

# EIKI

MULTIMEDIA PROJECTOR

## MODEL LC-HDT2000

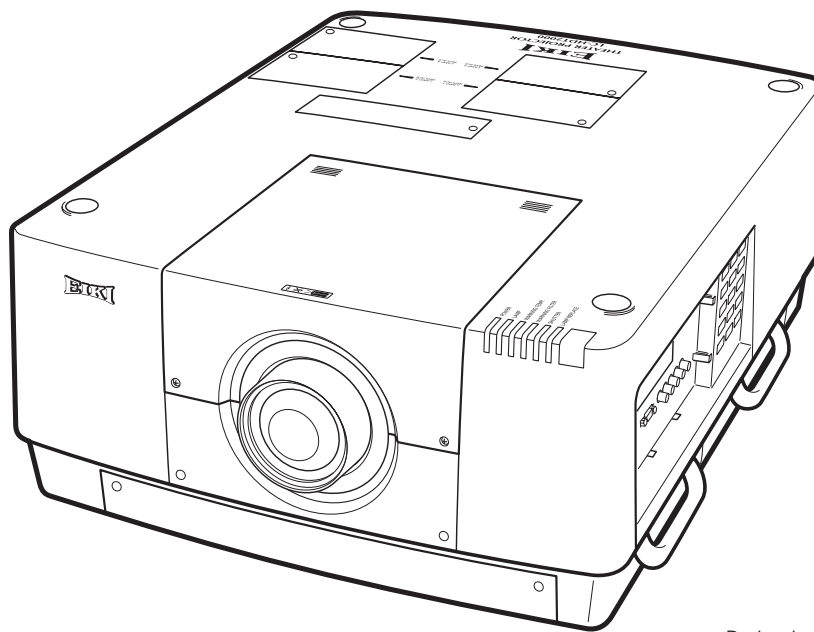

\* Projection lens not included.

## OWNER'S MANUAL

# Features and Design

This Multimedia Projector is designed with most advanced technology for portability, durability, and ease of use. This projector utilizes built-in multimedia features, a palette of 1.07 billion colors, and matrix liquid crystal display (LCD) technology.

## ◆ Functionally Rich

This projector has many useful functions such as lens shifting, ceiling and rear projection, perpendicular omnidirectional projection, variety of lens options, etc.

## ◆ Simple Computer System Setting

The projector has the Multi-scan system to conform to almost all computer output signals quickly (p.35). Supported resolution up to WUXGA.

## ◆ Security Function

The Security function helps you to ensure security of the projector. With the Key lock function, you can lock the operation on the side control or remote control (p.64). PIN code lock function prevents unauthorized use of the projector (pp.64–65).

## ◆ Power Management

The Power management function reduces power consumption and maintains lamp life (p.63).

## ◆ Picture-in-Picture

This projector is capable of projecting two images simultaneously by using either built-in picture-in-picture mode or picture-by-picture mode (pp.56-57).

## ◆ Multilanguage Menu Display

Operation menu is available in 12 languages; English, German, French, Italian, Spanish, Portuguese, Dutch, Swedish, Russian, Chinese, Korean, and Japanese (p.54).

## ◆ Hot-Swap Lamps

Hot-swap lamps enable you to replace the failed lamp with a new one without turning off the projector.

## ◆ Motor-driven Lens Shift

Projection lens can be moved up, down, right and left with the motor-driven lens shift function. This function makes it easy to provide projected image where you want. Zoom and focus can also be adjusted with a motor-driven operation. (p.28)

\*Zoom and focus functions may not operate depending on the optional lens.

## ◆ Shutter Function

The projector is equipped with the shutter that provides complete blackness for a while the projected image is not needed with keeping the projector on. The Shutter management function allows you to set the timer. It prevents leaving the projector on with the shutter closed for a long time. (p.66)

## ◆ Multi Versatile Platform

This projector applies various input/output terminals and 2 terminal slots for expansion to tune to diversity of signals from computers and video equipment (pp.19-21). For optional interface boards, contact sales dealer where you purchased the projector.

## ◆ Wired LAN Function

This projector is loaded with a wired LAN function to control and set-up the projector remotely via network. For details, refer to the owner's manual "Network Set-up and Operation".

## ◆ Active Maintenance Cleaner (AMC) unit

The built-in filter cleaning unit with a brush automatically removes large particles from the mesh filter, and the electrostatic honeycomb filter and electrostatic pleated filter capture medium and small particles. In addition, with the use of the smoke resistant filter (optional), you can filter out even oil smoke.

### ✓ Note:

- The On-Screen Menu and figures in this manual may differ slightly from the product.
- The contents of this manual are subject to change without notice.

# Table of Contents

<b>Features and Design</b> . . . . .	<b>2</b>	Computer Input Source Selection	34
<b>Table of Contents</b> . . . . .	<b>3</b>	Video Input Source Selection	35
<b>To The Owner</b> . . . . .	<b>4</b>	<b>Computer Input</b> . . . . .	<b>36</b>
<b>Safety Instructions</b> . . . . .	<b>5</b>	Computer System Selection	36
Air Circulation	6	Auto PC Adjustment	37
Installing the Projector in Proper Directions	7	Manual PC Adjustment	38
Moving the Projector	8	Image Selection	40
<b>Compliance</b> . . . . .	<b>9</b>	Image Adjustment	41
<b>Part Names and Functions</b> . . . . .	<b>10</b>	Screen Size Adjustment	44
Front	10	<b>Video Input</b> . . . . .	<b>47</b>
Back	10	Video System Selection	47
Bottom	10	Image Selection	48
Terminals and Connectors	11	Image Adjustment	49
Side Control and Indicators	12	Screen Size Adjustment	52
Side Control	12	<b>Settings</b> . . . . .	<b>54</b>
Indicators	13	Settings	54
LAMP 1/2/3/4 REPLACE indicators	13	<b>How To Overlap the Projection Images</b> <b>70</b>	
Remote Control	14	How to Overlap the Projection Images on a Screen	70
Remote Control Battery Installation	15	<b>Maintenance and Care</b> . . . . .	<b>72</b>
Remote Control Receivers and Operating Range	15	Maintaining the AMC unit	72
Wired Remote Control	15	Replacing the Filters	73
Remote Control Codes	16	Resetting the Filter Counter	74
<b>Installation</b> . . . . .	<b>17</b>	Lamp Management	75
Lens Installation	17	Lamp Replacement	76
Positioning Projector	17	Cleaning the Projection Lens	78
Picture Level and Pitch Adjustment	17	Cleaning the Projector Cabinet	78
Lens Shift Adjustment	18	Warning Indicators	79
Terminals of Projector	19	<b>Appendix</b> . . . . .	<b>80</b>
Connecting to Computer	20	Troubleshooting	80
Connecting to Video Equipment	21	Menu Tree	83
Attaching the Cable Tie	22	Indicators and Projector Condition	86
Connecting the AC Power Cord	23	Compatible Computer Specifications	89
<b>Basic Operation</b> . . . . .	<b>24</b>	Supported Signal Format for Optional Board	91
Turning On the Projector	24	Technical Specifications	92
Turning Off the Projector	25	Optional Parts	93
How to Operate the On-Screen Menu	26	PJ Link Notice	93
Main Menu	27	Configurations of Terminals	94
Operating with Projector Control	28	PIN Code Number Memo	95
Operating with Remote Control	29	Dimensions	96
Keystone Correction	32	List of Picture in Picture	97
<b>Input Selection</b> . . . . .	<b>33</b>	Serial Control Interface	98
Direct Operation	33		

## Trademarks

Each name of corporations or products in this book is either a registered trademark or a trademark of its respective corporation.





# To The Owner

Before installing and operating the projector, read this manual thoroughly.

The projector provides many convenient features and functions. Operating the projector properly enables you to manage those features and maintains it in good condition for many years to come.

Improper operation may result in not only shortening the product life, but also malfunctions, fire hazard, or other accidents.

If your projector seems to operate improperly, read this manual again, check operations and cable connections and try the solutions in the "Troubleshooting" section in the back of this manual. If the problem still persists, contact the dealer where you purchased the projector or the service center.

 <b>CAUTION</b> <b>RISK OF ELECTRIC SHOCK</b> <b>DO NOT OPEN</b> 
<b>CAUTION: TO REDUCE THE RISK OF ELECTRIC SHOCK, DO NOT REMOVE COVER (OR BACK). NO USER-SERVICEABLE PARTS INSIDE EXCEPT LAMP REPLACEMENT. REFER SERVICING TO QUALIFIED SERVICE PERSONNEL.</b>
 THIS SYMBOL INDICATES THAT DANGEROUS VOLTAGE CONSTITUTING A RISK OF ELECTRIC SHOCK IS PRESENT WITHIN THIS UNIT.
 THIS SYMBOL INDICATES THAT THERE ARE IMPORTANT OPERATING AND MAINTENANCE INSTRUCTIONS IN THE OWNER'S MANUAL WITH THIS UNIT.

## FOR EU USERS

The symbol mark and recycling systems described below apply to EU countries and do not apply to countries in other areas of the world.

Your product is designed and manufactured with high quality materials and components which can be recycled and/or reused.

The symbol mark means that electrical and electronic equipment, batteries and accumulators, at their end-of-life, should be disposed of separately from your household waste.

Note:

If a chemical symbol is printed beneath the symbol mark, this chemical symbol means that the battery or accumulator contains a heavy metal at a certain concentration. This will be indicated as follows: Hg: mercury, Cd: cadmium, Pb: lead.

In the European Union there are separate collection systems for used electrical and electronic equipment, batteries and accumulators.

Please, dispose of them correctly at your local community waste collection/recycling centre.

Please, help us to conserve the environment we live in!



## Safety Precaution

**WARNING: ●THIS APPARATUS MUST BE EARTHED.**

**●TO REDUCE THE RISK OF FIRE OR ELECTRIC SHOCK, DO NOT EXPOSE THIS APPLIANCE TO RAIN OR MOISTURE.**

- This projector produces intense light from the projection lens. Do not stare directly into the lens, otherwise eye damage could result. Be especially careful that children do not stare directly into the beam.
- Install the projector in a proper position. Otherwise it may result in a fire hazard.
- Allowing the proper amount of space on the top, sides, and rear of the projector cabinet is critical for proper air circulation and cooling of the unit. The diagrams shown here indicates the minimum space required. If the projector is to be built into a compartment or similarly enclosed, these minimum distances must be maintained.

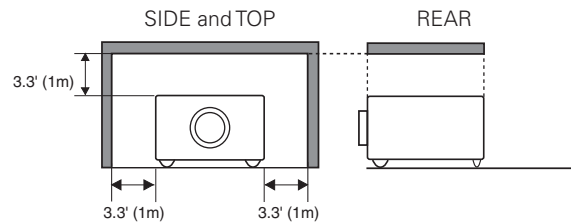

- Do not cover the ventilation slots on the projector. Heat build-up can reduce the service life of your projector, and can also be dangerous.
- If the projector is unused for an extended time, unplug the projector from the power outlet.
- Do not project the same image for a long time. It may be burned into the LCD panels.



## CAUTION ON HANGING FROM THE CEILING

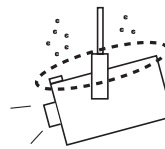

When hanging the projector from the ceiling, clean the air intake vent and top of the projector periodically with a vacuum cleaner. If you leave the projector unclean for a long time, the cooling fans can be clogged with dust, and it may cause a breakdown or a disaster.

**DO NOT SET THE PROJECTOR IN GREASY, WET, OR SMOKY CONDITIONS SUCH AS IN A KITCHEN TO PREVENT A BREAKDOWN OR A DISASTER. IF THE PROJECTOR COMES IN CONTACT WITH OIL OR CHEMICALS, IT MAY BECOME DETERIORATED.**

## CAUTION

Not for use in a computer room as defined in the Standard for the Protection of Electronic Computer/Data Processing Equipment, ANSI/NFPA 75.

**READ AND KEEP THIS OWNER'S MANUAL FOR LATER USE.**

# Safety Instructions

All the safety and operating instructions should be read before the product is operated.

Read all of the instructions given here and retain them for later use. Unplug this projector from AC power supply before cleaning. Do not use liquid or aerosol cleaners. Use a damp cloth for cleaning.

Follow all warnings and instructions marked on the projector.

For added protection to the projector during a lightning storm, or when it is left unattended and unused for long periods of time, unplug it from the wall outlet. This will prevent damage due to lightning and power line surges.

---

Do not expose this unit to rain or use near water... for example, in a wet basement, near a swimming pool, etc...

Do not use attachments not recommended by the manufacturer as they may cause hazards.

Do not place this projector on an unstable cart, stand, or table. The projector may fall, causing serious injury to a child or adult, and serious damage to the projector. Use only with a cart or stand recommended by the manufacturer, or sold with the projector. Wall or shelf mounting should follow the manufacturer's instructions, and should use a mounting kit approved by the manufacturers.

An appliance and cart combination should be moved with care. Quick stops, excessive force, and uneven surfaces may cause the appliance and cart combination to overturn.



---

Slots and openings in the back and bottom of the cabinet are provided for ventilation, to ensure reliable operation of the equipment and to protect it from overheating.

The openings should never be covered with cloth or other materials, and the bottom opening should not be blocked by placing the projector on a bed, sofa, rug, or other similar surface. This projector should never be placed near or over a radiator or heat register.

This projector should not be placed in a built-in installation such as a book case unless proper ventilation is provided.

Never push objects of any kind into this projector through cabinet slots as they may touch dangerous voltage points or short out parts that could result in a fire or electric shock. Never spill liquid of any kind on the projector.

Do not install the projector near the ventilation duct of air-conditioning equipment.

This projector should be operated only from the type of power source indicated on the marking label. If you are not sure of the type of power supplied, consult your authorized dealer or local power company.

Do not overload wall outlets and extension cords as this can result in fire or electric shock. Do not allow anything to rest on the power cord. Do not locate this projector where the cord may be damaged by persons walking on it.

Do not attempt to service this projector yourself as opening or removing covers may expose you to dangerous voltage or other hazards. Refer all servicing to qualified service personnel.

Unplug this projector from wall outlet and refer servicing to qualified service personnel under the following conditions:

- a. When the power cord or plug is damaged or frayed.
- b. If liquid has been spilled into the projector.
- c. If the projector has been exposed to rain or water.
- d. If the projector does not operate normally by following the operating instructions. Adjust only those controls that are covered by the operating instructions as improper adjustment of other controls may result in damage and will often require extensive work by a qualified technician to restore the projector to normal operation.
- e. If the projector has been dropped or the cabinet has been damaged.
- f. When the projector exhibits a distinct change in performance-this indicates a need for service.

When replacement parts are required, be sure the service technician has used replacement parts specified by the manufacturer that have the same characteristics as the original part. Unauthorized substitutions may result in fire, electric shock, or injury to persons.

Upon completion of any service or repairs to this projector, ask the service technician to perform routine safety checks to determine that the projector is in safe operating condition.

---

## NOTE FOR CUSTOMERS IN THE US

LAMP(S) INSIDE THIS PRODUCT CONTAIN MERCURY AND MUST BE RECYCLED OR DISPOSED OF ACCORDING TO LOCAL, STATE OR FEDERAL LAWS.

# Safety Instructions

## Air Circulation

Openings in the cabinet are provided for ventilation. To ensure reliable operation of the product and to protect it from overheating, these openings must not be blocked or covered.

### CAUTION

Hot air is exhausted from the exhaust vents. When using or installing the projector, the following precautions should be taken.

- Do not put any flammable object or spray can near the projector, hot air is exhausted from the air vents.
- Keep the exhaust vents at least 3' (1 m) away from any objects.
- Do not touch peripheral parts of the exhaust vents, especially screws and metallic parts. These areas will become hot while the projector is being used.
- Do not put anything on the cabinet. Objects put on the cabinet will not only get damaged but also may cause fire hazard by heat.
- Do not cover vents with papers or other materials.
- Make sure that there are no objects under the projector. An object under the projector may prevent the projector from taking cooling air through bottom vent.
- When detaching the adjustable feet, always keep at least 50 mm between the bottom of the projector and installation surface.

Cooling fans are provided to cool down the projector. The fans' running speed is changed according to the temperature inside the projector.

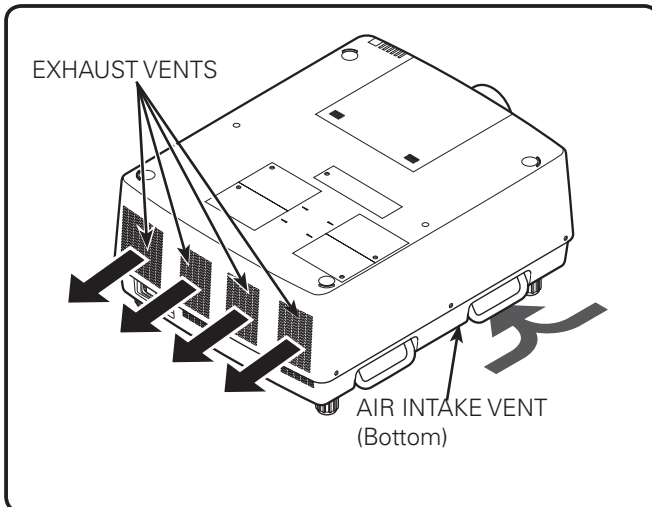

## IMPORTANT!

### Filter Maintenance!!

The projector uses a lamp which generates significant heat. The cooling fans and air vents are provided to dissipate the heat by drawing air into the housing and the filter is located in the intake vent to prevent dust from getting inside of the projector.

In order to care for the projector appropriately, regular cleaning is required. Remove any dirt or dust that has accumulated on the projector.

If the projector reaches a time set in the timer setting, the icon as shown in Fig. 1 appears on the screen and WARNING FILTER indicator lights up (see below), indicating that cleaning or replacing the filter is necessary.

If the projector detects that the filter is clogged, the icon as shown in Fig. 2 appears on the screen and WARNING FILTER indicator lights up (see below). Stop using the projector immediately and replace the electrostatic honeycomb filter and the electrostatic pleated filter.

Blocking the air vents and leaving the projector uncleaned for a long time may not only damage the projector and may require costly repairs but may also cause accidents or fire.

For maintenance of the filter, refer to "Filter counter" on page 68 and "Maintenance and Care" on pages 72-74.

**Damages to the projector caused by using an uncleaned filter or improper maintenance will void the warranty on the projector.**

### Top Panel







-  POWER
-  LAMP
-  WARNING TEMP.
-  WARNING FILTER
-  SHUTTER
-  LAMP REPLACE



Fig.1



Fig.2

**WARNING FILTER indicator**

## Installing the Projector in Proper Directions

Use the projector properly in specified positions. Improper positioning may reduce the lamp life and result in severe accident or fire hazard.

This projector can project the picture in upward, downward, or inclined position in perpendicular direction to the plane.

**✓ Note:**

- To inverse or reverse the image, set the ceiling function to "On." (pp. 46, 53)
- The projector can not be operated at an altitude above 3,000 meters.

## Positioning Precautions

Avoid positioning the projector as described below when installing.

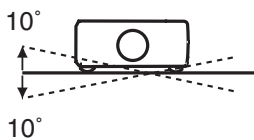

Do not roll the projector more than 10 degrees from side to side.

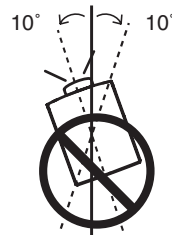

In upward projection, do not tilt the projector over 10 degrees right and left.



Do not put the projector on either side to project an image.

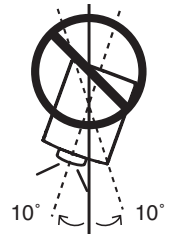

In downward projection, do not tilt the projector over 10 degrees right and left.



### CAUTION ON CEILING MOUNTING

For ceiling mounting, you need the ceiling mount kit designed for this projector. When not mounted properly, the projector may fall, causing hazards or injury. For details, consult your dealer. The warranty on this projector does not cover any damage caused by use of any non-recommended ceiling mount kit or installation of the ceiling mount kit in an improper location.



### Cautious use of equipment with laser technology

Do not radiate strong light such as laser light on the projection lens directly, as this may degrade the functionality of the projector. Failure to do so will void any applicable warranties.



## Moving the Projector



Retract the adjustable feet to prevent damage to lens and cabinet. For safety, holding the carrying handles on both sides by 2 or more people is recommended to move the projector because the projector is heavy. Moving it improperly may result in damage of cabinet or person's injury.

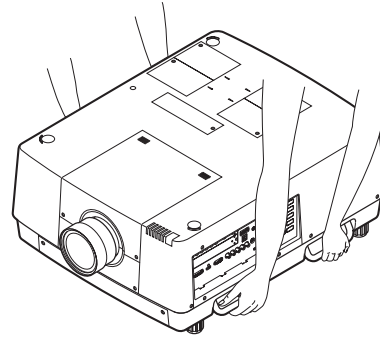

### CAUTION IN CARRYING OR TRANSPORTING THE PROJECTOR

- Do not drop or bump the projector, otherwise damages or malfunctions may result.
- When carrying the projector, use a suitable carrying case.
- Do not transport the projector by courier or any other transport service in an unsuitable transport case. This may cause damage to the projector. For information about transporting the projector by courier or any other transport service, consult your dealer.
- Do not put the projector in a case before it is cooled enough.
- Do not transport the projector with a replacement lens installed.

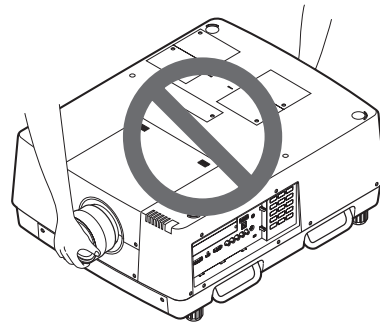
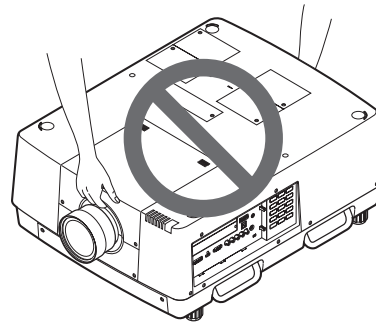



# Compliance

## Federal Communications Commission Notice

This equipment has been tested and found to comply with the limits for a Class A digital device, pursuant to Part 15 of FCC Rules. These limits are designed to provide reasonable protection against harmful interference when the equipment is operated in a commercial environment. This equipment generates, uses, and can radiate radio frequency energy and, if not installed and used in accordance with the instruction manual, may cause harmful interference to radio communications. Operation of this equipment in a residential area is likely to cause harmful interference in which case the user will be required to correct the interference at his own expense.

Do not make any changes or modifications to the equipment unless otherwise specified in the instructions. If such changes or modifications should be made, you could be required to stop operation of the equipment.

## Canadian Radio Interference Regulations

This Class A digital apparatus meets all requirements of the Canadian ICES-003.

## WARNING

This is a Class A product. In a domestic environment this product may cause radio interference in which case the user may be required to take adequate measures.

## AC Power Cord Requirement

The AC Power Cord supplied with this projector meets the requirement for use in the country you purchased it.

### AC Power Cord for the United States and Canada:

AC Power Cord used in the United States and Canada is listed by the Underwriters Laboratories (UL) and certified by the Canadian Standard Association (CSA).

AC Power Cord has a grounding-type AC line plug. This is a safety feature to be sure that the plug will fit into the power outlet. Do not try to defeat this safety feature. Should you be unable to insert the plug into the outlet, contact your electrician.



### AC Power Cord for the United Kingdom:

This cord is already fitted with a moulded plug incorporating a fuse, the value of which is indicated on the pin face of the plug. Should the fuse need to be replaced, an ASTA approved BS 1362 fuse must be used of the same rating, marked thus  $\diamond$ . If the fuse cover is detachable, never use the plug with the cover omitted. If a replacement fuse cover is required, ensure it is of the same colour as that visible on the pin face of the plug (i.e. red or orange). Fuse covers are available from the Parts Department indicated in your User Instructions.

If the plug supplied is not suitable for your socket outlet, it should be cut off and destroyed.

The end of the flexible cord should be suitably prepared and the correct plug fitted.

**WARNING: A PLUG WITH BARED FLEXIBLE CORD IS HAZARDOUS IF ENGAGED IN A LIVE SOCKET OUTLET.**

The Wires in this mains lead are coloured in accordance with the following code:

Green-and-yellow ..... Earth  
Blue ..... Neutral  
Brown ..... Live

As the colours of the wires in the mains lead of this apparatus may not correspond with the coloured markings identifying the terminals in your plug proceed as follows:

The wire which is coloured green-and-yellow must be connected to the terminal in the plug which is marked by the letter E or by the safety earth symbol  $\perp$  or coloured green or green-and-yellow.

The wire which is coloured blue must be connected to the terminal which is marked with the letter N or coloured black.

The wire which is coloured brown must be connected to the terminal which is marked with the letter L or coloured red.

**WARNING: THIS APPARATUS MUST BE EARTHED.**

**THE SOCKET-OUTLET SHOULD BE INSTALLED NEAR THE EQUIPMENT AND EASILY ACCESSIBLE.**

# Part Names and Functions

## Front

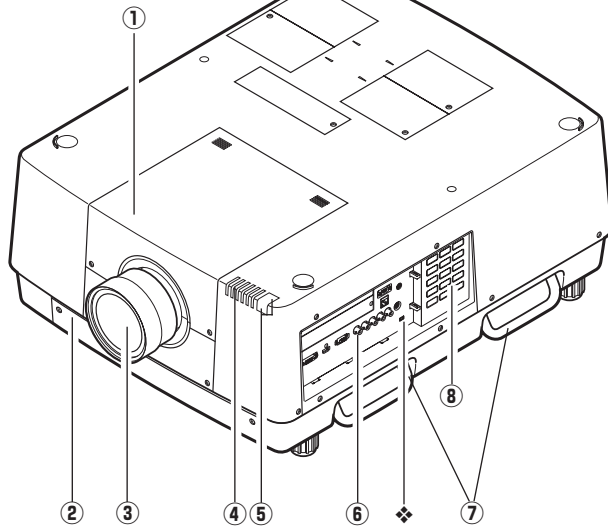

- ① Lens Mount Cover
- ② AMC (Active Maintenance Cleaner) Unit
- ③ Projection Lens (Optional)
- ④ Indicators
- ⑤ Infrared Remote Receivers (Front&Top)
- ⑥ Terminals and Connectors
- ⑦ Carrying Handles
- ⑧ Side Control

### ❖ Kensington\* Security Slot

This slot is for a Kensington lock used to deter theft of the projector.

\*Kensington is a registered trademark of ACCO Brands Corporation.

## Back

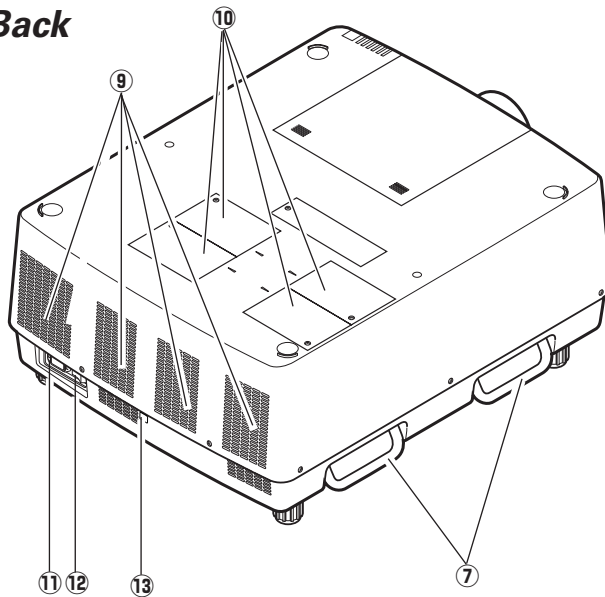

- ⑨ Exhaust Vents
- ⑩ Lamp Covers
- ⑪ Power Cord Connector
- ⑫ Main On/Off Switch
- ⑬ Infrared Remote Receiver (Rear)

### ⚠ CAUTION

Hot air is exhausted from the exhaust vents. Do not put heat-sensitive objects near this side.

## Bottom

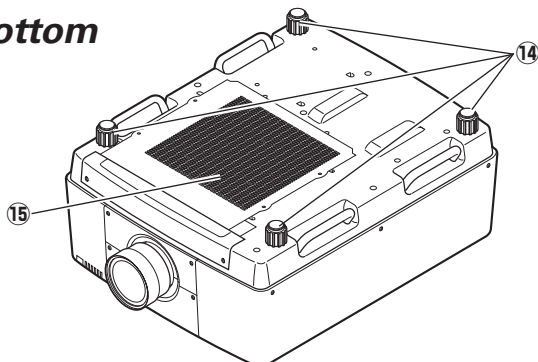

- ⑭ Adjustable Feet
- ⑮ Air Intake Vent

Terminals and Connectors

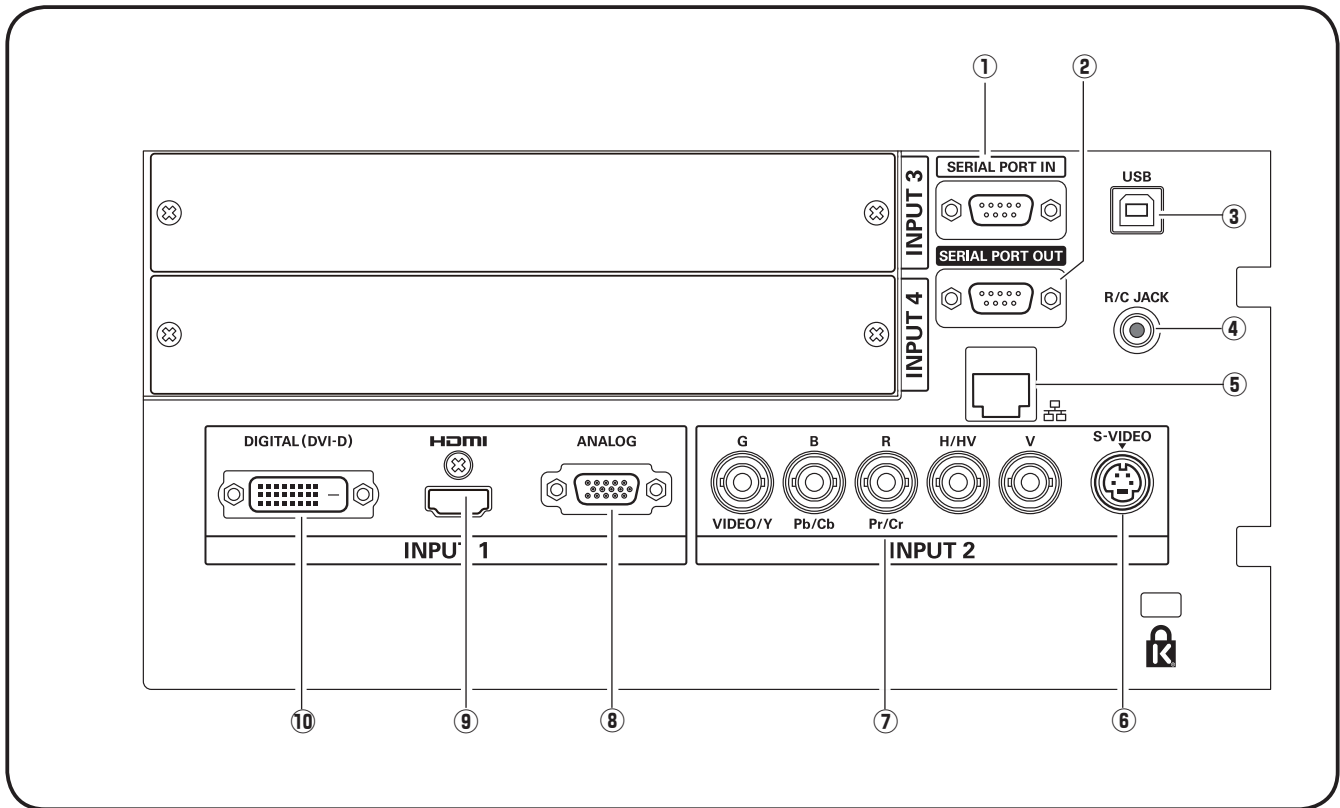

① SERIAL PORT IN TERMINAL

If you control the projector from a computer, you must connect a cable (not supplied) from your computer to this RS-232C terminal.

② SERIAL PORT OUT TERMINAL

This terminal outputs signal from SERIAL PORT IN. More than two projectors can be controlled with one computer by connecting SERIAL PORT IN of another projector to this RS-232C terminal.

③ USB CONNECTOR (series B)

USB connector is to used to service the projector.

④ R/C JACK

When using the wired remote control, connect the wired remote control to this jack with a remote control cable (supplied).

⑤ LAN PORT

Connecting the Ethernet cable See the owner's manual of "Network Set-up and Operation" for details.

⑥ S-VIDEO JACK

Connects the S-VIDEO output signal from video equipment to this jack (p.21).

⑦ 5 BNC JACK

Connects the component or composite video output signal from video equipment to VIDEO/Y, Pb/Cb, and Pr/Cr jacks or connect the computer output signal (5 BNC Type [Green, Blue, Red, Horiz. Sync, and Vert. Sync.]) to G, B, R, H/HV, and V jacks (pp.20-21).

⑧ ANALOG TERMINAL

Connects the computer (or RGB scart) output signal to this terminal (pp.20-21).

⑨ HDMI TERMINAL

Connects the HDMI output signal from video equipment to this terminal. (pp.20-21)

⑩ DIGITAL (DVI-D) TERMINAL

Connects computer output (Digital/DVI-D type) to this terminal (p.20). HD (HDCP Compatible) signal can be also connected (p.21).

## Side Control and Indicators

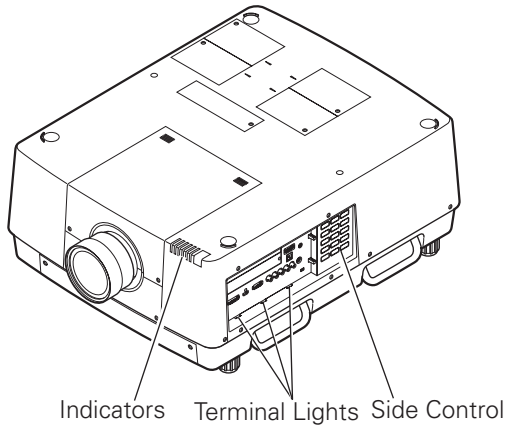

## Side Control

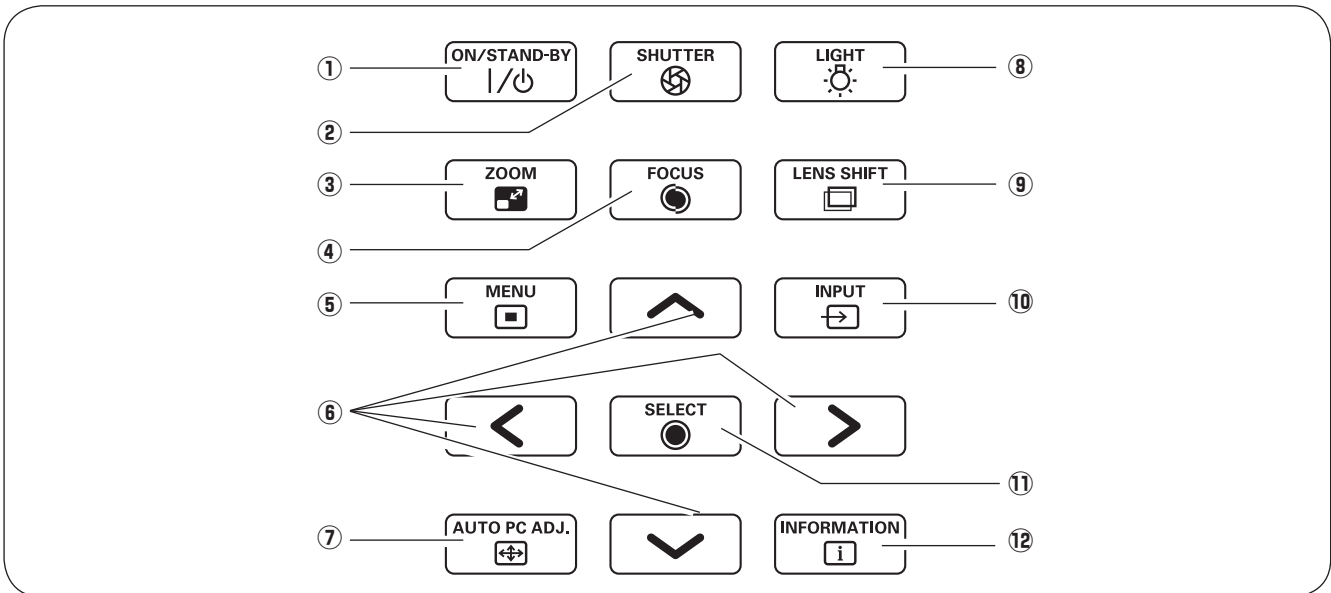

- ① **ON/STAND-BY button**  
Turns the projector on or off. (pp.24,25)
- ② **SHUTTER button**  
Closes and opens up the built-in shutter. (p.28)
- ③ **ZOOM button**  
Zooms in and out the images. (p.28)
- ④ **FOCUS button**  
Adjusts the focus. (p.28)
- ⑤ **MENU button**  
Opens or closes the On-Screen MENU. (pp.26, 27)
- ⑥ **POINT buttons**
  - Select an item or adjust the value in the On-Screen MENU. (p.26)
  - Pan the image in DIGITAL ZOOM + mode. (p.45)
- ⑦ **AUTO PC ADJ. button**  
Automatically adjusts the computer image to its optimum setting. (pp.28, 37)
- ⑧ **LIGHT button**  
Lights the side control and terminals. (p.28)
- ⑨ **LENS SHIFT button**  
Selects the LENS SHIFT function. (p.28)
- ⑩ **INPUT button**  
Selects an input source Input 1, Input 2, Input 3 or Input 4. (pp.33-35)
- ⑪ **SELECT button**  
Used to execute the selected item. (p.26) It is also used to make the image larger in DIGITAL ZOOM + mode and smaller in DIGITAL ZOOM - mode. (p.45)
- ⑫ **INFORMATION button**  
Displays the input source information (p.28).

## Indicators

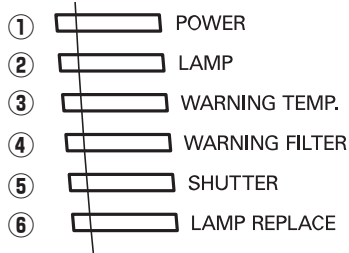

① **POWER indicator**

This indicator lights green when the projector is ready to be turned on in standby mode. And it flashes green in Power Management mode. (pp.63, 86-88)

② **LAMP Indicator**

This indicator is dim when the projector is turned on. And bright when the projector is in stand-by mode. (pp.86-88)

③ **WARNING TEMP. indicator**

This indicator flashes red when internal projector temperature is too high. (pp.79, 86-88)

④ **WARNING FILTER indicator**

– Lights orange when the clogging of the filter is detected or the filter counter reaches a time set in the timer setting, urging immediate filter replacement. (pp.68, 73, 88)  
 – Blinks orange during a filter cleaning process.

⑤ **SHUTTER indicator**

Lights blue when the shutter is closed. (p. 86)

⑥ **LAMP REPLACE indicator**

Lights orange when any of the projection lamps reaches its end of life. (pp.76, 87)

## LAMP 1/2/3/4 REPLACE indicators

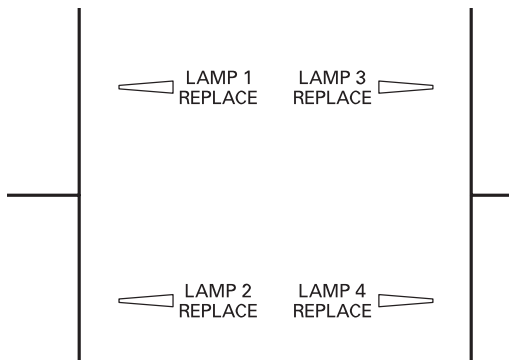

-When any of the LAMP 1/2/3/4 REPLACE indicators lights:  
 The corresponding lamp is approaching its end.

-When any of the LAMP 1/2/3/4 REPLACE indicators flashes:  
 The corresponding lamp needs to be replaced.

## Remote Control

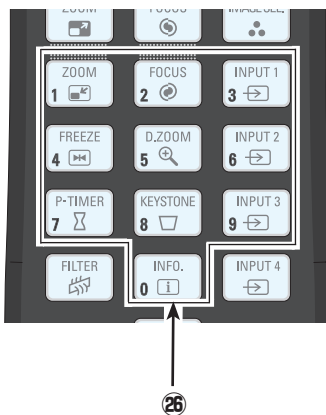
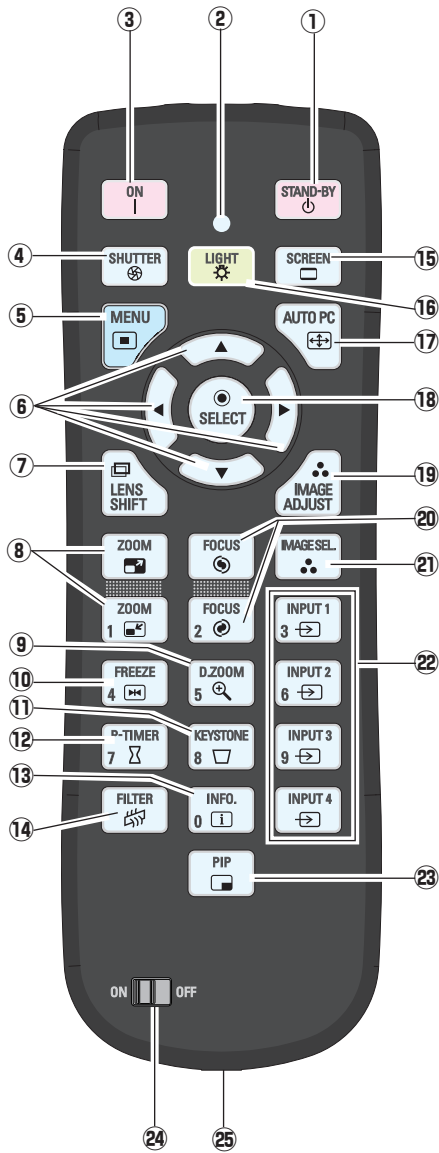

- ① **STAND-BY button**  
Turns the projector off. (p.25)
- ② **SIGNAL EMISSION indicator**  
Lights red while a signal is being sent from the remote control unit to the projector.
- ③ **ON button**  
Turns the projector on. (p.24)
- ④ **SHUTTER button**  
Closes the built-in shutter for light blocking. (pp.28, 29)
- ⑤ **MENU button**  
Opens or closes the On-Screen MENU. (pp.26, 27)
- ⑥ **POINT ▲▼◀▶ buttons**  
–Select an item or adjust the value in the ON-SCREEN MENU. (p.26)  
–Pan the image in DIGITAL ZOOM +/- mode. (p.45)
- ⑦ **LENS SHIFT button**  
Selects the LENS SHIFT function. (p.29)
- ⑧ **ZOOM buttons**  
Zoom in and out the images. (p.29)
- ⑨ **D.ZOOM button**  
Selects the Digital zoom +/- mode and resize the image. (pp.29, 45)
- ⑩ **FREEZE button**  
Freezes the picture on the screen. (p.31)
- ⑪ **KEYSTONE button**  
Corrects keystone distortion. (pp.32, 46, 53)
- ⑫ **P-TIMER button**  
Operates the P-TIMER function. (pp.31, 69)
- ⑬ **INFO. button**  
Displays the input source information. (p.29)
- ⑭ **FILTER button**  
To schedule a filter cleaning task. (p.31)
- ⑮ **SCREEN button**  
Selects the screen size. (pp.44-46, 52-53)
- ⑯ **LIGHT button**  
Lights the buttons on the remote control for about 10 seconds.
- ⑰ **AUTO PC button**  
Automatically adjusts the computer image to its optimum setting. (pp.29, 37)
- ⑱ **SELECT button**  
–Executes the selected item. (p.26)  
–Expands or compress the image in the DIGITAL ZOOM +/--mode. (p.45)
- ⑲ **IMAGE ADJUST button**  
Enters the image level adjustment mode. (pp.29, 41-43, 49-51)
- ⑳ **FOCUS buttons**  
Adjusts the focus. (p.29)
- ㉑ **IMAGE SEL. button**  
Selects the image level. (pp.31, 40, 48)
- ㉒ **INPUT 1, 2, 3, and 4 buttons**  
Select an input source. (pp.33-35)
- ㉓ **PIP button**  
Operates the Picture In Picture function. (p.31)
- ㉔ **ON/OFF switch**  
When using the remote control, set this switch to “ON”
- ㉕ **Wired Remote Jack**  
Connects the remote control cable (supplied) to this jack when using as a wired remote control.
- ㉖ **Number buttons**  
Use these buttons when setting the remote control codes (p.16) or when entering the PIN code numbers (pp. 24, 61, 65).

## Remote Control Battery Installation

- 1** Open the battery compartment lid.

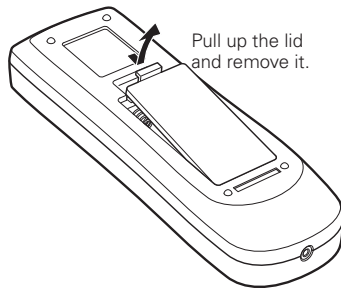

- 2** Install new batteries into the compartment.

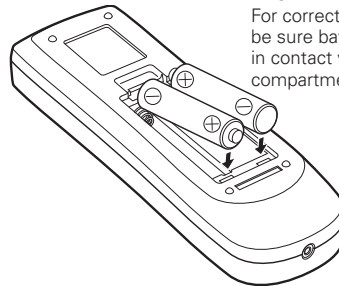

- 3** Replace the compartment lid.

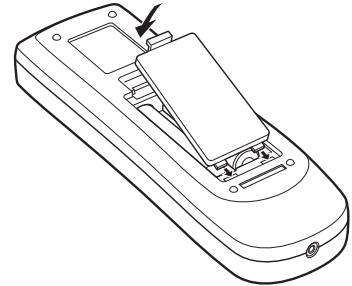

To ensure safe operation, please observe the following precautions :

- Use two (2) AAA or LR03 type alkaline batteries.
- Always replace batteries in sets.
- Do not use a new battery with a used battery.
- Avoid contact with water or liquid.
- Do not expose the remote control to moisture or heat.
- Do not drop the remote control.
- If the battery has leaked on the remote control, carefully wipe the case clean and install new batteries.
- Risk of an explosion if battery is replaced by an incorrect type.
- Dispose of used batteries according to the instructions or your local disposal rule or guidelines.

## Remote Control Receivers and Operating Range

Point the remote control toward the projector (to Infrared Remote Receivers). The operating distance and angle between the receivers and the remote control must be shorter than 16.4' (5 m) and less than 60 degrees.

Infrared Remote Receivers are located on the front, rear, and top panels. You can activate only necessary receivers. (pp. 10, 63).

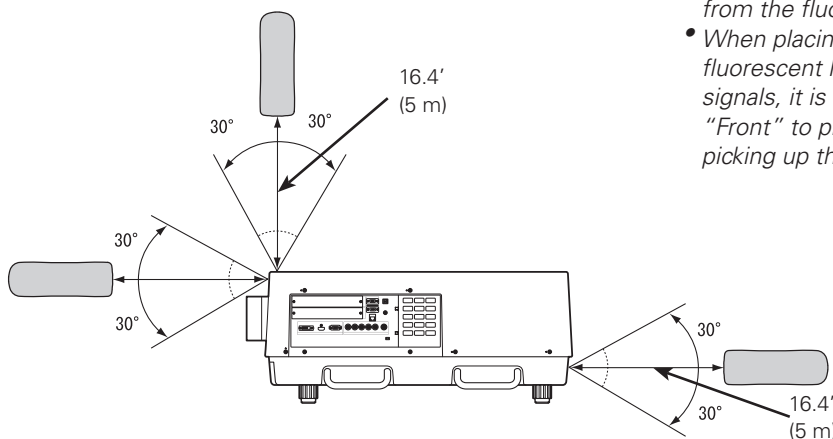

**✓Note:**

- When hanging the projector from the ceiling, select the Infrared Remote Receiver which is located farther away from the fluorescent light (p.63).
- When placing the projector in the horizontal position, as fluorescent light may negatively affect the remote control signals, it is recommended to select either "Back" or "Front" to prevent the receiver on top of the projector from picking up the signals from the remote control. (p.63)

## Wired Remote Control

The remote control can be used as a wired remote control. Wired remote control helps you use the remote control outside of the operating range (16.4'/ 5 m). Connect the remote control and the projector with the remote control cable (supplied). Connected with the remote control cable, the remote control does not emit wireless signal.



## Remote Control Codes

When controlling several projectors from each remote control at the same time, you can assign a remote control code (Code 1 - Code 8) to individual projectors and remote controls to prevent remote control interference. Assign the same code the you specified for the projector to the remote control. See "Remote Control" on page 62 for assigning a remote control code to the projector. Follow the procedures below to select the assigned code.

Press and hold the MENU and a number button (1–8) for more than five seconds to switch between the codes. To reset it to the default code number (Code 1), use the button combination of the MENU button and the 0 number button (press for 5 seconds).

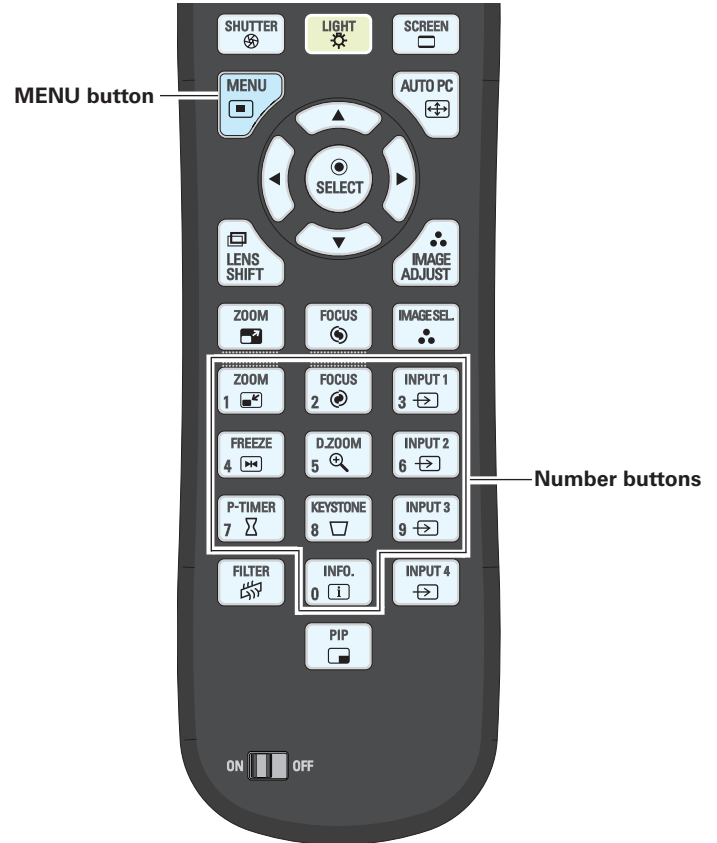

**✓ Note:**

To ensure safe operation, observe the following precautions:

- Do not bend, drop, or expose the remote control to moisture or heat.
- For cleaning, use a soft dry cloth. Do not apply benzene, thinner, spray, or any other chemical materials.

# Installation

## Lens Installation

Before setting up the projector, install Projection Lens on the projector.

Before installation, check where the projector is used and prepare a suitable lens. For the specifications of Projection Lens, contact sales dealer where you purchased the projector.



- **Lens installation and replacement should be performed by the qualified service personnel.**
- When setting the projector after lens installation, be sure to replace a Lens Cap to protect a surface.
- When carrying or holding up the projector, be careful not to put your hands on lens part. It may damage lens, cabinet, or mechanical parts.

## Positioning Projector

This projector is designed to project on a flat projection surface.

### ✓Note:

- *Brightness in room has a great influence on picture quality. It is recommended to limit ambient lighting in order to provide the best image.*

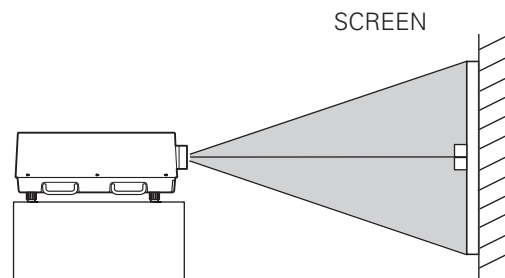

## Picture Level and Pitch Adjustment

The projection angle is adjustable up to 3 degrees upward and downward respectively by rotating front and back feet.

To raise the projector, rotate the feet clockwise.

To lower the projector or to retract the adjustable feet, rotate the feet counterclockwise.

To correct keystone distortion, press the KEYSTONE button on the remote control or select Keystone from the menu (see pages 32, 46, 53).

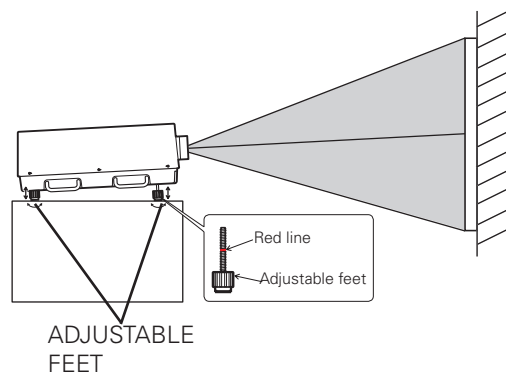

Do not rotate the adjustable feet when you see the red line on the adjustable feet. The adjustable feet may fall off.

## Lens Shift Adjustment

Projection lens can be moved from side to side and up and down with the motor-driven lens shift function. This function makes the positioning of images easy on the screen. The amount of lens shift range varies depending on the lens. The shift ranges shown below apply to the AH-22051 lens. (See page 28)

### When the lens is shifted to top

The display position can be shifted upward up to 50% elevation of the display.

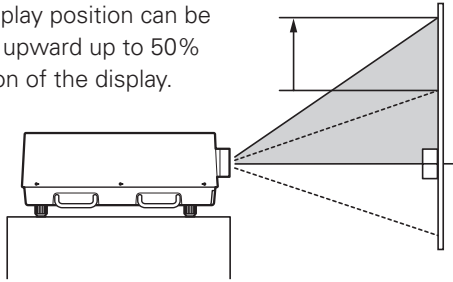

### When the lens is shifted to bottom

The display position can be shifted downward up to 50% low level of the display.

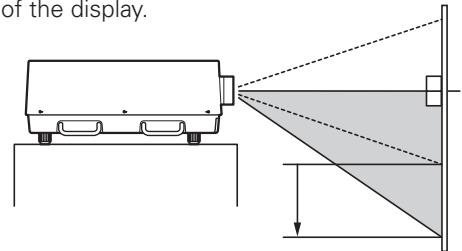

### When the lens is shifted to leftmost

The display position can be shifted to the left in up to 10% width of the display.

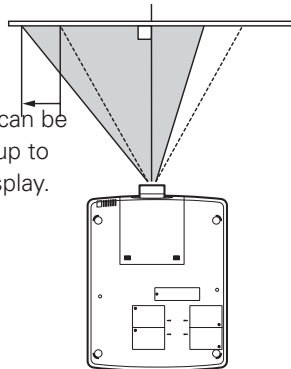

### When the lens is shifted to rightmost

The display position can be shifted to the right in up to 10% width of the display.

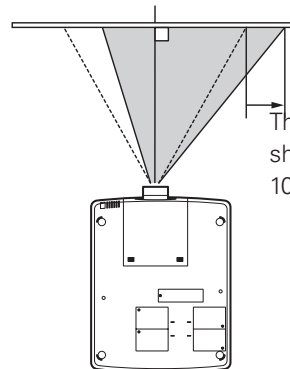

## Terminals of Projector

The projector has two replaceable Interface board slots. The projector's functions can be extended by installing the optional interface boards into the terminal slots. 2 vacant slots (Input 3 and 4) are provided in your purchasing the projector. For the Optional Interface Boards, contact sales dealer where you purchased the projector.

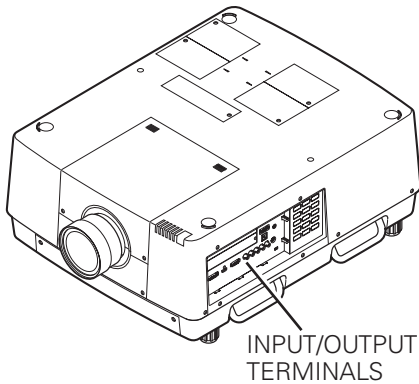

2 TERMINAL SLOTS (Factory set)

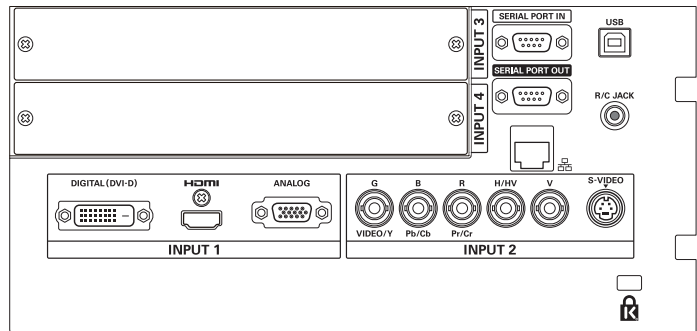

## Replacement of Terminal

**✓Note:**

- In the replacement of interface board, turn off the projector, press the Main On/Off Switch to Off and unplug the AC power cord from the AC outlet.

- 1 Remove 2 screws from an interface board.
- 2 Pull out the interface board.
- 3 Replace the interface board. Insert a new interface board along Guide to fit Socket to inside Plug.
- 4 Tighten screws to secure the interface board.

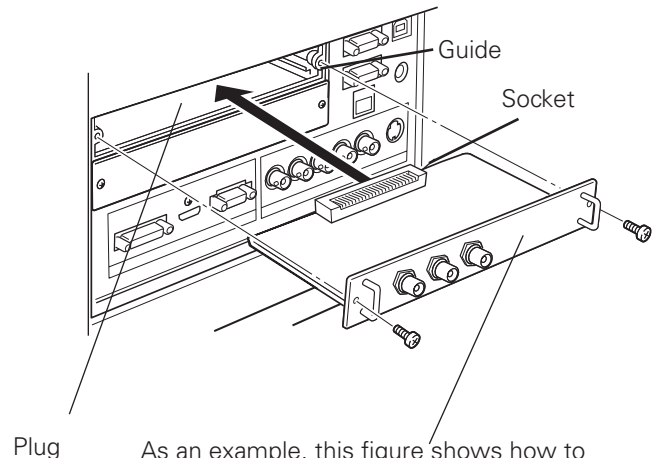
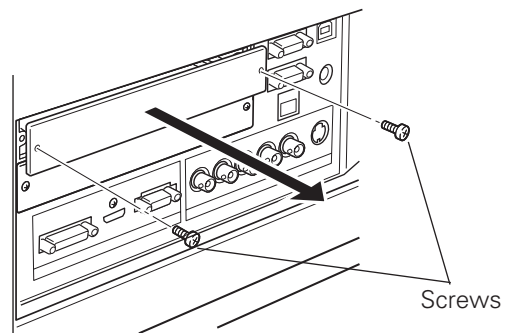

## NOTES ON ORDERING OR USING OPTIONAL INTERFACE BOARD

When ordering or using Optional Interface Board, contact your sales dealer. When contacting the sales dealer, tell the Option Control Number (Op.cont.No.) in the menu that is located on the bottom of the information menu. (See page 29)

## Connecting to Computer

### Cables used for connection

- DVI-D cable
- DVI/HDMI cable
- VGA Cable (D-sub 15 pin) \*
- ( \*One cable is supplied; Other cables are not supplied with this projector.)
- BNC Cable (BNC x 5)
- Serial cross cable
- USB cable

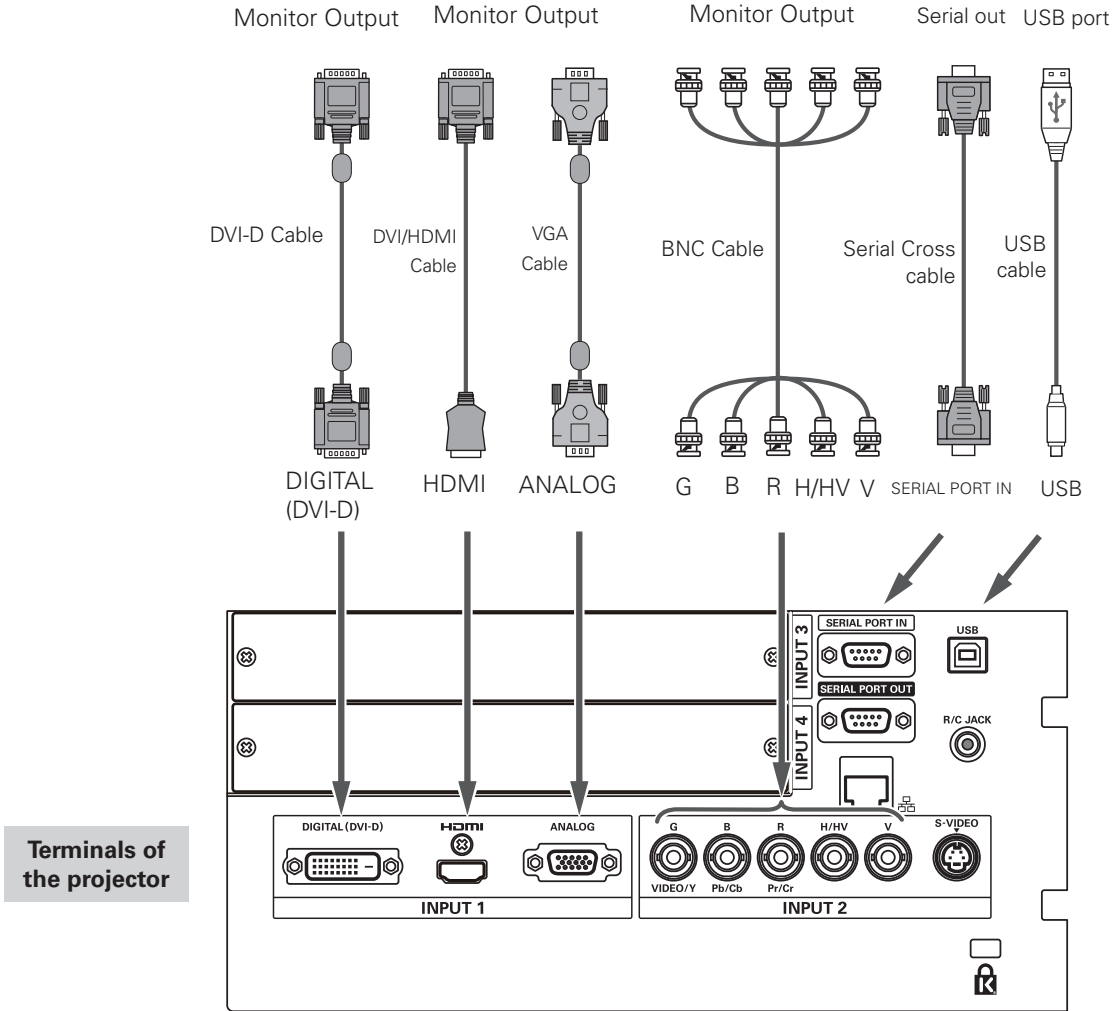
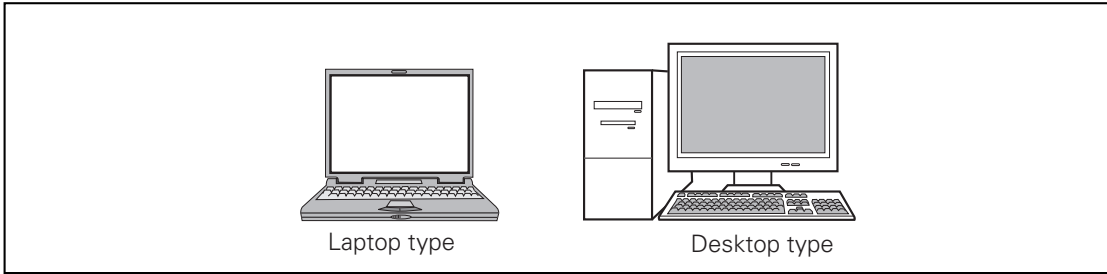

*Unplug the power cords of both the projector and external equipment from the AC outlet before connecting cables.*

## Connecting to Video Equipment

### Cables used for connection

- Video Cable (BNC x 3, BNC x 1)
- SCART-VGA Cable
- DVI-D Cable
- S-Video Cable

(Cables are not supplied with the projector.)

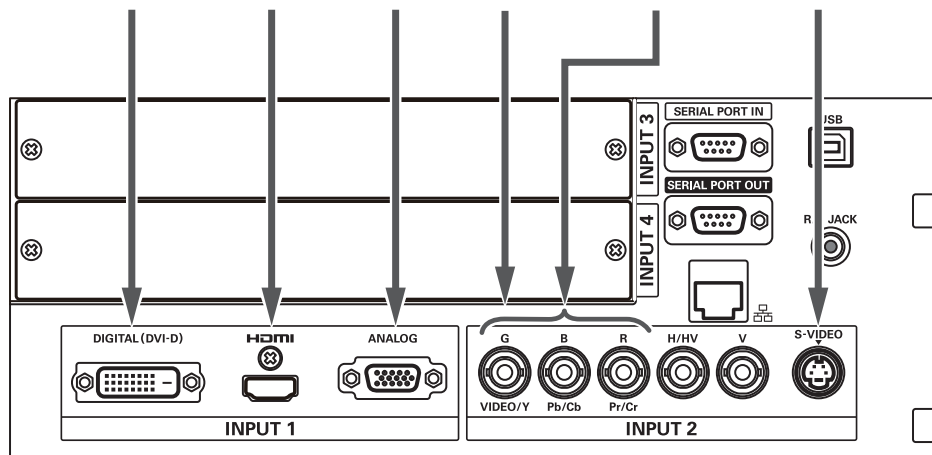
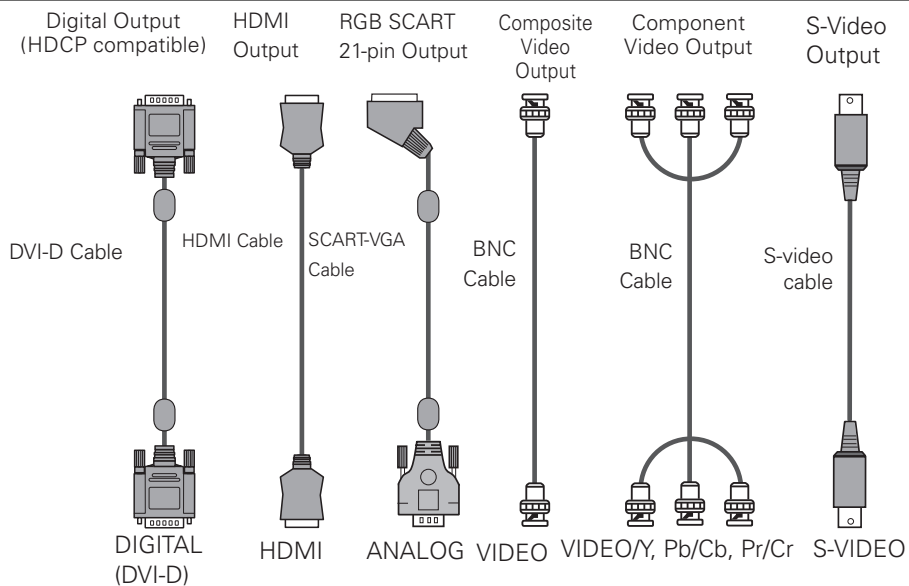
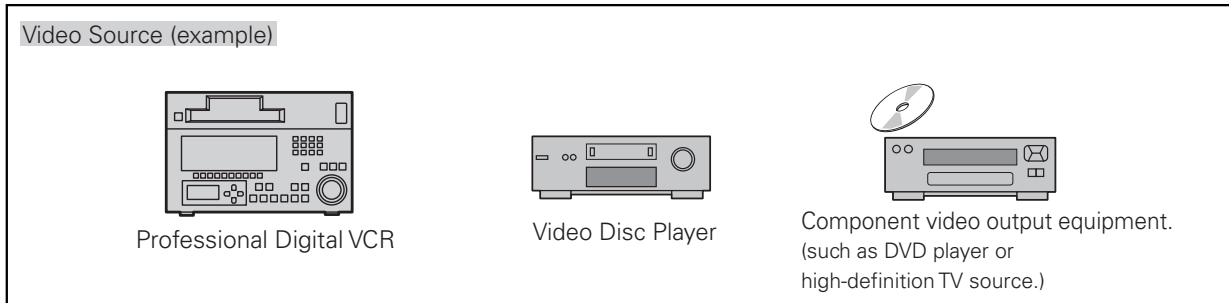

Unplug the power cords of both the projector and external equipment from the AC outlet before connecting cables.

## Attaching the Cable Tie

You can dress and secure all cables to a cable tie (supplied).

The cable tie is reusable and can be loosened and tightened as many times as needed.

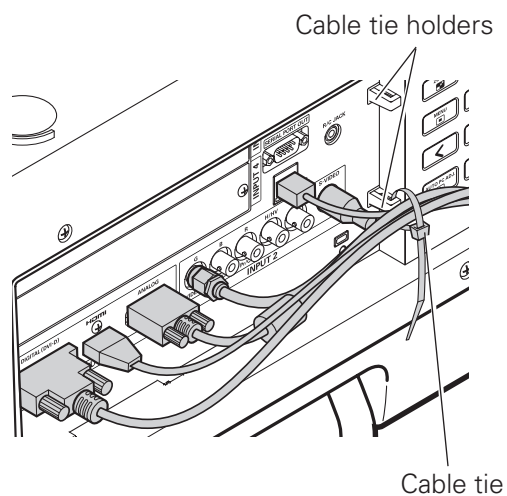

### To loosen the cable tie

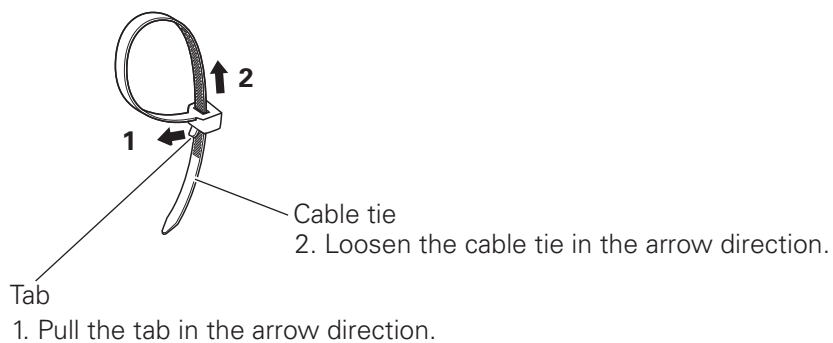



## Connecting the AC Power Cord

This projector uses nominal input voltages of 200-240 V AC. It is designed to work with single-phase power systems having a grounded neutral conductor. To reduce the risk of electrical shock, do not plug into any other type of power system. If you are not sure of the type of power being supplied, consult your authorized dealer or service center. Connect the projector with all peripheral equipment before turning on the projector.

A power cord clamp is designed to prevent the AC power cord from coming loose. Attach the power cord clamp and AC power cord to the projector by following these steps.

- 1 Insert the both ends of the power cord clamp into the holes and tilt the clamp.
- 2 Connect the AC power cord to the projector.
- 3 Secure the power cord connector with the clamp.

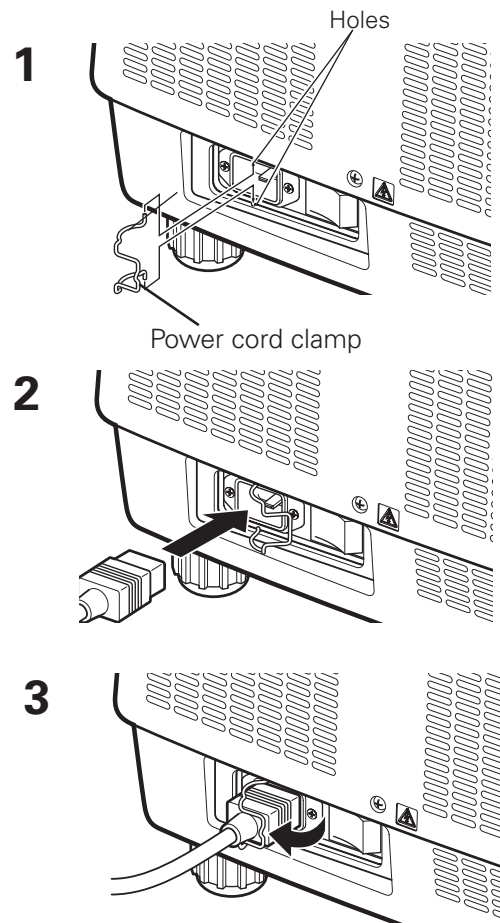

### CAUTION

The AC outlet must be near this equipment and must be easily accessible.

**✓ Note:**

- Unplug the AC power cord or turn off the MAIN ON/OFF Switch when the projector is not in use. When the projector is in stand-by mode, it consumes a little electric power.

### NOTE ON THE POWER CORD

AC power cord must meet the requirements of the country where you use the projector. Confirm the AC plug type with the chart below and proper AC power cord must be used. If the supplied AC power cord does not match your AC outlet, contact your sales dealer.

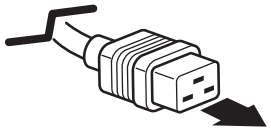
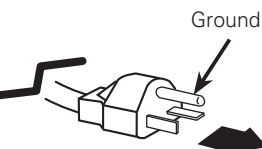
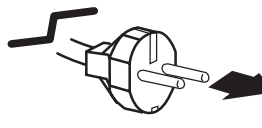
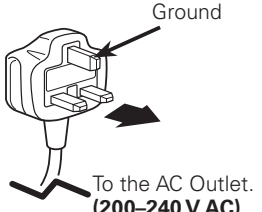
Projector side	AC Outlet side		
 <p>To POWER CORD CONNECTOR on your projector.</p>	<p><b>For the U.S.A. and Canada</b></p>  <p>To the AC Outlet. <b>(200-240 V AC)</b></p>	<p><b>For Continental Europe</b></p>  <p>To the AC Outlet. <b>(200-240 V AC)</b></p>	<p><b>For the U.K.</b></p>  <p>To the AC Outlet. <b>(200-240 V AC)</b></p>

# Basic Operation

## Turning On the Projector

- 1 Complete peripheral connections (with a computer, VCR, etc.) before turning on the projector.
- 2 Connect the projector's AC power cord into an AC outlet. The LAMP indicator lights red and the POWER indicator lights green.
- 3 Press the ON/STAND-BY button on the side control or the ON button on the remote control. The LAMP indicator dims and the cooling fans start to operate. The preparation display appears on the screen and the countdown starts.
- 4 After the countdown, the input source that was selected the last time and the Lamp control status icon (see the page 75) appear on the screen.

If the projector is locked with a PIN code, PIN code input dialog box will appear.

### ✓Note:

- When the Logo select function is set to Off, the logo will not be shown on the screen (p.66).
- When Countdown off or Off is selected in the Display function, the countdown will not be shown on the screen (p.54).
- If you press the ON/STAND-BY button on the side control or the remote control during the countdown period, you can skip the countdown and go to the normal operations. In this case, however, the brightness of the image needs some time to stabilize after turning on the projector. The display may flicker after turning on the lamps for the characteristics of the lamps. This is normal operation and not a malfunction.

## Enter a PIN code

Use the Point ▲▼◀▶ buttons on the side control or Number buttons on the remote control to enter a number.

### When using side control

Use the Point ▲▼ buttons on the side control to select a number. Press the Point ▶ button to fix the number and move the red frame pointer to the next box. The number changes to \*. Repeat this step to complete entering a four-digit number. After entering the four-digit number, move the pointer to "Set". Press the SELECT button so that you can start to operate the projector.

### When using remote control

Press the Number buttons on the remote control to enter a number (p.16). When you complete entering a four-digit number, the pointer moves to "Set". Press the SELECT button so that you can start to operate the projector.

If you fixed an incorrect number, use the Point ◀ button to move the pointer to the number you want to correct, and then enter the correct number.

If you entered an incorrect PIN code, "PIN code" and the number (\*\*\*\*) will turn red for a moment. Enter the correct PIN code all over again.



The preparation display will disappear after 20 seconds.

Selected Input Source and Lamp control



(See page 75 for Lamp control status.)

### ✓Note:

- The Lamp replacement icon and the Filter replacement may appear on the screen depending on the usage state of the projector.
- When the filter replacement icon keeps appearing on the screen at turning on the projector for some time and no action is taken to replace the filter, the projector will be automatically shut down in 3 minutes after turning on to protect the projector. (p.68)
- When the Picture in Picture function is set to Mode(1-5), Mode(1-5), Input source, Lamp control status, Lamp replacement icon and Filter warning icon will appear on the screen for 10 seconds.

## PIN Code Input Dialog Box

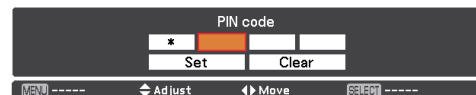

After the OK icon disappears, you can operate the projector.

### ✓Note:

- If the PIN code number is not entered within three minutes after the PIN code dialog box appeared, the projector will be turned off automatically.
- The "1234" is set as the initial PIN code at the factory.

## What is PIN code?

PIN (Personal Identification Number) code is a security code that allows the person who knows it to operate the projector. Setting a PIN code prevents unauthorized use of the projector.

A PIN code consists of a four-digit number. Refer to the PIN code lock function in the Setting Menu on pages 64, 65 for locking operation of the projector with your PIN code.



### CAUTION ON HANDLING PIN CODE

If you forget your PIN code, the projector can no longer be started. Take a special care in setting a new PIN code; write down the number in a column on page 95 of this manual and keep it on hand. Should the PIN code be missing or forgotten, consult your dealer or service center.

## Turning Off the Projector

- 1 Press the ON/STAND-BY button on the side control or the STAND-BY button on the remote control, and Power off? appears on the screen.
- 2 Press the ON/STAND-BY button on the side control or the STAND-BY button on the remote control again to turn off the projector. The LAMP indicator lights bright and the POWER indicator turns off.
- 3 When the projector has cooled down enough, the POWER indicator lights green and then you can turn on the projector.

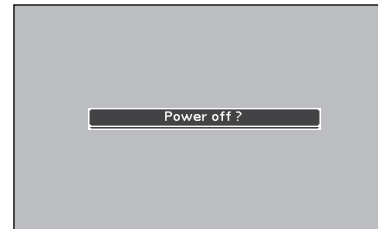

Power off? disappears after 4 seconds.



**TO MAINTAIN THE LIFE OF THE LAMP, ONCE YOU TURN THE PROJECTOR ON, WAIT AT LEAST FIVE MINUTES BEFORE TURNING IT OFF.**



**DO NOT OPERATE THE PROJECTOR CONTINUOUSLY WITHOUT REST. CONTINUOUS USE MAY RESULT IN SHORTENING THE LAMP LIFE. TURN OFF THE PROJECTOR AND LET STAND FOR ABOUT AN HOUR IN EVERY 24 HOURS.**

### ✓ Note:

- When the Direct On function is set to On, the projector will be turned on automatically by connecting the AC power cord to an AC outlet (p.63).
- The running speed of cooling fans is changed according to the temperature inside the projector.
- Do not put the projector in a case before the projector is cooled enough.
- If the WARNING TEMP. indicator blinks red, see "Warning Indicators" on page 79.
- The projector cannot be turned on during the cooling period with the POWER indicator turned off. You can turn it on again after the POWER indicator becomes green again.

### Direct OFF function

You can disconnect the power cord from the wall outlet or turn off the breaker even during projection without pressing the ON/STAND-BY button.

### ✓ Note:

- When using the Direct OFF function, you cannot restart the projector immediately after the power is disconnected. If the external power supply is suddenly cut off, the fan stops immediately. The lamp remains high temperature and needs to be cooled.

## How to Operate the On-Screen Menu

The projector can be adjusted or set via the on-screen menu. The menu has a hierarchical structure, with a main menu that is divided into submenus, which are further divided into other submenus. For each adjustment and setting procedure, refer to respective sections in this manual.

- 1 Press the MENU button on the side control or the remote control to display the on-screen menu.
- 2 Use the Point ▲▼ buttons to highlight or select a main menu item. Press the Point ► or the SELECT button to access the submenu items. (The selected item is highlighted in orange.)
- 3 Use the Point ▲▼ buttons to select the desired submenu item and press the SELECT button to set or access the selected item.
- 4 Use the Point ▲▼◀▶ buttons to adjust the setting or switch between each option and press the SELECT button to activate it and return to the submenu.
- 5 Press the Point ◀ button to return to the main menu. Press the MENU button to exit the on-screen menu.

### Side Control

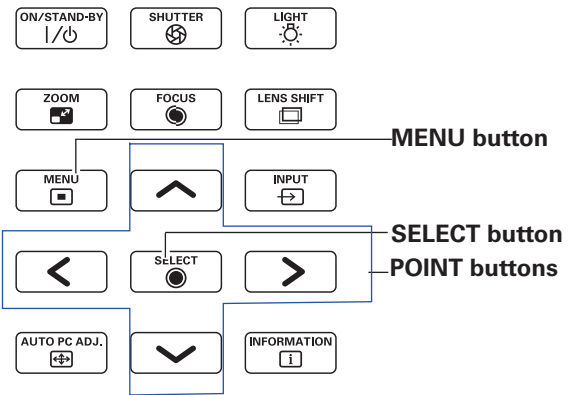

### Remote Control

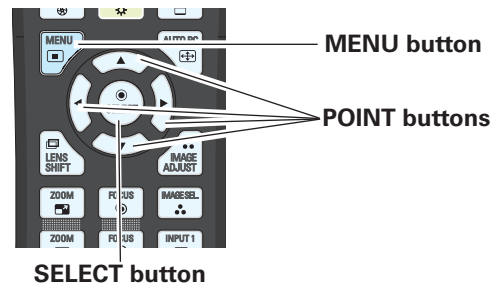

### On-screen menu

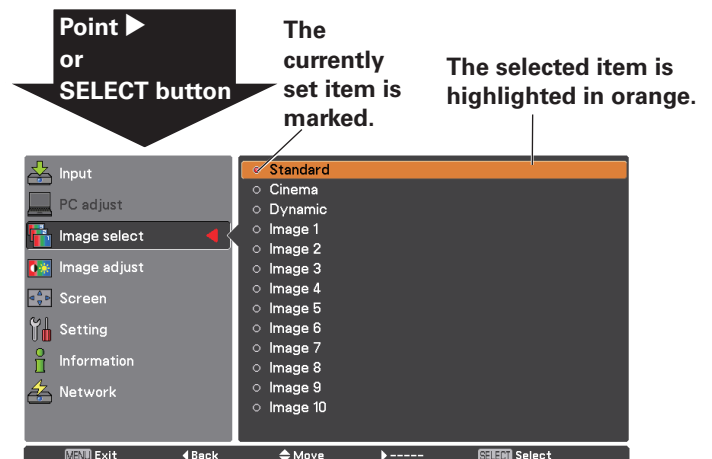

## Main Menu

For detailed functions of each menu, see “Menu Tree” on pages 83-85.

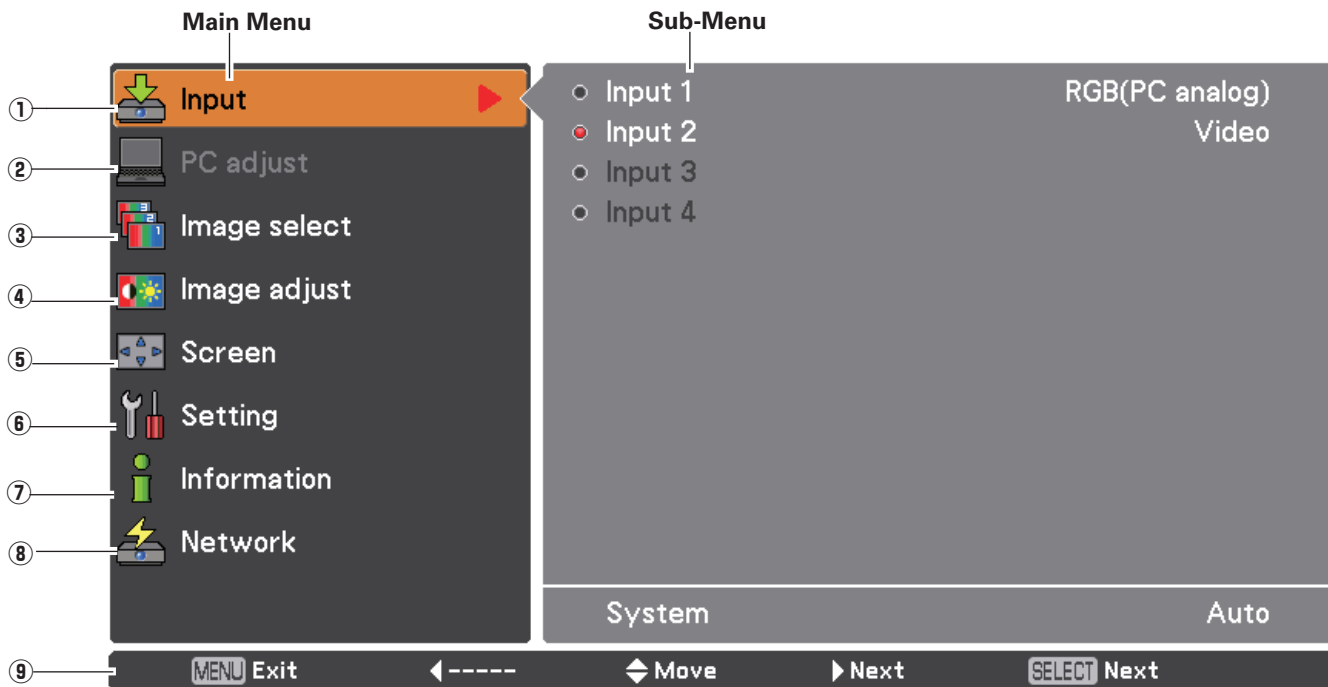

- ① **Input**  
Used to select an input source (Input 1, Input 2, Input 3, or Input 4) (p.33-35).
- ② **PC adjust**  
Used to adjust the parameters to match with the input signal format (pp.37-39).
- ③ **Image select**  
For computer source, used to select an image level among **Dynamic, Standard, Real, and Image 1-10** (p.40).  
For Video source, used to select an image level among **Dynamic, Standard, Cinema, and Image 1-10** (p.48).
- ④ **Image adjust**  
For computer source, used to adjust the computer image. [**Contrast/Brightness/Color management/Color temp./White balance (R/G/B)/Offset(R/G/B)/Auto picture control/Advanced color/Sharpness/Gamma/Reset/Store**] (pp.41-43).  
For video or HDMI source, used to adjust the video image. [**Contrast/Brightness/Color/Tint/Color management/Color temp./White balance (R/G/B)/Offset (R/G/B)/Auto picture control/Advanced color/Sharpness/Gamma/Noise Reduction/Progressive/Reset/Store**] (pp.49-51).
- ⑤ **Screen**  
For computer source, used to adjust the size of the image. [**Normal/Full/Wide(16:9)/Zoom/True/Custom/Custom adj./Digital zoom +/-/Keystone/Ceiling/Rear/Screen aspect/Reset**] (pp.44-46).  
For video or HDMI source, used to adjust the size of the image. [**Normal/Full/Wide(16:9)/Zoom/Natural wide/Custom/Custom adj./Keystone/Ceiling/Rear/Screen aspect/Reset**] (pp. 52-53).
- ⑥ **Setting**  
Used to set the projector's operating configurations (pp.54-69).
- ⑦ **Information**  
Displays the input source information: **Input, H-sync freq., V-sync freq., Screen, Lamp mode, Lamp control, Lamp interval, Lamp 1, Lamp 2, Lamp 3, Lamp 4, Language, Filter counter, Power management, Key lock, PIN code lock, Shutter management, Remote control, SERIAL NO. and Option control No.** (p.30).
- ⑧ **Network**  
See the owner's manual of "Network Set-up and Operation".
- ⑨ **Guide**  
The key operation is displayed.

## Operating with Projector Control

### Light Function

Light function is used to turn on the lights on the side control and around terminals. To turn off the lights, press the Light button again.

**✓Note:**

- The buttons on the side control except for the LIGHT button and ON/STAND-BY button do not light up when the projector is in stand-by mode or during the cooling down period.

### Auto PC Adjustment

Operates the Auto PC Adj. function. The computer screen adjustment can be done easily by pressing this button. See page 37 for details.

### Zoom Adjustment

Press the ZOOM button and "Zoom" will be displayed on the screen. And then press the Point ▲▼ buttons to zoom in and out the image.

### Focus Adjustment

Press the FOCUS button and "Focus" will be displayed on the screen. And then press the Point ▲▼ buttons to adjust the focus of the image.

### Lens Shift Adjustment

Press the LENS SHIFT button and "Lens shift" will be displayed on the screen. Use the Pointed ▲▼◀▶ buttons to position the projection image to the desired point without having picture distortion.

Press and hold the LENS SHIFT button for more than 5 seconds to return the lens to the central position. See page 18 for details.

### Shutter Function

Shutter function allows you to completely block out light to the screen. Press the SHUTTER button to close the shutter inside the projector. To open up the shutter, press the SHUTTER button again. Refer to p.66 for detail of setting for the Shutter function.

### Information

Information display can be used to confirm the current operating condition of the projector and the signal being projected through the projector.

Press the INFORMATION button to toggle between the current and next Information menus and the cancellation of menu display.

The Information menu can also be selected from the menu.

### Side Control

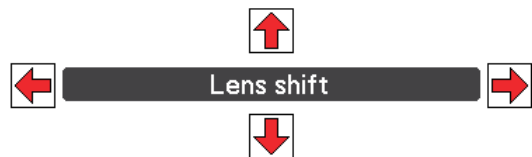
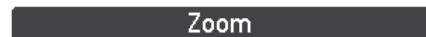
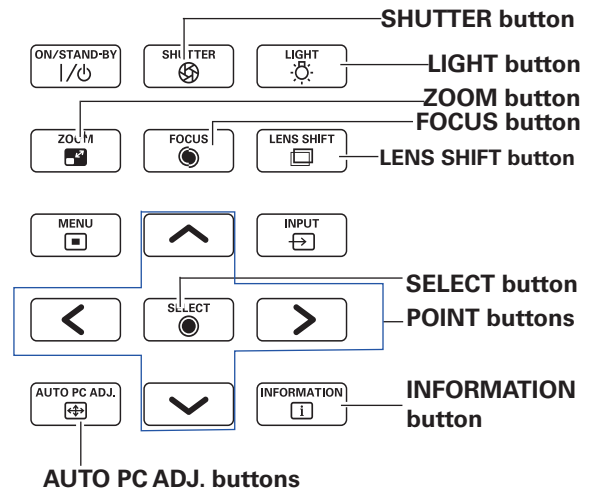

**✓Note:**

- The arrow disappears at the maximum lens shift in each direction.
- The arrows turn red when the lens shift comes to the center position of the screen.

**✓Note:**

- The SHUTTER button on the side control and the remote control cannot be effective when Shutter Protection is On in the Setting menu. (p.66)
- The SHUTTER indicator on the projector's top lights blue when the shutter is closed. (pp.13, 86)
- The projector will shut down automatically when the set time on shutter management has passed. (p.66)
- The Power management function does not work when the shutter is closed. (p.63)

## Operating with Remote Control

Using the remote control for some frequently used operations is advisable. Just pressing one of the buttons enables you to make the desired operation quickly without calling up the On-Screen Menu.

### SHUTTER button

See page 28 for details.

### MENU button

Press the MENU button to show the main menu. Press the button again to hide the menu.

### LENS SHIFT button

See page 28 for details.

### ZOOM buttons

Press the ZOOM buttons on the remote control to zoom in and out the image.

### D.ZOOM button

Press the D.ZOOM button on the remote control to enter to the Digital zoom +/- mode. See page 45 for details.

### SCREEN button

Press the SCREEN button on the remote control to select the desired screen size. The selected screen size symbol appears on the screen for 4 seconds. See pages 44 to 46 and 52 to 53 for details.  
Press and hold the SCREEN button for more than 5 seconds to return all the screen size adjustment setting to the factory default setting.

### AUTO PC button

Press the AUTO PC button on the remote control to operate the Auto PC adj. function. The computer screen adjustment can be done easily by pressing this button. See page 37 for details.

### IMAGE ADJUST button

Press the IMAGE ADJUST button to show the IMAGE ADJUST menu. Press this button again to hide the menu.

### FOCUS buttons

Press the FOCUS buttons on the remote control to adjust focus of the image.

### Remote Control

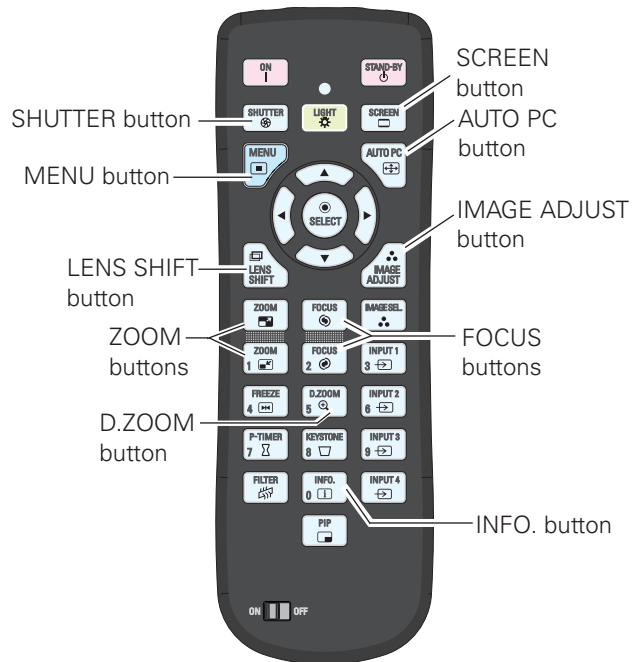

#### ✓Note:

See the next page for the description of other buttons.



## INFO. button

Press the INFO. button to confirm the current settings of the projector and the signals being transmitted to the projector. Use the Point ◀▶ buttons or INFO. button to toggle back and forth between the current and next Information menus and the cancellation of menu display.

✓ **Note:**

- The H-sync freq. and V-sync freq. values shown in the menu list may be different from the actual values.
- SERIAL NO. is used to service the projector.

### Information Menu

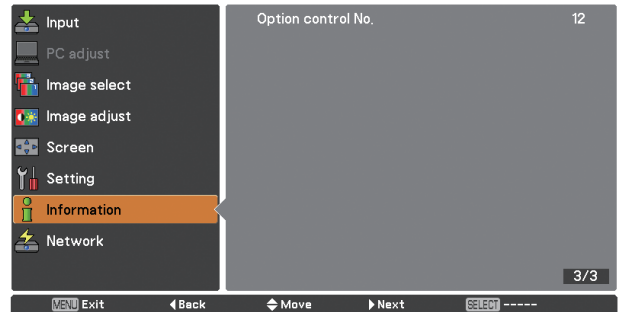
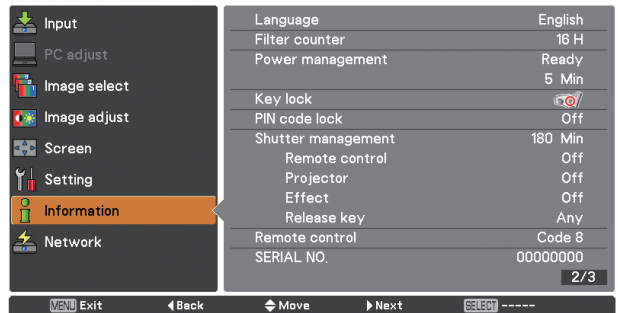
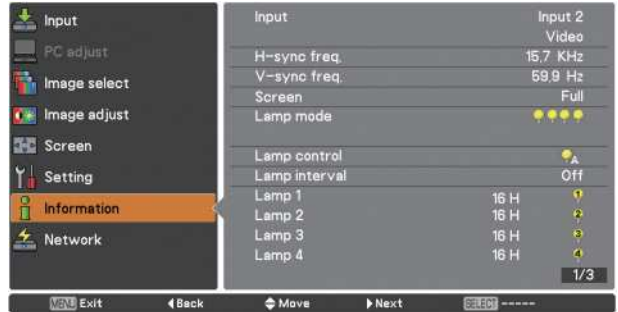

## LIGHT button

Press the LIGHT button to turn on/off Keypad backlight.

## FREEZE button

Press the FREEZE button on the remote control to freeze the picture on the screen. To cancel the FREEZE function, press the FREEZE button again or press any other button.

Fig.1 will appear when the Freeze function is working.



Fig.1

## P-TIMER button

Press the P-TIMER button on the remote control to operate the Count up/Count down function. Refer to p.68 for detail of Setting for the P-timer function for a few seconds. To stop the count time, press the P-TIMER button. To cancel the P-timer function, press and hold the P-TIMER button.

## FILTER button

Press and hold the FILTER button for more than five seconds to schedule a filter cleaning task.

## IMAGE SEL. button

Press the IMAGE SEL. button on the remote control to select a desired image level of the screen. For more detail, see pp.40, 48.

## KEystone button

See page 32 for details.

## PIP button

Press the PIP button on the remote control several times until the desired mode of Picture in Picture appears. Each user mode (User 1-5) appears only when it has stored data.

Press and hold the PIP button for more than 3 seconds to display the setting dialog box of Picture in Picture. See pages 56-57 for details of Picture in Picture function.

## Remote Control

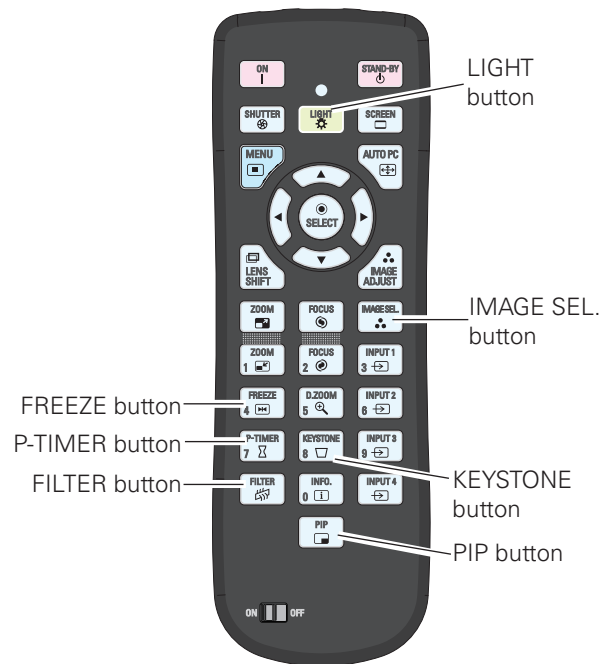

### ✓Note

See the previous page for the description of other buttons.

### User 1 of PIP (example)

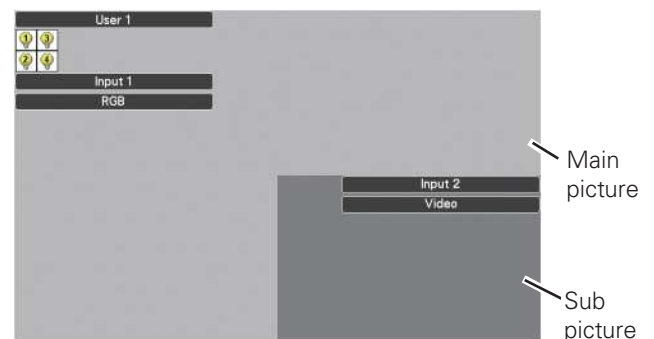

### User 2 of PIP (example)

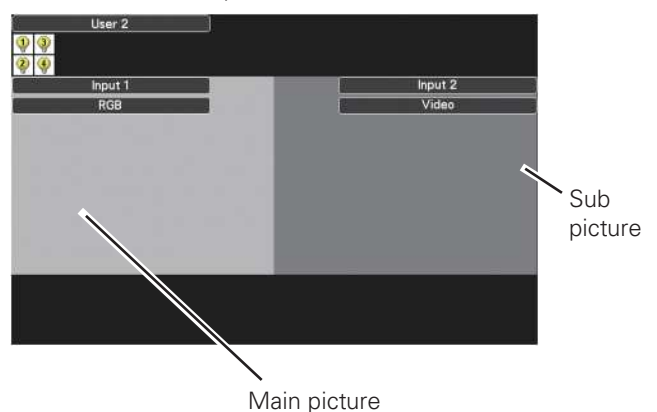

## Keystone Correction

Press the KEYSTONE button on the remote control to switch the Standard (for Vertical/Horizontal) /Corner correction adjustment. The Standard or Corner correction adjustment dialog box appears. Use the Point ▲▼◀▶ buttons to correct the Standard or Corner distortion. The Standard or Corner correction adjustment can be stored (see pages 46, 53).

Remote Control

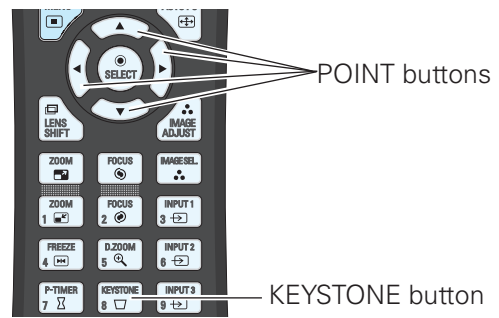

### Standard

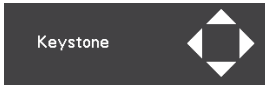

Reduce the lower width with the Point ▼ button.

Reduce the upper width with the Point ▲ button.

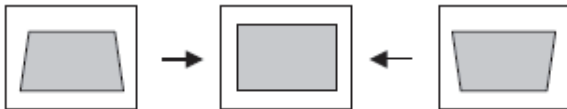

Reduce the right part with Point ▶ button.

Reduce the left part with Point ◀ button.

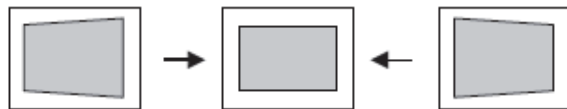

### Corner correction

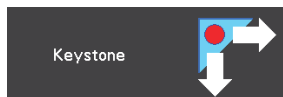

Press the KEYSTONE button on the remote control to switch Corner correction adjustment, press the SELECT button on the remote control to select the corner you want to adjust.

Reduce the top left corner part with the Point ▶▼ buttons. Reduce the top right corner part with the Point ◀▼ buttons.



Press the SELECT button

Press the SELECT button

Press the SELECT button

Press the SELECT button



Reduce the bottom left corner part with the Point ▶▲ buttons.

Reduce the bottom right corner part with the Point ◀▲ buttons.

#### ✓Note:

- The white arrows indicate that there is no correction.
- A red arrow indicates the direction of correction.
- An arrow disappears at the maximum correction.
- If you press and hold the KEYSTONE button for more than 3 seconds while the Standard or Corner correction dialog box is being displayed, the Standard or Corner correction adjustment will be released.
- The Corner pattern can be set to Off, Red, White or Blue in the Corner pattern function. See "Keystone" on pages 46, 53.
- The adjustable range is limited depending on the input signal.
- Standard and Corner correction functions cannot be adjusted at the same time. If one of the functions is adjusted, and then the other one will be reset automatically.

The top left corner adjustment as an example:

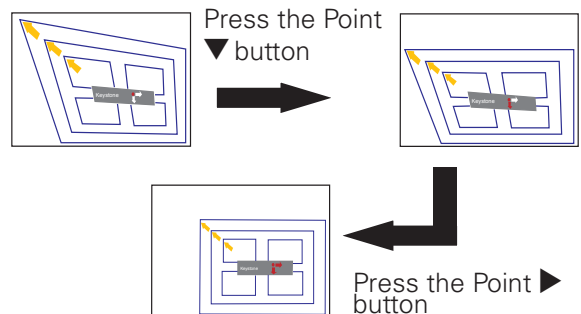

# Input Selection

## Direct Operation

### Side Control

Side Control

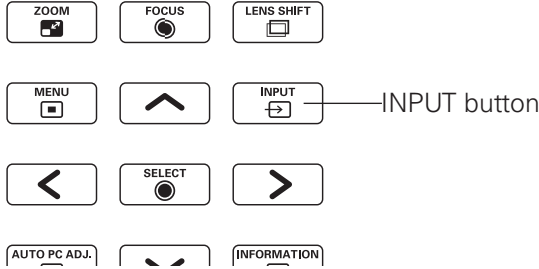

The input source changes each time you press the INPUT button on the side control as follows:

Input 1→Input 2→ ...

Before using the INPUT button on the side control or the remote control, you must select a correct input source by On-Screen Menu and the latest input source will be displayed.

### Remote Control Operation

Press the INPUT 1, INPUT 2, INPUT 3 or INPUT 4 button on the remote control. The input source appears on the screen as you press each button. Select the connected input source.

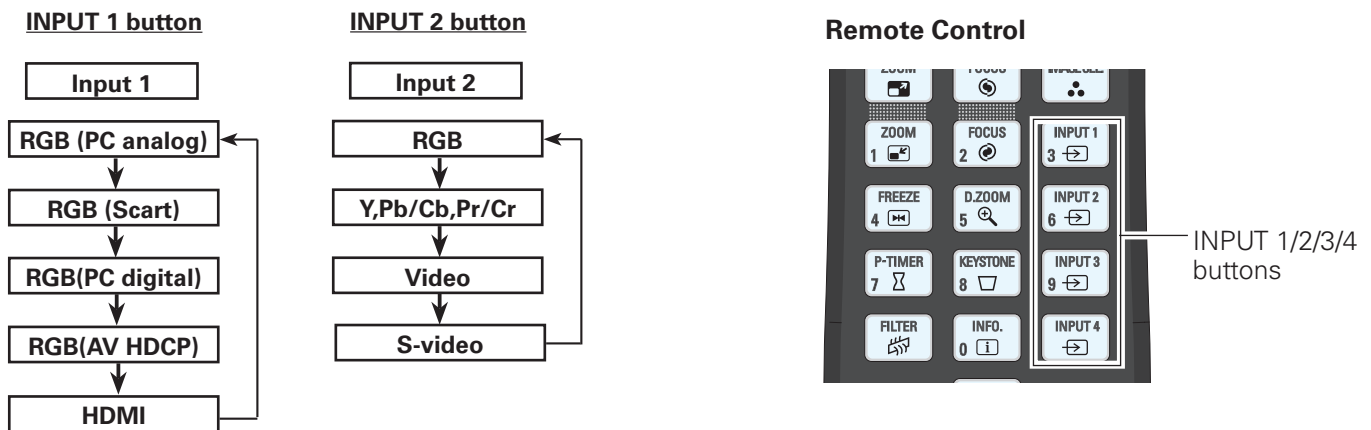

✓ **Note:**

- "Input 3" and/or "Input 4" are selectable only when interface board(s) are connected to either or both of the slots.

## Computer Input Source Selection

### Menu Operation

- 1 Press the MENU button to display the On-Screen Menu. Use the Point ▲▼ buttons to select Input and then press the Point ► or the SELECT button.
- 2 Use the Point ▲▼ buttons to select the desired input and then press the Point ► button to access the submenu items.
- 3 Use the Point ▲▼ buttons to select the desired source and then press the SELECT button.

✓ **Note:**

- "Input 3" and/or "Input 4" are selectable only when interface board(s) are connected to either or both of the slots.

### WHEN SELECTING INPUT 1 (COMPUTER INPUT TERMINALS)

#### RGB(PC analog)

When your computer is connected to the INPUT 1 (ANALOG) terminal, select RGB (PC analog).

✓ **Note:**

- Input source changes if the INPUT 1 button on the remote control is pressed.

### WHEN SELECTING INPUT 2 (5 BNC INPUT JACKS)

When connecting the computer output [5 BNC Type (Green, Blue, Red, Horiz. Sync, and Vert. Sync.)] from the computer to G, B, R, H/HV, and V jacks:

#### RGB

When your computer is connected to the INPUT 2 (5 BNC INPUT JACKS) terminal, select RGB.

### INPUT MENU

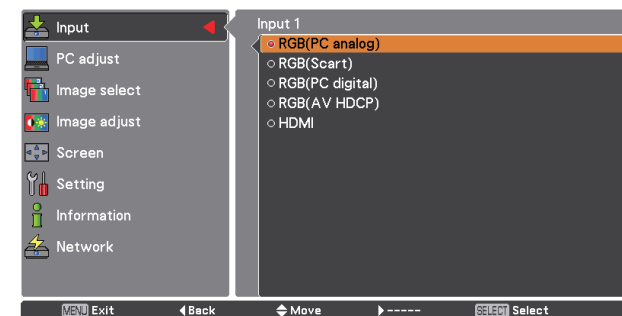
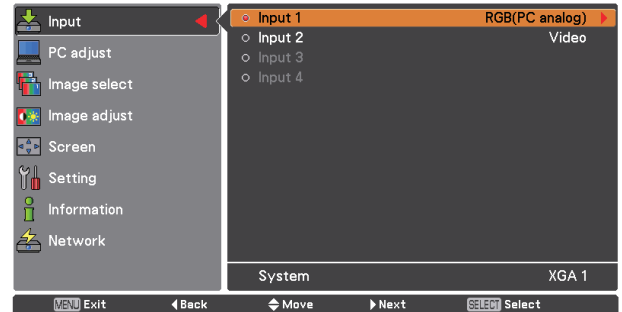
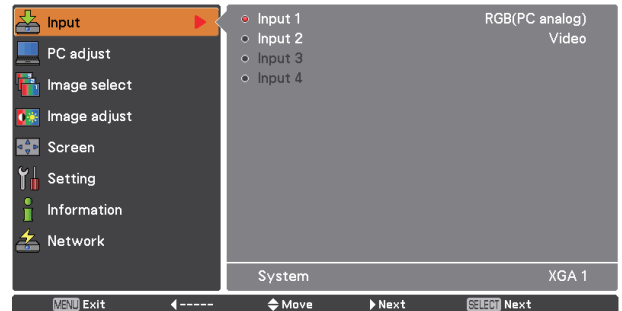

### INPUT 2 MENU

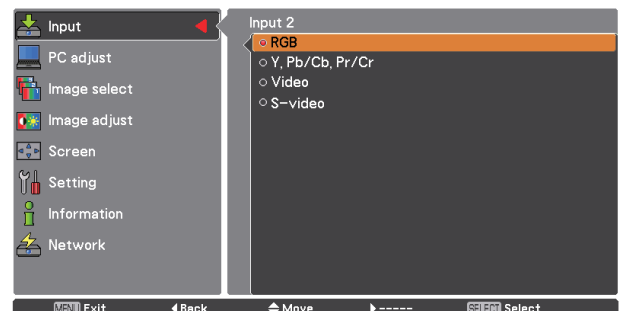

## Video Input Source Selection

### Menu Operation

- 1 Press the MENU button to display the On-Screen Menu. Use the Point ▲▼ buttons to select Input and then press the Point ► or the SELECT button.
- 2 Use the Point ▲▼ buttons to select the desired input and then press the Point ► button to access the submenu items.
- 3 Use the Point ▲▼ buttons to select the desired source and then press the SELECT button.

#### WHEN SELECTING INPUT 1 (COMPUTER INPUT TERMINALS )

When connecting to video equipment, select the type of Video source in the Source Select Menu.

##### RGB(Scart)

When scart video equipment is connected to the INPUT 1 (ANALOG) terminal, select RGB (Scart).

##### RGB(PC digital)

When your computer is connected to INPUT 1 (DIGITAL) terminal, select RGB (PC digital).

##### RGB(AV HDCP)

If the HDCP-compatible signal source is connected to the INPUT 1 (DIGITAL) terminal, select RGB (AV HDCP).

##### HDMI

When the video signal is connected to the HDMI terminal, select HDMI.

#### WHEN SELECTING INPUT 2 (5 BNC INPUT JACKS )

When connecting to video equipment, select the type of Video source in the Source Select Menu.

##### Y, Pb/Cb, Pr/Cr

When the video input signal is connected to the Y, Pb/Cb, Pr/Cr jacks, select Y, Pb/Cb, Pr/Cr.

##### Video

When the video input signal is connected to the VIDEO jack, select Video.

##### S-Video

When the video input signal is connected to the S-VIDEO jack, select S-Video.

#### ✓Note:

- When the video input signal is connected to the Y-Pb/Cb-Pr/Cr jacks, Y,Pb/Cb,Pr/Cr takes precedence of RGB.
- Y,Pb/Cb,Pr/Cr input can accept the component signal and the analog RGB signal. When analog RGB signal is not recognized in Y,Pb/Cb,Pr/Cr input source, set to RGB input manually.

#### INPUT 1 MENU

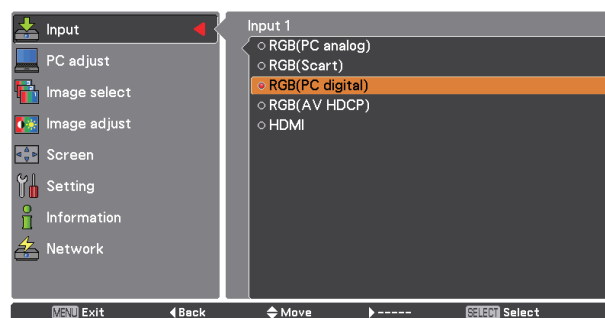

#### INPUT 2 MENU

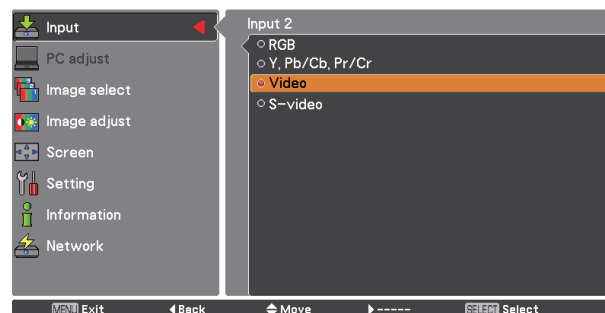

# Computer Input

## Computer System Selection

### Automatic Multi-Scan System

This projector automatically tunes to various types of computers with its Multi-scan system and Auto PC adjustment. If a computer is selected as a signal source, this projector automatically detects the signal format and tunes to project a proper image without any additional settings. (Signal formats provided in this projector are shown on pages 89-91)

### Selecting Computer System Manually

PC system can also be selected manually.

- 1 Press the MENU button to display the on-screen menu. Use the Point ▲▼ buttons to select Input and then press the Point ► or the SELECT button.
- 2 Use the Point ▲▼ buttons to select System and then press the Point ► or the SELECT button.
- 3 Use the Point ▲▼ buttons to select the desired system and then press the SELECT button.

One of the following messages may appear when:

#### Auto

When the projector cannot recognize the connected signal conforming to the provided PC Systems, Auto is displayed on the System Menu box and the Auto PC adjustment function works to display proper images. If the image is not projected properly, a manual adjustment is required (pp.38, 39).

-----

There is no signal input from the computer. Check the connection between your computer and the projector. (See "Troubleshooting" on pp.80-82.)

#### Mode 1

The preset system is manually adjusted in the PC adjust menu. The adjusted data can be stored in Mode 1-10 (pp.38, 39).

#### SVGA 1

PC Systems provided in this projector is chosen. The projector chooses a proper system provided in the projector and displays it.

\*Mode 1 and SVGA 1 are examples.

### PC System Menu

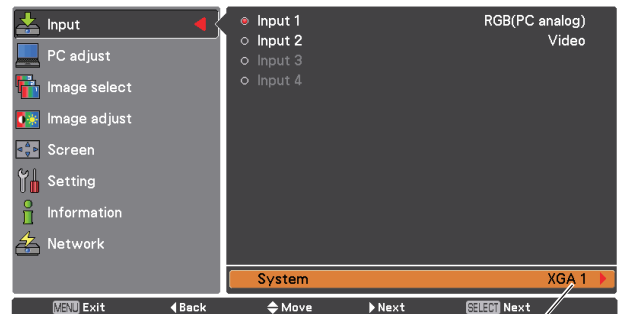

Selected system is displayed.

### PC System Menu

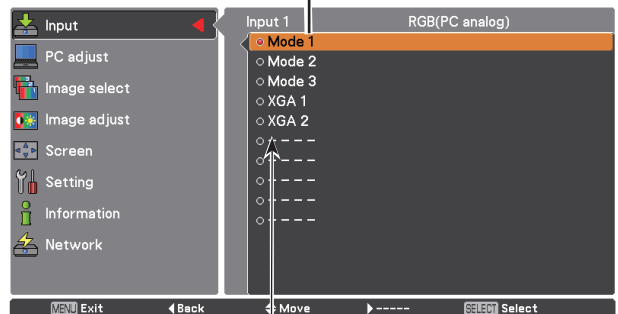

Customized Mode (1-10) set in the PC adjust menu (pp.38, 39).

Systems in this dialog box can be selected.



## Auto PC Adjustment

Auto PC Adjustment function is provided to automatically adjust Fine sync, Total dots, Position H and Position V to conform to your computer.

### Direct Operation

The Auto PC adjustment function can be operated directly by pressing the AUTO PC button on the remote control.

Remote Control

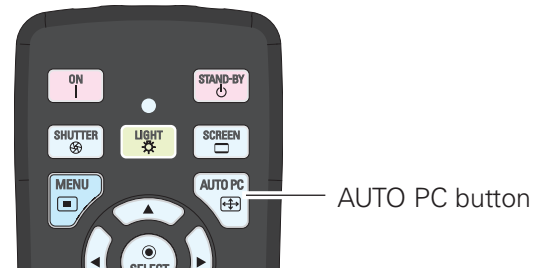

### Menu Operation

#### Auto PC adj.

- 1 Press the MENU button to display the On-Screen Menu. Use the Point ▲▼ buttons to select PC adjust and then press the Point ► or the SELECT button.
- 2 Use the Point ▲▼ buttons to select Auto PC adj. and then press the SELECT button.

#### To store the adjusted parameters.

The adjusted parameters from the Auto PC Adjustment can be stored in the projector. Once the parameters are stored, the setting can be done just by selecting Mode in PC System Menu (p.36). See "Manual PC Adjustment" on pages 38, 39.

#### ✓Note:

- Fine sync, Total dots, Position H and Position V of certain computers cannot be fully adjusted with the Auto PC Adjustment function. When the image is not provided properly with this operation, manual adjustments are required. (pp.38, 39)
- The Auto PC adjustment cannot be operated when 480i, 575i, 480p, 575p, 720p, 1035i, 1080i or 1080p is selected in the PC System Menu (p.36), or when the signal is coming from the HDMI/DVI-D terminal.
- Depending on the condition of signals and the type and length of cables, the signals may not be properly viewed.

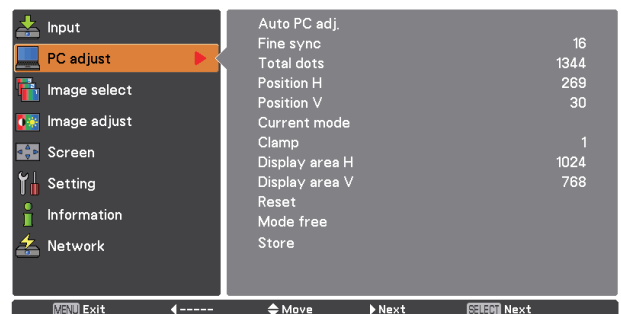

Use the Point ▲▼ buttons to select "Auto PC adj." and press the SELECT button. Please wait... appears while the Auto PC adjustment is in process.

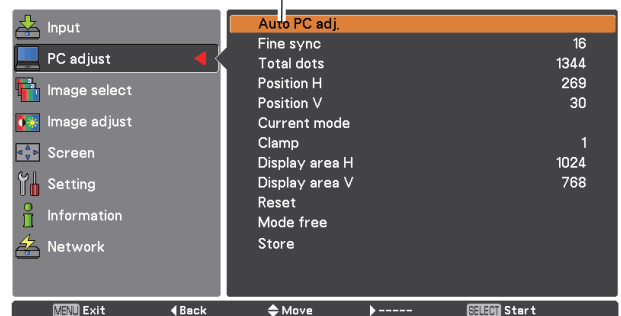

## Manual PC Adjustment

Some computers employ special signal formats which may not be tuned by Multi-Scan system of this projector. Manual PC Adjustment enables you to precisely adjust several parameters to match those special signal formats. The projector has 10 independent memory areas to store those parameters manually adjusted. It allows you to recall the setting for a specific computer.

- 1 Press the MENU button to display the On-Screen Menu. Use the Point ▲▼ buttons to select PC adjust and then press the Point ► or the SELECT button.
- 2 Use the Point ▲▼ buttons to select the desired item and then press the SELECT button to display the adjustment dialog box. Use the Point ◀▶ buttons to adjust the setting value.

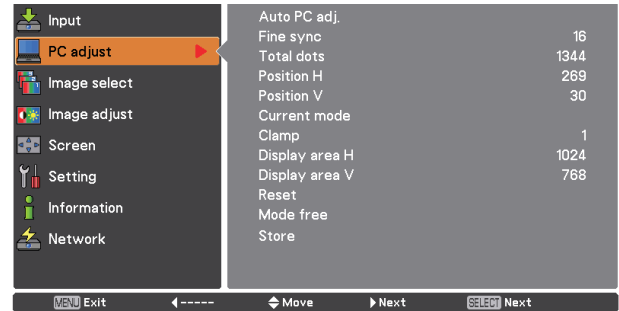

### Fine sync

Use the Point ◀▶ buttons to adjust the value, eliminating a flicker from the image displayed (from 0 to 31).

### Total dots

Use the Point ◀▶ buttons to adjust the number of total dots in one horizontal period to match your PC image.

### Position H

Use the Point ◀▶ buttons to adjust the horizontal picture position.

### Position V

Use the Point ◀▶ buttons to adjust the vertical picture position.

### Current mode

Press the SELECT button to show H-sync freq. and V-sync freq. of the connected computer.

### Clamp

Use the Point ◀▶ buttons to adjust the clamp level. When the image has dark bars, try this adjustment.

### Display area H

Use the Point ◀▶ buttons to adjust the horizontal area displayed by this projector.

### Display area V

Use the Point ◀▶ buttons to adjust the vertical area displayed by this projector.

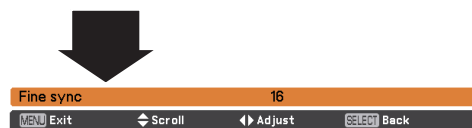
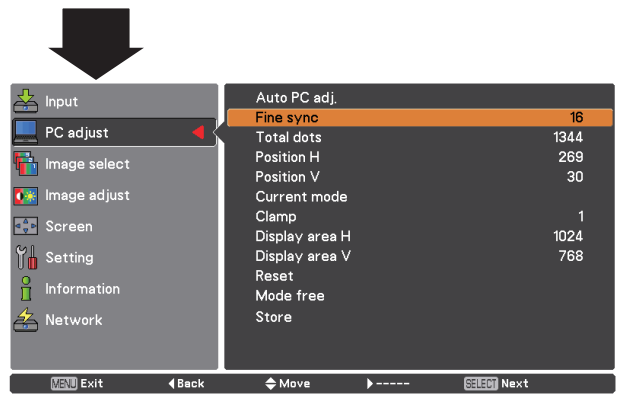

## Reset

To reset the adjusted data, select Reset and press the SELECT button. A confirmation box appears and then select Yes. All adjustments will return to their previous figures.

## Mode free

To clear the stored data, select Mode free and then press the Point ► or the SELECT button. Move the highlight to the Mode that you want to clear and then press the SELECT button.

## Store

To store the adjusted data, select Store and then press the Point ► or the SELECT button. Move the highlight to one of the Modes 1 to 10 in which you want to store, and then press the SELECT button.

### Mode free

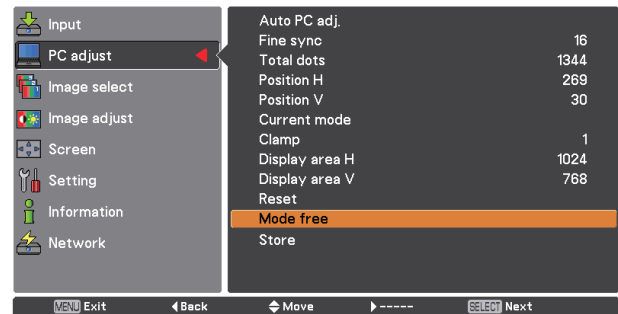

This mode has stored parameters.

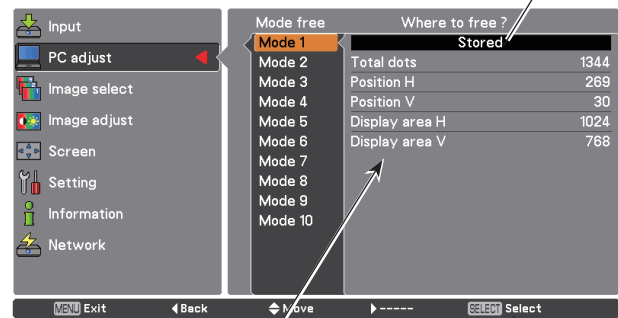

Values of Total dots, Position H, Position V, Display area H and Display area V.

Press the SELECT button to clear the stored data.

### Store

No parameters stored

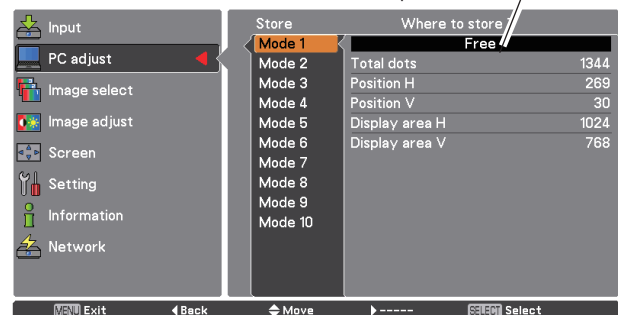

Press the MENU button to close this dialog box.

Press the SELECT button to store the data.

### ✓Note

- Display area (H/V) cannot be selected when 480i, 575i, 480p, 575p, 720p, 1035i, 1080i or 1080p is selected in the PC System Menu (p.36).
- When input computer signal to the projector, PC adjust function will become available.

## Image Selection

### Menu Operation

- 1 Press the MENU button to display the On-Screen Menu. Use the Point ▲▼ buttons to select Image select and then press the Point ► or the SELECT button.
- 2 Use the Point ▲▼ buttons to select the desired item and then press the SELECT button.

#### Standard

Normal picture level preset on the projector.

#### Real

Picture level with improved halftone for graphics.

#### Dynamic

For viewing pictures in a bright room.

#### Image 1-10

User preset picture adjustment in the Image adjust Menu. (pp.41-43)

#### Image select



## Image Adjustment

- 1 Press the MENU button to display the On-Screen Menu. Use the Point ▲▼ buttons to select Image adjust and then press the Point ► or the SELECT button.
- 2 Use the Point ▲▼ buttons to select the desired item and then press the SELECT button to display the adjustment dialog box. Use the Point ◀▶ buttons to adjust the setting value.

### Contrast

Press the Point ◀ button to decrease the contrast; press the Point ► button to increase the contrast (from 0 to 63).

### Brightness

Press the Point ◀ button to decrease the brightness; press the Point ► button to increase the brightness (from 0 to 63).

### Color management

The Color Management function can be used to adjust the LEVEL, PHASE, and GAMMA of the selected display colors (except for black, white, and gray) on the screen and replace these colors with other colors if required.

You can store up to eight (8) color management data.

- 1 Select and highlight Color Management by using the Point ▲▼ buttons and press the SELECT button. The projected image freezes, and the COLOR MANAGEMENT POINTER appears.
- 2 Use the Point ▲▼◀▶ buttons to move the pointer to the spot where you want to adjust the color and then press the SELECT button. The COLOR SELECTION window appears, and the color in the center of the pointer is selected and you can adjust the color.
- 3 Use the Point ▲▼◀▶ buttons to adjust the LEVEL and PHASE of the color, and then press the SELECT button to confirm the setting. Then use the Point ▲▼ buttons to adjust the GAMMA for the color and press the SELECT button to accept the setting. After adjusting, press the SELECT button to go to the COLOR MANAGEMENT LIST.

### COLOR SELECTION MODE

#### LIST

Go to the COLOR MANAGEMENT LIST.

#### COLOR M.

Return to the COLOR MANAGEMENT POINTER. (If you press the MENU button on the side control or the remote control, it returns to the COLOR MANAGEMENT POINTER and you will need to reselect and readjust the color.)

### Image Adjust Menu

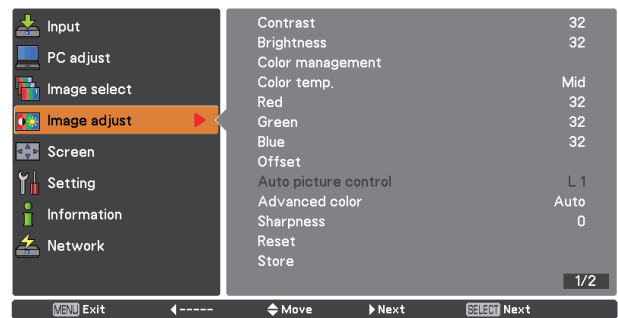

Selected Image mode

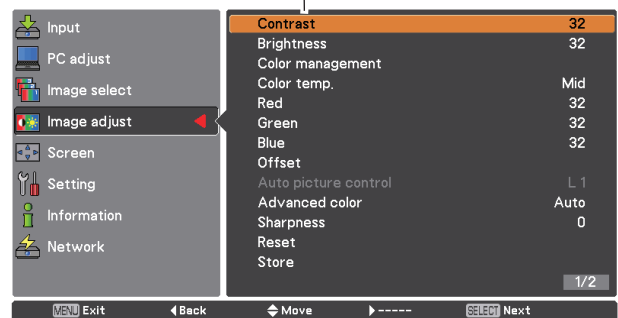

Use the Point ◀▶ buttons to adjust the setting value.



### ✓Note

When White balance Red, Green or Blue is adjusted, Color temp. will change to Adj.

### POINTER MODE

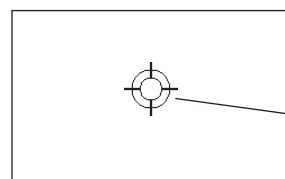

COLOR MANAGEMENT POINTER

## MENU

Return to the IMAGE ADJUST Menu. Any settings that have been changed will not be stored. To store the changed settings, be sure to select "LIST" and go to the COLOR MANAGEMENT LIST.

- 4** In the COLOR MANAGEMENT LIST, the adjusted color data are checkmarked. You can decide whether or not to apply the adjusted color data in the list to the projected image (see below).

## LIST MODE



Clear the check mark if you do not want to apply the adjusted color data; select the check mark and then press the SELECT button. The check mark disappears.

## COLOR PALETTE

Return to the COLOR SELECTION mode so that you can readjust the setting for the color in that line. (This option is not available if the check mark is cleared.)

## DEL

Select the DEL box if you want to delete the adjusted data. Press the SELECT button and a confirmation box appears and then select [Yes].

## ALL DEL

Delete all the data in the list. Press the SELECT button and a confirmation box appears and then select [Yes].

## MENU

The same function as stated above.

## COLOR M.

The same function as stated above.

### Color temp.

Use the Point ◀▶ buttons to select the desired Color temp. level (XLow, Low, Mid or High).

### White balance (Red)

Press the Point ◀ button to lighten red tone; press the Point ▶ button to deepen red tone (from 0 to 63).

### White balance (Green)

Press the Point ◀ button to lighten green tone; press the Point ▶ button to deepen green tone (from 0 to 63).

### White balance (Blue)

Press the Point ◀ button to lighten blue tone; press the Point ▶ button to deepen blue tone (from 0 to 63).

## COLOR SELECTION MODE

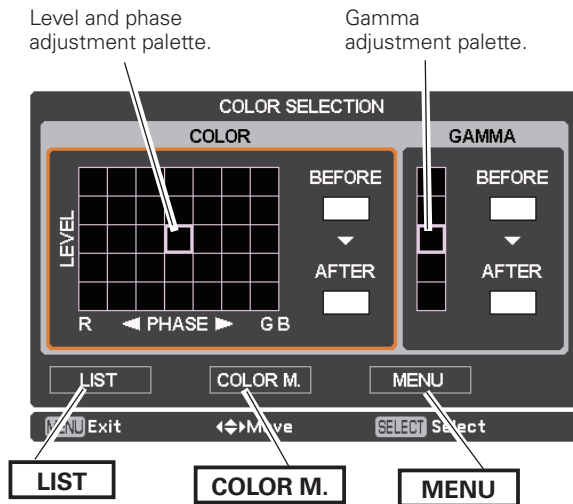

## LIST MODE

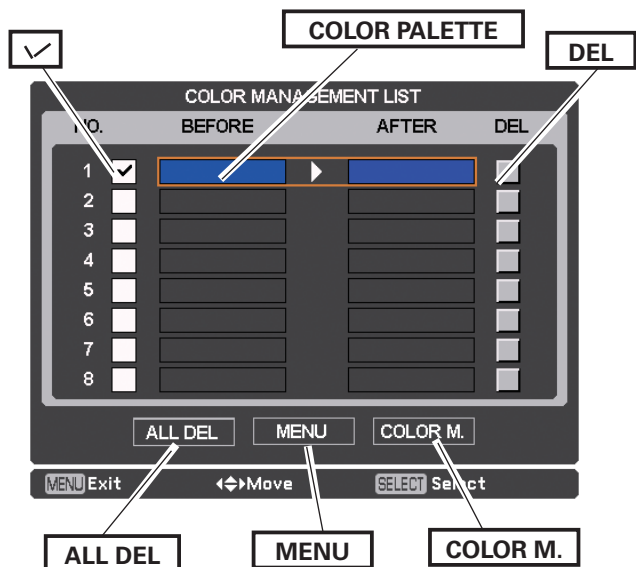

## Offset (Red/Green/Blue)

Press the Point ◀ button to lighten red/green/blue tone of the black level of an image; press the Point ▶ button to deepen red/green/blue tone of the black level of an image.

## Auto picture control

Use the Point ◀▶ buttons to select the desired Auto picture control option (Off, L1 or L2).

- Off . . . . Auto picture control OFF position.
- L1 . . . . Auto picture control LEVEL 1 position.
- L2 . . . . Auto picture control LEVEL 2 position.

## Advanced color\*

Use the Point ◀▶ buttons to select the advanced color mode.

- Off . . . . Advanced color mode is "Off"
- Auto . . . . Advanced color according to the type of image.

## Sharpness

Press the Point ◀ button to decrease the sharpness of the image; press the Point ▶ button to increase the sharpness of the image (from 0 to 31).

## Gamma

Use the Point ◀▶ buttons to adjust the gamma value to obtain a better balance of contrast (from 0 to 15).

## Reset

To reset the adjusted data, select Reset and press the SELECT button. A confirmation box appears and then select Yes. All adjustments will return to their previous figures.

## Store

To store the adjusted data, select Store and press the Point ▶ or the SELECT button. Use the Point ▲▼ buttons to select one from Image 1 to 10 and press the SELECT button.

A confirmation box appears and then select Yes. Stored data can be called up by selecting an Image (1-10) in the Image Mode Selection on page 40.

\*This function controls the operation of the Color Control Devic, which independently and automatically regulates the amount of yellow light passing through the LCD panel, to accurately reproduce both image color and image brightness. Normally leave Auto (default setting).

### ✓ Note:

- White balance may change depending on the image.



A confirmation box appears and then select Yes.

## Screen Size Adjustment

Select the desired screen size that conforms to the input signal source.

- 1 Press the MENU button to display the On-Screen Menu. Use the Point ▲▼ buttons to select Screen and then press the Point ► or the SELECT button.
- 2 Use the Point ▲▼ buttons select the desired item and then press the SELECT button.

### Normal

Provides the image within a screen size keeping its original aspect ratio.

### Full

Provides the image to fit full screen size.

### Wide (16:9)

Provides the image at the 16:9 wide screen ratio.

### Zoom

Scales the image proportionally to fit the entire screen. Either side of image may go over the screen.

### True

Displays an image based on the output resolution from the computer

- Less than the panel resolution (2048x1080)  
The image is centered on the screen.
- Equal to the panel resolution (2048x1080)  
"Normal" appears at a corner of the screen.
- Higher than the panel resolution (2048x1080)  
Panning mode begins with "True" displayed on the screen. In this case, the Zoom function is not available.

When the original image size is larger than the panel size (2048x1080), the projector enters to the panning mode automatically. Use the Point ▲▼◀▶ buttons to pan the image. When adjusted, the arrows will turn red. When reached to the correction limits, the arrows will disappear.

### Custom

Provides the last stored aspect screen image.

### Screen menu

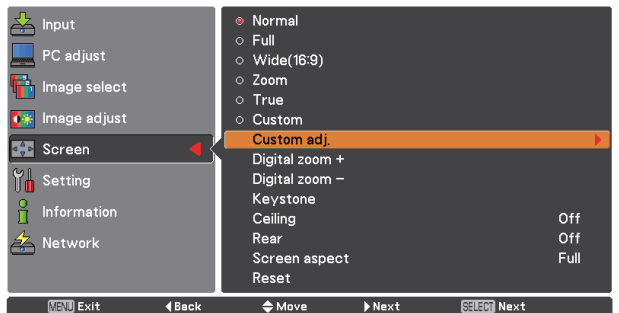
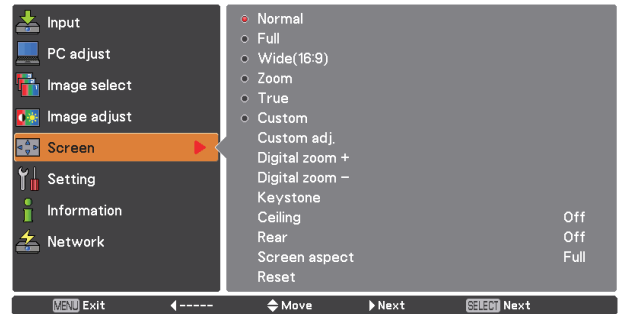

### ✓ Note

- The projector cannot display any resolution higher than 2048 x 1080. If your computer's screen resolution is higher than 2048 x 1080, lower the resolution before connecting the projector.
- The image data other than 2048 x 1080 is modified to fit the screen size in initial mode.
- Full, Wide(16:9), Zoom, True and Digital zoom +/- cannot be selected when no signal is detected in the PC System Menu. (p.36)
- You cannot zoom out an image smaller than normal size for display in Custom mode.



## Custom adj.

Adjust the screen scale and position manually with this function.

Press the Point ► button or the SELECT button at Custom adj. and Custom adj. is displayed on the screen, you can use the Point ▲▼ buttons to choose the item you want to adjust.

- Scale H/V ..... Adjusts the Horizontal/Vertical screen scale.
- H&V ..... When set to On, the aspect ratio is fixed. Scale V appears dimmed and becomes unavailable. Adjust Scale H, then the screen scale is automatically modified based on the aspect ratio.
- Position H/V ..... Adjusts the Horizontal/Vertical screen position.
- Common..... Saves the adjusted scale to all the inputs. Press the SELECT button at Common to display a confirmation box. To save the scale, press the SELECT button at Yes. When Custom is selected, the saved scale is used.
- Reset ..... Resets the all adjusted values. Press the SELECT button at Reset to display a confirmation box. To reset, press the SELECT button at Yes.



### ✓Note

- When no signal is detected, Normal is set automatically and the Aspect dialog box disappears.
- The adjustable range for Scale H/V and Position H/V is limited depending on the input signal.

## Digital zoom +

Selects Digital zoom +. The On-Screen Menu disappears and D. zoom + appears. Press the SELECT button to expand the image size. Use the Point ▲▼◀▶ buttons to pan the image. The Panning function can work only when the image is larger than the screen size.

You can also enter the Digital zoom + mode by pressing the D.ZOOM button on the remote control.

## Digital zoom -

Selects Digital zoom -. The On-Screen Menu disappears and D. zoom - appears. Press the SELECT button to compress image size.

The projected image can be also compressed by pressing the D.ZOOM button on the remote control.

You can also enter the Digital zoom - mode by pressing the D.ZOOM button on the remote control.

To return to the previous screen size, select a screen size from the Screen Size Adjustment Menu or select an input source from the Input Source Selection Menu (see pages 33-35) again or adjust the screen size with the D.ZOOM button.

### ✓Note:

- The panning function may not operate properly if the stored Mode in the PC adjust Menu is used (p.39).
- The minimum compression ratio is limited depending on the input signal, when the Keystone function is working or when the custom is selected for the screen size.
- True and Digital zoom +/- cannot be selected when 480i, 575i, 480p or 575p is selected in the PC System Menu (p.36).
- Digital zoom +/- cannot be selected when True is selected.
- Digital zoom - cannot be operated when Custom is selected.

## Keystone

This function is used to adjust keystone distortion of the projected image. Use the Point ▲▼ buttons to choose the item you want to adjust.

### Standard

Adjusts the Horizontal/Vertical keystone distortion of the projected image.

### Corner correction

Adjusts the corner distortion of the projected image.

### Corner pattern

Choose a Corner pattern mode among Red, White, Blue, and Off.

### Store

Store ..... Keeps the keystone correction even when the AC power cord is unplugged.

Reset ..... Releases the keystone correction when the AC power cord is unplugged.

Press the KEYSTONE button on the remote control to switch the Standard (for Vertical/Horizontal) /Corner correction adjustment. The Standard or Corner correction adjustment dialog box appears. Use the Point ▲▼◀▶ buttons to correct the Standard or Corner distortion. (p.32)

## Ceiling

When this function is set to On, the picture will be top/bottom and left/right reversed. This function is used to project the image from a ceiling-mounted projector.

## Rear

When this function is set to On, the picture will be left/right reversed. This function is used to project the image from rear of the screen.

## Screen aspect

This function is used to scale the input source to fit the screen. Select one of the following aspect ratio which is suitable for your cable and computer. Select "Full" if you do not want to set aspect ratio.

Full .....Flexible aspect ratio

16:9 ..... 16:9 aspect ratio

16:10 .... 16:10 aspect ratio

4:3 .....4:3 aspect ratio

## Reset

This function returns all adjusted values to the factory default settings. Press the SELECT button at Reset to display a confirmation box. To reset, press the SELECT button at Yes.

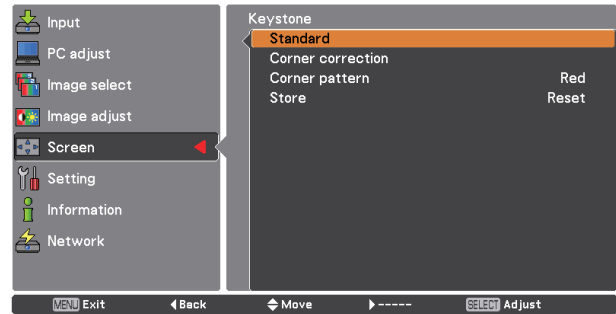

Ceiling

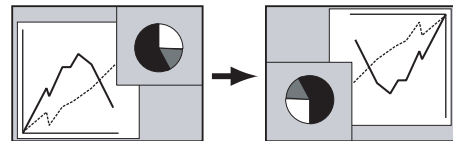

Rear

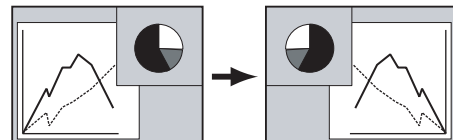

### ✓Note

- When the 16:9 function is selected, Wide(16:9) is not available in the PC and AV screen (pp.44, 52).

# Video Input

## Video System Selection

- 1 Press the MENU button to display the On-Screen Menu. Use the Point ▲▼ buttons to select Input and then press the Point ► or the SELECT button.
- 2 Use the Point ▲▼ buttons to select System and then press the Point ► or the SELECT button.
- 3 Use the Point ▲▼ buttons to select the desired system and then press the SELECT button.

### Video Jack or S-video Jack

#### Auto

The projector automatically detects an incoming video system, and adjusts itself to optimize its performance. When Video System is **PAL-M** or **PAL-N**, select the system manually.

#### PAL/SECAM/NTSC/NTSC4.43/PAL-M/PAL-N

If the projector cannot reproduce proper video image, select a specific broadcast signal format from among **PAL**, **SECAM**, **NTSC**, **NTSC 4.43**, **PAL-M**, and **PAL-N**.

### Y, Pb/Cb, Pr/Cr Jacks

#### Auto

The projector automatically detects an incoming video signal, and adjusts itself to optimize its performance. When the Video System is **1035i**, **1080i** or **1080p**, select the system manually.

#### Y, Pb/Cb, Pr/Cr SIGNAL FORMAT

If the projector cannot reproduce proper video image, select a specific component video signal format from among **480i**, **575i**, **480p**, **575p**, **720p**, **1035i**, **1080i**, and **1080p**.

#### ✓Note:

The AV System Menu cannot be selected when selecting RGB (Scart).

### AV System menu (Video or S-video)

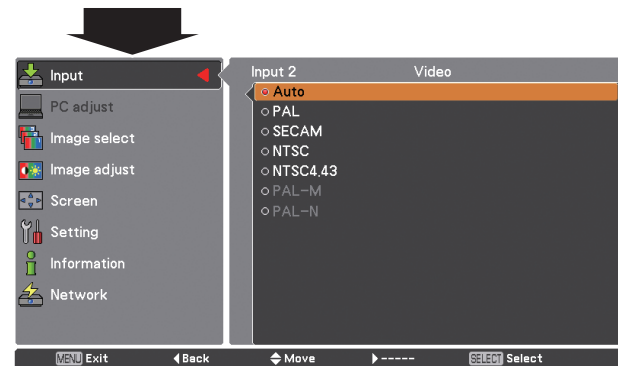
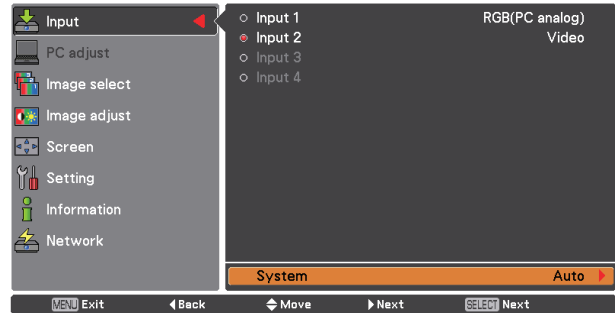

### AV System menu (Y, Pb/Cb, Pr/Cr)

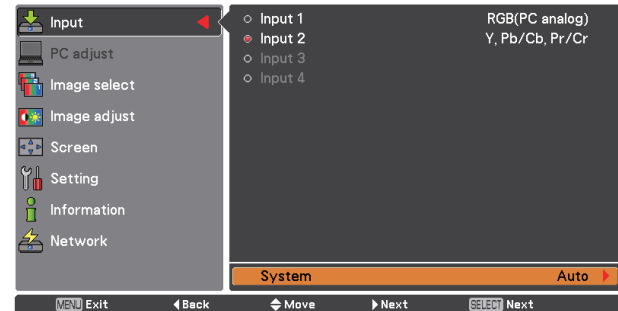

## Image Selection

### Menu Operation

- 1 Press the MENU button to display the On-Screen Menu. Use the Point ▲▼ buttons to select Image select and then press the Point ► or the SELECT button.
- 2 Use the Point ▲▼ buttons to select the desired item and then press the SELECT button.

#### Standard

Normal picture level preset on the projector.

#### Cinema

Picture level adjusted with fine tone.

#### Dynamic

For viewing pictures in a bright room.

#### Image 1–10

User preset picture adjustment in the Image adjust Menu. (p.51)

#### Image select menu

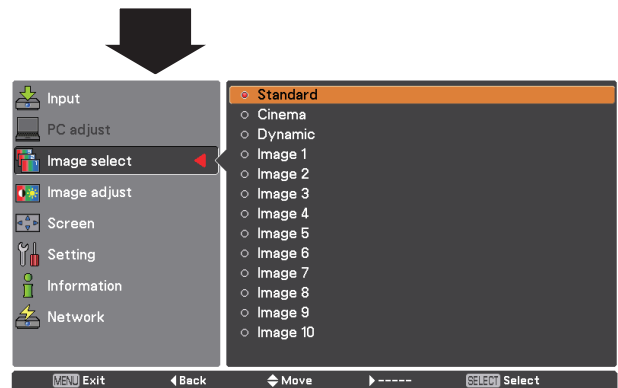

## Image Adjustment

- 1 Press the MENU button to display the On-Screen Menu. Use the Point ▲▼ buttons to select Image adjust and then press the Point ► or the SELECT button.
- 2 Use the Point ▲▼ buttons select the desired item and then press the SELECT button to display the adjustment dialog box. Use the Point ◀▶ buttons to adjust the setting value.

### Contrast

Press the Point ◀ button to decrease the contrast; press the Point ► button to increase the contrast (from 0 to 63).

### Brightness

Press the Point ◀ button to decrease the brightness; press the Point ► button to increase the brightness (from 0 to 63).

### Color

Press the Point ◀ button decrease the intensity of the color; press the Point ► button increase the intensity of the color (from 0 to 63).

### Tint

Press the Point ◀▶ buttons to adjust the tint value to get a proper color balance (from 0 to 63).

### Color management

Refer to pages 41 and 42.

### Color temp.

Use the Point ◀▶ buttons to select the desired Color temp. level (XLow, Low, Mid or High).

### White balance (Red)

Press the Point ◀ button to lighten red tone; press the Point ► button to deepen red tone (from 0 to 63).

### White balance (Green)

Press the Point ◀ button to lighten green tone; press the Point ► button to deepen green tone (from 0 to 63).

### White balance (Blue)

Press the Point ◀ button to lighten blue tone; press the Point ► button to deepen blue tone (from 0 to 63).

### Image adjust

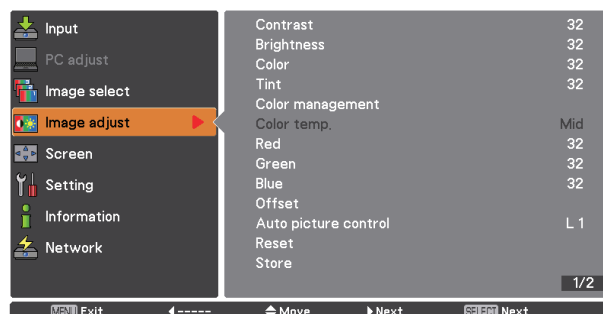

Selected Image mode

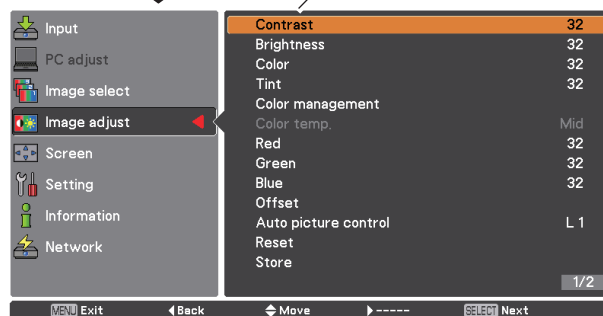

Use the Point ◀▶ buttons to adjust the setting value.



## Offset (Red/Green/Blue)

Press the Point ◀ button to lighten red/green/blue tone of the black level of an image; press the Point ▶ button to deepen red/green/blue tone of the black level of an image (from 0 to 63).

### ✓Note

- When White balance Red, Green or Blue is adjusted, the Color temp. level will change to Adj..
- Tint cannot be selected when the video system is **PAL**, **SECAM**, **PAL-M** or **PAL-N** (p.47).

## Auto picture control

Use the Point ◀▶ buttons to select the desired Auto picture control option (Off, L1 or L2).

Off . . . . Auto picture control OFF position.

L1 . . . . Auto picture control LEVEL 1 position.

L2 . . . . Auto picture control LEVEL 2 position.

## Advanced color\*

Use the Point ◀▶ buttons to select the advanced color mode.

Off . . . . Advanced color mode is "Off".

Auto . . . . Advanced color according to the type of image.

\*This function controls the operation of the Color Control Device, which independently and automatically regulates the amount of yellow light passing through the LCD panel, to accurately reproduce both image color and image brightness. Normally leave Auto (default setting).

### ✓Note:

- White balance may change depending on the image.

## Sharpness

Press the Point ◀ button to decrease the sharpness of the image; press the Point ▶ button to increase the sharpness of the image (from 0 to 31).

## Gamma

Use the Point ◀▶ buttons to adjust the gamma value to obtain a better balance of contrast (from 0 to 15).



## Noise reduction

Noise interference on the screen can be reduced. Press the Point ◀▶ buttons to change the noise reduction mode.

Off ..... Noise reduction mode is Off.

On..... Noise reduction mode is On.

## Progressive

An interlaced video signal can be displayed in progressive mode. Press the Point ◀▶ buttons to change the progressive scan mode.

Off ..... Progressive scan mode is Off.

On..... Progressive scan mode is On.

Film..... For watching a film. With this function, the projector reproduces pictures faithful to the original film quality.

## Reset

To reset the adjusted data, select Reset and press the SELECT button. A confirmation box appears and then select Yes. All adjustments will return to their previous figures.

## Store

To store the adjusted data, select Store and press the Point ▶ or the SELECT button. Use the Point ▲▼ buttons to select one from Images 1 to 10 and press the SELECT button.

A confirmation box appears and then select Yes. Stored data can be called up by selecting an Image (1-10) in the Image Mode Selection on page 48.

### ✓Note

- Progressive cannot be selected when 480p, 575p, 720p, or 1080p is selected (p.47).
- Noise reduction cannot be selected with the computer input and when the video signal format is 1080p. (p.47).

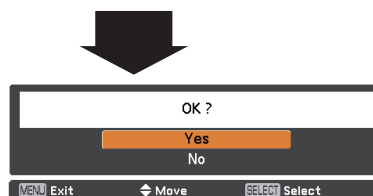

A confirmation box appears and then select Yes.

## Screen Size Adjustment

- 1 Press the MENU button to display the on-screen Menu. Use the Point ▲▼ buttons to select Screen and then press the Point ► or the SELECT button
- 2 Use the Point ▲▼ buttons to select the desired item and then press the SELECT button.

### Normal

Provides the image within a screen size keeping its original aspect ratio.

### Full

Provides the image to fit full screen size.

### Wide (16:9)

Provides the image at the 16:9 wide screen ratio.

### Zoom

Scales the image proportionally to fit the entire screen. Either side of image may go over the screen.

### Natural wide

Expands the right and left side of images naturally without changing the center areas.

### Custom

Provides the last stored aspect screen image.

### Custom adj.

Adjusts the screen scale and position manually with this function.

Press the Point ► button at Custom adj. and the Custom adjustment menu is displayed on the screen, you can use the Point ▲▼ buttons to choose the item you want to adjust.

Scale H/V ..... Adjusts the Horizontal/Vertical screen scale.

H&V ..... When set to On, the aspect ratio is fixed. Scale V appears dimmed and becomes unavailable. Adjust Scale H, then the screen scale is automatically modified based on the aspect ratio.

Position H/V..... Adjusts the Horizontal/Vertical screen position.

Common..... Saves the adjusted scale or position to all the inputs. Press the SELECT button at Common to display a confirmation box. To save the scale or position, press the SELECT button at "Yes", When Custom is selected, the saved scale or position is used.

Reset ..... Resets the all adjusted values. Press the SELECT button at Reset to display a confirmation box. To reset, press the SELECT button at Yes.

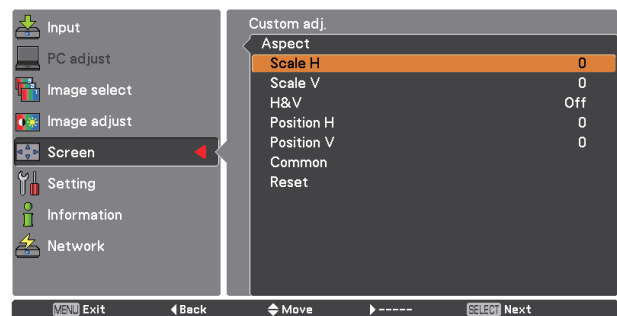

### ✓Note:

- When no signal is detected, Normal is set automatically and the Aspect dialog box disappears.
- The adjustable range for Scale H/V and Position H/V are limited depending on the input signal.
- Natural wide cannot be selected when 720p, 1035i, 1080i or 1080p is selected on AV System Menu (p.47).



## Keystone

This function is used to adjust keystone distortion of the projected image. Use the Point ▲▼ buttons to choose the item you want to adjust.

### Standard

Adjusts the Horizontal/Vertical keystone distortion of the projected image.

### Corner correction

Adjusts the corner distortion of the projected image.

### Corner pattern

Choose a Corner pattern mode among Red, White, Blue, and Off.

### Store

Store ..... Keeps the keystone correction even when the AC power cord is unplugged.

Reset ..... Releases the keystone correction when the AC power cord is unplugged.

Press the KEYSTONE button on the remote control to switch the Standard (for Vertical/Horizontal) /Corner correction adjustment. The Standard or Corner correction adjustment dialog box appears. Use the Point ▲▼◀▶ buttons to correct the Standard or Corner distortion. (p.32)

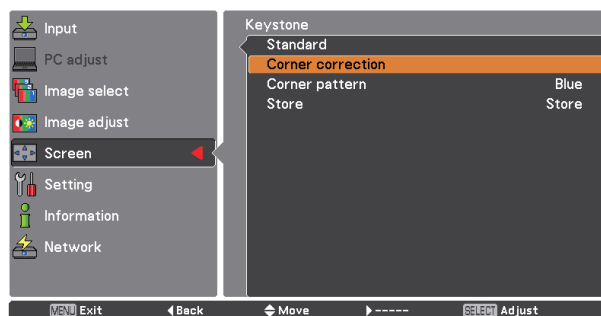

## Ceiling

When this function is set to On, the picture will be top/bottom and left/right reversed. This function is used to project the image from a ceiling-mounted projector.

## Rear

When this function is set to On, the picture will be left/right reversed. This function is used to project the image from rear of the screen.

## Screen aspect

This function is used to scale the input source to fit the screen. Select one of the following aspect ratio which is suitable for your cable and computer. Select "Full" if you do not want to set aspect ratio.

- Full .....Flexible aspect ratio
- 16:9 ..... 16:9 aspect ratio
- 16:10 .... 16:10 aspect ratio
- 4:3 .....4:3 aspect ratio

## Reset

This function returns all adjusted values to the factory default settings. Press the SELECT button at Reset to display a confirmation box. To reset, press the SELECT button at "Yes."

### Ceiling

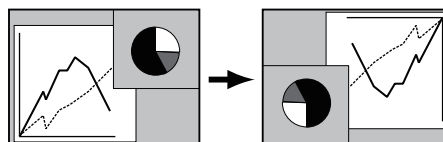

### Rear

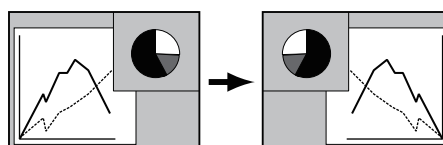

### ✓Note:

- Natural wide cannot be selected when 720p, 1035i, 1080i or 1080p is selected on AV System Menu (p.47).
- When the 16:9 function is selected, Wide(16:9) is not available in the PC and AV screen (pp.44, 52).
- When the 4:3 function is selected, Natural wide is not available in the AV screen (p.52).

# Settings

## Settings

This projector has a Setting menu that allows you to set up the other various functions described below.

- 1 Press the MENU button to display the On-Screen Menu. Press the Point ▲▼ buttons to select Setting and press the Point ► or the SELECT button to access the submenu items.
- 2 Use the Point ▲▼ buttons to select the desired item and then press the Point ► or the SELECT button to access the selected item.
- 3 Use the Point ▲▼ buttons to select the desired item and then press the SELECT button.

### Language

The language used in the On-Screen Menu is available in English, German, French, Italian, Spanish, Portuguese, Dutch, Swedish, Russian, Chinese, Korean and Japanese.

### Menu

This function is used to adjust the On-Screen Menu display position. Press the SELECT button and the adjustment screen appears (arrows appear). Use the Point ▲▼◀▶ buttons to adjust the position. After making the adjustment, press the SELECT button to return to the Menu screen. To resize the menu, select Normal (for normal size) or Double (for double size). Even after selecting Double, the Startup Logo size doesn't change.

### Display

This function decides whether to display On-Screen Displays.

- On ..... Shows all the On-Screen displays. Use this function when you want to project images after the lamp becomes bright enough. The factory default setting is in this option.
- Countdown Off..... Shows the input image instead of the countdown when turning on the projector. Use this function when you want to project the image as early as possible even when the lamp is not bright enough.
- Off ..... Hides the On-Screen Displays, but there are exceptions:
  - On-Screen Menu
  - The "Power off?" message (p.25)
  - Time counter displayed when the Power Management and/or P-Timer function works
  - Orange arrows for repositioning a menu .
  - The "Please wait ..." message (except for the filter warning message)
  - Warning messages displayed when configuring Video delay control settings and pressing a button unavailable in Picture in Picture mode.
  - In Picture in/by Picture mode, warning frame (red) displayed when using the unavailable combination of Input buttons on the remote control or inputting unacceptable signals.
  - White Arrows in panning mode (p.44)
  - Corner patterns (p.32)

### Language

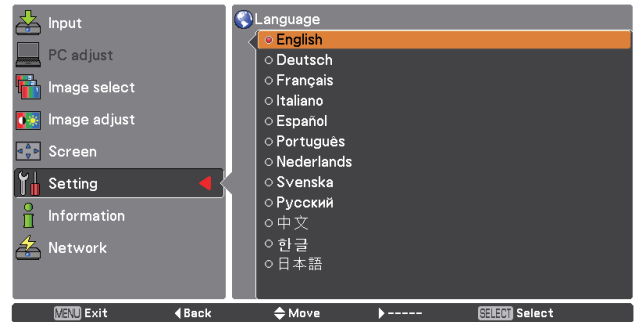
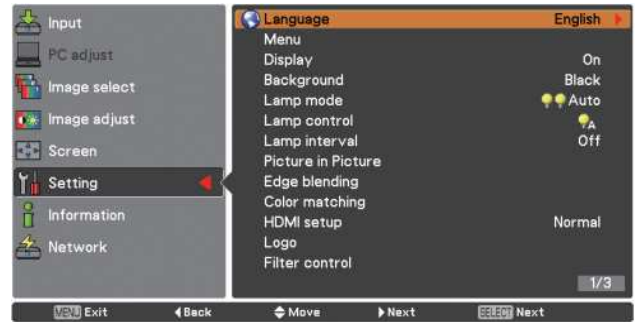

### Menu

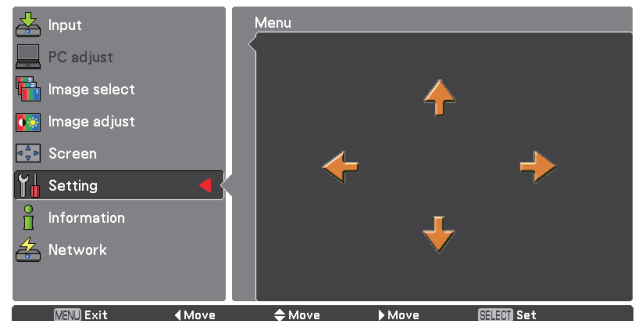
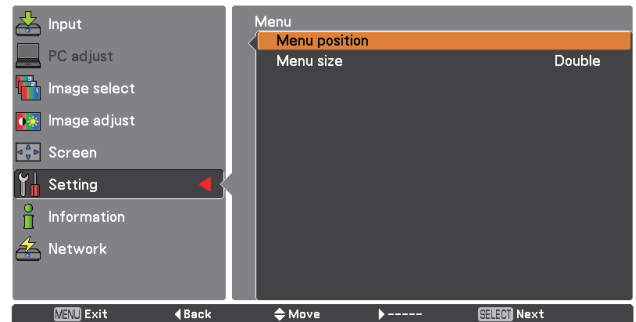

## Background

Select the background color or image when no input signal is detected. Press the Point ▲▼ buttons to switch between each option.

- Blue ..... Projects a blue background.
- User ..... Projects a captured image.
- Black ..... Projects a black background.

## Lamp mode

Allows you to select a lamp mode.

- 4-Lamps..... Uses four lamps.
- 3-Lamps..... Uses three lamps.
- 2-Lamps..... Uses two lamps.

**Auto:** In 3-lamps or 2-lamps mode, automatically and preferentially uses a lamp with shorter cumulated lighting time.

**Constant mode** .... Automatically switches between the lamp modes, or performs digital processings like modulation of the light from the lamps to keep the target brightness by switching the lamp modes.

**Target:** Allows you to specify the desired target brightness (up to 1024). Follow these steps below: 1) Select Target and press the SELECT button. 2) Set Target brightness by using the Point ▲▼ buttons and press the SELECT button. 3) Select Yes in the confirmation dialog box to activate Constant mode.

**Current:** Displays current brightness. If luminance level of lamp does not reach the target brightness, the parameter is displayed in red.

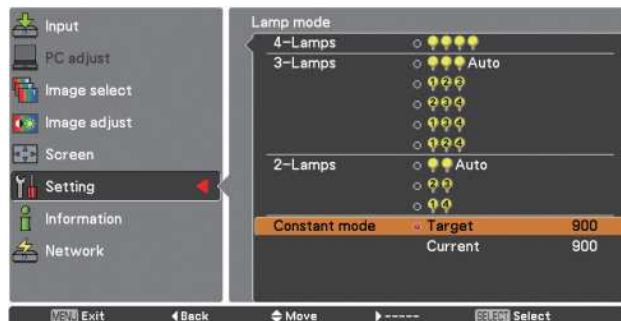
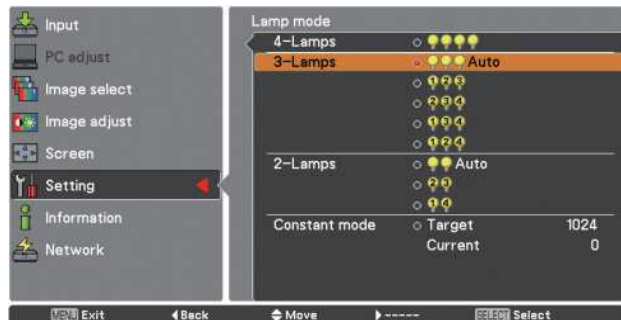

### ✓Note

- In Constant mode, some Setting menu items are not available.
- You can use the Real Color Manager Pro CD-ROM (supplied) except in Constant mode.
- In this example, the Target value is specified to 820, but as it is not absolute luminance, you can specify a value in the 0 - 1024 range.

## Lamp control

### Lamp control

This function allows you to change among the lamp modes: Auto, Normal, Eco 1, and Eco 2

- Auto . . . . Brightness according to the input signal.
- Normal . . . Normal brightness.
- Eco 1. . . . Lowers brightness and decrease of fan speed. Lower brightness reduces the lamp power consumption and extends the lamp life.
- Eco 2. . . . Lowers brightness and increase of fan speed. Lower brightness reduces the lamp power consumption and extends the lamp life. It is recommended to use Eco 2 when using the projector continuously over a long period of time. The fan noise becomes louder in Eco 2 than in Eco 1. Select the suitable mode for the used environment.

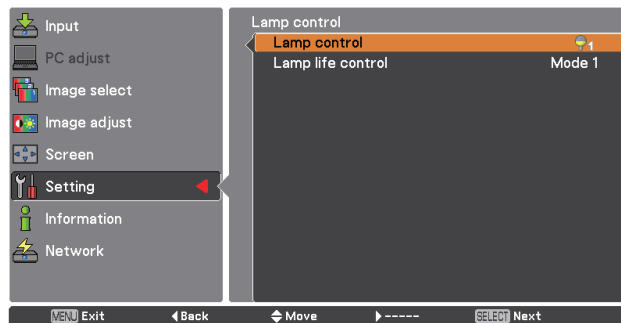

### ✓Note

The fan noise becomes louder in Eco 2 than in Eco 1. Select the suitable mode for the used environment.

## Lamp life control

Select the lamp operation when the total lighting time of a lamp exceeds the recommended total hours of use.

Mode 1 ..... A lamp can be turned on even after exceeding the recommended total hours of use.

Mode 2 ..... A lamp can be turned on even after exceeding the recommended total hours of use. But the projector turns off automatically after 3 minutes.

### ✓Note

- Lamp mode cannot be changed for a while after turning on the projector. Lamp needs some time to stabilize after the power is turned on. Stored lamp mode will be active after the lamp is stabilized.
- If Mode 2 has been selected and the projection lamp exceeds the recommended total hours of use, the replacement icon will be displayed at the time of power-on. Then the projector will turn off after 3 minutes.

## Lamp interval

In 1-lamp mode, this function allows you to specify the timing of switching between the lamps.

**Off** ..... Turns off the lamp switching function  
**XXXXH** ..... When the cumulated lighting time of the lamp reaches the specified time, automatically chooses the lamp of which total operation time is shortest. (Options: 24H, 200H, 500H, 1000H, 2000H)

### ✓Note

*The projector cannot switch between the lamps at exactly the same time as you specified. The time specified here is approximate.*

## Picture in Picture

This function is used to project two images simultaneously by placing a separate small sub screen within or next to the main screen.

Use the Point ▲▼ buttons to select Picture in Picture and then press the SELECT button to display a dialog box. You can also display the dialog box by pressing and holding the PIP button on the remote control for more than 3 seconds.

( In P in P, the larger picture is main picture, and the smaller one is sub picture; in P by P, the left picture is main picture, and the right one is sub picture.)

## Picture in Picture

Shows the selected mode (Off/User 1-5) and its status (Stored /Free/ Adj.). User 1 and User 2 have stored default values. See page 31 for details.

## Mode

**P in P:** Provide the images of Main picture and Sub picture at the ratio of Screen aspect in the Screen Menu.

**P by P:** Provide the images of Main picture and Sub picture at the ratio of 4:3.

## Main picture / Sub picture

Input .....Select an input from Input 1-4.

Source ..Select an input source. The display varies depending on the selected input.

Size .....Select the display size. Main picture can be changed between 10 and 100%, and Sub picture can be changed between 10 to 50% in increments of 10%. When P by P is selected in Mode, the projection size is fixed to 50%.

Position..Press the SELECT button at Position and the display position setting screen appears.

Use the Point ▲▼◀▶ buttons to adjust the display position of active frame indicated in white. The frame will disappear after 10 seconds or when the SELECT button is pressed.

### Selecting the Main picture or Sub picture

During Picture in Picture mode, and being undisplayed On Screen Menu, press the SELECT button to select Main or Sub picture. (A red frame will be displayed on the selected picture.)

### Switching Input and Source

When selecting Main picture or Sub picture, input and source can be set by pressing the INPUT button on the side control or INPUT 1/2/3/4 button on the remote control. Operation on the On Screen Menu is not necessary.

## Frame lock

Set the Frame Lock to Main picture or Sub picture.

## Store

Store the adjusted data in the User 1-5. Use the Point ▲▼ buttons to select Store and press the SELECT button to show the Where to store? dialog box. Move the highlight to one of the mode (User1 - 5) which you want to store and press the SELECT button. Then the confirmation box appears. To store adjusted data, select Yes.

## Reset

Press the SELECT button at Reset to display a confirmation box. To reset, press the SELECT button at Yes.

## Mode free

Delete the data stored in the Mode and return to Free. Use the Point ▲▼ buttons to select Mode free and press the SELECT button to show the Where to free? dialog box. Move the highlight to one of the mode (User1 - 5) which you want to delete and press the SELECT button. Then the confirmation box appears. To delete, select Yes.

## Back

Returns to the Picture in Picture menu.

Status (Stored /Free/ Adj.) of the selected mode

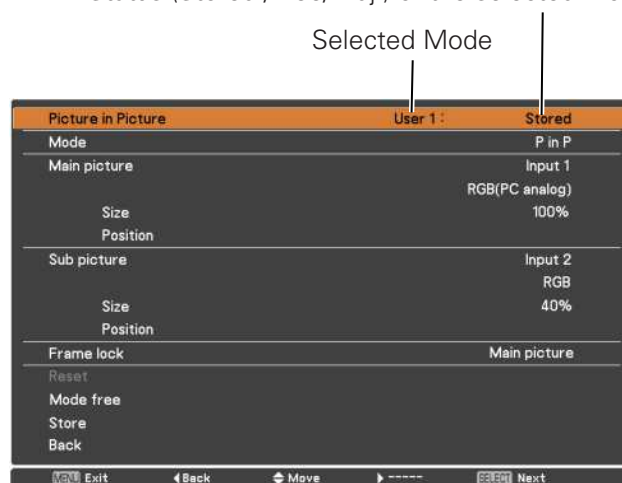

### ✓Note

- P by P is not available when the 4:3 function is selected in Screen aspect (p.46, 53).
- When P by P is selected in every User 1-5 and the 4:3 function is selected in Screen aspect, PIP button on the remote control is not available. To set Picture in Picture, select Full, 16:10, or 16:9 in Screen aspect (p.46, 53).

### Display position setting screen

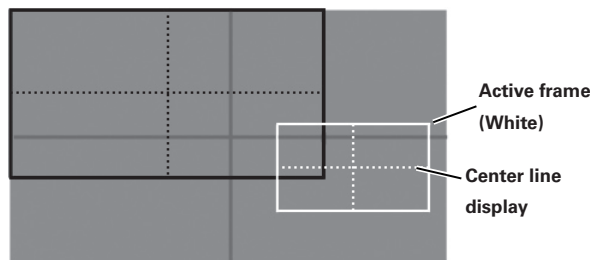

### ✓Note

- The Picture in Picture function is not available depending on the input signals and the selected input terminals. Refer to List of Picture in Picture for details. (p.97)
- When the input signal(s) is/are incompatible, X mark will be displayed on the Main/Sub picture.



## Edge blending

This function allows multiple projector images to be seamlessly overlapped.

Use the Point ▲▼ buttons to select Edge blending and then press the SELECT button to display a dialog box. Use the Point ▲▼◀▶ buttons to adjust the setting value.

- On/Off . . . . . Set to On to activate the Edge blending function.
- Start. . . . . The point at which edge blending starts.  
The edges of a green frame around an image shift in accordance with the values specified here. Specify a value in the 0 - 1024 range for Left and Right and a value in the 0 - 540 for Top and Bottom.
- Width. . . . . Adjusts the width of correction.  
Right/Left: Set the width. (from 0 to 1024).  
Top/Bottom: Set the width. (from 0 to 540).
- Black level . . . . Adjusts the black level of projected image.  
All: The values of R, G, and B will be changed simultaneously.  
R/G/B: Adjusts the value (up to ± 127).
- Test pattern . . . . Select On to display a suitable pattern (white: 50%).
- Menu off . . . . . Closes the menu and hides all edge lines (in green, red, and gray) temporarily.
- Reset. . . . . Select Reset and press the SELECT button. Then Return to factory default of Edge Blending? message appears. To reset, press the SELECT button at [Yes].
- Back. . . . . Hides the Edge blending setting menu and returns to the Setting menu.



### ✓ Note:

- The overlapping areas might become uneven depending on the images. In such a case, it is recommended to decrease the contrast of the images in the Image Adjust Menu.
- See "How to adjust multiple screens" on pages 70, 71 for further information.

## Color matching

When displaying multiple screens, eliminates the difference in color between the images that are projected from the projectors.

When multiple sets are used simultaneously, this projector allows the user to correct the difference of colors among the sets.

Use the Point ▲▼ buttons to select Color matching and then press the SELECT button to display a dialog box. Use the Point ▲▼◀▶ buttons to adjust the setting value.

- Color matching. . . . . Set to 'On' to activate the Color matching function. When the color matching is set to Off, all items except for Advanced color matching and Back are displayed in grayout and cannot be adjusted.
- Color adjustment . . . . Adjusts the color setting of Red/Green/Blue/White. The chromatic coordinate (X, Y) of Red, Green, Blue, and White can be adjusted respectively. The adjustable range is from 0.000 to 1.000.
- Auto test pattern . . . . Select On to display a suitable pattern when setting items.

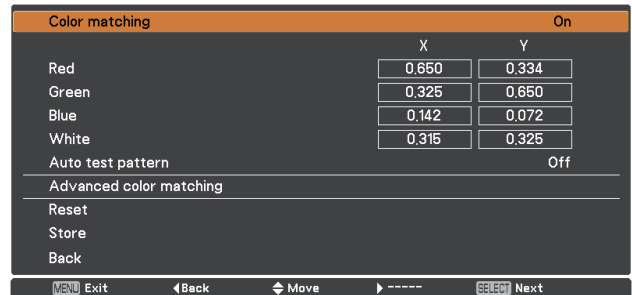



- Advanced color matching . . . . . Select Advanced color matching and press the SELECT button for more detailed settings. Another setting screen will appear.
- Reset . . . . . Select Reset and press the SELECT button. Then the confirmation message appears. Press the SELECT button at Yes to reset to the previously stored values.
- Store . . . . . Select Store and press the SELECT button to display the Confirmation box. To store adjusted data, select Yes.

## Advanced color matching

- Advanced color matching: Press the POINT ▲▼ buttons to switch between "On" and "Off". Selecting On displays the values which link to the Color Match values.
- Measured Information: When selecting "Measured Information," the window shown right appears. Current image level is shown. To go back to the "Advanced color matting" window, press any key.
- Measured: Displays the measured values of Red, Green, and Blue.
- Target: Adjusts the chromatic coordinate (X,Y) and the gain value (g) of Red, Green, Blue, Cyan, Magenta, Yellow, and White. Use the Point ▲▼ buttons to move the red frame pointer to an item of which you want to adjust the value and then press the SELECT button. Use the Point ▲▼ buttons to adjust the value. To move to the next digit, use the Point ▲▼ buttons. Press the SELECT button to set the value.
- Auto test pattern: Select On to display a suitable pattern when setting items.
- Menu off: Close the menu temporarily.
- Factory default: Select Factory default and press the SELECT button. Then Return to factory default of Color matching? message appears. To reset the selected Measured value and Target value, select Yes. Then, the confirmation box appears. Press the SELECT button at Yes again.
- Reset: Select Reset and press the SELECT button. Then the confirmation message appears. Press the SELECT button at Yes. to reset to the previously stored values.
- Store: Select Store and press the SELECT button. Then the Confirmation box appears. To store adjusted data, select Yes.
- Test pattern: Displays the "Test pattern" menu.
- Back: Cancels the "Advanced color matching" menu display.

## Advanced color matching

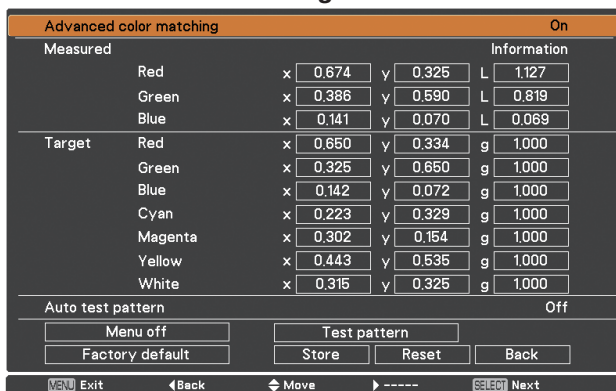

## Measured information

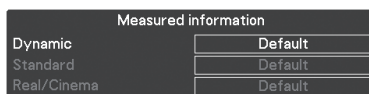

## Test pattern

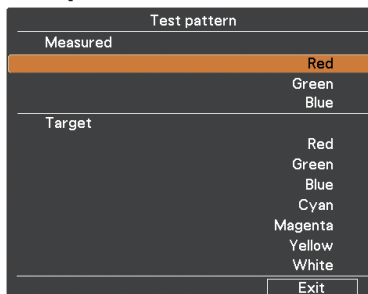

## HDMI setup

Select Normal or Enhanced according to the output signal of video equipment. Press the Point ▲▼ buttons to switch between each option.

- Normal . . . . . When the output of video equipment is set to "STANDARD."
- Enhanced . . . . . When the output of video equipment is set to "ENHANCED."

## Logo (Logo and Logo PIN code lock settings)

This function allows you to customize the screen logo with Logo select, Capture, Logo PIN code lock and Logo PIN code change functions.

### Logo select

**✓Note**

*When On is selected in the Logo PIN code lock function, Logo select, Capture and Logo PIN code change cannot be selected.*

This function decides on the starting-up display from among following options.

- User ..... Shows the image you captured.
- Default ..... Shows the factory-set logo.
- Off ..... Shows the countdown display only.

### Capture

This function enables you to capture an image being projected to use it for a starting-up display or interval of presentations. Select Capture and press the SELECT button. A confirmation box appears and select Yes to capture the projected image. After capturing the projected image, go to the Logo select function and set it to User. Then the captured image will be displayed the next time you turn on the projector. To cancel the capture function, select Yes in the "Quit?" confirmation box.

**✓Note**

- Before capturing an image, select Standard in the Image Select Menu to capture a proper image (pp.40, 48).
- When capturing the image that has been adjusted by the Keystone function, the adjusted data is automatically reset and the projector captures an image without keystone correction.
- When Logo PIN code lock is set to On, Capture cannot be selected.
- When starting to capture a new image, the previously stored image is cleared even if you cancel the capturing.
- When there is no captured image or it is interrupted while capturing an image, User can not be selected, you can only switch between Default and Off.
- Capture function is not available when the Picture in Picture function is set to User1-5.
- When changing a PIN code, the new PIN code numbers don't appear as asteriskmarks.

**✓Note:**

- The names for the output setting of video equipment vary from equipment to equipment. For details, refer to the manual of video equipment.

### Logo select

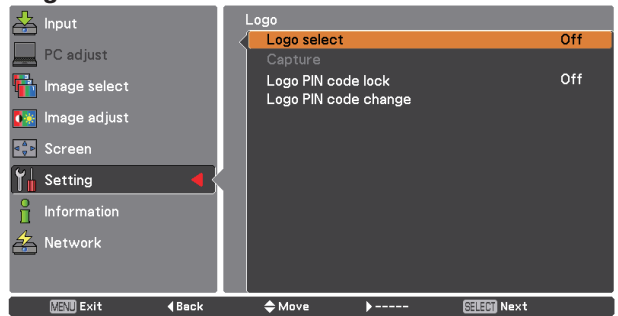

### Capture

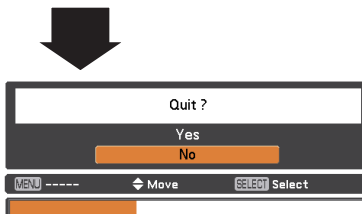
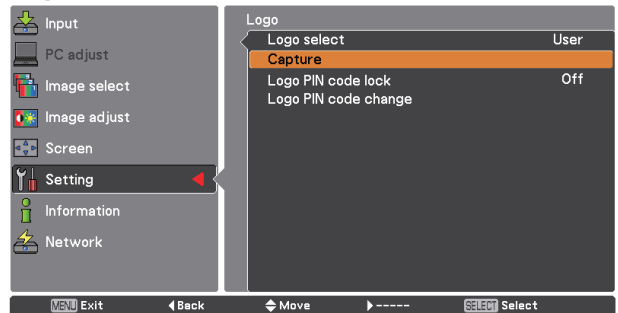



Use the Point ▲▼ buttons on the side control or Number buttons on the remote control to enter a number.

### Logo PIN code lock

This function prevents an unauthorized person from changing the screen logo.

- Off ..... The screen logo can be changed freely from the Logo Menu (p.60).
- On ..... The screen logo cannot be changed without a Logo PIN code.

If you want to change the Logo PIN code lock setting, press the SELECT button and the Logo PIN code dialog box appears. Enter a Logo PIN code by following the steps below. The initial Logo PIN code is set to "4321" at the factory.

**To change the Logo PIN code lock setting, follow these steps:**

#### 1. Enter a Logo PIN code

Use the Point ▲▼ buttons on the side control or Number buttons on the remote control unit to enter a number.

##### When using side control

Use the Point ▲▼ buttons on the side control to select a number. Press the Point ► button to fix the number and move the red frame pointer to the next box. The number changes to "\*." Repeat this step to complete entering a four-digit number. After entering the four-digit number, move the pointer to "Set." Press the SELECT button so that you can change the Logo PIN code lock setting.

##### When using remote control

Press the Number buttons on the remote control unit to enter a number (p.16). When you complete entering a four-digit number, the pointer moves to "Set." Press the SELECT button so that you can change the Logo PIN code lock setting.

If you fixed an incorrect number, use the Point ◀ button to move the pointer to the number you want to correct, and then enter the correct number.

If you entered an incorrect PIN code, "Logo PIN code" and the number (\*\*\*\*) will turn red for a moment. Enter the correct PIN code all over again.

#### 2. Change the Logo PIN code lock setting

Use the Point ▲▼ buttons to switch On or Off, and then press the SELECT button to close the dialog box.

#### 3. Change Logo PIN code

Logo PIN code can be changed to your desired four-digit number. Press the SELECT button to select Logo PIN code change. Current logo PIN code dialog box appears, use the Point ▲▼ buttons to enter the correct code. The New Logo PIN code input dialog box appears. Set a new Logo PIN code, confirmation box appears, choose Yes to set the new Logo PIN code.

#### To enter a Logo PIN code lock

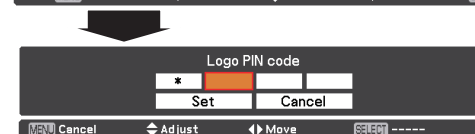
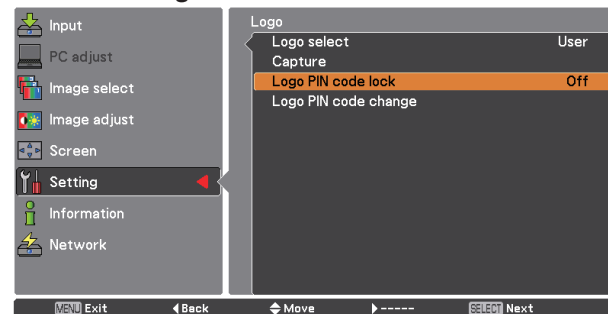

#### To change the Logo PIN code

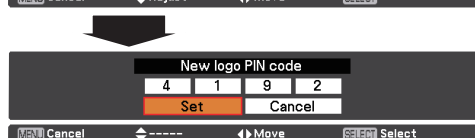
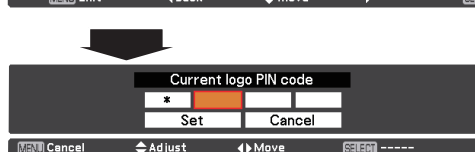
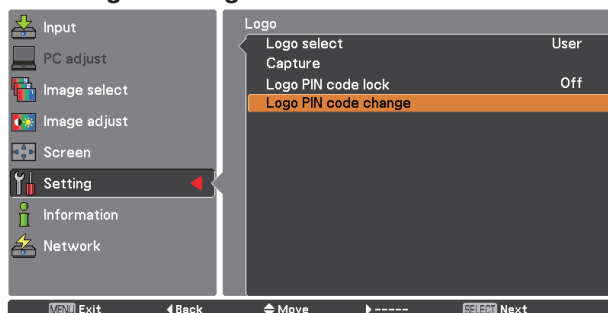

# Settings

## Filter control

This function allows you to schedule a filter cleaning task. Select Filter control from the Setting menu and Yes in the confirmation box, or press the FILTER button on the remote control for approximately 5 seconds.

### ✓Note

- The filter cleaning icon and “Cleaning is scheduled” message disappear 4 seconds after a filter cleaning task was scheduled.
- If a filter cleaning task is discontinued during the filter cleaning process, the filter cleaning unit resumes cleaning where it left off when the projector is turned on again.
- A filter cleaning task cannot be scheduled while filter cleaning is in progress.
- Normally, the filter cleaning unit automatically starts cleaning the mesh filter either while cooling down the projector after the power was turned off or after restarting the projector.
- The Filter control function is not available when you use an optional smoke resistant filter.

## Fan control

Choose the running speed of cooling fans from the following options.

- Normal..... Operates in this mode under normal conditions.
- Max..... Use this mode when you want to increase the cooling effect when operating the projector in high ambient temperature environment. Fan noise is louder than Normal.

## Remote control

The eight different remote control codes (Code 1-Code 8) are assigned to the projector; the factory-set, initial code (Code 1) and the other seven codes (Code 2 to Code 8). The same code should be set on both the projector and the remote control. For example, operating the projector in Code 7, the remote control code also must be switched to Code 7.

### To change the code for the projector:

Select a remote control code in this Setting Menu.

### To change the code for the remote control:

Press and hold the MENU button and a number button (1-8) on the remote control for more than five seconds to switch between the codes. See “Remote Control Codes” on page 16.

### ✓Note

- When different codes are set on the projector and on the remote control, any operation cannot be made. In that case, switch the code on the remote control to fit the code on the projector.
- If the batteries are removed from the remote control for a long period of time, the remote control code will be reset.

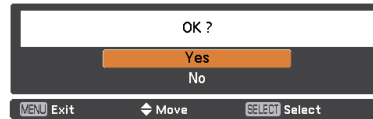
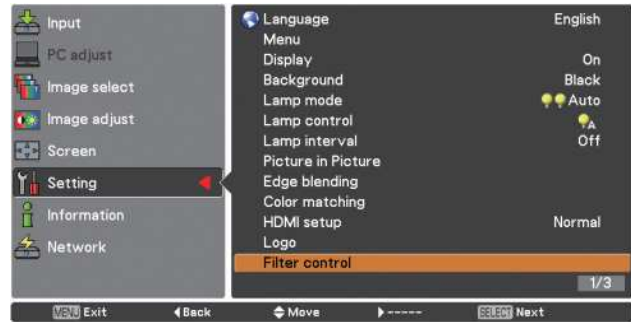

A confirmation box appears and then select Yes.



The filter cleaning icon and “Cleaning is scheduled” message appear.

## RC sensor

Select a location of the infrared remote receiver of the remote control. See “Remote Control Receivers and Operating Range” on page 15 for details.

- All ..... Activates all of the receivers
- Front & Top ..... Activates both the front and top receivers
- Top & Back ..... Activates both the top and back receivers
- Front & Back..... Activates both the front and back receivers
- Front..... Activates only the front receiver.
- Top..... Activates only the top receiver
- Back ..... Activates only the back receiver.

## Power management

For reducing power consumption as well as maintaining the lamp life, the Power management function turns off the projection lamp when the projector is not operated for a certain period.

Select one of the following options:

- Ready..... When the lamp has been fully cooled down, the POWER indicator changes to green blinking. In this condition, the projection lamp will be turned on if the input signal is reconnected or any button on the side control or remote control is pressed.
- Shut down ..... When the lamp has been fully cooled down, the power will be turned off.
- Off ..... Power management function is off.
- Timer ..... If the input signal is interrupted and no button is pressed for more than 30 seconds, the timer display with No signal appears. It starts the countdown until the lamp is turned off. Use the Point ▲▼ buttons to set the Timer(1~30Min).

### ✓Note

- Factory default is Ready: 5 Min.
- When the shutter is closed while the Power management function is working, the Power management function is released.

## Direct on

When this function is set to On, the projector will be automatically turned on just by connecting the AC power cord to the wall outlet.

### ✓Note

- Be sure to turn off the projector properly (see “Turning Off the Projector” on page 25). If the projector is turned off in the incorrect sequence, the “Direct on” function does not work properly.

### ✓Note

- When placing the projector in the horizontal position, as fluorescent light may negatively affect the remote control signals, it is recommended to select either “Back” or “Front” to prevent the receiver on top of the projector from picking up the signals from the remote control.



Timer left before Lamp is off.

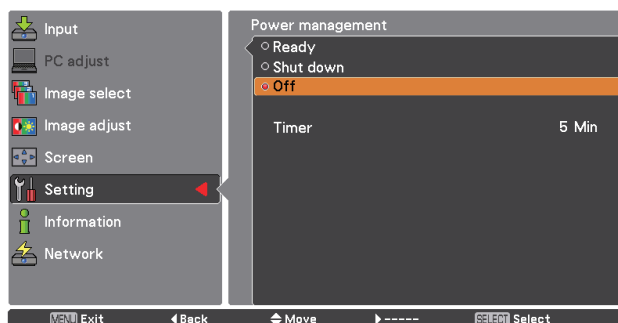



## Security (Key lock and PIN code lock)

This function allows you to use the Key lock and PIN code lock function to set the security for the projector operation.

### Key lock

This function locks the side control and remote control buttons to prevent operation by unauthorized persons.



..... Unlocked.



..... Locks the operation of the side control.

To unlock, use the remote control



..... Locks the operation of the remote control.

To unlock, use the side control.

If the side control accidentally becomes locked and you do not have the remote control nearby or there is something wrong with your remote control, contact the dealer where you purchased the projector or the service center.

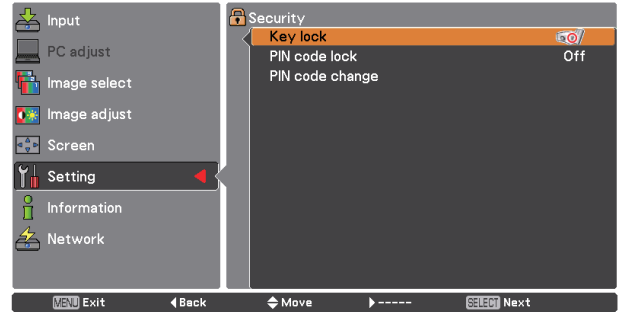

### PIN code lock

This function prevents the projector from being operated by unauthorized persons and provides the following setting options for security.

Off ..... Unlocked.

On 1 ..... Enter the PIN code every time turning on the projector.

On 2 ..... Enter the PIN code to operate the projector once the power cord is disconnected; as long as the AC power cord is connected, the projector can be operated without a PIN code.

Whenever you change the PIN code lock setting or the PIN code (the four-digit number), you are required to enter the PIN code. The "1234" is set as the initial PIN code at the factory.

If you want to change the PIN code lock setting, Press the SELECT button and the PIN code dialog box appears.

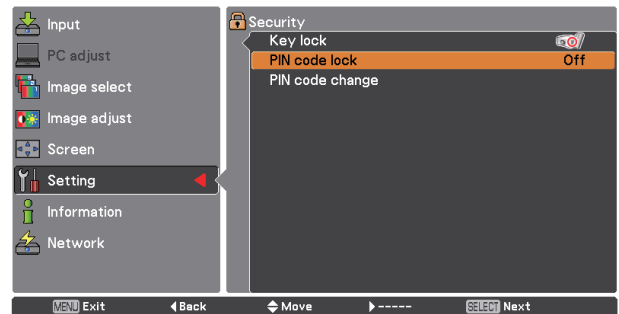

## To enter a PIN code

### When using side control

Use the Point ▲▼ buttons on the side control to select a number. Press the Point ► button to fix the number and move the red frame pointer to the next box. The number changes to “\*.” Repeat this step to complete entering a four-digit number. After entering the four-digit number, move the pointer to “Set.” Press the SELECT button so that you can change the PIN code lock setting.

### When using remote control

Press the Number buttons on the remote control to enter a number (p.16). When you complete entering a four-digit number, the pointer moves to “Set.” Press the SELECT button so that you can change the PIN code lock setting.

If you fixed an incorrect number, use the Point ◀ button to move the pointer to the number you want to correct, and then enter the correct number.

If you entered an incorrect PIN code, “PIN code” and the number (\*\*\*\*) will turn red for a moment. Enter the correct PIN code all over again.

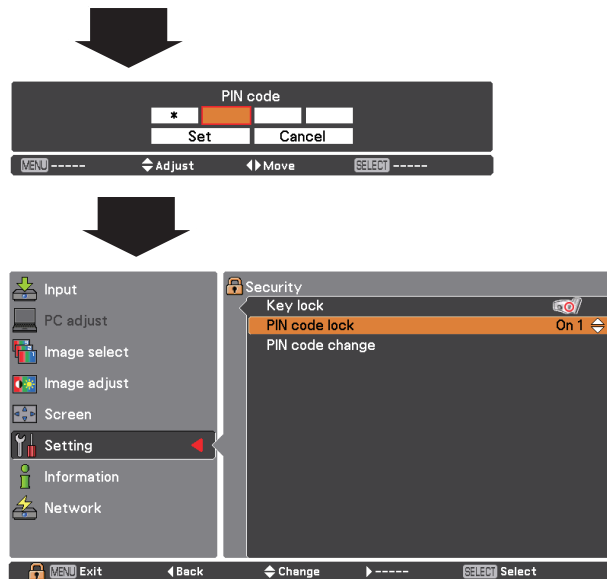

When the projector is locked with a PIN code, the PIN code lock symbol appears in the Guide.

## To change the PIN code lock setting

Use the Point ▲▼ buttons to select OFF, On 1 or On 2. Press the SELECT button to close the dialog box.

## To change PIN code

The PIN code can be changed to your desired four-digit number. Press the Point ▼ button to select PIN code change and press the SELECT button. The Current PIN code dialog box appears. Use the Point ▲▼ buttons or the Number buttons on the remote control to set the current PIN code. The New PIN code dialog box appears. Set a new PIN code, the confirmation box appears, and choose Yes to set the new PIN code.

### CAUTION:

**WHEN YOU HAVE CHANGED THE PIN CODE, WRITE DOWN THE NEW PIN CODE IN COLUMN OF THE PIN CODE NO. MEMO ON PAGE 95, AND KEEP IT SECURELY. IF YOU FORGET YOUR PIN CODE, THE PROJECTOR CAN NO LONGER BE STARTED.**

## To change the PIN code

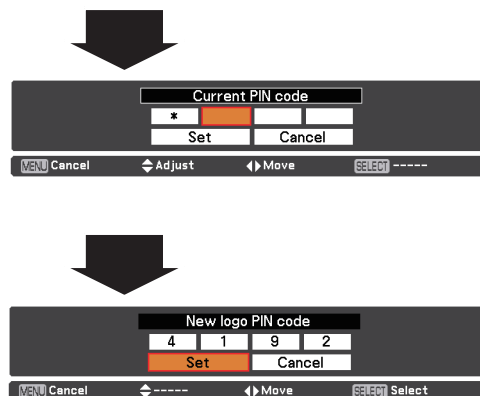

## Projector ID

This feature allows users to set serial communication configuration (Projector ID) when several projectors are connected via the RS-232C terminal (serial port) of the projector.

Use the Point ▲▼ buttons to adjust the Projector ID.  
Projector ID ... 1 - 999. (Factory default setting : Projector ID 1)

## Shutter

Shutter function is available to block out light to the screen, so that the screen can be used for the other presenters.

### Protection

Prohibits the shutter operation from the remote control and the projector's side control.

Remote control . . . Selecting "On" prohibits the shutter operation from the remote control.

Projector . . . . . Selecting "On" prohibits the shutter operation from the side control.

It is possible to prohibit the shutter operation from both of the remote control and the side control.

### Effect

Choose the image effect at opening or closing the shutter from the following options.

- Off ..... Disable.
- L1 ..... The Image will fade in and out at opening or closing the shutter.
- L2 ..... The Image will fade in and out more slowly compared with L1.

### Release key

Choose the active buttons to release the shutter when the shutter is closed from the following options.

- Any ..... By pressing any buttons on the remoter control and the side control when the shutter is closed, the shutter will be released.
- SHUTTER .. Only the SHUTTER button on the remote control and the side control can be released the shutter when the shutter is closed.  
Only the following buttons are active when the shutter is closed;
  - INPUT button and INPUT 1/2/3/4 button
  - ON/STAND-BY button

### Management

The Shutter Management function turns off the projection lamp when the projector is left with the shutter closed and the set time has passed away. The count-down time can be set between 5 and 480 minutes. When the count-down time has elapsed, the shutter will be opened up automatically and the lamp will be turned off to cool itself down. The SHUTTER indicator is blinking blue during this cooling-off period. When the lamp has been fully cooled down, the POWER indicator turns green lighting and the SHUTTER indicator keeps blinking. Should the ON / STAND-BY button be pressed in this condition, the projection lamp will be turned on and the SHUTTER indicator turns off.

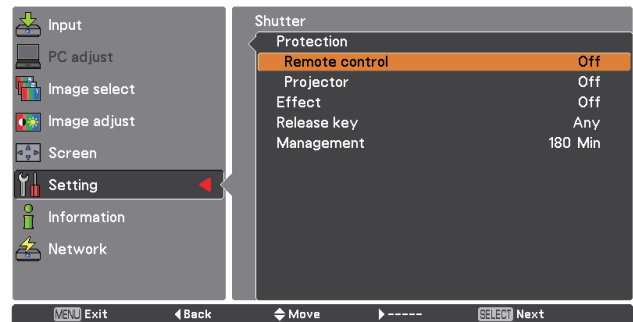

## Video delay control

When you want to make a digital processing of a projected image faster, set this function.

Use the Point ▲▼ buttons, select an item of Off/Low/Mid/High.

Digital processing speed becomes fast by order of Low → Mid → High. High is the fastest.

### ✓Note:

- The following functions are not available respectively when Video delay control is set to Low/Mid/High.  
 Low .....Keystone can not be selected.  
 Mid .....Progressive and Noise reduction can not be selected.  
 High..... Keystone, Progressive and Noise reduction can not be selected.
- When Video delay control function is set to Low or High and press the KEYSTONE button on the remote control, "Video delay :On" will be displayed on the left lower area of the screen (Fig.1).



Fig.1

## Closed caption

Closed Caption is a function that displays the audio portion of a TV program as text on the screen. If the input signal contains closed captions, you can turn on the feature and switch the channels. Press the Point ▲▼ buttons to select Off, CC1, CC2, CC3 or CC4.

If the Closed caption is not clear, you can change the text from Color to White.



## Filter counter

This function is used to set a frequency for the filter replacement.

Use the Point ▲▼ buttons to select Filter counter and then press the Point ► or the SELECT button to access the submenu items.

- Filter counter . . . . . Shows the total used filter time. The filter counter is displayed in red when filter counter exceeded the time specified for Filter counter timer, or filter clogging was detected.
- Filter counter remaining...Shows the remaining time every 10% until the specified time comes. (p.74). When the remaining time reached 10%, it is displayed in red.
- Filter counter timer. . . . . To set the timing of replacing with a new filter. The filter replacement icon appears when filter counter exceeded the specified time or filter clogging was detected. (Options available for the mesh filter: Off/4000H/8000H/12000H/16000H, Options available for an optional smoke resistant filter: Off/10H/15H/20H)
- Filter counter reset . . . . . To reset the filter counter. Select Reset, press the SELECT button, and select Yes in the confirmation box (p.74).
- Auto cleaning timer . . . . . To schedule a filter cleaning task when the length of time you used the filter reached the specified time. (Options: 50H, 100H(default), 150H).

**✓Note:**

- Normally, the filter cleaning unit automatically starts cleaning the mesh filter either while cooling down the projector after the power was turned off or after restarting the projector.
- When the icon as shown in Fig.3 appeared for the first time, replace the filters as soon as possible. If you turn off the projector before you replace the filters, the projector will turn off 3 minutes after the power is turned on next time.

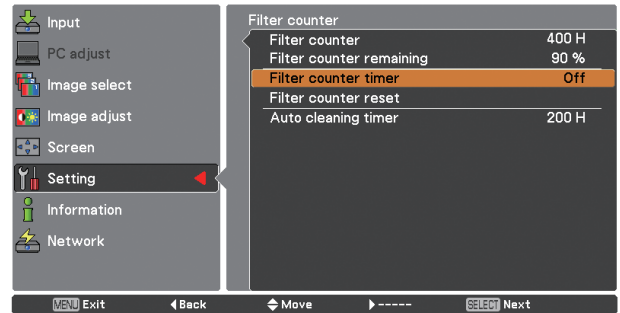

Press the SELECT button to select Filter counter timer and use the Point ▲▼ buttons to set the timer. Select from (Off/ 4000H/ 8000H/ 12000H/16000H) depending on the use environment.

Fig.1



This icon is warning you that the remaining time has exceeded the specified time.

Fig.2



This icon is warning you that the remaining time has reached 10%.

Fig.3



This icon is warning you that the remaining time has reached 0% and the filters need to be replaced as soon as possible.

**✓Note:**

- Fig.1, Fig. 2, and Fig. 3 appear at turning on and selecting input source.
- Fig.1, Fig. 2, and Fig. 3 will not appear when the Display function is set to Off (p.54) or during "Freeze" (p.31).



## P-timer

This function allows you to change the presentation of the P-timer and execute it.

Select one of the following options:

- Count up..... The P-timer display 000:00 appears on the screen and the count starts (000:00–180:00)
- Count down..... The time set in the Timer setting appears on the screen and the countdown starts.
- Timer ..... Use the Point ▲▼ buttons to set the Timer (1–180 Min). Only set to Count down, Timer is active. Factory default value is 10 Min.
- Start..... Executes the count up or count down function. Press the SELECT button at Start, Start changes to Stop in the Screen Menu. At that time, press the SELECT button at Stop to stop Count up or Count down, and Stop changes to Restart in the Screen Menu. Press the SELECT button at Restart to resume Count up or Count down.
- Reset ..... Resets the P-timer values. Press the SELECT button at Reset to return to the following value;  
Count up ... "000:00"  
Count down ... Timer that you set
- Exit..... To exit the P-timer operation.

### Stop or Cancel the P-timer via Remote Control

To stop the P-timer, press the P-TIMER button.

To cancel the P-timer, press and hold the P-TIMER button for a few seconds.

## Test pattern

Various test pattern are available for use when setting up the projector.

## Factory default

This function returns all setting values except for User logo, PIN code lock, Logo PIN code lock, Filter counter and Network setting to the factory default settings.

## P-TIMER

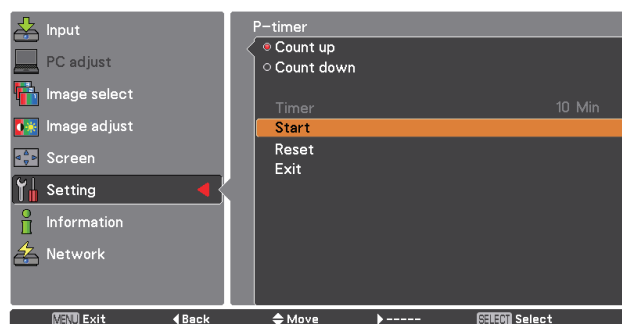

# How To Overlap the Projection Images

## How to Overlap the Projection Images on a Screen

You can obtain a seamless image by using the Edge Blending function which blends the images projected from multiple projectors and digitally dims the edges of the images and the Color Matching function which eliminates color unevenness. Follow the steps from 1 to 5 (or 8 if necessary) below to adjust multiple projector images.

### Edge blending

- 1 Configure the settings for screen size, image level, and lamp mode. These settings must match those for the rest of the projectors. Select Constant mode from the Lamp mode menu and then specify the same Target value as the projectors.
- 2 Display the images to be edge-blended on a screen.  
(In the following example, two projectors: Projectors A and B are used.)

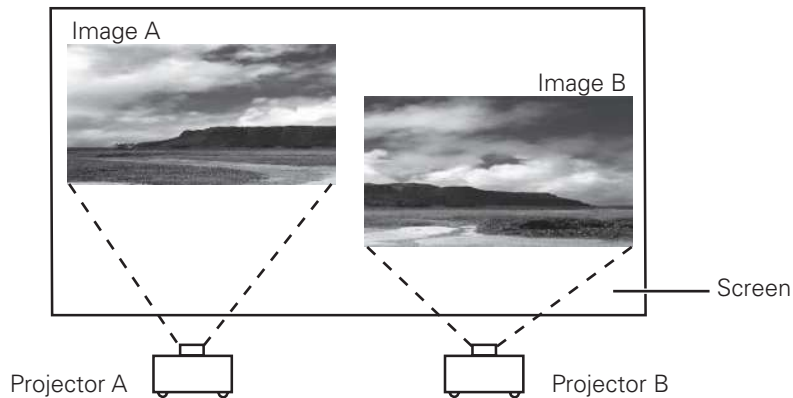

- 3 If black horizontal and/or vertical bar(s) on four sides of the images appear, adjust the Start values until they become invisible and specify the values for Width to adjust the width of the area where the images overlap. (Refer to pages 58, 59 for operation procedure.)

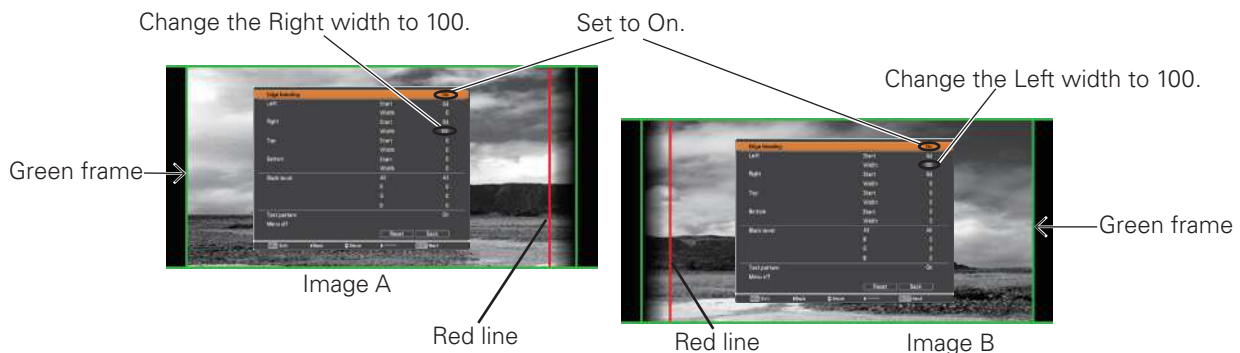

- The blending widths for each projector (e.g., the Right width of Image A and the Left width of Image B) must be set to the same value.
- The values in the figures are example .
- The frame around an image is displayed in green, and red line(s) appear at the specified position(s).
- The areas to be overlapped are displayed in shaded color.

- 4 Adjust the position, focus and zoom of each image if necessary, and then overlap the shaded areas by using the lens shift function. When the shaded areas are overlapped with each other correctly, the red lines turn yellow.

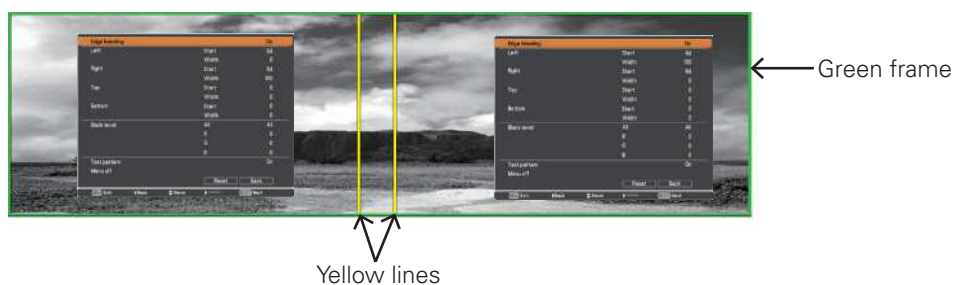

- 5** Set Test pattern to On to display a 50 % white image. The overlap area will be brighter than the non-overlapping area. Adjust the Black level in the Edge blending dialog box to increase the brightness of the non-overlapping area so that the unevenness is reduced.

**✓ Note:**

- The overlapping area might become uneven depending on the images. In such a case, it is recommended to decrease the contrast of the images in the Image Adjust Menu.

If the colors of the left and right images do not match, then follow the next step.

## Color matching

- 6** Select Color matching in the setting menu and display the Color matching dialog box. Then, set Color matching to On and adjust the color settings (Red/Green/Blue). (Refer to pages 57, 58 for operation procedure.)

- 7** Select Advanced color matching if you need further adjustment. In the Advanced color matching dialog box, set Advanced color matching to On and adjust the values of Target (Red/Green/Blue/ Cyan/ Magenta/ Yellow/ White).

**✓ Note:**

- When you change the values of Target, make sure that each Target value should be within the range of Measured value. (e.g., In the case of the Fig.1, the X value of Target-Red should be within 0.674 which is the X value of Measured-Red.)

- 8** If color unevenness is still detected between the left image and right image, measure chromaticity coordinates and luminance of Red, Green, and Blue by using a colorimeter, and then input the measured values by following the steps below.

1. Ensure that the Advanced color matching function is set to "On".
2. Highlight "Test pattern" appearing at the lower part of the window and press the SELECT button to display the Test pattern window.
3. Select Red, Green, or Blue and press the SELECT button to display the test pattern.
4. Measure chromaticity coordinates (X and Y) and luminance (Lx) by using a colorimeter.
5. Highlight "Exit" in the Test pattern window and press the SELECT button to return to the Advanced color matching window.
6. Highlight the color of the coordinates and luminance that you measured at the step 4, in the Measured section, and press the SELECT button.
7. Input the measured chromaticity coordinates and luminance values in the x and y fields.
8. The values to be input in the L fields can be calculated according to the following formula:  

$$L = \text{Measured luminance of the color} \div \text{total measured luminance of all colors (Red, Green, and Blue)}.$$
9. Readjust the Target values.
10. Highlight "Store" appearing at the lower part of the Advanced color matching window and press the SELECT button to store the values.

Set to On.

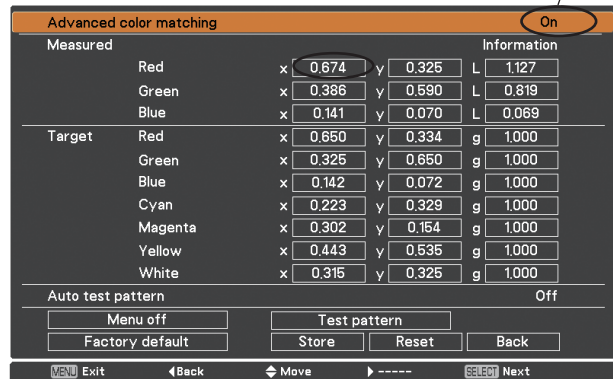

# Maintenance and Care

## Maintaining the AMC unit

- 1** Press the ON/STAND-BY button on the side control or the STAND-BY button on the remote control, flip the Main On/Off Switch off, and then unplug the AC power cord from the AC outlet.
- 2** Remove the dust on the projector and air vents.
- 3** Loosen the 2 screws that secure the AMC unit and pull it out.
- 4** Overturn the AMC unit and loosen the 2 screws that secure the filter cleaning unit.
- 5** After opening the filter cleaning unit cover, take out the dust bin from the filter cleaning unit, empty the dust bin by discarding the dust into a trash bin or carefully sucking up the dust with a vacuum cleaner, clean the brush, place back the dust bin, and then close the cover.
- 6** Place the AMC unit back into the projector and fix it with the 2 screws.
- 7** Plug the power cord and power on the projector.

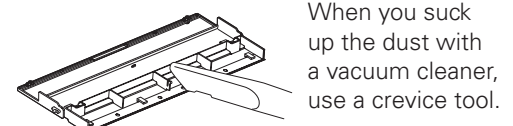
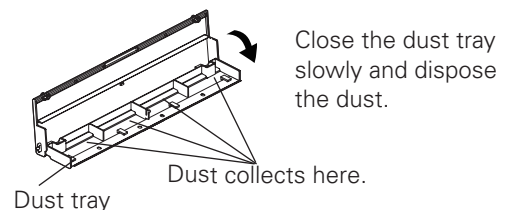
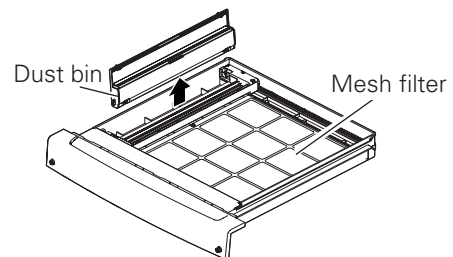
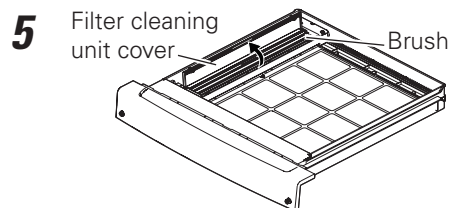
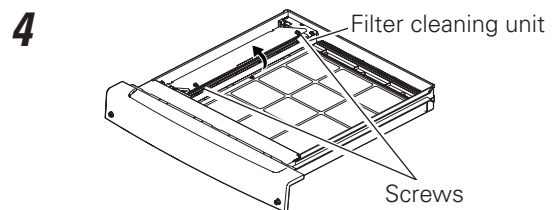
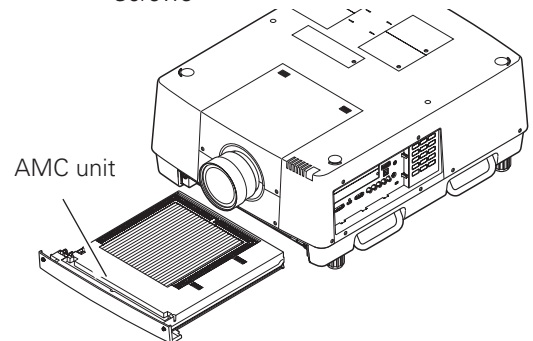
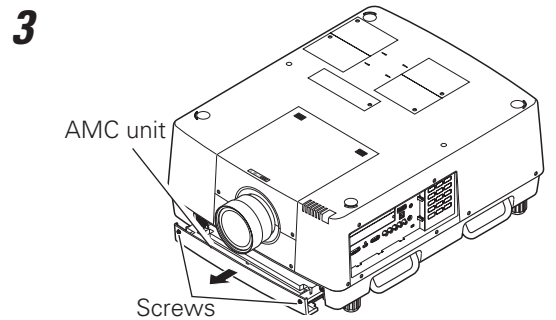

### ✓ Note:

- Do not reset the filter counter if the filters were not replaced.

### RECOMMENDATION

**We recommend avoiding dusty/smoky environments when operating the projector. Usage in these environments may cause a poor image quality.**

When using the projector under dusty or smoky conditions, dust may accumulate on a lens, liquid crystal panels, or optical elements inside the projector. Such condition may degrade the quality of the projected image.

When the symptoms above are noticed, contact your authorized dealer or service center for proper cleaning.

## Replacing the Filters

- 1** Press the ON/STAND-BY button on the side control or the STAND-BY button on the remote control, flip the Main On/Off Switch off, and then unplug the AC power cord from the AC outlet.
- 2** Remove the dust on the projector and air vents.
- 3** Loosen the 2 screws that secure the AMC unit and pull it out.
- 4** Slide forward a pair of the holders: A and B, loosen the 3 screws that secure the holders, and remove the holders.
- 5** After inserting your fingers through the slits and lifting the filters on the mesh filter to remove them easily, remove the filters one by one, and if necessary, suck up the dust accumulated on the mesh filter and the frame with a vacuum cleaner.
- 6** Put the new electrostatic honeycomb filter on the mesh filter, the new electrostatic pleated filter on the honeycomb filter, the holders on the electrostatic pleated filter, respectively, and then fix with the screws.
- 7** Slide backward the holders until the arrow marks on the holders are aligned with those on the AMC unit.
- 8** Place the AMC unit back into the projector and fix it with the 2 screws.
- 9** Plug the power cord, power on the projector and reset the filter counter.



### CAUTION

- After cleaning or replacing the filter, insert the AMC unit completely. If not, the projector cannot be turned on.
- Do not put anything into the air vents. Doing so may result in malfunction of the projector.
- Do not wash the filters in water or any other liquid. Otherwise the filters may be damaged.
- When using a vacuum cleaner to remove the dust on the mesh filter, be careful as the filter tears easily.
- When the mesh filter gets too dirty, contact your authorized dealer or service center.

**3**

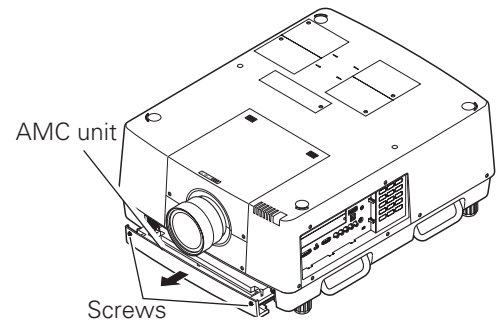

**4**

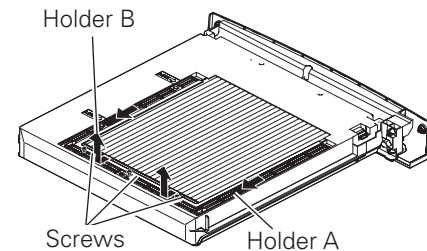

**5**

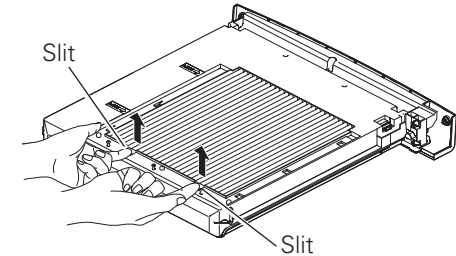

**6**

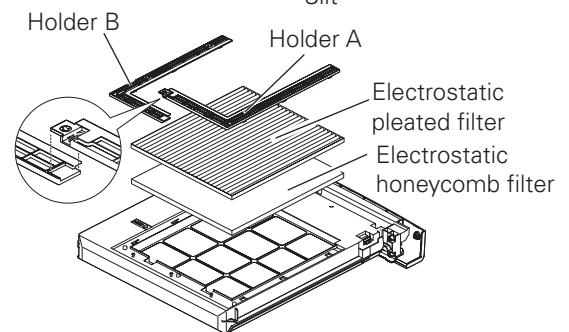

### ORDER REPLACEMENT FILTER

Replacement filter can be ordered through your dealer. When ordering, give the following information to the dealer.

- **Model No. of your projector:**  
LC-HDT2000
- **Replacement Filters (sold as a set):** 610 354 6902 (service parts code)  
An Electrostatic Pleated Filter  
An Electrostatic Honeycomb Filter

## Resetting the Filter Counter

Be sure to reset the Filter counter after replacing the filters.

- 1 Press the MENU button to display the On-Screen Menu. Use the Point ▲▼ buttons to select Setting and then press the Point ► or the SELECT button.
- 2 Use the Point ▲▼ buttons to select Filter counter and then press the SELECT button. Use the Point ▲▼ buttons to select Filter counter reset and then press the SELECT button. Filter counter Reset? appears. Select Yes to continue.
- 3 Another confirmation dialog box appears, select Yes to reset the Filter counter.

### Filter counter

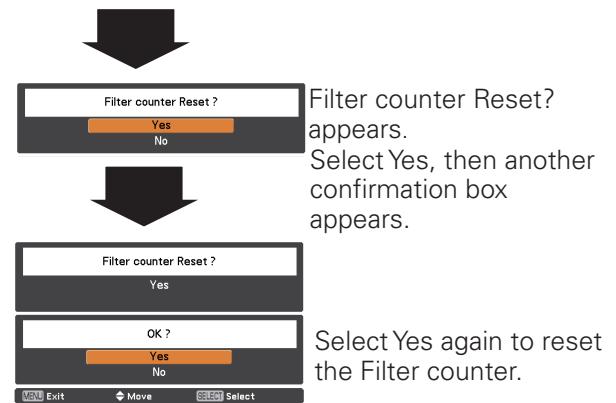
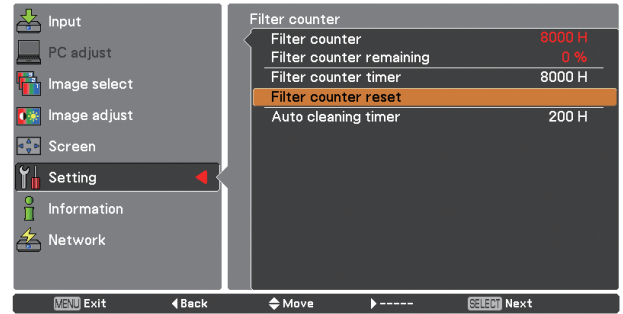

### ✓ Note:

- Whenever the filters have been replaced, reset the Filter counter, but if the filters were not replaced, do not reset the filter counter, as this could cause product damage.



## Lamp Management

This Projector is equipped with 4 Projection Lamps to ensure brighter image and those lamps are controlled by the Lamp Management Function. The Lamp Management Function detects the status of lamps and shows the status on screen or on the LAMP REPLACE indicators. This function also automatically controls the Lamp Mode when any of lamps is out for the end of life or malfunctions.

### LAMP REPLACE Indicator

- When the LAMP REPLACE indicator lights: Any of the projection lamps is approaching its end
- When the LAMP REPLACE indicator flashes: The lamp reached its end.

### LAMP 1/2/3/4 REPLACE Indicators

- When any of the LAMP 1/2/3/4 REPLACE indicators lights: The corresponding lamp is approaching its end.
- When any of the LAMP 1/2/3/4 REPLACE indicators flashes: The corresponding lamp needs to be replaced

### Lamp Status Display

The lamp status icons as shown right appears on screen when the projector is turned on or the input source (input 1, input 2, Input 3 or input 4) is switched. You can also check lamp status by using the Information window. To display the Information window, see pages 27 and 30.

### Lamp Mode Changeover

The Lamp mode function automatically changes the lighting lamp (Lamp Mode) by detecting the status of lamp. For example, in 4-lamps mode, if one of the 4 lamps failed, the projector operates with the rest of the lamps, and the lamp mode automatically switches to the 3-lamps mode. To change the lamp mode manually, use the Lamp mode function. The illustrations shown right are the examples of on-screen lamp status in each lamp mode. Refer to the SETTING section on pages 55, 56.

### LAMP REPLACE indicator

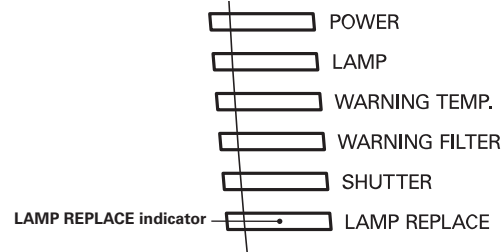

### LAMP 1/2/3/4 REPLACE indicators

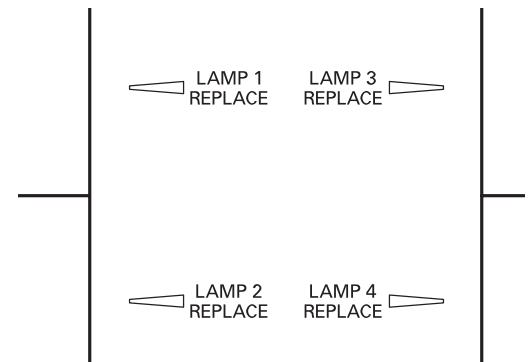

- Yellow Lamp**  
Projection Lamp lights normally.
- Dim Lamp**  
Projection Lamp is turned off.
- Red Lamp**  
Projection lamp is nearing its end. When the image becomes darker or the color becomes unnatural, replace lamp. (LAMP REPLACE indicator lights orange.)
- X Mark on Lamp**  
(LAMP REPLACE indicator flashes orange.)  
Projection lamp is defective or fails to be turned on. Restart the projector on, and make sure lamp is on. If this mark still appears, replace lamp corresponding with number marked X.

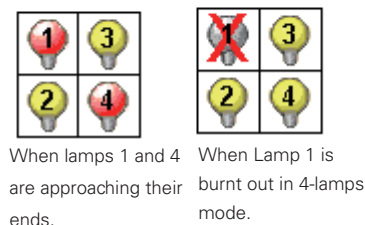
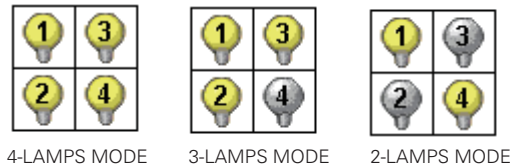

## Lamp Replacement

When the projection lamp of the projector reaches its end of life, the Lamp replacement icon appears on the screen and LAMP REPLACE indicator lights orange. Replace the lamp with a new one after it has cooled down. The timing when the LAMP REPLACE indicator lights up is depending on the mode that you specified for the Lamp control function.

### LAMP REPLACE indicator

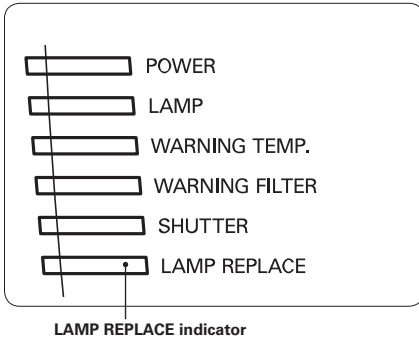

### LAMP 1/2/3/4 REPLACE indicators

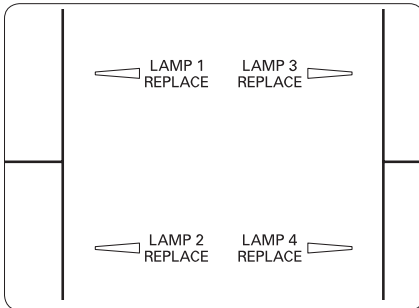

## CAUTION

When replacing the lamp because it has stopped illuminating, there is a possibility that the lamp may be broken. If replacing a lamp of the projector which has been installed on the ceiling, you should always assume that the lamp is broken, and you should stand to the side of the lamp cover, not underneath it. Remove the lamp cover gently. Small pieces of glass may fall out when the lamp cover is opened. If pieces of glass get into your eyes or mouth, seek medical advice immediately.

Follow these steps to replace the lamp.

- 1 Check the LAMP 1/2/3/4 REPLACE indicators on top of the projector. When any of the indicators blinks rapidly, wait at least 20 minutes until it blinks slowly. After that, go to the next step. When any of the indicators blinks slowly, go to the next step.
- 2 Loosen the screw on the lamp cover. Open the lamp cover. (See the right upper figure.)
- 3 Loosen the two screws that securing the lamp and pull out the lamp by using the handle. (See the right lower figure.)
- 4 Replace the lamp with a new one and tighten the two screws. Make sure the lamp is set properly.
- 5 Close the lamp cover and tighten the screw.

### Lamp replacement icon



### WARNING:

TURN OFF THE UV LAMP BEFORE OPENING THE LAMP COVER.



## CAUTION

Allow the projector to cool for at least 20 minutes before you open the lamp cover. The temperature inside the projector becomes very hot.



## CAUTION

- For continued safety, replace with a lamp assembly of the same type.
- Do not drop the lamp assembly or touch a glass bulb! The glass can shatter and may cause injury.
- When replacing the lamp, do it within 30 minutes after opening the lamp cover.
- Do not insert hand in the empty lamp compartment after the lamp is removed.

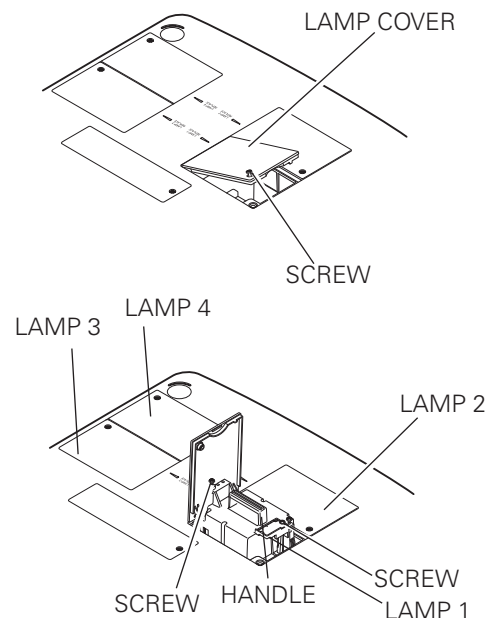



### **ORDER REPLACEMENT LAMP**

Replacement Lamp can be ordered through your dealer. When ordering a Projection Lamp, give the following information to the dealer.

- **Model No. of your projector:**      **LC-HDT2000**
- **Replacement Lamp Type No.:**      **POA-LMP147**  
(Service Parts No. 610 350 9051)



### **LAMP HANDLING PRECAUTIONS**

This projector uses high-pressure lamps which must be handled carefully and properly. Improper handling may result in accidents, injury, or create a fire hazard.

- Lamp lifetime may differ from lamp to lamp and according to the environment of use. There is no guarantee of the same lifetime for each lamp. Some lamps may fail or terminate their lifetime in a shorter period of time than other similar lamps.
- If the projector indicates that the lamp should be replaced, i.e., if the LAMP REPLACE indicator lights up, replace the lamp with a new one after the lamps have cooled down. (Follow carefully the instructions in the Lamp Replacement section of this manual.) Continuous use of the lamp with the LAMP REPLACE indicator lighted may increase the risk of lamp explosion.
- Lamp may explode as a result of vibration, shock or degradation as a result of hours of use as its lifetime draws to an end. Risk of explosion may differ according to the environment or conditions in which the projector and lamp are being used.

#### **IF A LAMP EXPLODES, THE FOLLOWING SAFETY PRECAUTIONS SHOULD BE TAKEN.**

If a lamp explodes, disconnect the projector's AC plug from the AC outlet immediately. Contact an authorized service center for a checkup of the unit and replacement of the lamp. Additionally, check carefully to ensure that there are no broken shards or pieces of glass around the projector or coming out from the cooling air circulation holes. Any broken shards found should be cleaned up carefully. No one should check the inside of the projector except those who are authorized trained technicians and who are familiar with projector service. Inappropriate attempts to service the unit by anyone, especially those who are not appropriately trained to do so, may result in an accident or injury caused by pieces of broken glass.

### ***Cleaning the Projection Lens***

Turn off the projector, press the Main On/Off Switch to Off and unplug the AC power cord from the AC outlet before cleaning.

Gently wipe the projection lens with a cleaning cloth that contains a small amount of non-abrasive camera lens cleaner, or use a lens cleaning paper or commercially available air blower to clean the lens.

Avoid using an excessive amount of cleaner. Abrasive cleaners, solvents, or other harsh chemicals might scratch the surface of the lens.

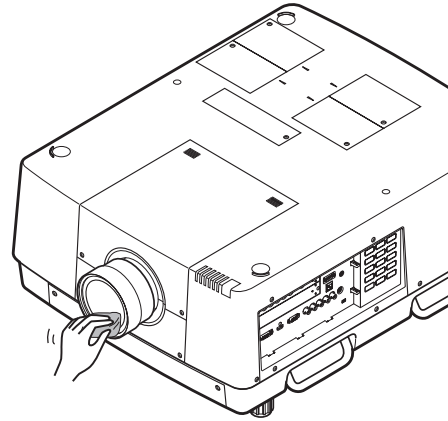

### ***Cleaning the Projector Cabinet***

Turn off the projector, press the Main On/Off Switch to Off and unplug the AC power cord from the AC outlet before cleaning.

Gently wipe the projector body with a soft dry cleaning cloth. When the cabinet is heavily soiled, use a small amount of mild detergent and finish with a soft dry cleaning cloth. Avoid using an excessive amount of cleaner. Abrasive cleaners, solvents, or other harsh chemicals might scratch the surface of the cabinet.

When the projector is not in use, put the projector in an appropriate carrying case or cover to protect it from dust and scratches.

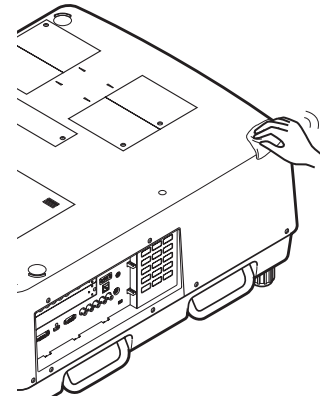

#### **CAUTION**

Do not use any flammable solvents or air sprays on the projector and in its vicinity. The explosion or fire hazard may occur even after the AC power cord is unplugged because the temperature inside the projector is extremely high due to the lamps. In addition, there is a risk that the internal parts may be damaged not only by the flammable air spray but also by the cold air.

## Warning Indicators

The WARNING indicators show the state of the function which protects the projector. Check the state of the WARNING TEMP. indicator and the LAMP indicator to take proper maintenance.

### **The projector is shut down and the WARNING TEMP. indicator is blinking red.**

When the temperature inside the projector reaches a certain level, the projector will be automatically shut down to protect the inside of the projector. The LAMP indicator turns red brighter and the WARNING TEMP. indicator blinks while the projector is being cooled down. When the projector has cooled down enough (to its normal operating temperature), it can be turned on again by pressing the ON/STAND-BY button.

**✓ Note:**

- The WARNING TEMP. indicator continues to blink even after the temperature inside the projector returns to normal. When the projector is turned on again, the WARNING TEMP. indicator stops blinking.

#### Indicators

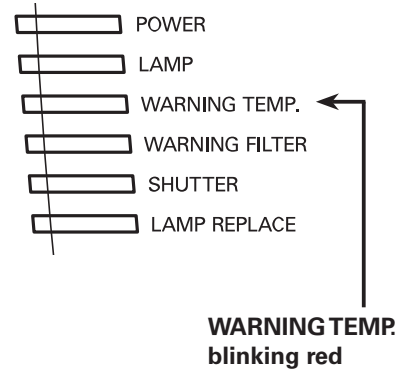

**WARNING TEMP.  
blinking red**

#### **Then check the matters below:**

- Did you provide appropriate space for the projector to be ventilated? Check the installing condition to see if the air vents of the projector are not blocked.
- Has the projector been installed near an Air-Conditioning/ Heating Duct or Vent? Move the installation of the projector away from the duct or vent.
- Is the filter clean? Replace the filter with a new one.

### **The projector is shut down; and the LAMP indicator is lighting and other indicators are blinking.**

When the projector detects an abnormal condition, it will be automatically shut down to protect the inside of the projector and the LAMP indicator lights on and other indicators blink. In this case, unplug the AC power cord and plug it, and then turn on the projector once again to verify operation. If the projector cannot be turned on and these indicators are still lighting and blinking, unplug the AC power cord and contact the service center.

#### Indicators

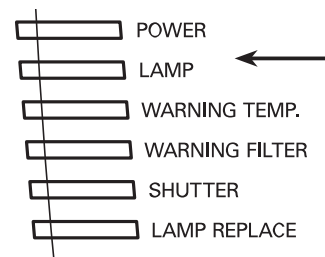

**LAMP indicator lights on  
and other indicators blink.**



**CAUTION**

DO NOT LEAVE THE PROJECTOR WITH THE AC POWER CORD CONNECTED UNDER AN ABNORMAL CONDITION. IT MAY RESULT IN FIRE OR ELECTRIC SHOCK.



# Appendix

## Troubleshooting

Before calling your dealer or service center for assistance, check the items below once again.

1. Make sure you have properly connected the projector to peripheral equipment as described on pages 20–21.
2. Check the cable connection. Make sure that all computers, video equipment, and power cords are properly connected.
3. Make sure that all power is switched on.
4. If the projector still does not produce an image, restart your computer.
5. If an image still does not appear, disconnect the projector from your computer and check your computer monitor's display. A problem may be noticed with your graphics controller rather than with the projector. (When you reconnect the projector, be sure to turn the computer and monitor off before you turn on the projector. Turn on equipment in the order of the projector and computer.)
6. If a problem still persists, check the following solutions.

<b>Problem:</b>	<b>Solutions</b>
<b>No power.</b>	<ul style="list-style-type: none"> <li>– Plug the power cord of the projector into the AC outlet.</li> <li>– Turn the MAIN ON/OFF switch to ON.</li> <li>– Press the ON/STAND-BY Button to ON.</li> <li>– Make sure the POWER indicator lights.</li> <li>– Check the indicators. If the LAMP indicator lights and the other indicators blink, the projector cannot be turned on. (Refer to page 79.)</li> <li>– Check the projection lamp. (Refer to pages 76, 77.)</li> <li>– Unlock the key lock function. (See page 64)</li> </ul>
<b>PIN code dialog box appears at start-up.</b>	<ul style="list-style-type: none"> <li>– PIN code lock is being set. Enter a PIN code; the "1234" or numbers you have set (see pages 24, 64, 65)</li> </ul>
<b>The initial display is not shown.</b>	<ul style="list-style-type: none"> <li>– Make sure "Off " or "Countdown Off" are not chosen at Display function. (See page 54)</li> </ul>
<b>The initial display is not same with the default one.</b>	<ul style="list-style-type: none"> <li>– Make sure "User" or "Off" are not chosen at Logo select function. (See page 60)</li> </ul>
<b>When the projector is on and you press the input button, an icon other than the Lamp mode icon appears.</b>	<ul style="list-style-type: none"> <li>– That is the Filter warning icon. Refer to page 68.</li> </ul>
<b>An icon other than Input mode or Lamp mode icon appears.</b>	<ul style="list-style-type: none"> <li>– That is the Lamp replacement icon or the Filter warning icon. See pages 76, 68.</li> </ul>
<b>No image.</b>	<ul style="list-style-type: none"> <li>– Check the connection between your computer or video equipment and the projector.</li> <li>– See if the input signal is correctly output from your computer. Some laptop computers may need to be changed the setting for monitor output when connected to the projector. See your computer's instruction manual for the setting.</li> <li>– It takes about 20 seconds to display an image after turning on the projector.</li> <li>– See if the selected system is corresponding with your computer or video equipment.</li> <li>– Select correct input source once again through menu operation (See pages 33-35).</li> <li>– Make sure the temperature is not out of Operating Temperature (41°F–104°F [5°C–40°C]).</li> <li>– Make sure that the shutter is open. (See pages 28, 66)</li> </ul>

 <p><b>appears on the screen</b></p>	<ul style="list-style-type: none"> <li>- The end of lamp life is approaching. Replace the lamp with a new one after it has cooled down. (See page 76)</li> </ul>
 or  <p><b>appears on the screen</b></p>	<ul style="list-style-type: none"> <li>- The remaining time exceeded the specified time or reached 0%. In the latter case, replace the filter with a new one promptly. (See pages 73, 74)</li> </ul>
<p><b>The image is out of focus.</b></p>	<ul style="list-style-type: none"> <li>- Adjust the focus of the projector.</li> <li>- Check Projection Lens to see if it needs cleaning.</li> <li>✓ <b>Note:</b> Moving the projector from a cool temperature location to a warm temperature location may result in moisture condensation on Projection Lens. In such cases, leave the projector OFF and wait until condensation evaporates.</li> <li>- Projecting from excessive slant angle to the screen may cause keystone distortion and partial imperfect focus.</li> </ul>
<p><b>The image is not bright enough.</b></p>	<ul style="list-style-type: none"> <li>- Check if "Contrast" or "Brightness" are adjusted properly. (See pages 41, 49)</li> <li>- Check if "Image level" is selected properly. (See pages 40, 48)</li> <li>- Check the Lamp control function. ( See "SETTING" section on page 55)</li> <li>- Check the LAMP REPLACE indicator. If it lights, the end of lamp life is approaching. Replace the lamp with a new one after it has cooled down. (See page 76)</li> <li>- The image is darker when 2-lamps mode is selected, compared with 3-lamps mode. Check the lamp mode at SETTING section on page 55.</li> </ul>
<p><b>The color is strange.</b></p>	<ul style="list-style-type: none"> <li>- Check the Input signal, color system, video system, or computer system mode.</li> </ul>
<p><b>The image is Left/Right reversed.</b></p>	<ul style="list-style-type: none"> <li>- Check the Ceiling / Rear function. (See pages 46, 53)</li> </ul>
<p><b>The image is Top/Bottom reversed.</b></p>	<ul style="list-style-type: none"> <li>- Check the Ceiling function. (See pages 46, 53)</li> </ul>
<p><b>The image is distorted or runs off.</b></p>	<ul style="list-style-type: none"> <li>- Check "PC Adjust" menu or " Screen" menu and adjust them.</li> </ul>
<p><b>Auto PC adjustment function does not work.</b></p>	<ul style="list-style-type: none"> <li>- Check the Input signal. Auto PC Adjustment function cannot work when 480p, 575p, 720p, 480i, 575i, 1035i, 1080p, or 1080i is selected or when the digital signal is input into HDMI/DVI-D terminal. (See page 37)</li> </ul>
<p><b>Some displays are not seen during the operation.</b></p>	<ul style="list-style-type: none"> <li>- Check the Display function (see page 54).</li> </ul>
<p><b>The setting does not remain after turning off power.</b></p>	<ul style="list-style-type: none"> <li>- Make sure you selected "Store" after adjusting settings. Some settings cannot be stored if not registered with "Store".</li> </ul>
<p><b>Power management function does not work.</b></p>	<ul style="list-style-type: none"> <li>- Power management function cannot work while "Freeze" function is running or the shutter is closed.</li> </ul>
<p><b>Image disappears automatically.</b></p>	<ul style="list-style-type: none"> <li>- Check the power management function in the Setting. The power management is set to "On" at the factory.</li> </ul>
<p><b>Capture function does not work.</b></p>	<ul style="list-style-type: none"> <li>- Check the connection to see if there is signal.</li> <li>- Capture function is not available when the Picture in Picture function is set to one of User1 - 5.</li> </ul>
<p><b>Some menus cannot be selected.</b></p>	<ul style="list-style-type: none"> <li>- Each of the Video Input and Computer Input has a limit on selectable menus.</li> </ul>

<p><b>The shutter does not work.</b></p>	<ul style="list-style-type: none"> <li>– Check “Protection” or “Release Key” of the shutter function. (See page 66)</li> </ul>
<p><b>The power is turned off automatically.</b></p>	<ul style="list-style-type: none"> <li>– Power management function runs by initial setting. Check “SETTING” section on page 63.</li> <li>– When the filter replacement icon keeps appearing on the screen at turning on the projector for some time and no action is taken to replace the filter, the projector will be automatically shut down in 3 minutes after turning on to protect the projector. (See pages 68, 88)</li> <li>– Do not cover the ventilation slots on the projector. (See pages 4, 6)</li> <li>– Projector may be used in high ambient temperature environment. Make sure the temperature is not out of Operating Temperature (41°F–104°F [5°C–40°C]). (See page 92)</li> </ul>
<p><b>You cannot operate with the side control.</b></p>	<ul style="list-style-type: none"> <li>– The side control is not available If the side control is locked at “Key lock” under “Security” of SETTING section. Please check “SETTING” section on page 64.</li> </ul>
<p><b>The Remote Control does not work.</b></p>	<ul style="list-style-type: none"> <li>– Check the batteries.</li> <li>– Check if the RC sensor is set properly. (See page 63)</li> <li>– Make sure no obstruction is between the projector and remote control.</li> <li>– Make sure you are not too far from the projector when using the remote control. Maximum operating range is 16.4' (5m).</li> <li>– Make sure that the remote control code conforms to the projector’s code. (See page 62.)</li> <li>– Check if the ON/ OFF switch on the remote control is set to ON.</li> <li>– Unlock the Key lock function for the remote control. (See page 64)</li> <li>– Wireless remote control does not work when the remote control cable is connected to the projector. (See page 15)</li> </ul>
<p><b>Indicators blink or light.</b></p>	<ul style="list-style-type: none"> <li>– Check the status of the projector with referring to “ INDICATORS AND PROJECTOR CONDITION” on pages 86-88.</li> </ul>
<p> <b>appears on the screen</b></p>	<ul style="list-style-type: none"> <li>– Your operation is invalid. Operate correctly.</li> </ul>
<p><b>Unable to unlock the Logo PIN code lock, Security key lock or Security PIN code lock.</b></p>	<ul style="list-style-type: none"> <li>– Contact the dealer where you purchased the projector or the service center.</li> </ul>
<p><b>Forget the Logo PIN code or Security PIN code.</b></p>	<ul style="list-style-type: none"> <li>– Contact the dealer where you purchased the projector or the service center.</li> </ul>
<p><b>When brightness (Current value) continuously goes down to a certain rate from Target value in Constant mode.</b></p>	<ul style="list-style-type: none"> <li>– Check the lamp status and replace the lamp, or decrease Target value in Constant mode.</li> </ul>

**WARNING:**

**High voltages are used to operate this projector. Do not attempt to open the cabinet.**

If problems still persist after following all operating instructions, contact the dealer where you purchased the projector or the service center. Specify the model number and explain about the problem. We will advise you how to obtain service.

## Menu Tree

### Computer Input/HDMI Input/Video Input

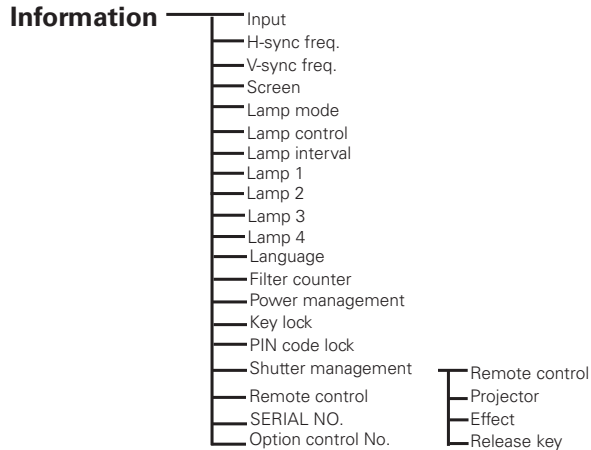
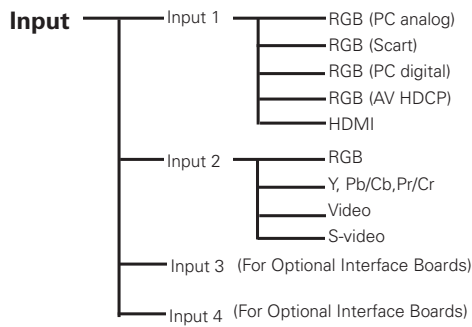

### Computer Input

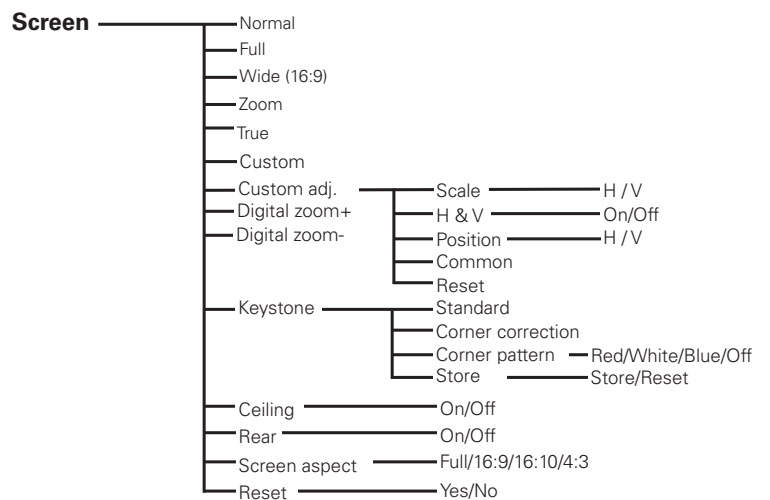
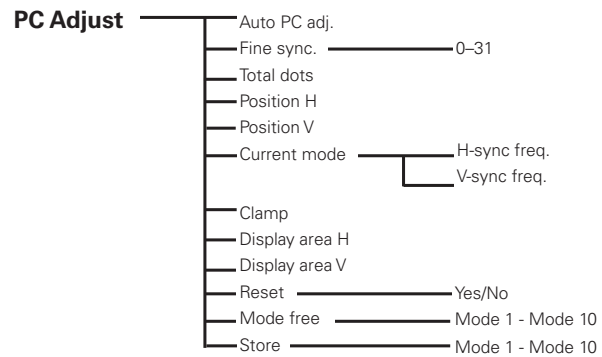
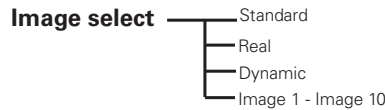
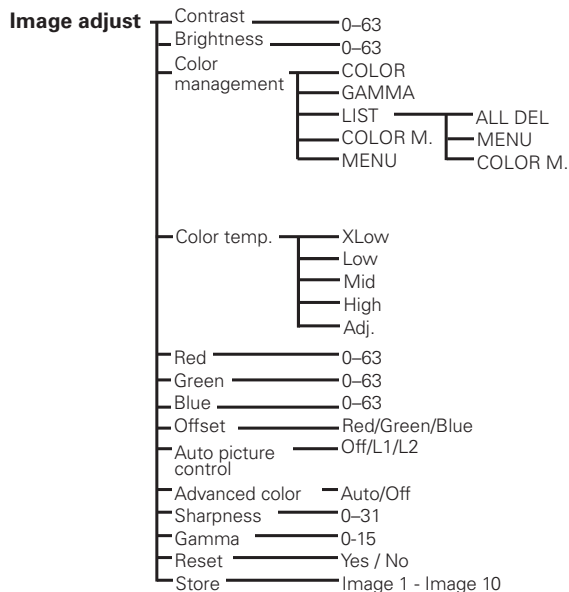
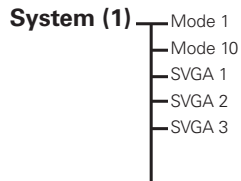

**✓ Note:**

•The Menu display varies depending on the input signal.





**Computer Input/HDMI Input/Video Input**

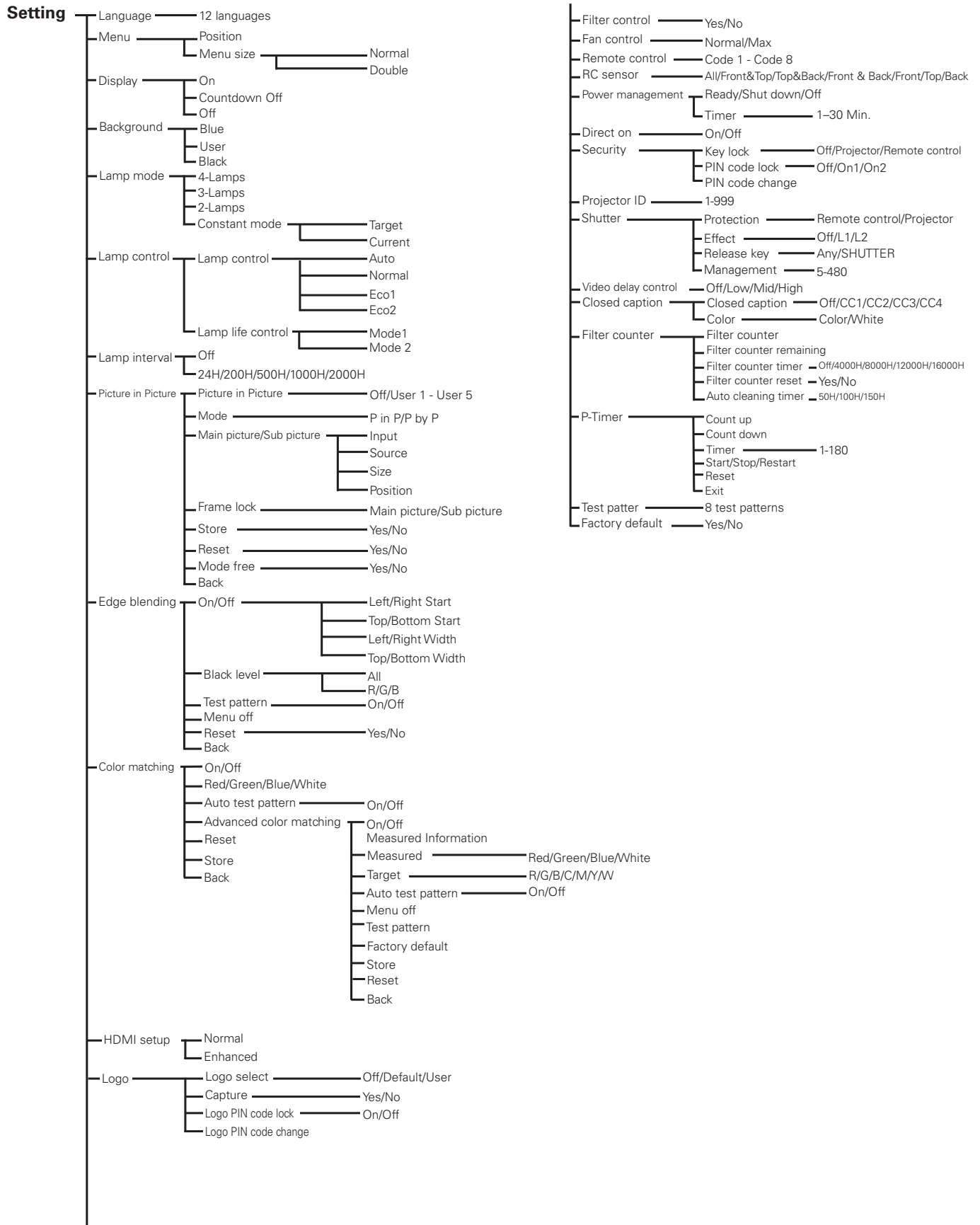

## Indicators and Projector Condition

Check the indicators for the projector condition.

**The projector is operating normally.**

Indicators						Projector Condition
POWER green	LAMP red	WARNING TEMP. red	WARNING FILTER orange	SHUTTER blue	LAMP REP. orange	
●	●	●	●	●	●	The projector is off. (The main On/Off switch is OFF position or the AC power cord is unplugged.)
○	○	●	*	*	*	The projector is in stand-by mode. Press the ON/STAND-BY button to turn on the projector.
○	●	●	*	●	*	The projector is operating normally. (The Shutter is open)
○	●	●	*	○	*	The projector is operating normally. (The Shutter is closed)
●	○	●	*	*	*	The projector is preparing for stand-by or the projection lamp is being cooled down. The projector cannot be turned on until cooling is completed and the POWER indicator lights green.
●	●	●	*	●	*	The projection lamp is being cooled down in the Power management mode.
○ <sup>⚡</sup>	●	●	*	●	*	The projector is in the Power management mode.
●	●	●	*	○ <sup>⚡</sup>	*	The projection lamp is being cooled down in the Shutter management mode.
○	●	●	*	○ <sup>⚡</sup>	*	The projector is in the Shutter management mode. Press the ON/STAND-BY button to turn on the projector.
○	*	●	⊙	*	*	The projector is cleaning the filter.

○ ●●● on

● ●●● dim

● ●●● off

○<sup>⚡</sup> ●●● blinking at the normal rate (approx. 1 second ON, 1 second OFF)

⊙ ●●● blinking fast (approx. 0.5 seconds ON, 0.5 seconds OFF)

\* ●●● Differs according to conditions.

○<sup>⚡</sup> ●●● blinking slowly (approx. 2 seconds ON, 2 seconds OFF)

⊙ ●●● blinking slowly (approx. 1 second ON, 5 seconds OFF)



The projector is detecting abnormal condition.

Indicators						Projector Condition
POWER green	LAMP red	WARNING TEMP. red	WARNING FILTER orange	SHUTTER blue	LAMP REP. orange	
○	●	☉	*	*	*	The temperature inside the projector is elevated close to the abnormally high level.
●	○	☉	*	*	*	The temperature inside the projector is abnormally high. The projector cannot be turned on. When the projector is cooled down enough and the temperature returns to normal, the POWER indicator lights green and the projector can be turned on. (The WARNING TEMP. indicator keeps blinking.)
○	○	☉	*	*	*	The projector has been cooled down enough and the temperature returns to normal. When turning on the projector, the WARNING TEMP. indicator stops blinking. Check and replace the filter.
●	○	●	*	*	☉	The lamp won't light up. (The projector is preparing for stand-by or the projection lamp is being cooled down. The projector cannot be turned on until cooling is completed.)
○	○	●	*	*	☉	The lamp won't light up. (The lamp has been cooled down enough and the projector is in stand-by mode and ready to be turned on with the ON/STAND-BY button.)
*	*	*	*	*	☉	One of the lamps failed. As the lamps are too hot to replace the lamp safely, the lamps are being cooled down.
*	*	*	*	*	☉	The lamps has been cooled down so that you can replace the lamp safely. To find out which lamp fails, check the LAMP 1/2/3/4/ REPLACE indicators on top of the projector (p.76)
*	*	*	*	*	○	One of the lamps has been operated for more than the total lamp operation time which you specified for the Lamp interval function (P56).

**WARNING FILTER**

When the filter detects clogging, the WARNING FILTER indicator lights orange. When this indicator lights orange, replace the filter with a new one promptly. Reset the Filter counter. (p.74).

## The projector is detecting abnormal condition.

Indicators						Projector Condition
POWER green	LAMP red	WARNING TEMP red	WARNING FILTER orange	SHUTTER blue	LAMP REP. orange	
○	*	●	○	*	*	<p>If the Filter counter reached a time set in the timer setting, the icon as shown in Fig.1 appears on the screen and the WARNING FILTER indicator on the top panel lights up. Replace the filter as soon as possible. If the projector reaches a time set in the timer setting, the icon shown in Fig. 2 appears on the screen and the WARNING FILTER indicator lights up. Replace the filter as soon as possible. If the filter is clogged, the icon as shown in Fig.3 appears on the screen and the WARNING FILTER indicator lights up. Replace the filter as soon as possible.</p> <p><b>✓ Note:</b> •Fig. 1, Fig.2 and Fig.3 icon will not appear when the Display function is set to "Off" (p.54), or during "Freeze" (p.31).</p>
 <p><b>Fig.1</b></p>						
 <p><b>Fig.2</b></p>						
 <p><b>Fig.3</b></p>						
⦿	○	⦿	⦿	⦿	⦿	The projector detects an abnormal condition and cannot be turned on. Unplug the AC power cord and plug it again to turn on the projector. If the projector is turned off again, unplug the AC power cord and contact the dealer or the service center. Do not leave the projector on. It may cause an electric shock or a fire hazard.
*	*	*	*	⦿	*	The shutter is out of control.
●	○	●	●	⦿	*	The shutter is out of control. (The projector is in the cooling mode.)
○	○	●	*	⦿	*	The shutter is out of control. (The projector is in the stand-by mode.) In that case, contact the service center immediately.

## Compatible Computer Specifications

Basically this projector can accept the signal from all computers with the V- and H-Frequency mentioned below and less than 230 MHz of Dot Clock.

ON-SCREEN DISPLAY	RESOLUTION	H-Freq. (kHz)	V-Freq. (Hz)	ON-SCREEN DISPLAY	RESOLUTION	H-Freq. (kHz)	V-Freq. (Hz)
VGA 1	640x480	31.470	59.880	SXGA 14	1280x1024 i	50.000	94.000
VGA 2	720x400	31.470	70.090	SXGA 15	1280x1024	63.370	60.010
VGA 3	640x400	31.470	70.090	SXGA 16	1280x1024	76.970	72.000
VGA 4	640x480	37.860	74.380	SXGA 17	1152x900	61.850	66.000
VGA 5	640x480	37.860	72.810	SXGA 18	1280x1024 i	46.430	86.700
VGA 6	640x480	37.500	75.000	SXGA 19	1280x1024	63.790	60.180
VGA 7	640x480	43.269	85.000	SXGA 20	1280x1024	91.146	85.024
MAC LC13	640x480	34.970	66.600	SXGA+ 1	1400x1050	63.970	60.190
MAC 13	640x480	35.000	66.670	SXGA+ 2	1400x1050	65.350	60.120
480p	640x480	31.470	59.880	SXGA+ 3	1400x1050	65.120	59.900
575p	768x575	31.250	50.000	SXGA+ 4	1400x1050	64.030	60.010
575i	768x576 i	15.625	50.000	SXGA+ 5	1400x1050	62.500	58.600
480i	640x480 i	15.734	60.000	MAC 21	1152x870	68.680	75.060
SVGA 1	800x600	35.156	56.250	MAC	1280x960	75.000	75.080
SVGA 2	800x600	37.880	60.320	MAC	1280x1024	80.000	75.080
SVGA 3	800x600	46.875	75.000	WXGA 1	1366x768	48.360	60.000
SVGA 4	800x600	53.674	85.060	WXGA 2	1360x768	47.700	60.000
SVGA 5	800x600	48.080	72.190	WXGA 3	1376x768	48.360	60.000
SVGA 6	800x600	37.900	61.030	WXGA 4	1360x768	56.160	72.000
SVGA 7	800x600	34.500	55.380	WXGA+ 2	1440 x 900	74.918	60.000
SVGA 8	800x600	38.000	60.510	UXGA 1	1600x1200	75.000	60.000
SVGA 9	800x600	38.600	60.310	UXGA 2	1600x1200	81.250	65.000
SVGA 10	800x600	32.700	51.090	UXGA 3	1600x1200	87.500	70.000
SVGA 11	800x600	38.000	60.510	UXGA 4	1600x1200	93.750	75.000
MAC 16	832x624	49.720	74.550	720p	1280x720	45.000	60.000
XGA 1	1024x768	48.360	60.000	720p	1280x720	37.500	50.000
XGA 2	1024x768	68.677	84.997	1035i	1920x1035 i	33.750	60.000
XGA 3	1024x768	60.023	75.030	1080i	1920x1080 i	33.750	60.000
XGA 4	1024x768	56.476	70.070		1920x1080 i	28.125	50.000
XGA 5	1024x768	60.310	74.920				
XGA 6	1024x768	48.500	60.020				
XGA 7	1024x768	44.000	54.580				
XGA 8	1024x768	63.480	79.350				
XGA 9	1024x768 i	36.000	87.170				
XGA 10	1024x768	62.040	77.070				
XGA 11	1024x768	61.000	75.700				
XGA 12	1024x768 i	35.522	86.960				
XGA 13	1024x768	46.900	58.200				
XGA 14	1024x768	47.000	58.300				
XGA 15	1024x768	58.030	72.000				
MAC 19	1024x768	60.240	75.080				
SXGA 1	1152x864	64.200	70.400				
SXGA 2	1280x1024	62.500	58.600				
SXGA 3	1280x1024	63.900	60.000				
SXGA 4	1280x1024	63.340	59.980				
SXGA 5	1280x1024	63.740	60.010				
SXGA 6	1280x1024	71.690	67.190				
SXGA 7	1280x1024	81.130	76.107				
SXGA 8	1280x1024	63.980	60.020				
SXGA 9	1280x1024	79.976	75.025				
SXGA 10	1280x960	60.000	60.000				
SXGA 11	1152x900	61.200	65.200				
SXGA 12	1152x900	71.400	75.600				
SXGA 13	1280x1024 i	50.000	86.000				

✓ **Note:**

- Alphabet letter "i" placed beside some of the resolutions represents interlace signal.
- \* "True" cannot be selected.

When an input signal is digital from the HDMI or DVI-D terminal, refer to the chart below.

ON-SCREEN DISPLAY	RESOLUTION	H-Freq. (kHz)	V-Freq. (Hz)
D-VGA	640x480	31.470	59.940
D-480i	720x480 i	15.734	60.000
D-575i	720x576 i	15.625	50.000
D-480p	720x480	31.470	60.000
D-575p	720x575	31.250	50.000
D-SVGA	800x600	37.879	60.320
D-XGA	1024x768	43.363	60.000
D-WXGA 1	1366x768	48.360	60.000
D-WXGA 2	1360x768	47.700	60.000
D-WXGA 3	1376x768	48.360	60.000
D-WXGA 4	1360x768	56.160	72.000
D-WXGA 5	1366x768	46.500	50.000
D-SXGA 1	1280x1024	63.980	60.020
D-SXGA 2	1280x1024	60.276	58.069
D-SXGA+ 1	1400x1050	63.970	60.190
D-WUXGA 2	1920x1200	74.038	59.950
D-WSXGA+ 1	1680x1050	65.290	59.954
D-WXGA+ 1	1440x900	55.935	59.887
D-720p	1280x720	45.000	60.000
D-720p	1280x720	37.500	50.000
D-1035i	1920x1035 i	33.750	60.000
D-1080i	1920x1080 i	33.750	60.000
	1920x1080 i	28.125	50.000
D-1080psf/30	1920x1080	33.750	60.000
D-1080psf/25	1920x1080	28.125	50.000
D-1080psf/24	1920x1080	27.000	48.000

ON-SCREEN DISPLAY	RESOLUTION	H-Freq. (kHz)	V-Freq. (Hz)
D-1080p	1920x1080	33.750	30.000
	1920x1080	28.125	25.000
	1920x1080	27.000	24.000
	1920x1080	67.500	60.000
	1920x1080	56.250	50.000

\* D-480i and D-575i signals are acceptable only when transferred via an HDMI cable.

**✓ Note:**

- Depending on the condition of signals and the type and length of cables, these signals may not be properly viewed.
- Specifications are subject to change without notice.
- You might be able to project images even when signals other than above are inputted, however the functions of the projector could be limited.
- Depending on your PC settings, the digital signals of your PC may not be projected correctly. In such a case, confirm your PC settings.
- When you project a DVI signal, connect the cables, turn the projector on, then select the input. Finally, turn on your PC. Be sure to follow this procedure, otherwise an image may not be projected on the screen. If an image is not projected correctly, restart your PC.
- Do not disconnect the cable while the projector is running. If the cable has been disconnected and then reconnected, an image may not be correctly projected.

**Supported Signal Format for Optional Board**

When using the optional board (DVI) “**AH-72223**”, refer to the chart on the previous page.  
 When using other optional boards, refer to the charts below.

Dual SDI Board “**AH-72217**”

ON-SCREEN DISPLAY	RESOLUTION	H-Freq.(kHz)	V-Freq.(Hz)
D-480i	720x480	15.734	60.000
D-575i	720x576	15.625	50.000
D-1035i	1920x1035 i	33.750	60.000
D-1080i	1920x1080 i	33.750	60.000
	1920x1080 i	28.125	50.000
D-720p	1280x720	45.000	60.000
D-1080psf/24	1920x1080	27.000	48.000
D-1080psf/25	1920x1080	28.125	50.000

ON-SCREEN DISPLAY	RESOLUTION	H-Freq.(kHz)	V-Freq.(Hz)
D-1080psf/30	1920x1080	33.750	60.000
D-1080p	1920x1080	27.000	24.000
	1920x1080	28.125	25.000
	1920x1080	33.750	30.000

Dual Link SDI Board “**AH-72722**”

ON-SCREEN DISPLAY	RESOLUTION	H-Freq.(kHz)	V-Freq.(Hz)
D-480i	720x480	15.734	60.000
D-575i	720x576	15.625	50.000
D-1035i	1920x1035 i	33.750	60.000
D-1080i	1920x1080 i	33.750	60.000
	1920x1080 i	28.125	50.000
D-720p	1280x720	37.500	50.000
	1280x720	45.000	60.000
D-1080psf/24	1920x1080	27.000	48.000
D-1080psf/25	1920x1080	28.125	50.000
D-1080psf/30	1920x1080	33.750	60.000

ON-SCREEN DISPLAY	RESOLUTION	H-Freq.(kHz)	V-Freq.(Hz)
D-1080p	1920x1080	27.000	24.000
	19820x100	28.125	25.000
	1920x1080	33.750	30.000
	1920x1080	56.250	50.000
	1920x1080	67.500	60.000
D-1080psf/24(2K)	2048x1080	27.000	48.000
D-1080psf/25(2K)	2048x1080	28.125	50.000
D-1080psf/30(2K)	2048x1080	33.750	60.000
D-1080p/24(2K)	2048x1080	27.000	24.000

5 BNC, S Board “**AH-72225**”

ON-SCREEN DISPLAY	RESOLUTION	H-Freq.(kHz)	V-Freq.(Hz)
480i	720x480	15.734	60.000
575i	720x576	15.625	50.000
480p	720x480	31.470	59.880
575p	720x575	31.250	50.000
1035i	1920x1035	33.750	60.000
1080i	1920x1080	33.750	60.000
	1920x1080	28.125	50.000
720p	1280x720	37.500	50.000
	1280x720	45.000	60.000

## Technical Specifications

### Mechanical Information

---

Projector Type	Multi-media Projector
Dimensions (W x H x D)	25.59" x 13.74" x 32.09" (650.0 mm x 349.0 mm x 815 mm)
Net Weight	102.5lbs (46.5 kg)
Feet Adjustment	±3.0°

### Panel Resolution

---

LCD Panel System	1.64" TFT Active Matrix type, 3 panels
Panel Resolution	2,048 x 1,080 dots
Number of Pixels	6,635,520 (2,048 x 1,080 x 3 panels)

### Signal Compatibility

---

Color System	PAL, SECAM, NTSC, NTSC4.43, PAL-M, and PAL-N
HDTV Compatible	720p, 1035i, 1080i, 1080p and 2K
SDTV Compatible	480i, 480p, 575i and 575p
Input Scanning Frequency	H-sync. 15 kHz–120 kHz, V-sync. 48 Hz–120 Hz

### Optical Information

---

Projection Lamp	380 W NSHA lamp x 4
-----------------	---------------------

### Interface

---

Input 1	DVI-D Terminal (Digital), Mini D-Sub 15-pin Terminal (Analog), HDMI (v.1.3 with Deep Color)
Input 2	BNC Type x 5 (VIDEO/Y/G, B/Pb/Cb, R/Pr/Cr, H/HV and V), S-Video
Other Jacks	Serial port in (D-sub 9), Serial port out (D-sub 9), USB port, LAN port (RJ-45), and Wired Remote Jack

### Power

---

Voltage and Power Consumption	AC 200–240 V (11.0 A Max. Ampere), 50/60 Hz
-------------------------------	---

### Operating Environment

---

Operating Temperature	41°F–104°F (5°C–40°C)
Storage Temperature	14°F–140°F (-10°C–60°C)

### Remote Control

---

Battery	AAA or LR03 Type x 2
Operating Range	16.4' (5 m/ ±30°)
Dimensions	1.9" (W) x 1.1" (H) x 5.7" (D) (48 mm x 27 mm x 145 mm)
Net Weight	3.6 oz (102 g) (including batteries)

### Accessories

---

<input type="checkbox"/> Remote Control and Batteries	<input type="checkbox"/> Spacers (For optional lens)
<input type="checkbox"/> AC Power Cord	<input type="checkbox"/> Power cord clamps
<input type="checkbox"/> VGA Cable	<input type="checkbox"/> Owner's Manual (CD-ROM)
<input type="checkbox"/> Real Color Manager Pro (CD-ROM)	<input type="checkbox"/> Quick Reference Guide
<input type="checkbox"/> PJ Network Manager (CD-ROM)	<input type="checkbox"/> PIN Code Label
<input type="checkbox"/> Mounting Clamp	<input type="checkbox"/> Remote Control Cable
<input type="checkbox"/> Cable ties	
<input type="checkbox"/> Lens Attachment (1 type) (For optional lens)	
<input type="checkbox"/> Light Block Plates (3 types) (For optional lens)	



- The specifications are subject to change without notice.
- LCD panels are manufactured to the highest possible standards. Even though 99.99% of the pixels are effective, a tiny fraction of the pixels (0.01% or less) may be ineffective by the characteristics of the LCD panels.
- Each projector has its own characteristics.  
When projecting with several projectors on the same screen or side by side, you may recognize different white balance and color uniformity on each projector.

### Optional Parts

The parts listed below are optionally available. When ordering those parts, specify the item name and Model No. to the sales dealer.

	<i>Model No.</i>
<b>Optional Interface Board (Dual-SDI)</b>	: AH-72217
<b>Optional Interface Board (Dual-Link SDI)</b>	: AH-72722
<b>Optional Interface Board (DVI / D-sub 15)</b>	: AH-72223
<b>Optional Interface Board (5-BNC / VIDEO)</b>	: AH-72225
<b>Smoke Resistant Filter Unit</b>	: AH-38321
<b>Smoke Resistant Filter (Replacement Filter)</b>	: AH-38323

### PJ Link Notice

This projector is compliant with PJLink Standard Class 1 of JBMA (Japan Business Machine and Information System Industries Association). The projector supports all commands defined by PJLink Class 1 and is verified conformance with PJLink Standard Class 1.

Projector Input		PJLink Input	Parameter
<b>INPUT 1</b>	RGB (PC analog)	RGB 1	11
	RGB (Scart)	RGB 2	12
	RGB (PC Digital)	DIGITAL 1	31
	RGB (AV HDCP)	DIGITAL 2	32
	HDMI	DIGITAL 3	33
	INPUT 1	AUX1	46
<b>INPUT 2</b>	Video	VIDEO 1	21
	Y, Pb/Cb, Pr/Cr	VIDEO 2	22
	RGB	RGB 3	13
	S-Video	VIDEO 5	25
	INPUT 2	AUX 2	47
<b>INPUT 3</b>	INPUT 3	AUX 3	48
<b>INPUT 4</b>	INPUT 4	AUX 4	49

PJLink is a registered trademark of JBMA and pending trademark in some countries.



## Configurations of Terminals

### ANALOG TERMINAL(Mini D-sub 15 pin)

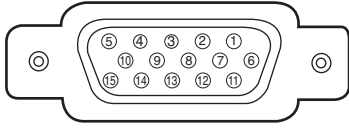

1	Red Input	9	+5V Power
2	Green Input	10	Ground (Vert. sync)
3	Blue Input	11	Ground
4	---	12	DDC data
5	Ground (Horiz. sync.)	13	Horiz. sync.
6	Ground (Red)	14	Vert. sync.
7	Ground (Green)	15	DDC Clock
8	Ground (Blue)		

### USB PORT(Series B)

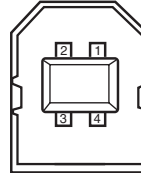

1	Vcc
2	- Data
3	+ Data
4	Ground

### CONTROL PORT CONNECTOR (D-sub 9 pin)

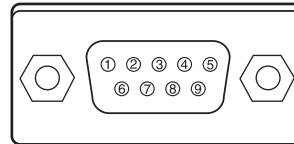

	Serial
1	---
2	RXD
3	TXD
4	---
5	SG
6	---
7	---
8	---
9	---

### HDMI TERMINAL(19 pin Type A)

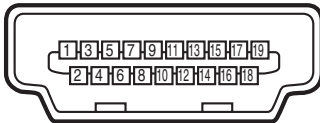

1	T.M.D.S. Data 2+ Input	11	Ground (T.M.D.S. Clock)
2	Ground(T.M.D.S. Data 2)	12	T.M.D.S. Clock- Input
3	T.M.D.S. Data 2- Input	13	---
4	T.M.D.S. Data 1+ Input	14	---
5	Ground (T.M.D.S. Data 1)	15	SCL
6	T.M.D.S. Data 1- Input	16	SDA
7	T.M.D.S. Data 0+ Input	17	Ground (DDC/CEC)
8	Ground (T.M.D.S. Data 0)	18	+5V Power
9	T.M.D.S. Data 0- Input	19	Plug insert detection
10	T.M.D.S. Clock+ Input		

### LAN PORT (RJ-45)

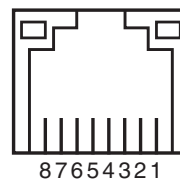

1	TX+
2	TX-
3	RX+
4	---
5	---
6	RX-
7	---
8	---

### DIGITAL (DVI-D) TERMINAL (DVI 24 PIN)

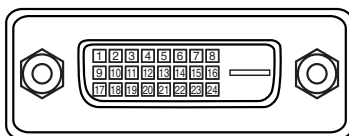

1	T.M.D.S. Data2-	9	T.M.D.S. Data1-	17	T.M.D.S. Data0-
2	T.M.D.S. Data2+	10	T.M.D.S. Data1+	18	T.M.D.S. Data0+
3	T.M.D.S. Data2 Shield	11	T.M.D.S. Data1 Shield	19	T.M.D.S. Data0 Shield
4	---	12	---	20	---
5	---	13	---	21	---
6	DDC Clock	14	+5V Power	22	T.M.D.S. Clock Shield
7	DDC Data	15	Ground (for +5V)	23	T.M.D.S. Clock+
8	---	16	Hot Plug Detect	24	T.M.D.S. Clock-

### ***PIN Code Number Memo***

Write down the PIN code number in the column below and keep it with this manual securely. If you forgot or lost the number and unable to operate the projector, contact the service center.

<b><i>PIN Code Lock No.</i></b>	<table border="1" style="width: 100%; height: 40px;"> <tr> <td style="width: 25%;"></td> <td style="width: 25%;"></td> <td style="width: 25%;"></td> <td style="width: 25%;"></td> </tr> </table> <p><b><i>Factory default set No: 1 2 3 4*</i></b></p>				
<b><i>Logo PIN Code Lock No.</i></b>	<table border="1" style="width: 100%; height: 40px;"> <tr> <td style="width: 25%;"></td> <td style="width: 25%;"></td> <td style="width: 25%;"></td> <td style="width: 25%;"></td> </tr> </table> <p><b><i>Factory default set No: 4 3 2 1*</i></b></p> <p><small>*Should the four-digit number be changed, the factory set number will be invalid.</small></p>				

While the projector is locked with the PIN code...

Put the label below (supplied) on in a prominent place of the projector's body while it is locked with a PIN code.

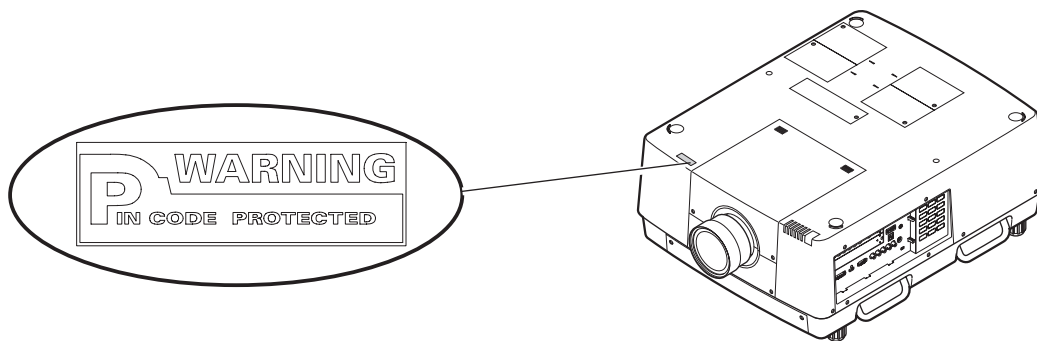

This symbol on the nameplate means the product is Listed by Underwriters Laboratories Inc. It is designed and manufactured to meet rigid U.L. safety standards against risk of fire, casualty, and electrical hazards.



The CE Mark is a Directive conformity mark of the European Community (EC).

## Dimensions

Unit: mm (inch)

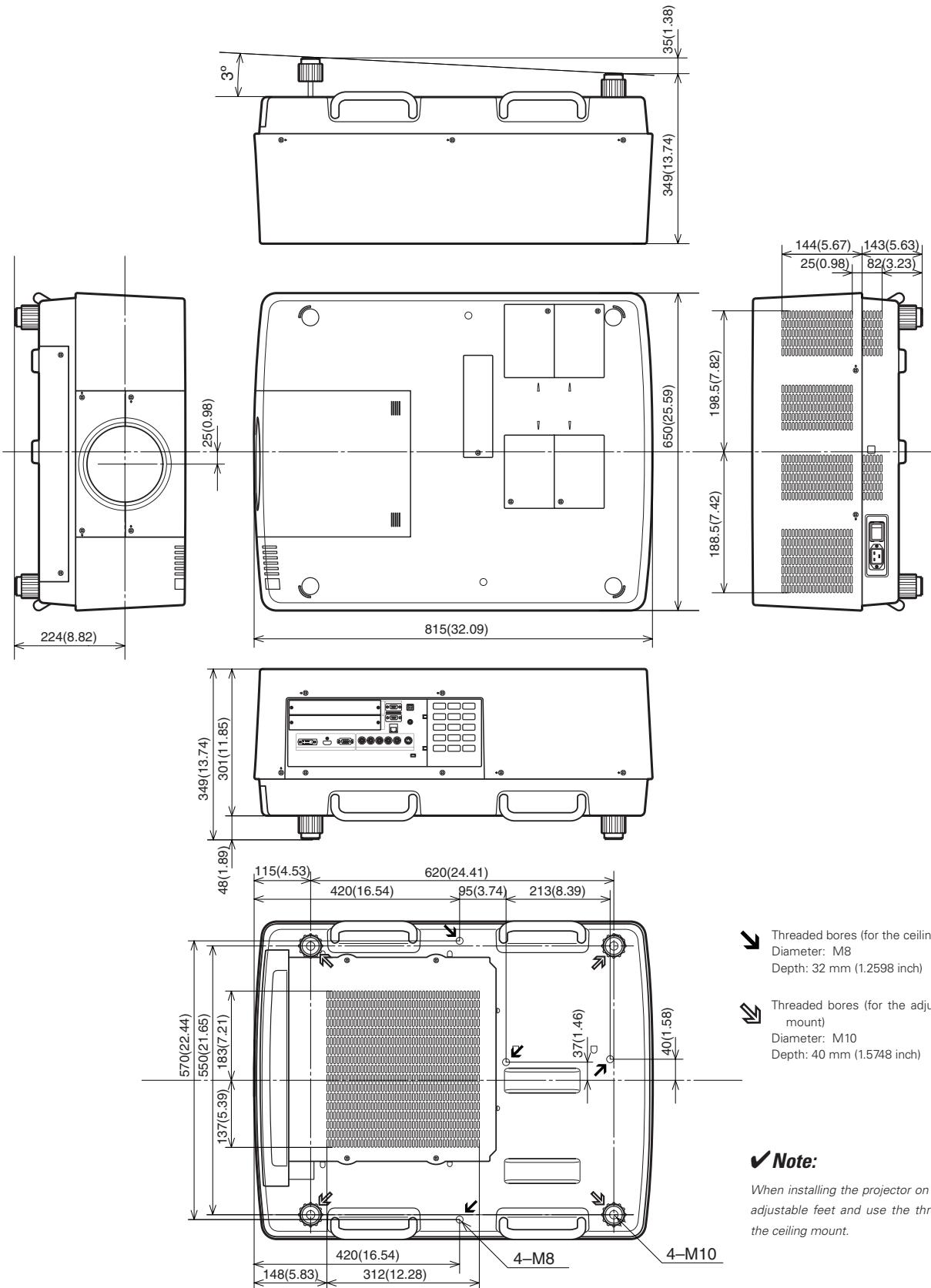

**List of Picture in Picture**

		On-Board						Optional Interface Board							
		Input1			Input2			Dsub -DVI			Component -S-video			SDI	Dual Link SDI
		Analog PC	Scart	Digital	Analog PC	Component	Video/ S-Video	Analog PC	Scart	Digital	Analog PC	Component	Video/ S-video	Digital	Digital
On-Board Input1	Analog PC	/	/	o	o	o	o	o	o	o	o	o	o	o	o
	Scart	/	/	o	o	o	o	o	o	o	o	o	o	o	o
	Digital	o	o	/	o	o	o	o	o	o	o	o	o	o	o
On-Board Input2	Analog PC	o	o	o	/	/	/	o	o	o	o	o	o	o	o
	Component	o	o	o	/	/	/	o	o	o	o	o	o	o	o
	Video/ S-Video	o	o	o	/	/	/	o	o	o	o	o	o	o	o

o : Picture in Picture combinations are enabled  
 - : Picture in Picture combinations are disabled

**✓ Note:**

- As for Input 3 and Input 4, combination of digital signals for Main picture and Sub picture is not available.
- When the input signal(s) is/are incompatible, X mark will be displayed on the Main/Sub picture.
- Depending on the frequency or signal type of PC/AV input, the display resolution may be lowered or images may not be displayed on the Main/Sub picture.
  - <Display resolution is lowered when;>
    - Inputting PC analog signals: More than 165 MHz
  - <Images are not displayed and X mark appears when;>
    - Inputting PC digital signals: More than 165MHz

## Serial Control Interface

This projector provides a function to control and monitor the projector's operations by using the RS-232C serial port.

### Operation

- 1** Connect a RS-232C serial cross cable to SERIAL PORT IN on the projector and serial port on the PC (See p.11).
- 2** Check the communication specifications shown right.
- 3** Type a functional execution command and press the Enter key.

Baud rate	: 9600 / 19200 bps
Parity check	: none
Stop bit	: 1
Flow control	: none
Data bit	: 8

#### Example

To select INPUT 2 port, type "C06" [CR].

#### ✓ Note:

- The default of the baud rate is set to 19200 bps. If an error occurs in the communication, change the serial port and the communication speed (baud rate).
- Enter with ASCII 64-byte capital characters and one-byte characters.

## Functional Execution Commands

### Format

The command is sent from PC to the projector with the format below;

"C" [Command] [CR]

Command: two characters (refer to the command table below.

-The projector decodes the command and returns the "ACK" with the format below;

[ACK] [CR]

-When the projector cannot decode the command, it returns with format below.

"?" [CR]

Command	Function
C00	Turn the projector ON
C01	Turn the projector OFF (immediately OFF)
C05	Select Input 1
C06	Select Input 2
C07	Select Input 3
C08	Select Input 4
C0D	Video mute ON
C0E	Video mute OFF
C0F	Screen Normal Size
C10	Screen Full Size
C1C	Menu ON
C1D	Menu OFF
C3A	Pointer RIGHT

Command	Function
C3B	Pointer LEFT
C3C	Pointer UP
C3D	Pointer DOWN
C3F	Enter
C46	Zoom DOWN
C47	Zoom UP
C4A	Focus DOWN
C4B	Focus UP
C5D	Lens shift UP
C5E	Lens shift DOWN
C5F	Lens shift LEFT
C60	Lens shift RIGHT
C89	Auto PC Adj.
C8E	Keystone UP
C8F	Keystone DOWN
C90	Keystone RIGHT
C91	Keystone LEFT

## Status Read Commands

### Format

The command is sent from PC to the projector with the format below;

“CR” [Command] [CR]

Command: one character (refer to the command table below.)

The projector decodes the command and returns the 'Character string' with the format below;

Command	Function	Return value	Projector status
CR0	Status Read	00	Power On
		80	Stand-by mode
		40	Countdown
		20	Cooling down
		10	Power Malfunction
		28	Cooling down at the temperature anomaly
		24	Cooling down at Power Management mode
		04	Power Management mode after Cooling down
		21	Cooling down after the projector is turned off when the lamps are out.
		81	Stand-by mode after Cooling down when the lamps are out.
		88	Stand-by mode after Cooling down at the temperature anomaly.
		2C	Cooling down when the projector is turned off by the shutter management function.
8C	Stand-by mode after Cooling down by the shutter management function.		
CR6	Temperature Read	%1 %2	%1 = Temperature at Sensor 1 (°C) %2 = Temperature at Sensor 2 (°C) (ex.) %1 = 12.3 (°C), %2 = 23.4 (°C) → The projector returns “ 12.3 23.4” (For each sensor, two digit and the tenth place numbers are displayed with a space between each temperature.)
		?	Communication failure

The tables on page 98 show the typical command lists for controlling the projector. Please consult your local dealer for further information of other commands.

# EIKI

## **U.S.A.**

---

EIKI International, Inc.  
30251 Esperanza  
Rancho Santa Margarita  
CA 92688-2132  
U.S.A.  
Tel : 800-242-3454 (949)-457-0200  
Fax : 800-457-3454 (949)-457-7878  
E-Mail : usa@eiki.com

## **Canada**

---

EIKI CANADA - Eiki International, Inc.  
P.O. Box 156, 310 First St. - Unit 2,  
Midland, ON, L4R 4K8, Canada  
Tel : 800-563-3454 (705)-527-4084  
Fax : 800-567-4069 (705)-527-4087  
E-Mail : canada@eiki.com

## **Deutschland & Österreich**

---

EIKI Deutschland GmbH  
Am Frauwald 12  
65510 Idstein  
Deutschland  
Tel : 06126-9371-0  
Fax : 06126-9371-14  
E-Mail : info@eiki.de

## **Eastern Europe**

---

EIKI CZECH SPOL. s.r.o.  
Nad Cementárnou 1163/4a  
Praha 4, Podolí  
147 00  
Czech Republic  
Tel : +420 241 410 928  
+420 241 403 095  
Fax: +420 241 409 435  
E-Mail : info@eiki.cz

## **China**

---

EIKI (Shanghai) Co., Ltd.  
Lakeside Oasis Middle Ring Business Centre  
Block 10. #16-07,  
1628, Jin Sha Jiang Road,  
Shanghai, 200333. China  
Main Line : 86-21-3251-3993  
Service Hot Line : 86-21-3251-3995  
Fax : 86-21-3251-3997  
E-mail : info@eiki-china.com

## **South East Asia**

---

EIKI Industrial (M) Sdn Bhd  
No. 3A-2C, 4th Floor, Jalan PJU 8/3A,  
Perdana Business Centre,  
Bandar Damansara Perdana,  
47820 Petaling Jaya, Selangor  
Malaysia  
Tel : +603-7722-4362  
Fax : +603-7722-4392  
E-Mail : sales@eiki.my

## **Japan & Worldwide**

---

EIKI Industrial Company Limited.  
4-12 Banzai-Cho, Kita-Ku, Osaka,  
530-0028 Japan  
Tel : +81-6-6311-9479  
Fax : +81-6-6311-8486

**WorldWide Website <http://www.eiki.com>**