

USER'S MANUAL

U2-1130/U2-1110

DATA PROJECTOR

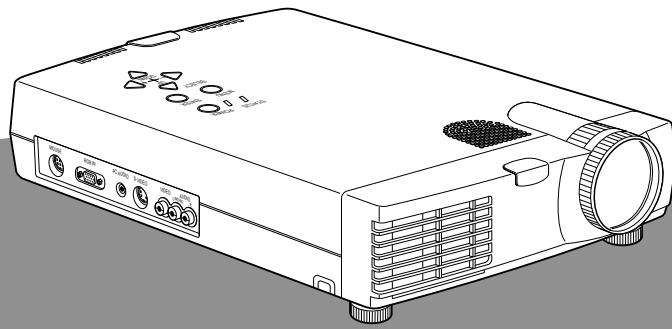

U2-1130

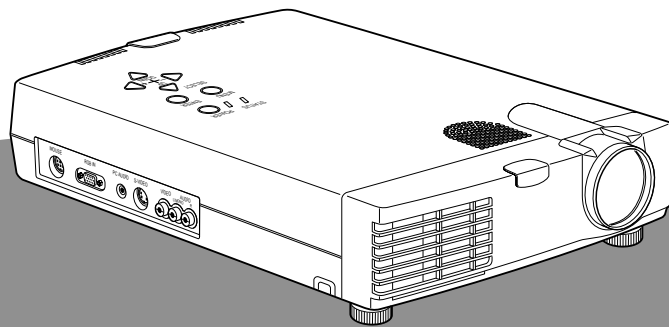

U2-1110*

* The U2-1130 is used for illustration purposes in this manual unless otherwise specified.

English

Français

Deutsch

Italiano

Español

中国语

PLUS

Note:

This equipment has been tested and found to comply with the limits for a Class A digital device, pursuant to Part 15 of the FCC Rules. These limits are designed to provide reasonable protection against harmful interference when the equipment is operated in a commercial environment. This equipment generates, uses, and can radiate radio frequency energy and, if not installed and used in accordance with the instruction manual, may cause harmful interference to radio communications. Operation of this equipment in a residential area is likely to cause harmful interference in which case the user will be required to correct the interference at his own expense.

PLUS CORPORATION

IMPORTANT

DMD™ is a trademark of Texas Instruments Inc.

Windows 98, Windows 95, and Windows 3.1 are registered trademarks in the United States and other countries of Microsoft Corporation.

IBM is a registered trademark of International Business Machines Corporation.

Macintosh and MAC are trademarks of Apple Computer Inc.

Other names of companies and products mentioned are trademarks and registered trademarks of the respective companies.

™, ® and © marks are not used in this document.

USER'S MANUAL

U2-1130/U2-1110

English

PLUS

IMPORTANT SAFETY INFORMATION

Precautions

Please read this manual carefully before using your PLUS U2-1130/U2-1110 Data Projector and keep the manual handy for future reference.

Your serial number is located next to the main power switch on the back of the unit. Record it here: _____

CAUTION

TO PREVENT SHOCK, DO NOT OPEN THE CABINET. NO USER-SERVICEABLE PARTS INSIDE. REFER SERVICING TO QUALIFIED PLUS SERVICE PERSONNEL.

WARNING

TO PREVENT FIRE OR SHOCK, DO NOT EXPOSE THIS UNIT TO RAIN OR MOISTURE. DO NOT USE THIS UNIT'S GROUNDED PLUG WITH AN EXTENSION CORD OR IN AN OUTLET UNLESS ALL THREE PRONGS CAN BE FULLY INSERTED. DO NOT OPEN THE CABINET. THERE ARE HIGH-VOLTAGE COMPONENTS INSIDE. ALL SERVICING MUST BE DONE BY QUALIFIED PLUS SERVICE PERSONNEL.

RF Interference

WARNING

The Federal Communications Commission does not allow any modifications or changes to the unit EXCEPT those specified by PLUS Technologies in this manual. Failure to comply with this government regulation could void your right to operate this equipment.

This equipment has been tested and found to comply with the limits for a Class A digital device, pursuant to Part 15 of the FCC Rules. These limits are designed to provide reasonable protection against harmful interference when the equipment is operated in a commercial environment. This equipment generates, uses, and can radiate radio frequency energy and, if not installed and used in accordance with the instruction manual, may cause harmful interference to radio communications. Operation of this equipment in a residential area is likely to cause harmful interference in which case the user will be required to correct the interference at his own expense.

DOC Compliance Notice

This Class A digital apparatus complies with Canadian ICES-003.

Warning

This is a class A product. In a domestic environment this product may cause radio interference in which case the user may be required to take adequate measures.

Important Safeguards

These safety instructions are to ensure the long life of the unit and to prevent fire and shock. Please read them carefully and heed all warnings.

Installation

- For best results, use the unit in a darkened room.
- Place the unit on a flat, level surface in a dry area away from dust and moisture.
- Do not place the unit in direct sunlight, near heaters or heat radiating appliances.
- Exposure to direct sunlight, smoke or steam can harm internal components.
- Handle the unit carefully. Dropping or jarring can damage internal components.
- Do not place heavy objects on top of the unit.
- If installing the unit on the ceiling:
 - The ceiling must be strong enough to support the unit and the installation must be in accordance with any local building codes.
 - The unit must be installed by qualified PLUS service personnel.

Power Supply

- The unit is designed to operate on a power supply of 100 to 120 and 220 to 240 V 50/60 Hz AC. Ensure that your power supply fits these requirements before attempting to use the unit.
- For PLUGGABLE EQUIPMENT, the socket-outlet shall be installed near the equipment and shall be accessible.
- Handle the power cable carefully and avoid excessive bending. A damaged cord can cause electric shock or fire.
- Disconnect the power cable (mains lead) from the power outlet after using the unit.
Before disconnecting the power cable, make sure that the POWER indicator lights in amber (not in green).

Table of contents

Cleaning

- Disconnect the power cable (mains lead) from the unit.
- Clean the cabinet of the unit periodically with a damp cloth. If heavily soiled, use a mild detergent. Never use strong detergents or solvents such as alcohol or thinner.
- Use a blower or lens paper to clean the lens, and be careful not to scratch or mar the lens.
- Clean the ventilation slots and speaker grills on the unit periodically using a vacuum cleaner. If accumulated dust blocks the ventilation slots, the unit will overheat, which may cause the unit to malfunction.
Use a soft brush attachment when using the vacuum cleaner. Do not use a hard attachment, such as a crevice tool, to prevent the damage to the unit.

Lamp Replacement

- Be sure to replace the lamp when the Status indicator comes on. If you continue to use the lamp after 1000 hours of usage, the lamp will turn off.

Fire and Shock Precautions

- Ensure that there is sufficient ventilation and that vents are unobstructed to prevent the buildup of heat inside the unit. Allow at least 10 cm (3 inches) of space between the unit and walls.
- Prevent foreign objects such as paper clips and bits of paper from falling into the unit. Do not attempt to retrieve any objects that fell into the unit. Do not insert any metal objects such as a wire or screwdriver into the unit. If something should fall into the unit, immediately disconnect the power cable from the unit and have the object removed by a qualified PLUS service person.
- Do not place any liquids on top of the unit.
- **Do not look into the lens while the unit is on. Serious damage to your eyes could result.**

Carrying around

When carrying the unit around, please use the carrying case that comes with it and, to protect the lens from scratches, always attach the lens cap. Also, do not subject the unit to strong mechanical shock.

Caution labels on bottom of the remote controller

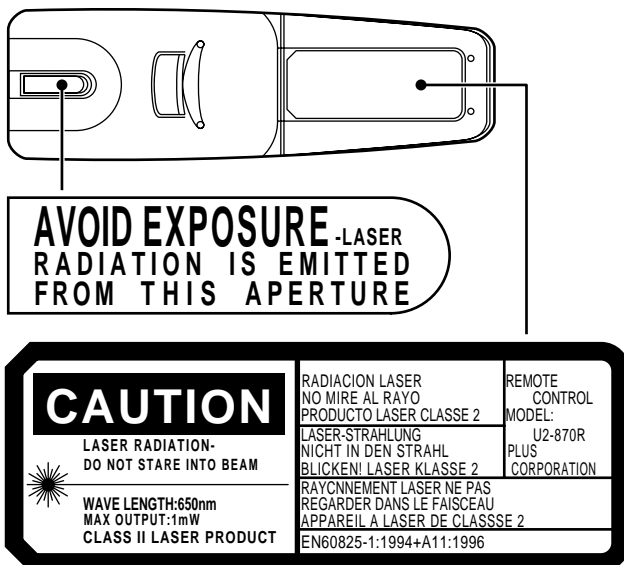

| | |
|------------------------------------|---|
| IMPORTANT SAFETY INFORMATION | 2 |
| Table of contents | 3 |

Basic information and preparations 4

| | |
|---|---|
| Features | 4 |
| Checking the supplied accessories | 4 |
| Preparing the remote control | 5 |
| Parts and controls | 6 |
| Installation | 9 |

Connections 11

| | |
|--|----|
| Connecting video equipment | 11 |
| Connecting a PC or Macintosh | 12 |
| Using the remote control as a computer mouse | |
| –Wireless mouse function | 14 |

Operation 15

| | |
|--|----|
| Using the unit | 15 |
| Various functions while using the unit | 19 |

Menu operation 22

| | |
|---|----|
| Menu structure | 22 |
| Basic operation (Selecting the input source) | 23 |
| Correcting the keystone effect | 24 |
| Selecting a projection type | 24 |
| Selecting a menu language | 24 |
| Selecting the color system | 24 |
| Selecting the pointer type | 25 |
| Adjusting the volume | 25 |
| Selecting the background | 25 |
| Adjusting the projected image from the computer | 26 |
| Adjusting the picture elements | 28 |
| Selecting the picture type | 28 |
| Activating the power saving function | 29 |
| Quick-starting the unit | 29 |
| Activating the on-screen function | 29 |
| Checking hours of lamp usage | 30 |
| Resetting to the factory settings | 30 |

Others 31

| | |
|---|----|
| Troubleshooting | 31 |
| When the STATUS indicator lights or flashes | 32 |
| Replacing the lamp cartridge | 33 |
| Specifications | 34 |

Features

Congratulations On Your Purchase Of The U2-1130/U2-1110 Data Projector

The U2-1130/U2-1110 is one of the very most spectacular data projectors available today. The unit enables you to project precise images up to 300 inches across (measured diagonally) from your PC or Macintosh computer (desktop or notebook), VCR, document camera, laser disc player, DVD player, etc.

The unit can be placed on a tabletop or cart, or permanently mounted on the ceiling*. The unit can also be used to project images from behind the screen.

* Installing the unit on the ceiling must be done by authorized PLUS technicians. Consult your dealer for more information.

The other main features you'll enjoy

- **Compatible with following various color systems:**

- NTSC (U.S. and Canada standard)
- PAL (Western Europe standard)
- SECAM (France and Eastern Europe standard)
- NTSC4.43 (Middle East standard)

- **(U2-1130)**

Superior brightness of 1300 ANSI lumens, the size of an A4 size/letter size piece of paper, and weighing only 2.6 kilograms/5.7 lbs.

- **(U2-1110)**

Superior brightness of 1100 ANSI lumens, the size of an A4 size/letter size piece of paper, and weighing only 2.5 kilograms/5.6 lbs.

Using TI's Digital Mirror Device (DMD) and our own optical design we have developed a geometric effect that increases the light usage efficiency. By increasing the light usage efficiency we can better reproduce the three basic colors (RGB) required for color reproduction on a single DMD. This means superior brightness, smaller size, and lighter weight.

- **Sharp, clear images**

There is no RGB color separation, and the spaces between the individual pixels are not noticeable. That means sharp and clear reproduction of small characters and figures. Take a closer look and notice the difference in quality!

- **Outstanding sharp, clear, 3D like images with vivid colors when reproducing DVD video and other high picture-quality data/video sources**

Faithful gray scale reproduction makes for more natural image displays. DVD and other high quality image sources bring out the true display capacity of the unit.

- **Screen not distorted to a trapezoid (keystoning) when projecting to the height of the line of vision**

Because the projection position is already set to the height of the line of vision, there is no keystoning effect.

Even when projecting above or under the height of the line of vision, image distortion (if any) can be adjusted using the keystone correction function.

- **(U2-1130, U2-1110)**

Fully compatible with true XGA; support for SXGA using advanced intelligent compression technology

The advanced intelligent compression technology enables these projectors to present clear compression SXGA images without any line omission.

- **A remote control that can operate the PC or Macintosh**

The supplied remote control both operates the unit and acts as a wireless mouse control to operate the PC or Macintosh connected to the unit.

- **The compact and easy to carry cabinet with its contemporary design complements any office, board room, or auditorium.**

Checking the supplied accessories

Make sure your box contains everything listed below. If any pieces are missing, contact your dealer.

Please save the original box and packing materials in case you ever need to ship the unit.

The number of accessories is indicated in brackets.

For remote control

Remote control [1]

Batteries (size AA/R6) [2]

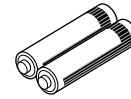
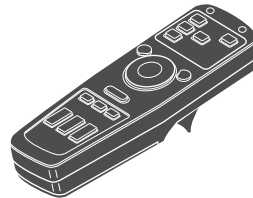

Power cable (mains lead) (1.8 m/5.9 ft.) [1]

The shape of the plug varies depending on the region where the unit is purchased.

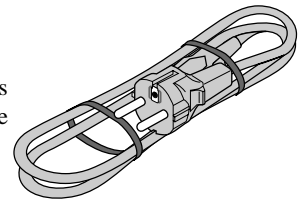

When using the remote control as computer mouse

Serial mouse cable [1]

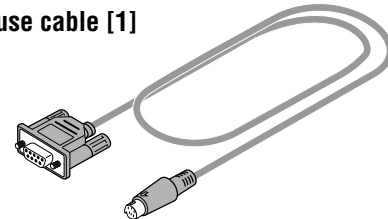

Mouse adapter (for IBM PS/2) [1]

Mouse adapter (for Macintosh) [1]

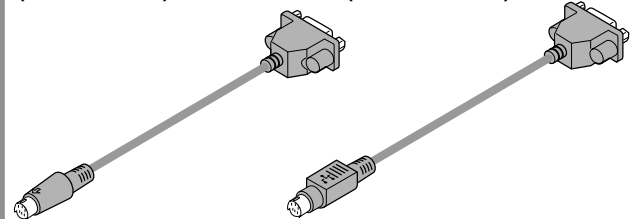

For computer connection

PC/Macintosh multicable (1 m/3.3 ft.) [1]

Monitor adapter (for Macintosh) [1]

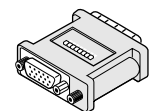
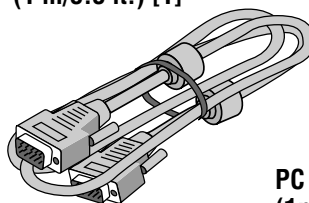

PC audio cable (1m/3.3 ft.) [1]

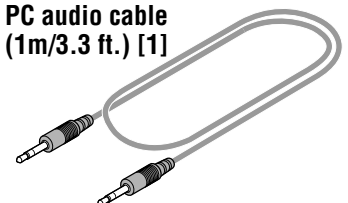

Preparing the remote control

For video equipment connection

Audio video cable
(1 m/3.3 ft.) [1]

S-video cable
(1 m/3.3 ft.) [1]

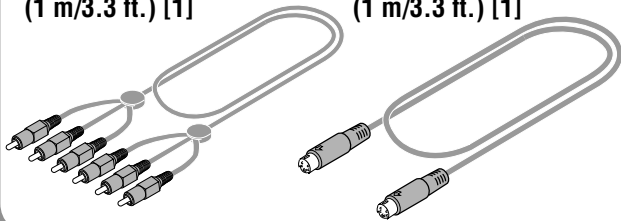

Lens cap (attached to the lens of the unit) [1]

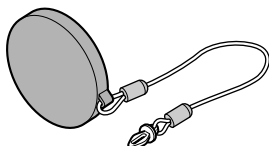

About the lens cap

The lens cap is fixed on the bottom of the unit as shown in the illustration below.

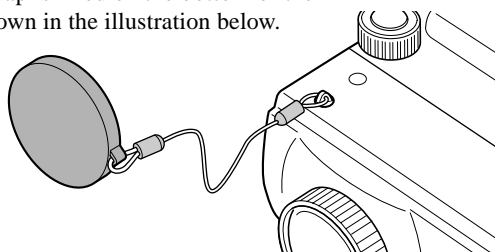

Carrying case [1]



How to use the carrying case

Packing the unit

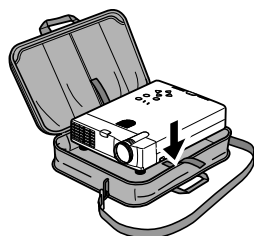

Packing the accessories



USER'S MANUAL
(this manual) [1]

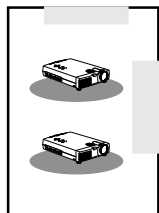

Quick Start Guide [1]

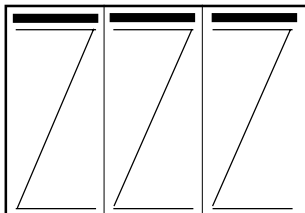

Inserting the batteries

① Press firmly and slide the battery cover off.

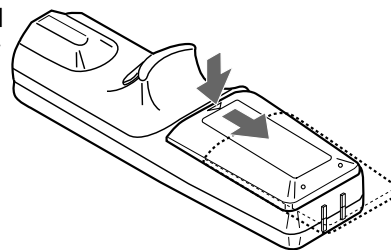

② Insert the two supplied batteries (size AA/R6). Ensure that the polarities (+ and -) of the batteries are aligned correctly.

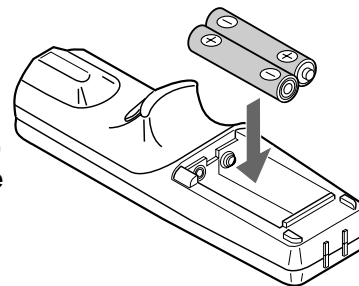

③ Slide the cover back until it snaps into place.

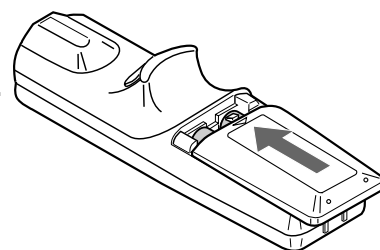

Notes

- If the remote control gets wet, wipe it dry immediately.
- Avoid excessive heat and humidity.
- If you will not be using the remote control for a long time, remove the batteries.
- Do not mix new and old or different types of batteries.
- There are operations that can only be carried out by remote control. Handle the remote control carefully.

Remote control effective range

The remote sensors are located on the front and back of the unit. The controllable range is 50 degrees horizontally and 30 degrees vertically relative to a line that is at a right angle to the remote sensor. And the distance between the point of the remote control and remote sensor must be shorter than four meters (13 feet).

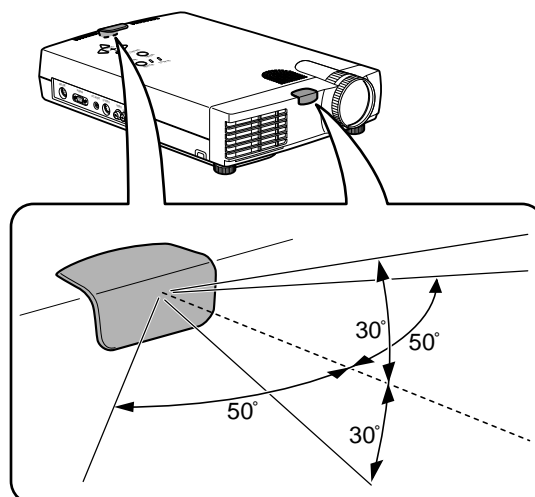

Parts and controls

For operational instructions, refer to the page indicated in brackets.

Top, front and side panel view

Control panel

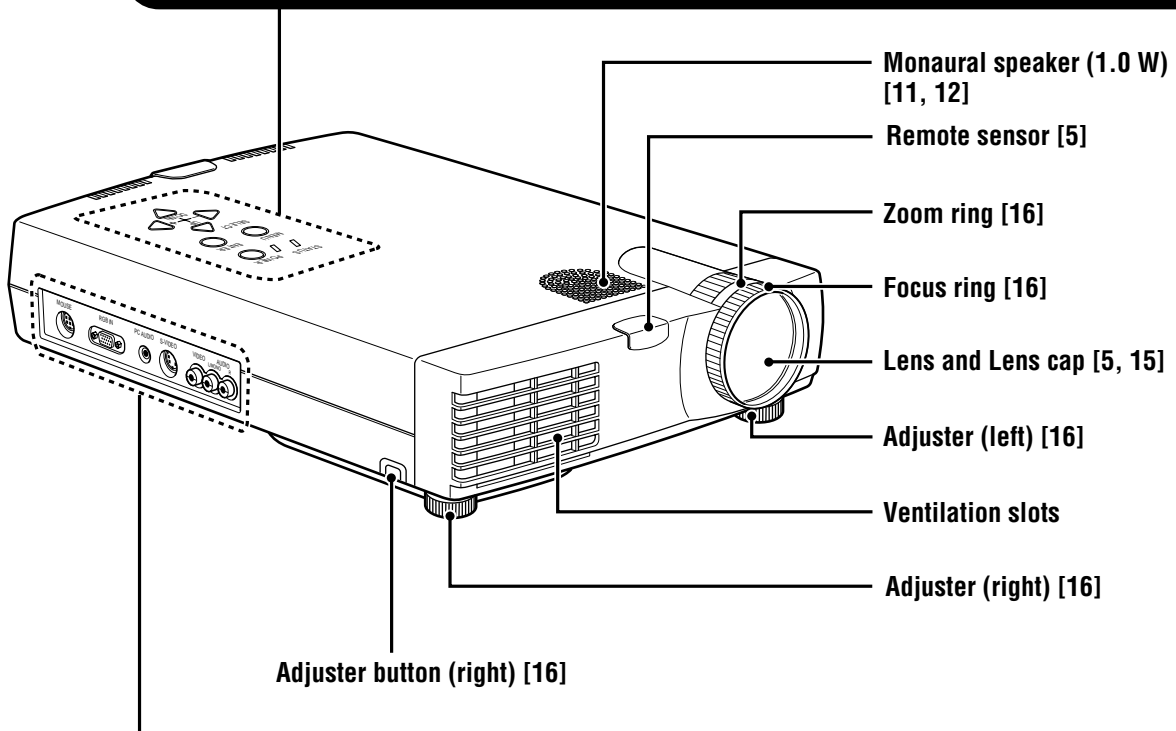
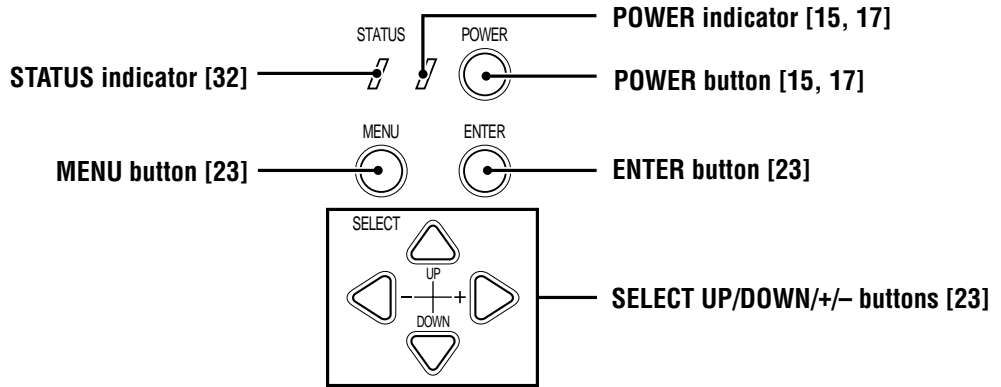

Terminal Panel

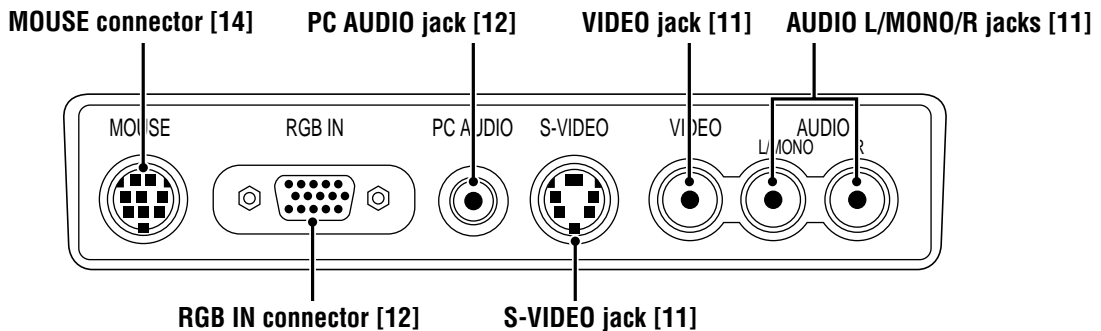

Rear and side panel view

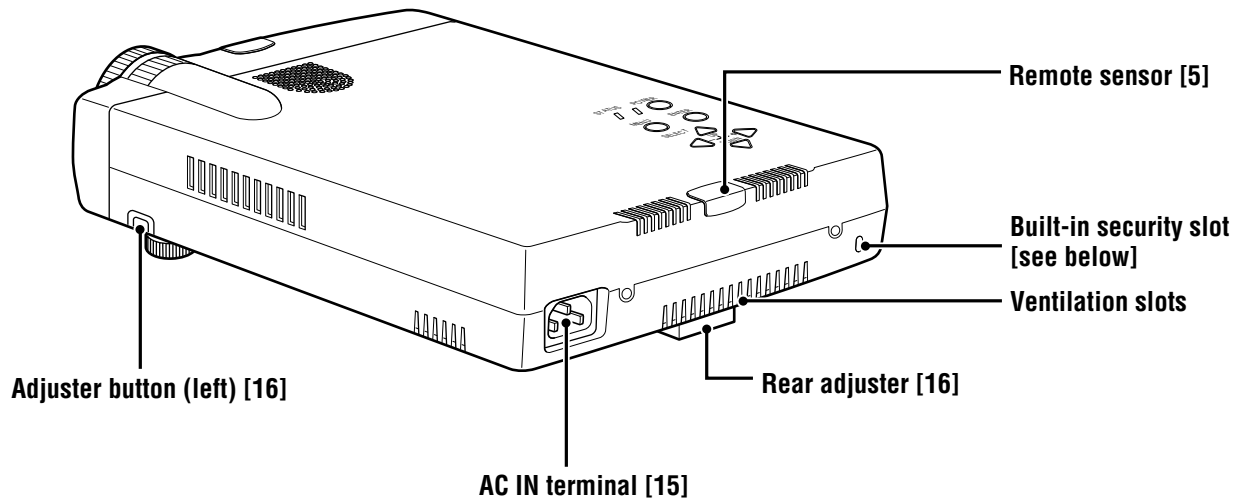

Built-in Security Slot



This security slot supports the MicroSaver® Security System. MicroSaver® is a registered trademark of Kensington Microware Inc. The logo  is trademarked and owned by Kensington Microware Inc.

Bottom

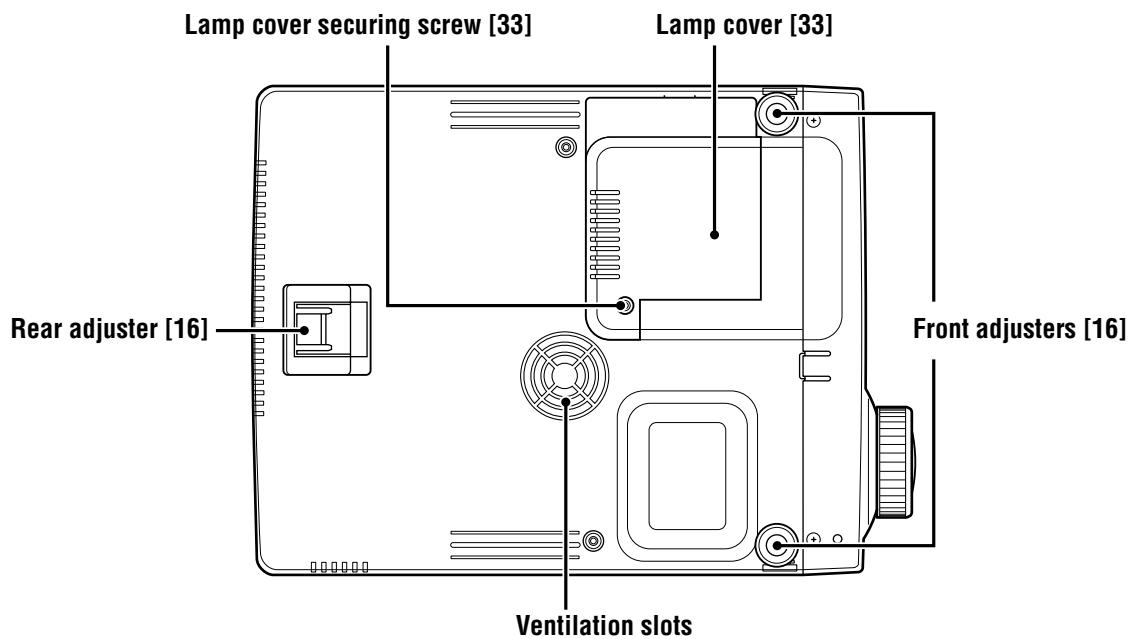

(Continued on next page.)

Remote control

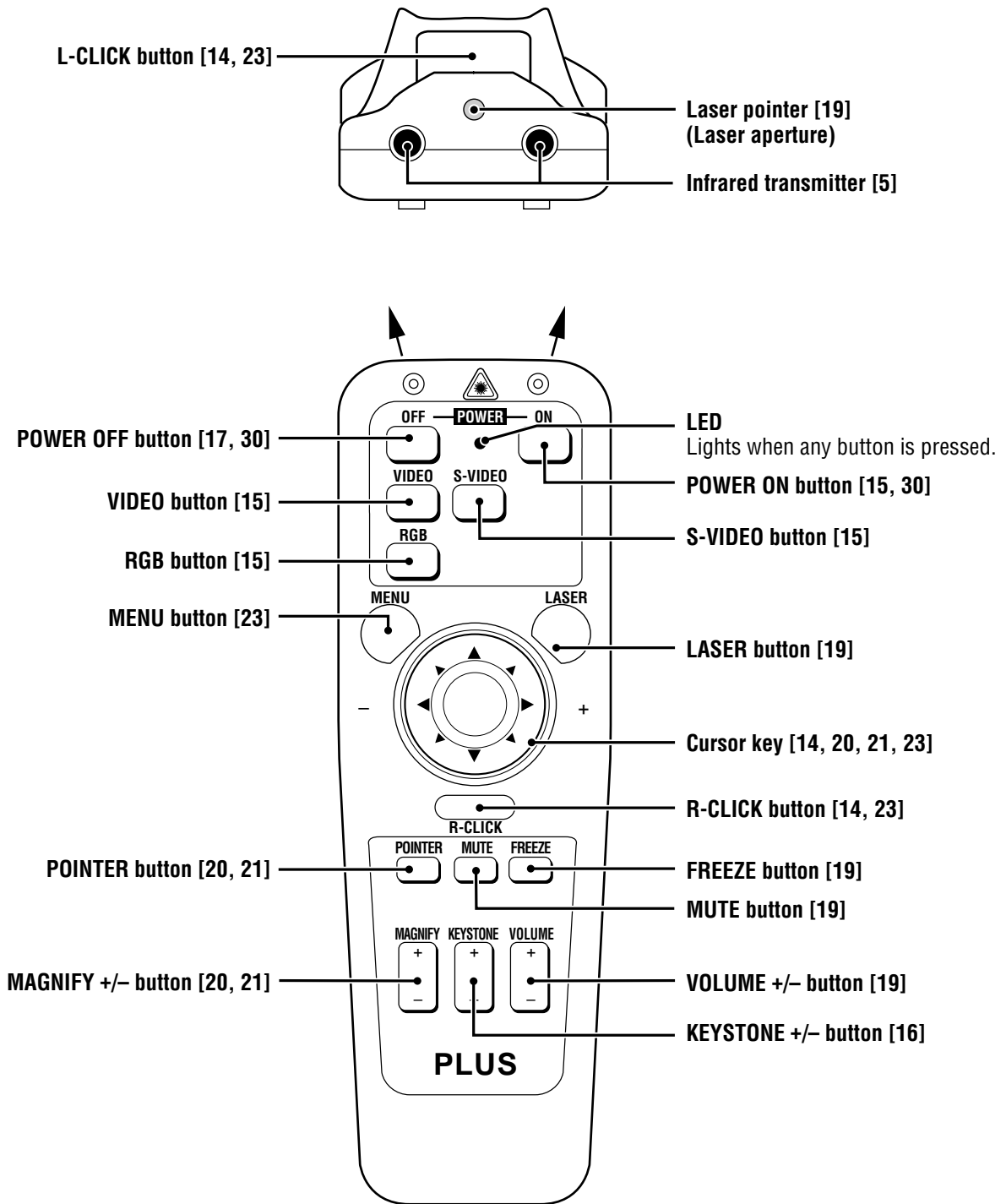

Installation

The distance from the unit lens to the screen determines to the size of the projected image, therefore, you need to consider the place where you set up the unit and screen before making connections. You also need to consider the screen size and height of the unit and screen as other important factors.

Tip

A non-glossy wall may be used as a substitute for a screen.

⚠ WARNING

• **Carrying the unit**

Always carry the unit in the carrying case. Ensure that the power cable and any other cables connecting to video sources are disconnected before moving the unit. When moving the unit or when it is not in use, cover the lens with the lens cap.

- Only use the unit on a solid flat level surface. If the unit falls to the ground, you may be injured and the unit may severely be damaged.
- Do not use the unit where temperatures vary greatly. The unit must be used at temperatures between 5°C (41°F) and 35°C (95°F).
- Do not expose the unit to moisture, dust, or smoke. This will harm the screen image.
- Ensure that you have adequate ventilation around the unit to allow heat dissipation. Do not cover the vents on the bottom or the side of the unit.

Positioning the unit

The projected image becomes larger as the distance between the unit and screen increases. The minimum image size is about 25 inches diagonally at a distance of about 1.2 m (approx. 3.9 feet) and the maximum size is approx. 300 inches at a distance of 12.3 m (approx. 40.4 feet) from the screen. Use the following information when you fix the position of the unit.

Projecting distance and image size

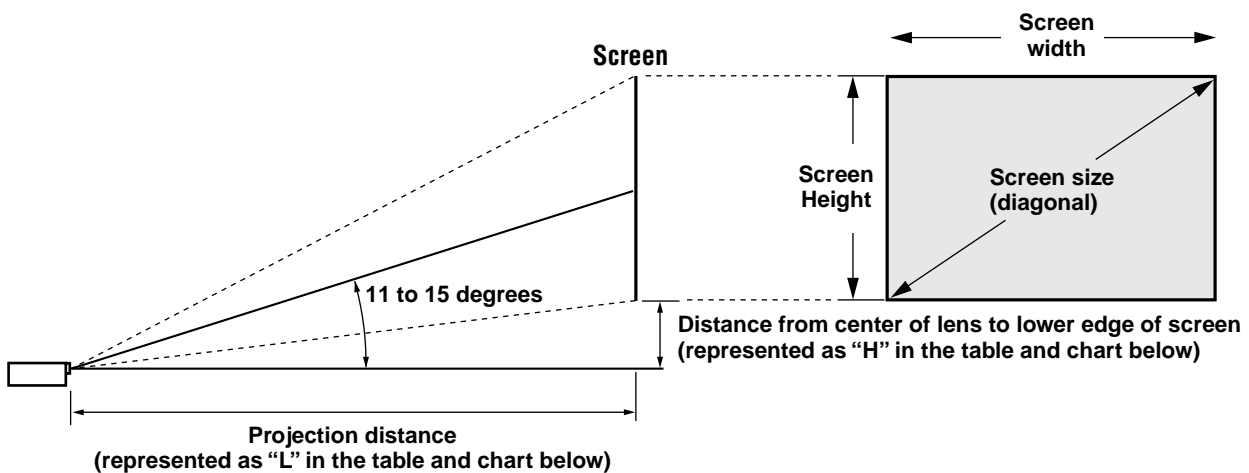

• **Horizontal projection position** — Lens centered left to right

• **Vertical projection position (U2-1130)**

| Screen size | Projection distance (L) | | Dimension (H) cm |
|-------------|-------------------------|---------------|------------------|
| | Wide (W) | Telephoto (T) | Both W & T |
| Inches | m / feet | m / feet | cm / inch |
| 25 | — | 1.2 / 3.9 | 7.4 / 2.9 |
| 40 | 1.6 / 5.2 | 1.9 / 6.2 | 11.9 / 4.7 |
| 60 | 2.4 / 7.9 | 2.9 / 9.5 | 17.8 / 7.0 |
| 80 | 3.2 / 10.5 | 3.9 / 12.8 | 23.7 / 9.3 |
| 100 | 4.0 / 13.1 | 4.9 / 16.1 | 29.7 / 11.7 |
| 120 | 4.9 / 16.1 | 5.8 / 19.0 | 35.6 / 14.0 |
| 150 | 6.0 / 19.7 | 7.3 / 24.0 | 44.5 / 17.5 |
| 200 | 8.1 / 26.6 | 9.8 / 32.2 | 59.3 / 23.3 |
| 240 | 9.8 / 32.2 | 11.7 / 38.4 | 71.2 / 28.0 |
| 300 | 12.3 / 40.4 | — | 89.0 / 35.0 |

(Continued on next page.)

Installation (continued)

• Projecting distance and image size

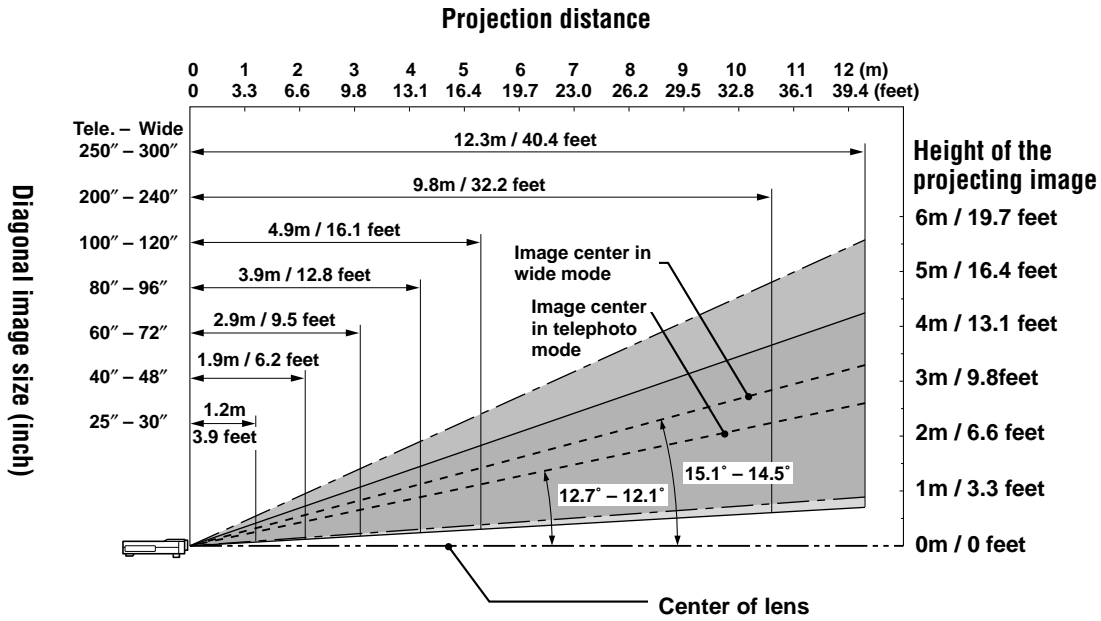

Using the ceiling mounting fixtures

When using the ceiling hanging fixtures, select "FRONT/CEILING" in "PROJECTION" of "SETTING MENU" (see pages 17 and 24).

Note

Installing the unit on the ceiling must be performed by qualified PLUS service personnel. Contact your PLUS dealer for more information. Never attempt to install the unit yourself.

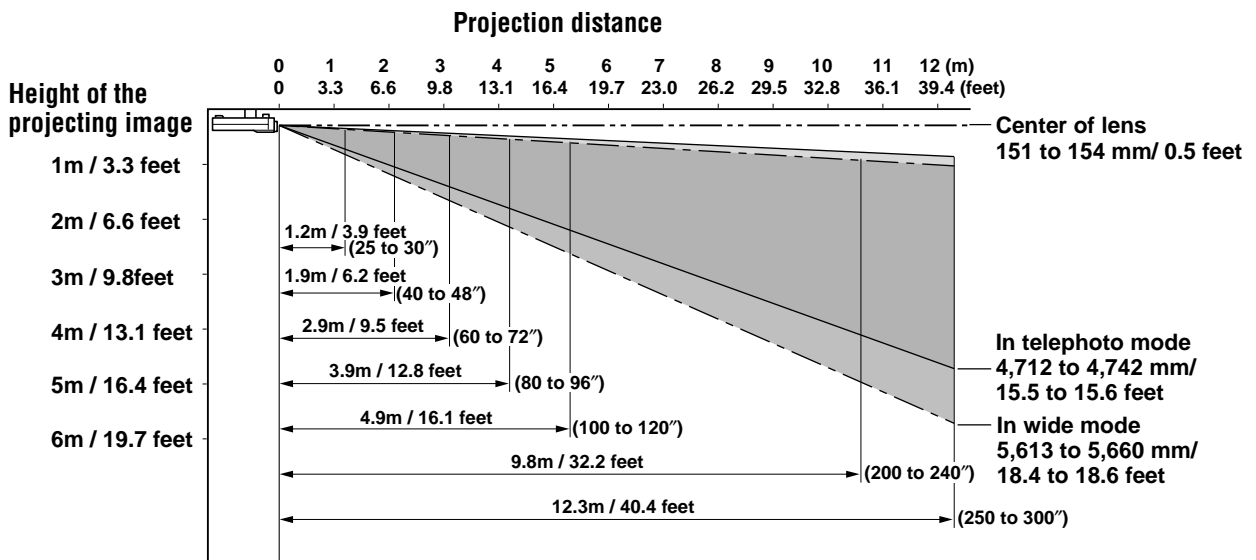

Connecting video equipment

You can connect up to two pieces of video equipment to the unit following the illustrations below.

- You can switch the input source (picture) to VIDEO or S-VIDEO when you connect two pieces of equipment. (The S-VIDEO connection provides more vivid color and higher resolution compared to the VIDEO connection.)
- You can output the sound of only one component through the unit speaker even when two components are connected.

Before connecting

- Turn off the components that are to be connected.
- The unit and computer will be turned on in "Using the unit" on page 15. Do not turn on either the computer or the unit until you read this section.
- Please also refer to the manual of the video component to be connected.

Connection to the VIDEO jack of the unit

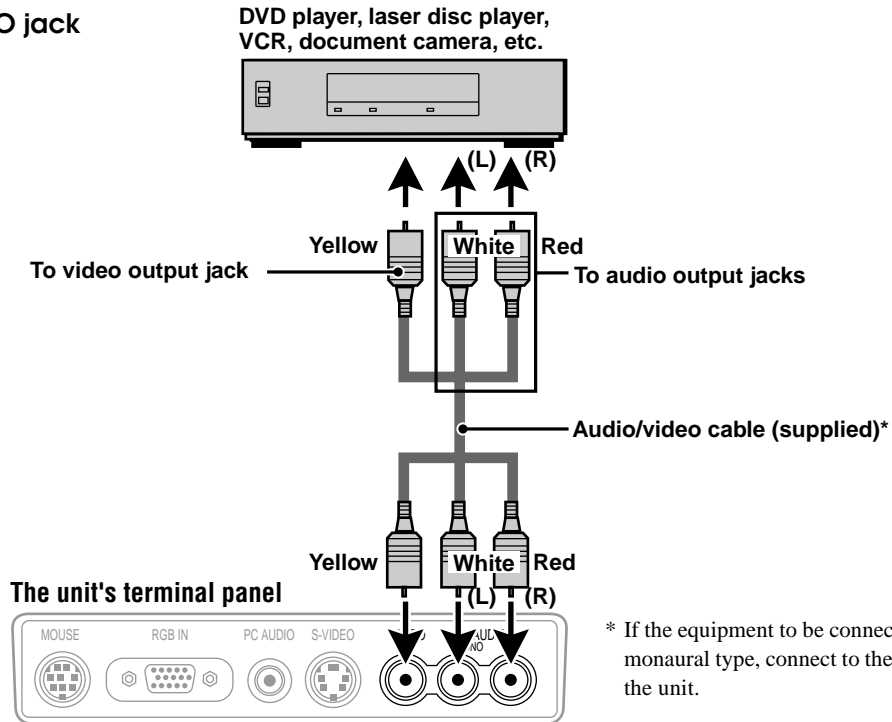

Connection to the S-VIDEO jack of the unit

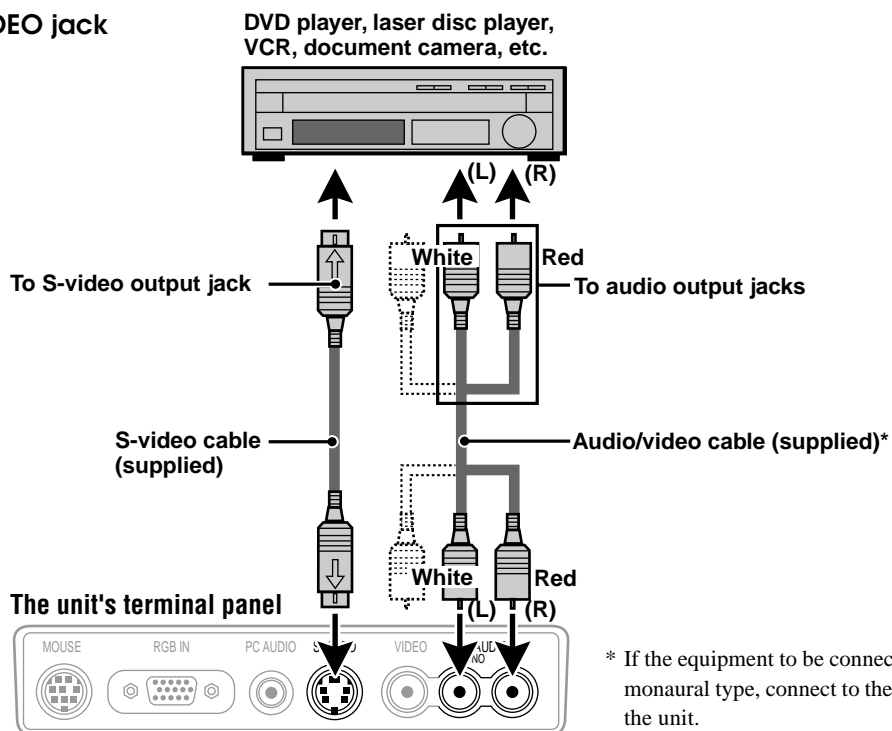

Connecting a PC or Macintosh

Connecting a PC or Macintosh to the unit will enable you to project your computer screen images for impressive presentations.

- The following display standards are supported:

| | |
|--------------------------|-----------------------|
| VGA 640×480 for graphics | SuperVGA 800×600 |
| VGA 640×350 for graphics | XGA 1024×768 |
| VGA 720×350 for text | Macintosh at 640×480 |
| VGA 640×400 for graphics | Macintosh at 832×624 |
| VGA 720×400 for text | Macintosh at 1024×768 |

- A PC, Macintosh, or computer equipped with an XGA adapter or compatible graphics adapter can easily be connected.
- If your PC does not support XGA you will need to install an XGA graphics board. Consult your computer's owner's manual for your XGA configuration. If you need to install a new board, refer to the manual supplied with your new graphics board for installation instructions.

Notes

- Refer to the owner's manual supplied with your computer for more information about the video output requirements of the computer and any special identification or configuring required by the projector image and monitor.
- Some Macintosh PowerBooks may need to set the mirroring to off to output 1024 × 768 dot signals. Please consult your PowerBook manual or computer dealer for details.

Before connecting

- Turn off the computer that is to be connected.
- The unit and computer will be turned on in "Using the unit" on page 15. Do not turn on either the computer or the unit until you read this section.
- Please also refer to the manual of the computer to be connected.

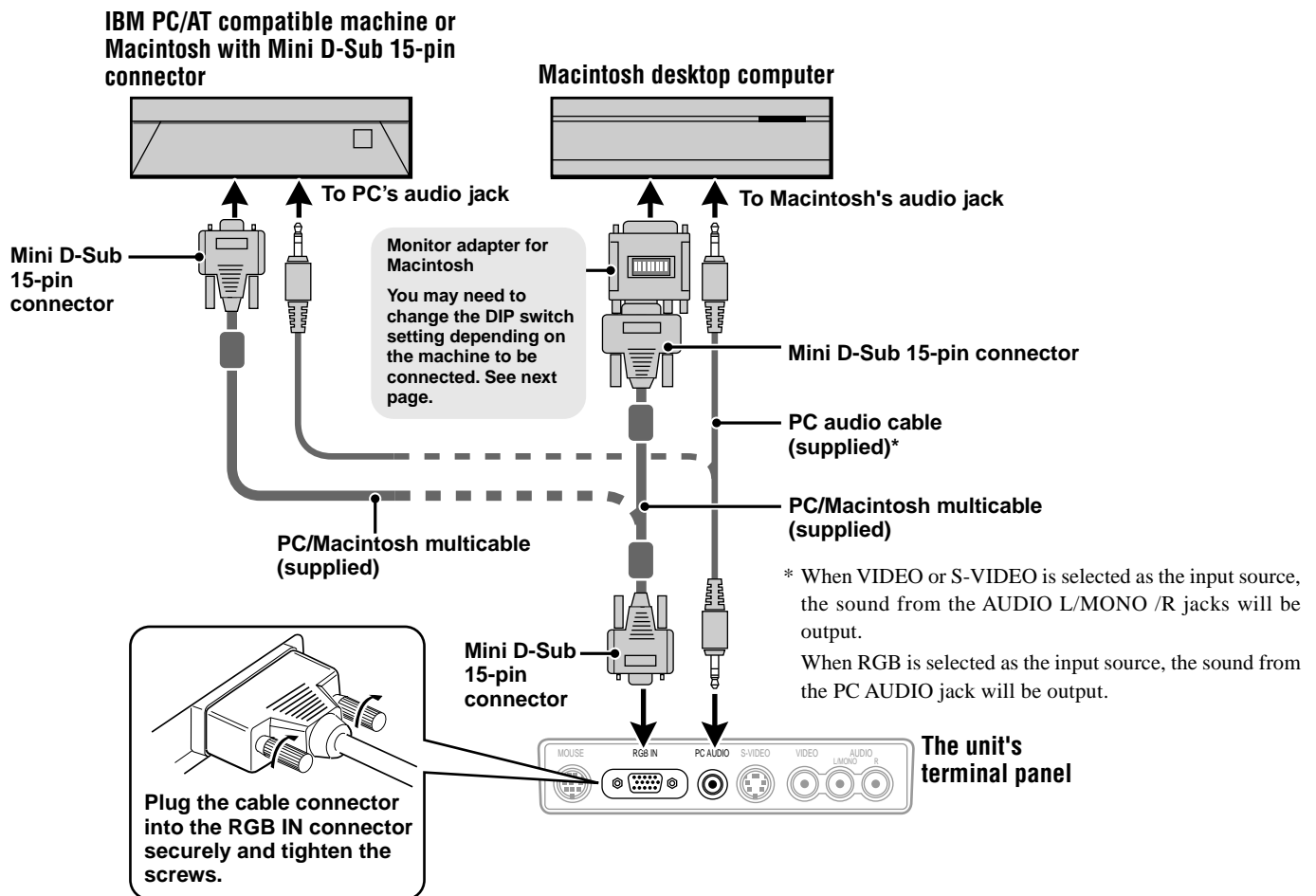

Note on the PowerBook connection

Depending on the model of your PowerBook, the additional Apple video cable adapter may be required with the above connection.

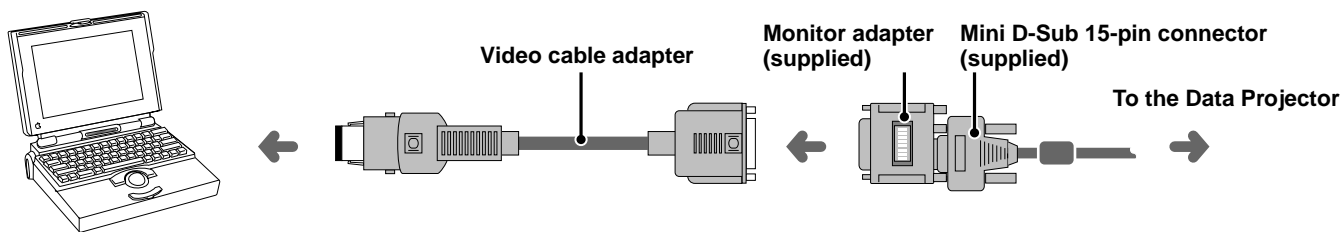

Modifying the DIP switch setting (for Macintosh)

Modify the DIP switch setting according to the DIP switch setting table below.

DIP switch setting (● = ON)

| MONITOR | RESOLUTION | 1 | 2 | 3 | 4 | 5 | 6 |
|------------------|------------|---|---|---|---|---|---|
| MULTIPLE SCAN 21 | | ● | ● | | | | ● |
| MULTIPLE SCAN 17 | | ● | ● | | | ● | |
| MULTIPLE SCAN 16 | | ● | ● | | | ● | ● |
| VGA/S-VGA | | | | ● | ● | | |
| 21" COLOR | 1152x870 | ● | ● | ● | ● | | |
| 19" COLOR | 1024x768 | | ● | ● | | | |
| 16" COLOR | 832x624 | | ● | | ● | | |
| 13" COLOR | 640x480 | ● | ● | | | | |

Inch 13

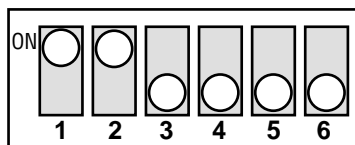

MULTIPLE SCAN 17

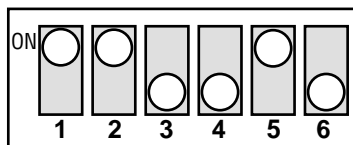

VGA/S-VGA/XGA/SXGA

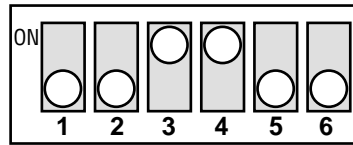

Using the remote control as a computer mouse - Wireless mouse function

The supplied remote control enables you to operate the computer's mouse functions by connecting the computer to the MOUSE connector of the unit. It is a great way to control your computer-generated presentations.

How does the remote control operate the computer?

- The cursor key on the remote control operates the computer mouse functions.
- If a computer running Windows is connected, the L-CLICK button on the remote control operates as the computer mouse left click button and the R-CLICK button as the computer mouse right click button.
- If a Macintosh computer is connected, the L-CLICK and R-CLICK buttons operate in the same way as the computer mouse click button.
- While the menu is displayed on the screen (see page 22, 23), the cursor key, L-CLICK and R-CLICK buttons will operate to control the menu.

Connecting the computer to the MOUSE connector of the unit

Before connecting

- Turn off the computer, then remove the current mouse.
- The unit and computer will be turned on as described in "Using the unit" on page 15. Do not turn on either the computer or the unit until you read that section.
- Please also refer to the manual of the computer to be connected.

How to connect to the IBM PC/AT computer

Use the supplied serial mouse cable to connect the MOUSE connector of the unit and the 9-pin serial port (COM1/COM2/COM3/COM4) of the computer.

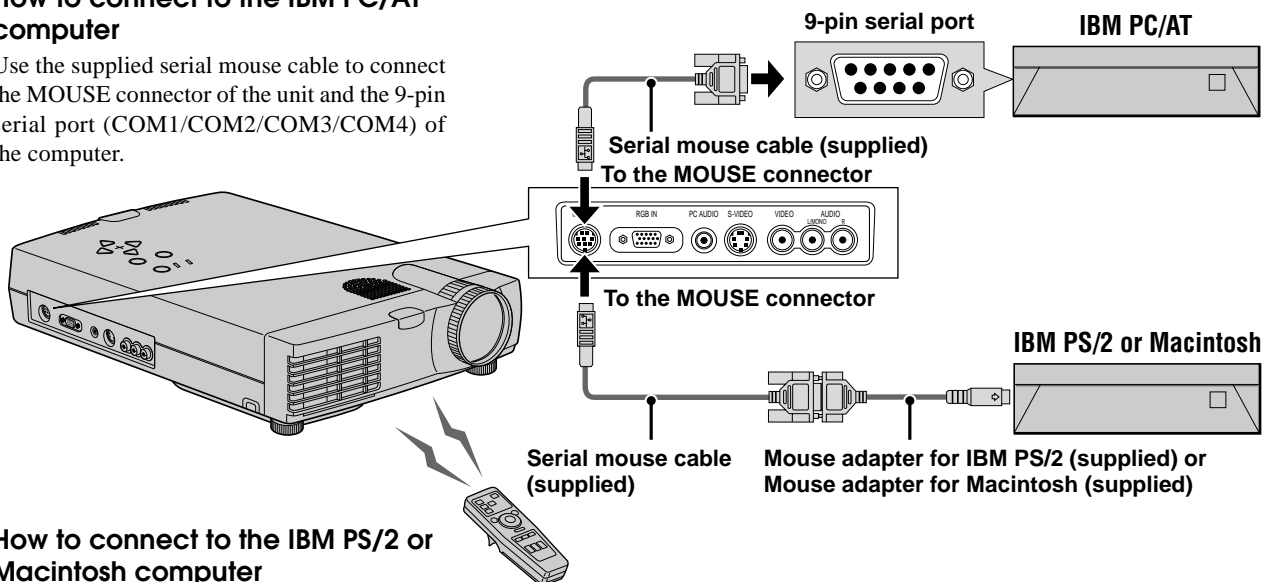

How to connect to the IBM PS/2 or Macintosh computer

Use the supplied serial mouse cable and mouse adapter (for IBM PS/2 or Macintosh).

- 1 Connect the serial mouse cable and mouse adapter.
- 2 Connect the other end of the serial mouse cable to the MOUSE connector of the unit.
- 3 Connect the other end of the mouse adapter to the mouse port of the computer.

Using the unit

Before starting

- Remove the lens cap from the lens. Please keep it because it must be replaced after use.
- Don't use the unit in a bright room and don't expose the screen to direct sunlight or other strong light sources.

1 Connect the supplied power cable to the unit, then to the wall outlet (the mains). The POWER indicator on top of the unit lights in amber.

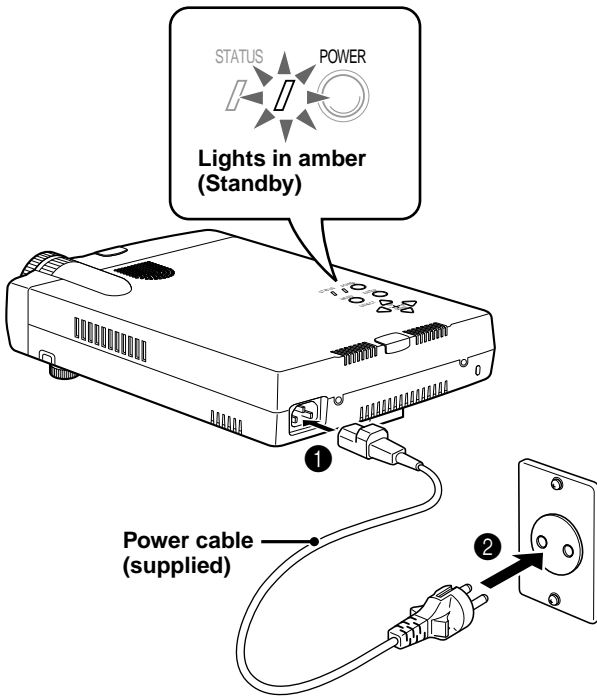

2 Press **POWER ON** on the remote control, or **POWER** on top of the unit, to turn on the unit.

The POWER indicator on top of the unit turns to green and starts flashing. It takes one minute for the unit to be ready for use. Wait until the indicator stops flashing and lights steadily in green.

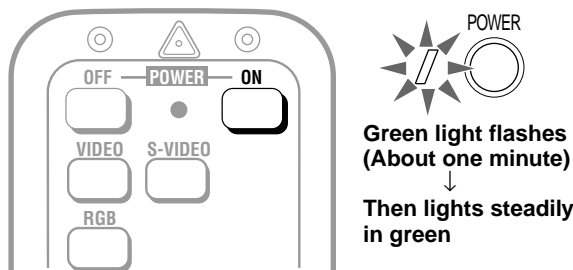

Note

While the POWER indicator is flashing, the unit doesn't turn off even if you press POWER OFF on the remote control, or POWER on the unit.

Tip

If you set "AUTO START" to "ON" in the menu (see page 29), the unit will turn on automatically after connecting the power cable in step 1.

3 Turn on the connected source (computer, VCR, DVD player, etc.).

If you use a video component, start playback for screen/image adjustment.

4 Press either **VIDEO**, **S-VIDEO**, or **RGB** to select the input source.

You can also select the input source with the menu operation (see page 23).

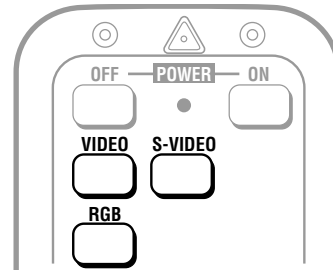

Notes

- If the blue or black screen (the background type differs depending on the "BACKGROUND" setting. See page 25.) is projected, check the following:
 - Is the source properly connected to the unit?
 - Is the source component or computer turned on?
 - Are the video signals coming to the unit?
- The video resolution of the connected computer can be changed. See page 18.

5 Adjust the position and height of the unit.

Move the unit to the position where the projected image is horizontally centered to the screen.

• **When the projected image is offset horizontally**

Adjust the position of the unit so that the unit is square to the screen.

View from the top

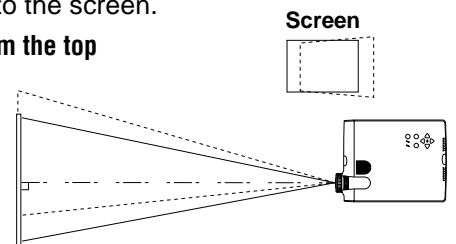

• **When the projected image is offset vertically**

Adjust the height balance of the unit with the adjusters. See next page.

Side view

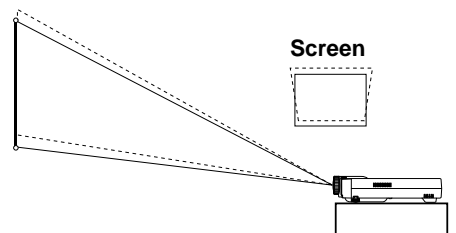

(Continued on next page.)

Using the unit (continued)

Using the adjusters to adjust the height balance

There are two front adjusters and one rear adjuster.

- 1 If you need to lower the position of the projected image, pull out the leg of the rear adjuster.
- 2 Hold the front sides of the unit, then adjust the height of the projected image.

While adjusting the height, the rear adjuster should remain on the table.

- 3 Press the left and right buttons by the front adjusters at the same time to loosen the adjuster legs.

The front adjuster legs will loosen and be extended.

- 4 Release the buttons to fix the position of the front adjuster legs.

- 5 To fine-adjust the height and balance, turn each foot of the front adjuster legs.

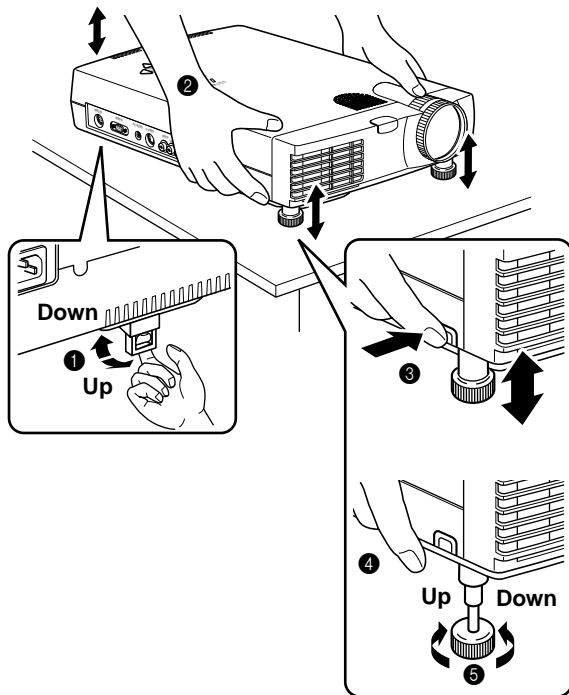

6 (If the vertical offset cannot be adjusted completely with the adjusters)

Press **KEYSTONE +** or **-** to correct the offset (keystoning) image.

You can also correct the keystoning effect with the menu operation (see page 24).

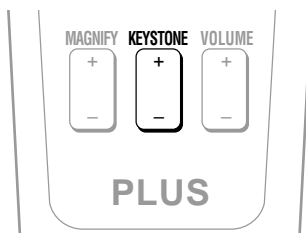

Note

The maximum correction value is 29° including the optical correction value.

Adjusting the distorted picture

The upper distortion of the picture will be corrected as you see the illustration below.

The menu screen shape is not changed by the keystone correction even when displayed.

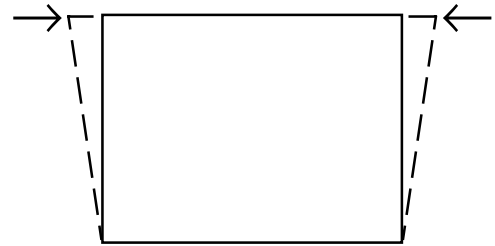

7 Adjust the image size with the zoom ring, then adjust the focus with the focus ring.

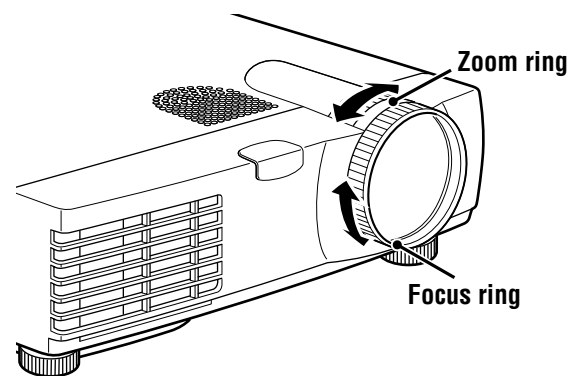

8 Change the unit setting to suit the method and source selected in step 4.

The following settings can be made using the menu operation.

The menu can be displayed in English, Deutsch, Français, Italiano, Español, Svenska, or 日本語. (The standard setting is English.) See page 24.

- For basic menu operation, see page 23.
- To see an overview of the menu structure, see page 22.

• Select the type of projection

If the projected image is horizontally reversed or upside down, change the projection type.

See page 24.

• When the input source is VIDEO or S-VIDEO

Select the color system. See page 24.

• When the input source is RGB

Adjust the projected image from the computer. The resolution most suitable for the incoming signals is automatically selected.

However, if any vertical banding, noise, dot interference, or crosstalk appears on the screen, manually adjust "PICTURE ADJ," then "FINE PICTURE" using the menus. See page 27.

The horizontal and vertical positions of the image can also be adjusted manually. See page 27.

If you have set "AUTO MODE" to "OFF" to carry out the above described adjustments (see page 27 for details), you can choose to project the image at the original size of the incoming signal resolution. (Normally, the image is enlarged or reduced to the most suitable size automatically.) See page 27.

9 Adjust the picture elements (see page 28), then select the picture type according to the video content (see page 28).

10 Start using the unit.

The following functions are available while using the unit:

- Adjusting the volume of the unit's speaker (see pages 19 and 25),
- Using the laser pointer (see page 19),
- Turning off the image and muting the sound temporarily (see page 19),
- Freezing a moving picture (see page 19),
- Enlarging the picture (see page 20), and
- Enlarging the picture after selecting the portion you wish to enlarge (see page 21).

Note

If "POWER OFF" is set to "ON" (see page 29), the image will be turned off if the unit has been left unoperated for five minutes with an RGB input source.

If the image is suddenly turned off while projecting a computer image, the computer's screen saver or power management function may be activated.

After using the unit

1 Press POWER OFF on the remote control, or POWER on the unit, for two to three seconds.

When you have turned off the unit, the POWER indicator will start flashing then turn to amber in one minute.

Never disconnect the power cable while the POWER indicator is flashing.

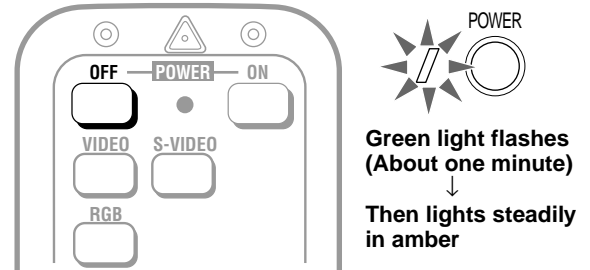

Notes

- Neither POWER ON on the remote control nor POWER on the unit operate while the POWER indicator is flashing.
- Wait at least one minute before turning on the unit again. POWER ON on the remote control or POWER on the unit may not operate if you try to turn on the unit again within one minute after turning off the unit.

2 After the POWER indicator stops flashing and turns to amber, disconnect the power cable from the wall outlet, then from the unit.

The POWER indicator goes out.

Note

Hold the plug when disconnecting the power cable. Never pull the cord.

(Continued on next page.)

Changing the computer's video resolutions

Depending on your computer's graphics capability, you may be able to select one of several resolutions. Generally a computer—either a PC or Macintosh— with 1 MB VRAM will generally run:

640 × 480 at 16.7 million colors (24 bit Truecolor)

800 × 600 at 65,000 colors.

1024 × 768 at 256 colors.

As the resolution increases, the number of colors you can run decreases. With 2 MB VRAM a computer will generally run:

640 × 480 at 16.7 million colors (24 bit Truecolor).

800 × 600 at 16.7 million colors (24 bit Truecolor).

1024 × 768 at 65,000 colors.

1280 × 1024 at 256 colors.

Windows 98/Windows 95

There are two methods you can use to change your resolution.

Method 1

- 1 Move your cursor to the background image and click.
- 2 In the “Properties” menu, select “Settings.”
- 3 Change your resolution and click “OK.”
- 4 You may be asked to reboot for the changes to take effect, or a message may appear saying that “Windows is about to resize your display.” You'll be asked if you want to keep your settings. Select “Yes.”

Method 2

- 1 Click on your “My Computer” icon.
- 2 Open “Control Panel” and select “Display.”
- 3 Change your resolution and click “OK.” after the new resolution is selected.
- 4 You may be asked to reboot for the changes to take effect, or a message may appear saying that “Windows is about to resize your display.” You'll be asked if you want to keep your settings. Select “Yes.”

Windows 3.1

- 1 Click on the “Main” icon and open “Control Panel.”
- 2 Select “Change System Settings” and click on “Option.”
- 3 Choose “Change Display Settings.”
- 4 Select the resolution you want.
- 5 Choose the current or desired drive.
- 6 Restart Windows for the changes to take effect.

Macintosh

- 1 Under the Apple menu, select “Control Panels” and open “Monitors.”
- 2 Click and open “Options.”
- 3 Select your new resolution and click “OK.”

Notebook computers and resolution standards

The unit is designed to project industry standardized video such as VESA (Video Electronics Standards Association) or XGA (eXtended Graphics Array). Notebook computers do not use industry standards. They use whatever timing is necessary to match their local LCD display. The end result is typically not standard. By turning off your notebook's display, the timing parameters are a bit more like the real VESA or XGA signal.

Various functions while using the unit

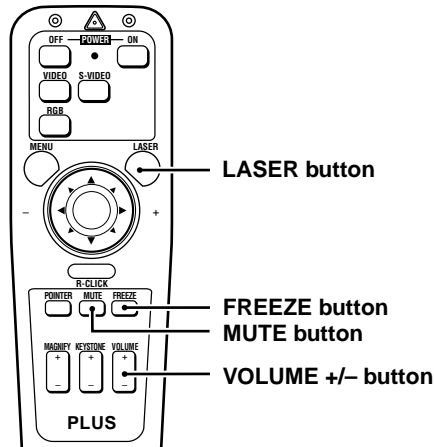

Adjusting the volume of the unit's speaker

Press **VOLUME +** to increase the volume or **-** to decrease.

The volume can also be adjusted using the menu (see page 25).

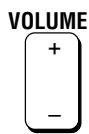

Turning off the image and muting the sound temporarily

Press **MUTE**.

The image turns off and the sound is muted at the same time. To restore the picture and sound, press the button again.



Using the laser pointer

You can highlight the desired point on the screen with a beam of red light.

⚠ Caution

- Do not look into the laser pointer while it is on, nor point the laser beam at any other persons. This could result in serious eye damage or blindness.
- Use of controls or adjustments or performance other than those specified herein may result in hazardous radiation exposure.

Press **LASER**.

The red light is on while pressing the button.

The light goes out when you release the button.



Freezing a moving picture

You can capture the desired frame of a moving picture.

Press **FREEZE**.

A still image of the current frame is displayed. To restore the present picture, press the button again.



Tip

The still picture can also be enlarged (see pages 20 and 21).

(Continued on next page.)

Various functions while using the unit(continued)

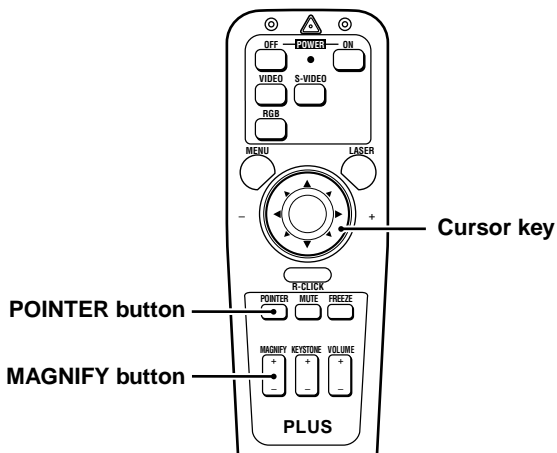

Enlarging the picture

You can enlarge the picture up to four times the original size.

Press MAGNIFY +.

While the button is pressed the picture is enlarged until it becomes four times the original size.

Release the button at the desired size.

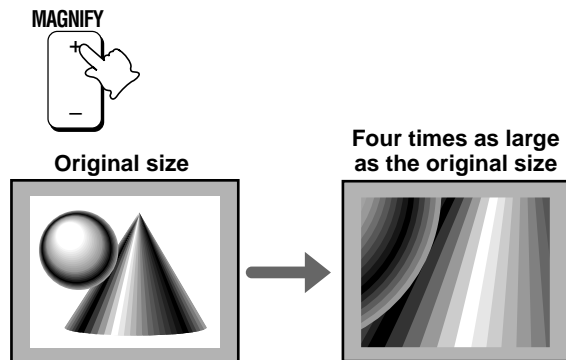

Note

The quality of the enlarged picture deteriorates compared to the original size picture.

To reduce the size of the enlarged picture

Press MAGNIFY -.

While the button is pressed the picture is reduced until it becomes the original size.

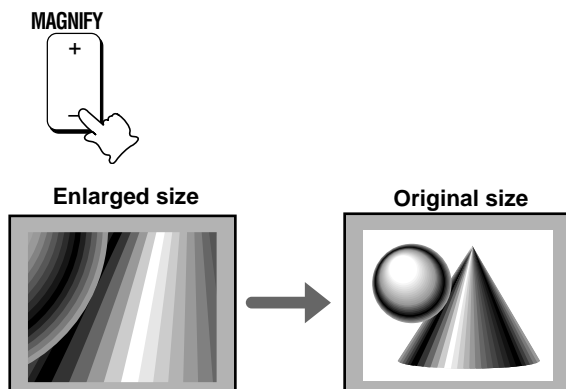

To move to the desired portion of the enlarged picture

1 Press POINTER.

The button lights in red. If you don't proceed to step 2 within ten seconds, the button goes off.

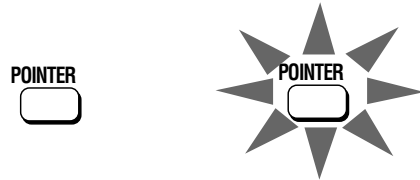

2 Press the desired portion of the cursor key while POINTER is lit.

The available directions are indicated by the eight triangle marks on the cursor key. The picture will move in the direction of the mark you are pressing.

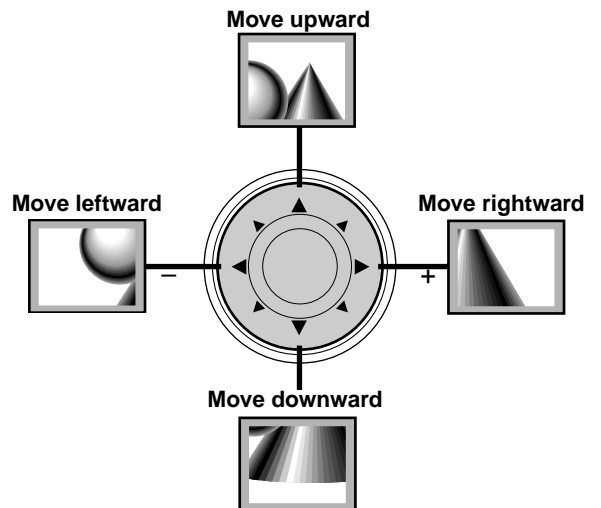

Note

The original size of the picture cannot be moved because the whole image is fully displayed.

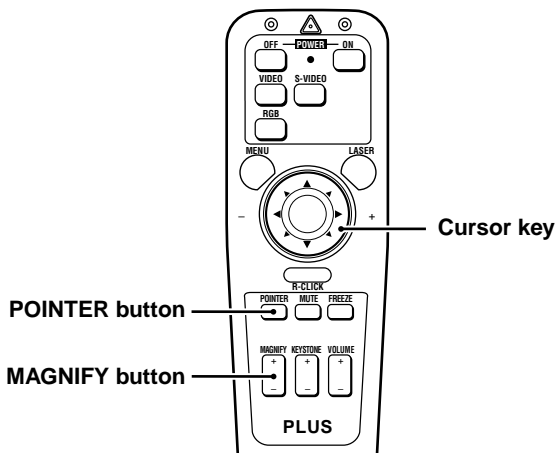

Enlarging the picture after selecting the portion you wish to enlarge

After selecting the portion you wish to enlarge, you can enlarge the picture up to four times the original size.

1 While the picture is projected at its original size, press POINTER.

The button lights in red, then the pointer is displayed on the screen.

If you don't proceed to step 2 within ten seconds, the button goes off.

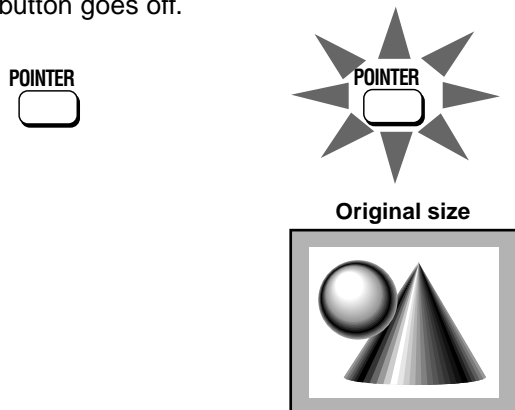

Note

You can also display the pointer on the menu screen. See page 25.

You can select from among eight pointers using the menu. See page 25.

2 Press the desired portion of the cursor key to move the pointer while POINTER is lit.

The available directions are indicated by the eight triangle marks on the cursor key. The pointer will move in the direction of the mark you are pressing.

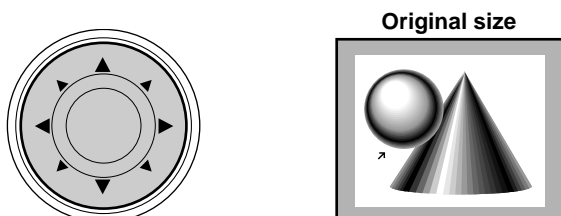

3 Press MAGNIFY +.

While the button is pressed, the picture is enlarged until it becomes four times the original size.

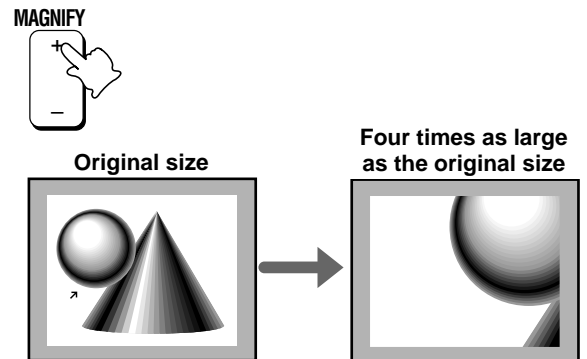

Note

The quality of the enlarged picture deteriorates compared to the original size picture.

To reduce the size of the enlarged picture

Press MAGNIFY -.

While the button is pressed, the picture is reduced until it becomes the original size.

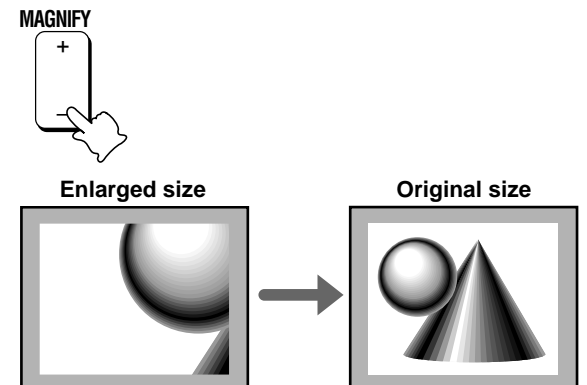

Menu structure

For operational instructions, refer to the page indicated in brackets.

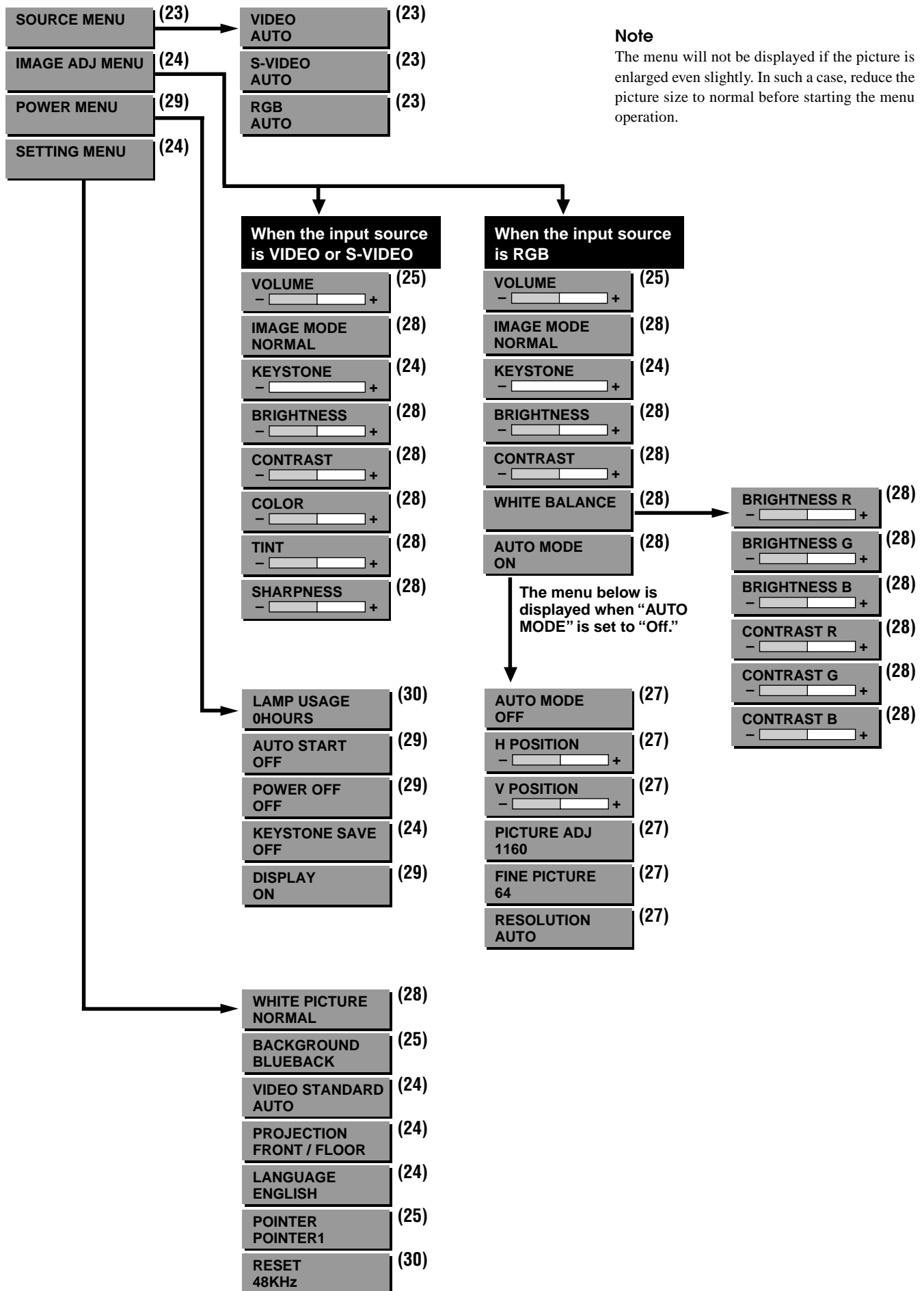

Basic operation (Selecting the input source)

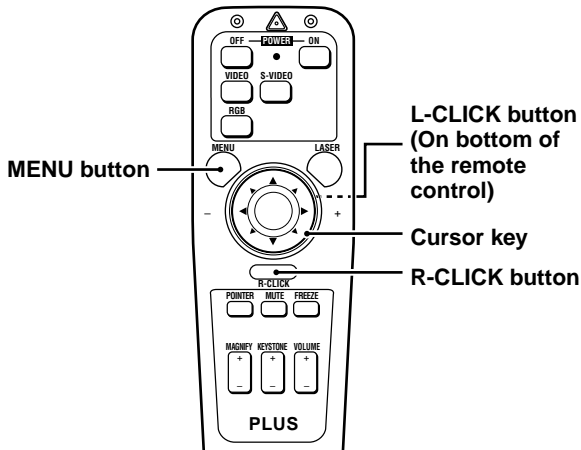

1 Press MENU.
The button lights in red and the main menu appears on the screen.
If you don't proceed to step 2 within ten seconds, the button goes off.



Note
The menu will not be displayed if the picture is enlarged even slightly. In such a case, reduce the picture size to normal before starting the menu operation.



2 Press the cursor ▲ / ▼ key to select "SOURCE MENU."

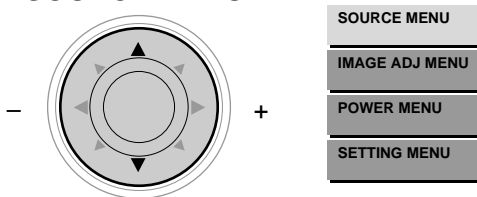

3 Press L-CLICK.
The source menu appears on the screen.



4 Press the cursor ▲ / ▼ key to select the desired input source.

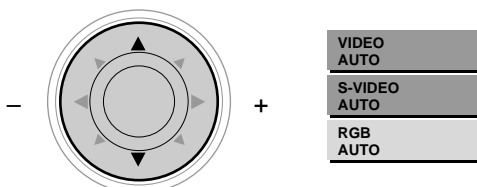

5 Press L-CLICK.
The source you've selected in step 4 is confirmed, then the picture from the selected source is projected on the screen.



6 Press R-CLICK to turn off the menu display.
Whenever you wish to turn off the menu display, press the R-CLICK button.



Operating using the unit

The menu operation is explained using the remote control, however, it can also be controlled using the unit operation buttons. To operate using the unit, refer to the comparison table below.

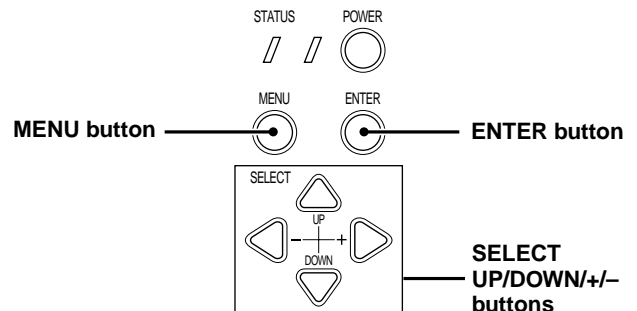

The remote control and unit button comparison table

| Remote control buttons | Unit operation buttons |
|--|---|
| MENU The main menu appears on the screen when you press this button. To turn off any menu, press R-CLICK . | MENU The main menu appears on the screen when you press this button. To turn off any menu, press R-CLICK on the remote control. (You cannot turn off the menu with the unit's button.) |
| Cursor ▲ / ▼ keys Press either key to select the menu item. | SELECT UP/DOWN Press either button to select the menu item. |
| Cursor + / - keys Press either key to choose the setting or value of the selected menu item. | SELECT + / - Press either button to choose the setting or value of the selected menu item. |
| L-CLICK Press this button whenever confirmation is required. | ENTER Press this button whenever confirmation is required. |

Correcting the keystone effect

The keystone correction function can be used if the vertical offset cannot be completely adjusted with the adjusters (see page 16).

The unit retains the correction value even if you select another input source after keystoneing unless you turn off the unit.

This correction can also be made with KEYSTONE +/- on the remote control (see page 16).

- 1 Press MENU to display the main menu.
- 2 Press the cursor ▲/▼ keys to select “IMAGE ADJ MENU.”
- 3 Press L-CLICK to display the IMAGE ADJ MENU.
- 4 Press the cursor ▲/▼ keys to select “KEystone.”
- 5 Press the cursor +/- keys to correct the offset image.

For more information, see page 16.

Saving the corrected value

The keystoneing value returns to the standard settings after the power of the unit is turned off. To keep the corrected value for the next use of the unit, set “KEYSTONE SAVE” to “ON.”

- 1 After keystoneing, press MENU to display the main menu.
- 2 Press the cursor ▲/▼ keys to select “POWER MENU.”
- 3 Press L-CLICK to display the POWER MENU.
- 4 Press the cursor ▲/▼ keys to select “KEYSTONE SAVE.”
- 5 Press the cursor + key to select “ON.”

Selecting a projection type

This reorients your image for your type of projection.

- 1 Press MENU to display the main menu.
- 2 Press the cursor ▲/▼ keys to select “SETTING MENU.”
- 3 Press L-CLICK to display the SETTING MENU.
- 4 Press the cursor ▲/▼ keys to select “PROJECTION.”
- 5 Press the cursor + / - keys to select the projection type which suits the unit setup conditions.

The following four projection types can be selected:

- FRONT FLOOR (Normal),
 - REAR CEILING (Upside down and horizontally reversed),
 - REAR FLOOR (Horizontally reversed), or
 - FRONT CEILING (Upside down).
- 6 Press L-CLICK.

Selecting a menu language

- 1 Press MENU to display the main menu.
- 2 Press the cursor ▲/▼ keys to select “SETTING MENU.”
- 3 Press L-CLICK to display the SETTING MENU.
- 4 Press the cursor ▲/▼ keys to select “LANGUAGE,” then press the cursor + / - keys to select one of the following languages:
 - ENGLISH (English),
 - DEUTSCH (German),
 - FRANÇAIS (French),
 - ITALIANO (Italiano),
 - ESPAÑOL (Spanish),
 - SVENSKA (Swedish), or
 - 日本語 (Japanese).
- 5 Press L-CLICK.

Selecting the color system

The unit can be changed to the following color systems:

- NTSC 3.58
 - PAL (except for the PAL-M and PAL-N systems)*
 - SECAM
 - NTSC 4.43
- * The unit cannot project the PAL-M and PAL-N systems.

If your color system is NTSC 3.58 or PAL, select “AUTO” (factory setting).

If your color system is SECAM or NTSC 4.43, select “SECAM” or “4.43NTSC.”

- 1 Press MENU to display the main menu.
- 2 Press the cursor ▲/▼ keys to select “SETTING MENU.”
- 3 Press L-CLICK to display the SETTING MENU.
- 4 Press the cursor ▲/▼ keys to select “VIDEO STANDARD.”
- 5 Press the cursor +/- keys to select the color system.
- 6 Press L-CLICK to change the unit to the selected color system.

Selecting the pointer type

If you press **POINTER** on the remote control while the picture is projected at its original size, the pointer is displayed on the screen (see page 21).

You can select from among eight pointers.

- 1 Press **MENU** to display the main menu.
- 2 Press the cursor **▲/▼** keys to select “**SETTING MENU.**”
- 3 Press **L-CLICK** to display the **SETTING MENU.**
- 4 Press the cursor **▲/▼** keys to select “**POINTER.**”
- 5 Press the cursor **+/-** keys to select one of the following eight pointer types.
- 6 Press **L-CLICK** to confirm the pointer type.

Selecting the background

- 1 Press **MENU** to display the main menu.
- 2 Press the cursor **▲/▼** key to select “**SETTING MENU.**”
- 3 Press **L-CLICK** to display the **SETTING MENU.**
- 4 Press the cursor **▲/▼** key to select “**BACKGROUND.**”
- 5 Press the cursor **+ / -** key to select one of the following background types:
 - **BLUEBACK** or
 - **BLACKBACK.**
- 6 Press **L-CLICK.**

Adjusting the volume

The last adjusted volume will not be changed if you change the input source from **S-VIDEO** to **VIDEO**, and vice versa. But the volume for **RGB** is independently set.

The volume can also be adjusted with **VOLUME +/-** on the remote control (see page 19).

- 1 Press **MENU** to display the main menu.
- 2 Press the cursor **▲/▼** keys to select “**IMAGE ADJ MENU.**”
- 3 Press **L-CLICK** to display the **IMAGE ADJ MENU.**
- 4 Press the cursor **▲/▼** keys to select “**VOLUME,**” then press the cursor **+ / -** keys to adjust the volume.

Adjusting the projected image from the computer

The unit selects the most suitable resolutions as shown in the “Timing Chart” below according to the incoming signals from the RGB IN connector when “AUTO MODE” is set to “ON.” (See page 27). However, you may need manual adjustment depending on the computer. If you have any vertical banding, noise, dot interference, or crosstalk on the projected picture, adjust the clock frequency with “PICTURE ADJ” then the clock phase with “FINE PICTURE” (see page 27). You can also adjust the horizontal and vertical position of the image (see page 27). When adjusting manually (when “AUTO MODE” is set to “OFF”), you can choose to project the image at the original size of the incoming signal resolution (see page 27). (Normally, the image is enlarged or reduced to the most suitable size automatically.)

Timing Chart

| | Resolution | H Sync. (kHz) | V Sync. (Hz) |
|-------------------------------------|-------------|---------------|--------------|
| IBM PC/AT compatible machine | 640 × 350 | 31.5 | 70.1 |
| | 640 × 350 | 37.9 | 85.1 |
| | 720 × 350 | 31.5 | 70.0 |
| | 640 × 400 | 31.5 | 70.1 |
| | 640 × 400 | 37.9 | 85.1 |
| | 720 × 400 | 31.5 | 70.0 |
| | 720 × 400 | 37.9 | 85.0 |
| | 640 × 480 | 31.5 | 60.0 |
| | 640 × 480 | 37.9 | 72.8 |
| | 640 × 480 | 37.5 | 75.0 |
| | 640 × 480 | 43.3 | 85.0 |
| | 800 × 600 | 35.2 | 56.3 |
| | 800 × 600 | 37.9 | 60.3 |
| | 800 × 600 | 46.9 | 75.0 |
| | 800 × 600 | 48.1 | 72.2 |
| | 800 × 600 | 53.7 | 85.1 |
| | 1024 × 768 | 48.4 | 60.0 |
| | 1024 × 768 | 56.5 | 70.1 |
| | 1024 × 768 | 58.1 | 72.0 |
| | 1024 × 768 | 60.0 | 75.0 |
| 1024 × 768 | 68.7 | 85.0 | |
| 1280 × 1024 | 64.0 | 60.0 | |
| 1280 × 1024 | 80.0 | 75.0 | |
| Apple Macintosh | 640 × 480 | 35.0 | 66.7 |
| | 832 × 624 | 49.7 | 74.5 |
| | 1024 × 768 | 60.2 | 74.9 |
| | 1152 × 870 | 68.7 | 75.6 |
| | 1280 × 1024 | 81.1 | 76.1 |
| Sun | 1152 × 900 | 61.8 | 66.0 |
| | 1280 × 1024 | 74.9 | 69.9 |
| | 1280 × 1024 | 81.1 | 76.1 |
| SGI | 1024 × 768 | 49.7 | 60.4 |
| | 1280 × 1024 | 63.9 | 60.0 |
| | 1152 × 900 | 71.7 | 76.1 |
| HP | 1280 × 1024 | 78.1 | 72.0 |

Note on AccuBlend™

The resolution of the unit is 1024 × 768. Other resolution images (e.g. 1280 × 1024) are compressed into 1024 × 768 (AccuBlend). In such a case, projected letters and lines might appear unevenly.

Adjusting the clock frequency (PICTURE ADJ) and clock phase (FINE PICTURE) manually

When "AUTO MODE" is set to "ON," the clock frequency and clock phase will be adjusted automatically. However, if you need any manual adjustment for these two items, you first need to set "AUTO MODE" to "OFF" as indicated in the following steps.

Adjust the clock frequency to eliminate any vertical banding, then the clock phase to reduce any video noise, dot interference, or cross talk. (When the clock phase is not matched evenly, the image appears to be shimmering.)

1 Setting the input source to "RGB"

Select the RGB input source (see page 15 or 23).

2 Setting "AUTO MODE" to "OFF" for manual adjustment

- 1 Press MENU to display the main menu.
- 2 Press the cursor ▲/▼ keys to select "IMAGE ADJ MENU."
- 3 Press L-CLICK to display the IMAGE ADJ MENU.
- 4 Press the cursor ▲/▼ keys to select "AUTO MODE."
- 5 Press the cursor – key to select "OFF," then press L-CLICK.

The AUTO MODE OFF menu appears.

3 Adjusting the clock frequency

- 1 Press the cursor ▲/▼ keys to select "PICTURE ADJ."
- 2 Press the cursor – key until the vertical banding disappears.
Press + to increase the frequency and – to decrease.

4 Adjusting the clock phase

- 1 Press the cursor ▲/▼ keys to select "FINE PICTURE."
- 2 Press the cursor +/- keys until the video noise, dot interference, and cross talk are reduced.
Press + to increase the phase and – to decrease the phase.

If the image (and the menu) disappears while setting the clock frequency or clock phase

Carry out the following steps.

- 1 Turn off the source connected to the RGB IN connector.
The incoming signals from the source go down and a blue or black screen will be displayed. (The background type differs depending on the "BACKGROUND" setting. See page 25.)
- 2 Carry out "Resetting to the factory settings" on page 30.
- 3 Turn on the source, then carry out "Adjusting the clock frequency and clock phase manually" from the beginning.

When you have connected another computer

Set "AUTO MODE" to "ON" by pressing the cursor + key in step 2-5 above.

Adjusting the horizontal (H POSITION) and vertical (V POSITION) position of the image

- 1 Carry out steps 1 and 2 in the left column.
- 2 Press the cursor ▲/▼ keys to select "H POSITION."
- 3 Press the cursor +/- keys to adjust the horizontal position.
Press + key to move the image right and – key to move it left.
- 4 Press the cursor ▲/▼ keys to select "V POSITION."
- 5 Press the cursor +/- keys to adjust the vertical position.
Press + keys to move the image up and – key to move it down.

Adjusting the image size automatically/ Displaying the image at its original size

Normally the unit enlarges or reduces the image from the computer to the most suitable size, however, you can choose to project the image at the original size of the incoming signal resolution.

- 1 Carry out steps 1 and 2 in the left column.
- 2 Press the cursor ▲/▼ keys to select "RESOLUTION."
- 3 Press the cursor +/- keys to select "AUTO" or "REAL MODE."
When adjusting the size of the image automatically, select "AUTO."
When displaying the image at its original size, select "REAL MODE."
- 4 Press L-CLICK to confirm the setting in step 3.

Adjusting the picture elements

The picture elements such as brightness, contrast, white balance, and so on can be adjusted individually for each input source. The adjustable items vary depending on the input source.

(The elements marked with "●" are adjustable.)

| | Input source | |
|----------------------|---------------|-----|
| | VIDEO/S-VIDEO | RGB |
| BRIGHTNESS | ● | ● |
| CONTRAST | ● | ● |
| COLOR | ● | - |
| TINT | ● | - |
| SHARPNESS | ● | - |
| WHITE BALANCE | - | ● |

- 1 Select the input source (see page 15 or 23).
- 2 Press MENU to display the main menu.
- 3 Press the cursor ▲/▼ keys to select "IMAGE ADJ MENU."
- 4 Press L-CLICK to display the IMAGE ADJ MENU.
- 5 Press the cursor ▲/▼ keys to select "BRIGHTNESS," then press the cursor +/- keys to adjust the brightness.
- 6 Press the cursor ▲/▼ keys to select "CONTRAST," then press the cursor +/- keys to adjust the contrast.

When the input source is VIDEO or S-VIDEO

- 7 Press the cursor ▲/▼ keys to select "COLOR," then press the cursor +/- keys to adjust the color.
- 8 Press the cursor ▲/▼ keys to select "TINT," then press the cursor +/- keys to adjust the tint.

Note

The tint control doesn't operate with a PAL or SECAM source.

- 9 Press the cursor ▲/▼ keys to select "SHARPNESS," then press the cursor +/- keys to adjust the sharpness.

When the input source is RGB

- 7 Press the cursor ▲/▼ keys to select "WHITE BALANCE," then press L-CLICK.

The WHITE BALANCE menu appears.

- 8 Press the cursor ▲/▼ keys to select each item in the WHITE BALANCE menu, then press the cursor +/- keys to adjust the item for the white color balance.

Selecting the picture type

Selecting the brightness or color oriented image setting

The brightness oriented setting may be suitable for PC images and the color oriented setting may be suitable for movie pictures. In this way, you can focus on either brightness or color.

This setting is applied to all input sources regardless of the present input source.

- 1 Press MENU to display the main menu.
- 2 Press the cursor ▲/▼ keys to select "SETTING MENU."
- 3 Press L-CLICK to display the SETTING MENU.
- 4 Press the cursor ▲/▼ keys to select "WHITE PICTURE," then press the cursor +/- keys to select the white picture mode.

The following two types can be selected:

- NORMAL to set the unit to the brightness oriented setting or
- QUIET to reduce brightness for better color expression,

- 5 Press L-CLICK to confirm the setting.

Selecting the color preference

After selecting the brightness or color oriented image setting, you can set the color preference individually for each input source according to the video content and your preferences.

- 1 Select the input source (see page 15 or 23).
- 2 Press MENU to display the main menu.
- 3 Press the cursor ▲/▼ keys to select "IMAGE ADJ MENU."
- 4 Press L-CLICK to display the IMAGE ADJ MENU.
- 5 Press the cursor ▲/▼ keys to select "IMAGE MODE," then press the cursor +/- keys to select the gamma mode.

The following three types of gamma modes can be selected according to your preferences:

- NORMAL,
- NATURAL 1, or
- NATURAL 2.

Activating the power saving function

This function operates only with an RGB input source.

If there are no input signals from the RGB IN connector for more than five minutes, the unit will automatically turn off and enter the standby mode.

- 1 Press MENU to display the main menu.
- 2 Press the cursor ▲/▼ keys to select "POWER MENU."
- 3 Press L-CLICK to display the POWER MENU.
- 4 Press the cursor ▲/▼ keys to select "POWER OFF," then press the cursor + key to select "ON" to activate the power saving function.

To deactivate the function, set "POWER OFF" to "OFF" by pressing the cursor – key.

Activating the on-screen function

The factory setting of this function is "ON."

When the function is activated, the source menu appears on the screen in the following cases:

- The source menu appears for three seconds when you select the input source with the remote control, and
- The source menu appears for approximately twenty seconds when you turn on the unit.

- 1 Press MENU to display the main menu.
- 2 Press the cursor ▲/▼ keys to select "SETTING MENU."
- 3 Press L-CLICK to display the SETTING MENU.
- 4 Press the cursor ▲/▼ keys to select "DISPLAY," then press the cursor + key to select "ON" to activate the on-screen function.

To deactivate the function, set "DISPLAY" to "OFF" by pressing the cursor – key.

Quick-starting the unit

The unit can be turned on by only connecting the power cable (see page 15) if you set "AUTO START" to "ON." There is no need to press POWER ON on the remote control or POWER on the unit after "AUTO START" is activated to turn on the unit.

- 1 Press MENU to display the main menu.
- 2 Press the cursor ▲/▼ keys to select "POWER MENU."
- 3 Press L-CLICK to display the POWER MENU.
- 4 Press the cursor ▲/▼ keys to select "AUTO START," then press the cursor + key to select "ON" to activate the function.

To deactivate the function, set "AUTO START" to "OFF" by pressing the cursor – key.

Checking hours of lamp usage

The lamp cartridge must be replaced after 1000 hours of usage. When 1000 hours have elapsed the STATUS indicator will light in red (see page 32). Periodically check the hours of lamp usage in the menu so that you will have time to purchase a new lamp cartridge before the old one burns out.

- 1 Press MENU to display the main menu.
- 2 Press the cursor ▲/▼ keys to select "POWER MENU."
- 3 Press L-CLICK to display the POWER MENU.
- 4 Press the cursor ▲/▼ keys to select "LAMP USAGE."

The lamp usage hours will be displayed.

Resetting the lamp usage hours to zero

You need to reset the lamp usage hours to zero after replacing the lamp cartridge (see page 33).

- 1 Carry out the steps above.
- 2 Press POWER ON on the remote control for more than ten seconds.
"LAMP USAGE" will be reset to zero and the STATUS indicator will go off (see page 32).

If the unit doesn't turn on because lamp usage exceeds 1100 hours.

The unit is designed not to turn on after the lamp usage has exceeded 1100 hours. (If the unit is in use, it will go off.) If this happens you must replace the lamp cartridge with a new one immediately. After replacing the lamp cartridge, you need to reset the lamp usage hours to zero to enable you to turn on the unit.

- 1 Connect the power cable (see step 1 on page 15).
- 2 Press POWER OFF on the remote control for more ten seconds.
"LAMP USAGE" will be reset to zero and the STATUS indicator will go off (see page 32).

Resetting to the factory settings

The following items can be reset to the standard settings.

- H POSITION
- V POSITION
- PICTURE ADJ
- FINE PICTURE
- BRIGHTNESS
- CONTRAST
- COLOR
- TINT
- SHARPNESS
- WHITE BALANCE

Although the above items for the particular input source are stored in memory when setting the value, the items for all input sources will be reset regardless of the input source when resetting.

- 1 Press MENU to display the main menu.
- 2 Press the cursor ▲/▼ keys to select "SETTING MENU."
- 3 Press L-CLICK to display the SETTING MENU.
- 4 Press the cursor ▲/▼ keys to select "RESET."
The horizontal frequency appears under "RESET" when the present input source is RGB.
- 5 Press the cursor + key for more than three seconds.
"COMPLETED" appears under the title "RESET" after the reset is complete.

Troubleshooting

This section helps you resolve problems you may encounter while setting up or using the unit.

Common Problems & Solutions

| <i>Problem</i> | <i>Remedy</i> |
|--|---|
| <i>Does not turn on</i> | <ul style="list-style-type: none"> • Check that the power cable is properly connected to the unit and wall outlet (the mains). (See page 15). • Check the STATUS indicator to see if the unit has overheated or the lamp usage has exceeded 1100 hours. (See page 32.) |
| <i>No picture</i> | <ul style="list-style-type: none"> • Check that you have selected the proper input source you wish to project. (See pages 15 and 32.) • Ensure all the cables are connected properly. (See pages 11 to 13.) • Adjust the brightness and contrast. (See page 28.) • Remove the lens cap. (See page 15.) • Is the POWER indicator flashing? (See page 15.) • Is the STATUS indicator flashing? (See page 32.) |
| <i>Image isn't square on the screen</i> | <ul style="list-style-type: none"> • Reposition the unit to improve its angle on the screen. (See pages 15 and 16.) • Is the vertical offset properly corrected using the keystone function? (See page 16). |
| <i>Picture is blurred</i> | <ul style="list-style-type: none"> • Adjust the focus. (See page 16.) • Reposition the unit to improve its angle to the screen. (See pages 15 and 16.) • Ensure that the distance between the unit and screen is within the adjustment range of the lens. (See pages 9 and 10.) |
| <i>Remote control does not work</i> | <ul style="list-style-type: none"> • Replace the dead batteries with new ones. (See page 5). • Make sure there is no obstacle between the remote control and the unit. • Stand within 4m (13 feet) of the unit. (See page 5.) |
| <i>The STATUS indicator is lit or flashing</i> | See the STATUS indicator message chart on the next page. |
| <i>Cross color appears in RGB mode</i> | <ul style="list-style-type: none"> • If "AUTO MODE" is set to "ON," set it to "OFF" then manually adjust the clock frequency and clock phase. (See page 27.) • If "AUTO MODE" is set to "OFF," set it to "ON." (See page 27.) |

When the STATUS indicator lights or flashes

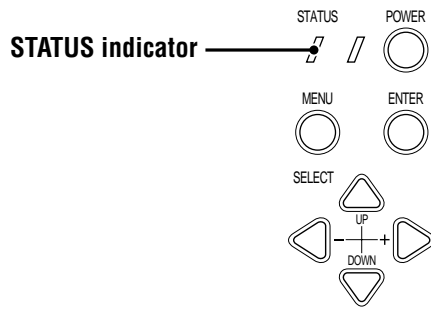

Status Light Messages

| <i>Condition</i> | <i>Status</i> |
|--|--|
| <i>OFF</i> | <i>Normal</i> |
| <i>On Continually</i> | <i>The lamp usage has exceeded 1000 hours of operation and should be replaced.</i> |
| <i>Flashing Very Rapidly (On and off in a cycle of 1 sec.)</i> | <ul style="list-style-type: none"> • <i>The lamp cover is not correctly attached. Replace it correctly.</i> |
| <i>Flashing Rapidly (On and off in a cycle of 4 sec.)</i> | <ul style="list-style-type: none"> • <i>The temperature protector has been triggered. If the room temperature is high, move the unit to a cool location. If the temperature within the unit is high, check the cooling fan ventilation slots and the ventilation slots on the bottom of the unit. If any of the slots are blocked, remove whatever is blocking them.</i> • <i>The temperature protector has been triggered. If you try to turn on the unit immediately after turning off, sometimes the power does not come on. If this happens, wait at least one minute, then turn on the unit again.</i> • <i>The lamp lighting voltage error detection protector has been triggered. Wait at least one minute before turning on the unit again. If this does not solve the problem, please contact your dealer.</i> |
| <i>Flashing Slowly (On and off in a cycle of 8 sec.)</i> | <i>The cooling fan has stopped. Contact your PLUS dealer for service.</i> |
| <i>Flashing Very Slowly (On and off in a cycle of 12 sec.)</i> | <p><i>The lamp is not turned on.</i></p> <ul style="list-style-type: none"> • <i>The unit was turned on immediately after being turned off. Turn off the unit, wait at least one minute, then turn on the unit again.</i> • <i>The lamp is dead. Replace the lamp cartridge. (See page 33.)</i> |

Replacing the lamp cartridge

The lamp life is about 1,000 hours (under the test conditions of our company), however, it may become shorter depending on the conditions of usage.

After the lamp has been operating for 1000 hours or longer, the STATUS indicator on the control panel will light and the "LAMP USAGE" icon which shows hours of total lamp usage will be displayed on the screen. When this happens, turn off the unit and replace the lamp cartridge with a new one. The unit will not turn on after 1100 hours. (It will go off if it is in use.)

⚠ CAUTION

- DO NOT TOUCH THE LAMP immediately after it has been used. It will be extremely hot. Allow at least one hour for the lamp to cool before handling.
- DO NOT LOOSEN ANY SCREWS except for those mentioned in the instructions below. There is danger of electric shock.

Lamp cartridge replacement procedure

- 1 Disconnect the power cable.
Wait at least one hour for the lamp to cool.
- 2 Turn the unit upside down carefully.
- 3 Loosen the lamp cover securing screw.
- 4 Remove the lamp cover.

⚠ **CAUTION:** Do not use a lamp cartridge other than the PLUS replacement lamp cartridge. Order this from your PLUS dealer using the unit model number (see "Notes" below).

- 5 Loosen the three lamp cartridge securing screws.
(This unit has a safety switch.)
- 6 Hold the handle then pull the lamp cartridge upward to remove it.
- 7 Install the new lamp cartridge.
- 8 Secure the lamp cartridge with the three screws.
- 9 Replace the lamp cover and secure it with the securing screw.
- 10 Return the unit to the normal position, connect the power cable, and turn on the unit.
- 11 Reset "LAMP USAGE." (See page 30).

Notes

- When the lamp usage time reaches 1100 hours, it becomes impossible to switch on the power and menus are not displayed. In such a case, see "If the unit doesn't go on because lamp usage exceeds 1100 hours" on page 30.
- Obtain a replacement lamp cartridge at the store where the unit was purchased. Please specify the following information when ordering a replacement lamp cartridge:
 - Model name : U2-150
 - Product code : 28-640

Step 3

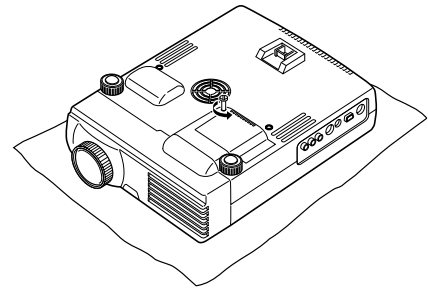

Step 4

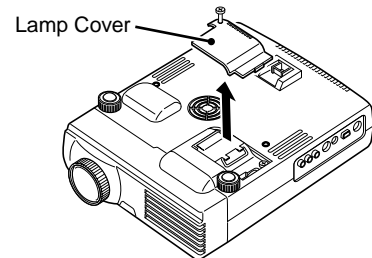

Step 5

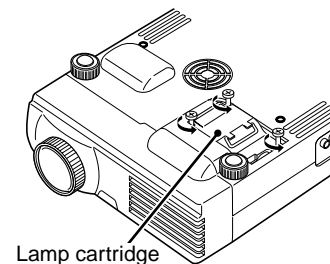

Step 6

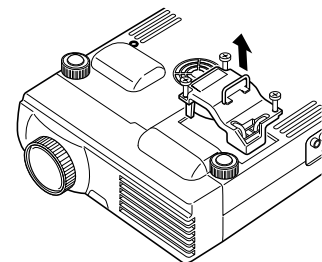

Step 7

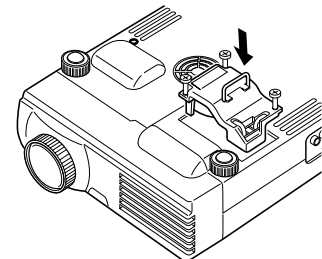

Step 8

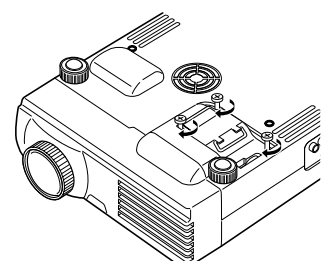

Step 9

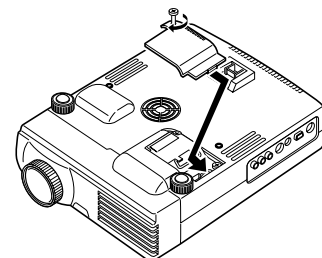

Specifications

Optical

| | |
|---------------------|---|
| DMD™ | Single Chip Digital Micro Device (DMD™) (U2-1130) (U2-1110) 1024×768 dots 1024×768 dots |
| Lens | Manual zoom, manual focus (U2-1130) (U2-1110) F=2.7 to 3.0 f=35 to 42 mm F=3.0 to 3.3 f=27.5 to 33 mm (1.4 to 1.65 in.) (1.1 to 1.3 in.) |
| Lamp | High Performance Compact Lamp 150 W |
| Image Size | 635 to 7620 mm (25 to 300 in.) diagonal |
| Projection Distance | 1.2 to 12.3m (3.9 to 40.4 ft.) |
| Light Output | (U2-1130) (U2-1110) 1300 ANSI lumens (normally white) 1100 ANSI lumens (normally white) |
| Contrast Ratio | 800 : 1 |

Electrical

| | |
|-----------------------|--|
| Inputs | Video (NTSC / PAL / SECAM / NTSC4.43) RGB (H:15 to 85 kHz, V: 50 to 85 Hz) |
| Video Bandwidth | 60 MHz |
| Color Reproduction | Full color, 16.7 million colors simultaneously. |
| Horizontal Resolution | NTSC 500, PAL 500, SECAM 300, NTSC4.43 350 TV lines RGB 1024 dots horizontal, 768 dots vertical |
| Power Requirement | 100 to 120/220 to 240 V AC, 50/60 Hz |
| Input Current | 2.2A/1.0A (220W) |

Mechanical

| | |
|--------------------------|---|
| Dimensions | 23.5 cm (W) × 5.8 cm (H) × 29.7 cm (D) / 9.3 in.(W) × 2.3 in.(H) × 11.7 in.(D) |
| Net Weight | (U2-1130) (U2-1110) 2.6 kg / 5.7 lbs 2.5 kg / 5.5 lbs |
| Operational Temperatures | Data projector: 5° to 35°C (41° to 95°F), 30 to 85% humidity Remote control: 0° to 60°C (32° to 140°F) |
| Regulations | UL Approved (UL 1950, CSA 950) Meets DOC Canada requirements Meets FCC Class A requirements Meets EMC Directive (EN55022, EN61000-3-2, EN61000-3-3, EN50082-1) Meets Low Voltage Directive (EN60950, TÜV GS Approved) |



D-Sub Pin Assignments

PC 15-Pin mini D-Sub

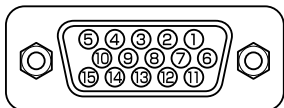

| Pin No. | Signal to be connected |
|---------|------------------------|
| 1 | Red |
| 2 | Green |
| 3 | Blue |
| 4 | GND |
| 5 | GND |
| 6 | Red GND |
| 7 | Green GND |
| 8 | Blue GND |
| 9 | No Connection |
| 10 | Digital GND |
| 11 | GND |
| 12 | SDA |
| 13 | Horizontal Sync |
| 14 | Vertical Sync |
| 15 | SCL |

(Continued on next page.)

Specifications (continued)

Dimensions

(U2-1130)

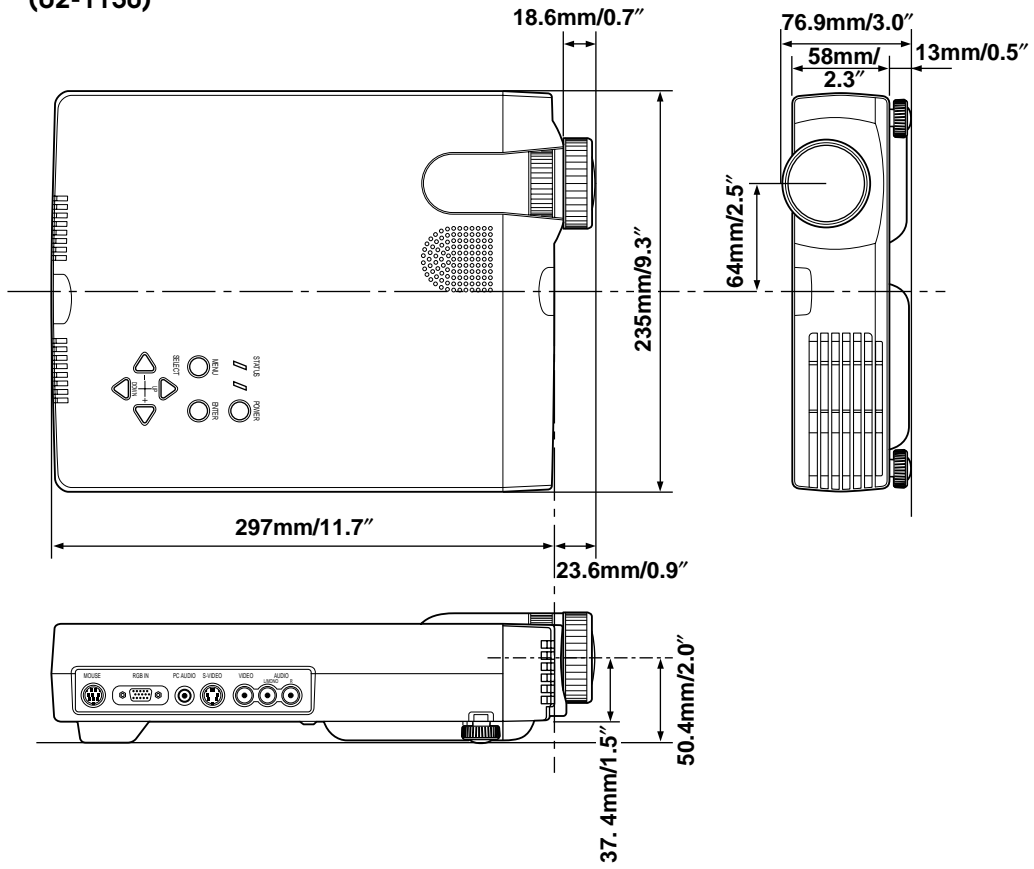

(U2-1110)

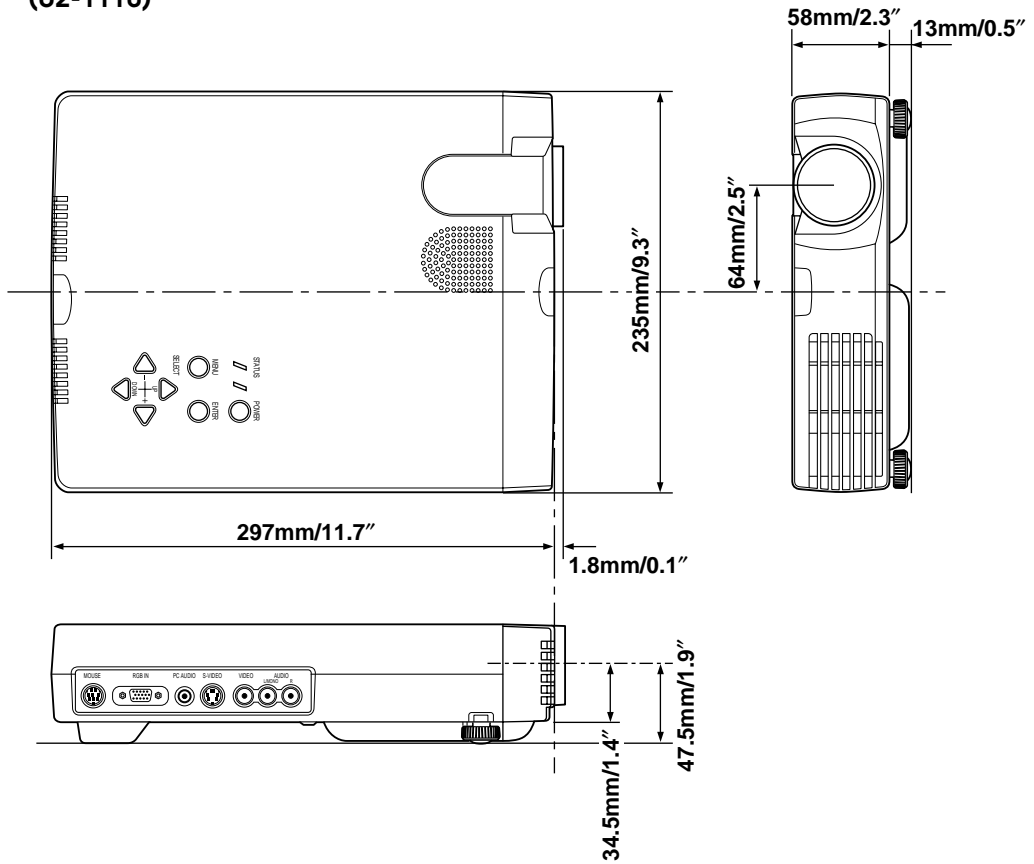

PLUS CORPORATION

3-B22, NAKASE 1-CHOME, MIHAMA-KU, CHIBA 261-01 JAPAN
PHONE: 043-296-3056 FAX: 043-296-3025
TELEX: J22113 PLUSJIM, CABLE PLUSJIMUK TOKYO