



# Table of Contents

Table of Contents .....	1	SETUP   Audio Settings .....	43
Usage Notice .....	2	SETUP   Advanced .....	44
Safety Information .....	2	SETUP   LAN .....	45
Precautions .....	3	OPTIONS .....	50
Eye Safety Warnings .....	5	OPTIONS   Advanced .....	52
Product Features .....	5	OPTIONS   Lamp Settings .....	53
Introduction .....	6	OPTIONS   Optional Filter Settings .....	54
Package Overview .....	6	Appendices .....	55
Product Overview .....	7	Troubleshooting .....	55
Main Unit .....	7	Replacing the lamp .....	60
Control Panel .....	8	Compatibility Modes .....	62
Input/Output Connections .....	9	Computer/Video/HDMI/Mac	
Remote Control .....	11	Compatibility .....	62
Installation .....	12	3D Input Video Compatibility .....	63
Connecting the Projector .....	12	RS232 Commands and Protocol	
Connect to Computer/Notebook .....	12	Function List .....	64
Connect to Video Sources .....	14	RS232 Pin Assignments .....	64
Powering the projector On / Off .....	16	RS232 Protocol Function List .....	65
Powering On the Projector .....	16	Wall Mount Installation .....	69
Powering Off the Projector .....	17	Optoma Global Offices .....	70
Warning Indicator .....	17	Regulation & Safety Notices .....	72
Adjusting the Projected Image .....	18		
Adjusting the Projector's Height .....	18		
Adjusting the Projector's Focus .....	19		
Adjusting Projection Image Size .....	19		
User Controls .....	21		
Control Panel & Remote Control .....	21		
Control Panel .....	21		
Remote Control .....	22		
On-screen Display Menus .....	27		
How to operate .....	27		
Menu Tree .....	28		
IMAGE .....	30		
IMAGE   Advanced .....	32		
IMAGE   Advanced   Signal (RGB) .....	34		
DISPLAY .....	35		
DISPLAY   3D .....	38		
SETUP .....	39		
SETUP   Security .....	41		

## Safety Information

	The lightning flash with arrow head within an equilateral triangle is intended to alert the user to the presence of uninsulated "dangerous voltage" within the product's enclosure that may be of sufficient magnitude to constitute a risk of electric shock to persons.
	The exclamation point within an equilateral triangle is intended to alert the user to the presence of important operating and maintenance (servicing) instructions in the literature accompanying the appliance.

**WARNING:** TO REDUCE THE RISK OF FIRE OR ELECTRIC SHOCK, DO NOT EXPOSE THIS APPLIANCE TO RAIN OR MOISTURE. DANGEROUS HIGH VOLTAGES ARE PRESENT INSIDE THE ENCLOSURE. DO NOT OPEN THE CABINET. REFER SERVICING TO QUALIFIED PERSONNEL ONLY.

### **Class B emissions limits**

This Class B digital apparatus meets all requirements of the Canadian Interference-Causing Equipment Regulations.

### **Important Safety Instruction**

1. Do not block any ventilation openings. To ensure reliable operation of the projector and to protect from over heating, it is recommended to install the projector in a location that does not block ventilation. As an example, do not place the projector on a crowded coffee table, sofa, bed, etc. Do not put the projector in an enclosure such as a book case or a cabinet that restricts air flow.
2. Do not use the projector near water or moisture. To reduce the risk of fire and/or electric shock, do not expose the projector to rain or moisture.
3. Do not install near heat sources such as radiators, heaters, stoves or any other apparatus such as amplifiers that emits heat.
4. Clean only with dry cloth.
5. Only use attachments/accessories specified by the manufacturer.
6. Do not use the unit if it has been physically damaged or abused.  
Physical damage/abuse would be (but not limited to):
  - Unit has been dropped.
  - Power supply cord or plug has been damaged.
  - Liquid has been spilled on to the projector.
  - Projector has been exposed to rain or moisture.
  - Something has fallen in the projector or something is loose inside.Do not attempt to service the unit yourself. Opening or removing covers may expose you to dangerous voltages or other hazards. Please call Optoma before you send the unit for repair.
7. Do not let objects or liquids enter the projector. They may touch dangerous voltage points and short out parts that could result in fire or electric shock.
8. See projector enclosure for safety related markings.
9. The unit should only be repaired by appropriate service personnel.

## Precautions



*Please follow all warnings, precautions and maintenance as recommended in this user's guide.*

- Warning- Do not look into the projector's lens when the lamp is on. The bright light may hurt and damage your eyes.
- Warning- To reduce the risk of fire or electric shock, do not expose this projector to rain or moisture.
- Warning- Please do not open or disassemble the projector as this may cause electric shock.
- Warning- When replacing the lamp, please allow the unit to cool down. Follow instructions as described on pages 60-61.
- Warning- This projector will detect the life of the lamp itself. Please be sure to change the lamp when it shows warning messages.
- Warning- Reset the "Lamp Reset" function from the on-screen display "OPTIONS | Lamp Settings" menu after replacing the lamp module (refer to page 53).
- Warning- When switching the projector off, please ensure the cooling cycle has been completed before disconnecting power. Allow 90 seconds for the projector to cool down.
- Warning- Do not use lens cap when projector is in operation.
- Warning- When the lamp is approaching the end of its lifetime, the message "Lamp Warning: Lamp life exceeded." will show on the screen. Please contact your local reseller or service center to change the lamp as soon as possible.
- Warning- Do not look into or point the laser pointer on your remote control into your or someone's eyes. Laser pointer can cause permanent damage to eyesight.



- ❖ When the lamp reaches the end of its life, the projector will not turn back on until the lamp module has been replaced. To replace the lamp, follow the procedures listed under "Replacing the Lamp" section on pages 60-61.

# Usage Notice

## **Do:**

- ❖ Turn off and unplug the power plug from the AC outlet before cleaning the product.
- ❖ Use a soft dry cloth with mild detergent to clean the display housing.
- ❖ Disconnect the power plug from AC outlet if the product is not being used for a long period of time.

## **Do not:**

- ❖ Block the slots and openings on the unit provided for ventilation.
- ❖ Use abrasive cleaners, waxes or solvents to clean the unit.
- ❖ Use under the following conditions:
  - In extremely hot, cold or humid environments.
    - ▶ Ensure that the ambient room temperature is within 5 - 40°C.
    - ▶ Relative Humidity is 5 - 40°C, 80% (Max.), non-condensing.
  - In areas susceptible to excessive dust and dirt.
  - Near any appliance generating a strong magnetic field.
  - In direct sunlight.

## Eye Safety Warnings



- Avoid staring/facing directly into the projector beam at all times. Keep your back to the beam as much as possible.
- When projector is used in a classroom, adequately supervise students when they are asked to point out something on the screen.
- In order to minimize the lamp power, use room blinds to reduce ambient light levels.

## Product Features



- ❖ Monitor loop through only supported in VGA1-In/YPbPr.

- XGA (1024x768) / WXGA (1280x800) Native resolution
- HD compatible – 720p and 1080p supported
- VGA monitor loop through (works in standby mode > 0.5W)
- BrilliantColor™ Technology
- Security Bar and Kensington Lock
- RS232 control
- Rapid shutdown
- Built-in speakers
- Network support
- Full 3D
- Eco+ and Quick Resume

# Introduction

## Package Overview

*Unpack and inspect the box contents to ensure all parts listed below are in the box. If something is missing, please contact your nearest customer service center.*

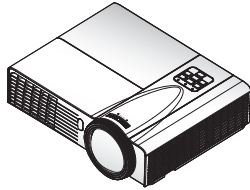

Projector with lens cap

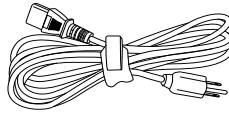

Power Cord

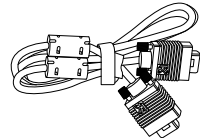

VGA Cable

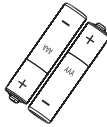

2 × AAA Batteries



IR Remote Control



❖ Due to different applications in each Country, some regions may have different accessories.

### Documentation :

- User's Manual
- Warranty Card
- Quick Start Card
- WEEE Card  
(for EMEA only)
- STOP Card  
(for US Only)

## Product Overview

### Main Unit

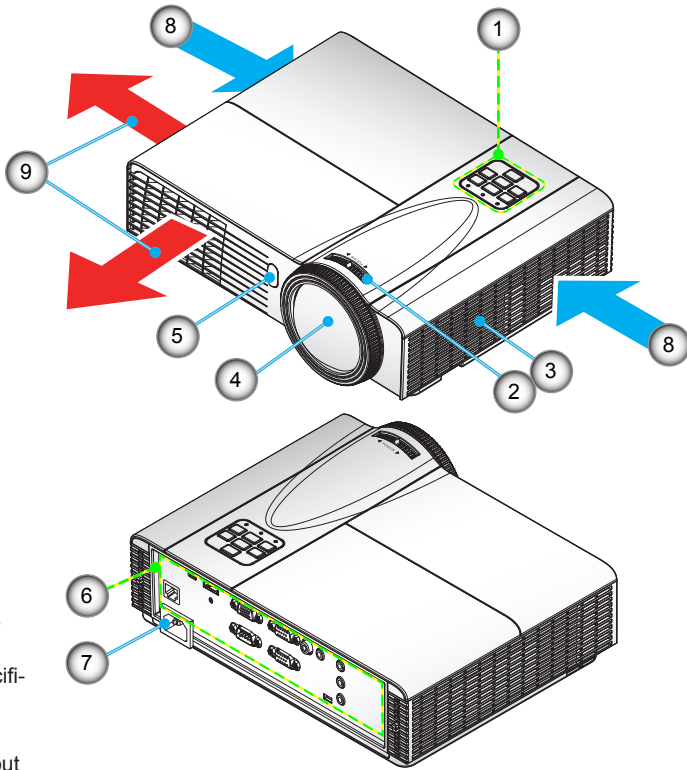

- ❖ The interface is subject to model's specifications.
- ❖ Do not block projector in/out air vents.

- |                  |                               |
|------------------|-------------------------------|
| 1. Control Panel | 6. Input / Output Connections |
| 2. Focus Ring    | 7. Power Socket               |
| 3. Speaker       | 8. Ventilation (inlet)        |
| 4. Zoom Lens     | 9. Ventilation (outlet)       |
| 5. IR Receiver   |                               |

# Introduction

## Control Panel

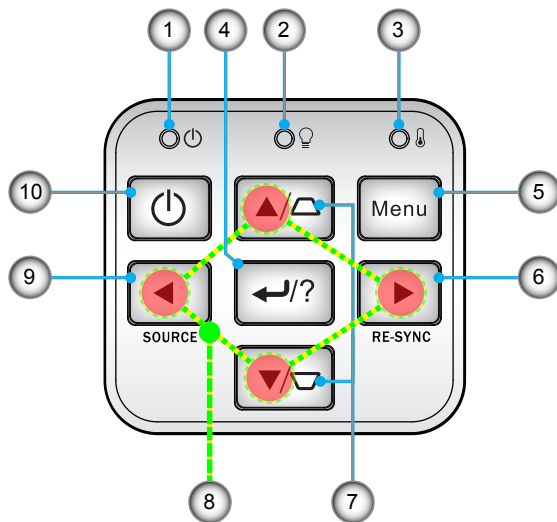

1. Power LED
2. Lamp LED
3. Temp LED
4. Enter / Help
5. Menu
6. Re-Sync
7. Keystone Correction
8. Four Directional Select Keys
9. Source
10. Power/Standby button



# Introduction

## Input/Output Connections

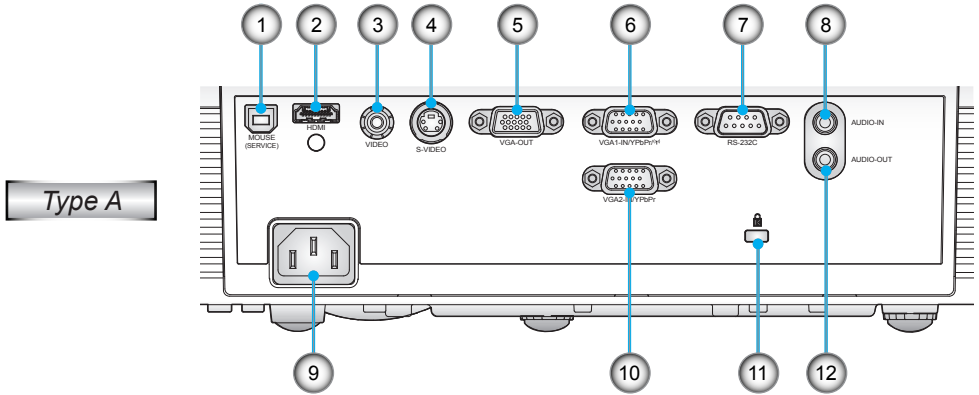

1. USB Connector / Type-B (Connect to PC for Remote Mouse function)
2. HDMI Connector
3. Composite Video Input Connector
4. S-Video Input Connector
5. VGA-Out Connector (Monitor Loop-through Output)
6. VGA1-In/YPbPr/H<sup>(\*)</sup> Connector  
(PC Analog Signal/Component Video Input/HDTV/YPbPr/Wireless function via VGA Dongle)
7. RS-232 Connector (9-pin DIN Type)
8. Audio Input connector (3.5mm mini jack)
9. Power Socket
10. VGA2-In/YPbPr Connector  
(PC Analog Signal/Component Video Input/HDTV/YPbPr)
11. Kensington™ Lock Port
12. Audio Output Connector (3.5mm Mini Jack)

### NOTE

- ❖ Monitor loop through only supported in VGA1-IN/YPbPr.

# Introduction

## Type B

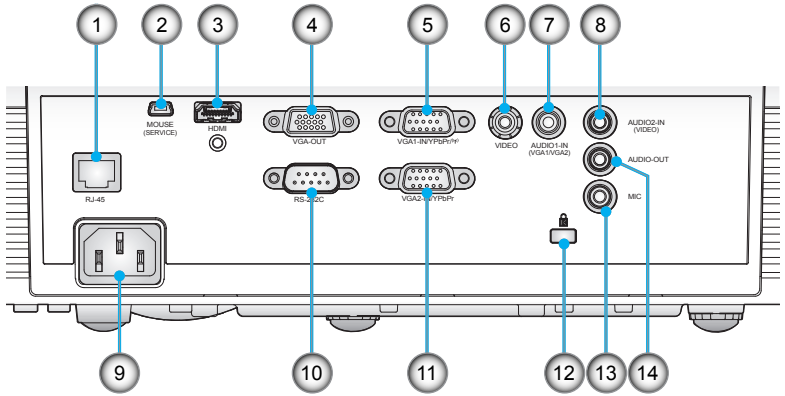

1. RJ-45 Networking Connector
2. USB Connector / Type-B (Connect to PC for Remote Mouse function)
3. HDMI Connector
4. VGA-Out Connector (Monitor Loop-through Output)
5. VGA1-In/YPbPr<sup>(\*)</sup> Connector  
(PC Analog Signal/Component Video Input/HDTV/YPbPr/Wireless function via VGA Dongle)
6. Composite Video Input Connector
7. Audio 1 Input connector (3.5mm mini jack)  
(for VGA1/VGA2)
8. Audio 2 Input connector (3.5mm mini jack)  
(for Video)
9. Power Socket
10. RS-232 Connector (9-pin DIN Type)
11. VGA2-In/YPbPr Connector  
(PC Analog Signal/Component Video Input/HDTV/YPbPr)
12. Kensington™ Lock Port
13. Microphone Input Connector
14. Audio Output Connector (3.5mm Mini Jack)



❖ Monitor loop through only supported in VGA1-IN/YPbPr.

# Introduction

## Remote Control



❖ The interface is subject to model's specifications.

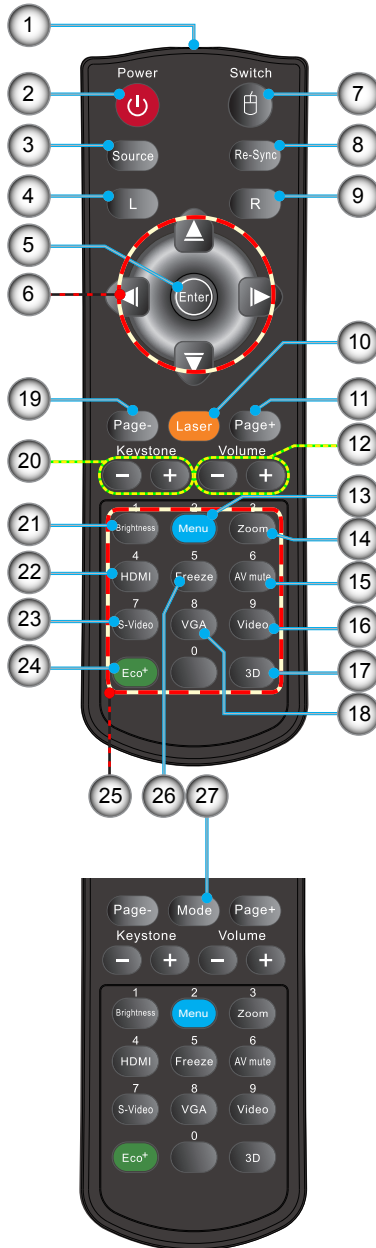

1. LED Indicator
2. Power On/Off
3. Source
4. Mouse Left Click
5. Enter
6. Four Directional Select Keys / Mouse control
7. Switch
8. Re-Sync
9. Mouse Right Click
10. Laser Pointer
11. Page Up
12. Volume +/-
13. Menu
14. Zoom
15. AV mute
16. Video
17. 3D
18. VGA
19. Page Down
20. Keystone +/-
21. Brightness
22. HDMI
23. S-Video
24. Eco+
25. Numbered keypad (for password input)
26. Freeze
27. Mode

# Installation

## Connecting the Projector

### Connect to Computer/Notebook

Type A



- ❖ Due to the difference in applications for each country, some regions may have different accessories.
- ❖ (\*) Optional accessory
- ❖ The interface is subject to model's specifications .

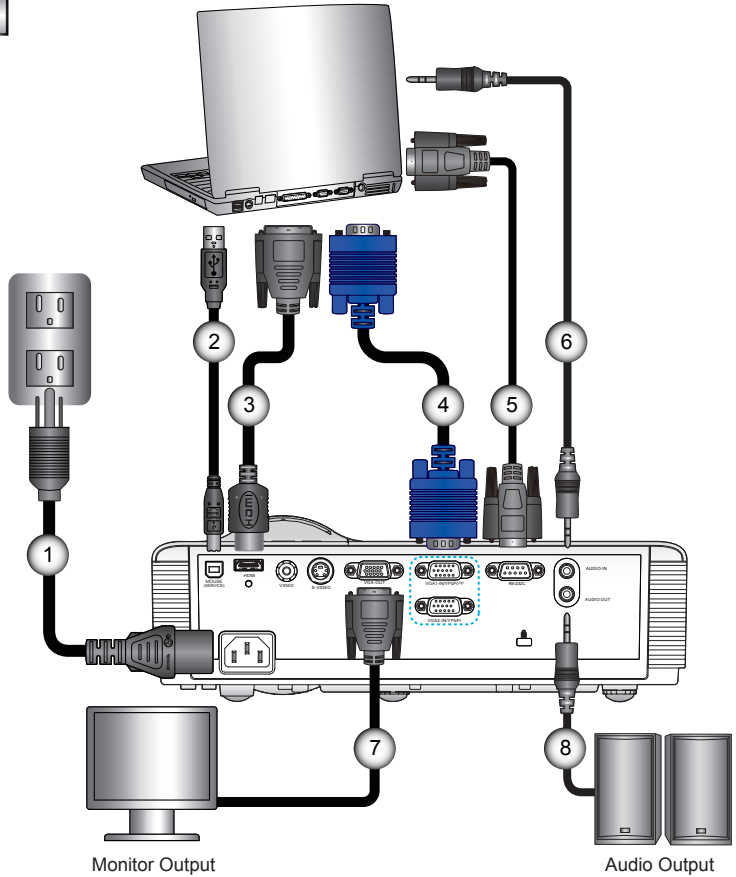

1.....	Power Cord
2.....	*USB Cable
3.....	*DVI/HDMI Cable
4.....	VGA Cable
5.....	*RS232 Cable
6.....	*Audio Input Cable
7.....	*VGA Out Cable
8.....	*Audio Output Cable

# Installation

Type B

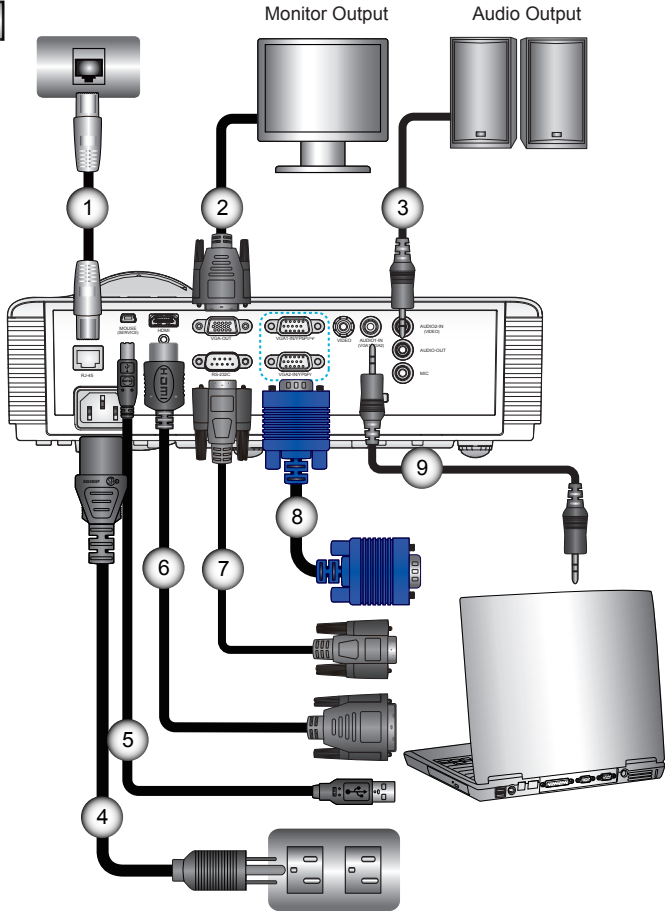

- ❖ Due to the difference in applications for each country, some regions may have different accessories.
- ❖ (\*) Optional accessory
- ❖ The interface is subject to model's specifications .

- |        |                     |
|--------|---------------------|
| 1..... | *Network Cable      |
| 2..... | *VGA Out Cable      |
| 3..... | *Audio Output Cable |
| 4..... | Power Cord          |
| 5..... | *USB Cable          |
| 6..... | *DVI/HDMI Cable     |
| 7..... | *RS232 Cable        |
| 8..... | VGA Cable           |
| 9..... | *Audio Input Cable  |

# Installation

## Connect to Video Sources

Type A



- ❖ Due to the difference in applications for each country, some regions may have different accessories.
- ❖ (\*) Optional accessory
- ❖ The interface is subject to model's specifications .

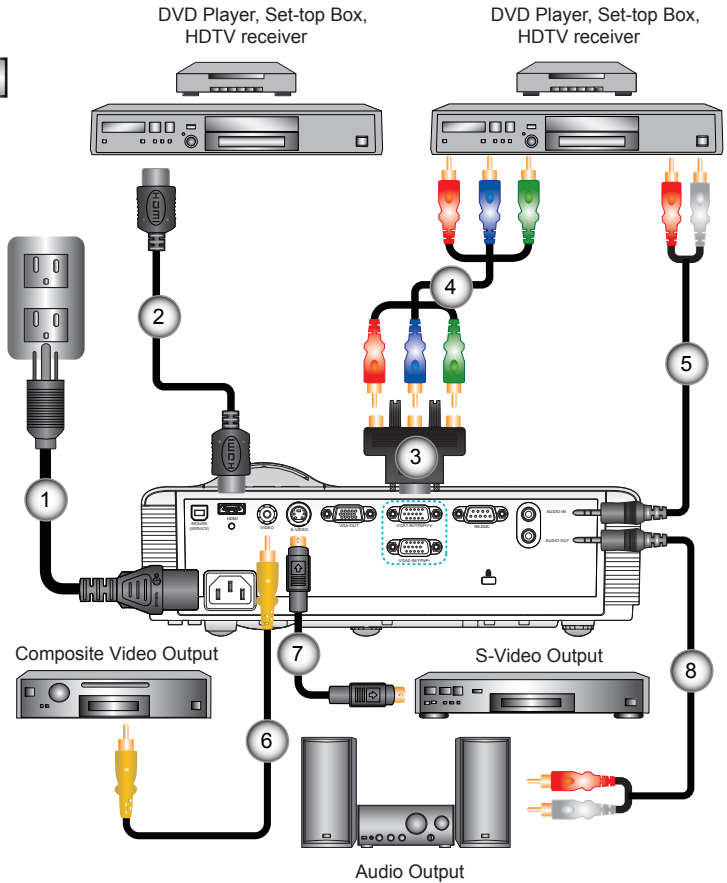

- |        |   |
|--------|---|
| 1..... | Power Cord                              |
| 2..... | *HDMI Cable                             |
| 3..... | *15-Pin to 3 RCA Component/HDTV Adaptor |
| 4..... | *3 RCA Component Cable                  |
| 5..... | *Audio Input Cable                      |
| 6..... | *Composite Video Cable                  |
| 7..... | *S-Video Cable                          |
| 8..... | *Audio Output Cable                     |

# Installation

Type B

Composite Video Output

Audio Output

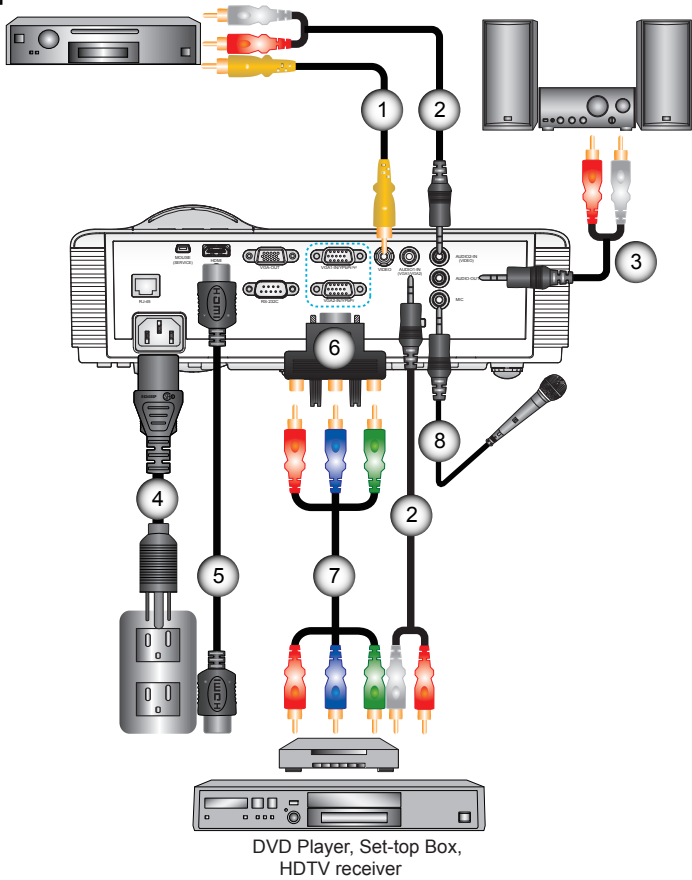

- ❖ Due to the difference in applications for each country, some regions may have different accessories.
- ❖ (\*) Optional accessory
- ❖ The interface is subject to model's specifications .

- |        |   |
|--------|---|
| 1..... | *Composite Video Cable                  |
| 2..... | *Audio Input Cable                      |
| 3..... | *Audio Output Cable                     |
| 4..... | Power Cord                              |
| 5..... | *HDMI Cable                             |
| 6..... | *15-Pin to 3 RCA Component/HDTV Adaptor |
| 7..... | *3 RCA Component Cable                  |
| 8..... | *Microphone Cable                       |

## Powering the projector On / Off

### Powering On the Projector

1. Remove the lens cap. (optional) ❶
2. Securely connect the power cord and signal cable. When connected, the POWER/STANDBY LED will turn Amber.
3. Turn on the lamp by pressing “” button either on the top of the projector or on the remote. The POWER/STANDBY LED will now turn Green. ❷

The startup screen will display in approximately 10 seconds. The first time you use the projector, you will be asked to select the preferred language and power saving mode.

4. Turn on and connect the source that you want to display on the screen (computer, notebook, video player, etc). The projector will detect the source automatically. If not, push menu button and go to “OPTIONS”. Make sure that the “Source Lock” has been set to “Off”.
- ❖ If you connect multiple sources at the same time, press the “SOURCE” button on the control panel or direct source keys on the remote control to switch between inputs.



❖ When Power mode (Standby) is set to Eco (<0.5W), the VGA output and Audio pass-through will be deactivated when the projector is in standby.



❖ Turn on the projector first and then select the signal sources.

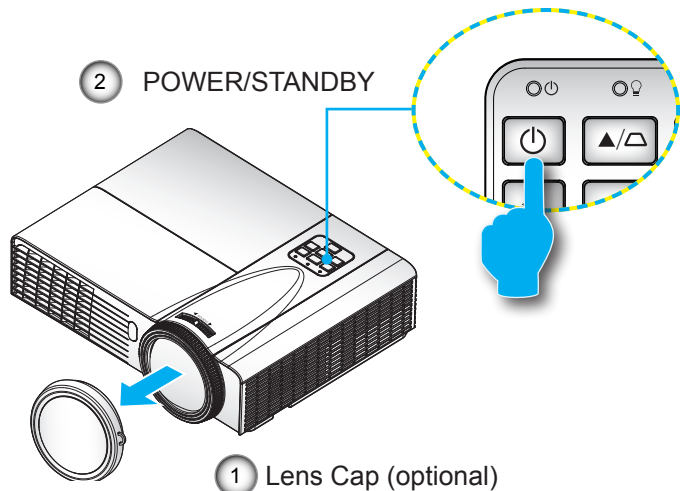



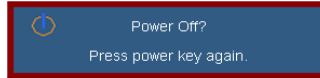

## Powering Off the Projector

1. Press the “” button on the remote control or on the control panel to turn off the projector. The following message will be displayed on the screen.



Press the “” button again to confirm otherwise the message will disappear after 15 seconds. When you press the “” button for the second time, the fan will start cooling the system and will shut down.

2. The cooling fans continue to operate for about 10 seconds for cooling cycle and the POWER/STANDBY LED will Flash Green. When the POWER/STANDBY LED lights solid Amber, the projector has entered standby mode.

If you wish to turn the projector back on, you must wait until the projector has completed the cooling cycle and has entered standby mode. Once in standby mode, simply press “” button to restart the projector.

3. Disconnect the power cord from the electrical outlet and the projector.
4. Do not turn on the projector immediately following a power off procedure.

## Warning Indicator

When the warning indicators (see below) come on, the projector will automatically shutdown:



- ❖ Contact the nearest service center if the projector displays these symptoms. See pages 70-71 for more information.
- ❖ “LAMP” LED indicator is lit red and if “POWER/STANDBY” indicator flashes amber.
- ❖ “TEMP” LED indicator is lit red and if “POWER/STANDBY” indicator flashes amber. This indicates the projector has overheated. Under normal conditions, the projector can be switched back on.
- ❖ “TEMP” LED indicator flashes red and if “POWER/STANDBY” indicator flashes amber.

Unplug the power cord from the projector, wait for 30 seconds and try again. If the warning indicator light up again, please contact your nearest service center for assistance.

## Adjusting the Projected Image

### Adjusting the Projector's Height

*The projector is equipped with elevator feet for adjusting the image height.*

1. Locate the adjustable foot you wish to modify on the underside of the projector.
2. Rotate the adjustable ring clockwise to raise the projector or counter clockwise to lower it. Repeat with the remaining feet as needed.

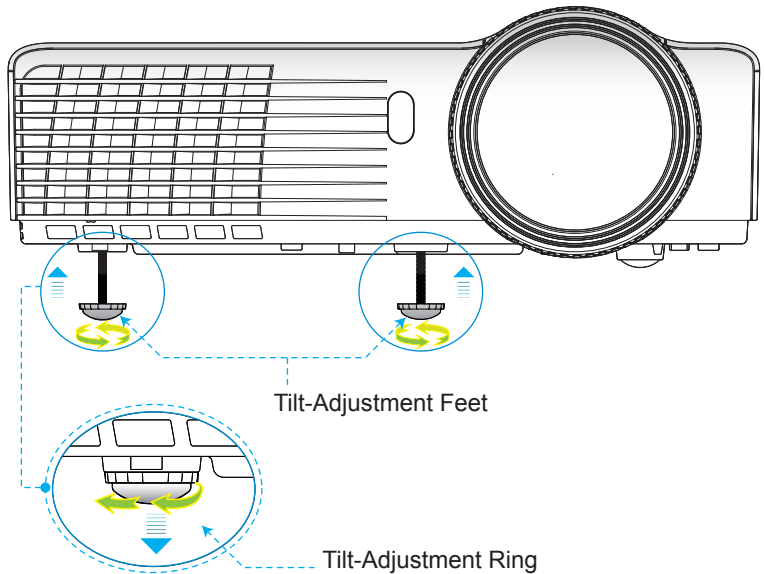

# Installation

## Adjusting the Projector's Focus

To focus the image, rotate the focus ring until the image is clear.

- ▶ XGA series: The projector will focus at distances from 2.46 to 3.61 feet (0.75 to 1.10 meters).
- ▶ WXGA series: The projector will focus at distances from 2.56 to 3.70 feet (0.78 to 1.13 meters).

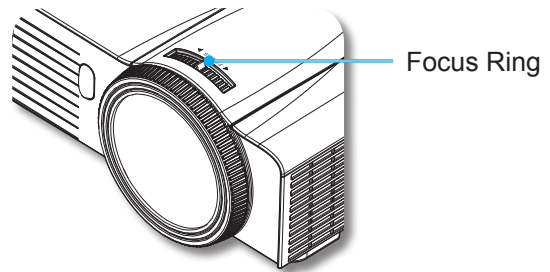

## Adjusting Projection Image Size

- ▶ XGA series: Projection Image Size from 59" to 86" (1.50 to 2.18 meters).
- ▶ WXGA series: Projection Image Size from 69" to 98" (1.75 to 2.49 meters).

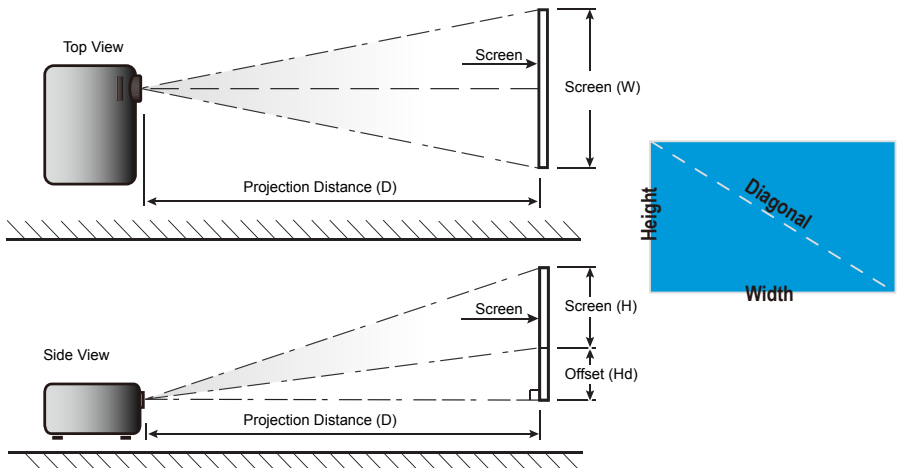

# Installation

## XGA

Diagonal length (inch) size of 4:3 Screen	Screen Size W x H				Projection Distance (D)				Offset (Hd)	
	(m)		(inch)		(m)		(feet)			
	Width	Height	Width	Height	wide	tele	wide	tele	(m)	(inch)
40.00	0.81	0.61	32.00	24.00	0.51	0.51	1.67	1.67	0.09	3.60
60.00	1.22	0.91	48.00	36.00	0.76	0.76	2.50	2.50	0.14	5.40
70.00	1.42	1.07	56.00	42.00	0.89	0.89	2.92	2.92	0.16	6.30
80.00	1.63	1.22	64.00	48.00	1.02	1.02	3.34	3.34	0.18	7.20
90.00	1.83	1.37	72.00	54.00	1.14	1.14	3.76	3.76	0.21	8.10
100.00	2.03	1.52	80.00	60.00	1.27	1.27	4.17	4.17	0.23	9.00
120.00	2.44	1.83	96.00	72.00	1.53	1.53	5.01	5.01	0.27	10.80
150.00	3.05	2.29	120.00	90.00	1.91	1.91	6.26	6.26	0.34	13.50
180.00	3.66	2.74	144.00	108.00	2.29	2.29	7.51	7.51	0.41	16.20
250.00	5.08	3.81	200.00	150.00	3.18	3.18	10.43	10.43	0.57	22.50
300.00	6.10	4.57	240.00	180.00	3.82	3.82	12.52	12.52	0.69	27.00

## WXGA

Diagonal length (inch) size of 16:10 Screen	Screen Size W x H				Projection Distance (D)				Offset (Hd)	
	(m)		(inch)		(m)		(feet)			
	Width	Height	Width	Height	wide	tele	wide	tele	(m)	(inch)
40.00	0.86	0.54	33.92	21.20	0.45	0.45	1.77	1.77	0.07	2.63
60.00	1.29	0.81	50.88	31.80	0.67	0.67	2.65	2.65	0.10	3.94
70.00	1.51	0.94	59.36	37.10	0.79	0.79	3.10	3.10	0.12	4.60
80.00	1.72	1.08	67.84	42.40	0.90	0.90	3.54	3.54	0.13	5.26
90.00	1.94	1.21	76.32	47.70	1.01	1.01	3.98	3.98	0.15	5.91
100.00	2.15	1.35	84.80	53.00	1.12	1.12	4.42	4.42	0.17	6.57
120.00	2.58	1.62	101.76	63.60	1.35	1.35	5.31	5.31	0.20	7.89
150.00	3.23	2.02	127.20	79.50	1.68	1.68	6.64	6.64	0.25	9.86
180.00	3.88	2.42	152.64	95.40	2.02	2.02	7.96	7.96	0.30	11.83
250.00	5.38	3.37	212.00	132.50	2.81	2.81	11.06	11.06	0.42	16.43
300.00	6.46	4.04	254.40	159.00	3.37	3.37	13.27	13.27	0.50	19.72













❖ This table is for user's reference only.

## Control Panel & Remote Control

### Control Panel



#### Using the Control Panel

POWER		Refer to the "Power On/Off the Projector" section on pages 16-17.
RE-SYNC		Automatically synchronize the projector to the input source.
Enter / Help		 Confirm your item selection.  Help Menu (only available when OSD menu is not shown).
SOURCE		Press "SOURCE" to select an input signal.
Menu		Press "Menu" to launch the on-screen display (OSD) menu. To exit OSD, Press "Menu" again.
Four Directional Select Keys		Use     to select items or make adjustments to your selection.
Keystone		Use   to adjust image distortion caused by tilting the projector. ( $\pm 40$ degrees)
Lamp LED		Indicate the projector's lamp status.
Temp LED		Indicate the projector's temperature status.
POWER/ STANDBY LED		Indicate the projector's status.









# User Controls

## Remote Control

### Using the Remote Control



- ❖ The interface is subject to model's specifications.

Power		Refer to the "Power On/Off the Projector" section on pages 16-17.
L Button		Mouse left click.
R Button		Mouse right click.
Page +		Use this button to page up.
Page -		Use this button to page down.
Enter		Confirm your item selection.
Source		Press "Source" to select an input signal.
Re-Sync		Automatically synchronizes the projector to the input source.
Four Directional Select Keys		Use     to select items or make adjustments to your selection.
PC/Mouse Control		Use     for emulation of USB mouse via USB when you press "Switch" button.
Keystone +/-		Adjust image distortion caused by tilting the projector.
Volume +/-		Adjust to increase / decrease the volume.
Brightness		Adjust the brightness of the image.
3D		Press the "3D" to turn the 3D OSD menu on/off.
Menu		Press "Menu" to launch the on-screen display (OSD) menu. To exit OSD, press "Menu" again.
HDMI		Press "HDMI" to choose HDMI source.

# User Controls



## Using the Remote Control

Freeze	Press "Freeze" to pause the screen image. Press this button again to unlock.
AV mute	Momentarily turns off/on the audio and video.
S-Video	Press "S-Video" to choose S-Video source.
VGA	Press "VGA" to choose VGA sources.
Video	Press "Video" to choose Composite video source.
Switch	USB mouse switch.
Mode	Select the display mode from Presentation, Bright, Movie, sRGB, Blackboard, Classroom, User and 3D.
Zoom	Zoom in on an image. Press ◀▶ buttons to alter zoom.
Eco+	When Eco+ mode is activated, the brightness level of the content is automatically detected to significantly reduced lamp power consumption (up to 70%) during periods of inactivity.



- ❖ AV mute: Save up to 70% of the lamp power when AV mute is applied.

# User Controls

## Using the HELP button

The HELP function ensures easy setup and operation.

- ▶ Press the “?” button on the control panel to open the Help Menu.

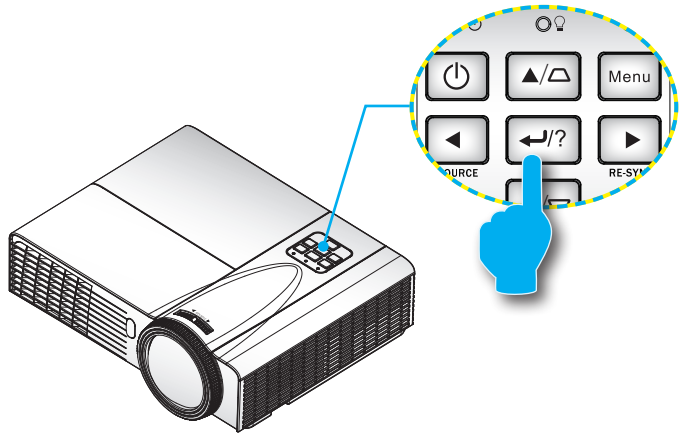



# User Controls

- ▶ Help menu button functions only when no input source is detected.



- ❖ Please refer to the “Troubleshooting” section on pages 55-59 for more details.

The screenshot shows a 'HELP' menu with the following content:

HELP

? No Image appears on-screen.

UpDown Select Menu Exit

No Image appears on-screen.

- ▶ Ensure all the cables and power connections are correctly and securely connected as described in the Installation section of User's Manual.
- ▶ Ensure all the pins of connectors are not bent or broken.
- ▶ Ensure that the [AV MUTE] feature is not turned on.

[NEXT]

[Exit]

UpDown Select Menu Exit

No Image appears on-screen.

- ▶ If you are using a Notebook :
  1. First, follow the steps above to adjust resolution of the computer.
  2. Press the toggle output settings. Example : [Fn]+[F 4]

Acer ⇨	[Fn]+[F5]	IBM/Lenovo ⇨	[Fn]+[F7]
Asus ⇨	[Fn]+[F8]	HP/Compaq ⇨	[Fn]+[F4]
Dell ⇨	[Fn]+[F8]	NEC ⇨	[Fn]+[F3]
Gateway ⇨	[Fn]+[F4]	Toshiba ⇨	[Fn]+[F5]

Mac Apple :

System Preference ⇨ Display ⇨ Arrangement ⇨ Mirror display

[PREV]

[Exit]

UpDown Select Menu Exit

- ▶ If input source is detected and help button is pressed, the following pages will appear to help diagnose any problems.

The screenshot shows a 'HELP' menu with the following content:

HELP

- ? Image has slanted sides.
- ? Image is too small or too large.
- ? Image is unstable or flickering.
- ? There is no audio heard or the volume is too low.

UpDown Select Menu Exit

# User Controls

Image has slanted sides.

- ▶ If possible, reposition the projector so that is centered on the screen and below the bottom of the screen.
- ▶ Press [KEYSTONE + / -] button until the sides are vertical on the remote control.

[KEYSTONE + / -]

 [Exit]



 UpDown    Select    Menu Exit

Image is too small or too large.



- ▶ Adjust the Zoom Ring on the top of projector.
- ▶ Move the projector closer to or further from the screen.
- ▶ Press [MENU] button on the remote control or projector panel, go to "DISPLAY | Format" and try the different settings.

[DISPLAY | Format]

 [Exit]

 UpDown    Select    Menu Exit

There is no audio heard or the volume is too low.

-  Is the volume setting at the minimum?
  - ▶ Turn up the volume setting.
-  Is the cable connected properly to the projector?
  - ▶ Check the physical connection and ensure the cable is connected properly from the source to projector.

[Volume]

 [Exit]







 UpDown    Select    Menu Exit

Image is unstable or flickering.

- ▶ Use [Phase / Frequency] to correct it.
- ▶ Change the monitor color setting on your computer.

[Phase]  
[Frequency]

 [Exit]

 UpDown    Select    Menu Exit

## On-screen Display Menus

The Projector has multilingual On-screen Display menus that allow you to make image adjustments and change a variety of settings. The projector will automatically detect the source.

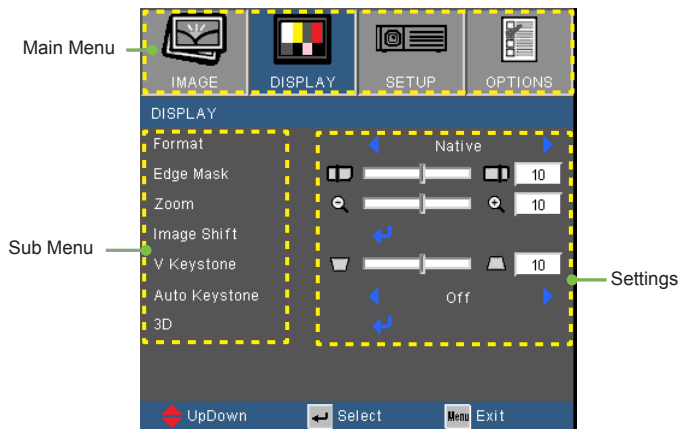

### How to operate

1. To open the OSD menu, press “Menu” on the Remote Control or Projector Keypad.
2. When OSD is displayed, use ◀▶ keys to select any item in the main menu. While making a selection on a particular page, press ▼ or “Enter” key to enter sub menu.
3. Use ▲▼ keys to select the desired item and adjust the settings using ◀▶ key.
4. Select the next item to be adjusted in the sub menu and adjust as described above.
5. Press “Enter” to confirm, and the screen will return to the main menu.
6. To exit, press “MENU” again. The OSD menu will close and the projector will automatically save the new settings.



# User Controls

## Menu Tree

Main Menu	Sub Menu	Settings			
<b>Image</b>	Display Mode	Presentation / Bright / Movie / sRGB / Blackboard / User / 3D			
	Brightness	-50~50			
	Contrast	-50~50			
	Sharpness	1~15			
	<sup>#1</sup> Color	-50~50			
	<sup>#1</sup> Tint	-50~50			
	Advanced	Gamma	Film / Video / Graphics / Standard		
			BrilliantColor™	1~10	
			Color Temp.	Warm / Medium / Cold	
			Color Settings	Red / Green / Blue / Cyan / Magenta / Yellow /	Hue / Saturation / Gain
				White	R / G / B
				Reset	
		Exit			
		Color Space	AUTO / RGB / YUV		
			<sup>#1</sup> AUTO / RGB (0-255) / RGB (16-235) / YUV		
		<sup>#1</sup> Signal	Automatic	On / Off	
			Phase (VGA)	0~31	
			Frequency (VGA)	-5~5	
			H. Position (VGA)	-5~5	
			V. Position (VGA)	-5~5	
			Exit		
	Reset				
	<b>Display</b>	Format	<sup>#1</sup> 4:3 / 16:9 / Native / AUTO		
<sup>#1</sup> 4:3 / 16:9 or 16:10 / LBX / Native / AUTO					
Edge Mask		0~10			
Zoom		-5~25 (80%~200%)			
Image Shift		H Image Shift	-100~100		
		V Image Shift	-100~100		
V Keystone		-40~40			
<sup>#1</sup> Auto Keystone		On / Off			
3D		3D Mode	Off / DLP-Link / IR		
		<sup>#1</sup> 3D Format	Auto / SBS / Top and Bottom / Frame Sequential		
	<sup>#1</sup> 3D Sync. Invert	On / Off			
	Exit				
<b>Setup</b>	Language	English / Deutsch / Français / Italiano / Español / Português / Svenska / Nederlands / Norsk/Dansk / Polski / Suomi / Русский / ελληνικά / Magyar / Čeština / العربية / 繁體中文 / 简体中文 / 日本語 / 한국어 / ไทย / Türkçe / Việt / Bahasa Indonesia / Română			
	Projection				
	Menu Location				
	<sup>#1</sup> Screen Type	16:10 / 16:9			
	Security	Security	On / Off		
		Security Timer	Month / Day / Hour		
		Change Password			
Exit					

# User Controls

Main Menu	Sub Menu	Settings		
<b>Setup</b>	Projector ID	0-99		
	Audio Settings	<sup>#5</sup> Internal Speaker	On / Off	
		Mute	On / Off	
		<sup>#5</sup> Audio Input	Default / Audio1 / Audio2	
		<sup>#5</sup> Volume	Audio	0-10
			Mic	0-10
	<sup>#4</sup> Volume	0-10		
	Advanced	Logo	Default / Neutral	
		Closed Captioning	Off / CC1 / CC2	
		Exit		
	<sup>#5</sup> LAN Settings	LAN State		
		DHCP	On / Off	
		IP Address		
		Subnet mask		
		Gateway		
DNS				
Apply		Yes / No		
Exit				
<b>Options</b>	Input Source	<sup>#4</sup> VGA1 / VGA2 / S-Video / Video / HDMI <sup>#5</sup> VGA1 / VGA2 / Video / HDMI		
	Source Lock	On / Off		
	High Altitude	On / Off		
	Information Hide	On / Off		
	Keypad Lock	On / Off		
	Test Pattern	None / Grid / White Pattern		
	Background Color	Black / Red / Blue / Green / White		
	Advanced	Direct Power On	On / Off	
		Auto Power Off (min.)	0-180	
		Sleep Timer (min.)	0-990	
		Quick Resume	On / Off	
		Power Mode (Standby)	Active / Eco	
		Exit		
	Lamp Settings	Lamp Hours		
		Lamp Reminder	On / Off	
		Brightness Mode	Bright / Eco	
		Lamp Reset	Yes / No	
		Exit		
	Optional Filter Settings	Optional Filter Installed	Yes / No	
		Filter Usage Hours	0-9999	
Filter Reminder		Off / 300hr / 500hr / 800hr / 1000hr		
Filter Reset		Yes / No		
Exit				
Reset		Yes / No		



- ❖ Please note that the on-screen display (OSD) menus vary according to the signal type selected and the projector model you are using.
- ❖ (#1) “Color” and “Tint” are only supported in Video mode.
- ❖ (#2) “Signal” is only supported in Analog VGA (RGB) signal.
- ❖ (#3) For HDMI Source only.
- ❖ (#4) For Type A model only.
- ❖ (#5) For Type B model only.
- ❖ (#6) “3D Sync Invert” is only available when 3D is enabled and this mode 3D is for DLP link glass only.
- ❖ (#7) For WXGA model only.

## IMAGE

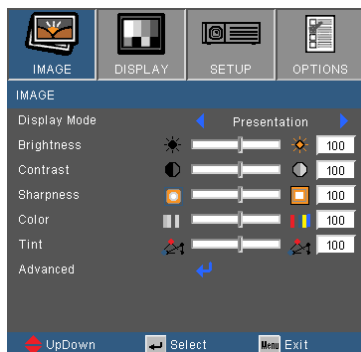

### Display Mode

There are many factory presets optimized for various types of images.

- ▶ Presentation: Good color and brightness from PC input.
- ▶ Bright: Maximum brightness from PC input.
- ▶ Movie: For home theater.
- ▶ sRGB: Standardised accurate color.
- ▶ Blackboard: This mode should be selected to achieve optimum color settings when projecting onto a blackboard (green).
- ▶ User: User's settings.
- ▶ 3D: Recommend setting for 3D mode enabled. Any further adjustments by the user in 3D will be saved in this mode for further use.

### Brightness

Adjust the brightness of the image.

- ▶ Press the ◀ to darken image.
- ▶ Press the ▶ to lighten the image.

### Contrast

The contrast controls the degree of difference between the lightest and darkest parts of the picture.

- ▶ Press the ◀ to decrease the contrast.
- ▶ Press the ▶ to increase the contrast.



- ❖ “Color” and “Tint” functions are only supported under Video mode.

## Sharpness

Adjust the sharpness of the image.

- ▶ Press the ◀ to decrease the sharpness.
- ▶ Press the ▶ to increase the sharpness.

## Color

Adjust a video image from black and white to fully saturated color.

- ▶ Press the ◀ to decrease the amount of saturation in the image.
- ▶ Press the ▶ to increase the amount of saturation in the image.

## Tint

Adjust the color balance of red and green.

- ▶ Press the ◀ to increase the amount of green in the image.
- ▶ Press the ▶ to increase the amount of red in the image.

## IMAGE | Advanced

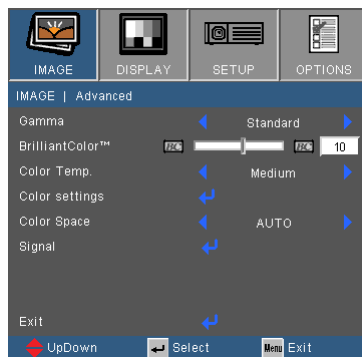

### Gamma

This allows you to choose a degamma table that has been fine-tuned to bring out the best image quality for the input.

- ▶ Film: for home theater.
- ▶ Video: for video or TV source.
- ▶ Graphics: for image source.
- ▶ Standard: for PC or computer source.

### BrilliantColor™

This adjustable item utilizes a new color-processing algorithm and system level enhancements to enable higher brightness while providing true, more vibrant colors in picture. The range is from “0” to “10”. If you prefer a stronger enhanced image, adjust toward the maximum setting. For a smoother, more natural image, adjust toward the minimum setting.

### Color Temp

If set to cold temperature, the image looks more blue. (cold image)  
If set to warm temperature, the image looks more red.  
(warm image)

### Color Settings

Press **↵** into the next menu as below and then use **▲** or **▼** to select item.



# User Controls

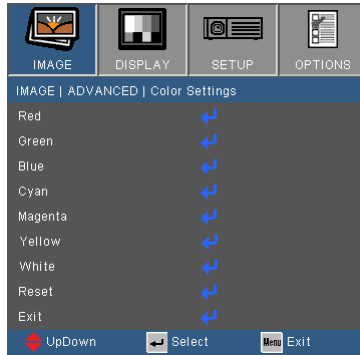

- ▶ Red/Green/Blue/Cyan/Magenta/Yellow: Use ◀ or ▶ to select Hue, Saturation and Gain Colors.



- ▶ White: Use ◀ or ▶ to select Red, Green and Blue Colors.



- ▶ Reset: Choose “Yes” to return the factory default settings for color adjustments.



❖ (\*) For HDMI only.

## Color Space

Select an appropriate color matrix type from AUTO, RGB, RGB(0-255)<sup>(\*)</sup>, RGB(16-235)<sup>(\*)</sup> or YUV.

## Reset

Choose “Yes” to return the display parameters on all menus to the factory default settings.

## IMAGE | Advanced | Signal (RGB)

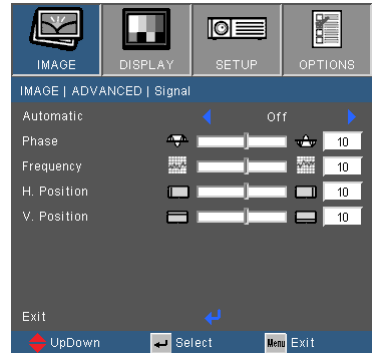

- ❖ “Signal” is only supported in Analog VGA (RGB) signal.

### Automatic

Automatically selects the signal. If you use this function, the Phase, frequency items are grayed out, and if Signal is not automatic, the phase, frequency items will appear for user to manually tune and saved in settings after that for next time projector turns off and on again.

### Phase

Synchronize the signal timing of the display with the graphic card. If the image appears to be unstable or flickers, use this function to correct it.

### Frequency

Change the display data frequency to match the frequency of your computer's graphic card. Use this function only if the image appears to flicker vertically.

### H. Position

- ▶ Press the ◀ to move the image left.
- ▶ Press the ▶ to move the image right.

### V. Position

- ▶ Press the ◀ to move the image down.
- ▶ Press the ▶ to move the image up.

## DISPLAY

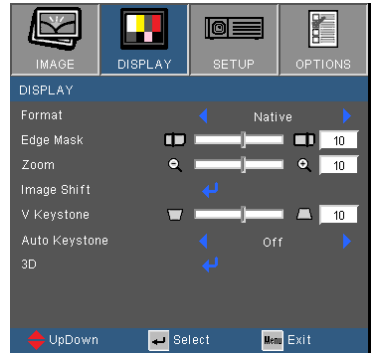

### Format

Use this function to choose your desired aspect ratio.



- ▶ 4:3: This format is for 4×3 input sources.
- ▶ 16:9: This format is for 16×9 input sources, like HDTV and DVD enhanced for Wide screen TV.
- ▶ Native: This format displays the original image without any scaling.
- ▶ AUTO: Automatically selects the appropriate display format.

Auto	Input resolution		Auto/Scale	
	H	V	H	V
4:3	640	480	1024	768
	800	600	1024	768
	1024	768	1024	768
	1280	1024	1024	768
	1400	1050	1024	768
	1600	1200	1024	768
Wide Laptop	1280	720	1024	576
	1280	768	1024	614
	1280	800	1024	640
SDTV	720	576	1024	576
	720	480	1024	576
HDTV	1280	720	1024	576
	1920	1080	1024	576

# User Controls

Aspect ratio (source detected)	Resize image (XGA)
4:3	1024 x 768 center
16:9	1024 x 576 center
Native	No resize image, 1:1 mapping and centered. This format shows the original image without scaling.

## WXGA



- ❖ 16:9 or 16:10 depend on “Screen Type” setting.

- ▶ 4:3: This format is for 4×3 input sources.
- ▶ 16:9: This format is for 16×9 input sources, like HDTV and DVD enhanced for Wide screen TV.
- ▶ 16:10: This format is for 16×10 input sources, like widescreen laptops.
- ▶ LBX: This format is for non-16x9, letterbox source and for users who use external 16x9 lens to display 2.35:1 aspect ratio using full resolution.
- ▶ Native: This format displays the original image without any scaling.
- ▶ AUTO: Automatically selects the appropriate display format.

16:10 Screen	480i/p	576i/p	1080i/p	720p	PC
4:3	1066 x 800 center				
16:10	1280 x 800 center				
LBX	1280 x 960 center, then get the central 1280 x 800 image to display				
Native	1:1 mapping centered.		1:1 mapping (960 x 540) display 1280 x 800	1280 x 720 center	1:1 mapping centered.

16:9 Screen	480i/p	576i/p	1080i/p	720p	PC
4:3	960 x 720 center				
16:9	1280 x 720 center				
LBX	1280 x 960 center, then get the central 1280 x 720 image to display				
Native	1:1 mapping centered.		1:1 mapping (960 x 540) display 1280 x 720	1280 x 720 center	1:1 mapping centered.



- ❖ Each I/O has different setting of "Edge Mask".
- ❖ "Edge Mask" and "Zoom" can't work at same time.

## Edge Mask

Edge mask function removes the noise in a video image. Edge mask the image to remove video encoding noise on the edge of video source.

## Zoom

- ▶ Press the ◀ to reduce the size of an image.
- ▶ Press the ▶ to magnify an image on the projection screen.

## Image Shift

Press ↵ into the next menu as below and then use ▲ or ▼ to select item.

- ▶ H: Use ◀ or ▶ to shift the projected image position horizontally.
- ▶ V: Use ◀ or ▶ to Shift the projected image position vertically.

## V Keystone

Press the ◀ or ▶ to adjust image distortion vertically. If the image looks trapezoidal, this option can help make the image rectangular.

## Auto Keystone<sup>(\*)</sup>

Automatically adjusts vertical image distortion.



- ❖ (\*) For Type B model only.

## DISPLAY | 3D

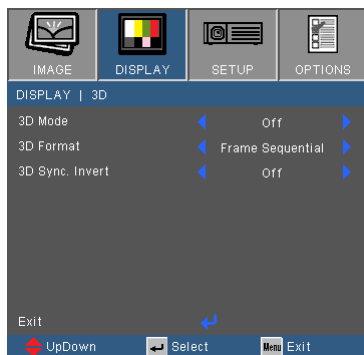

- ❖ “IR” options may vary according to model.
- ❖ “3D Sync Invert” is only available when 3D is enabled and this mode 3D is for DLP link glass only.
- ❖ Compatible 3D source, 3D content and active shutter glasses are required for 3D viewing.
- ❖ See page 63 for supported 3D formats.
- ❖ (\*) For Type B model only.

### 3D Mode

- ▶ Off: Select “Off” to turn 3D settings off for 3D images.
- ▶ DLP Link: Select “DLP Link” to use optimized settings for DLP Link 3D images.
- ▶ IR (\*): Select “IR” to use optimized settings for IR-based 3D images.

### 3D Format

- ▶ Auto : When a 3D identification signal is detected, the 3D format is selected automatically.
- ▶ SBS: Use this mode for “Side-by-side” format 3D content.
- ▶ Top and Bottom: Use this mode for “Top and Bottom” format 3D content.
- ▶ Frame Sequential: Use this mode for “Frame Sequential” format 3D content.

### 3D Sync. Invert

- ▶ Press the “On” to invert left and right frame contents.
- ▶ Press the “Off” for default frame contents.

## SETUP

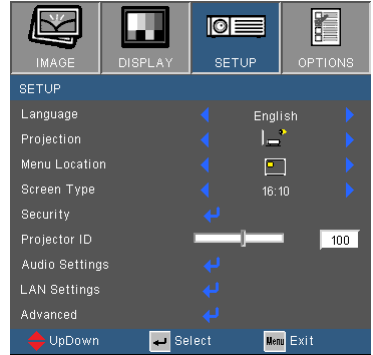

- ❖ (\*) depend on model.

### Language (\*)

Choose the multilingual OSD menu. Press ◀ or ▶ into the sub menu and then use the ▲ or ▼ key to select your preferred language. Press “Enter” to finalize the selection.



- ❖ Rear-Desktop and Rear-Ceiling are to be used with a translucent screen.

### Projection



#### Front-Desktop

This is the default selection. The image is projected straight on the screen.



#### Rear-Desktop

When selected, the image will appear reversed.



#### Front-Ceiling

When selected, the image will turn upside down.



#### Rear-Ceiling

When selected, the image will appear reversed in upside down position.

# User Controls

## Menu Location

Choose the menu location on the display screen.

## Screen Type

Choose the screen type from 16:10 or 16:9.

## Projector ID

ID definition can be set up by menu (range 0-99), and allow user control an individual projector by RS232. Refer to page 65-68 for the complete list of RS232 commands.



- ❖ “Screen Type” is for WXGA only.



## SETUP | Security

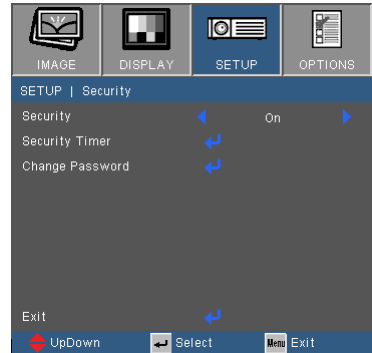

### Security

- ▶ On: Choose “On” to use security verification when the turning on the projector.
- ▶ Off: Choose “Off” to be able to switch on the projector without password verification.









- ❖ Password default value is “1234” (first time).

### Security Timer

Use this function to set the how long (Month/Day/Hour) the projector can be used. Once this time has elapsed you will be requested to enter your password again.

### Change Password

- ▶ First time:
  1. Press “” to set the password.
  2. The password has to be 4 digits.
  3. Use number button on the remote to enter your new password and then press “” key to confirm your password.
- ▶ Change Password:
  1. Press “” to input old password.
  2. Use number button to enter current password and then press “” to confirm.
  3. Enter new password (4 digits in length) using the number buttons on the remote, then press “” to confirm.
  4. Enter new password again and press “” to confirm.

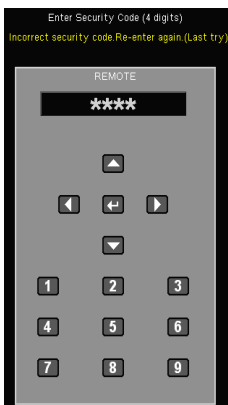

# User Controls

- ▶ If the incorrect password is entered 3 times, the projector will automatically shut down.
- ▶ If you have forgotten your password, please contact your local office for support.

## SETUP | Audio Settings



❖ (\*) For Type B model only.

### Internal Speaker (\*)

Choose the “On” or “Off” to turn on or off the internal speaker.

### Mute

- ▶ Choose the “On” to turn mute on.
- ▶ Choose the “Off” to turn mute off.

### Audio Input (\*)

The default audio settings are on the back panel of the projector. Use this option to reassign any of the Audio Inputs (1 or 2) to the current image source. Each Audio input can be assigned to more than one video source.

- ▶ Default.
- ▶ Audio 1: VGA 1 and VGA 2.
- ▶ Audio 2: Video.

### Volume

Adjust the volume from “Audio”, “MIC” connector. (\*)

- ▶ Press the ◀ to decrease the volume.
- ▶ Press the ▶ to increase the volume.

## SETUP | Advanced

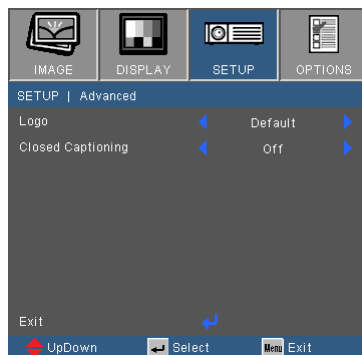

### Logo

Press  to capture an image of the picture currently displayed on screen. If changes are made they will take effect the next time the projector is powered on.

- ▶ Default: The default startup screen.
- ▶ Neutral: Logo is not displayed on startup screen.

### Closed Captioning

Use this function to set the desired startup screen. If changes are made they will take effect the next time the projector is powered on.

- ▶ Off: select "Off" to turn off the closed captioning feature.
- ▶ CC1:CC1 language: American English.
- ▶ CC2:CC2 language (depending on the TV channel of the user): Spanish, French, Portuguese, German, Danish.

## SETUP | LAN

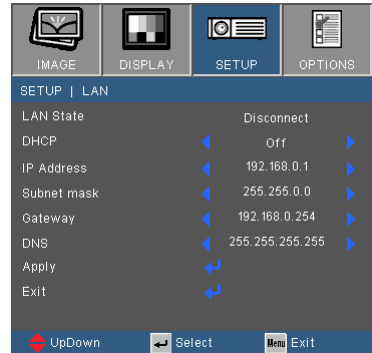

- ❖ “LAN” is for Type B model only.

### LAN State

Display the network connection status.

### DHCP

Use this function to select your desired startup screen. If you change the setting from one to another, when you exit the OSD menu, the new setting will take effect on next open.

- ▶ On: Assign an IP address to the projector from an external DHCP server automatically.
- ▶ Off: Assign an IP address manually.

### IP Address

Display an IP address.

### Subnet Mask

Display subnet mask number.

### Gateway

Display the default gateway of the network connected to the projector.

### DNS

Display DNS number.

### Apply

Press “←” and then choose “Yes” to apply the selection.

# User Controls

## How to use web browser to control your projector

1. Turn on DHCP to allow a DHCP server to automatically assign an IP, or manually enter the required network information.

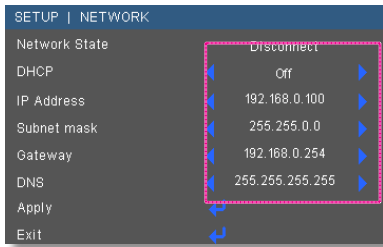

2. Then choose apply and press “←” button to complete the configuration process.
3. Open your web browser and type in IP Address from the OSD LAN screen then the web page will display as below:



- NOTE** ❖ When you use the projector IP address, you cannot link to your service server.

4. Based on network web-page for the input-string in [tools] tab, the limitation for Input-Length is in the below list (“space” and the other punctuation key included):

Category	Item	Input-Length (characters)
Crestron Control	IP Address	15
	IP ID	2
	Port	5
Projector	Projector Name	10
	Location	9
	Assigned To	9
Network Configuration	DHCP (Enabled)	(N/A)
	IP Address	15
	Subnet Mask	15
	Default Gateway	15
User Password	DNS Server	15
	Enabled	(N/A)
	New Password	15
Admin Password	Confirm	15
	Enabled	(N/A)
	New Password	15
	Confirm	15

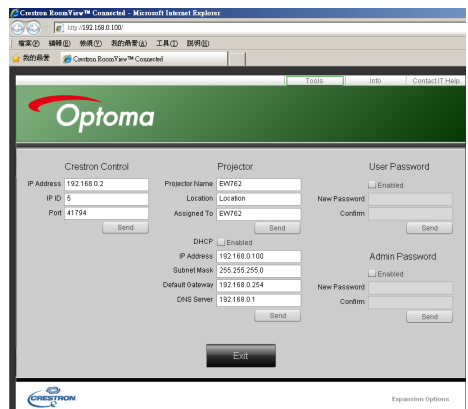

# User Controls

**When making a direct connection from your computer to the projector**

Step 1: Find an IP Address (192.168.0.100) from LAN function of projector.



Step 2: Select apply and press “Enter” button to submit function or press “menu” key to exit.

Step 3: To open Network Connections, click **Start**, click **Control Panel**, click **Network and Internet Connections**, and then click **Network Connections**. Click the connection you want to configure, and then, under **Network Tasks** , click **Change settings of this connection**.

Step 4: On the **General** tab, under **This connection uses the following items**, click **Internet Protocol (TCP/IP)**, and then click “Properties.”

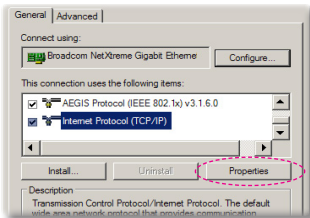

Step 5: Click **Use the following IP address**, and type in as below:

- 1) IP address: 192.168.0.100
- 2) Subnet mask: 255.255.255.0
- 3) Default gateway: 192.168.0.254

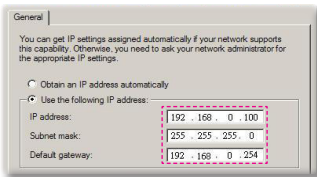

Step 6: To open Internet Options, click IE web browser, click Internet Options, click the **Connections** tab and click “LAN Settings...”

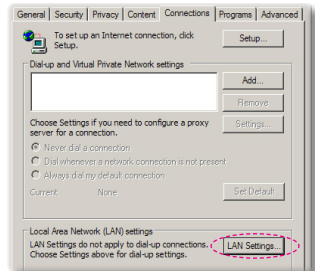

Step 7: The **Local Area Network (LAN) Setting** dialog box appears. In the **Proxy Server** area, cancel the **Use a proxy server for your LAN** check box., then click “OK” button twice.

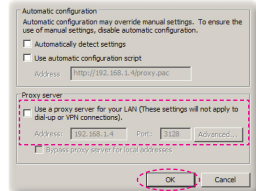

Step 8: Open your IE and type in the IP address of 192.168.0.100 in the URL then press “Enter” key.

## Crestron RoomView Control Tool

Crestron RoomView™ provides a central monitoring station for 250+ control systems on a single Ethernet network (more are possible, the number depends on the combination of IP ID and IP address). Crestron RoomView monitors each projector, including projector's online status, system power, lamp life, network setting and hardware faults, plus any custom attribute as defined by the Administrator. The Administrator can add, delete, or edit room information, contact information and events, which are logged automatically by the software for all users. (Operation UI as following image)

### 1. Main Screen

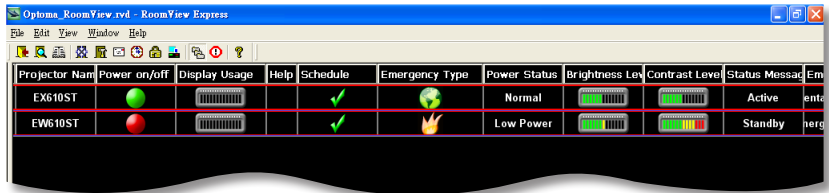

### 2. Edit Room



❖ Crestron RoomView function support is dependent on model.

Dialog box titled "Edit Room: crestron room" with tabs: General | Groups | Attributes | Assets | Contacts | Events |

Room Information

Name:  Phone:

Location:  e-Control Link:  Browse...

IP Address:  Video Link:

IPID/IP Port:

DHCP Enabled

External Gateway

SSL

Username:  Password:

Comment:

Save Room Save As Help

OK Cancel Apply



## 3. Edit Attribute

The screenshot shows the 'Edit Attribute: Display Power' dialog box. It has tabs for 'General', 'Alert', 'Groups', and 'Contacts', with 'General' selected. The 'Attribute Properties' section includes: 'Signal Name' (Display Power), 'Device' (None), 'Signal Type' (Digital), 'Join Number' (5), and 'Default Max. Value' (1). A 'Graphic' section shows 'Off' (red) and 'On' (green) indicators. The 'Options' section has checkboxes for 'Apply attribute to all rooms' (checked), 'Apply attribute to all contacts' (unchecked), 'Record attribute changes to log' (checked), 'Display on main view' (checked), and 'Show on context menu' (checked). An 'Advanced...' button is next to 'Show on context menu'. 'OK', 'Cancel', and 'Apply' buttons are at the bottom.

## 4. Edit Event

The screenshot shows the 'Edit Event: Display Off Warning' dialog box. It has tabs for 'General' and 'Rooms', with 'General' selected. The 'Event Properties' section includes: 'Name' (Display Off Warning), 'Type' (Digital), 'Join' (5), 'Enable this event' (unchecked), and 'Repeat event' (unchecked). The 'Schedule' section includes: 'Start Date' (2010/ 9/ 2), 'End Date' (2010/ 9/ 2), 'Time' (0:00:00), and checkboxes for 'Weekdays' (checked), 'Weekends' (unchecked), 'Monday' (checked), 'Tuesday' (checked), 'Wednesday' (checked), 'Thursday' (checked), 'Friday' (checked), 'Saturday' (unchecked), and 'Sunday' (unchecked). 'OK', 'Cancel', and 'Apply' buttons are at the bottom.

**For more information, please visit**  
**<http://www.crestron.com> & [www.crestron.com/getroomview](http://www.crestron.com/getroomview).**

## OPTIONS

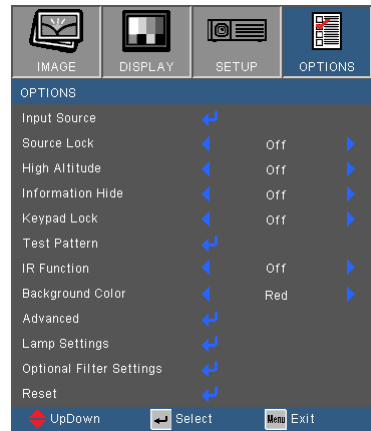

### Input Source

Use this option to enable / disable input sources. Press to enter the sub menu and select which sources you require. Press “Enter” to finalize the selection. The projector will not search for inputs that are not selected.

### Source Lock

- ▶ On: The projector will only search current input connection.
- ▶ Off: The projector will search for other signals if the current input signal is lost.

### High Altitude

When “On” is selected, the fans will spin faster. This feature is useful in high altitude areas where the air is thin.

### Information Hide

- ▶ On: Choose “On” to hide the info message.
- ▶ Off: Choose “Off” to show the “searching” message.

### Keypad Lock

When the keypad lock function is “On”, the control panel will be locked however, the projector can be operated by the remote control. By selecting “Off”, you will be able to reuse the control panel.

### Test Pattern

Display a test pattern. There are Grid, White pattern and None.

## Background Color

Use this feature to display a “Black”, “Red”, “Blue”, “Green” or “White”, screen when no signal is available.



- ❖ (\*) For Type B model only.

## IR Function (\*)

When this function is “On” , the projector can be operated by the remote control from IR receiver. By selecting “Off”, you will be able to use the control panel keys.

## Reset

Choose “Yes” to return the display parameters on all menus to the factory default settings.

## OPTIONS | Advanced

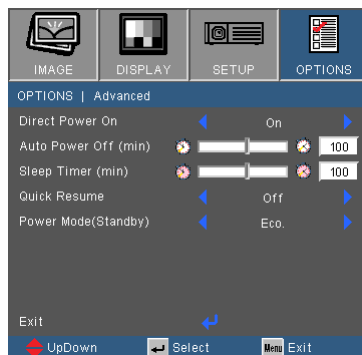

### Direct Power On

Choose “On” to activate Direct Power mode. The projector will automatically power on when AC power is supplied, without pressing the “**⏻**” key on the projector control panel or on the remote control.

### Auto Power Off (min)

Sets the countdown timer interval. The countdown timer will start, when there is no signal being sent to the projector. The projector will automatically power off when the countdown has finished (in minutes).

### Sleep Timer (min)

Sets the countdown timer interval. The countdown timer will start, with or without a signal being sent to the projector. The projector will automatically power off when the countdown has finished (in minutes).

### Quick Resume

- ▶ On: If the projector is accidentally turned off, this feature allows the projector to be instantly powered on again, if selected within a period of 100 seconds.
- ▶ Off: The fan will start cooling the system immediately when user turns off the projector.

### Power Mode (Standby)

- ▶ Eco.: Choose “Eco.” to save power dissipation further < 0.5W.
- ▶ Active: Choose “Active” to return to normal standby and the VGA out port will be enabled.



- ❖ When Power mode (Standby) is set to Eco (<0.5W), the VGA output and Audio pass-through will be deactivated when the projector is in standby.

## OPTIONS | Lamp Settings

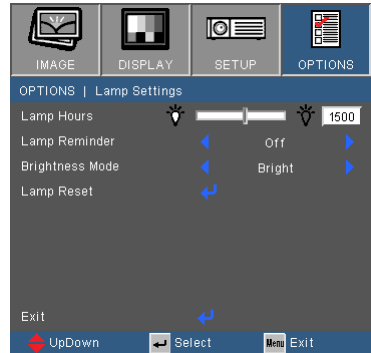

### Lamp Hours

Display the projection time.

### Lamp Reminder

Choose this function to show or to hide the warning message when the changing lamp message is displayed.

The message will appear 30 hours before suggested replacement of lamp.



❖ When ambient temperature is over 40°C in operating, the projector will switch to Eco automatically.

### Brightness Mode

- ▶ BRIGHT: Choose "BRIGHT" to increase the brightness.
- ▶ Eco.: Choose "Eco." to dim the projector lamp which will lower power consumption and extend the lamp life.
- ▶ Eco+: When Eco+ mode is activated, the brightness level of the content is automatically detected to significantly reduced lamp power consumption (up to 70%) during periods of inactivity.

### Lamp Reset

Reset the lamp hour counter after replacing the lamp.

## OPTIONS | Optional Filter Settings

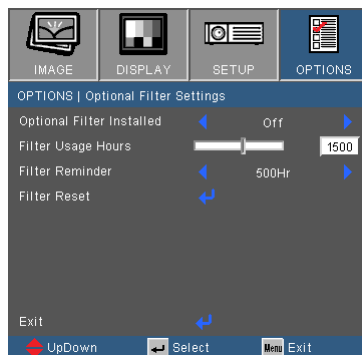

- ❖ “Optional Filter Settings” is only for Type B model.

### Optional Filter Installed

Select “Yes” to display warning message after 500 hours of use.  
Select “No” to turn off warning message.

### Filter Usage Hours

Display the filter time.

### Filter Reminder

Choose this function to show or hide the warning message when the changing filter message is displayed. (Factory default setting: 500 hours)

### Filter Reset

Reset the dust filter counter after replacing or cleaning the dust filter.

## Troubleshooting

*If you experience a problem with your projector, please refer to the following information. If a problem persists, please contact your local reseller or service center.*

### **[?]** No image appears on-screen

- ▶ Ensure all the cables and power connections are correctly and securely connected as described in the “Installation” section.
- ▶ Ensure all the pins of connectors are not bent or broken.
- ▶ Check if the projection lamp has been securely installed. Please refer to the “Replacing the lamp” section.
- ▶ Make sure you have removed the lens cap (optional) and the projector is switched on.
- ▶ Ensure that the “AV mute” feature is not turned on.

### **[?]** Partial, scrolling or incorrectly displayed image

- ▶ Press “Re-Sync” on the remote.
- ▶ If you are using a PC:

For Windows 95, 98, 2000, XP, Windows 7:

1. Open the “My Computer” icon, the “Control Panel” folder, and then double click on the “Display” icon.
2. Select the “Settings” tab.
3. Verify that your display resolution setting is lower than or equal to UXGA (1600 × 1200).
4. Click on the “Advanced Properties” button.

If the projector is still not projecting the whole image, you will also need to change the monitor display you are using. Refer to the following steps.

5. Verify the resolution setting is lower than or equal to UXGA (1600 × 1200).
6. Select the “Change” button under the “Monitor” tab.

# Appendices

7. Click on “Show all devices”. Next, select “Standard monitor types” under the SP box; choose the resolution mode you need under the “Models” box.
  8. Verify that the resolution setting of the monitor display is lower than or equal to UXGA (1600 × 1200).
- ▶ If you are using a Notebook:
1. First, follow the steps above to adjust resolution of the computer.
  2. Press the appropriate keys listed below for your notebook manufacturer to send signal out from notebook to projector.  
Example: [Fn]+[F4]

Acer ⇨	[Fn]+[F5]	IBM/Lenovo ⇨	[Fn]+[F7]
Asus ⇨	[Fn]+[F8]	HP/Compaq ⇨	[Fn]+[F4]
Dell ⇨	[Fn]+[F8]	NEC ⇨	[Fn]+[F3]
Gateway ⇨	[Fn]+[F4]	Toshiba ⇨	[Fn]+[F5]

Mac Apple:  
System Preference ⇨ Display ⇨ Arrangement ⇨ Mirror display

- ▶ If you experience difficulty changing resolutions or your monitor freezes, restart all equipment including the projector.

**?** The screen of the Notebook or PowerBook computer is not displaying your presentation

- ▶ If you are using a Notebook PC  
Some Notebook PCs may deactivate their own screens when a second display device is in use. Each has a different way to be reactivated. Refer to your computer’s manual for detailed information.

**?** Image is unstable or flickering

- ▶ Use “Phase” to correct it. See page 34 for more information.  
▶ Change the monitor color setting on your computer.

**?** Image has vertical flickering bar

- ▶ Use “Frequency” to make an adjustment. See page 34 for more information.  
▶ Check and re-configure the display mode of your graphic card to make it compatible with the projector.



## **[?]** Image is out of focus

- ▶ Make sure the lens cap (optional) is removed.
- ▶ Adjust the Focus Ring on the projector lens.
- ▶ Make sure the projection screen is between the required distance. See pages 19-20.



## **[?]** The image is stretched when displaying 16:9 DVD title

- ▶ When you play anamorphic DVD or 16:9 DVD, the projector will show the best image when the projector display mode is set to 16:9 in the OSD.
- ▶ If you play 4:3 format DVD titles, please change the format to 4:3 in the projector OSD.
- ▶ If the image is still stretched, you will also need to adjust the aspect ratio by referring to the following:
- ▶ Please setup the display format as 16:9 (wide) aspect ratio type on your DVD player.

## **[?]** Image is too small or too large

- ▶ Move the projector closer to or further from the screen.
- ▶ Press “Menu” button on the remote control, go to “Display → Format” and try the different settings.

## **[?]** Image has slanted sides

- ▶ If possible, reposition the projector so that it is horizontally centered on the screen and below the bottom of the screen.
- ▶ Press “Keystone +/-” button on the remote control or press “ / 

## **[?]** Image is reversed

- ▶ Select “SETUP → Projection” from the OSD and adjust the projection direction.



❖ Use of Keystone is not recommended.

# Appendices





## **[?]** The projector stops responding to all controls

- ▶ If possible, turn off the projector, then unplug the power cord and wait at least 60 seconds before reconnecting power.
- ▶ Check that “Keypad Lock” is not activated by trying to control the projector with the remote control.

## **[?]** Lamp burns out or makes a popping sound

- ▶ When the lamp reaches its end of life, it will burn out and may make a loud popping sound. If this happens, the projector will not turn on until the lamp module has been replaced. To replace the lamp, follow the procedures in the “Replacing the Lamp” section on pages 60-61.

## **[?]** LED lighting message

Message	 POWER/STAND- BY LED	 Temp-LED	 Lamp-LED
	(Green/Amber)	(Red)	(Red)
Standby State (Input power cord)	Amber	○	○
Power on (Warming)	Flashing Green	○	○
Lamp lighting	Green	○	○
Power off (Cooling)	Flashing Green	○	○
Quick Resume(100 secs)	Flashing Green	○	○
Error (Over Temp.)	Flashing Amber		○
Error (Fan fail)	Flashing Amber	Flashing	○
Error (Lamp fail)	Flashing Amber	○	

\* POWER/STANDBY LED be ON when OSD appears, be OFF when OSD disappears.



Steady light ⇒   
No light ⇒ ○

## ? On Screen Messages

### ▶ Temperature warning:

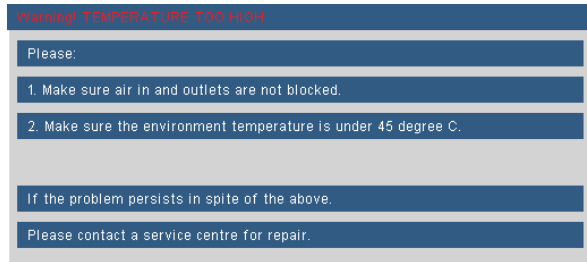

### ▶ Fan failed:

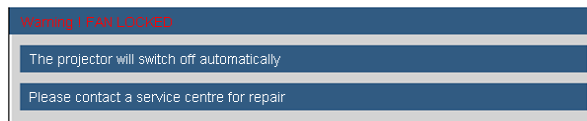

### ▶ Lamp warning:

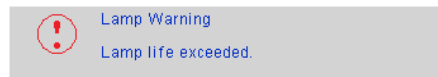

### ▶ Out of display range:

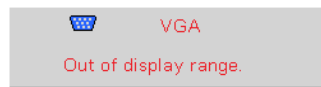

### ▶ Filter warning:

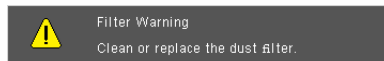

## ? If the remote control does not work

- ▶ Check the operating angle of the remote control is within  $\pm 15^\circ$  both horizontally and vertically of one of the IR receivers on the projector.
- ▶ Make sure there are not any obstructions between the remote control and the projector. Move to within 7 m ( $\pm 0^\circ$ ) of the projector.
- ▶ Make sure the batteries are inserted correctly.
- ▶ Replace batteries if they are exhausted.

## Replacing the lamp

The projector automatically detects the lamp life. When the lamp life is nearing the end of use, you will receive a warning message.

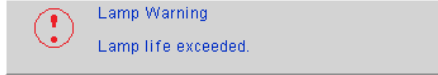

When you see this message, please contact your local reseller or service center to change the lamp as soon as possible. Make sure the projector has been cooled down for at least 30 minutes before changing the lamp.



   **CAUTION!**

HIGH PRESSURE LAMP MAY EXPLODE IF IMPROPERLY HANDED. REFER TO LAMP REPLACEMENT INSTRUCTIONS.

**ATTENTION:**

Les lampes à haute pression peuvent exploser si elles sont mal utilisées.

Confier l'entretien à une personne qualifiée.

-  Warning: If ceiling mounted, please use caution when opening the lamp access panel. It is recommended to wear safety glasses if changing the bulb when ceiling mounted. “Caution must be used to prevent any loose parts from falling out of projector.”
-  Warning: Lamp compartment may be hot! Allow it to cool down before changing the lamp!
-  Warning: To reduce the risk of personal injury, do not drop the lamp module or touch the lamp bulb. The bulb may shatter and cause injury if it is dropped.

## NOTE

- ❖ The screws on the lamp cover and the lamp cannot be removed.
- ❖ The projector cannot be turned on if the lamp cover has not been placed back on the projector.
- ❖ Do not touch the glass area of the lamp. Hand oil can cause the lamp to shatter. Use a dry cloth to clean the lamp module if it was accidentally touched.

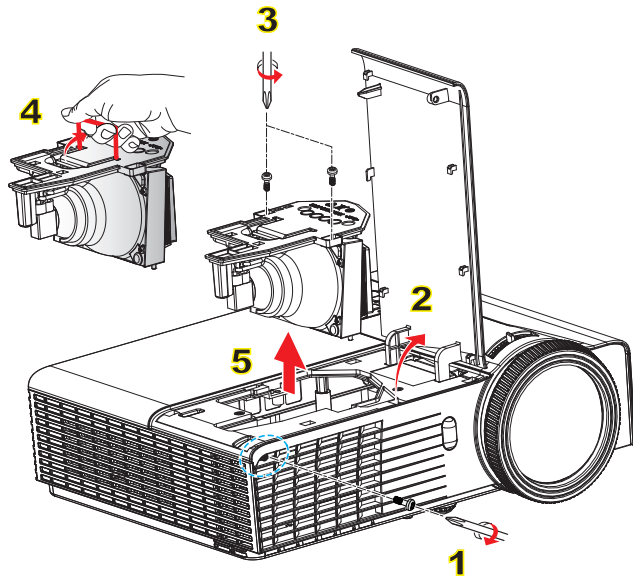

### Lamp Replacement Procedure:

1. Switch off the power to the projector by pressing the “” button.
  2. Allow the projector to cool down for at least 30 minutes.
  3. Disconnect the power cord.
  4. Unscrew the two screws on the cover. **1**
  5. Lift up and remove the cover. **2**
  6. Unscrew the two screws on the lamp module. **3**
  7. Lift up the lamp handle **4** and remove the lamp module slowly and carefully. **5**
- To replace the lamp module, reverse the previous steps.
8. Turn on the projector and reset the lamp timer.

Lamp Reset: (i) Press “Menu” → (ii) Select “OPTIONS” → (iii) Select “Lamp Settings” → (iv) Select “Lamp Reset” → (v) Select “Yes”.

## Compatibility Modes

### ► Computer/Video/HDMI/Mac Compatibility



- ❖ For widescreen resolution (WXGA), the compatibility support is dependent on Notebook/PC models.
- ❖ Please note that using resolutions other than native 1024 x 768 (XGA model), 1280 x 800 (WXGA model) may result in some loss of image clarity.
- ❖ (\*1) 1920 x 1200 @60Hz only support RB (reduced blanking).
- ❖ (\*2) 3D timing for True 3D projector.
- ❖ (\*3) is not supported HDMI input signal for Mac.
- ❖ (\*4) is only for Type A model.
- ❖ 120Hz input signals may be dependent on graphics cards support.

Signal	Resolution	Refresh Rate (Hz)	Video	Analog	HDMI	Mac	
NTSC	720 x 480	60	O	-	-	-	
PAL/SECAM	720 x 576	50	O	-	-	-	
VGA	640 x 480	60	-	O	O	O	
	640 x 480	67	-	O	-	-	
	640 x 480	72.8	-	O	-	O	
	640 x 480	85	-	O	-	O	
SVGA	800 x 600	56.3	-	O	-	-	
	800 x 600	60.3 <sup>(*2)</sup>	-	O	O	O	
	800 x 600	72.2	-	O	O	O	
	800 x 600	85.1	-	O	O	O	
XGA	800 x 600	120 <sup>(*2)</sup>	-	O	O	-	
	1024 x 768	60 <sup>(*2)</sup>	-	O	O	O	
	1024 x 768	70.1	-	O	O	O	
	1024 x 768	75	-	O	O	O	
	1024 x 768	85	-	O	O	O	
WSVGA	1024 x 768	120 <sup>(*2)</sup>	-	O	O	-	
	1024 x 600	60	-	-	O	O	
	HDTV (720p)	1280 x 720	50	O	O	O	-
		1280 x 720	60 <sup>(*2)</sup>	O	O	O	O
		1280 x 720	120 <sup>(*2)</sup>	-	O	O	-
WXGA	1280 x 768	60	-	O	O	O <sup>(*3)</sup>	
	1280 x 768	75	-	O	O	O	
	1280 x 768	85	-	O	O	O <sup>(*3)</sup>	
	1280 x 800	60	-	O	O	O	
	1366 x 768	60 <sup>(*4)</sup>	-	O	O	-	
WXGA+	1440 x 900	60 <sup>(*4)</sup>	-	O	O	-	
	SXGA	1280 x 1024	60	-	O	O	O
		1280 x 1024	75	-	O	O	O
1280 x 1024		85	-	O	O	-	
SXGA+	1400 x 1050	60	-	O	O	-	
UXGA	1600 x 1200	60	-	O	O	-	
HDTV (1080p)	1920 x 1080	24	O	O	O	-	
	1920 x 1080	30	-	-	O	-	
	1920 x 1080	50	O	O	O	-	
	1920 x 1080	60	O	O	O	O	
HDTV (1080i)	1920 x 1080	50	O	-	O	-	
	1920 x 1080	60	O	-	O	-	
WUXGA	1920 x 1200	60 <sup>(*1)</sup>	-	O	O	O	

# Appendices

Signal	Resolution	Refresh Rate (Hz)	Video	Analog	HDMI	Mac
SDTV (576i)	768 x 576	50	O	-	O	-
SDTV (576p)	768 x 576	50	O	-	O	-
SDTV (480i)	640 x 480	60	O	-	O	-
SDTV (480p)	640 x 480	60	O	-	O	-

## ▶ 3D Input Video Compatibility

Input Resolution	HDMI 1.4a 3D Input	Input Timing		
		1280 x 720p @ 50Hz	Top-and-Bottom	
	1280 x 720p @ 60Hz	Top-and-Bottom		
	1280 x 720p @ 50Hz	Frame packing		
	1280 x 720p @ 60Hz	Frame packing		
	1920 x 1080i @ 50 Hz	Side-by-Side (Half)		
	1920 x 1080i @ 60 Hz	Side-by-Side (Half)		
	1920 x 1080p @ 24 Hz	Top-and-Bottom		
	1920 x 1080p @ 24 Hz	Frame packing		
	HDMI 1.3 3D Content	1920 x 1080i @ 50Hz	Side-by-Side (Half)	While 3D Format is "SBS"
		1920 x 1080i @ 60Hz		
		1280 x 720p @ 50Hz		
		1280 x 720p @ 60Hz		
	HDMI 1.3 3D Content	1920 x 1080i @ 50Hz	Top-and-Bottom	While 3D Format is "Top and Bottom"
		1920 x 1080i @ 60Hz		
		1280 x 720p @ 50Hz		
		1280 x 720p @ 60Hz		
		480i	HQFS	While 3D Format is "Frame sequential"

## RS232 Commands and Protocol Function List

### RS232 Pin Assignments



- ❖ RS232 shell is grounded.

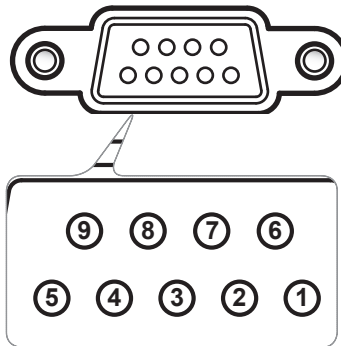

Pin no.	Spec. (from projector side)
1	N/A
2	RXD
3	TXD
4	N/A
5	GND
6	N/A
7	N/A
8	N/A
9	N/A



## RS232 Protocol Function List



1. There is a <CR> after all ASCII commands.
2. 0D is the HEX code for <CR> in ASCII code.

Baud Rate : 9600

Data Bits: 8

Parity: None

Stop Bits: 1

Flow Control : None

UART16550 FIFO: Disable

Projector Return (Pass): P

Projector Return (Fail): F

XX=00-99, projector's ID,  
XX=00 is for all projectors

### SEND to projector (telnet supported)

E32 ASCII Code	HEX Code	Function	Description
-XX00 1	7E 30 30 30 30 20 31 0D	Power ON	
-XX00 0	7E 30 30 30 30 20 30 0D	Power OFF	(0/2 for backward compatible)
-XX00 1 ~nmm	7E 30 30 30 30 20 31 20 a 0D	Power ON with Password	-nmm = -0000 (a=7E 30 30 30 30) ~9999 (a=7E 39 39 39 39)
-XX01 1	7E 30 30 30 31 20 31 0D	Resync	
-XX02 1	7E 30 30 30 32 20 31 0D	AV Mute	On Off (0/2 for backward compatible)
-XX03 1	7E 30 30 30 33 20 31 0D	Mute	On Off (0/2 for backward compatible)
-XX04 1	7E 30 30 30 34 20 31 0D	Freeze	
-XX04 0	7E 30 30 30 34 20 30 0D	Unfreeze	(0/2 for backward compatible)
-XX05 1	7E 30 30 30 35 20 31 0D	Zoom Plus	
-XX06 1	7E 30 30 30 36 20 31 0D	Zoom Minus	
(Type A : X305ST/W305ST)			
-XX12 1	7E 30 30 31 32 20 31 0D		HDMI
-XX12 5	7E 30 30 31 32 20 35 0D		VGA 1
-XX12 6	7E 30 30 31 32 20 36 0D		VGA 2
-XX12 9	7E 30 30 31 32 20 39 0D		S-Video
-XX12 10	7E 30 30 31 32 20 31 30 0D		Video
-XX100 3	7E 30 30 31 30 30 20 33 0D		Next source
(Type B : X306ST/W306ST)			
-XX12 7	7E 30 30 31 32 20 37 0D		VGA1 SCART
-XX12 8	7E 30 30 31 32 20 38 0D		VGA1 Component
-XX12 9	7E 30 30 31 32 20 39 0D		VGA2 Component
-XX12 10	7E 30 30 31 32 20 31 30 0D		Video
-XX100 3	7E 30 30 31 30 30 20 33 0D		Next source
-XX20 1	7E 30 30 32 30 20 31 0D	Display Mode	Presentation
-XX20 2	7E 30 30 32 30 20 32 0D		Bright
-XX20 3	7E 30 30 32 30 20 33 0D		Movie
-XX20 4	7E 30 30 32 30 20 34 0D		sRGB
-XX20 5	7E 30 30 32 30 20 35 0D		User
-XX20 7	7E 30 30 32 30 20 37 0D		Blackboard
-XX20 8	7E 30 30 32 30 20 39 0D		3D
-XX21 n	7E 30 30 32 31 20 a 0D	Brightness	n = -50 (a=2D 35 30) ~ 50 (a=35 30)
-XX22 n	7E 30 30 32 32 20 a 0D	Contrast	n = -50 (a=2D 35 30) ~ 50 (a=35 30)
-XX23 n	7E 30 30 32 33 20 a 0D	Sharpness	n = 1 (a=31) ~ 15 (a=31 35)
-XX170 n	7E 30 30 31 37 30 20 a 0D	Color Settings	Red Hue n = -45 (a=2D 34 35) ~ +45 (a=34 35) Red Saturation n = -45 (a=2D 34 35) ~ +45 (a=34 35) Red Gain n = -50 (a=2D 35 30) ~ 50 (a=35 30) Green Hue n = -45 (a=2D 34 35) ~ +45 (a=34 35) Green Saturation n = -45 (a=2D 34 35) ~ +45 (a=34 35) Green Gain n = -50 (a=2D 35 30) ~ 50 (a=35 30) Blue Hue n = -45 (a=2D 34 35) ~ +45 (a=34 35) Blue Saturation n = -45 (a=2D 34 35) ~ +45 (a=34 35) Blue Gain n = -50 (a=2D 35 30) ~ 50 (a=35 30) Cyan Hue n = -45 (a=2D 34 35) ~ +45 (a=34 35) Cyan Saturation n = -45 (a=2D 34 35) ~ +45 (a=34 35) Cyan Gain n = -50 (a=2D 35 30) ~ 50 (a=35 30) Magenta Hue n = -45 (a=2D 34 35) ~ +45 (a=34 35) Magenta Saturation n = -45 (a=2D 34 35) ~ +45 (a=34 35) Magenta Gain n = -50 (a=2D 35 30) ~ 50 (a=35 30) Yellow Hue n = -45 (a=2D 34 35) ~ +45 (a=34 35) Yellow Saturation n = -45 (a=2D 34 35) ~ +45 (a=34 35) Yellow Gain n = -50 (a=2D 35 30) ~ 50 (a=35 30) Reset
-XX24 n	7E 30 30 32 34 20 a 0D		
-XX172 n	7E 30 30 31 37 32 20 a 0D		
-XX173 n	7E 30 30 31 37 33 20 a 0D		
-XX25 n	7E 30 30 32 35 20 a 0D		
-XX174 n	7E 30 30 31 37 34 20 a 0D		
-XX175 n	7E 30 30 31 37 35 20 a 0D		
-XX26 n	7E 30 30 32 36 20 a 0D		
-XX176 n	7E 30 30 31 37 36 20 a 0D		
-XX177 n	7E 30 30 31 37 37 20 a 0D		
-XX30 n	7E 30 30 33 30 20 a 0D		
-XX180 n	7E 30 30 31 38 30 20 a 0D		
-XX181 n	7E 30 30 31 38 31 20 a 0D		
-XX32 n	7E 30 30 33 32 20 a 0D		
-XX178 n	7E 30 30 31 37 38 20 a 0D		
-XX179 n	7E 30 30 31 37 39 20 a 0D		
-XX31 n	7E 30 30 33 31 20 a 0D		
-XX33 1	7E 30 30 33 33 20 31 0D		
-XX34 n	7E 30 30 33 34 20 a 0D	BrilliantColor™	n = 0 (a=30) ~ 10 (a=31 30)
-XX35 1	7E 30 30 33 35 20 31 0D	Degamma	Film
-XX35 2	7E 30 30 33 35 20 32 0D		Video
-XX35 3	7E 30 30 33 35 20 33 0D		Graphics
-XX35 4	7E 30 30 33 35 20 34 0D		Standard
-XX36 1	7E 30 30 33 36 20 31 0D	Color Temp.	Warm
-XX36 2	7E 30 30 33 36 20 32 0D		Medium
-XX36 3	7E 30 30 33 36 20 33 0D		Cold

# Appendices

~XX37 1	7E 30 30 33 37 20 31 0D	Color Space	Auto	
~XX37 2	7E 30 30 33 37 20 32 0D		RGB/RGB(0-255)	
~XX37 3	7E 30 30 33 37 20 33 0D		YUV	
~XX37 4	7E 30 30 33 37 20 34 0D		RGB(16 - 235)	
~XX45 n	7E 30 30 34 34 20 a 0D	Color (Saturation)	n = -50 (a=2D 35 30) ~ 50 (a=35 30)	
~XX44 n	7E 30 30 34 35 20 a 0D	Tint	n = -50 (a=2D 35 30) ~ 50 (a=35 30)	
~XX60 1	7E 30 30 36 30 20 31 0D	Format	4:3	
~XX60 2	7E 30 30 36 30 20 32 0D		16:9	
~XX60 3	7E 30 30 36 30 20 33 0D		16:10 (WXGA)	
~XX60 5	7E 30 30 36 30 20 35 0D		LBX	
~XX60 6	7E 30 30 36 30 20 36 0D		Native	
~XX60 7	7E 30 30 36 30 20 37 0D		Auto	
~XX61 n	7E 30 30 36 31 20 a 0D	Edge mask	n = 0 (a=30) ~ 10 (a=31 30)	
~XX62 n	7E 30 30 36 32 20 a 0D	Zoom	n = -5 (a=2D 35) ~ 25 (a=32 35)	
~XX63 n	7E 30 30 36 33 20 a 0D	H Image Shift	n = -50 (a=2D 35 30) ~ 50 (a=35 30)	
~XX64 n	7E 30 30 36 34 20 a 0D	V Image Shift	n = -50 (a=2D 35 30) ~ 50 (a=35 30)	
~XX66 n	7E 30 30 36 36 20 a 0D	V Keystone	n = -40 (a=2D 34 30) ~ 40 (a=34 30)	
~XX230 3	7E 30 30 32 33 30 20 31 0D	3D Mode	Off (Type-A model)	
~XX230 1	7E 30 30 32 33 30 20 31 0D	3D Mode	DLP-Link	
~XX230 2	7E 30 30 32 33 30 20 31 0D	3D Mode	IR (Type B model)	
~XX405 0	7E 30 30 34 30 35 20 30 0D	3D format	Off	
~XX405 1	7E 30 30 34 30 35 20 31 0D	3D format	SBS	
~XX405 2	7E 30 30 34 30 35 20 32 0D	3D format	Top and Bottom	
~XX405 3	7E 30 30 34 30 35 20 33 0D	3D format	Frame Sequential	
~XX231 1	7E 30 30 32 33 31 20 31 0D	3D Sync Invert	On	
~XX231 0	7E 30 30 32 33 31 20 30 0D	3D Sync Invert	Off (0/2 for backward compatible)	
~XX70 1	7E 30 30 37 30 20 31 0D	Language	English	
~XX70 2	7E 30 30 37 30 20 32 0D		German	
~XX70 3	7E 30 30 37 30 20 33 0D		French	
~XX70 4	7E 30 30 37 30 20 34 0D		Italian	
~XX70 5	7E 30 30 37 30 20 35 0D		Spanish	
~XX70 6	7E 30 30 37 30 20 36 0D		Portuguese	
~XX70 7	7E 30 30 37 30 20 37 0D		Polish	
~XX70 8	7E 30 30 37 30 20 38 0D		Dutch	
~XX70 9	7E 30 30 37 30 20 39 0D		Swedish	
~XX70 10	7E 30 30 37 30 20 31 30 0D		Norwegian/Danish	
~XX70 11	7E 30 30 37 30 20 31 31 0D		Finnish	
~XX70 12	7E 30 30 37 30 20 31 32 0D		Greek	
~XX70 13	7E 30 30 37 30 20 31 33 0D		Traditional Chinese	
~XX70 14	7E 30 30 37 30 20 31 34 0D		Simplified Chinese	
~XX70 15	7E 30 30 37 30 20 31 35 0D		Japanese	
~XX70 16	7E 30 30 37 30 20 31 36 0D		Korean	
~XX70 17	7E 30 30 37 30 20 31 37 0D		Russian	
~XX70 18	7E 30 30 37 30 20 31 38 0D		Hungarian	
~XX70 19	7E 30 30 37 30 20 31 39 0D		Czech	
~XX70 20	7E 30 30 37 30 20 32 30 0D		Arabic	
~XX70 21	7E 30 30 37 30 20 32 31 0D		Thai	
~XX70 22	7E 30 30 37 30 20 32 32 0D		Turkish	
~XX70 23	7E 30 30 37 30 20 32 33 0D		Farsi	
~XX70 25	7E 30 30 37 30 20 32 35 0D		Vietnamese	
~XX70 26	7E 30 30 37 30 20 32 36 0D		Indonesia	
~XX70 27	7E 30 30 37 30 20 32 37 0D		Romanian	
~XX71 1	7E 30 30 37 31 20 31 0D	Projection	Front-Desktop	
~XX71 2	7E 30 30 37 31 20 32 0D		Rear-Desktop	
~XX71 3	7E 30 30 37 31 20 33 0D		Front-Ceiling	
~XX71 4	7E 30 30 37 31 20 34 0D		Rear-Ceiling	
~XX72 1	7E 30 30 37 32 20 31 0D	Menu Location	Top Left	
~XX72 2	7E 30 30 37 32 20 32 0D		Top Right	
~XX72 3	7E 30 30 37 32 20 33 0D		Centre	
~XX72 4	7E 30 30 37 32 20 34 0D		Bottom Left	
~XX72 5	7E 30 30 37 32 20 35 0D		Bottom Right	
WXGA only		Screen Type	16:10	
~XX90 1	7E 30 30 39 31 20 31 0D		16:9	
~XX90 0	7E 30 30 39 31 20 30 0D			
~XX73 n	7E 30 30 37 33 20 a 0D	Signal	Frequency	n = -5 (a=2D 35) ~ 5 (a=35) By signal
~XX91 n	7E 30 30 39 31 20 a 0D		Automatic	n = 0 disable; n = 1 enable
~XX74 n	7E 30 30 37 34 20 a 0D		Phase	n = 0 (a=30) ~ 31 (a=33 31) By signal
~XX75 n	7E 30 30 37 35 20 a 0D		H. Position	n = -5 (a=2D 35) ~ 5 (a=35) By timing
~XX76 n	7E 30 30 37 36 20 a 0D		V. Position	n = -5 (a=2D 35) ~ 5 (a=35) By timing
~XX77 n	7E 30 30 37 37 20 aabbcc 0D	Security	Security Timer	Month/Day/Hour n = mm/dd/hh mm= 00 (aa=30 30) ~ 12 (aa=31 32) dd = 00 (bb=30 30) ~ 30 (bb=33 30) hh= 00 (cc=30 30) ~ 24 (cc=32 34)
~XX78 1	7E 30 30 37 38 20 31 0D	Security Settings	Enable	
~XX78 0 ~nnnn	7E 30 30 37 38 20 32 20 a 0D		Disable(0/2 for backward compatible)	
			~nnnn = -0000 (a=7E 30 30 30 30)	
			~9999 (a=7E 39 39 39 39)	
~XX79 n	7E 30 30 37 39 20 a 0D	Projector ID	n = 00 (a=30 30) ~ 99 (a=39 39)	

# Appendices

## Type B model only

~XX310 1	7E 30 30 33 31 30 20 31 0D	Internal Speaker	On
~XX310 0	7E 30 30 33 31 30 20 30 0D		Off (0/2 for backward compatible)
~XX80 1	7E 30 30 38 30 20 31 0D	Mute	On
~XX80 0	7E 30 30 38 30 20 30 0D		Off (0/2 for backward compatible)
~XX81 n	7E 30 30 38 31 20 a 0D	Volume Logo	n = 0 (a=30) ~ 10 (a=31 30)
~XX82 1	7E 30 30 38 32 20 31 0D		Default
~XX82 3	7E 30 30 38 32 20 33 0D	Closed Captioning	Neutral
~XX88 0	7E 30 30 38 38 20 30 0D		Off
~XX88 1	7E 30 30 38 38 20 31 0D		cc1
~XX88 2	7E 30 30 38 38 20 32 0D		cc2
~XX100 1	7E 30 30 31 30 30 20 31 0D	Source Lock	On
~XX100 0	7E 30 30 31 30 30 20 30 0D		Off (0/2 for backward compatible)
~XX100 3	7E 30 30 31 30 30 20 33 0D	Next Source High Altitude	On
~XX101 1	7E 30 30 31 30 31 20 31 0D		Off (0/2 for backward compatible)
~XX101 0	7E 30 30 31 30 31 20 30 0D	Information Hide	On
~XX102 1	7E 30 30 31 30 32 20 31 0D		Off (0/2 for backward compatible)
~XX102 0	7E 30 30 31 30 32 20 30 0D	Keypad Lock	On
~XX103 1	7E 30 30 31 30 33 20 31 0D		Off (0/2 for backward compatible)
~XX103 0	7E 30 30 31 30 33 20 30 0D	Background Color	Blue
~XX104 1	7E 30 30 31 30 34 20 31 0D		Black
~XX104 2	7E 30 30 31 30 34 20 32 0D		Red
~XX104 3	7E 30 30 31 30 34 20 33 0D		Green
~XX104 4	7E 30 30 31 30 34 20 34 0D		White
~XX104 5	7E 30 30 31 30 34 20 35 0D		
~XX105 1	7E 30 30 31 30 35 20 31 0D	Advanced	Direct Power On On
~XX105 0	7E 30 30 31 30 35 20 30 0D		Off (0/2 for backward compatible)
~XX106 n	7E 30 30 31 30 36 20 a 0D		Auto Power Off (min) n = 0 (a=30) ~ 180 (a=31 38 30)
~XX107 n	7E 30 30 31 30 37 20 a 0D		Sleep Timer (min) n = 0 (a=30) ~ 995 (a=39 39 39)
~XX115 1	7E 30 30 31 31 35 20 31 0D		Quick Resume On
~XX115 0	7E 30 30 31 31 35 20 30 0D		Off (0/2 for backward compatible)
~XX114 1	7E 30 30 31 31 34 20 31 0D		Power Mode(Standby) Eco.(≤=0.5W)
~XX114 0	7E 30 30 31 31 34 20 30 0D		Active (0/2 for backward compatible)
~XX322 1	7E 30 30 33 32 32 20 31 0D		Filter Reminder On
~XX322 0	7E 30 30 33 32 32 20 30 0D		Off (0/2 for backward compatible)
~XX323 1	7E 30 30 33 32 33 20 31 0D	Filter Reset Yes	
~XX323 0	7E 30 30 33 32 33 20 30 0D	No (0/2 for backward compatible)	
~XX321 1	7E 30 30 33 32 31 20 31 0D	Filter Hour	
~XX109 1	7E 30 30 31 30 39 20 31 0D	Lamp Reminder	On
~XX109 0	7E 30 30 31 30 39 20 30 0D		Off (0/2 for backward compatible)
~XX110 1	7E 30 30 31 31 30 20 31 0D	Brightness Mode	Bright
~XX110 2	7E 30 30 31 31 30 20 32 0D		Eco
~XX110 3	7E 30 30 31 31 30 20 33 0D		Eco+
~XX111 1	7E 30 30 31 31 31 20 31 0D	Lamp Reset	Yes
~XX111 0	7E 30 30 31 31 31 20 30 0D		No (0/2 for backward compatible)
~XX320 1	7E 30 30 33 32 30 20 31 0D	Optional Filter Installed	Yes
~XX320 0	7E 30 30 33 32 30 20 30 0D		No (0/2 for backward compatible)
~XX322 0	7E 30 30 33 32 32 20 30 0D		Filter Reminder Off
~XX322 1	7E 30 30 33 32 32 20 31 0D		Filter Reminder 300hr
~XX322 2	7E 30 30 33 32 32 20 32 0D		Filter Reminder 500hr
~XX322 3	7E 30 30 33 32 32 20 33 0D		Filter Reminder 1000hr
~XX323 1	7E 30 30 33 32 33 20 31 0D		Filter Reset Yes
~XX323 0	7E 30 30 33 32 33 20 30 0D		Filter Reset No (0/2 for backward compatible)
~XX195 0	7E 30 30 31 39 35 20 30 0D	Test pattern	None
~XX195 1	7E 30 30 31 39 35 20 31 0D		Grid
~XX195 2	7E 30 30 31 39 35 20 32 0D		White Pattern
~XX112 1	7E 30 30 31 31 32 20 31 0D	Reset	Yes
~XX99 1	7E 30 30 39 39 20 31 0D	RS232 Alert Reset Display message on the OSD	Reset System Alert
~XX210 n	7E 30 30 32 30 30 20 n 0D		n: 1-30 characters
<b>SEND to emulate Remote</b>			
~XX140 10	7E 30 30 31 34 30 20 31 30 0D	Up	
~XX140 11	7E 30 30 31 34 30 20 31 31 0D	Left	
~XX140 12	7E 30 30 31 34 30 20 31 32 0D	Enter (for projection MENU)	
~XX140 13	7E 30 30 31 34 30 20 31 33 0D	Right	
~XX140 14	7E 30 30 31 34 30 20 31 34 0D	Down	
~XX140 15	7E 30 30 31 34 30 20 31 35 0D	Keystone +	
~XX140 16	7E 30 30 31 34 30 20 31 36 0D	Keystone -	
~XX140 17	7E 30 30 31 34 30 20 31 37 0D	Volume -	
~XX140 18	7E 30 30 31 34 30 20 31 38 0D	Volume +	
~XX140 19	7E 30 30 31 34 30 20 31 39 0D	Brightness	
~XX140 20	7E 30 30 31 34 30 20 32 30 0D	Menu	
~XX140 21	7E 30 30 31 34 30 20 32 31 0D	Zoom	

# Appendices

## SEND from projector automatically

232 ASCII Code	HEX Code	Function	Projector Return	Description
		System status	INFO	n : 0/1/2/3/4/6/7/8 = Standby/Warming/Cooling/Out of Range/ Lamp fail/Fan Lock/Over Temperature/ Lamp Hours Running Out

## READ from projector (telnet supported)

232 ASCII Code	HEX Code	Function	Projector Return	Description
~XX121 1	7E 30 30 31 32 31 20 31 0D	Input Source	OKn (Type A model) (Type B model)	n : 0/1/2/3/4/5 = None/VGA1/VGA2/S-Video/Video/HDMI n : 0/1/2/3/4 = None/VGA1/VGA2/Video/HDMI
~XX122 1	7E 30 30 31 32 32 20 31 0D	Software Version	OKdddd	dddd: FW version
~XX123 1	7E 30 30 31 32 33 20 31 0D	Display Mode	OKn	n : 0/1/2/3/4/5/6/7 = None/Presentation/Bright/Movie/sRGB/ User/Blackboard/3D n : 0/1 = Off/On
~XX124 1	7E 30 30 31 32 34 20 31 0D	Power State	OKn	
~XX125 1	7E 30 30 31 32 35 20 31 0D	Brightness	OKn	
~XX126 1	7E 30 30 31 32 36 20 31 0D	Contrast	OKn	
~XX127 1	7E 30 30 31 32 37 20 31 0D	Aspect Ratio	OKn	n : 0/1/2/3 = 4:3/16:9/Native/AUTO (XGA) n : 0/1/2/3/4/5 = 4:3/16:9/16:10/LBX/Native/AUTO (WXGA)
~XX128 1	7E 30 30 31 32 38 20 31 0D	Color Temperature	OKn	n : 0/1/2 = Warm/Medium/Cold
~XX129 1	7E 30 30 31 32 39 20 31 0D	Projection Mode	OKn	n : 0/1/2/3 = Front-Desktop/Rear-Desktop/Front-Ceiling/ Rear-Ceiling
~XX150 1	7E 30 30 31 35 30 31 0D	Information	OKabbbccddddd  (Type A model) (Type B model)	a : 0/1 = Off/On bbbb: LampHour cc: source 00/01/02/03/04/05 = None/VGA1/VGA2/S-Video/Video/HDMI 00/01/02/03/04 = None/VGA1/VGA2/Video/HDMI dddd: FW version e : Display mode 0/1/2/3/4/5/6/7 = None/Presentation/Bright/Movie/ sRGB/User/Blackboard/3D
~XX151 1	7E 30 30 31 35 31 20 31 0D	Model name	OKn	(Type A) n:1/2 = X305ST/W305ST (Type B) n:1/2 = X306ST/W306ST
~XX108 1	7E 30 30 31 30 38 20 31 0D	Lamp Hours	OKbbbb	bbbb: LampHour
~XX108 2	7E 30 30 31 30 38 20 31 0D	Cumulative Lamp Hours	OKbbbb	bbbb: (5 digits) Total Lamp Hours

## Wall Mount Installation

1. To prevent damage to your projector, please use the Optoma ceiling mount.
2. If you wish to use a third party ceiling mount kit, please ensure the screws used to attach a mount to the projector meet the following specifications:

- ▶ Screw type: M4\*3
- ▶ Maximum screw length: 11mm
- ▶ Minimum screw length: 8mm



❖ Please note that damage resulting from incorrect installation will void the warranty.



### ⚠ Warning:

1. If you buy a ceiling mount from another company, please be sure to use the correct screw size. Screw size will vary depending on the thickness of the mounting plate.
2. Be sure to keep at least 10 cm gap between the ceiling and the bottom of the projector.
3. Avoid installing the projector near a heat source.

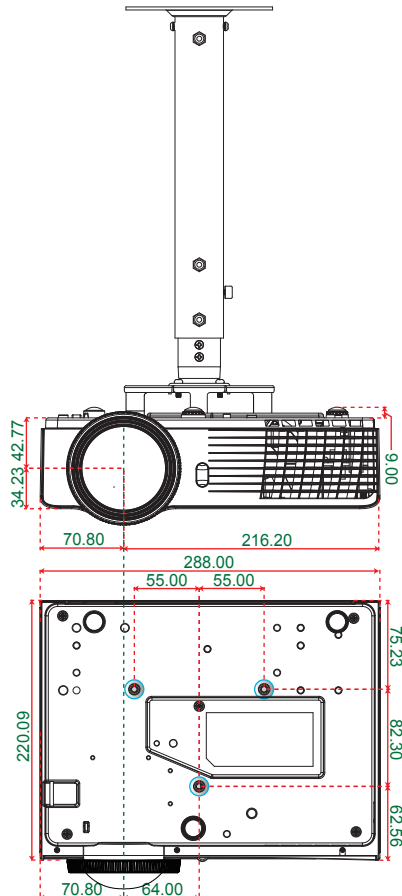

Unit: mm



Lens

## Optoma Global Offices

*For service or support please contact your local office.*



### USA

3178 Laurelview Ct.  
Fremont, CA 94538, USA  
[www.optomausa.com](http://www.optomausa.com)

 888-289-6786  
 510-897-8601  
 [services@optoma.com](mailto:services@optoma.com)



### Canada

3178 Laurelview Ct.  
Fremont, CA 94538, USA  
[www.optomausa.com](http://www.optomausa.com)

 888-289-6786  
 510-897-8601  
 [services@optoma.com](mailto:services@optoma.com)

### Latin America

3178 Laurelview Ct.  
Fremont, CA 94538, USA  
[www.optomausa.com](http://www.optomausa.com)

 888-289-6786  
 510-897-8601  
 [services@optoma.com](mailto:services@optoma.com)



### Europe

42 Caxton Way, The Watford Business Park  
Watford, Hertfordshire,  
WD18 8QZ, UK  
[www.optoma.eu](http://www.optoma.eu)  
Service Tel : +44 (0)1923 691865

 +44 (0) 1923 691 800  
 +44 (0) 1923 691 888  
 [service@tsc-europe.com](mailto:service@tsc-europe.com)



### Benelux BV

Randstad 22-123  
1316 BW Almere  
The Netherlands  
[www.optoma.nl](http://www.optoma.nl)

 +31 (0) 36 820 0253  
 +31 (0) 36 548 9052



### France

Bâtiment E  
81-83 avenue Edouard Vaillant  
92100 Boulogne Billancourt, France

 +33 1 41 46 12 20  
 +33 1 41 46 94 35  
 [savoptoma@optoma.fr](mailto:savoptoma@optoma.fr)



### Spain

C/ José Hierro,36 Of. 1C  
28522 Rivas VaciaMadrid,  
Spain

 +34 91 499 06 06  
 +34 91 670 08 32

## Deutschland

Wiesenstrasse 21 W  
D40549 Düsseldorf,  
Germany

 +49 (0) 211 506 6670  
 +49 (0) 211 506 66799  
 [info@optoma.de](mailto:info@optoma.de)

## Scandinavia



Lerpeveien 25  
3040 Drammen  
Norway

 +47 32 98 89 90  
 +47 32 98 89 99  
 [info@optoma.no](mailto:info@optoma.no)

PO.BOX 9515  
3038 Drammen  
Norway

## Korea

WOOMI TECH.CO.,LTD.  
4F,Minu Bldg.33-14, Kangnam-Ku,  
seoul,135-815, KOREA

 +82+2+34430004  
 +82+2+34430005



## Japan

東京都足立区綾瀬3-25-18  
株式会社オーエス  
コンタクトセンター:0120-380-495

 [info@os-worldwide.com](mailto:info@os-worldwide.com)  
[www.os-worldwide.com](http://www.os-worldwide.com)



## Taiwan

12F., No.215,Sec. 3, Beixin Rd.,  
Xindian Dist., New Taipei City 231,  
Taiwan, R.O.C.  
[www.optoma.com.tw](http://www.optoma.com.tw)

 +886-2-8911-8600  
 +886-2-8911-6550  
 [services@optoma.com.tw](mailto:services@optoma.com.tw)  
[asia.optoma.com](http://asia.optoma.com)



## Hong Kong

Unit A, 27/F Dragon Centre,  
79 Wing Hong Street,  
Cheung Sha Wan,  
Kowloon, Hong Kong

 +852-2396-8968  
 +852-2370-1222  
[www.optoma.com.hk](http://www.optoma.com.hk)

## China

5F, No. 1205, Kaixuan Rd.,  
Changning District  
Shanghai, 200052, China

 +86-21-62947376  
 +86-21-62947375  
[www.optoma.com.cn](http://www.optoma.com.cn)

## Regulation & Safety Notices

*This appendix lists the general notices of your projector.*

### **FCC notice**

This device has been tested and found to comply with the limits for a Class B digital device pursuant to Part 15 of the FCC rules. These limits are designed to provide reasonable protection against harmful interference in a residential installation. This device generates, uses and can radiate radio frequency energy and, if not installed and used in accordance with the instructions, may cause harmful interference to radio communications.

However, there is no guarantee that interference will not occur in a particular installation. If this device does cause harmful interference to radio or television reception, which can be determined by turning the device off and on, the user is encouraged to try to correct the interference by one or more of the following measures:

- Reorient or relocate the receiving antenna.
- Increase the separation between the device and receiver.
- Connect the device into an outlet on a circuit different from that to which the receiver is connected.
- Consult the dealer or an experienced radio/television technician for help.

### **Notice: Shielded cables**

All connections to other computing devices must be made using shielded cables to maintain compliance with FCC regulations.

### **Caution**

Changes or modifications not expressly approved by the manufacturer could void the user's authority, which is granted by the Federal Communications Commission, to operate this projector.



## **Operation conditions**

This device complies with Part 15 of the FCC Rules. Operation is subject to the following two conditions:

1. This device may not cause harmful interference and
2. This device must accept any interference received, including interference that may cause undesired operation.

## **Notice: Canadian users**

This Class B digital apparatus complies with Canadian ICES-003.

## **Remarque à l'intention des utilisateurs canadiens**

Cet appareil numérique de la classe B est conforme à la norme NMB-003 du Canada.

## **Declaration of Conformity for EU countries**

- EMC Directive 2004/108/EC (including amendments)
- Low Voltage Directive 2006/95/EC
- R & TTE Directive 1999/5/EC (if product has RF function)

### **Disposal instructions**



**Do not throw this electronic device into the trash when discarding. To minimize pollution and ensure utmost protection of the global environment, please recycle it.**