

# EPSON®

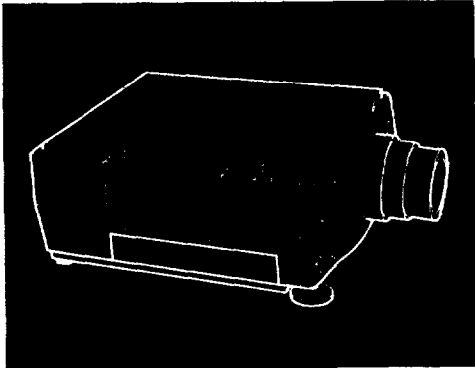

## *ELP-3000*

DATA/VIDEO PROJECTOR

Owner's Manual

**ProSelecta**

View :: Compare :: Select - [www.ProSelecta.com](http://www.ProSelecta.com)

# Important Information About Your ELP-3000

## Important Safety Information

*Warning : Never look into the projector lens when the lamp is turned on ; the bright light can damage your eyes. Never let children look into the lens when it is on.*

*Warning : Never open any cover on the projector, except the lamp, fuse, and filter covers. Dangerous electrical voltages inside the projector can severely injure you. Except as specifically explained in the Owner's Manual, do not attempt to service this product yourself. Refer all servicing to qualified service personnel.*

*Caution : When you replace the lamp, never touch the new bulb with your bare hands, the invisible residue left by the oil on your hands may shorten the bulb life. Use a cloth or gloves to handle the new bulb.*

All rights reserved. No part of this publication may be reproduced, stored in a retrieval system, or transmitted in any form or by any means, electronic, mechanical, photocopying, recording, or otherwise, without the prior written permission of Seiko Epson Corporation. No patent liability is assumed with respect to the use of the information contained herein. Neither is any liability assumed for damages resulting from the use of the information contained herein.

Neither Seiko Epson Corporation nor its affiliates shall be liable to the purchaser of this product or third parties for damages, losses, costs, or expenses incurred by purchaser or third parties as a result of: accident, misuse, or abuse of this product or unauthorized modifications, repairs, or alterations to this product, or (excluding the U.S.) failure to strictly comply with Seiko Epson Corporation's operating and maintenance instructions.

Seiko Epson Corporation shall not be liable against any damages or problems arising from the use of any options or any consumable products other than those designated as Original EPSON Products or EPSON Approved Products by Seiko Epson Corporation.

EPSON is a registered trademark of Seiko Epson Corporation.  
EPSON Connection is a service mark of Epson America, Inc.

***General Notice: Other product names used herein are for identification purposes only and may be trademarks of their respective owners. EPSON disclaims any and all rights in those marks.***

Copyright © 1995 by Epson America, Inc.  
Torrance, California, USA

4003816-01  
3/24/95



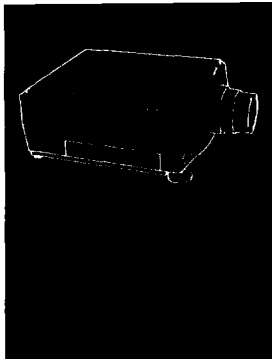

# Contents

Introduction	vii
Getting the Most Out of Your Projector	<i>viii</i>
Optional Accessories	x
About This Manual	x i
Safety Instructions	x ii
Where to Get Help	x iv
CompuServe online support	x v
<b>1 Installation</b>	<b>1</b>
Unpacking the Projector	2
Additional components	3
Setting Up the Projector	4
Connecting to a Computer	6
Connecting to a PC desktop computer	7
Connecting to a PC laptop computer	8



---

Connecting to a desktop Macintosh	9
Connecting to a PowerBook	10
Connecting to a Video Source	11
Connecting to an Audio Source	13
Connecting to an External Speaker or PA System	14
Setting Up Serial Communication	15
Connecting the serial cable	15
Installing the software	16
Connecting the Remote Control with the Lead Wire	17
<b>2 Using the Projector</b>	<b>19</b>
Turning the Equipment On and Off	20
Focusing <b>and</b> Positioning the Screen Image	21
Controlling the Projector	23
Adjusting the settings from ELP Link	26
Monitoring the Projector	27
Using Rear Projection	28
<b>3 Using the Menus</b>	<b>29</b>
Accessing the Menus	30
Changing menu settings	31
Accessing ELP Link menus	32
Restoring the default settings	33
Menu Settings	33
Computer menu	34

---

Video menu	36
Display menu	37
Audio menu	39
Options menu	40
Custom menu	41
<b>4 Remote Control of the Computer</b>	<b>43</b>
ELP Remote Programmer Templates	44
Starting the ELP Remote Programmer	45
Assigning a Macro to a Programmable Button	48
Using record mode	49
Using manual mode	51
Activating a Template	51
ELP Remote Programmer Menus	52
<b>5 Maintenance</b>	<b>53</b>
Cleaning the Lens	54
Cleaning the Projector Case	54
Cleaning the Air Filter	54
Cleaning the Trackball	56
Replacing the Lamp	58
Replacing the Fuse	61



---

<b>6 Troubleshooting</b>	<b>63</b>
Problems with the Projector	64
Problems with the Image or Sound	67
Problems with the Remote Control	70
<b>A Technical Specifications</b>	<b>73</b>
General	73
optical	74
Projector Lamp	74
Mechanical	74
Electrical	75
Environmental	75
Supported Monitor Displays	76
Pin Assignments	77
<b>Glossary</b>	<b>79</b>
<b>Index</b>	<b>83</b>

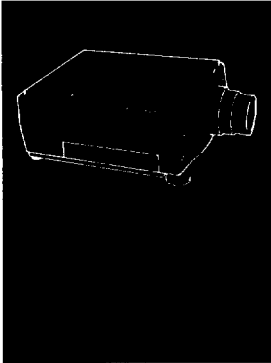

# Introduction

The compact, lightweight EPSON® ELP-3000 Projector allows you to project computer images and video onto a large screen for full-color presentations. The projector can connect simultaneously to two image sources; one can be your PC or Apple® Macintosh® computer and the other can be a video source, such as a VCR, camcorder, digital camera, or laser disk player. Audio can be supplied with one or both image sources.

Images are displayed in up to 16 million colors at a resolution of 640 x 480 pixels. The projector's 250-lumen bulb produces bright images that can be easily seen in rooms light enough to take notes. You can play audio on the projector's internal speakers or route it to an external speaker for amplification. You control the projector through a hand-held remote control, which allows you to switch between image sources and make adjustments to the projected image.

The projector supports any computer capable of VGA output, including IBM®-compatible PCs and laptops and Apple Macintosh computers, including the PowerBook™ and Power Macintosh.™ The video source can be NTSC, PAL, and SECAM in composite video or S-Video format.



---

# Getting the Most Out of Your Projector

The projector comes with a full set of features that allow you to control the settings for the image display, video, and audio. To get the most out of your projector, read this section for a quick summary of the important features.

## Remote control

The buttons on the remote control allow you to directly change the volume, control the brightness, or switch from one image source to the other. Additional adjustments can be made by using the buttons on the remote control to access the projector's menu system.

The menus, which you can superimpose on the projector image or display on your computer screen, allow you to do the following:

- Control the brightness, contrast, sharpness, color, and position of the image.
- Adjust the volume, balance, treble, and bass settings.
- Adjust the display by rotating or inverting it.

Additional settings are described in Chapter 3.

You can also use the remote control to control your computer if you install the Serial Communication Kit.

---

## Serial Communication Kit

The Serial Communication Kit allows your computer and projector to communicate over an RS-232C connection. The kit includes an RS-232C serial cable and two software utilities: ELP Link and ELP Remote Programmer.

- ELP Link allows you to make adjustments to the projector from your computer. The same controls that are available on your remote control, including the ability to access the projector menus, are available from the main ELP Link screen.
- The ELP Remote Programmer allows you to use the remote control to control your computer. The trackball moves the mouse on your computer monitor, and five buttons on the remote control can be programmed to drag or click windows and icons or perform the same functions as keys on your keyboard.

For information on using ELP Link, see Chapters 2 and 3. For information on the ELP Remote Programmer, see Chapter 4.

## Standby mode

Standby mode conserves electricity by automatically turning off the lamp if the projector has not been used for a specified period of time (the default is **10** minutes). In standby mode, the projector remains on but the lamp is turned off. This conserves electricity, cools the projector, and extends the life of the lamp.

Use the Standby button on the remote control to turn standby mode on or off.

---

## Rear projection

If you have a translucent screen, you can set up the projector for rear projection, in which the projector sits behind the screen. To use the remote control with rear projection, you need to purchase the optional lead wire and connect the remote control directly to your computer.

## Optional Accessories

To enhance your use of the projector, EPSON provides the following accessories:

- Polarized screens designed specifically for use with the projector. They allow you to project images in a bright, illuminated room, making it unnecessary to dim lights to view the projected image. The polarized screen comes in two sizes: 40" and 60" diagonal.
- Carrying cases especially designed for the projector and its cables. Both a soft and hard case are available.
- Remote control lead wire, which allows you to directly connect the remote control to the projector. This option enables you to use the remote control when an object is blocking the path between the remote control and projector, such as during rear projection when the screen is between the remote control and the projector.

You can purchase these accessories from your ELP-3000 dealer or by calling EPSON Accessories at (800) 873-7766.

---

## About This Manual

Chapter 1, “Installation,” gives step-by-step instructions on setting up the projector and connecting it to your computer, video source, and optional other equipment. Read the installation procedures that apply to your environment.

Chapter 2, “Using the Projector,” tells you how to turn on the projector; control simple projector settings using the remote control, the operation panel, and the ELP Link software; and set up the projector for rear projection.

Chapter 3, “Using the Menus,” describes how to use the menus to adjust the color and image settings, change the display of the projected image, and modify audio settings such as bass or treble.

Chapter 4, “Remote Control of the Computer,” explains how to use the ELP Remote Programmer so you can use the remote control to control your computer. It also describes how you can assign keyboard macros to the programmable buttons on the remote control.

Chapter 5, “Maintenance,” describes how to maintain the projector in good working order.

Chapter 6, “Troubleshooting,” tells you how to interpret the projector’s status lights and gives helpful information for avoiding errors, optimizing image quality, and solving problems.

Appendix A provides technical specifications.



---

# Safety Instructions

Follow these safety instructions when setting up and using the projector:

1. Do not place the projector on an unstable cart, stand, or table.
2. Do not use the projector near water or sources of heat.
3. Use attachments only as recommended.
4. Use the type of power source indicated on the projector. If you are not sure of the type of power available, consult your dealer or local power company,
5. Insert the projector's three-wire grounding-type plug into a properly grounded outlet. If you have a two-prong outlet, contact an electrician to replace it.
6. Do not overload wall outlets, extension cords, or integral convenience receptacles. This can cause fire or electric shock.
7. Do not place the projector where the cord can be walked on.
8. Unplug the projector from the wall outlet before cleaning. Use a damp cloth for cleaning. Do not use liquid or aerosol cleaners.
9. Do not block the slots and openings in the projector case. They provide ventilation and prevent the projector from overheating. Do not put the projector on a sofa, rug, or other soft surface or in a built-in installation unless proper ventilation is provided.

- 
10. Never push objects of any kind through cabinet slots. Never spill liquid of any kind in the projector.
  11. Except as specifically explained in this Owner's Manual, do not attempt to service this product yourself. Opening or removing covers may expose you to dangerous voltages and other hazards. Refer all servicing to qualified service personnel.
  12. Unplug the projector during lightning storms or when it will not be used for extended periods.
  13. Unplug the projector from the wall outlet and refer servicing to qualified service personnel under the following conditions:
    - A. When the power cord or plug is damaged or frayed.
    - B. If liquid has been spilled into it or it has been exposed to rain or water.
    - C. If it does not operate normally when the operating instructions are followed or if it exhibits a distinct change in performance, indicating a need for service.
    - D. If it has been dropped or the cabinet has been damaged.

---

## Where to Get Help

Epson America provides local customer support and service through a nationwide network of authorized EPSON dealers and Service Centers.

EPSON also provides the following support services through the EPSON Connection.<sup>SM</sup> In the U.S., call (800) **922-8911**; in Canada, call **(800) GO-EPSON**.

- Assistance in locating your nearest Authorized EPSON Reseller or Service Center
- Technical assistance with the installation, configuration, and operation of EPSON products
- EPSON Technical information library fax service
- Product literature with technical specifications on EPSON's current and new products
- Customer Relations.

You can purchase supplies, parts, documentation, and accessories by calling EPSON Accessories at (800) 873-7766 (U.S. sales only). In Canada, call (800) CO-EPSON for sales locations.

When you call for technical assistance, be ready to identify your system and its configuration.

If you need help with any software application program you are using, see the documentation that came with that program for technical support.

---

## CompuServe® online support

The fastest way to access helpful tips, specifications, drivers, application notes, and bulletins is through the Epson America Forum on CompuServe,

If you are already a CompuServe member, simply type GO EPSON at the menu prompt to reach the Epson America Forum.

If you are not currently a member of CompuServe, you are eligible for a free introductory membership as an owner of an EPSON product. This membership entitles you to:

- An introductory \$15 credit on CompuServe
- Your own user ID and password
- A complimentary subscription to *Compuserver Magazine*, CompuServe's monthly publication.

To take advantage of this offer, call (800) 848-8199 in the United States and Canada and ask for representative #529. In other countries, call (614) 529-1611 or your local CompuServe access number.



---

## Remote control information

The ELP-3000 allows you operate it by remote control via infrared(IR) receivers located at the front and back of projector. The projector may not respond to remote control commands under the following conditions :

- The ambient room light is too bright
- Certain types of fluorescent lighting are used
- A strong light source shines into either IR receiver
- Other equipment that emits infrared energy, such as a radiant room heater, is in the room.

These conditions commonly cause problems for most infrared-controlled equipment.

Try the following solutions :

- The remote control unit's batteries may be low on power, replace the batteries.
- Dim the ambient lighting and/or Dim off any fluorescent lights.
- Close any window coverings and/or move the projector out of direct sunlight.
- Turn off other equipment that emits infrared energy.

If the remote control still does not work properly, cover the unused IR receiver on the projector with light-blocking material, such as masking tape.

Remember, you can always control your computer-based presentation directly from the computer, even in an environment containing one of the conditions listed above.

## README File Information

The diskettes that came with your projector include README files that contain additional important information about the projector. Be sure to read these files.

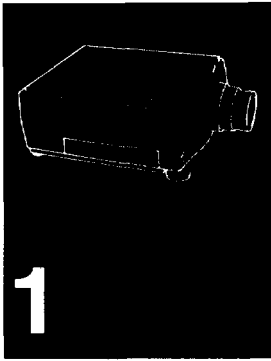

# Installation

This chapter describes how to unpack, set up, and connect your projector to other equipment. You must connect the projector to your computer or to a video source such as a VCR, camcorder, digital camera, or laser disk player. Connecting to other equipment is optional. For example, you may want to connect the projector to both your computer and video source, or set up the projector for one or more of the following:

- Provide audio for one or both image sources. The audio source can be the computer, video source, or another device such as a stereo.
- Connect to an external speaker or PA system to amplify the audio.
- Install the **RS-232C Serial** Communication Kit. This kit enables communication between your computer and the projector so you can use the remote control to control your computer and use your computer to control the projector settings.
- Directly connect the remote control and the projector using the optional lead wire. You need to do this to use the remote control for rear projection.



---

# Unpacking the Projector

After you unpack the projector, make sure you have all these components:

- Projector
- Remote control
- 2 AA batteries
- Power cord
- Y-shaped VGA cable
- 2 Macintosh adapters (labeled VGA and MONITOR)
- Lens cover
- Video/audio cable
- RS-232C serial communication kit, which consists of an RS-232C serial cable, an RS-232C adapter for the Macintosh, and two diskettes (one for the Macintosh, and one for the PC)
- Sparefuse.

Depending on your configuration, you may not need all of these components.

Save all packaging materials in case you need to ship the projector in the future. It should always be transported in its original packaging or the equivalent.

---

## Additional components

Depending on how you plan to use the projector, you may need to obtain additional components:

- To receive audio from both the computer and video source, you need a second video/audio cable. See your computer dealer to obtain one.
- To receive an S-Video signal, you need an S-Video cable. One is usually provided with your video device.
- For a Macintosh PowerBook, you need a video-out cable. One is provided for all new PowerBooks that have video-out capability. If your PowerBook does not include one, see your Macintosh dealer.
- To connect the projector to external speakers, you need an RCA-to-3.5mm audio cable. You can obtain one from your computer dealer.
- If your PC has a 25-pin RS-232C port, you need a 25-pin to 9-pin converter. You can obtain one from your computer dealer.



---

## Setting Up the Projector

1. Place the projector on a sturdy, level surface within five feet of the computer or video source.



*Caution: Do not hold the projector by the lens when you move it. This will damage the lens.*

2. Place the projector the proper distance from the screen.

The distance between the projector and the screen determines the actual image size. Use the following general guidelines to determine the proper distance.

---

<b>Maximum Zoom</b>	<b>Image size (diagonal)</b>	<b>Minimum Zoom</b>	<b>Distance from screen (approximate)</b>
300 inches (25 feet)		214 inches (30 feet)	40 feet
204 inches		146 inches	27 feet
96 inches		69 inches	13 feet
60 inches		42 inches	6 feet
30 inches		21 inches	4 feet

---

3. Turn the projector so the lens is at a right angle to the screen. If the projector is not at a right angle, the screen image will be crooked.



- 
4. **Connect one** end of the power cord to the projector's power connector. Connect the other end to a grounded electrical outlet.

If the projector comes on, turn it off using the power switch at the back of the projector.

5. To insert the batteries in the remote control, slide off the battery compartment cover as shown here.

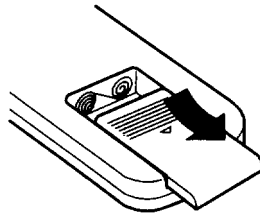

6. Insert the two AA batteries included with the projector. Make sure the polarity of the batteries is correct.

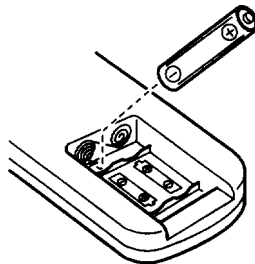

7. Replace the battery compartment cover.



---

When replacing batteries, take the following precautions:

- Do not mix old and new batteries.
- Replace batteries as soon as they run out. If the batteries leak, wipe away the fluid with a soft cloth. If battery fluid gets on your hands, wash immediately.
- Remove batteries if you will not be using the projector for long periods.
- Because batteries are hazardous waste, always dispose of them with nonburnable trash. Whenever possible, recycle used batteries.

## Connecting to a Computer

You can connect the projector to any computer capable of VGA output, including:

- IBM desktop PC or compatible
- IBM laptop or compatible
- Apple Macintosh desktop computer, including Macintosh Quadra<sup>®</sup> Macintosh Centris<sup>®</sup> and Power Macintosh
- Any Apple PowerBook with video-out capability. This includes all 160, 165, 180, and 500 series PowerBooks.

See the following section that applies to your computer.

## Connecting to a PC desktop computer

Before beginning, turn off the projector and computer if they are on. To access the connectors on the projector, push open the cover located on the right side of the projector, under the handle.

1. Disconnect the computer's monitor cable from the VGA port on the back of your computer and connect it to the MONITOR connector of the Y-cable.
2. Connect the Y-cable's VGA connector to the computer's VGA port.
3. Connect the Y-cable's LCD connector to the projector's Computer IN/OUT port.
4. Tighten the screws for all connectors to make sure they are fastened securely.

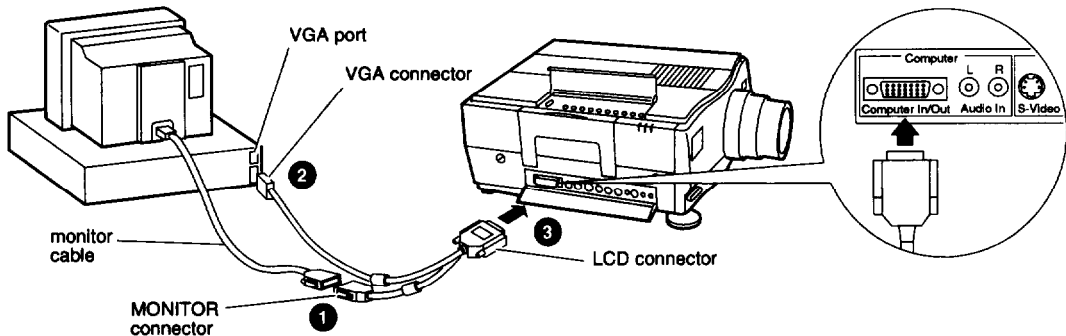

• • • • •



## Connecting to a PC laptop computer

Before beginning, turn off the projector and computer if they are on. To access the connectors on the projector, push open the cover located on the right side of the projector, under the handle.

1. Connect the LCD connector on the Y-cable to the projector's Computer IN/OUT port.
2. Connect the VGA connector on the Y-cable to the laptop's monitor port.
3. Tighten the screws for all connectors to make sure they are fastened securely.

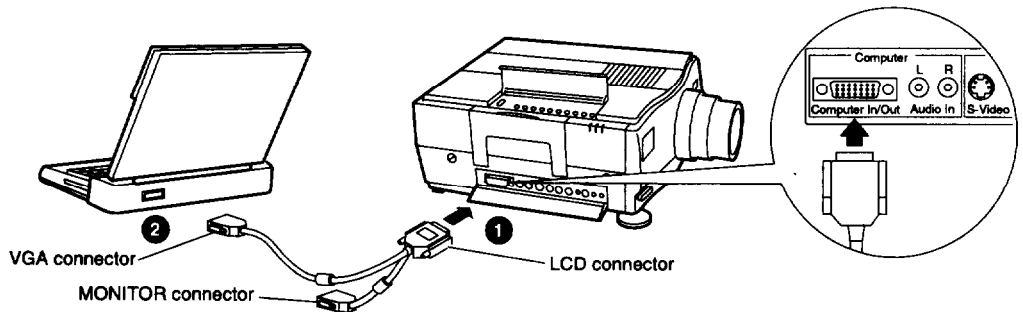

When the external graphics port is activated, some laptop computers automatically turn off their internal display. See your computer manual for information on using the internal display,

## Connecting to a desktop Macintosh

Before beginning, turn off the projector and Macintosh if they are on. To access the connectors on the projector, push open the cover located on the right side of the projector, under the handle.

1. Attach the Macintosh adapters provided with the projector to the appropriate connectors on the Y-cable. Connect the MONITOR adapter to the MONITOR connector (1a), and connect the VGA adapter to the VGA connector (1b).
2. Disconnect the monitor cable from the monitor port on the back of the Macintosh and connect it to the MONITOR Macintosh adapter.
3. Connect the VGA adapter (attached to the Y-cable) to the Macintosh's monitor port.
4. Connect the Y-cable's LCD connector to the projector's Computer IN/OUT port.
5. Tighten the screws for all connectors to make sure they are fastened securely.

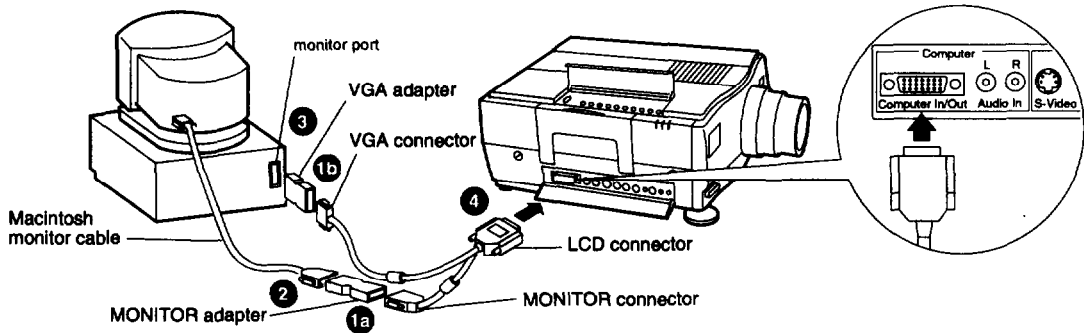

---

## Connecting to a PowerBook

Your PowerBook must have a video-out capability, See page 6 for more information.

Before beginning, turn off the projector and computer if they are on. To access the connectors on the projector, push open the cover located on the right side of the projector, under the handle.

1. Attach the video-out cable supplied with your PowerBook to the video-out connector on the back of the PowerBook.
2. Attach the Macintosh VGA adapter to the VGA connector of the Y-cable.
3. Connect the VGA Macintosh adapter to the video-out cable.
4. Connect the Y-cable's LCD connector to the projector's Computer IN/OUT port.
5. Tighten the screws for all connectors to make sure they are fastened securely.
6. In the PowerBook's Display Control Panel, select Mirroring.

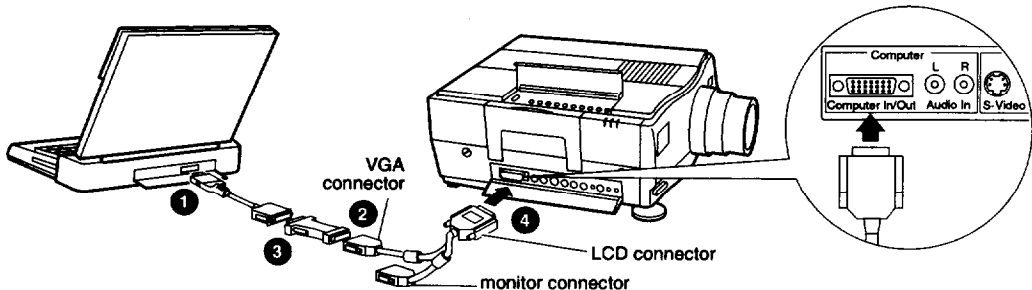

---

## Connecting to a Video Source

The projector can receive composite video or S-Video. You have composite video if your video source has a one-pin RCA video jack. You have S-Video if your video source has a four-pin video jack.

*Note: The projector is not compatible with a cable TV-style F connector*

You can connect to both an S-Video and a composite video source at the same time. However, the projector automatically selects the S-Video source. To display composite video, you need to disconnect the S-Video source.

The projector supports NTSC, PAL, and SECAM video formats. By default, it automatically detects and identifies the video format. However, you can specify that a single broadcast format be detected. (See “Video menu” in Chapter 3.) Note that the projector will then be able to detect only one type of video signal.

The type of cable you use to connect the video source to the projector depends on whether you have composite video or S-Video. For composite video, use the video/audio cable supplied with the projector. For S-Video, use the S-Video cable supplied with your video device or obtain one from your computer dealer.

To connect a video source to the projector:

1. Turn off the projector and video source if they are on.
2. Locate the video-out jack on the video source. It may be labeled Video Out, To Monitor, or something similar.



For composite video, connect the yellow RCA plug on one end of the video/audio cable to the projector's Video In jack. Connect the other yellow RCA plug to the video-out jack of the video source. (The red and white plugs carry audio. For information about audio, see page 13.)

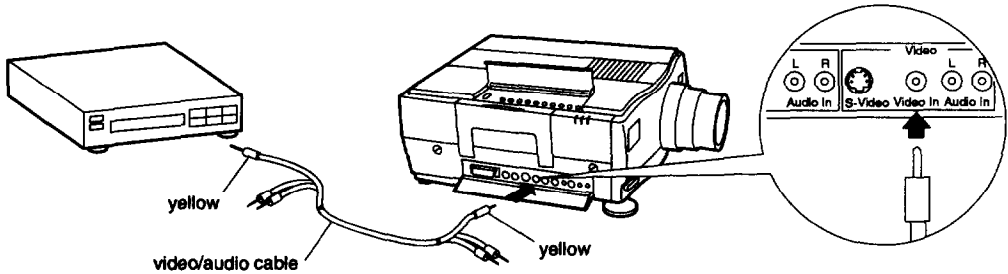

For S-Video, insert one end of the S-Video cable into the projector's S-Video jack. Insert the other end to the video-out jack of your video source.

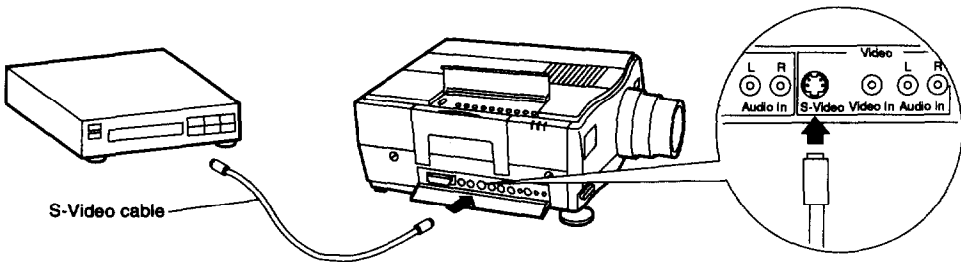

## Connecting to an Audio Source

The projector has two inputs for audio: one for your computer and one for your video source. Each input has two audio jacks: the L jack controls the left speaker and the R jack controls the right speaker. If you're connecting to an audio source that has only a single plug, connect it to the L Audio In jack.

To receive audio from the computer or video source, use the video/audio cable supplied with the projector. To receive audio from both the computer and video source, you need to obtain an additional cable from your computer dealer.

1. Connect one end of the audio cable to the appropriate (computer or video source) Audio In jacks on the projector. Insert the white plug in the L Audio In jack and the red plug in the R Audio In jack. (You don't use the yellow plug unless you're supplying composite video.)
2. Connect the other end of the cable to the audio source. Insert the white plug in the L Audio Out jack, and the red plug in the R Audio Out jack.

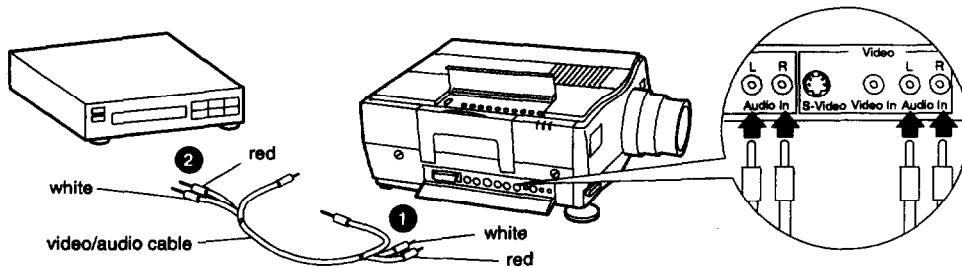

## Connecting to an External Speaker or PA System

For most small-or medium-sized rooms, the projector's internal speakers are sufficient. If you need extra amplification for a large room, you can connect the projector to an external amplified speaker or PA system.

To connect the projector to an external sound system, you need to obtain an RCA-to-3.5mm Stereo audio cable. You can get one from your computer dealer.

Before beginning, turn off the projector and the speaker or PA system,

1. Connect the cable's 3.5mm stereo miniplug into the projector's Audio Out jack.
2. Connect the RCA plug to the external amplified speaker or PA system. Insert the cable's red plug into the R side, and the white plug into the L side.

You should now adjust the Fade menu setting. See page 39.

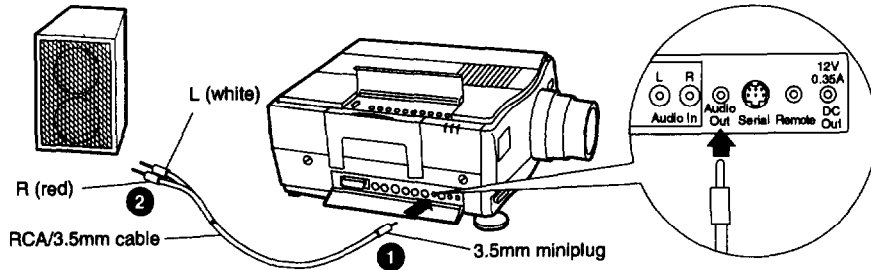

---

## Setting Up Serial Communication

The RS-232C Serial Communication Kit allows your computer and projector to communicate so you can access the projector menus from your computer and use the remote control to control your computer. The kit consists of a cable, a Macintosh adapter, and two software utilities: ELP Link and ELP Remote Programmer.

Instructions for installing the cable and software are given in the next two sections. For information on using ELP Link, see Chapters 2 and 3. For information on the ELP Remote Programmer, see Chapter 4.

By default, the Serial setting in the Options menu is on to enable communication when the Serial Communication Kit is installed. If, after installing the kit, you cannot enable communication, make sure the Serial setting has not been turned off. See Chapter 3 for more information about the menus.

### Connecting the serial cable

To connect the serial RS-232C cable to your computer and projector:

1. Connect one end of the serial RS-232C cable to the projector's RS-232C connector.
2. If you have a Macintosh, attach the RS-232C adapter to the modem port on the Macintosh.





---

The modem port is identified by the following icon:



3. Connect the other end of the RS-232C cable to the PC's RS-232C serial connector or to the RS-232C adapter on your Macintosh.

The serial connector on your PC is a nine-pin male connector. It may be labeled Serial, RS-232C, COM1, or something similar. If you have a 25-pin serial connector, you need to obtain a **25-pin** to 9-pin converter.

## Installing the software

Two diskettes are provided with the kit: one for the Macintosh and one for the PC. Use only the diskette appropriate for your platform. Each contains ELP Link and the ELP Remote Programmer,

Before installing the software, exit any open programs. Insert the appropriate diskette in a diskette drive. Then do the following:

- Windows.™ Go to the Program Manager and choose Run from the File menu. In the Command Line text box, type A: SETUP or B : SETUP as appropriate. Choose OK. Then follow the onscreen instructions.
- Macintosh Double-click on the ELP Installer icon and follow the onscreen instructions.

---

## Connecting the Remote Control with the Lead Wire

If you set up the projector for rear projection and want to use the remote control to control the projector, you need to connect the remote control directly to the projector with the optional lead wire. You might also need to directly connect the remote control if anything is blocking the path between the remote control and the projector.

To directly connect the remote control, connect one end of the lead wire to the projector's Remote jack. Connect the other end to the output terminal at the front end of the remote control. Make sure both ends are plugged in securely.

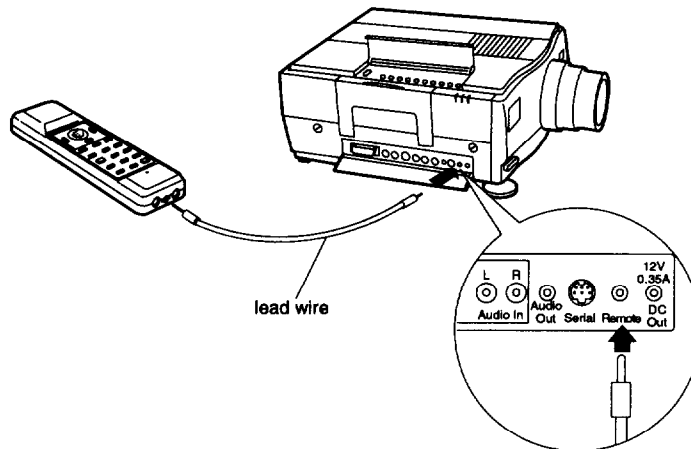

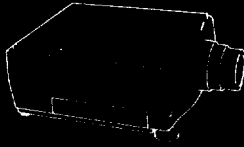

# 2

## Using the Projector

This chapter provides the following information about using your projector:

- Turning the equipment on and off
- Focusing and positioning the image
- Controlling the projector with the remote control, operation panel, and ELP Link software
- Monitoring the status of the projector
- Using rear projection.

---

## Turning the Equipment On and Off

Always turn on the projector and its attached equipment in the following order:

1. Monitor
2. Video source
3. Audio source (if different than computer or video source)
4. Projector
5. External amplified speaker or PA system
6. Computer.

The projector's power switch is at the back. When you turn on the projector, the green power indicator comes on and the lamp begins to warm up. Remove the lens cap. After a few seconds, an image appears on screen.



*Warning: Never look into the lens when the lamp is on. This can damage your eyes. It is especially important that children not look into the lens.*

If the lamp does not come on when you turn on the projector, the projector may be in standby mode. To turn off standby mode, press the Standby button on the remote control.

To turn off the projector and other equipment, reverse the order shown above. After you turn off the projector, the fan may remain on a few minutes to dissipate heat from the lamp. Always wait 10 to 60 seconds before turning the projector back on. If you turn on the projector immediately after turning it off, the lamp might be too hot and the projector will not turn on.

---

The following illustration identifies the different parts of the projector:

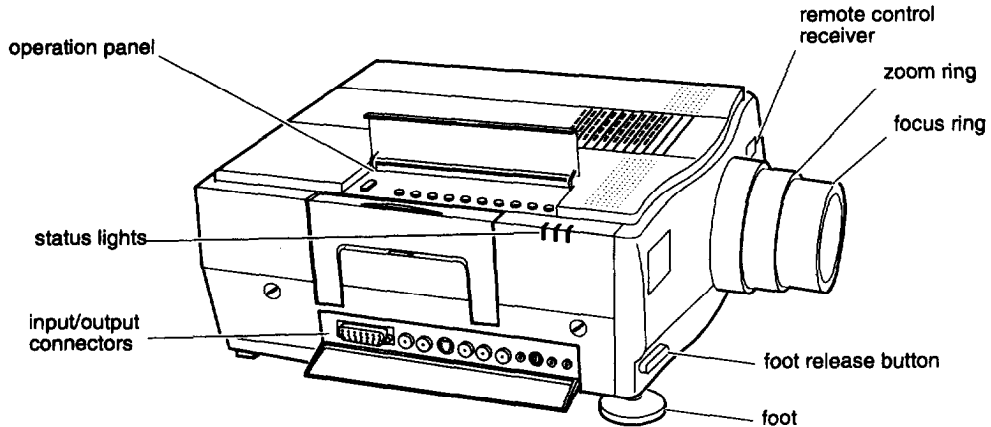

## Focusing and Positioning the Screen Image

When an image appears on screen, check that it is in focus and correctly positioned on the screen. To focus the image, rotate the focus ring, which is the outside ring on the lens. To adjust the size of the image, rotate the zoom ring, which is the inside ring. Rotate the zoom ring clockwise to make the screen image larger or counterclockwise to make it smaller.



---

If you need to raise or lower the image on the screen, extend or retract the two feet at the bottom of the projector as follows:

1. Stand behind the projector and support the front of it while you press the purple release buttons located above the feet. This unlocks the feet so they can move up and down freely. Do not let the projector drop.

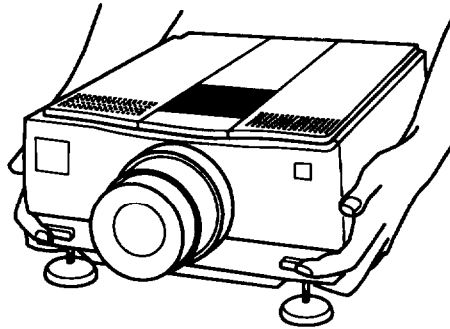

*Caution: Do not hold the projector by its lens. This can damage the lens.*

2. While pressing the release buttons, raise or lower the projector until the screen image is correctly positioned.
3. Release the buttons to lock the feet in their new position.
4. To fine-tune the height of the projector, turn the feet clockwise to raise the height or counterclockwise to lower it.

---

# Controlling the Projector

Normally you control the projector using the remote control. The buttons on the remote control allow you to do the following:

- Switch between the computer and video images
- Adjust the brightness, volume, and synchronization
- Turn standby mode on or off
- Access the menus to adjust the image, audio, video, or display settings (described in Chapter 3)
- Control your computer (described in Chapter 4).

The functions of the remote control buttons are summarized on page 25.

To use the remote control, always point it toward one of the two remote control receivers. One is located at the front of the projector; the other is located on the back. You can use the remote control up to 33 feet (10 meters) from the projector.

In addition to the remote control, you can control the projector by:

- Pressing the buttons on the projector's operation panel, located on top of the projector. These buttons duplicate the buttons on the remote control.
- Running the ELP Link software on your computer. This program contains the same controls available on the remote control, including the menus. See page **26** for more information.



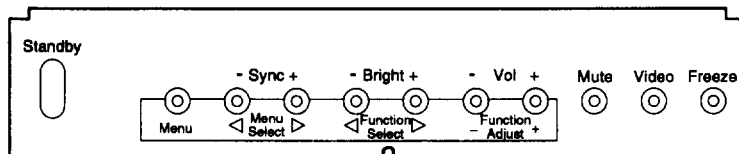
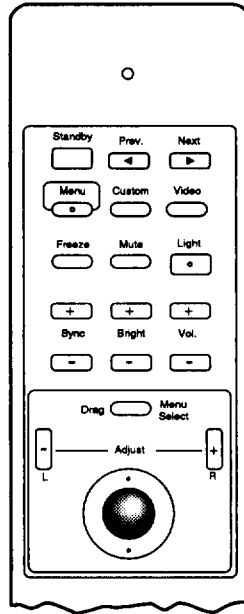



---

<b>Button/component</b>	<b>Function</b>
Standby	Turns standby mode on or off.
Prev, Next*	Control the computer (see Chapter 4).
Menu	Displays or hides the menus.
Custom	Selects one of four functions: pattern (default), serial, blank, or prompt. See Chapter 3 to assign the function.
Video	Switches between the computer image and video source.
Freeze	Freezes or unfreezes the image.
Mute	Turns off the sound.
Light	Illuminates buttons for 10 seconds or until you press a button or use the trackball. Pressing again keeps the buttons on for another 10 seconds.
Sync (+ and -)	Synchronize the RGB signals coming from the computer to eliminate flickering.
Bright (+ and -)	Adjust the image brightness.
Volume (+ and -)	Adjust the volume level.
Drag/Menu Select*	Selects a menu when the menu bar is displayed or controls the computer (see Chapter 4).
Trackball	Moves the cursor when using the projector menus, or moves the mouse on your computer screen.
Adjust buttons (+ and -)*	Adjust the settings when using the projector menus. When no menu is displayed, these buttons control the computer.

---

- Programmable to control the computer. See Chapter 4 for more information.

If you do not use the remote control for 15 minutes, it enters sleep mode and cannot be reactivated using the trackball. Press any button to turn off sleep mode so you can use the trackball.



---

## Adjusting the settings from ELP Link

If you set up the projector for serial communication as described in Chapter 1, you can use the ELP Link program to control the projector from your computer. To start ELP Link, do one of the following:

- *Windows.* Open the ELP Utilities program group by double-clicking on its icon. Then double-click the ELP Link icon.
- *Macintosh.* Open the ELP Utilities folder by double-clicking on its icon. Double-click the ELP Link folder icon and then double-click the ELP Link icon.

You see a screen similar to the following:

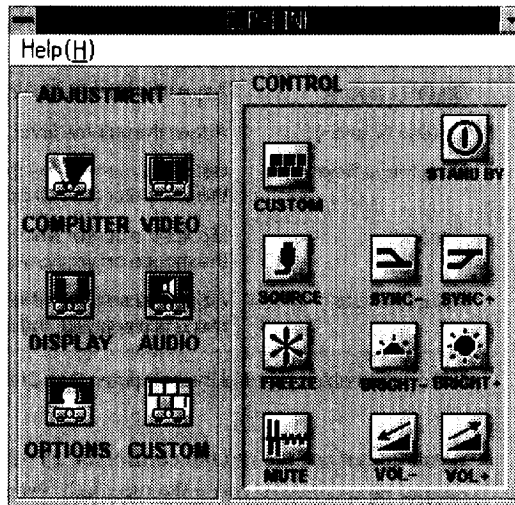

---

The buttons on the right side of the screen allow you to control the projector settings as you do with the remote control. See the table on page 25 for a description of these buttons. The buttons on the left allow you to access the menus. For more information about the menus, see Chapter 3.

## Monitoring the Projector

The three lights at the top of the projector monitor its operating status:

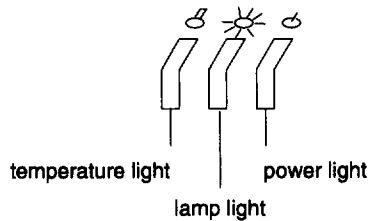

Under normal circumstances the power and lamp lights are green and the temperature light is off. (During standby mode, the lamp light is off and the power light is orange.) Any time the status or operation of the projector changes or whenever a problem occurs, the lights gash or turn orange. See Chapter 6 for specific information about the meaning of the status lights,

---

## Using Rear Projection

The projector can be set up for front or rear projection. In rear projection, the projector is on the opposite side of the screen from the audience, as shown here:

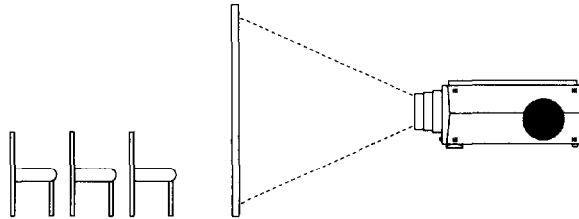

For rear projection, you must turn on the Rear setting in the Display menu. This setting flips the image from left to right for correct viewing. See Chapter 3 for information about the menus.

Because the screen is between the remote control and the projector for rear projection, you need the optional lead wire to use the remote control. See Chapter 1 for more information. If you don't have the lead wire, use the buttons on the operation panel to make changes to the menus.

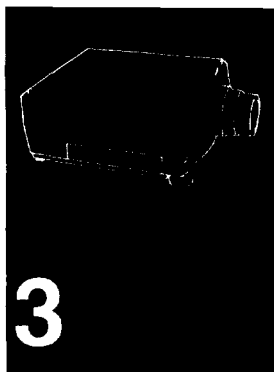

## Using the Menus

The projector menus allow you to do the following:

- Control the brightness, contrast, sharpness, and color of the image.
- Adjust the vertical or horizontal position of the display, change the placement of the menus, and configure the display for rear projection or an upside down ceiling mount.
- Adjust audio settings such as volume, balance, bass, and treble.
- Adjust the display by rotating or inverting it and modifying the color.
- Change the language used in the menus and specify how long the projector is idle before it enters standby mode.
- Assign a function to the remote control's Custom button.



## Accessing the Menus

You can display menus on the projector screen or on your computer. To display menus on top of the projector screen, press the Menu button on the remote control or the operation panel. This opens the currently selected menu. Other menus are available from the menu bar at the bottom of the menu.

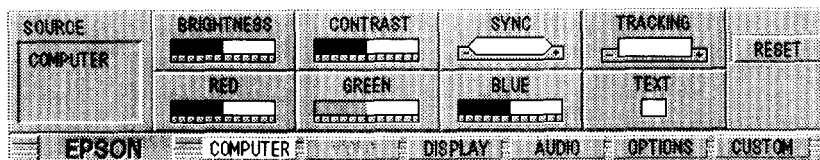

The following table shows the settings for each of the menus:

Menu	Settings
Computer	Brightness, Contrast, Sync, Tracking, Red, Green, Blue, Tint (PC only), Mac LC (Macintosh only)
Video	Brightness, Contrast, Sharpness, Color, Mode, Text
Display	Horizontal, Vertical, Menu, Blank To, Rear Proj, Upside Down, Invert
Audio	Volume, Balance, Audio Source, Bass, Treble, Loudness, Fade
Options	Prompt, Backgnd, Serial, Power Save, Dly On, Language
Custom	Pattern, Serial, Blank To, Prompt

---

To select a different menu, press the Menu Select button on the remote control or operation panel. To select a setting in the menu, use the trackball (remote control) or the Function Select buttons (operation panel).

To close the menus, again press the Menu button.

## Changing menu settings

Menu settings are sliders with increasing and decreasing values or checkboxes you turn on or off. A checkbox is on when it is shown with a checkmark.



To change a slider setting or turn a checkbox on or off, do one of the following:

- If you're using the remote control, use the trackball to select a menu setting. Then press the Adjust buttons (+ and -) to increase or decrease a slider setting or turn a checkbox on or off.
- If you're using the operation panel, use the Function Select buttons to select a setting and use the Function Adjust buttons to change a slider setting or turn a checkbox on or off.

Any adjustments you make using the menus remain in effect until you change them. Turning off the projector does NOT reset the settings.

---

*Note: If you do not use the remote control for 15 minutes, it enters sleep mode and cannot be reactivated using the trackball. Press any button to turn off sleep mode so you can use the trackball.*

## Accessing ELP Link menus

You can also access menus from your computer. To do so, start the ELP Link program as described in Chapter 2. You see a screen similar to the one shown below. The menu buttons are on the left. To open a menu, simply double-click on the appropriate icon. Although the menus look different from those displayed on the projector screen, the menu settings are the same.

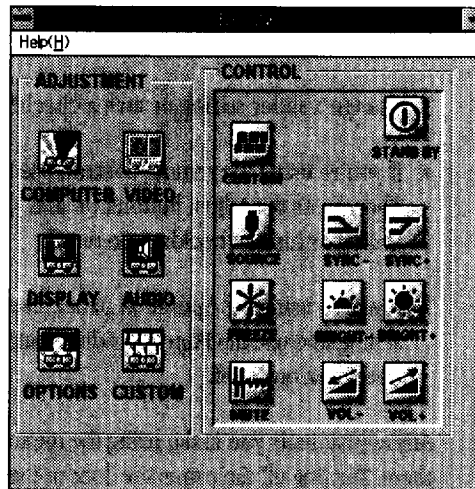



---

## Restoring the default settings

You can reset all settings in the current menu back to the factory defaults by pressing the Reset button, which appears in each projector and ELP Link menu except the Options menu.

To restore all default settings in all menus, choose the Reset All button in the Options menu.

## Menu Settings

The following sections describe the settings on each menu. Note that the Computer and Video menus both contain Brightness and Contrast settings. This allows you to change the brightness and contrast of one image source without affecting the other.

*Note: You cannot display the Video menu when the computer is selected as the image source Likewise, you cannot display the Computer menu when the video source is selected.*

The menus displayed on the projector screen are shown on the following pages. The ELP Link screens look different, but the settings on the menus are the same.



---

## Computer menu

You see the first Computer menu if you have a PC, or the second menu if you have a Macintosh.

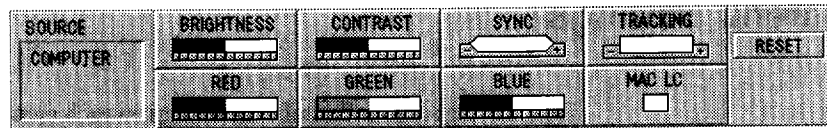
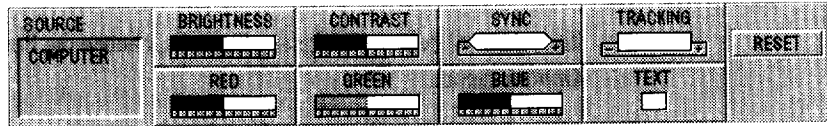

**Brightness** Lightens or darkens the overall image. Increase brightness to lighten an image; decrease it to darken an image.

**Contrast** Adjusts the degree of difference between light and dark areas. Increase the contrast if you want light areas to be very light and dark areas to be very dark. Decrease contrast to minimize the difference between the lightest and darkest parts of the image.

**synchronize** Synchronizes the graphics signals coming from the computer. Adjust this setting if the image is fuzzy or streaked or contains artifacts.

---

Use the Synchronize setting only if the image cannot be corrected by adjusting Brightness and Contrast.

Tracking	Matches the projector's internal clock to the various computer graphics signals. If vertical lines appear within an image, adjust Tracking to spread the distance between the lines until they disappear
Red	Adjusts the strength of the red level.
Green	Adjusts the strength of the green level.
Blue	Adjusts the strength of the blue level.
Text (PC only)	Compresses the projected image to fit into the projector's 640-pixel image area. Normally you need to compress an image only if your DOS software program has a text screen wider than the projector's area.
Mac LC (Mac only)	Configures the projector for the Macintosh LC model. Turn on this setting if you have a Macintosh LC.

---

## Video menu

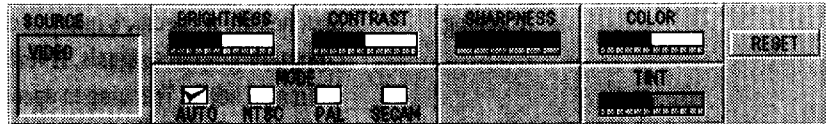

- |            |   |
|------------|---|
| Brightness | Lightens or darkens the overall image. Increase brightness to lighten an image; decrease it to darken an image.   |
| Contrast   | Adjusts the degree of difference between light and dark areas. Increase the contrast if you want light areas to be very light and dark areas to be very dark. Decrease contrast to minimize the difference between the lightest and darkest parts of the image. |
| Sharpness  | Emphasizes or de-emphasizes edges within an image. Increase sharpness for more edge definition and a sharper image. Decrease sharpness for softer edges.  |
| Color      | Adjusts the color density. Increase color when you want darker and more opaque colors. Decrease color for lighter and less opaque colors.   |
| Mode       | Specifies the type of video signal the projector can receive. Mode can be Auto (default), NTSC, PAL, or SECAM.  |

---

When Auto is selected, the projector automatically identifies the incoming video signal. If you select NTSC, PAL, or SECAM, the projector accepts only the selected video signal. Normally you should not change the default setting.

Tint Adjusts the red/green color balance. Increase tint to make the image more green; decrease to make it more red.

## Display menu

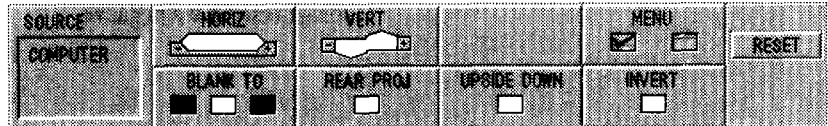

Horizontal Moves the image left or right. To move the image to the right, increase the setting; to move it to the left, decrease the setting.

Vertical Moves the image up or down, To move the image up, increase the setting; to move it down, decrease the setting.

Menu Switches the position of the menu between the top and bottom of the projector screen.



---

Blank To	Selects the color shown on the screen when you use the Blank setting to clear the screen. Choose Black, White, or Blue. For a description of Blank, see page 41.
Rear Proj	Flips the right and left of the projected image so the projector can be used for rear projection. For front projection, Rear Proj should be off.
Upside Down	Flips the horizontal axis of the image so the projector can be turned upside down from a ceiling mount.
Invert	Substitutes each color with its complementary opposite. For example, when you use Invert, red areas of an image turn green. For black and white images, Invert makes the image resemble a negative.

---

## Audio menu

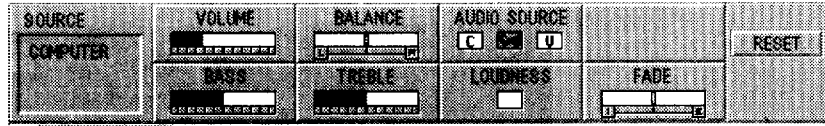

- |              |   |
|--------------|---|
| Volume       | Increases or decreases the volume.  |
| Balance      | Distributes sound between the left and right speakers. Increase the setting for more sound on the left and less on the right. Decrease it for more sound on the right.  |
| Audio Source | Specifies whether audio is supplied only from the computer (C), only from the video source (V), or from the currently selected source (CV, the default). If you select C or V, pressing the Video button does not switch the audio. |
| Bass         | Increases or decreases low tones.   |
| Treble       | Increases or decreases high tones.  |
| Loudness     | Turns bass boost on or off.   |
| Fade         | Adjusts the audio levels between the projector's built-in speakers and an external amplified speaker. If you connect to an external speaker, move the slider to the right to increase volume to the external speaker.               |



---

## Options menu

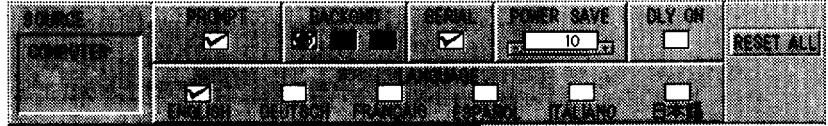

- |            |   |
|------------|---|
| Prompt     | Temporarily displays a prompt on the projector screen to identify which source (computer or video) is providing the image. This prompt appears only when you switch the image source.   |
| Backgrnd   | Specifies what is shown onscreen when an image signal is not available. The options are Test Pattern (default), Black, or Blue.   |
| serial     | Enables communication between your computer and the projector. See Chapter 4 for more information.  |
| Power Save | Specifies in minutes how long the projector waits for an image signal before entering standby mode. If an image signal is not received within the specified time, the projector automatically enters standby mode.<br><br>Power Save can be 5 to 60 minutes. The default is 10. |
| Delay On   | Automatically places the projector in standby mode when it is turned on. By default Delay On is off.  |



---

Language Specifies the language used in the menus. The choices are English (default), Deutsch, Francais, Espanol, Italiano, and Japanese.

## Custom menu

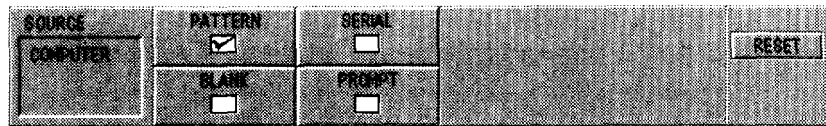

The Custom menu allows you to use the Custom button to immediately access one of the following four functions:

- Pattern (default), Displays a test pattern on the screen.
- Serial. Enables communication between the projector and your computer if you have installed the Serial Communication Kit.
- Blank. Turns off the image display and blanks the screen to black, white, or blue. The color of the screen is determined by the Blank To setting (see page 38).
- Prompt. Temporarily displays a prompt on the projector screen to identify which source (computer or video) is providing the image. This prompt appears only when you switch the image source.

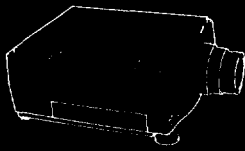

# 4

## Remote Control of the Computer

**T**his chapter describes the ELP Remote Programmer. When this utility is running on your computer, you can use the remote control to control your software program. The trackball moves the mouse on your computer, and the five programmable buttons can be used to drag or click windows or icons.

If you wish, you can also assign a keyboard macro to a programmable button. A macro is a sequence of up to 32 keystrokes and mouse commands. If you assign a macro to a button, pressing the button has the same effect as typing the keys on the keyboard or using the mouse. For example, if you have Windows and assign Alt + Tab to one of the buttons, you can cycle through your open programs with the press of a button. If you have a Macintosh, you could assign Apple + O and open a new document by pressing a button.

In order to use the ELP Remote Programmer, you must first install the Serial Communication Kit as described in Chapter 1.







---

## ELP Remote Programmer Templates

Five buttons on the remote control can control the computer if you are running the ELP Remote Programmer. The five programmable buttons are the Prev, Next, Drag, and Adjust (+ and -) buttons.

The keys and mouse commands assigned to each button are stored in a file called a template. The ELP Remote Programmer comes with a series of templates. Each is customized for several popular software programs.

Only one template can be active at a time. The following table shows the button assignments for the default template. This template is active the first time you start the ELP Remote Programmer. You can modify the default template or any of the custom templates for your own purposes.

	<b>Windows</b>	<b>Macintosh</b>
<b>Prev</b> 	Left mouse click [MLBC]	Left arrow
<b>Next</b> 	Right mouse click [MRBC]	Right arrow
<b>Drag</b> 	Left mouse drag [MLBDG]	Mouse drag
- 	Left mouse click [MLBC]	Mouse click
+ 	Right mouse click [MRBC]	Mouse click

---

## Starting the ELP Remote Programmer

The ELP Remote Programmer can run under Windows or on the Macintosh. This section provides general information that applies to both platforms. For specific information on how to use the ELP Remote Programmer on your platform, see the online help, which is available by selecting Help in the menu bar.

Do the following to start the ELP Remote Programmer:

- **Windows:** Open the ELP Utility program group by double-clicking on it. Then double-click the ELP Remote Programmer icon.
- **Macintosh:** Open the ELP Utilities folder by double-clicking on its icon. Double-click the ELP Remote Programmer folder and then double-click the ELP Remote Programmer icon.

When you start the ELP Remote Programmer, you see a screen similar to the one on the next page. This screen, which represents the buttons on the remote control, allows you to change the button assignment and then activate the template so you can use it with the remote control.

The ELP Remote Programmer must be running on your computer in order for you to use the remote control to control your software program. If you do not need to program any buttons, you can minimize the ELP Remote Programmer screen so it appears as an icon at the bottom of the screen.

*Note: Although both ELP Remote Programmer and ELP Link can be running on your computer at the same time, only one can be active. If both are running, ELP Link has priority.*



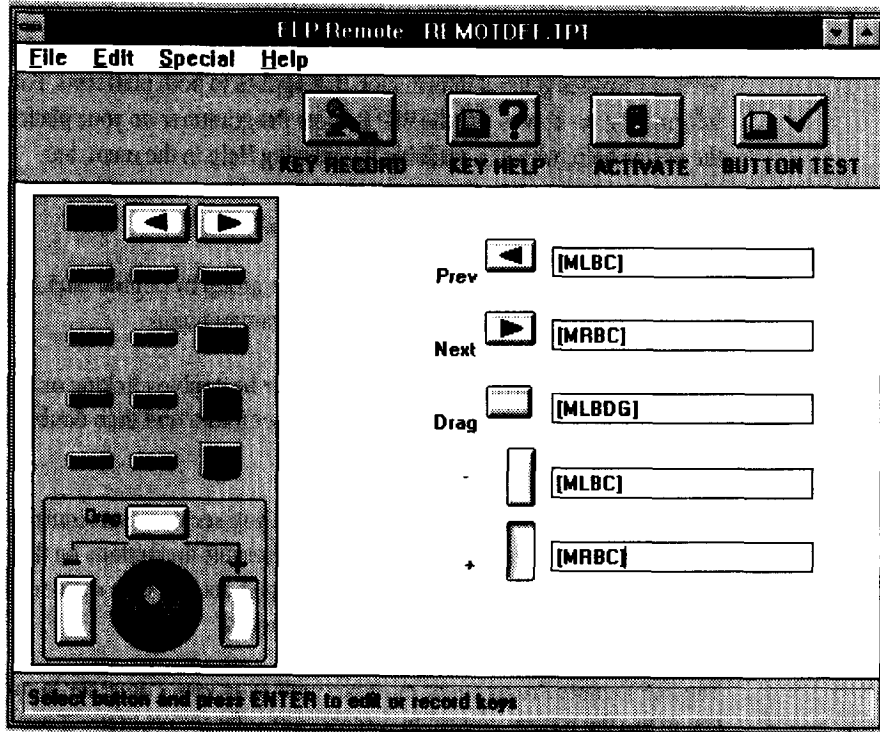

---

The following table describes the elements in the ELP Remote Programmer screen. The remote control buttons that can be programmed are shown at the right of the screen.

<b>Element</b>	<b>Function</b>
Menu bar	Contains ELP Remote Programmer commands. See “ELP Remote Programmer Menus” on page 52 for information.
Key Record button	Turns record mode on and off.
Key Help button	Windows: Brings up a list of the codes that represent non-character keys and mouse commands.  Macintosh: Identifies the special symbols used to represent non-character keys (e.g., Alt, Shift, Control) and mouse commands.
Activate button	Makes the current template active so it can be used with the remote control.
Button Test button	Brings up a text box that displays the assigned keystrokes when you press a remote control button.



---

## Assigning a Macro to a Programmable Button

To assign a macro, start the ELP Remote Programmer. Move the cursor to the text box of the button you want to edit. You can then assign keystrokes and mouse commands.

To assign a mouse command, open the Special menu at the top of the screen and select the appropriate mouse command. This inserts a special code (PC) or symbol (Macintosh) in the text box to represent the mouse command.

To assign keyboard keys, you can use record mode or manual mode.

- In record mode, you simply type one or more keyboard keys. The keys are shown in the text box next to the button, with special codes (PC) or symbols (Macintosh) representing non-character keys (e.g., Ctrl, Alt, F1) .

On the Macintosh, some non-character keys cannot be typed in, including Command, Shift, and Control. You need to choose these keys from Mouse/Special Buttons in the Special menu at the top of the screen.

- If you have a PC, use manual mode to include Scroll Lock in a macro or to enter key combinations, such as Ctrl + Alt + S. See page 51 for more information about manual mode. You do not normally need to use manual mode on the Macintosh because key combinations are created using the options in Mouse/Special Buttons of the Special menu.

---

## Using record mode

In record mode, you simply type keystrokes and the ELP Remote Programmer displays the keys in the text box next to the button. For non-character keys, the ELP Remote Programmer enters codes (PC) or special symbols (Macintosh) that represent the keys. For a list of codes or symbols, choose the Key Help button.

To use record mode to assign a button:

1. Open the ELP Remote Programmer.
2. Turn on record mode. Choose the Key Record button at the top of the screen. If you have a PC, you can also press Scroll Lock
3. Move the cursor to the text box of the button you want to program. Use the mouse or press Enter to move the cursor.
4. Type the keys you want to assign to the button or assign a mouse command.

Simply type the keys into the text box. On the Macintosh, you cannot type some non-character keys (e.g., Shift, Command, and Control) in the text box. Instead, you need to select these keys from the Mouse/Special Buttons list in the Special menu.

To enter mouse commands, open the Special menu and select Mouse Buttons (PC) or Mouse/Special Buttons (Macintosh).





---

On the Macintosh, you can assign key combinations, such as **Command + 0**, while in record mode. To do so, use the Link symbol under Mouse/Special Buttons between each key you want to combine. For example, to program Command + 0, choose Command in Mouse/Special Buttons, then choose Link in Mouse/Special Buttons, then type 0 in the text box. (It is not necessary to be in record mode to choose keys from Mouse/Special Buttons.)

On the PC, use manual mode to create key combinations. See the next section.

5. Repeat steps 3 through 4 for each button you want to program.
6. Turn off record mode. Choose the Key Record button or, if you have a PC, press the Scroll Lock key
7. Activate the template by pressing the Activate button. This makes the new button assignment active with the remote control.

To be able to use the remote control and the new macros, be sure you have connected the RS-232C cable as described in Chapter 1 .

8. Save the template. Choose Save or Save As in the File menu.

*Note: In Windows, the ELP Remote Programmer assumes use of the COM1 serial port. To use COM2 port, choose COM2 in the Special menu*

---

## Using manual mode

Use manual mode if you have a PC and want to create macros that include the Scroll Lock key or key combinations such as Ctrl + Alt + Delete.

To manually enter alphanumeric characters (1-9 and A, B, C . . .), simply type the key. For non-character keys, enter the code for the key. To display the codes, press the Key Help button. Each control code is enclosed in square brackets. For example, the code for the Control key is [C] or [Ctrl].

When entering a control key combination, put brackets around the entire combination as well as around each control key. Do not put individual brackets around alphanumeric keys. The following gives examples of how to program key combinations on the PC:

To program Ah + X, enter [ [A]X].

To program Ah + X followed by the escape key, enter [ [A] X] [ESC].

To program Control + Alt + Delete, enter [ [C] [A] [DEL]].

## Activating a Template

Once you assign a new macro to a button, you need to activate the template to be able to use the new button assignment with the remote control. You do not need to save a template before you activate it. To activate the template, choose the Activate button.



---

## ELP Remote Programmer Menus

The menu bar at the top of the screen contains these four menus:

**File** Allows you to create a new template or open an existing one, save the current template or create a new one, or exit the program.

**Edit** Makes it easy to edit text in the text box of the currently selected button. The items on this menu allow you to cut, copy, and paste text and clear the contents of the currently selected button.

**Special** The items on this menu allow you to do the following:

- Activate and test the buttons of the current template
- Insert codes for mouse commands
- Insert codes for special keys (Macintosh only)
- Adjust the mouse speed to your preference
- Configure the remote control for the COM1 or COM2 port (PC only).

**Help** Displays topics to help you use the program.

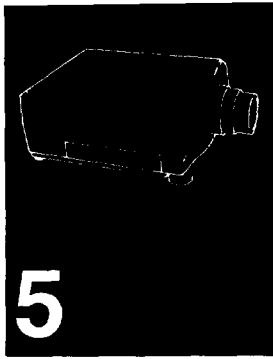

## Maintenance

The projector needs little maintenance. You should keep the lens clean because any dirt or stains will appear on the screen. You also need to periodically clean the air filter, which is located at the bottom of the projector. Keeping the air filter clean is important because a clogged air filter prevents proper ventilation, which is necessary to cool the projector **and** prevent it from overheating.

You should also clean the trackball on the remote control whenever you notice that the trackball is not rotating smoothly due to dirt and dust that have collected on the trackball.

The only parts you should replace are the lamp, air filter, and fuse. If any other part needs replacing, contact your ELP-3000 dealer or a qualified service person,

Whenever you clean any part of the projector, always turn off the projector and unplug it first.



---

## Cleaning the Lens

Clean the lens whenever you notice dirt or dust on the surface. Gently wipe the lens surface with a soft, dry, lint-free cloth.

To remove dirt or stains on the lens, moisten a soft cloth with an alcohol-based cleaner and gently wipe the lens surface.

## Cleaning the Projector Case

To clean the projector case, first unplug the power cord. To remove dirt or dust, wipe the casing with a soft, dry, lint-free cloth. To remove stubborn dirt or stains, moisten a soft cloth with water and a neutral detergent. Then wipe the casing.

Do not use alcohol, benzene, thinner, or other chemical detergents. These can cause the casing to warp.

## Cleaning the Air Filter

The air filter, which is located at the bottom of the projector, should be cleaned after every 100 hours of use. If it is not cleaned periodically, it can become clogged with dust and prevent the projector from being ventilated properly. This can cause overheating and damage the projector.

---

To clean the air filter:

1. Turn off the projector and unplug the power cable from the wall outlet.
2. Turn the projector over so you can easily access the filter.

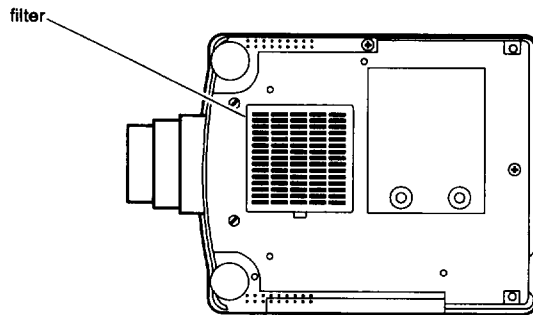

3. Use a flat-head screwdriver to lift and remove the filter cover.

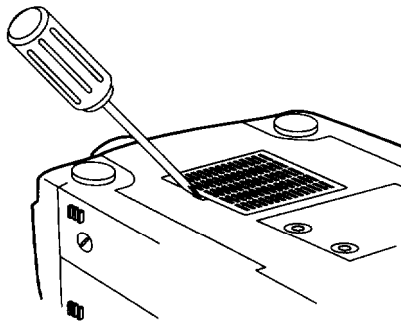

- 
4. The filter is attached to the other side of the filter cover. To clean the filter it is recommended that you use a small vacuum cleaner designed for computers and other office equipment. If you don't have one, use a dry, lint-free cloth.

If the dirt is difficult to remove or if the filter is torn, replace it. Contact your ELP dealer or call EPSON Accessories at (800) **873-7766** to obtain a new one. Be sure to request part number **1023658**.

5. Replace the filter,
6. Reconnect the power cord to the wall outlet.

## Cleaning the Trackball

You should clean the trackball periodically and whenever you notice that it is not moving smoothly.

1. Turn off both the projector and the computer.
2. Turn the frame that surrounds the trackball counterclockwise until it unlocks. You may need to use a sharp object, such as a pencil, to help turn the frame.

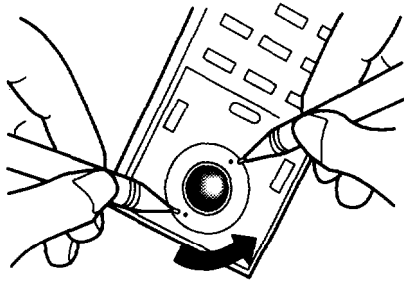

3. Lift out the trackball from its holder and wipe it completely with a soft, dry cloth to remove dirt and grit. To remove stubborn dirt and stains, moisten the cloth with a neutral detergent. Do not use an alcohol-based cleaner.
4. Use a cotton swab to gently clean the trackball holder. Pressing too hard can cause the holder to move out of position.

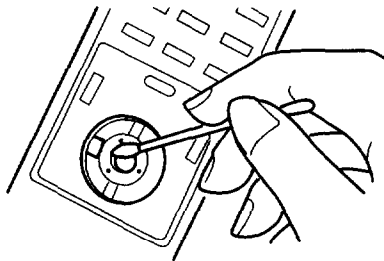

5. Place the trackball back into its holder and rotate its frame clockwise until it locks in place.





---

## Replacing the Lamp

If the lamp light does not come on or turns red, or if you notice that the screen image is dark, you might need to replace the lamp. Use only replacement lamp type MSCR150E3H, part number 1023661.



*Warning: Allow the lamp to cool and before replacing it. During use it becomes hot enough to burn you.*

1. Turn off the projector and disconnect the power cable from the wall outlet.
2. Turn the projector over so you can access the lamp cover.

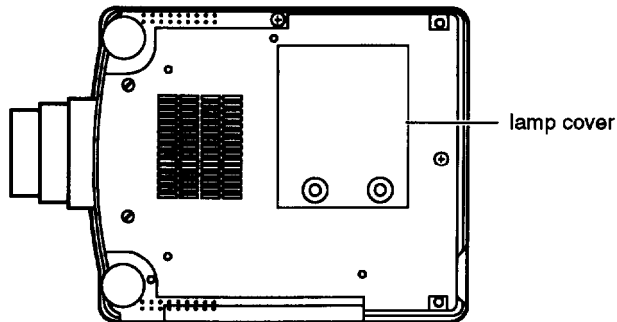

- 
3. Use a screwdriver, coin, or similar object to unloosen the two retaining screws on the lamp cover. You cannot remove these screws.
  4. When the screws are loose, lift off the lamp cover.

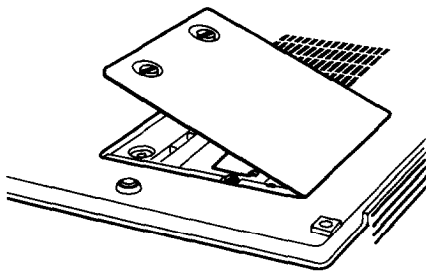

5. Use a screwdriver, coin, or similar object to unloosen the two screws holding the lamp in position. You cannot remove these screws.

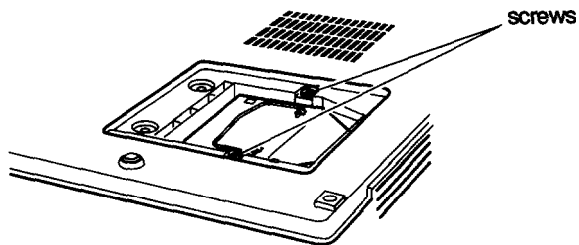

- 
- Lift up the handle and pull out the lamp.

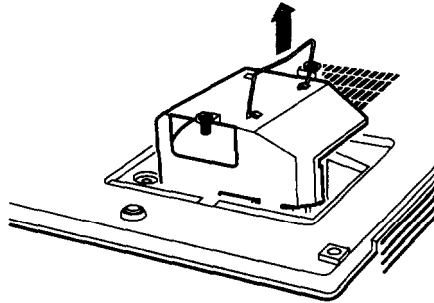

- Gently insert the new lamp by lowering it into position.
- Tighten the screws you loosened in step 5.
- Replace the lamp cover and tighten the cover screws.

Make sure the lamp cover is securely fastened. The projector turns itself off if the lamp cover is open.

---

## Replacing the Fuse

When you need to replace the fuse, use only a 250 V, 6.3 AT fuse appropriate for your voltage. **Follow** these steps:

1. Turn off the projector and disconnect the power cord from both the back of the projector and the wall outlet.
2. Turn the projector so its back panel is facing you. The fuse holder is located below the power switch.
3. Remove the fuse holder by inserting a screwdriver or similar object into the groove. Then pry out the holder.

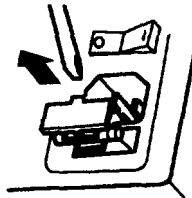

- 
4. To remove the fuse from the holder, pull out one end so it is at an angle. Then pull out the fuse.

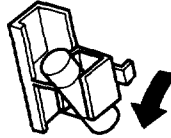

5. Insert the new fuse and push the fuse holder back into position.

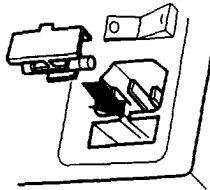

6. Reconnect the power cord.

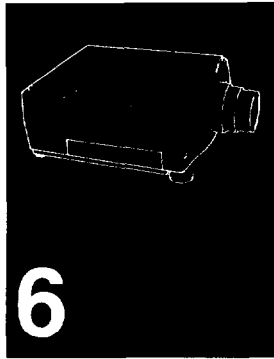

## Troubleshooting

This chapter describes what problems are indicated by the status lights and provides information on what to do if you are having problems with the projector. It is divided into the following sections:

- General problems with the projector. See this section if the projector is not working and to find out what the status lights are indicating.
- Problems with the screen image. See this section if you cannot project an image or if the screen image is not good.
- Problems with the remote control. See this section if the projector or computer does not respond correctly when you use the remote control.

If you have a problem, check the appropriate section and follow all suggestions that apply to your problem. If none of the suggested solutions solves the problem, call your ELP-3000 dealer or call the EPSON Connection. In the U.S., call (800) 922-8911. In Canada, call (800) GO-EPSON.



# Problems with the Projector

If you are having problems with the projector, first check the status lights at the top of the projector. These lights monitor the operation of the projector.

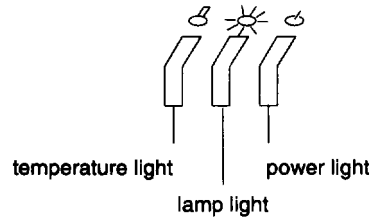

status light	Color	Status
Temperature	Flashing orange	The projector is hot.
	Orange	The projector is too hot. The lamp turns off.
Lamp	Flashing green	The lamp is warming up.
	Green	The lamp is on.
	Flashing orange	The lamp is cooling down.
	Flashing red	The lamp is not working.
Power	Orange	The projector is in standby mode.
	Green	The projector and lamp are on.
	Flashing green	The projector is receiving a signal from the remote control.
	Flashing red	There is a problem with the projector.

---

For specific problems, see the following:

**I The power status light does not come on.**

Check the power switch and make sure the power cable is securely connected at both the power outlet and the projector.

The projector has become too hot and has turned off automatically. Wait for the projector to cool before turning it back on.

The fuse may have blown. Replace the fuse as described in Chapter 5.

**I The lamp does not come on.**

The projector is in standby mode. Press the Standby button on the remote control or the operation panel.

The lamp is burned out and needs to be replaced.

**I The temperature status light is flashing orange.**

The lamp is too hot. Turn off the lamp and let it cool. When you turn the lamp back on, check the temperature light again. Make sure nothing is blocking the ventilation vents.





---

**I The temperature status light is orange.**

The projector is overheating and turns the lamp off automatically. Let the projector cool for a few minutes; then turn it back on. Make sure nothing is blocking the ventilation vents.

The air filter may be clogged. Clean it as described in Chapter 5 and then let the projector cool for a while.

If the projector continues to overheat after you clean the air filter, the problem may be caused by damage to the cooling fan or internal circuits. Contact a qualified service person.

**The lamp status light is flashing red and the lamp does not come on.**

Turn off the projector and turn it back on again. Check the lamp light again.

If the lamp still does not come on, it may have burned out or become damaged. Replace it as described in Chapter 5.

---

## Problems with the Image or Sound

- I An image does not appear on the screen.

Check that the power light is on and the lens cover is off. Also make sure the Y-cable is installed correctly to both the image source and projector as described in Chapter 1.

The projector may be in standby mode. Press the Standby button on the remote control or operation panel to turn on the lamp.

The correct image source may not be selected. Press the Video button on the remote control or operation panel to choose the other image source.

The brightness level may not be set correctly. Use the Brightness button to adjust the brightness level.

### **Only part of the computer image is displayed.**

Your monitor is set up for a resolution higher than 640 x 480, and the projector is compressing the image. You need to choose a different monitor display setting. In Windows, use Windows Setup in the Main program group. For a Macintosh, choose Control Panels under the Apple menu and then Monitors; in the Monitors screen, choose Options and make sure Macintosh Hi-Res Display or another 640 x 480 display is selected. For supported display settings, see Appendix A.

You may also need to modify existing presentation files if you created for them for a different resolution. See your software manual for specific information,



---

## I **Only the test pattern is displayed.**

The input source has not been selected correctly. Press the Video button on the remote control or operation panel to select the other image source.

The projector is not detecting the signal from the source. Check that the cable is securely attached to both the source and projector. If it is, the problem may be with your presentation software.

The proper order was not followed when the projector and peripheral devices were turned on. Turn off the projector and all devices in the reverse order shown on page 20. Then turn everything back on in the proper order.

## I **The image or parts of the image are blurred or not in focus.**

Turn the focus ring on the projector to see if this improves the image. Check also that the projector is within the recommended distance *according* to the size of the screen (see page 4). For the sharpest images, the projector must be perpendicular to the screen and the projection surface must be flat.

Adjust the Brightness and Contrast settings on the Computer or Video menu. If you're viewing a computer image, also try adjusting the Sync setting on the Computer menu.

There may be dirt or stains on the lens. Clean the lens as described in Chapter 5.

---

**The colors of the image are not right.**

The color balance may be incorrect. If you're displaying a computer image, adjust the Red, Green, and Blue settings in the Computer menu. If you're displaying video, adjust the Color and Tint settings. Check also that Invert in the Display menu is not selected.

The video cable from your computer may not be properly attached. Check to see that it is properly and securely attached to the connectors on both the projector and image source.

**Text is not displayed correctly.**

The software program you are using displays text at 720 Pixel, but the projector displays text at 640 Pixel. Use the Text setting in the Computer menu to compress the text to 640 Pixel.

**There is no sound.**

Check first that the volume setting is not turned all the way down and that the audio/video cable is securely attached to both the projector and the audio source. Press the Mute button on the remote control to make sure the mute function is not on.

The wrong source is selected. Use the Video button on the remote control to change the source. Also, check that the Audio Source setting in the Audio menu is not set for a specific source.

The Fade setting might not be appropriate. Adjust this setting in the Audio menu.



---

## Problems with the Remote Control

- 1 You programmed the buttons on the remote control to control the computer, but pressing one or more buttons has no effect.**

First make sure the RS-23X serial cable is properly and securely connected as described in Chapter 1. Check that the Serial setting on the Options menu is on and the ELP Remote Programmer is running on your computer.

The remote control is more than 33 feet from the projector or is more than 30 degrees to the side of the projector. Move closer to the projector and hold the remote control more directly in front of it.

There is an obstacle in the path between the remote control and the receiver at the front or back of the projector. Remove anything blocking the path. If you're using rear projection and the screen is between the remote control and the projector, you need to connect the remote control directly to the projector using the optional lead wire.

Both the ELP Remote Programmer and ELP Link utilities are running. When both are running, ELP Link has priority. You need to close ELP Link in order to use the ELP Remote Programmer.

The ELP Remote Programmer might be set up for a different serial port than the one you're using. Bring up the ELP Remote Programmer and open the Special menu to check which serial COM port is selected.

---

The batteries in the remote control are not inserted properly or are no longer good. Reinsert them or replace them if necessary.

A strong light source, such as direct sunlight or a compact fluorescent tube, is causing interference. Move the projector away from the strong light source.

**Using the trackball has no effect.**

The remote control is in sleep mode. Press any button to exit sleep mode so you can use the trackball.

**Double-clicking a programmable button has no effect.**

You are double-clicking too fast and the projector is not able to distinguish both clicks. Double-click more slowly.

**When using the ELP Remote Programmer on your PC, the mouse speed is too slow or too fast.**

The ELP Remote Programmer mouse speed and the Windows Control Panel mouse speed may be interfering with one another. First try adjusting the mouse speed in the ELP Remote Programmer's Special menu. If this does not solve the problem, adjust the mouse speed in your computer's Control Panel.



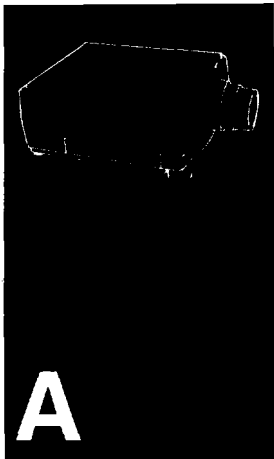

# Technical Specifications

---

## General

---

Type of display	Thin Film Transistor (TFT)
Size of liquid crystal panels	1.32 inches (33.6 mm)
Resolution	640 (horizontal) x 480 (vertical) pixels
Image size	21 to 300 inches (.5 to 7 meters)
Projection distance	4 to 40 feet (1.2 to 12.3 meters)
Remote control range	33 feet (10 meters)
Maximum volume	1W X 1W stereo



---

## Optical

---

Aspect ratio	4 x 3 (horizontal x vertical)
Brightness	250 lumens maximum
Zoom ratio	1:1.4

---

## Projector Lamp

---

Model number	MSCRI50E3H
Type	Metal halide
Power	150w

---

## Mechanical

---

Height	5.9 inches (14.9 cm)
Width	11.2 inches (28.5 cm)
Depth	16.3 inches (41.3 cm)
Weight	17 lb (7.7 kg)



---

## Electrical

---

Voltage	100-120V4C and 220-240VAC
Rated frequency	50/60 Hz
Fuse type	250V, 6.3AT, 5 x 20mm
Power consumption	220W (in standby mode, 50W) 100 - 120 VAC 3.5 Amps, 50/60 Hz 220 - 240 VAC 2.1 Amps, 50/60 Hz

---

## Environmental

---

Temperature	Operation:	41 to 104°F (5 to 40° C)
	Storage:	14 to 140° F (-20 to 60° C)
Humidity	Operation:	20 to 80% RH, non-condensing
	Storage:	10 to 90% RH, non-condensing

---

## Supported Monitor Displays

---

The projector displays images at a resolution of 640 x 480 pixels. To display a higher resolution image, the projector compresses it to 640 x 480.

The following table lists the display formats supported by the projector:

Computer type	Formats	Resolutions
IBM PC compatible	VGA, VESA, NEC, JEGA, CGA	640 x 460
		640 x 200
		640x400
		640 x 360
		720 x 360*
		720 x 400
		800 x 600*
Apple Macintosh	Standard 8- and 24-bit color monitor	640 x 460
		640x400

- Compressed to 640 x 460.

---

## Pin Assignments

---

The following tables describe the pin assignments for the three connectors of the Y-cable: LCD connector, VGA connector, and Monitor connector. The pin assignments for the VGA and Monitor connectors are identical.

### LCD connector pin assignments

The LCD connector is a 26-pin D-style connector. Its pin assignments are as follows:

Input pin	Signal	Output pin
1	Vertical sync	10
2	Horizontal sync	11
8	Blue analog	14
6	Intensity digital	12
7	Green digital	13
9	Red analog	15
16	Blue digital	3
17	Red digital	4
18	Green analog input with composite sync	5
20	GND	
21	GND	
22	GND	
23	Digital/analog video cable ID	
24	GND	
25	VGA/no video cable ID pin	
26	Monochrome digital (Hercules)	19



---

## Monitor and VGA connector pin assignments

The Monitor connector is a female video RGB, 15-pin micro-D style connector, and the VGA connector is a male video RGB, 15-pin micro-D style connector. The pin assignments for both connectors are as follows:

Input pin	Signal
1	Red analog input
2	Green analog input with composite sync
3	Blue analog input
4	GND
5	GND
6	Red GND
7	Green GND
8	Blue GND
9	NC
10	Sync GND
11	GND
12	NC
13	Horizontal sync/composite sync input
14	Vertical sync input
15	NC

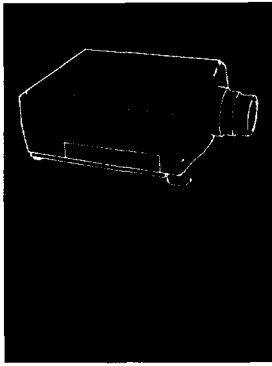

# Glossary

**Brightness.** The balance of light and dark shades in an image.

**Composite video.** A type of video signal that encodes picture, luminance, and synchronization information so it can be carried in one signal.

**Contrast.** A measure of the tonal differences between the highlights and shadows of an image. In a high-contrast image, light areas are very bright and dark areas are very dark, with relatively few levels of gray between white and black. Contrast is made lower by adding grays.

**ELP Remote Programmer.** Utility that **allows** you to use the remote control to control your computer. It also allows you to assign a keyboard macro to the remote controls five programmable buttons.

**Macro.** As used in the ELP Remote Programmer, a series of 32 keystrokes and mouse commands that can be assigned to a programmable button on the remote control. Pressing the button has the same effect as typing the keys contained in the macro.



---

**NTSC.** A 525-line video broadcast format developed by the National Television Standards Committee, NTSC is widely used in North America, Mexico, and Japan.

**PAL (Phase Alternation by Line).** A 625-line video broadcast format used in Western Europe, India, China, Australia, New Zealand, and parts of Africa.

**Record mode.** A Remote Control Programmer mode in which the codes for non-character keys are entered automatically when the key is pressed.

**Resolution.** A measure of the amount of detail contained in an image. Resolution can be measured in dots per inch or in pixels. Image sharpness and clarity improve as resolution increases.

**RGB.** A type of color scheme that defines color as percentages of red, green, and blue.

**RS-232C.** A standard type of serial communication.

**S-Video.** A type of video signal used in S-VHS videotape formats. It transmits luminance and color separately

**Saturation.** A measure of how much white is mixed with a hue. For example, a pale pink and bright red are the same hue but differ in the level of saturation, with red being very saturated and pink being pure (not saturated).

**SECAM (System Electronique pour Couleur Avec Memoire).** A 625-line TV system used in France, Eastern Europe, Russia, and parts of Africa.

---

Serial. The type of communication interface that transmits data over a single wire.

**Sleep mode.** A battery-saving feature in which the remote control becomes idle when it is not used for 15 minutes.

**Standby mode.** A power-saving feature in which the projector remains on but the lamp is turned off. By default, standby mode is automatically turned on when the projector is not used for 10 minutes.

**VGA.** Video Graphics Array, A high-resolution display adapter that provides a variety of video modes.