

DPX-1100

Digital Cinema Projector

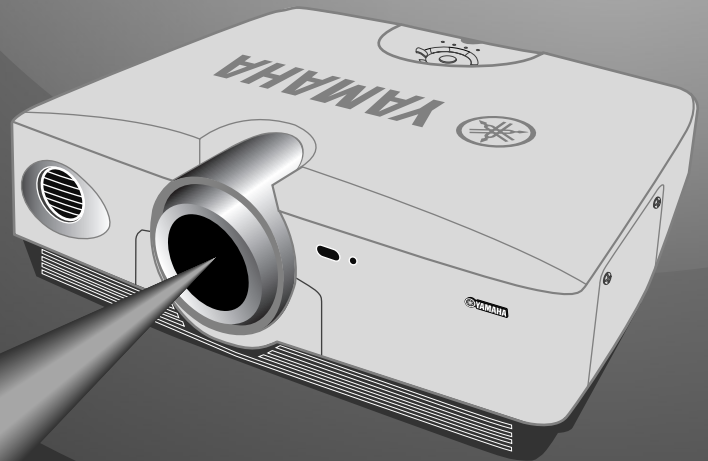

IMPORTANT SAFETY INSTRUCTIONS

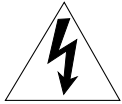

CAUTION

RISK OF ELECTRIC SHOCK
DO NOT OPEN



CAUTION: TO REDUCE THE RISK OF ELECTRIC SHOCK, DO NOT REMOVE COVER (OR BACK). NO USER-SERVICEABLE PARTS INSIDE. REFER SERVICING TO QUALIFIED SERVICE PERSONNEL.

• Explanation of Graphical Symbols



The lightning flash with arrowhead symbol, within an equilateral triangle, is intended to alert you to the presence of uninsulated “dangerous voltage” within the product’s enclosure that may be of sufficient magnitude to constitute a risk of electric shock to persons.



The exclamation point within an equilateral triangle is intended to alert you to the presence of important operating and maintenance (servicing) instructions in the literature accompanying the appliance.

WARNING

TO REDUCE THE RISK OF FIRE OR ELECTRIC SHOCK, DO NOT EXPOSE THIS UNIT TO RAIN OR MOISTURE.

IMPORTANT!

Please record the serial number of this unit in the space below.

Model:

Serial No.:

The serial number is located on the bottom of the unit.

Retain this Owner’s Manual in a safe place for future reference.

OBSERVERA

Apparaten kopplas inte bort från växelströmskällan (nätet) så länge som den är ansluten till vägguttaget, även om själva apparaten har stängts av.

ADVARSEL

Netspændingen til dette apparat er IKKE afbrudt, så længe netledningen sidder i en stikkontakt, som er t endt – også selvom der er slukket på apparatets afbryder.

VAROITUS

Laitteen toisiopiiriin kytketty käyttökytkin ei irroita koko laitetta verkosta.

- 1 Read these instructions.
- 2 Keep these instructions.
- 3 Heed all warnings.
- 4 Follow all instructions.
- 5 Do not use this apparatus near water.
- 6 Clean only with dry cloth.
- 7 Do not block any ventilation openings. Install in accordance with the manufacturer’s instructions.
- 8 Do not install near any heat sources such as radiators, heat registers, stoves, or other apparatus (including amplifiers) that produce heat.
- 9 Do not defeat the safety purpose of the polarized or grounding-type plug. A polarized plug has two blades with one wider than the other. A grounding type plug has two blades and a third grounding prong. The wide blade or the third prong are provided for your safety. If the provided plug does not fit into your outlet, consult an electrician for replacement of the obsolete outlet.
- 10 Protect the power cord from being walked on or pinched particularly at plugs, convenience receptacles, and the point where they exit from the apparatus.
- 11 Only use attachments/accessories specified by the manufacturer.
- 12 Use only with the cart, stand, tripod, bracket, or table specified by the manufacturer, or sold with the apparatus. When a cart is used, use caution when moving the cart/apparatus combination to avoid injury from tip-over.
- 13 Unplug this apparatus during lightning storms or when unused for long periods of time.
- 14 Refer all servicing to qualified service personnel. Servicing is required when the apparatus has been damaged in any way, such as power-supply cord or plug is damaged, liquid has been spilled or objects have fallen into the apparatus, the apparatus has been exposed to rain or moisture, does not operate normally, or has been dropped.
- 15 Be sure to allow spaces of at least 30cm above, behind and on both sides the unit.
- 16 Do not place the following objects on this unit:
A vessel with water in it. If the vessel falls by vibrations and water spills, it may cause damage to the unit, and/or you may get an electric shock.

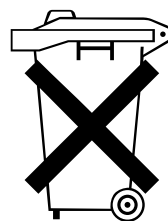

Alleen voor klanten in Nederland

Bij dit product zijn batterijen geleverd. Wanneer deze leeg zijn, moet u ze niet weggooien maar inleveren als KCA.

COMPLIANCE INFORMATION STATEMENT

(DECLARATION OF CONFORMITY PROCEDURE)

Responsible Party: Yamaha Electronics Corporation
Address: 6660 Orangethorpe Avenue
Buena Park, CA90620
Telephone: 714-522-9105
Fax: 714-670-0108
Type of Equipment: Projector
Model Name: DPX-1100

This device complies with Part 15 of the FCC Rules.

Operation is subject to the following conditions:

- 1) this device may not cause harmful interference, and
- 2) this device must accept any interference received including interference that may cause undesired operation.

See the user manual instructions if interference to radio reception is suspected.

FCC INFORMATION (for US customers only)

1. IMPORTANT NOTICE: DO NOT MODIFY THIS UNIT!

This product, when installed as indicated in the instructions contained in this manual, meets FCC requirements. Modifications not expressly approved by Yamaha may void your authority, granted by the FCC, to use the product.

2. IMPORTANT: When connecting this product to accessories and/or another product use only high quality shielded cables. Cable/s supplied with this product **MUST** be used. Follow all installation instructions. Failure to follow instructions could void your FCC authorization to use this product in the USA.

3. NOTE: This product has been tested and found to comply with the requirements listed in FCC Regulations, Part 15 for Class "B" digital devices. Compliance with these requirements provides a reasonable level of assurance that your use of this product in a residential environment will not result in harmful interference with other electronic devices.

This equipment generates/uses radio frequencies and, if not installed and used according to the instructions found in the users manual, may cause interference harmful to the operation of other electronic devices.

Compliance with FCC regulations does not guarantee that interference will not occur in all installations. If this product is found to be the source of interference, which can be determined by turning the unit "OFF" and "ON", please try to eliminate the problem by using one of the following measures:

Relocate either this product or the device that is being affected by the interference.

Utilize power outlets that are on different branch (circuit breaker or fuse) circuits or install AC line filter/s.

In the case of radio or TV interference, relocate/reorient the antenna. If the antenna lead-in is 300 ohm ribbon lead, change the lead-in to coaxial type cable.

If these corrective measures do not produce satisfactory results, please contact the local retailer authorized to distribute this type of product. If you can not locate the appropriate retailer, please contact Yamaha Electronics Corp., U.S.A. 6660 Orangethorpe Ave, Buena Park, CA 90620.

The above statements apply **ONLY** to those products distributed by Yamaha Corporation of America or its subsidiaries.

We Want You Listening For A Lifetime

YAMAHA and the Electronic Industries Association's Consumer Electronics Group want you to get the most out of your equipment by playing it at a safe level. One that lets the sound come through loud and clear without annoying blaring or distortion – and, most importantly, without affecting your sensitive hearing. Since hearing damage from loud sounds is often undetectable until it is too late, YAMAHA and the Electronic Industries Association's Consumer Electronics Group recommend you to avoid prolonged exposure from excessive volume levels.



Caution: Read this before operating this unit.

- To assure the finest performance, please read this manual carefully. Keep it in a safe place for future reference.

Installation

- Install this unit in a well-ventilated, cool, dry, clean place with at least 30 cm (1 feet) clearance on the top, right and left, and at the back of this unit — away from direct sunlight, heat sources, vibration, dust, moisture, and/or cold.
- Locate this unit away from other electrical appliances, motors, or transformers to avoid humming sounds. To prevent fire or electrical shock, do not place this unit where it may get exposed to rain, water, and/or any type of liquid.
- Do not expose this unit to sudden temperature changes from cold to hot, and do not locate this unit in an environment with high humidity (i.e. a room with a humidifier) to prevent condensation inside this unit, which may cause an electrical shock, fire, damage to this unit, and/or personal injury.
- On the top of this unit, do not place:
 - Other components, as they may cause damage and/or discoloration on the surface of this unit.
 - Burning objects (i.e. candles), as they may cause fire, damage to this unit, and/or personal injury.
 - Containers with liquid in them, as they may cause electrical shock to the user and/or damage to this unit.
- Do not cover this unit with a newspaper, tablecloth, curtain, etc. in order not to restrict heat dissipation. If the temperature inside this unit rises too much, it may cause fire, damage to this unit, and/or personal injury.
- When installing this unit on the ceiling, make sure the ceiling has sufficient strength to support this unit and the ceiling mounts for an extended period of time. Installation must be performed only by qualified service personnel.

Operation

- Remove the lens cover before starting any operation of this unit to prevent the heat from staying around the lens. Operation with the cap on may cause damage to this unit.
- Do not plug in this unit to a wall outlet until all connections are complete.
- Only the voltage specified on this unit must be used. Using this unit with a higher voltage than specified is dangerous and may cause fire, damage to this unit, and/or personal injury. YAMAHA will not be held responsible for any damage resulting from use of this unit with a voltage other than that specified.
- Do not use force on switches, knobs and/or cords.
- Take care of this unit so that no foreign objects and/or liquid drop inside this unit.
- To prevent damage by lightning, disconnect the power cord from the wall outlet during an electrical storm.
- Do not look into the lens while this unit is turned on. It may cause serious damage to your eyesight.
- Before moving this unit, press **STANDBY/ON** to set this unit in the standby mode, and disconnect the AC power plug from the wall outlet.
- Do not attempt to modify or fix this unit. Contact qualified YAMAHA service personnel when any service is needed. The cabinet should never be opened for any reason.

- When not planning to use this unit for a long period of time (i.e. vacation), disconnect the AC power plug from the wall outlet.
- When disconnecting the power cord from the wall outlet, grasp the plug; do not pull the cord.
- Be sure to read the “TROUBLESHOOTING” section on common operating errors before concluding that this unit is faulty.

Others

- Clean the lens carefully so as not to create any scratches by using a blower or lens paper.
- Replace the lamp when the LAMP warning indicator blinks in red after the lamp usage has exceeded 2000 hours. Follow the lamp replacement procedure described in this manual.

For U.K. customers

IMPORTANT

THE WIRES IN THIS MAINS LEAD ARE COLOURED IN ACCORDANCE WITH THE FOLLOWING CODE:

GREEN-AND-YELLOW:	EARTH
BLUE:	NEUTRAL
BROWN:	LIVE

As the colours of the wires in the mains lead of this apparatus may not correspond with the coloured markings identifying the terminals in your plug, proceed as follows:

The wire which is coloured GREEN-AND-YELLOW must be connected to the terminal in the plug which is marked by the letter E or by the safety earth symbol or coloured GREEN or GREEN-and-YELLOW.

The wire which is coloured BLUE must be connected to the terminal which is marked with the letter N or coloured BLACK.

The wire which is coloured BROWN must be connected to the terminal which is marked with the letter L or coloured RED.

If the socket outlets in the home are not suitable for the plug supplied with this appliance, it should be cut off and an appropriate 3 pin plug fitted. For details, refer to the instructions described below.

Note

- The plug severed from the mains lead must be destroyed, as a plug with bared flexible cord is hazardous if engaged in a live socket outlet.

For Canadian customers

To prevent electric shock, match wide blade of plug to wide slot and fully insert.

This Class B digital apparatus complies with Canadian ICES-003.

Table of contents

1 Getting started	2
Inappropriate places for installation	2
Accessory check	2
2 Features	3
3 Controls and functions	4
4 Remote control	6
5 Before using the DPX-1100 for projection	10
6 Projection	12
Checking installation and connections ...	12
Turning the projector power on / off	13
Selecting an input signal	15
Adjusting the vertical position and focus of an image	20
7 Menu	22
Menu configurations	22
Menu items	23
Menu operations	32
8 Memory function	41
(Saving, recalling, locking and resetting memory.)	
9 Connection	46
Connecting to image source components ...	46
Connecting to computer devices	47
10 Setting up the projector and screen	48
Setting up the projector	48
Projection distance and the screen	49
Projection image position	50
11 Reference	51
Glossary	51
Signals the DPX-1100 can project	53
Maintenance	54
Troubleshooting	56
Message display	58
LED Indicator meanings	59
Specifications	60
Dimensional drawing	61

Getting started	1
Features	2
Controls and functions	3
Remote control	4
Before using the DPX-1100 for projection	5
Projection	6
Menu	7
Memory function	8
Connection	9
Setting up the projector and screen	10
Reference	11

1 Getting started

◆ Inappropriate places for installation

If this unit is not correctly installed in an appropriate place, it may cause fire or failure, or damage the unit itself. Carefully choose the place to install this unit by avoiding the places listed below.

1. Places where the temperature and humidity vary greatly

- Do not install this unit in a place where the temperature and humidity become extremely high or the temperature becomes extremely low.
- This unit must be used within a temperature range of 5—35°C.

2. Places without adequate ventilation

- Install this unit with at least 30 cm (1 feet) of ventilation space on the top, right and left, and back.
- Do not cover the ventilation slots of this unit. Covering the slots will obstruct heat dissipation.
- Install this unit on the firm surface.
- Do not cover this unit with a tablecloth, etc.
- Make sure there is nothing to get sucked into the ventilation slots so that the temperature of this unit does not become too high.
- If you are going to install the unit in a rack, be sure to leave space for ventilation to prevent exhaust overheating the unit.

3. Places where it gets dusty

- If the filter is blocked with dust, the temperature of this unit may become too high.

4. Places with too much vibration or impact

- Vibration and impact can damage parts of this unit.

5. Places where this unit gets exposed to water or high humidity

- If this unit is exposed to water or high humidity, it may cause a fire or electrical shock.

6. Unstable places

- If this unit is installed on an unstable or an inclined tabletop, it may fall and cause damage to the unit or personal injury.

7. In close proximity to a Radio or Stereo

- The unit may interfere with reception if placed in close proximity to a radio or television receiver.

Warning

- To ensure vivid, high contrast images, make sure that no light other than the projector light falls directly on the screen.

◆ Accessory check

Please check that all accessories listed here are included in your package.

- Remote control
- Batteries (AA, UM-3 or R6)
- Power cable

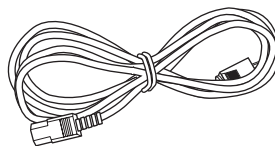
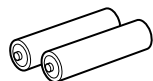
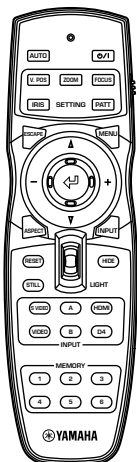

• Pin/BNC adapters

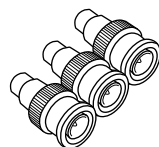

• Lens cap

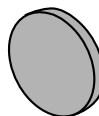

• Trigger-out DC plug
(For USA only)



Highly configurable electronic adjustment gives you the freedom to place the projector wherever you want

A short focal length, high power zoom, and fully vertically adjustable lens allow you to use the projector in a wide range of environments. You can also use the remote control to access many lens functions such as focus, zoom, and lens shift to fine-tune the projector from your viewing position.

Uses the latest DMD™ device HD2+

The projector uses the latest upgraded version of the high contrast 720p DMD™ “HD2” panel, the “HD2+”, to reduce black levels even further and reproduce contrasts close to that of a film.

Adjust 7 colors independently (including white), or use the automatic color balance function

Adjustment is not restricted to simple color temperature control. The DPX-1100 also allows you to adjust the 7-axis WRGBYCM color coordinate and gain parameters directly. For better consistency, you can also control color temperature and RGB balance together, allowing you to check that the changes you make are always consistent with your preferences.

The latest digital I/F provides sharp, detailed images

The DPX-1100 is equipped with an HDMI terminal, which is set to become the standard for the coming generation of products. Connect it to a DVD player or set-top box with a HDMI terminal to receive digital image data directly, and enjoy completely digitally processed images. Compatible with the content protection function of HDCP.

Intelligent memory functions

The DPX-1100 can store six image memory settings for each terminal. For each memory setting, you can set parameters for different input resolutions, and the unit will automatically switch to the parameters you set when it begins displaying an image of an appropriate resolution. For example, the unit automatically changes display settings without changing memory numbers when you change from watching a DVD to watching a HDTV image for which you have set different image menu item parameters.

In-line menus for image adjustment

You can access image adjustment menu items at the touch of a button, and adjust images while viewing them without opening the menu screen.

3 Controls and functions

◆ Main unit <Front panel and controls>

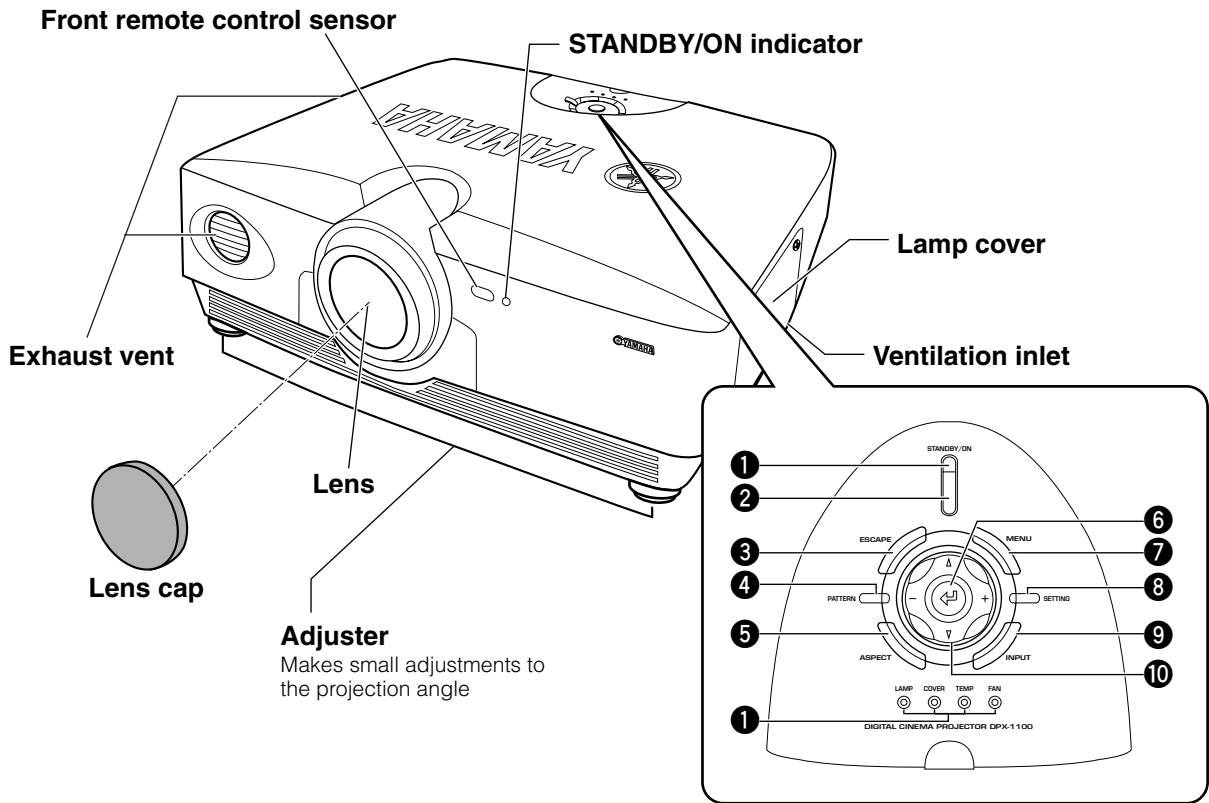

1 LED Indicators

The main unit is equipped with 5 indicators to display various states of operation. See page 59 for explanations of the LED indicator meanings.

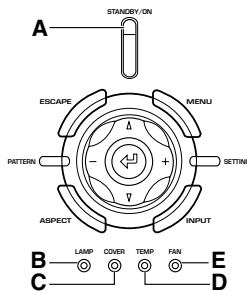

- A** STANDBY/ON indicator
(There is also an LED on the front panel of the main unit)
- B** LAMP warning indicator
- C** COVER warning indicator
- D** TEMP warning indicator
- E** FAN warning indicator

2 STANDBY/ON button

Switches the unit between Standby and On (operational) modes.

3 ESCAPE button

Exits from submenus.

4 PATTERN button

Switches the built-in test pattern on and off.

5 ASPECT button

Turns the display aspect menu for the project image on and off

6 (Enter) button

Sets values when the DPX-1100 is displaying the menu. When the menu is not displayed, the DPX-1100 displays the in-line image quality adjustment menu. (ℰ^{SP} page 40)

7 MENU button

Switches the settings and adjustments menu display on and off.

8 SETTING button

Selects lens adjustment modes.

9 INPUT button

Switches the input signal selection menu display on and off.

10 Cursor buttons

Use the Δ , ∇ , +, - buttons for system operations, menu item selection, and changing system values.

◆ Main unit <Rear panel / Connections>

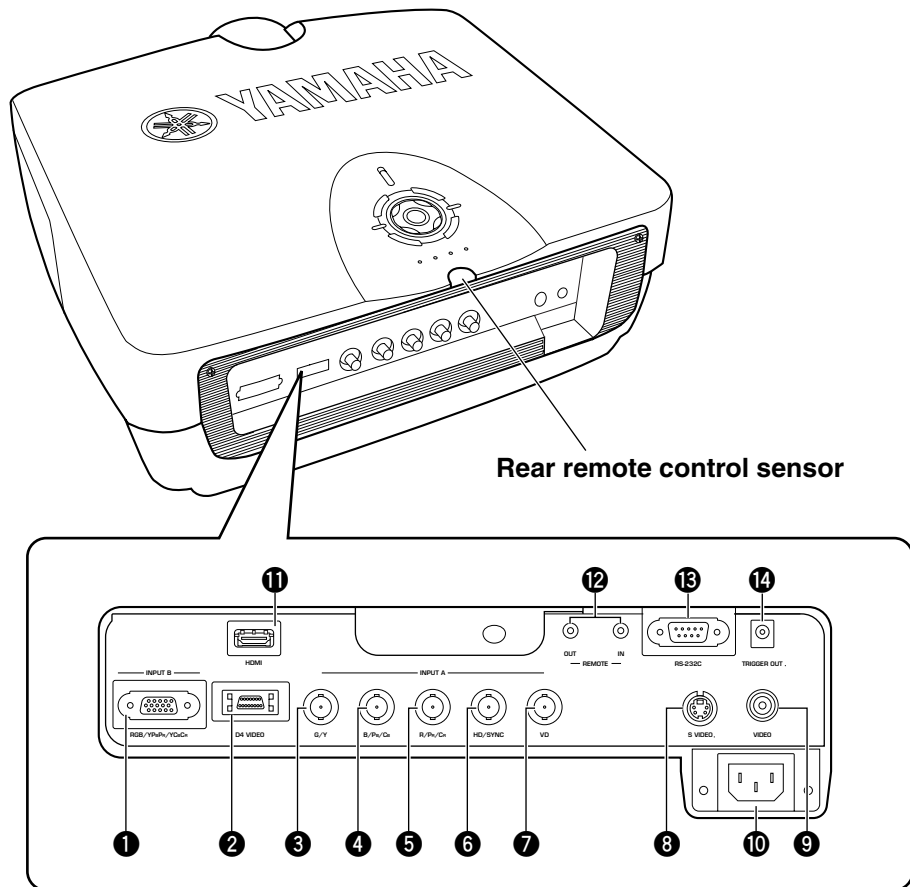

❶ INPUT B (D-sub 15 pin)

Receives component video and RGB (RGB/YPbPr/YCbCr) signals. Use a D-sub monitor cable to connect components to this jack.

❷ D4 VIDEO (D jack)

Receives signals output from the D jacks of other AV components. It is compatible with D1 - D4 formats.

❸ - ❷ INPUT A (BNC jacks)

Receive component video and RGB signals. Connect component signal connectors from AV components to input jacks ❸ - ❷, and RGB signal connectors from computers to input jacks ❸ - ❷. Use BNC cables for these connections.

- ❸ G/Y (G, or luminance signal)
- ❹ B/Pb/Cb (B, or color difference signal)
- ❺ R/Pr/Cr (R, or color difference signal)
- ❻ HD/SYNC (Horizontal sync signal, composite sync signal)
- ❼ VD (Vertical sync signal)

❽ S VIDEO (Mini DIN jack)

Receives signals from S-VIDEO output jacks of other AV components. Use an S-VIDEO cable for these connections.

❾ VIDEO (Pin Jack)

Receives composite video signals from the VIDEO output jacks of other AV components. Use a video pin cable for these connections.

❿ AC inlet

Insert the supplied AC power cord here.

⓫ HDMI™ (HDMI™ jack)

Receives HDMI™ signals from computers or AV components.

⓬ REMOTE IN / OUT jack

Connect the remote control to the REMOTE IN jack if you want to use it through a cable. The REMOTE OUT jack outputs the signal received through the REMOTE IN jack without any change.

⓭ RS-232C (D-sub 9 pin)

For use in servicing this unit.

⓮ TRIGGER OUT

Outputs control signals to external components. This output provides a potential of 12 V/ maximum 200 mA when this unit is projecting.

4 Remote control

◆ Remote control functions

Buttons on the remote control with identical names to those on the main unit perform identical functions. When using the remote control, point it at the sensor on the front or back of the main unit from a distance of 7m (23 feet) or less.

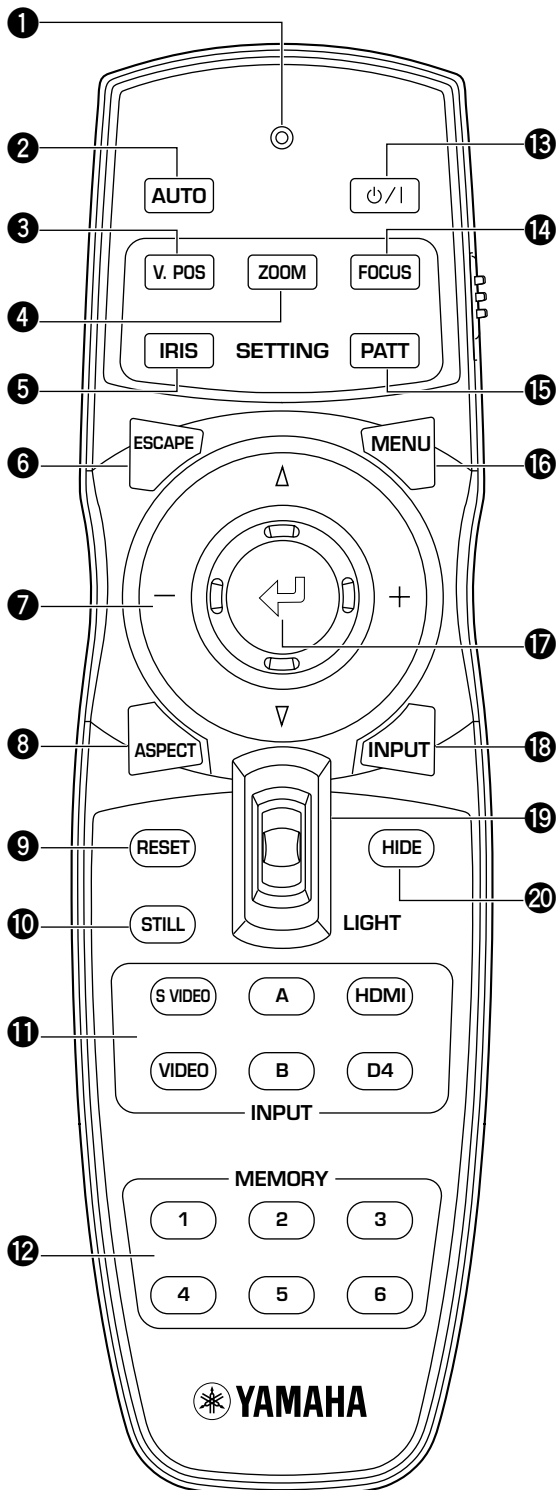

1 Transmit indicator

Lights up when the remote control sends infrared signals to the main unit.

2 AUTO button

Automatically sets the DPX-1100 to the best settings for the type of signal it is currently receiving.

3 V.POS button

Switches on or off the vertical adjustment mode for the entire image.

4 ZOOM button

Switches on or off the size adjustment mode for the image the DPX-1100 is projecting.

5 IRIS button

Switches on or off the lens iris change mode.

6 ESCAPE button

Exits from submenus.

7 Cursor buttons

Use the Δ , ∇ , +, - buttons to move the cursor within the on-screen display.

8 ASPECT button

Turns the display aspect menu for the project image on and off

9 RESET button

Resets all adjustable parameters to their default settings.

10 STILL button

Stops a moving image, displaying a still of the image the DPX-1100 is projecting. Press STILL again to cancel this effect.

11 INPUT area

Selects the INPUT jacks directly.

12 MEMORY area

Calls stored memory (all parameter settings) directly.

13 $\text{\textcircled{P}}/I$ button

Switches the unit between Standby and On (operational) modes.

14 FOCUS button

Switches on or off the focus adjustment mode for the image the DPX-1100 is projecting.

15 PATT (PATTERN) button

Switches on and off the built-in test pattern.

16 MENU button

Switches on and off the settings and adjustments menu display.

17 $\text{\textcircled{E}}$ (Enter) button

Sets values when the DPX-1100 is displaying the menu. When the menu is not displayed, the DPX-1100 displays the in-line image quality adjustment menu. (see page 40)

18 INPUT button

Switches on and off the input signal selection menu display.

19 LIGHT switch

Moving this switch up or down lights the high-use **2**, **6**, **8**, **13**, **16**, and **18** buttons. The light disappears if you do not perform any operation within 10 seconds.

20 HIDE button

Temporarily halts projection of the image the DPX-1100 is currently displaying. Press again to cancel this effect.

21 Remote control code switch

The remote control functions when the code set in the menu is the same as that set on the remote control. The default menu setting is ID-1.

22 Remote control cable jack

Connect a cable to this jack to link the remote control to the main unit.

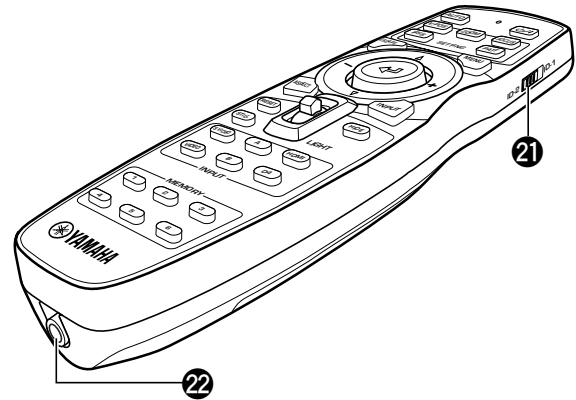

◆ Loading the batteries into the remote control

1. Remove the battery compartment cover.
2. Insert two batteries (AA, UM3, or R6 type), matching the polarity markings on the batteries with those in the battery compartment.
3. After loading the batteries, close the cover until it snaps into place.

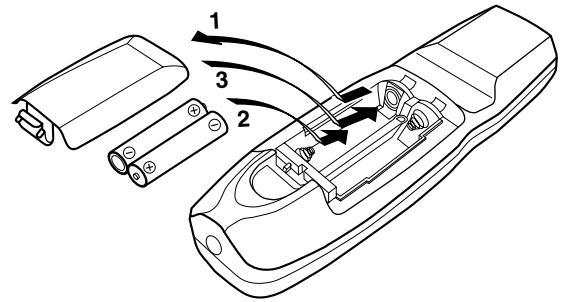

Warning

- If the remote control must be used closer to the main unit than normal, or does not always operate correctly, exchange the batteries for new ones.
- Do not mix old and new, or different types of batteries.
- Remove the batteries if you do not plan to use the unit for a long time.
- If the batteries leak, dispose of them immediately, taking care not to touch the battery fluid. If the battery fluid comes into contact with your eyes, mouth, or skin, rinse it off with water immediately and consult a doctor. Clean the battery compartment thoroughly before installing new batteries.

◆ Using the remote control with a wired connection

Use a 2P monaural miniplug cable to connect the remote control jack on the underside of the remote control to the REMOTE IN jack on the main unit.

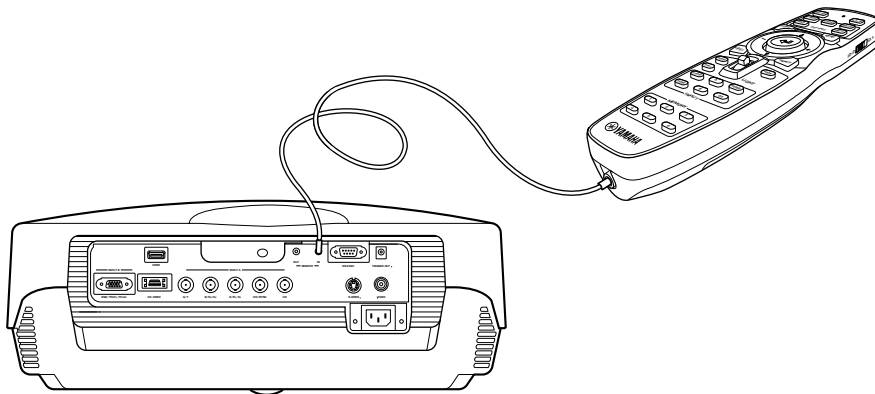

◆ Limits for using the remote control

Use the remote control within the following parameters. The remote control may not function correctly if you use it outside the limits detailed here.

Distance to sensor	Angle to sensor
7m (approximate value)	30° vertically and horizontally (approximate value)

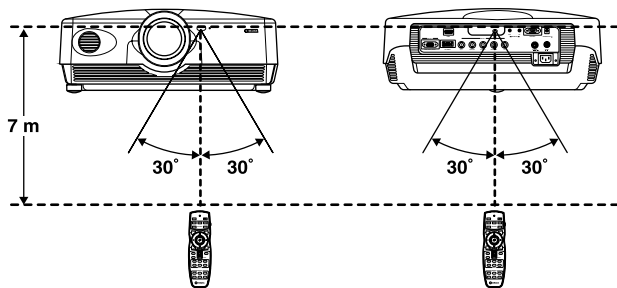

A left/right arc of 30 degrees

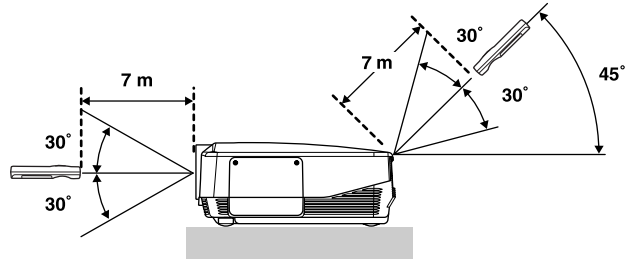

A vertical arc of 30 degrees

Warning

- Bright or fluorescent light on the main unit remote sensor may inhibit the functioning of the remote control
- Objects placed between the main unit remote sensor and the remote control may block the remote control signal and inhibit functioning.

5 Before using the DPX-1100 for projection

Before using the DPX-1100 (referred to as the main unit below) for projection, install the main unit and a screen, connect the main unit to an AV component or computer, and adjust the projection image. You can begin projection as soon as installation is complete. Refer to the sections below for information on how to install the main unit to suit your viewing environment.

◆ You have not installed the main unit or screen

- Immediately after purchase, when you have not installed either the main unit or a screen.
- When moving the main unit and screen to a new location.

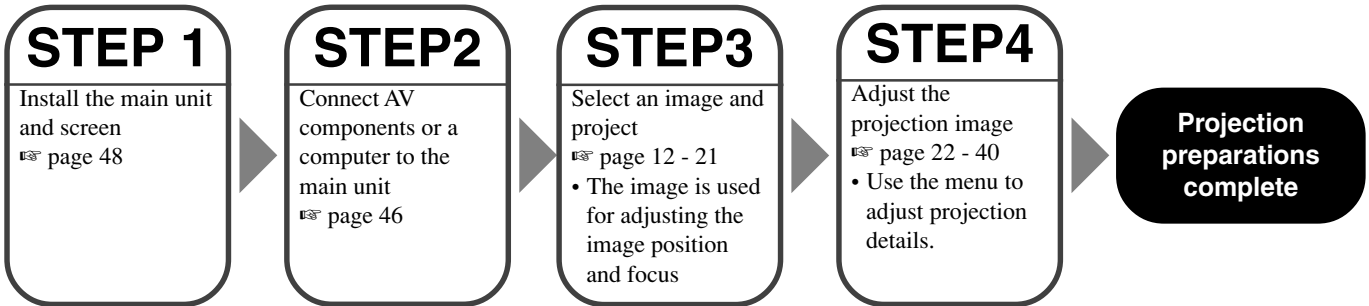

◆ You have installed the main unit and screen, but not connected any image playback components

- You have installed the main unit and screen, but not connected any image playback source components.
- You are using the main unit in a previously installed location, and wish to change the component you use as an image playback source.

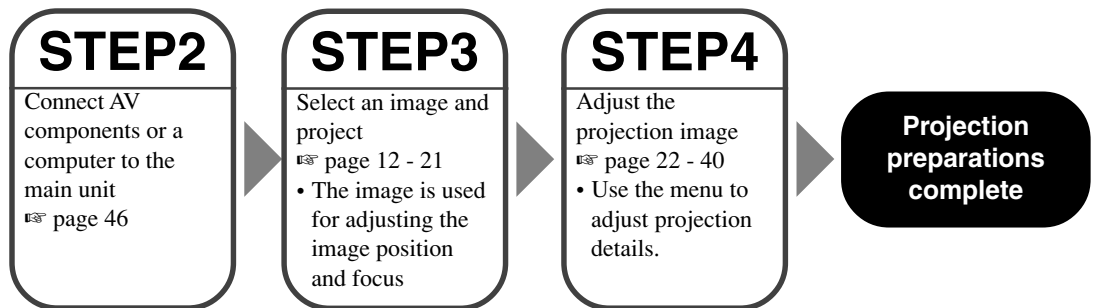

◆ You have installed the main unit and screen, and connected an image playback component

- You have installed the main unit and screen, and connected image playback source components.
- You are using the main unit in a previously installed location with previously connected source components.

You do not need to carry out step 3 or step 4 if you do not want to adjust the projection image. If the unit does not project the image correctly, it may not be connected correctly. In this case, carry out this procedure starting from step 2.

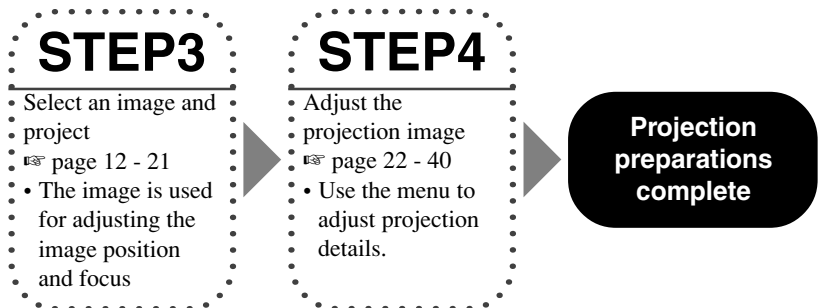

Step1

Setting up the projector and screen

- Install the projector
- Install the screen  page 48

Step2

Connect an AV component or a computer

- Connect AV components
- Connect a computer  page 46

Step3

Turning the projector power on and selecting an image for projection

- Turn on the projector power
- Begin playback of the input image
- Select an input signal
- Select a project image aspect
- Adjust the image
Focus/Vertical and Horizontal position/Size/Iris
 page 12 - 21

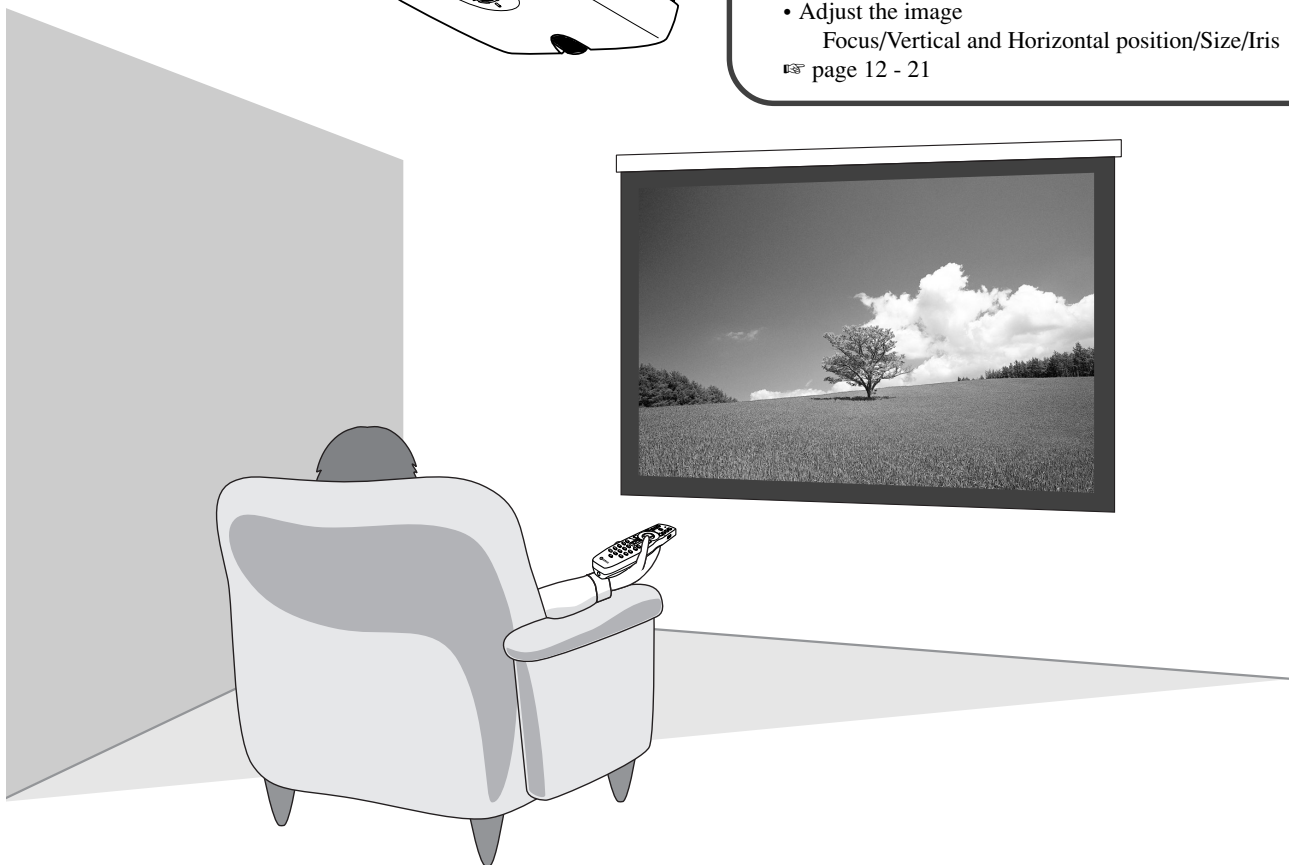
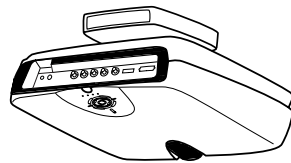

Step4

Using the menu to adjust the image quality and other parameters

- Adjusting image quality: Set image quality details
- Signal setting: Set input signal details
- Default settings: Set the default settings for everyday use
- Installation settings: Set to suit your viewing environment  page 22 - 40

Only adjust these parameters when necessary. It is not necessary to adjust these settings once you have set them initially.

6 Projection

Checking installation and connections

◆ Pre-operation check

Prior to projection, adjust settings to suit the location of the main unit and screen, and the input signal you are using.

However, there is usually no need to adjust any settings if you have not changed the installation location or components since the last time you used this unit. Check settings and connections only when the unit does not appear to project images correctly.

Prior to projection, check that the main unit and screen are correctly installed, and that image source components are connected correctly.

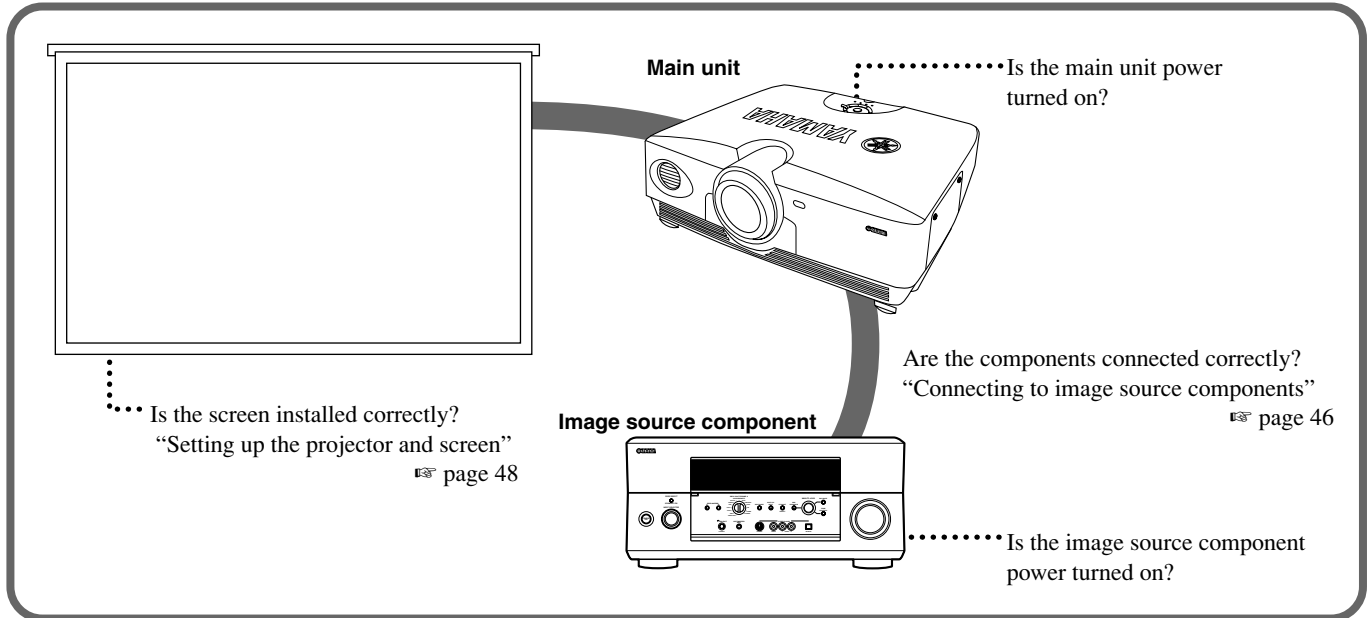

To project images, carry out the following procedure

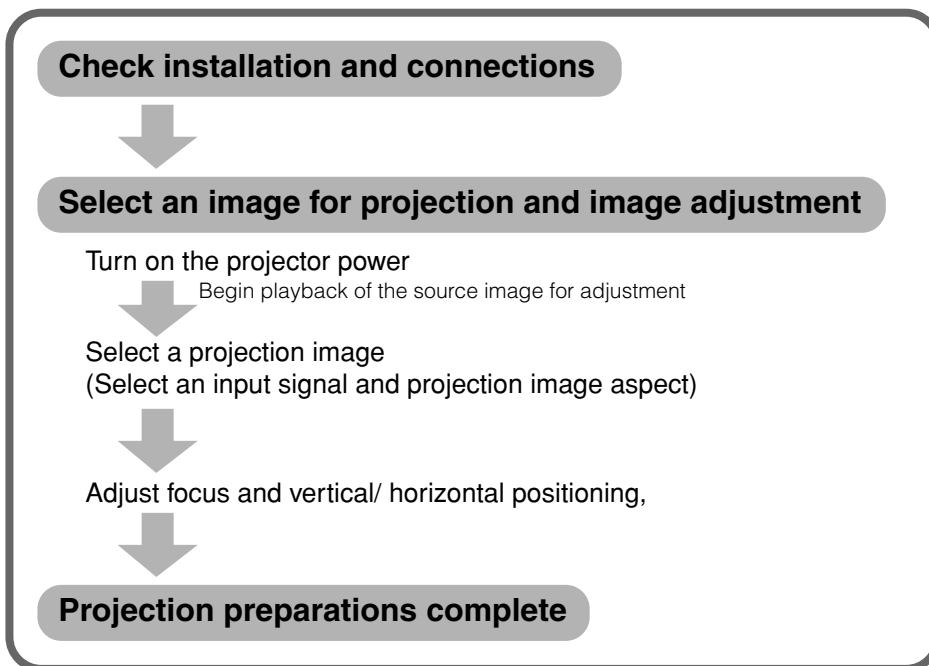

For an explanation of detailed settings, see "Menu". page 22 - 40

Turning the projector power on / off

◆ Turning the power on

Always remove the lens cap before operating the main unit.

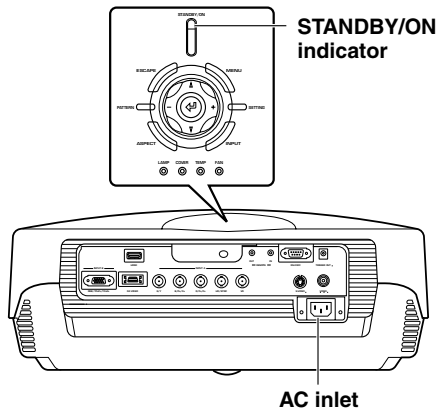

1. Insert the supplied power cord firmly into the AC inlet at the rear of the main unit, then insert the plug into an AC outlet.

The STANDBY/ON indicator lights orange.

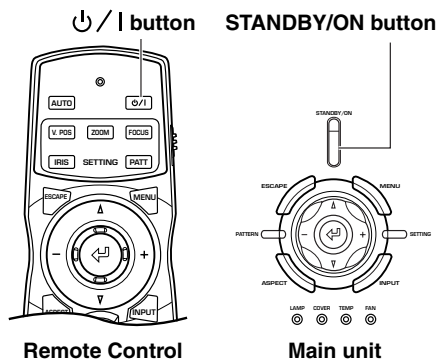

2. Press the STANDBY/ON button (the  / | button on the remote control).

The indicator blinks green and the lamp lights up in preparation for projection. After approximately 35 seconds, the indicator changes from blinking to solid green, indicating that the unit is ready to project.

Warning

- Do not remove the power cord while the STANDBY/ON indicator is blinking green or lit steady green. This could damage the lamp or reduce lamp life.

◆ Turning power off

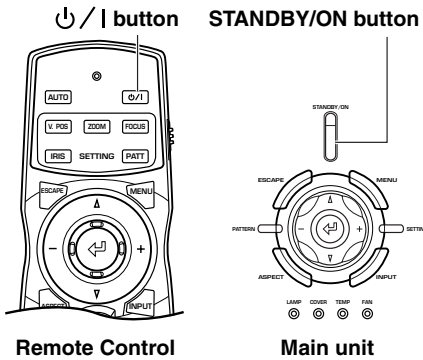

1. Press the STANDBY/ON button.

A confirmation message appears on the screen.

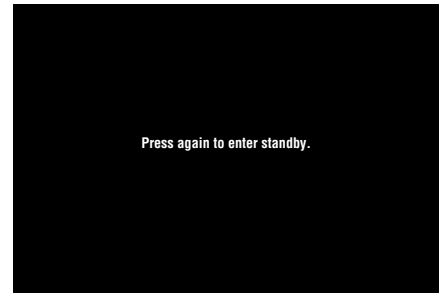

2. When you wish to turn off the main unit power, press the STANDBY/ON button again.

The lamp changes to a half lit state, and the fan activates for 2 minutes to cool the lamp. During this time, the STANDBY/ON indicator blinks orange, and pressing STANDBY/ON does not turn main unit power on again. When the unit finishes cooling, the fan stops, and the STANDBY/ON indicator turns orange.

Memo

- The lamp may blink when half lit. This is not a defect.

Warning

- Do not remove the power cord while the STANDBY/ON indicator is blinking green or when the fan is activated. This could damage the lamp or reduce lamp life.

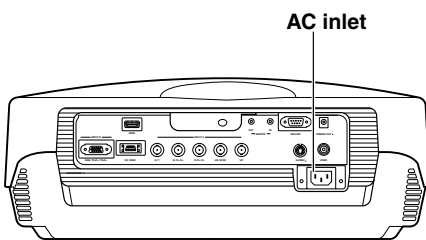

3. If you do not plan to use the main unit for a long period of time, attach the lens cap and remove the plug from the AC outlet.

Warning

- Condensation may appear on the unit if the temperature of the surrounding environment changes quickly. Condensation may also cause the projected image to be cloudy. Switch off the unit power until the condensation disappears. Switching the unit on when condensation is present may damage the unit.

Selecting an input signal

◆ <Select using the INPUT button>

Press the INPUT button to select an input signal from an image source component. Choose from the following:

INPUT SIGNAL	Projection image signal
VIDEO	Selects component video signals received from AV components connected to the VIDEO jack.
S VIDEO	Selects S-Video signals received from AV components connected to the S VIDEO jack.
INPUT A	<ul style="list-style-type: none">• Component : Selects component signals received from the INPUT A BNC jacks.• RGB PC : Selects RGB signals received from computers connected to the INPUT A BNC jacks.• RGB TV : Selects RGB signals received from AV components connected to the INPUT A BNC jacks.
INPUT B	<ul style="list-style-type: none">• Component : Selects component signals received from the INPUT B D-sub 15 pin jack.• RGB PC : Selects RGB signals received from computers connected to the INPUT B D-sub 15 pin jack.• RGB TV : Selects RGB signals received from AV components connected to the INPUT B D-sub 15 pin jack.
HDMI	<ul style="list-style-type: none">• Auto : Signals input to the HDMI jack from AV components (automatically distinguishes between component and RGB signals).• Component : Selects digital component signals received from AV components connected to the HDMI jack.• RGB TV : Selects digital RGB signals received from AV components connected to the HDMI jack.
D4 VIDEO	Selects component signals received from AV components connected to the D4 VIDEO jack.

<Using the INPUT button to select a signal>

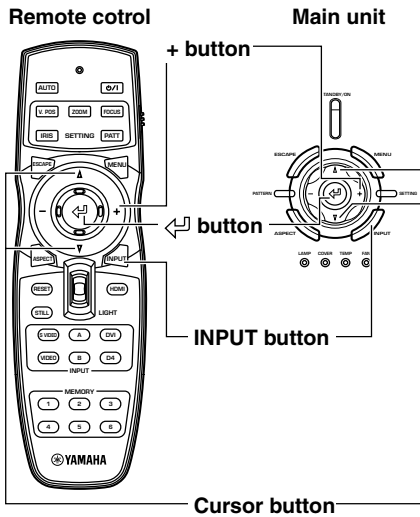

1. Press the INPUT button.

The input signal selection menu appears on the display.

Input signal
VIDEO
S VIDEO
INPUT A
INPUT B
HDMI
D4

2. Use the Δ , ∇ cursor buttons to select an input signal, then press the \leftarrow button.

Input signal
VIDEO
S VIDEO
INPUT A
INPUT B
HDMI
D4

Warning

- You can select [Component], [RGB PC], or [RGB TV] for INPUT A and INPUT B, or [Auto], [Component], or [RGB TV] for HDMI, from the submenu. If you do not select a setting, the unit continues to use the setting from the last signal it received. To change this setting, carry out the following procedure.

3. Press the + button to open the submenu.

Input signal
VIDEO
S VIDEO
INPUT A 
INPUT B
HDMI
D4

The  mark to the right of the input signal name indicates that there is a submenu available for selection.

4. Select an appropriate setting from [Component], [RGB PC], or [RGB TV] and press the \leftarrow button to confirm the setting.

Input signal	
VIDEO	
S VIDEO	
INPUT A	Component
INPUT B	RGB PC
HDMI	RGB TV
D4	

Memo

- If you set your laptop or notebook computer to display simultaneously on its built-in display and on an external monitor, the main unit may not project the image incorrectly. If this occurs, set your computer to display on the external monitor only. Refer to your computer's operating instructions for further details.

◆ Selecting a display aspect for a projection image

The display aspect parameter sets the ratio of length to breadth the unit uses to project an image for an input signal.

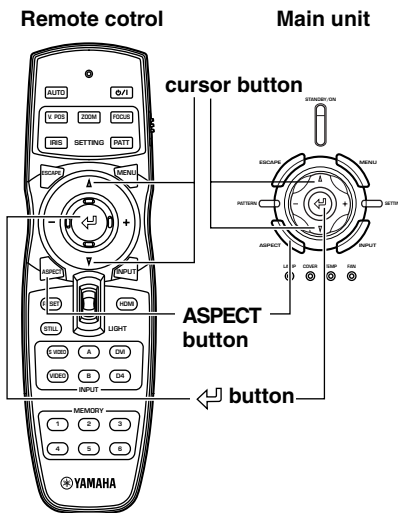

1. Press the ASPECT button.

The display aspect selection menu appears on the display.

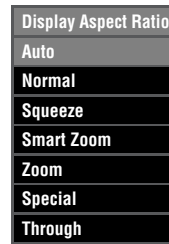

2. Use the Δ , ∇ cursor buttons to select a suitable display aspect setting, then press the \leftarrow button.

If you select [Special] or [Through], pressing the + button displays a submenu.

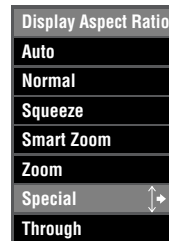

Memo

- The display aspect you can use depends on the current input signal. When the input signal contains display aspect information, set the display aspect parameter to [Auto] to detect the appropriate display aspect setting automatically.
- You can also use the [Display Aspect Ratio] page in the menu screen to select a projection image display aspect. (page 22- 40)

<Display aspect types>

Memo

- Refer to the glossary for explanations of terms such “letterbox” or “squeeze”. (☞ page 51)

Auto

The unit detects information encoded in letterbox or squeeze type input signals and automatically selects an appropriate display aspect. Depending on the input source, the unit may not change to the most appropriate mode. In this case, manually select a suitable setting.

Normal

Project images with their original display aspect. Depending on the input signal, black areas may appear to the left and right of the image.

Squeeze

Returns horizontally compressed images to their original aspect. Use this mode to display horizontally squeezed images in a normal wide aspect manner.

Smart Zoom

Stretches the left and right edges of a 4:3 image without altering the image center, to project a 16:9 image that fills the screen.

Zoom

Projects images the unit receives in letterbox format as 16:9 images that fill the screen.

Special

Subtitle Zoom

The best format for projecting subtitled letterbox format software. See page 38 for the operational procedure.

- Subtitle area: Adjust the area used to display subtitles on screen.
- V Scroll: Adjusts the vertical position of the subtitles.

Cinema Zoom

Removes the black bar from Cinescope size screens (2.35:1) to display a full horizontal image, cutting both screen sides. There are two types: SDTV for 4:3 images, and HDTV for 16:9 images.

Cinema Squeeze

Removes the black bar from cinescope size screens for 4:3 images in which the cinescope size has been squeeze recorded to compress and resize the vertical image so that a 16:9 panel resolution is fully displayed, cutting both screen sides.

14:9 Zoom

14:9 images recorded at 4:3 are displayed in full vertical image, wherein the black area on the either screen side is kept.

Through

Normal Through

A mode that projects images without stretching or reducing them. The size of the projection image depends on the resolution of the image received.

Squeeze Through

Widen the image received to project it with a 16:9 aspect ratio. The size of the projection image depends on the resolution of the image received. This mode is not available for RGB PC input signals.

<Representative examples>

Input signal type		Input image	Display aspect	Projected image
Standard 4:3 image			Normal	
			Smart Zoom	
Letter box			Zoom	
			Subtitle Zoom	
			Cinema Zoom	
Squeeze			Squeeze	
			Squeeze	
		Cinema Squeeze		
14:9 image			14:9 Zoom	
HDMI	Normal		Normal	
	Cinema Scope		Cinema Zoom	
RGB PC			Normal	
All	Normal		Normal Through	
	Squeeze		Squeeze Through	

Adjusting the vertical position and focus of an image

Carry out the following adjustments to obtain the optimal projection conditions.

◆ Using the test pattern to adjust the projection image – PATT button

This unit is equipped with three test patterns, the crosshatch pattern necessary for focus and keystone adjustment, and the grayscale and color bar patterns necessary for adjusting image quality.

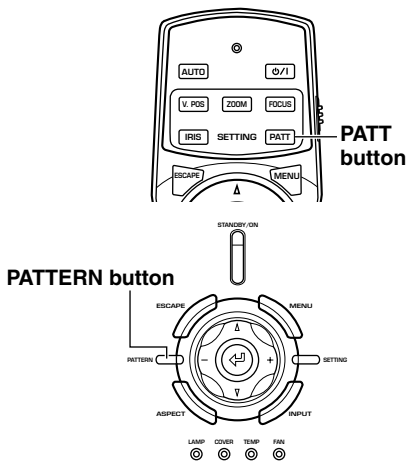

1. Press the PATT button on the remote control, or the PATTERN button on the main unit.
2. Press the + or - buttons to select the necessary pattern.
3. To exit from test display, press the PATT or PATTERN buttons.

Crosshatch pattern

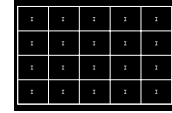

Grayscale pattern

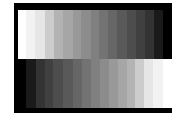

Color bar pattern



◆ Adjusting the vertical position – V.POS button

If the center of the screen is not in line with the center of the lens of this unit, use the V.POS button to adjust the position of the projected image up or down. You can adjust the image to a maximum of half of the height of the projection screen.

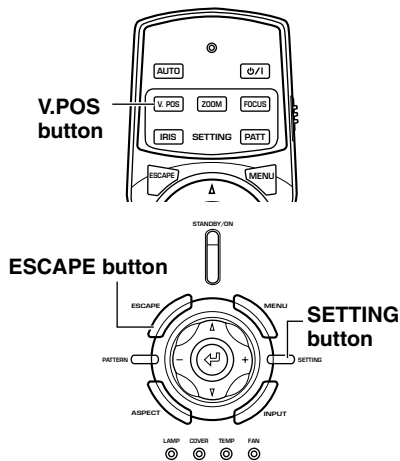

1. Press the V.POS button on the remote control, or press the SETTING button on the main unit repeatedly to select [Lens Shift] from the display menu.
2. Press the Δ or ∇ button to move the projected image to a suitable place.
3. To exit from the adjustment mode, press the V.POS or ESCAPE buttons.

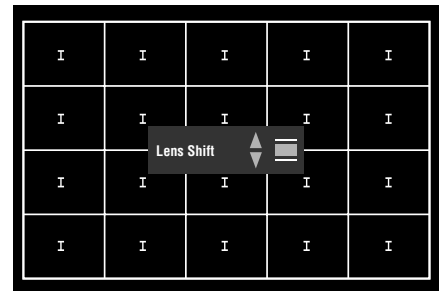

◆ Adjusting the size of an image – ZOOM button

Enlarge or reduce the size of the projection image to match the size of the screen. The zoom ratio is 1:1.6.

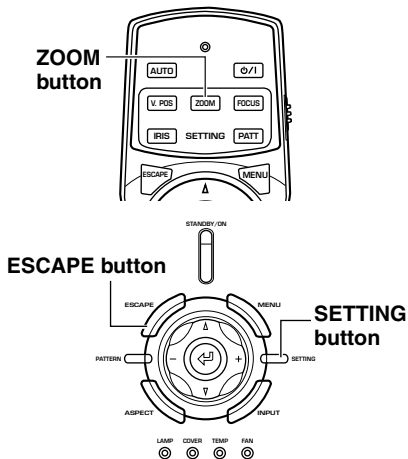

1. Press the ZOOM button on the remote control, or press the SETTING button on the main unit repeatedly to select [Zoom] from the display menu.
2. Press the Δ or ∇ buttons to adjust the projected image to a suitable size.
3. To exit from the adjustment mode, press the ZOOM or ESCAPE buttons.

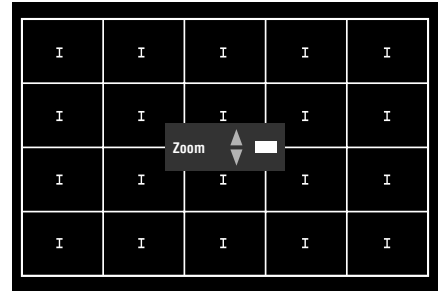

◆ Adjusting the image focus – FOCUS button

Adjust the focus of the on-screen image.

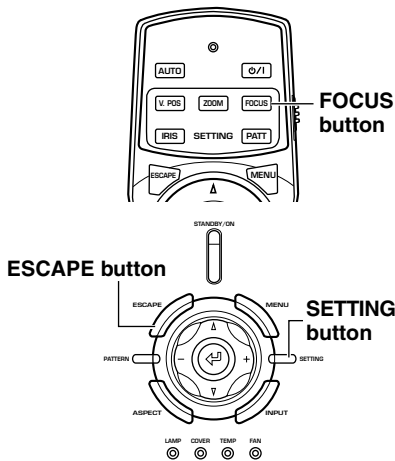

1. Press the FOCUS button on the remote control, or press the SETTING button on the main unit repeatedly to select [FOCUS] from the display menu.

Memo

- When you want to use the test pattern to adjust image focus press the PATT button on the remote control, or the PATTERN button on the main unit before carrying out step 1.
2. Press the Δ or ∇ buttons to adjust the focus of the projected image.
 3. To exit from the adjustment mode, press the FOCUS or ESCAPE buttons.

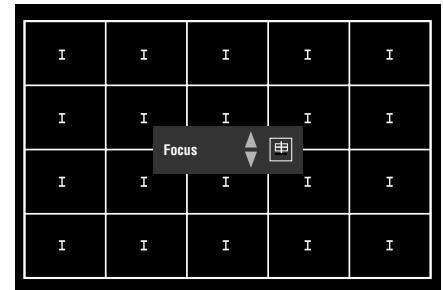

◆ Adjusting the iris setting – IRIS button

Press the ∇ button to reduce the aperture of the iris for increased black levels and contrast, or the Δ button to increase aperture to obtain a brighter image.

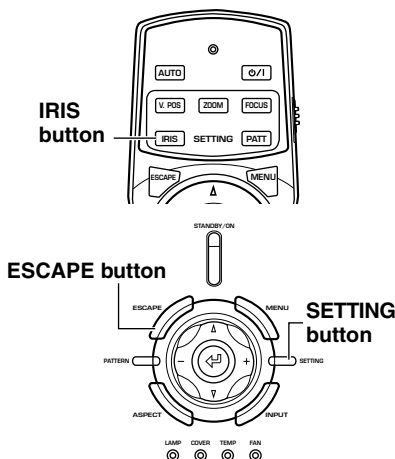

1. Press the IRIS button on the remote control, or press the SETTING button on the main unit repeatedly to select [IRIS] from the display menu.
2. Press the Δ or ∇ buttons to adjust the iris setting for the projected image.
3. To exit from the adjustment mode, press the IRIS or ESCAPE buttons.

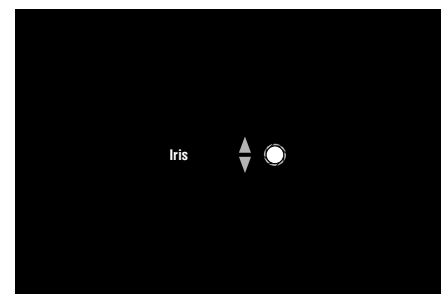

Menu configurations

You can configure the DPX-1100 to suit your viewing environment by adjusting parameters that affect image quality, initial settings, defaults, and setup characteristics. These parameters can be accessed through the menu.

The menu consists of the [Image], [Signal], [Initial], and [Setup] menu groups, each containing numerous items you can use for configuring the unit. Note that some items are only selectable for certain types of input signal (Video, Component, RGB TV, RGB PC).

Press the MENU button on the remote control or main unit to display the menu screen.

Menu groups appear in the upper area of the display, as the top level of menu composition. Menu items appear in the left area of the display. You can select settings and make adjustments to suit your preferences. See page 32 - 40 for an explanation of how to use the menu.

◆ Menu screen

<Example: When in advanced mode>

Menu group
[Image] selected.

Menu items
The items displayed here depend on the menu group you select.

Menu operation guide
Displays helpful instructions when special operations are necessary.

Memory number status
Displays the currently selected memory number and memory status. Change the memory number and lock/unlock memory settings here (see page 41-43).

Input jack display area
Shows the currently selected input jack.

Parameter adjustment area

[Move Menu Window] area
Use this selection area to move menu screens. See page 37 for more information.

There is an additional level of items below menu items (called sub menus). Moving the cursor to an item with a submenu attached displays a ↗ to the right of the item name. Some submenus contain further levels of submenus containing items for selection.

<Display example: [Color Adjustment] item submenu>

Indicates the existence of a submenu

[Color Adjustment] submenu

[WRGB] submenu

In this example, the menu has three levels: the [Color Adjustment] item contains 3 submenus [Standard] • [WRGB] • [WRGBYCM], and the [WRGB] submenu contains a further submenu.

Menu items

◆ Menu item list:

There are two types of menus, [Basic Mode] and [Advanced Mode].

- Basic mode: The menu displays menu items that are frequently used or absolutely necessary to image projection.
- Advanced mode: The menu displays all menu items, allowing you to carry out detailed adjustments.

You can change between the menu modes using the [Menu Mode] setting in the [Setup] menu group.

<Basic Mode>

● Image

Black Level (Brightness)
White Level (Contrast)
Gamma
Hue
Saturation
Color Temp
White Correction
Sharpness Type
White Peaking

● Signal

Display Aspect Ratio	★ 3
Setup Level (SDTV)	
Setup Level (HDTV)	
Signal Status	★ 4

● Initial

Color System	★ 5
INPUT A Signal	★ 6
INPUT B Signal	★ 6
HDMI Signal	
Display Language	★ 7
Lamp Running Time	
Reset	★ 8

● Setup

Location	★ 9
Keystone Correction	
Lens Adjustment Lock	
Menu Color	★ 12
Menu Mode	

<Advanced Mode>

● Image

Black Level (Brightness)	
White Level (Contrast)	
Gamma	
Hue	
Saturation	
Sharpness Type	
Sharpness Gain	
Color Adjustment	★ 1
White Peaking	
Iris	
Level Adjustment	★ 2

● Signal

Display Aspect Ratio	★ 3
Overscan	
3D Y/C separation	
Noise Reduction	
Video Type	
Progressive Mode	
Color Space Conversion	
Setup Level (SDTV)	
Setup Level (HDTV)	
Clamp Position	
Sync Adjustment	
Tracking	
Horiz. Display Position	
Vert. Display Position	
Signal Status	★ 4

● Initial

Color System	★ 5
INPUT A Signal	★ 6
INPUT A Sync Type	★ 6
INPUT B Signal	★ 6
INPUT B Sync Type	★ 6
HDMI Signal	
Auto Power Off	
Auto Input Search	
Display Language	★ 7
Lamp Running Time	
Reset	★ 8

● Setup

Location	★ 9
Keystone Correction	
Remote Control Sensor	★ 10
Remote Control ID	★ 11
Lens Adjustment Lock	
Lamp Power	
Menu Color	★ 12
Menu Mode	
Message	
Trigger Out	★ 13
Baud Rate	

Memo

- Menu items you can choose may differ depending on the input signal type.
- Items in the menu that contain submenus are marked with a ★.

<Submenu Items>

The submenus display different items depending on the input signal. Items in the submenu that contain further submenus are marked with a ☆.

● Image

★ 1: Color Adjustment	
Standard	☆ 1
WRGB	☆ 2
WRGBYCM	☆ 3
★ 2: Level Adjustment	
Y Offset	
Cb Offset	
Cr Offset	
Y Gain	
Cb Gain	
Cr Gain	

● Signal

★ 3: Display Aspect Ratio	
Auto	
Normal	
Squeeze	
Smart Zoom	
Zoom	
Special	☆ 4
Through	☆ 5
★ 4: Signal Status	
Resolution	
Sync Type	
Sync Polarity	
Frequency	
Source Equipmet (HDMI only)	

● Initial

★ 5: Color System	
Auto	
NTSC	
NTSC4.43	
PAL	
PAL-M	
PAL-N	
PAL60	
SECAM	
★ 6: All Input Signals	
Component	
RGB PC	
RGB TV .etc	
★ 7: Display Language	
日本語	
English	
Deutsch	
Español	
Français	
Italiano	
Portuguêsa	
한국어	
中文	
★ 8: Reset	
All Settings	
All Memory	
Current Memory	

● Setup

★ 9: Location	
Front/Table	
Front/Ceiling	
Rear/Table	
Rear/Ceiling	
★ 10: Remote Control Sensor	
Front & Rear	
Front	
Rear	
Off	
★ 11: Remote Control ID	
ID 1	
ID 2	
★ 12: Menu Color	
Monotone	☆ 6
Color	☆ 7
★ 13: Trigger Out	
Lamp	
Fan	
RS-232C	

<Lower level menu items>

☆1 Standard

• Color Temp.

☆2 WRGB

• Color selection screen
├ Color coordinate
└ Gain

☆3 WRGBYCM

• Color selection screen
├ Color coordinate
└ Gain

☆4 Special

• Subtitle Zoom
├ Subtitle Area
└ V Scroll
• Cinema Zoom
• Cinema Squeeze
• 14:9 Zoom

☆5 Through

(For video type input signal)
• Normal Through
• Squeeze Through

☆6 Monotone

• Menu Brightness
• Menu Contrast

☆7 Color

• Menu Brightness
• Menu Contrast
• Color Style

Memo

- In addition to color temperature adjustment, the color coordinates and gain adjustment for each color may be carried out at the [WRGB] and [WRGBYCM] color selection screen. Refer to page 36 for operation.
- You can select [Subtitle Area] and [V Scroll] from the [Subtitle Zoom] menu item. See page 38 and 39 for more information.

◆ Menu group items and functions

Memo

- You can only select items displayed with a **Advanced** in advanced mode.

<Image>

You can adjust the image when the unit is receiving an input signal.

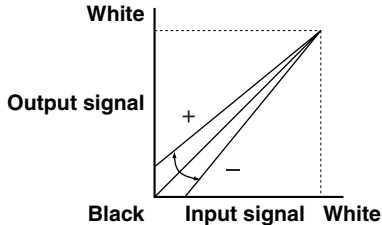
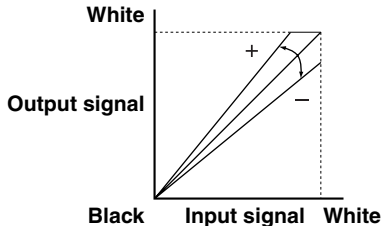
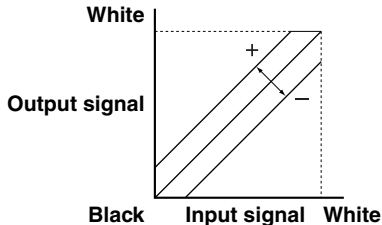
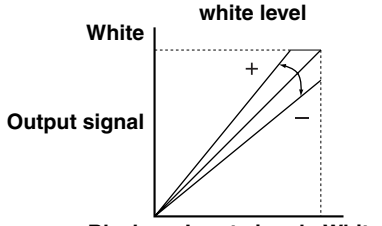
<p>Black Level (Input signal) Video/S-Video/Component/RGB TV</p>	<p>Adjusts the level of darkness (black level) in an image. Adjusts the level of darkness without altering the peak whiteness levels.</p> <ul style="list-style-type: none"> + side (0 to +100): Increases the luminance of dark scenes, increasing the clarity of shading, but reducing contrast. - side (-100 to 0): Weakens dark scenes, increasing image contrast while reducing the clarity of black shading. 
<p>White Level (Input signal) Video/S-Video/Component/RGB TV</p>	<p>Adjusts the bright areas (white level) in the image. Changes the brightness of an image without altering the brightness of the black areas of the image.</p> <ul style="list-style-type: none"> + side (0 to +100): Increases the brightness of white areas in the image, increasing contrast clarity, but rendering white shadings difficult to see. - side (-100 to 0): Reduces the contrast of images. 
<p>Brightness (Input signal) RGB PC</p>	<p>Adjusts the overall brightness of the image.</p> <ul style="list-style-type: none"> Increase luminance (0 to +100): Setting this figure too high results in a white saturated image without any black. Decrease luminance (-100 to 0) Setting this figure too low darkens the entire image. 
<p>Contrast (Input signal) RGB PC</p>	<p>Adjusts the bright areas (white level) in the image. Changes the brightness of an image without altering the brightness of the black areas of the image.</p> <ul style="list-style-type: none"> + side (1.00 to 1.50): Increases the brightness of white areas in the image, increasing contrast clarity, but rendering white shadings difficult to see. - side (0.50 to 1.00): Reduces the contrast of images. 
<p>Gamma (Input signal) Video/S-Video/Component/RGB TV/RGB PC</p>	<p>Changes the way the unit responds to changes in the shadings and color tones of the image. The unit supplies 10 types of patterns for dealing with these changes. (☞ page39)</p> <ul style="list-style-type: none"> A-E Provides the same sense of contrast as an ordinary TV monitor. Dark sections become more muted in the order A → E. a-e Provides richer expression of gradations in dark sections. Dark sections become more muted in the order a → e

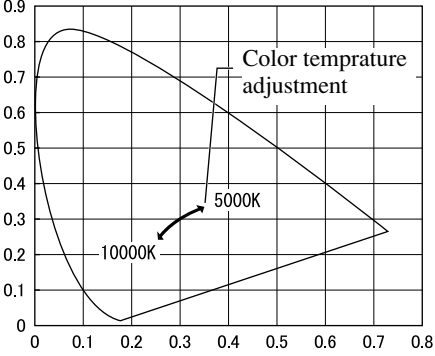
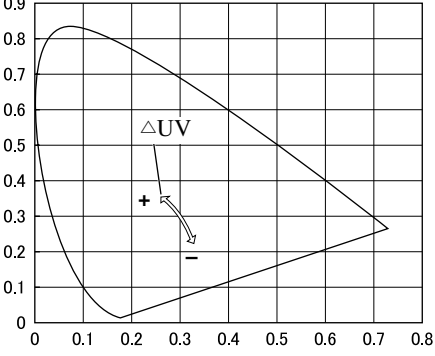
<p>Hue (Input signal) Video/S-Video/Component/RGB TV</p>	<p>Sets the hue or phase of the image.</p> <ul style="list-style-type: none"> • + side (0 to +100) : Shifts the hue towards blue coloration. • - side (-100 to 0) : Shifts the hue towards red coloration.
<p>Saturation (Input signal) Video/S-Video/Component/RGB TV</p>	<p>Adjusts the degree to which color depth is expressed in the image.</p> <ul style="list-style-type: none"> • + side (+100 to + 200) : The unit projects colors with greater depth. • - side (0 to +100) : The unit projects colors with less depth.
<p>Color Temp. (Input signal) Video/S-Video/Component/RGB TV/RGB PC</p> <p>Adjust in the [Color Adjustment] menu in advanced mode.</p>	<p>Adjust color temperature. Adjusts the level of white in colors between red and blue, and between green and magenta. Increase the color temperature to increase the amount of blue in an image, giving bright color tones. Reduce the color temperature to increase the amount of red, giving a darker, more relaxed atmosphere to the image. Choices: 5,000 to 10,000</p>  <p>The graph shows a color triangle on a grid with axes from 0 to 0.8. A vertical line labeled 'Color temperature adjustment' is positioned at approximately x=0.35. An arrow points from the top of this line to a point labeled '5000K' at approximately (0.35, 0.75). Another arrow points from the bottom of the line to a point labeled '10000K' at approximately (0.35, 0.25).</p>
<p>White Correction (Input signal) Video/S-Video/Component/RGB TV/RGB PC</p> <p>Adjust in the [Color Adjustment] menu in advanced mode.</p>	<p>Adjust ΔUV. Increasing the ΔUV setting increases the amount of green in the image. Decreasing this setting increases the amount of magenta. Choices: -0.02 to +0.02</p>  <p>The graph shows a color triangle on a grid with axes from 0 to 0.8. A vertical line labeled 'ΔUV' is positioned at approximately x=0.35. An arrow points from the top of the line to a '+' sign at approximately (0.35, 0.45). Another arrow points from the bottom of the line to a '-' sign at approximately (0.35, 0.25).</p>
<p>Sharpness Type (Input signal) Video/S-Video/Component/RGB TV</p>	<p>Changes the characteristics of the filter used to sharpen edges in the image. Choices: Off / L / ML / MH / H</p>
<p>Sharpness Gain Advanced (Input signal) Video/S-Video/Component/RGB TV</p>	<p>Adjusts the clearness of the image edges. Increase this figure to render a sharper image, and reduce it to give a softer image with less image noise. You cannot adjust this parameter if [Sharpness Type] is set to [Off]. Choices: 0 to 10</p>

Color Adjustment Advanced

(Input signal)
Video/S-Video/Component/
RGB TV/RGB PC

Adjust color balance.

There are three menus available, [Standard], [WRGB], and [WRGBYCM], separated in order of complexity from simple to detailed. Refer to page 36 for parameter operation methods. The present color temperature setting is displayed to the right of the menu items.

Color Adjustment Standard 6700K ±0.000uv ← The current color temperature is displayed.

Standard

You can adjust color temperature and ΔUV only. ΔUV adjusts values within the maximum color temperature limits of the projector.

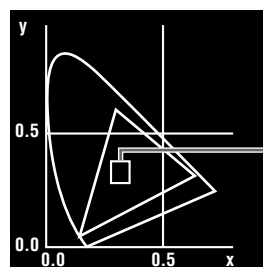

WRGB

Adjust the color coordinates and gain for the three primary colors, R(Red), G(Green), and B(Blue). The unit sets the complementary colors Y(Yellow), C(Cyan), and M(Magenta) automatically. Adjusting [Color Temp.] resets the RGB gain based on color coordinate settings. Adjusting [Gain] resets [Color temp.] based on color coordinate settings.

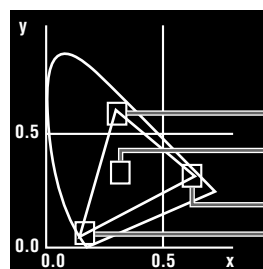

WRGBYCM

You can set the color coordinates and gain for each component color individually. Press the RESET button on the remote control when the WRGBYCM menu is open to automatically adjust the RGB gain and YCM color coordinates and gain based on the color temperature and RGB color settings. When you have selected WRGBYCM in the color adjustment submenu, press RESET to automatically adjust the RGB gain and YCM color balance to the most appropriate setting, based on color temp and RGB color balance settings.

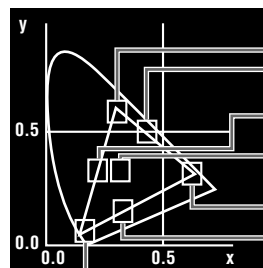

- Choices: White correction : -0.02 to +0.02
- Color temperature : 5,000 to 10,000
- Gain : 0.00 to 1.99

White Peaking

Enhances the radiance of the white portions of the projected image.

Choices: 0 to 5

Iris Advanced

(Input signal)
Video/S-Video/Component/RGB TV/RGB PC

Adjust the iris (Optical).

You can select 3 levels.

Close ← → Open



Level Adjustment Advanced

(Input signal)
Component/RGB TV/RGB PC

Adjust the analog input signal gain and offset settings.

Adjust the gain and offset for component and RGB (Y, C_B, C_R/R, G, B) input signals.

Choices: -50 to 0 to +50 (except for HDMI signals)

◆ Signal

You can adjust the image when the unit is receiving an input signal.

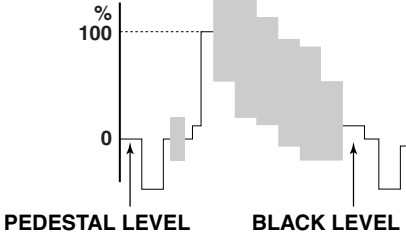
<p>Display Aspect Ratio</p> <p>(Input signal) Video/S-Video/Component/RGB TV/RGB PC</p>	<p>Set the aspect ratio you want to use for projecting an image from an input signal.</p> <p>See “Selecting a display aspect for projecting images”, page 17.</p>
<p>Overscan Advanced</p> <p>(Input signal) Video/S-Video/Component/RGB TV</p>	<p>Overscans video input sources for display.</p> <p>You can select from [Standard] and [Full]. This parameter is not available when you select [Smart Zoom] in [Display Aspect]. In some cases, noise may appear at the edges of the image when you select [Full].</p> <ul style="list-style-type: none"> • The overscan for [Standard] mode is approximately 94%. • The overscan for [Full] mode is approximately 100%.
<p>3D Y/C Separation Advanced</p> <p>(Input signal) Video(NTSC)</p>	<p>Adjusts the quality of images input from VIDEO jack.</p> <p>Suppresses the rainbow-like color and annoying dots in images. This function is only available for NTSC format signals the unit receives at its composite inputs.</p> <p>Choices: On/Off</p>
<p>Noise Reduction Advanced</p> <p>(Input signal) Video/S-Video/Component/RGB TV</p>	<p>Reduces noise in analog images.</p> <p>Digital processing eliminates noise in the luminance and color signals from sources with a comparatively large amount of noise, producing a more vivid image. Use when the quality of the source you are viewing requires it.</p> <p>Choices: Off/1/2/3</p>
<p>Video Type Advanced</p> <p>(Input signal) Video/S-Video</p>	<p>Select the correct type of device to ensure image synchronization.</p> <p>Select [VCR] when using an analog video tape as a video source. Select [DVD] for other sources.</p>
<p>Progressive Mode Advanced</p> <p>(Input signal) Video/S-Video/Component/RGB TV</p>	<p>Switches the interlace/progressive (I/P) conversion mode.</p> <p>Change from Interlace/Progressive (I/P) conversion mode to [Auto] or [Video] mode. (Only for SDTV interlaced signal).</p> <ul style="list-style-type: none"> • [Auto] : Detects the film source automatically and projects it progressively. • [Video]: Turns the detection function off.
<p>Color Space Conversion</p> <p>Advanced</p> <p>(Input signal) Video/S-Video/Component</p>	<p>Selects color space coefficients.</p> <ul style="list-style-type: none"> • [Auto] : Selects the best color space coefficient for the image resolution. • [SDTV] : Color space coefficient for BT.601 type signal. • [HDTV] : Color space coefficient for BT.709 type signal.
<p>Setup Level (SDTV)</p> <p>(Input signal) Video/S-Video/Component/RGB TV</p>	<p>Compensates for differences in the black levels of SDTV images.</p> <ul style="list-style-type: none"> • For signals equal to the pedestal level : Set to [0%]. • For signals with high levels of blackness : Set to [7.5%]. 

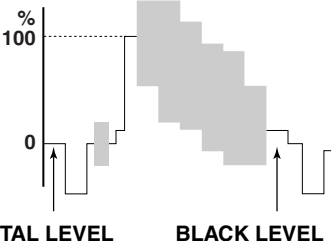
<p>Setup Level (HDTV) (Input signal) Component/RGB TV</p>	<p>Compensates for differences in the black levels of HDTV images. Choose [0%] in general.</p> <ul style="list-style-type: none"> • For signals equal to the pedestal level : Set to [0%]. • For signals with high levels of blackness : Set to [7.5%]. 
<p>Sync Adjustment Advanced (Input signal) RGB PC (except for HDMI signals)</p>	<p>Regulates flickering, noise, and disorder in the projected image. Choices: -128 to +127</p>
<p>Tracking Advanced (Input signal) RGB PC (except for HDMI signals)</p>	<p>Regulates vertical striping in the image. Choices: 0 to 31</p>
<p>Clamp Position Advanced (Input signal) Component/RGB TV</p>	<p>Adjust the clamp position for analog video sources. Choices: -30 to +30</p>
<p>Horiz. Display Position Advanced (Input signal) RGB PC (except for HDMI signals)/ Component/RGB TV</p>	<p>Adjust the horizontal display position of the projection image. Choices: PC type : -50 to 0 to +50 Video type : -10 to 0 to +10</p>
<p>Vert. Display Position Advanced (Input signal) RGB PC (except for HDMI signals)/ Component/RGB TV</p>	<p>Adjusts the vertical display position of the projection image. Choices: PC type : -50 to 0 to +50 Video type : -5 to 0 to +5</p>
<p>Signal Status</p>	<p>Displays the resolution of the image signal the unit is receiving. It also displays sync signal information for RGB type inputs.</p>

◆ Initial

Color System	<p>Selects the color system to use for video input signals.</p> <p>Usually, set this parameter to Auto to have the unit automatically detect the signal and select an appropriate color system. Set the unit manually to view NTSC4.43 images as it cannot detect NTSC4.43 automatically.</p> <p>Choices: Auto/NTSC/NTSC4.43/PAL/PAL-M/PAL-N/PAL60/SECAM</p>
INPUT A Signal	<p>Selects the type of input signal received at INPUT A.</p> <p>Choices: Component/RGB PC/RGB TV</p>
INPUT A Sync Type <small>Advanced</small>	<p>Selects the sync type for signals received at INPUT A.</p> <p>This function is only available for RGB TV.</p> <p>Choices: Auto/Separate Sync/Composite Sync/Sync on Green</p>
INPUT B Signal	<p>Selects the signal type received at INPUT B.</p> <p>Choices: Component/RGB PC/RGB TV</p>
INPUT B Sync Type <small>Advanced</small>	<p>Selects the sync type for signals received at INPUT B.</p> <p>This function is only available for RGB TV.</p> <p>Choices: Auto/Separate Sync/Composite Sync/Sync on Green</p>
HDMI Signal	<p>Selects the signal type received at the HDMI jack.</p> <p>Choices: Auto/Component/RGB TV</p>
Auto Power Off <small>Advanced</small>	<p>If the signal the unit is currently receiving stops and you do not perform any operations for 30 minutes or more, the unit automatically places itself in standby mode.</p> <p>Choices: On/Off</p>
Auto Input Search <small>Advanced</small>	<p>Automatically changes inputs when the unit does not receive a signal.</p> <p>If the signal the unit is currently receiving stops, or the input signal you selected the last time you used the unit does is not available when you turn the unit power on, it automatically searches through inputs for a signal in the following order.</p> <p>INPUT A → INPUT B → D4 VIDEO → S VIDEO → VIDEO → HDMI → INPUT A</p> <p>Choices: On/Off</p>
Display Language	<p>Selects the language the unit uses in the menu display.</p> <p>Choices: 日本語/English/Deutsch/Español/Français/Italiano/Portuguêsa/한국어/中文</p>
Lamp Running Time	<p>Displays the total lamp running time.</p> <p>Open the submenu to reset the running time. See page 38 for the operational procedure.</p>
Reset	<p>Reset menu parameters to their default setting.</p> <p>Reset all menu parameters to their default setting, and return the configurations stored in the memory to their defaults. See page 37, 44 and 45 for the operational procedure.</p> <ul style="list-style-type: none"> • [All Settings] : Return all settings in the [Initial] and [Setup] menu groups in the main menu, and all configurations stored by the memory function, to their factory default settings. • [All Memory] : Return all configurations stored by the memory function to their factory default settings. • [Current Memory] : Return the currently selected memory configuration to its factory default setting.

◆ Setup

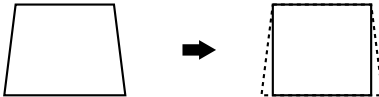
Location	Designate the location of the main unit. Choices: [Front/Table] [Front/Ceiling] [Rear/Table] [Rear/Ceiling] (☞ page 48)
Keystone Correction	<p>Adjusts the projection angle of the image.</p> <p>If you do not install the projector at right angles to the screen, the image will be trapezoidally distorted. You can electronically correct this distortion using the keystone function to adjust the width without changing the height of the image. Increase the keystone value (0 to 100) when the top of the image is overly wide, and reduce it (-100 to 0) when the lower part is overly wide.</p> <div style="display: flex; justify-content: space-around; align-items: center;"> <div style="text-align: center;"> <p>When the upper part of the image is wider than the lower</p>  <p>Increase the value in the positive (+) direction</p> </div> <div style="text-align: center;"> <p>When the lower part of the image is wider than the top</p>  <p>Decrease the value in the negative (-) direction</p> </div> </div>
Remote Control Sensor Advanced	<p>Set the remote control sensor.</p> <p>The main unit has two remote control sensors, one on the front panel and one on the rear, which this setting allows you to switch between. The remote control functions regardless of the setting of this parameter if you use a wired connection to connect it to the main unit.</p> <p>Choices: Front & Rear/Front/Rear/Off</p>
Remote Control ID Advanced	<p>Set the remote control ID.</p> <p>The main unit can receive commands from the remote control if you set the same ID in the main menu as the remote control code switch on the side of the remote control is set to. Use this remote control code switch to allow one remote control to control two main units independently.</p> <p>Choices: ID1/ID2</p>
Lens Adjustment Lock	<p>Lock the lens adjustment function.</p> <p>Locks the lens so that you cannot change the V.POS, ZOOM, and FOCUS settings accidentally when set to [ON]. Set to [OFF] to cancel this function.</p>
Lamp Power Advanced	<p>Lower the power supply to the lamp.</p> <p>You can adjust the power supplied to the lamp within the range of 80 to 100%.</p>
Menu Color	<p>Selects the color of the letters and background the main unit uses to display the menu on screen.</p> <p>You can choose to display the menu screen in [Monotone] or [Color]. Also, you can adjust the contrast and brightness of the menu from the [Menu Brightness] and [Menu Contrast] menus. You can select from 3 color types.</p> <div style="display: flex; justify-content: space-around; align-items: center;"> <div style="text-align: center;"> <p>Monotone</p> <ul style="list-style-type: none"> └ Menu Brightness └ Menu Contrast </div> <div style="text-align: center;"> <p>Color</p> <ul style="list-style-type: none"> └ Menu Brightness └ Menu Contrast └ Color Style </div> </div>
Menu Mode	<p>You can switch menu modes between an easy-to-use basic mode and a detailed advanced mode.</p> <p>Choices: Basic/Advanced</p>
Message Advanced	<p>Set whether to display memory number, input signal and other information on the projection screen. (☞ page 58)</p> <p>Choices: On/Off</p>
Trigger Out Advanced	<p>Sets the TRIGGER OUT terminal.</p> <p>Set the external control TRIGGER OUT jack 12 V signal emission to [Lamp] to synchronize it to the ON/OFF state of the lamp, to [Fan] to synchronize it to the fan, and to [RS-232C] to receive ON/OFF signals through the RS-232C terminal.</p> <p>Choices: Lamp/Fan/RS-232C</p>
Baud Rate Advanced	<p>Sets the transmission speed of the RS-232C terminal.</p> <p>This setting becomes valid from the next time you switch the unit on.</p> <p>Choices: 9600bps/19200bps/38400bps/57600bps/115200bps</p>

Menu Operations

◆ Operation Button Functions

Use the buttons on the remote control or the main unit to operate the menus. The button functions are listed below.

Remote Control

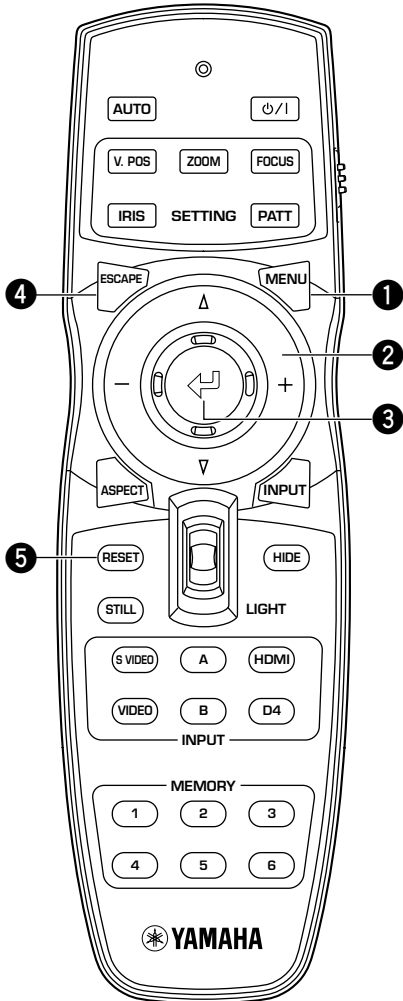

1 Menu Button

Open/Close the menu.

2 Cursor button

+ / - (Move the cursor right/left)

- Select menu groups.
- Open/Close submenus.
- Select/Change settings.

△ / ▽ (Move the cursor up/down)

- Select menu items.
- Select/Change settings.

3 ↵ button

- Confirm setting changes.
- Opens the in-line menu when the menu is not open.
- Selection of special menu item (☞ page 36) and memory operation. (☞ page 41)

4 ESCAPE button

- The cursor returns one level up the menu (e.g. From the menu item level to the menu group level).
- Closes submenus.
- Closes the menu screen when the cursor is in a menu group.
- After moving a menu, return from the menu movement bar to the menu entry screen.

5 RESET button (Remote control only)

Return parameters back to their default settings (Does not effect items with no default setting).

Main Unit

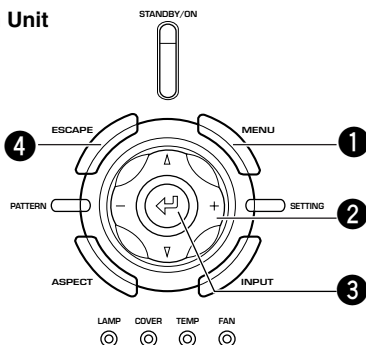

◆ Menu Operations 1 (with no submenu)

Menu operations with no submenu consist of the following 3 stages:

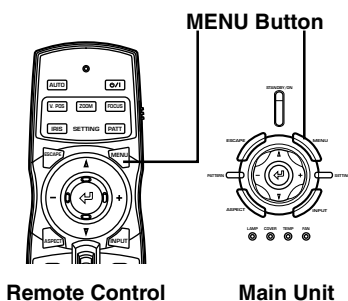
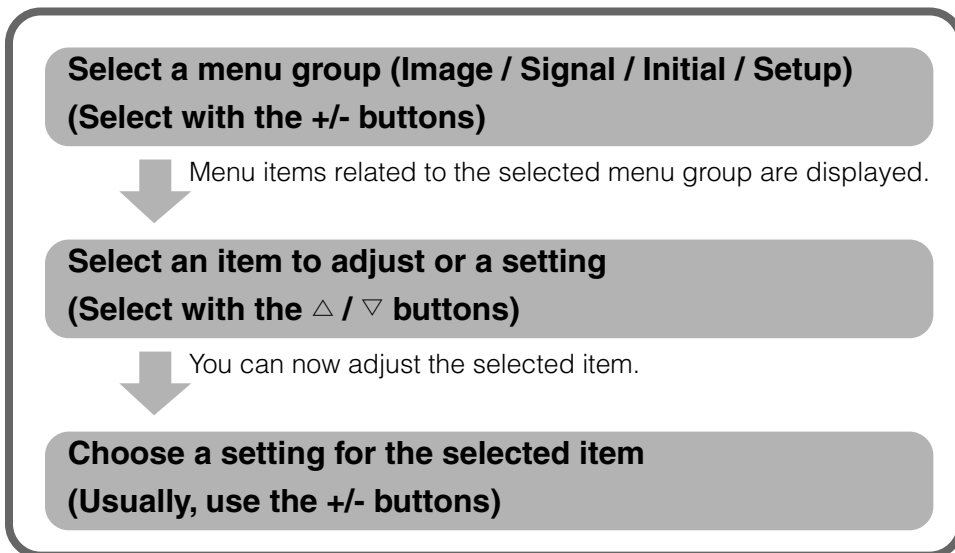

1. Open the menu screen.

Press the MENU button to open the menu screen.

Memo

- If you have opened the menu screen previously, the menu displays the settings from the last time you used it.

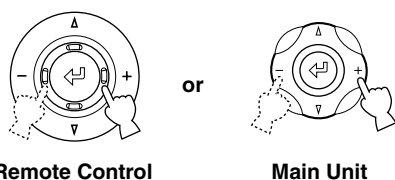
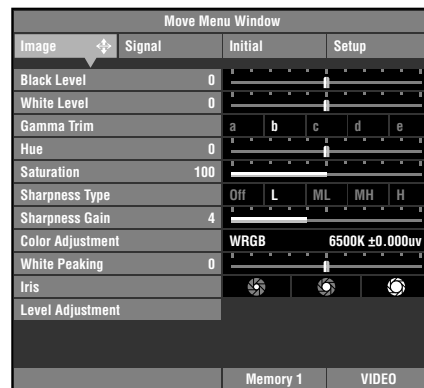

2. Select a menu group.

Use the +/- buttons to select a menu group. The illustration at right depicts the [Setup] group being selected.



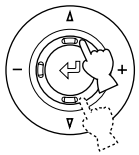

Remote Control

or

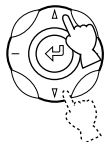

Main Unit

3. Select a menu item.

Use the Δ / ∇ buttons to move the cursor to the item you wish to adjust.

The illustration at right depicts [Lens Adjustment Lock] being selected.

Move Menu Window			
Image	Signal	Initial	Setup
Location		Front / Table	
Keystone Correction	0		
Remote Control Sensor		Front & Rear	
Remote Control ID		ID 1	
Lens Adjustment Lock	Off	On	
Lamp Power	105		
Menu Color		Color	
Menu Mode	Basic	Advance	
Message	Off	On	
Trigger Out		Lamp	
Baud Rate		115200bps	
		Memory 1	VIDEO

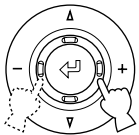

Remote Control

or

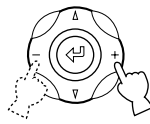

Main Unit

4. Choose a setting for the item.

Use the +/- buttons to select a suitable setting.

The illustration at right depicts the [Lens Adjustment Lock] mode set to on.

Memo

- The setting method depends on the item selected. In the example on the right, you need to press +/- buttons to change On/Off states of the menu item.

Move Menu Window			
Image	Signal	Initial	Setup
Location		Front / Table	
Keystone Correction	0		
Remote Control Sensor		Front & Rear	
Remote Control ID		ID 1	
Lens Adjustment Lock	Off	On	
Lamp Power	105		
Menu Color		Monotone	
Menu Mode	Basic	Advance	
Message	Off	On	
Trigger Out		Lamp	
Baud Rate		115200bps	
		Memory 1	VIDEO

5. Move to another item or group.

Memo

- To move to another item in the same group, use the Δ / ∇ buttons to move the cursor to another item.
To move to an item in another menu group, press ESCAPE or the Δ button to return to the top of the menu group, and repeat steps 2,3 and 4.

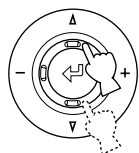

Remote Control

or

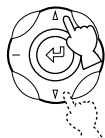

Main Unit

ESCAPE Button

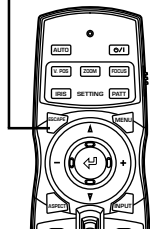

Remote Control

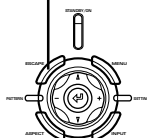

Main Unit

MENU Button



Remote Control

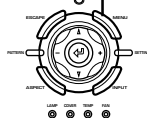

Main Unit

6. Close the menu screen.

When you have finished making adjustments, press the MENU button to close the menu screen.

◆ Menu Operations 2 (with submenus)

Follow the procedure below to use menu items that contain submenu items.

1. Select a menu item.

Carry out steps 1-3 of “Menu Operations 1” to select the item you want to set.

The illustration at right depicts [Display Language] in the [Initial] group selected.

Memo

- A ↗ appears to the right of items that contain a submenu.

Move Menu Window		
Image	Signal	Initial ↗ Setup
Color System		Auto
INPUT A Signal		Component
INPUT A Sync Type		Auto
INPUT B Signal		RGB TV
INPUT B Sync Type		Auto
HDMI Signal		Component
Auto Power Off	Off	On
Auto Input Search	Off	On
Display Language ↗		English
Lamp Running Time		0 Hour
Reset		
		Memory 1 VIDEO

2. Use the + buttons to move to the submenu.

Memo

- Some menu items contain other items that you can select. At this time, move to the lower level sub-menu using the + button.

Move Menu Window		
Image	Signal	Initial ↗ Setup
		日本語
		English
		Deutsch
		Español
		Français
Display Language		Italiano
		Portuguêsa
		한국어
		中文
		Memory 1 VIDEO

3. Use the cursor button to adjust item settings.

Memo

- You must press the ↵ button to confirm some settings.
↵ : Fix appears in the operations guide at the bottom left of the menu screen if this is necessary.

メニューの移動		
画質	信号	初期 ↗ 設置
		日本語
		English
		Deutsch
		Español
		Français
表示言語		Italiano
		Portuguêsa
		한국어
		中文
		メモリー1 VIDEO

4. Press the – or ESCAPE buttons to return to higher level menu items.

5. Close the menu screen.

Press the MENU button to close the menu screen when you have finished making adjustments.

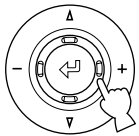

Remote Control

or

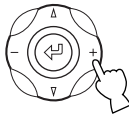

Main Unit

Items using the ↵ button for setting.

Display Aspect Ratio
Color System
Input A Signal
Input A Sync Type
Input B Signal
Input B Sync Type
HDMI Signal
Remote Control Sensor
Remote Control ID

◆ Special menu operations

Some items in the menu require special methods to configure.

<Color Adjustment>

1. Select [Color Adjustment] in the [Image] group from the main menu.
2. Press the + button to enter submenus.
3. Select a suitable item from [Standard] • [WRGB] • [WRGBYCM] using the Δ or ∇ buttons, and press the + button.

This explanation uses the [WRGBYCM] menu as an example.

4. Use the cursor buttons to select the item you wish to configure from the color scale and press the \leftarrow button.

Color coordinate adjustment area on the right side of the menu screen will be highlighted.

5. Using the cursor buttons to adjust a setting for the item.
6. Press the \leftarrow button to move to the gain adjustment area for R (red), G (green), B (blue), Y (yellow), C (cyan), and M (magenta).
7. Press the +/- buttons to adjust the gain.
8. Press the ESCAPE button to return to the color scale.

Example: Adjusting R (Red)

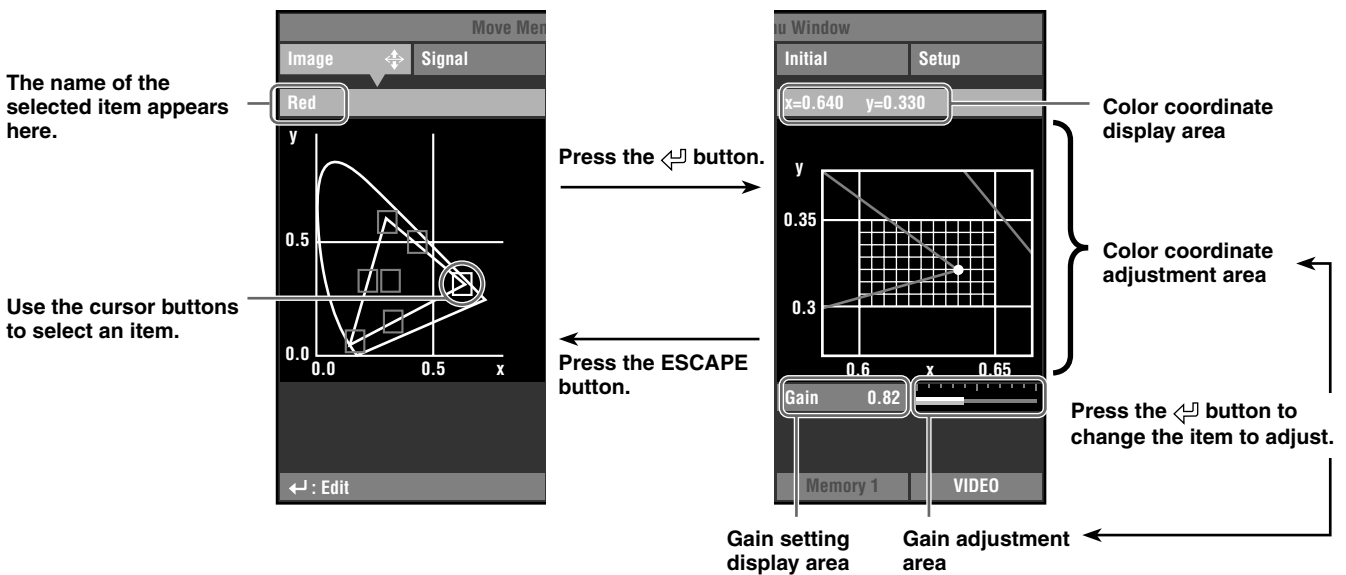

Memo

- See page 27 for details about each color item.

<To reset 1 parameter>

Reset parameters to the default settings.

1. From the main menu, select the item you wish to reset to the default setting.
2. Press the RESET button on the remote control to reset to the default settings (does not affect items with no default setting).

Memo

- The RESET button has special function while you select [WRGBYCM] in [Color Adjustment]. (ESC page 27)

<To reset all parameters>

Return all settings to their default state.

1. From the menu screen, select [Initial] → [Reset] → [All Settings].

2. Press the + button to display a confirmation message.
3. Press the ↵ button to reset to the default settings.

Memo

- Press the ESCAPE button to cancel this operation and return to the previous screen.

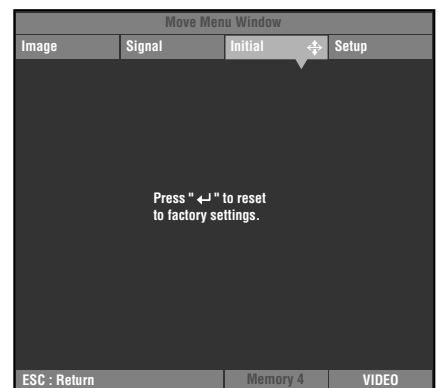
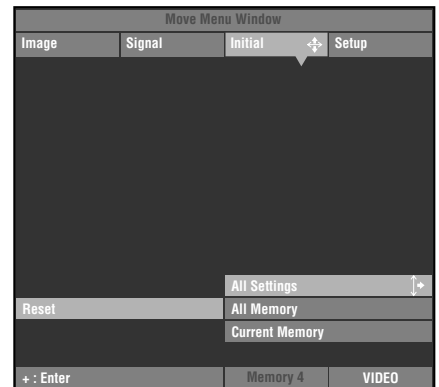

<Changing the position of the menu screen.>

Change the position of the menu on the projection screen.

1. With the menu screen open, press the ESCAPE or △ button and move the cursor to one of the menu groups.
2. Press the △ button to enter [Move Menu Window].
3. Use the cursor buttons to move the menu screen to a location of your choice.
4. Press the ESCAPE button to return to the previous menu screen.

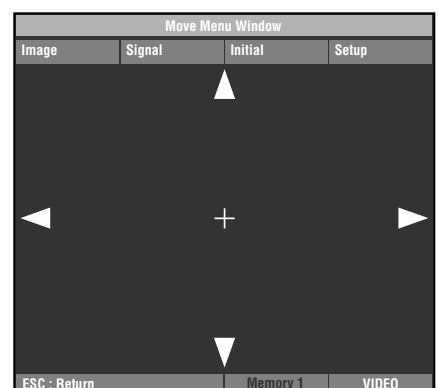

<Resetting the lamp running time.>

Reset the [Lamp Running Time] displayed on screen to “0”.

1. From the menu screen select [Initial] → [Lamp Running Time].

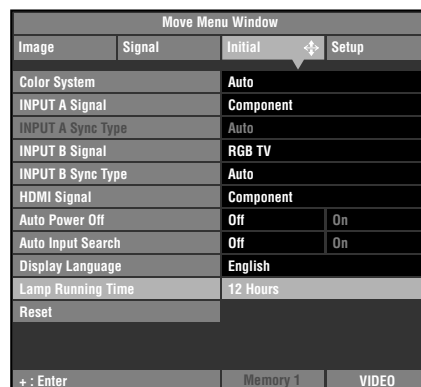

2. Press the + buttons to open the confirmation screen.
3. Use the △ or ▽ buttons to select [Yes].
4. Press the ↵ button to confirm.

Memo

- Select [No] to cancel the operation and return to the menu screen.

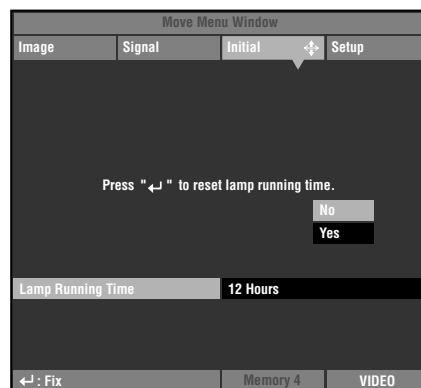

<Subtitle Zoom>

Use the [Subtitle Area] menu to adjust the size of the subtitle display area. Use [V Scroll] to adjust the vertical position of the subtitle display.

1. From the menu screen select [Signal] → [Display Aspect Ratio] → [Special].
2. Press the + button to enter lower level menu items.
3. Select [Subtitle Zoom] with △ or ▽ buttons.

4. Press the ↵ button.

A ↕ appears to the right of [Subtitle zoom].

Memo

- After the first time you carry out this procedure, a ↕ appears beside [Subtitle Zoom] automatically.



5. Press the + button to enter lower level selection menus.
6. Use Δ or ∇ buttons to select [Subtitle Area] or [V Scroll].
7. Use the + or – buttons to select a suitable setting.

Memo

- Press Δ or ∇ buttons to move to a different menu item within the [Subtitle Zoom] menu.
8. Press the ESCAPE button to return to a higher level menu.

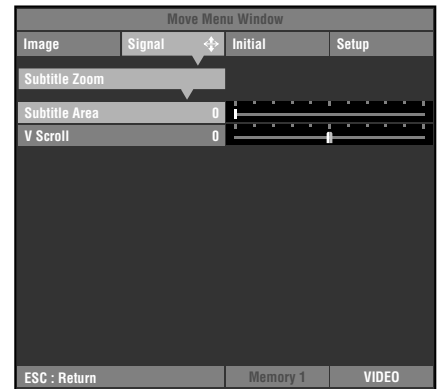

<Changing the [Gamma] page>

Press the \leftarrow button to cycle between the 2 menu pages containing the 5 menu items per page, total of 10 items. (page 25)

1. From the menu screen, select [Image] \rightarrow [Gamma].
2. Press the \leftarrow button to switch between capital (A to E) and non capital (a to e) letters.
3. Use the + or – buttons to select an appropriate setting.

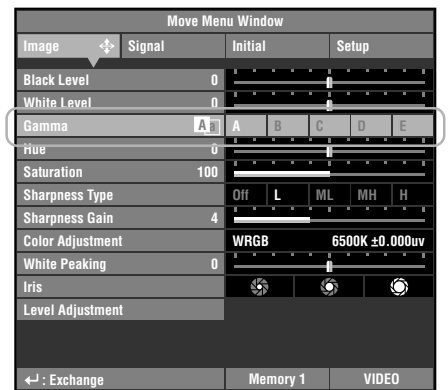

Press the \leftarrow button

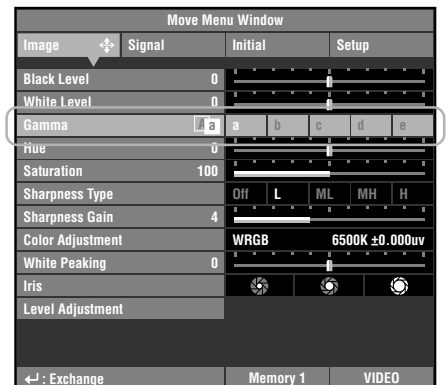

◆ Adjusting image quality using the inline menu

You can use the inline menu to adjust image quality without obstructing the image during projection. See “Menu group items and functions” (pages 25-31) for information on each setting.

<Inline menu composition>

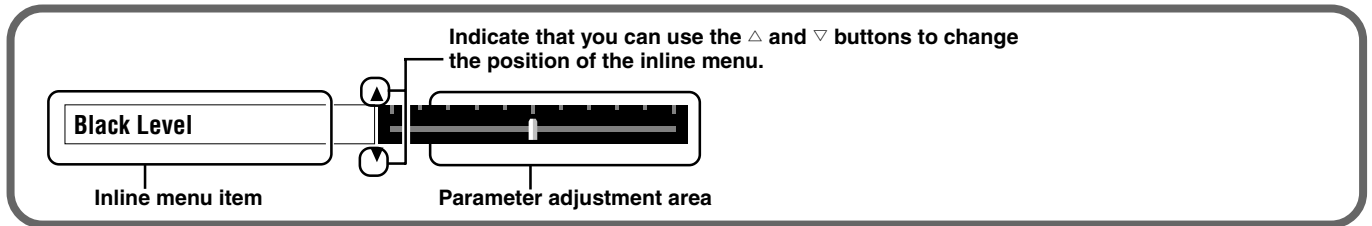

<Inline menu item list>

The menu items you can choose may differ depending on the input signal type.

For video type sources		For PC type sources
Black Level	Sharpness Type	Brightness
White Level	Sharpness Gain	Contrast
Gamma	White Peaking	Gamma
Hue	Iris	Color Temp.
Saturation		White Correction
Color Temp.		White Peaking
White Correction		Iris

Memo

- When [Sharpness Type] is set to [Off], the [Sharpness Gain] adjustment cannot be performed.

<Example: Using the inline menu>

1. Press the \leftarrow button when the menu is not open.

Image menu items appear one at a time in the lower area of the screen. If you do not carry out any operations within 5 seconds, the menu display disappears.

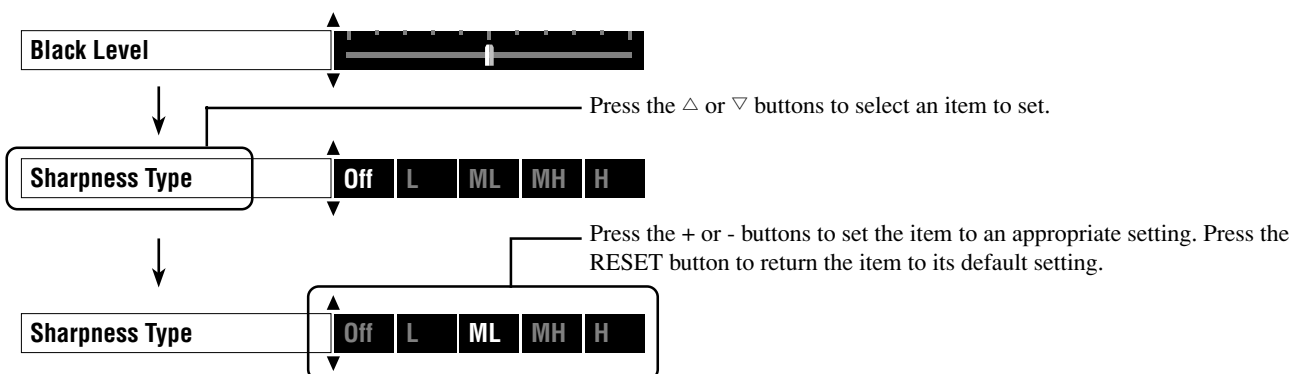

2. When you have finished making adjustments, press the ESCAPE button to close the menu display.

Memo

- Press the \leftarrow button to change between the pages of the [Gamma] menu.

8 Memory function (Saving, recalling, locking, and resetting memory.)

This projector has a memory function for automatically saving settings of menu items in the "Menu Items to be set by memory function" (see Table below).

◆ Memory configurations

This unit is provided with up to 6 memories for each input terminal. In addition, because multiple storage is automatically made to correspond with the type of input signal for each memory number, a maximum of 72 track settings is possible.

Memory configurations for each input jack/connector

Input	Input Signal Type	Memory number that you can use
VIDEO	—	1 to 6
S VIDEO	—	1 to 6
INPUT A	SDTV	1 to 6
	HDTV	1 to 6
	RGB-PC	1 to 6
INPUT B	SDTV	1 to 6
	HDTV	1 to 6
	RGB-PC	1 to 6
HDMI	SDTV	1 to 6
	HDTV	1 to 6
D4	SDTV	1 to 6
	HDTV	1 to 6
Total		up to 72

Menu items to be set by memory function

Image	Signal
Black Level (Brightness)	3D Y/C Separation
White Level (Contrast)	Noise Reduction
Gamma	Video Type
Hue	Progressive Mode
Saturation	Color Space Conversion
Color Temp.	Setup Level
White Correction	Signal Level
Sharpness Type	
Sharpness Gain	
Color Adjustment	
White Peaking	
Iris	
Level Adjustment	

◆ Saving memory settings

Memory numbers 1 – 6 store the various initial settings. The unit saves any changes to menu item settings to the current memory number, so you do not need save the settings yourself. To preserve your current settings, change the memory number you are using without making any further changes, or use the "Memory lock" function to keep the settings as they are (See page 43).

◆ Recalling a memory number

<Using the remote control>

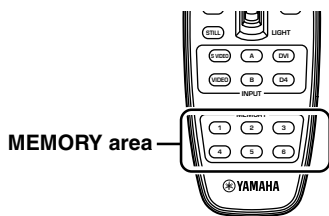

Remote Control

1. Press the MEMORY button with the desired memory number (1-6).

<Using the menu>

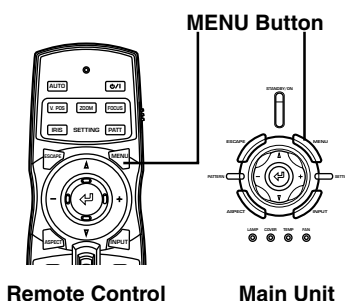

Remote Control

Main Unit

1. Select [Image] or [Signal] group from the menu screen.

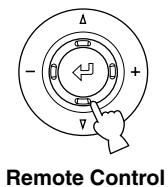

Remote Control

or

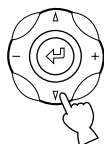

Main Unit

2. Press the ∇ button to select "Memory number status" from the bottom of the screen.

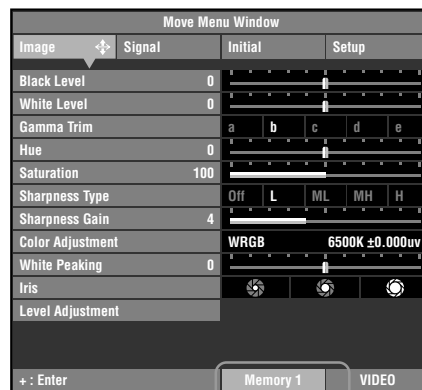

Memory number status

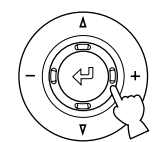

Remote Control

or

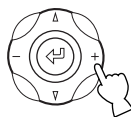

Main Unit

3. Press the + button to open the submenu.

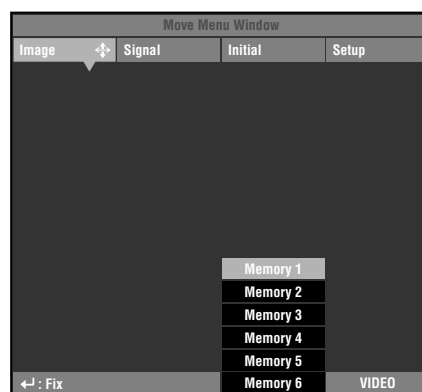

4. Press the Δ or ∇ buttons to select a memory setting number.

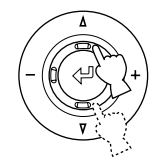

Remote Control

or

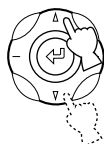

Main Unit

5. Press the \leftarrow button to call the memory number you selected.

Memo

- When the unit receives a signal with a different resolution from the same input jack, it automatically detects the new resolution and calls an appropriate memory setting.

◆ Memory lock

The unit has a lock function you can set so that it does not accidentally overwrite information stored in its memory. You can set the lock function for each memory number, and additionally for each SDTV/HDTV/RGB-PC input.

<Setting Memory Lock>

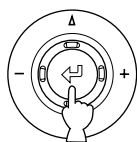

Remote Control

or



Main Unit

1. Call the memory number you wish to lock.
2. Choose the memory number status.
3. Press the button.

A mark appears beside locked memory numbers.

Memo

- To lock memory other than that with the currently selected memory number, call up memory according to the procedure in "Recalling a memory number". (page 41-42)

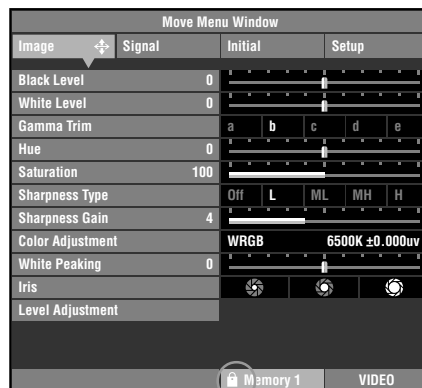

The appears.

<Resetting Memory Lock>

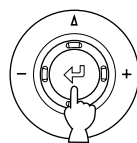

Remote Control

or



Main Unit

1. Call the memory number you wish to unlock.
2. Choose the memory number status.
3. Press the button.

The disappears from the memory status screen and the memory lock is removed from the memory number you selected.

Memo

- To unlock memory other than that with the currently selected memory number, call it up according to the procedure in "Recalling a memory number". (page 41-42)

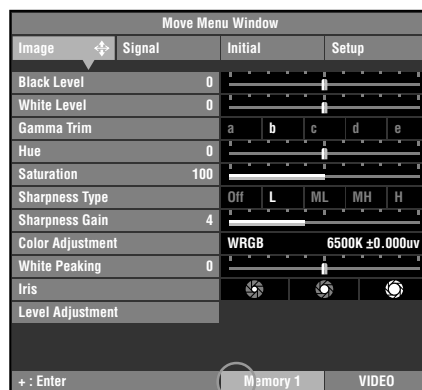

The disappears.

Memo

- You can change settings when the memory is locked, but the unit does not save the changes to memory. Any changes you make are erased when you turn the unit power off. The memory number status color changes from white to grey if you change any menu items when the memory is locked.

◆ Resetting to the default settings

Reset stored memory to default settings.

<Initialization of currently selected memory>

This returns memory (corresponding to the signal input from the currently selected input terminal) to its initial setting.

1. From the main menu, select [Initial] → [Reset] → [Current Memory].

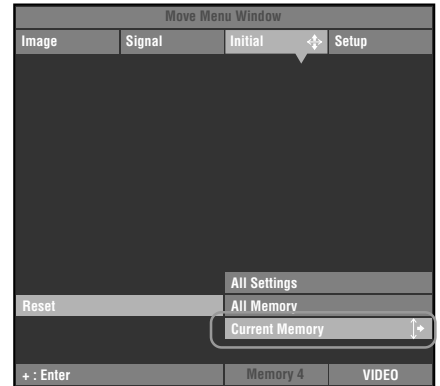

2. Press the + button to display a confirmation screen.

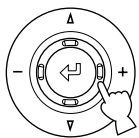
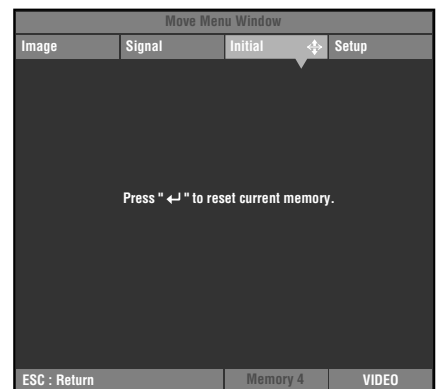

Remote Control

or

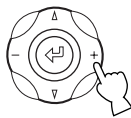

Main Unit

3. Press the ↵ button to return the parameters to their default settings.

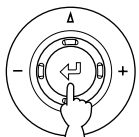

Remote Control

or



Main Unit

<To reset all parameters for all memory numbers>

Return the all memory contents to the default settings regardless of the input jack or input signal.

1. From the main menu, select [Initial] → [Reset] → [All memory].



2. Press the + button to display a confirmation screen.

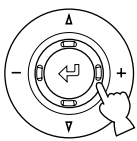
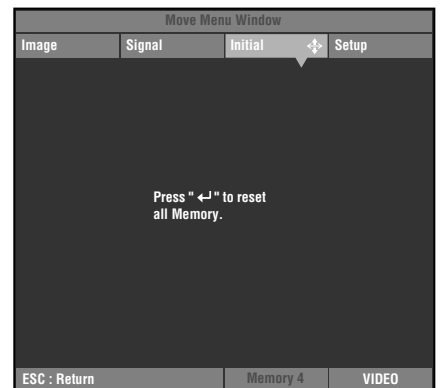

Remote Control

or

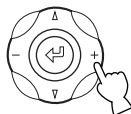

Main Unit

3. Press the ↵ button to return the parameters to their default settings.

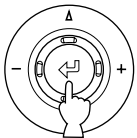

Remote Control

or

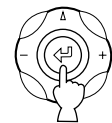

Main Unit

9 Connection

Connecting to image source components

This unit is equipped with 6 types of video input jacks for AV components. Follow the diagram to connect AV components to this unit, taking care to use cables and adapters that match the input jacks.

Input	Signal type	Connector type
VIDEO	Composite video	Pin jack
S VIDEO	S-Video	Mini DIN connector
INPUT A	Component video/RGB video	BNC connector x 3-5
INPUT B	Component video/RGB video	D-sub 15 pin
D4 VIDEO	Component video	D connector
HDMI	Component video/RGB video (digital)	HDMI connector

Warning

- Be sure to turn off the power of this unit and the source component before attempting connection.
- Connection methods and jack names may differ depending on the component you are attempting to connect. Refer to the owner's manual for the component.
- Insert all plugs firmly to avoid noise or other problems.

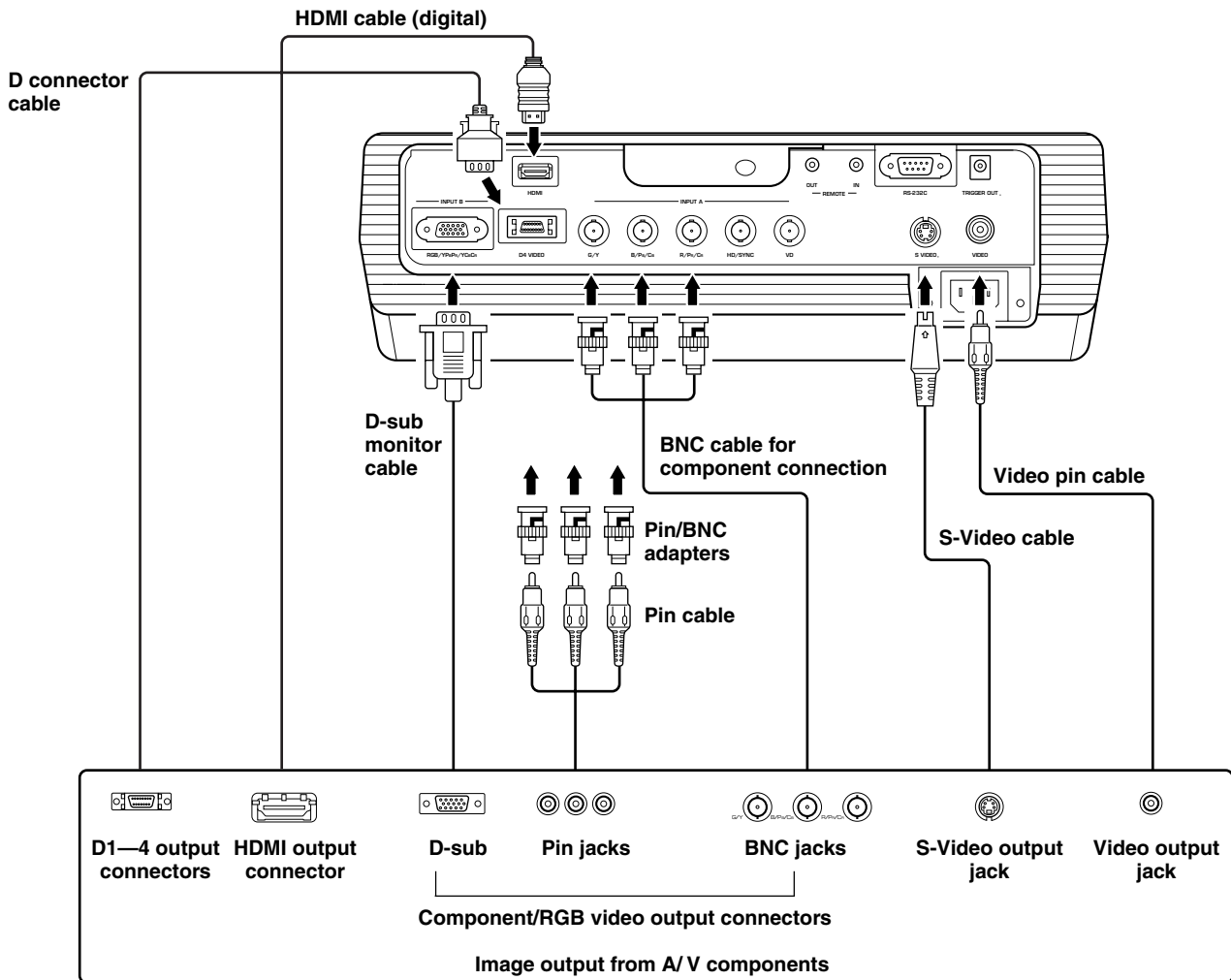

Memo

- Be sure to connect Y/Pb/Pr and Y/Cb/Cr to the jacks with the correct signals when connecting AV components to INPUT A. Refer to the owner's manual of the source component for more information. You may need to make connections to HD/SYNC and VD for RGB video signals.

Connecting to computer devices

You can use the following two methods to connect to computer devices. Be sure to use cables with jacks that match the connectors and jacks you wish to use.

Input	Signal type	Connector type
INPUT A	RGB (Analog)	BNC jack x 5
INPUT B	RGB (Analog)	D-sub 15 pin

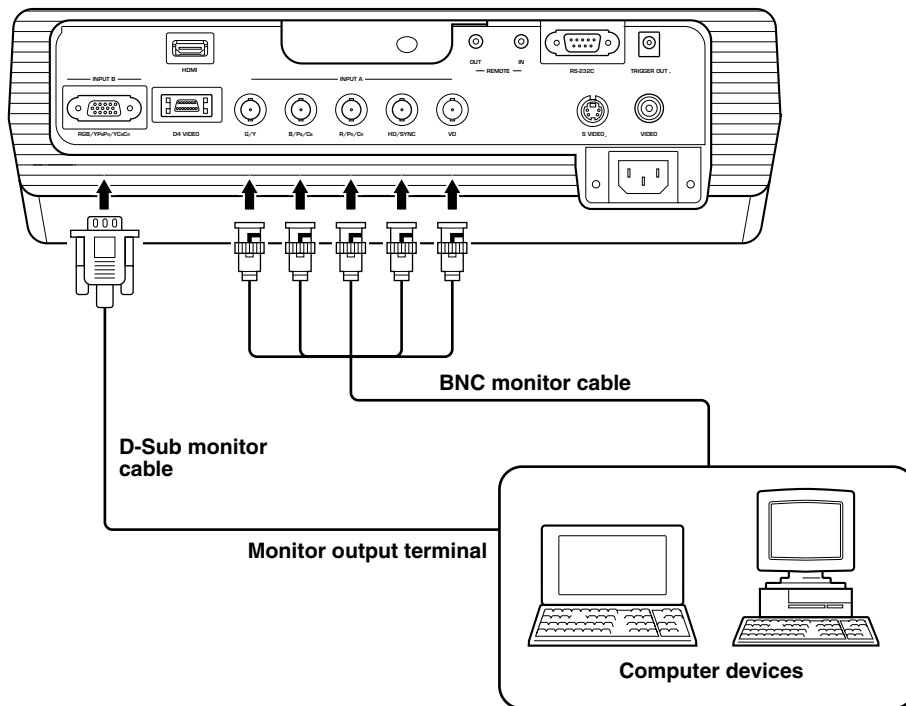

10 Setting up the projector and screen

Setting up the projector

There are four ways of mounting the projector.

Mounting method	Projection method
Placed on a table	A: From in front of the screen
	B: From behind a semi-translucent screen
Mounted on the ceiling	C: From in front of the screen
	D: From behind a semi-translucent screen

◆ Mounting the projector on a table

A: From in front of the screen

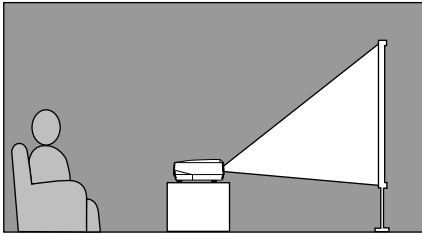

Place the unit on a table to project and view the image from in front of the screen. Usually, place the unit on a reasonably high table. The height from the bottom of the unit to the center of the lens is 12.4cm (4"-7/8).

B: From behind a screen (using a semi-translucent screen)

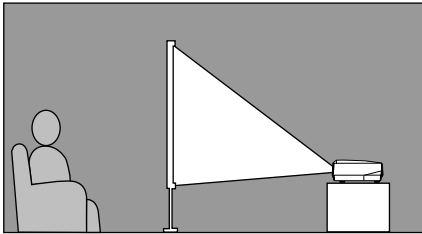

Place the unit on a table to project and view the image from behind a semi-translucent screen. The distance between the projector and the screen should be the same as "A: From in front of the screen".

- Set the [Location] menu item in the [Setup] menu group to [Rear/Table]. (☞ page 22 - 40)

◆ Mounting the projector on the ceiling

There are two kinds of brackets (low ceiling and high ceiling, sold separately), which you can use to mount the projector on the ceiling. Please consult your dealer for details on their use, and have installation done by either your dealer or a reputable contractor.

C: From in front of the screen

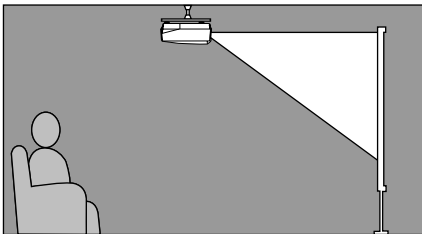

Mount the unit on the ceiling to project and view the image from in front of the screen. The distance between the projector and the screen should be the same as "A: From in front of the screen".

- Set the [Location] menu item in the [Setup] menu group to [Front/Ceiling]. (☞ page 22 - 40)

D: From behind a semi-translucent screen

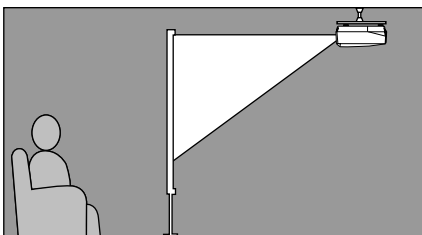

Mount the unit on the ceiling to project and view the image from behind a semi-translucent screen. The distance between the projector and the screen should be the same as "B: From behind a screen".

- Set the [Location] menu item in the [Setup] menu group to [Rear/Ceiling]. (☞ page 22 - 40)

Projection distance and the screen

The most suitable distance between the screen and the projector (see Projection distance [a]) depends on the size of the screen (diagonal length) you use. You can use the zoom function to adjust the projection distance within a preset range from Wide to Tele. You can also alter the V.POS parameter to adjust the vertical position of the image to better suit the screen. Use the information in the table below to determine the best location to place the projector in to suit your screen size.

<When using a 16:9 screen>

Screen size (inch)	Projection distance [a] Wide (m) – Tele (m)
60	1.78 – 2.88
70	2.08 – 3.37
80	2.39 – 3.86
90	2.70 – 4.35
100	3.00 – 4.84
110	3.31 – 5.33
120	3.62 – 5.82
150	4.54 – 7.29
200	6.07 – 9.74

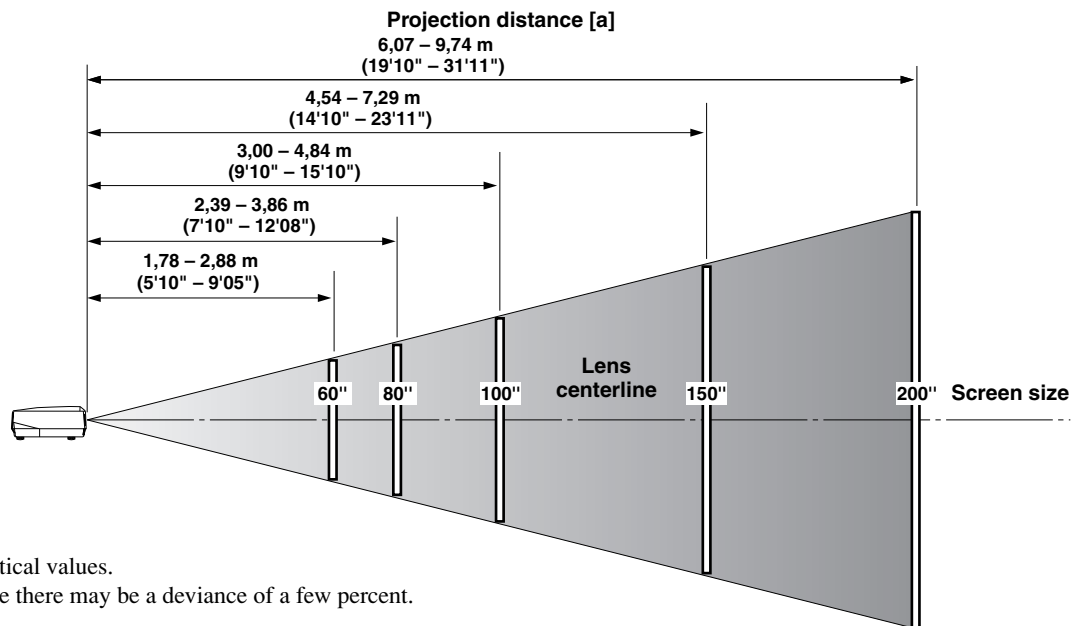

* These are theoretical values.
During actual use there may be a deviance of a few percent.

<When using a 4:3 screen>

Since the DPX-1100 has a 16:9 panel, the ideal installation location for use with a 4:3 screen depends on the size of the image you wish to view.

Screen size (inch)	Projection distance[a]	
	16:9 image (*1) Wide (m) – Tele (m)	4:3 image (*2) Wide (m) – Tele (m)
60	1.63 – 2.64	2.17 – 3.52
80	2.19 – 3.54	2.93 – 4.72
100	2.76 – 4.44	3.68 – 5.92
120	3.32 – 5.34	4.43 – 7.12
200	5.58 – 8.94	7.43 – 11.92
	(*)3	

(*1) Projects a 16:9 image that completely fills the screen (leaves a black line at the top and bottom of the screen).

(*2) Projects a 4:3 image that completely fills the screen.

(*3) When projecting both 16:9 and 4:3 images.

You can use the zoom function to make efficient use of the screen for both *1 and *2 above. The projection distance in this case is between Wide in *2 and Tele in *1. Use the zoom to adjust the size of the projection images so that they fill the screen completely. Note that adjustments to V.POS may cause the position of the image to change.

Projection image position

Follow the instructions to adjust the position of the projected image on screen.

<Using ZOOM to adjust image position>

This illustration shows the limits within which the zoom function can alter projection distance [a] in relation to screen size. You can adjust the image within these limits so that it fills the screen completely. (☞ page 21)

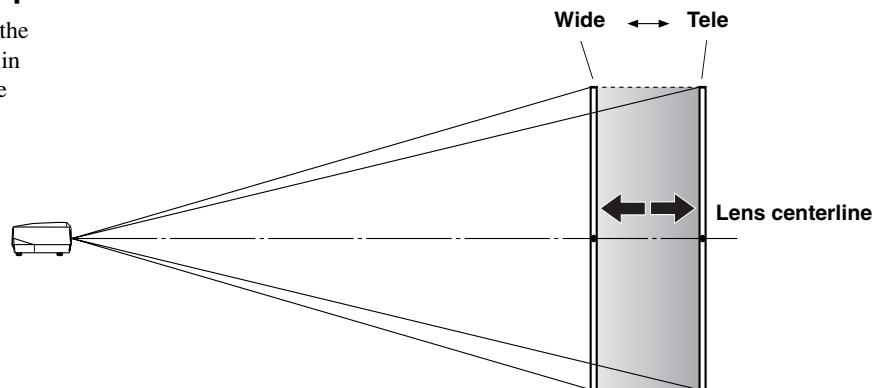

<Using V.POS (vertical position) to adjust image position>

You can adjust the vertical position of the projection image up or down by half of the height of the screen. For example, shifting V.POS fully up brings the lower limit of the image above the centerline of the lens. (☞ page 20)

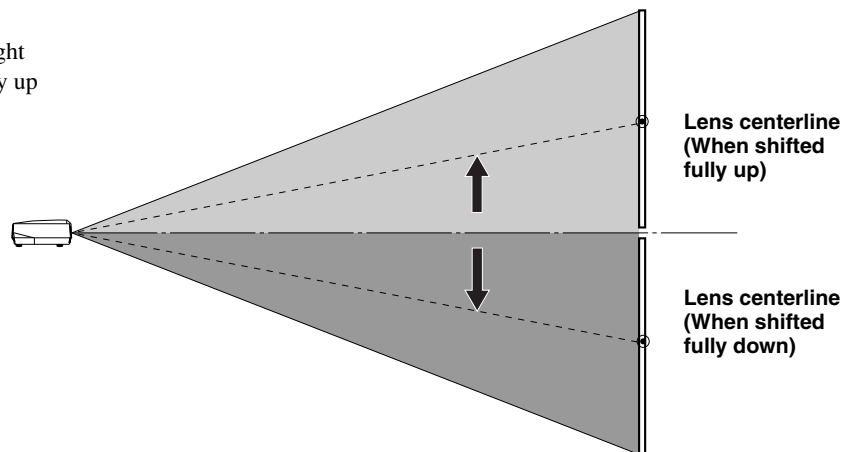

<Using the adjusters to adjust image position>

If you mount this unit on a tabletop, you can use the adjusters on its underside to change the position of the projection image. Rotate the movable part of the two screw-type adjusters at the front bottom of the case to adjust the height. The movement range of the adjusters is 3cm (1-1/4 inch). Adjust with care as loosening them further than 3cm may cause them to separate from the unit.

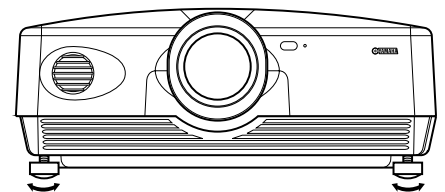

◆ Keystone adjustment

If you mount the unit at an angle to the screen, it projects trapezoidally distorted images. You can use the [keystone Correction] item in the [Setup] menu group to rectify this. (☞ page 22-34)

Memo

- If the keystone is adjusted aspect ratio may not be correctly maintained. To correctly maintain the aspect ratio, try to use the lens shift as much as possible in a center position.
- The video may be disturbed by keystone correction. Wherever possible, we recommend setting up so the screen and projector form a right angle.

Glossary

The following is a list of key words used in the use of projectors and image signals and their explanations. Please refer to it when using this manual.

For an explanation of vocabulary used in the menu, refer to "Menu group items and functions" (☞ page 25).

Ceiling mount bracket

The mounting hardware used to hang this unit from the ceiling.

Two types of bracket are available, for high and low ceilings.

Ceiling mount brackets are sold separately.

Cinemascope size

The widest film format in 70mm film, with an aspect of 2.35:1.

Color spacing

The conversion of YUV color separated signal to RGB signal.

There are two formats for this, BT.601 for SDTV, and BT.709 for HDTV. This unit switches between them as required.

Component video signal

A method of sending video signals with independent luminance and color signals. Component video gives a higher image quality than ordinary composite video because it bypasses mixing and separating circuits. Component video signal consists of three lines, the luminance signal (Y), and two color difference signals (P_B/C_B, P_R/C_R).

Composite video signal

The most common type of video signal, combining luminance and color signals in one line. This method requires mixing and separating processes on both the send and receive sides. Use a pin cable for connection.

DCDi™ function

Directional Correlational Deinterlacing, a high quality image circuitry developed by the Faroudja company. DCDi uses edge cutting techniques to remove jagged edges from images during Interlace to Progressive conversion, allowing smooth, natural reproduction of images.

DLP™ technology

Digital Light Processing, an image display engine used in projectors that use the DMD™ chip developed by Texas Instruments.

D terminal

A cable that allows transmission of all of the signals in composite video in one cable. This method is used for transmitting image signals between the latest AV components. There are 5 methods of transmission, D1-D5. This unit is compatible with D4.

HDCP

A technique designed to protect the video transmission between a DVI or HDMI transmitter and a display device.

HDMI™

High-Definition Multimedia Interface, a method of differentially transmitting digital RGB/component video signal from computers and home digital equipment.

HDTV

High-Definition Television, a term used to define systems that satisfy the following conditions:

- A vertical resolution of 720p or 1080i (p stands for progressive scans, ; stands for interlace scans)
- A 16:9 aspect ratio

Interlace

The most common type of scanning used in televisions. It divides a screen into even and odd numbered fields for scanning, and then builds an image by combining them into one image (frame).

Keystone Correction

Using the unit at an angle to the screen distorts the projected image trapezoidally. You can use Keystone Correction to electronically correct this distortion.

Letterbox

A method of converting the content of landscape oriented film to a 4:3 signal. You can watch landscape images without trimming them by adding a black bar to the top and bottom of the screen, however this sacrifices vertical resolution to some extent.

Progressive

This method displays all scanning lines in a frame at once, reducing flicker noticeable on a larger screen and creating a sharp, smooth image. This unit uses progressive scanning for progression.

RGB Signal

A method of transmitting color information using a numeric representation of the primary colors red, green, and blue separately. When received, it is expressed in various colors by adding a mixing colors. RGB is widely used for sending and receiving color images between computers, and requires horizontal and vertical sync signals.

SDTV

Standard Definition Television, a term used to define normal television broadcasts which do not meet HDTV standards.

Smart zoom

Expands the left and right sides of a 4:3 image without altering the center, when you are attempting to project a 4:3 image on a wide screen format. This creates some distortion at both edges.

Squeeze

A method of compressing film images horizontally to an aspect of ratio of 4:3 when recording to video medium. The raw image is oblong, so needs to be passed through a desqueezing circuit to be projected in it's original form.

Standby

The state in which the circuit that receives infrared-signals from the remote control is active, but all other main circuits are turned on. The unit consumes a small amount of power in this state.

S Video signal

S stands for Separate. A method of sending signals with separate luminance (Y) and color (C) signals. Use a 4-pin mini DIN connector and cable for connection.

Sync.

Computers output signals with a given regular frequency, which you must synchronize the projector to in order to produce a good quality image. If you do not match the phase of the signal, the image may be flickery, faded, or distorted.

Test pattern

This unit contains test patterns which you can use to adjust the position and focus of the projected image on the screen.

Tracking

Computers output signals with a given regular frequency, which you must synchronize the projector to in order to produce a good quality image. If you do not match the phase of the signal, vertical stripes may appear on the image.

Vista size

A standard film size, with an aspect ratio of 1.85:1 in North America, and 1.66:1 in Europe.

3-2 pulldown detection style IP conversion

A function for directly converting interlace signal into sixty frame progressive signal used when receiving 60 field interlace signal from an image source recorded with the same 24 frames as movie film. This allows DVD and other materiel recorded with 24 frames to be projected on large screens as a natural, precise image with no loss of quality, comparable to a movie film.

* DLP™ and DMD™ are registered trademarks of the Texas Instruments corporation of America.



* “DCDi” is a trademark of Faroudja, a division of Genesis Microchip, Inc.



* HDMI, the HDMI logo and High-Definition Multimedia Interface are trademarks or registered trademark of HDMI Licensing LLC.

Signals the DPX-1100 can project

The following tables show the types and formats of signals the DPX-1100 can project. Signals other than those listed here may not be projected correctly.

◆ TV format 1 (Composite or S Video signals received at the VIDEO or S-VIDEO jacks)

Signal type	V active (lines)	f (V) (Hz)	fsc (MHz)	Color system
NTSC	480	59.94	3.58	NTSC
PAL	576	50.00	4.43	PAL
SECAM	576	50.00	4.406, 4.25	SECAM
PAL60	480	59.94	4.43	PAL
NTSC4.43	576	59.94	4.43	NTSC
PAL-M	480	59.94	3.58	PAL
PAL-N	576	50.00	3.58	PAL

◆ TV Format 2 (Component/RGB TV signals received at the INPUT A and B, or component signals received at the D4 jacks)

Signal type	H active (pixels)	V active (lines)	f (H) (kHz)	f (V) (Hz)
480i	720	483	15.734	59.940
576i	720	576	15.625	50.000
480p	720	480	31.469	59.940
576p	720	576	31.250	50.000
720p/50Hz	1280	720	37.500	50.000
720p/60Hz	1280	720	44.955	59.940
1035i	1920	1035	33.750	60.000
1080i/50Hz	1920	1080	28.125	50.000
1080i/60Hz	1920	1080	33.716	59.940

◆ PC Format (Analog RGB PC signals received at the INPUT A or B jacks)

Signal type	H active (pixels)	V active (lines)	f (H) (kHz)	f (V) (Hz)	
VESA (*1)	VGA/60Hz	640	480	31.469	59.940
	VGA/72Hz	640	480	37.861	72.809
	VGA/75Hz	640	480	37.500	75.000
	VGA/85Hz	640	480	43.269	85.008
	SVGA/56Hz	800	600	35.156	56.250
	SVGA/60Hz	800	600	37.879	60.317
	SVGA/72Hz	800	600	48.077	72.188
	SVGA/75Hz	800	600	46.875	75.000
	SVGA/85Hz	800	600	53.674	85.061
	XGA/60Hz	1024	768	48.363	60.004
Macintosh (*2)	640	480	35.000	66.666	

(*1) VESA is a registered trademark of the Video Electronics Standards Association.

(*2) Macintosh is a registered trademark of the Apple Computer corporation.

◆ HDMI Format (Component/RGB signals input from the HDMI jack)

Signal type	H active (pixels)	V active (lines)	f (H) (kHz)	f (V) (Hz)	Component type
VGA	640	480	31.469	59.94	RGB (*3)
480i	(1440) 720	480	15.734	59.94	RGB/YCbCr4:4:4/YCbCr4:2:2 (*4)
576i	(1440) 720	576	15.625	50	RGB/YCbCr4:4:4/YCbCr4:2:2 (*4)
480p	720 1440	480	31.469	59.94	RGB/YCbCr4:4:4/YCbCr4:2:2 (*4)
576p	720 1440	576	31.25	50	RGB/YCbCr4:4:4/YCbCr4:2:2 (*4)
720/60p	1280	720	37	59.94	RGB/YCbCr4:4:4/YCbCr4:2:2 (*4)
720/50p	1280	720	44.955	50	RGB/YCbCr4:4:4/YCbCr4:2:2 (*4)
1080/60i	1920	1080	33.716	59.94	RGB/YCbCr4:4:4/YCbCr4:2:2 (*4)
1080/50i	1920	1080	28.125	50	RGB/YCbCr4:4:4/YCbCr4:2:2 (*4)

(*3) VGA mode is only available for RGB signals.

(*4) You cannot select YCbCr4:2:2 mode manually. This mode only available when you set the unit to HDMI Auto mode.

Maintenance

◆ Regular care

Be sure to disconnect the power cable before doing any maintenance.

<Main unit>

Wipe with a soft cloth. Use a damp cloth with a mild detergent and then wipe with a dry cloth again if the unit is heavily soiled. Do not use strong solvents such as thinner or alcohol as they may damage the unit casing.

<Lens>

Use commercially available blowers or lens tissue to remove any dirt from the lens.

<Filter>

If dust accumulates on the ventilation port filter, the internal temperature of the unit rises, which may cause damage to the unit. Clean the filter approximately once every 200 hours. Remove the power cable from the AC outlet, and remove dust from the filter with a vacuum cleaner.

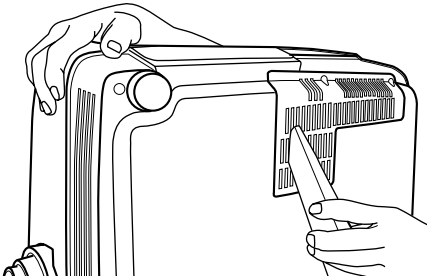

To prevent dust from entering the filter itself, be sure to vacuum the filter with the unit on its side.

◆ Replacing the filter

Replace the filter when it becomes difficult to remove dust from it.

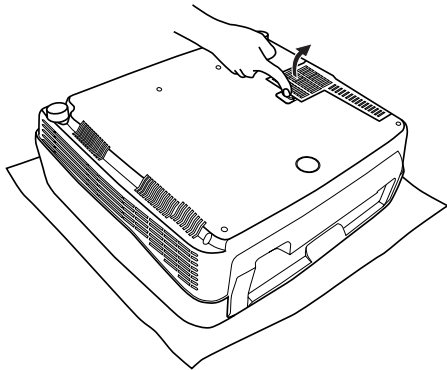

1. Turn off the power and remove the power cable.
2. Carefully place the unit upside down on a soft cloth to prevent scratching.
3. Press the filter hook on the underside of the main unit to remove the filter.

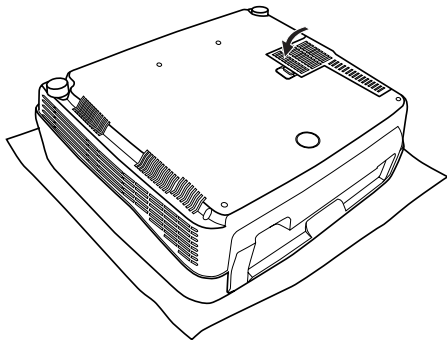

4. Firmly attach the new filter. The lamp does not light if the filter is incorrectly attached.

Warning

- Contact a YAMAHA dealer or service center if you require replacement filters.

◆ Replacing the lamp

Warning

- Be sure to use the replacement lamp cartridge PJL 427. Other lamp cartridges are not suitable for use in this unit.
- If replacing the lamp of the projector that has been installed to the ceiling, you should remove the projector from the ceiling before replacing the lamp.

The lamp used as a light source in this unit is a consumable item which will gradually lose its brightness during the course of use. It is advisable to replace the lamp when running time has exceeded 2000 hours.

You can check the lamp running time in the [Lamp Running Time] in the [Initial] menu group of the Menu screen. The LAMP warning indicator will blink when running time exceeds 2000 hours.

There will also be a message displayed on the screen. In this case, follow the instructions below to replace the lamp cartridge. Be sure to use the replacement lamp cartridge PJL 427. Other lamp cartridges are not suitable for use in this unit. Consult the store where this unit was bought for details on replacement of lamp cartridges.

Warning

- Before starting to replace the lamp cartridge, turn off the power, disconnect the power cable after the fan has completely stopped, and wait at least one hour for the lamp to cool down.
- Do not remove any other screws than those specified in the following steps.

1. Loosen the lamp cover screws.

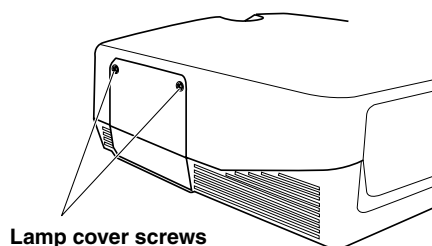

2. Remove the lamp cover.

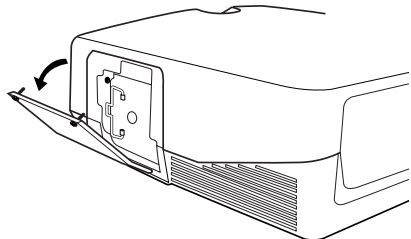

3. Loosen the screws of the lamp cartridge.

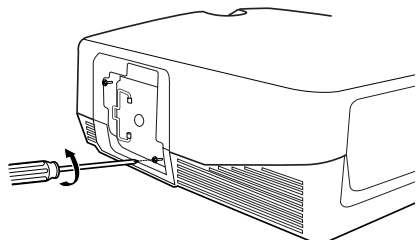

4. Grip the handle and pull the lamp cartridge to remove it.

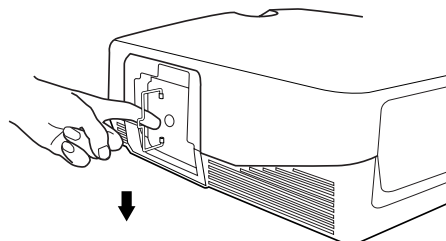

5. Insert the new lamp cartridge by reversing the above steps, and tighten the screws to fix it into place.

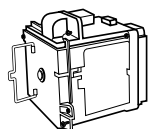

6. Replace the lamp cover and secure it with the screws.
The lamp will not turn on if the cover is not securely fastened. Take care to attach it firmly in place.
7. Connect the unit to the power outlet, turn the unit on, and reset [Lamp Running Time] on the [Initial] group in the menu. (☞ page 38)

Troubleshooting

Problem	Cause	Remedy
This unit does not turn on.	The power cable is not plugged in.	➔ Plug the power cable in firmly.
	You attempted to turn on this unit immediately after turning it off.	➔ Wait for approximately 2 minutes. <MEMO> • To protect the lamp, you cannot turn on power for 2 minutes after you turn it off.
	The filter cover is not correctly attached.	➔ Correctly attach the filter cover.
	The lamp cover is not correctly attached.	➔ Correctly attach the lamp cover.
No picture.	The lens cover has not been removed.	➔ Remove the lens cover.
	This unit is not correctly connected to the other components.	➔ Check the connections.
	The input signal has not been correctly selected.	➔ Select the correct input signal with the INPUT button. Press the AUTO button on the remote control. Use the menu to adjust the signal setting to suit the input setting. ➔ [Initial]
	The picture is turned off.	➔ Press the HIDE button again to cancel the HIDE function.
	The computer is not set to display on the external monitor.	➔ Set the computer to display on the external monitor. (Refer to the computer operating instructions.)
Image is unstable.	The connection cables are not correctly attached to the connectors.	➔ Correctly connect the cables to the appropriate connectors.
Picture is blurred.	The lens is not correctly focused.	➔ Press the FOCUS button, and adjust the focus.
	The screen and the main unit are not facing each other directly.	➔ Adjust the projection angle and direction, and the height of this unit.
The image becomes cloudy.	There is condensation on the unit.	➔ Switch the unit power off until the condensation disappears.
Cannot adjust focus or zoom, or the vertical position of the lens.	[Lens Adjustment Lock] in the menu is set to ON.	➔ Set correctly. Set [Lens Adjustment Lock] to off. Press the MENU button to display the menu and select [Setup] ➔ [Lens Adjustment Lock].
Remote control does not work correctly.	The batteries are exhausted.	➔ Replace both batteries with new ones.
	The remote control sensor is not set correctly.	➔ Set correctly. Press the MENU button to display the menu and select [Setup] ➔ [Remote Control Sensor].
	There is a fluorescent lamp near the remote control sensor being used.	➔ Turn off the remote control sensor near the fluorescent lamp, and use the other remote sensor.
	The remote control code switch is incorrectly set.	➔ Set the remote control code switch to the same ID number as the setting on the "REMOTE CONTROL ID" in the setting menu.

Problem	Cause	Remedy
COVER warning indicator lights up.	The filter cover is not correctly attached.	➔ Tightly attach the filter cover.
	The lamp cover is not correctly attached.	➔ Tightly attach the lamp cover.
LAMP warning indicator lights up or blinks.	Lamp running time has exceeded 2000 hours.	➔ Replace the lamp with a new one.
	The lamp has burned out.	➔ Replace the lamp with a new one.
TEMP warning indicator lights up.	The temperature inside this unit is extremely high.	➔ Check that the ventilation slots are not covered.
FAN warning indicator lights up.	The fan is broken.	➔ Contact the store where this unit was purchased.

Message display

Message	Condition
No Signal	The unit is not receiving or detecting any signal at the selected input source. This message is displayed together with the name of the input source selected with the INPUT button.
INPUT A (Component) (Example)	The input name selected by the INPUT button is displayed. It will turn off 2 seconds after the signal has been input.
Out Of Range	The unit is not able to decode the PC or HDMI signal currently being input.
Unknown Format	The unit is not able to decode the video signal currently being input.
Auto Sync...	The unit is setting itself to the most appropriate configuration for the RGB signal currently being received.
Memory 1—6 Now Processing	The memory setting number is displayed for 2 seconds.
The lamps has reached its recommended replacement time. Please replace with a new one.	This message is displayed when the power switch is turned on if the lamp running time exceeds 2000 hours. Press the ESCAPE button to remove the message.
Press again to enter standby.	Press the STANDBY/ON button once more to place the unit in standby mode.
Lens Adjustment is locked.	This message will display for 2 seconds if you press the V. POS, ZOOM, or FOCUS buttons when the [Lens Adjustment Lock] is set to [On].
Invalid Operation	Appears in the menu operation guide when you press an invalid button during menu operation. This message displays for 2 seconds.

LED indicator meanings

LED indicator	State	Meaning
STANDBY/ON (*)	Unlit	Electrical fault.
	Lit orange	Standby
	Blinking green	Preparing for operation.
	Lit green	Operating
	Blinking orange	Cooling the lamp.
	Blinking red	When the LAMP/COVER/TEMP/FAN indicator is lit red.
LAMP	Unlit	Normal
	Blinking orange	The lamp running time has exceeded 2000 hours.
	Lit red	The lamp has burned out.
COVER	Unlit	Normal
	Lit red	The lamp cover or the filter cover is not attached correctly.
TEMP	Unlit	Normal
	Lit red	The temperature of the lamp or the interior of the case is abnormally high.
FAN	Unlit	Normal
	Lit red	The cooling fan has broken.

(*) This LED is also present on the front panel of the main unit.

Specifications

• Optical		
Projection mode	DLP™ (DMD™) type, 1280 X 720 pixels, 0.8 inch	
Lens	f=24.3 – 38.9 mm F=2.7 – 5.0, Electronic zoom(x 1.6), Electronic focus, Electronic lens shift	
Lamp	270 W SHP lamp	
Screen size	60–200 inch (16:9)	
Brightness	800 – 400 ANSI lm (depends on Iris Setting)	
Contrast	2000:1(Default mode), 4000:1(depends on Iris Setting)	
• Input		
Color system	NTSC, PAL, SECAM, NTSC4.43, PAL-M, PAL-N, PAL60	
VIDEO	Composite signal	1Vp-p/75 Ω, Negative sync
S VIDEO	S-Video signal	Y:1Vp-p/75 Ω, Negative sync C:0.286 or 0.3Vp-p/75 Ω
D4 VIDEO	Component signal	Y with sync:1Vp-p/75 Ω, Negative sync (480i, 576i, 480p, 576p)
		Y with sync:1Vp-p/75 Ω, 3 values sync (1035i, 1080i, 720p)
		P _B /C _B , P _R /C _R :0.7Vp-p/75 Ω
INPUT A/INPUT B	Component signal	Y with sync:1Vp-p/75 W, Negative sync (480i, 576i, 480p, 576p)
		Y with sync:1Vp-p/75 W, 3 values sync (1035i, 1080i, 720p)
		P _B /C _B , P _R /C _R :0.7Vp-p/75 Ω
	RGB signal	G with sync:1Vp-p/75 Ω, Negative sync (480i, 576i, 480p, 576p)
		G with sync:1Vp-p/75 Ω, 3 values sync (1035i, 1080i, 720p)
		G:0.7Vp-p/75 Ω (When using HD/VD or SYNC)
		B, R:0.7Vp-p/75 Ω
		HD, VD:1–5Vp-p/2.2kΩ, positive and negative sync
		SYNC:2Vp-p/2.2kΩ, Negative sync (with video signals) (480i, 576i)
SYNC:0.6–5Vp-p/2.2kΩ, Negative sync (without video signals) (480i, 576i, 480p, 576p)		
HDMI	Digital RGB/component signal	
• Controls		
Remote	RS-232C (D-sub 9 pins)	
Trigger	+12 V/Max 200 mA when the power is on	
Wireless remote	1 in front, 1 at rear	
Wired remote	1 input jack, 1 output jack	
• General		
Usable temperature range	5 °C – 35 °C	
Usable humidity range	30 % – 85 %(There should be no condensation)	
Power supply	AC100 – 120 V/220 – 240 V, 50/60 Hz	
Power consumption	375 W	
Power consumption in standby mode	0.1 W – 0.2 W	
Noise level	30 dB(Standard mode), 28 dB(When Lamp Power Mode is set to 80)	
Dimension	495(W) x 192.6(H) x 465.4(D) mm	
Weight	13.8 kg	

Dimensional drawing

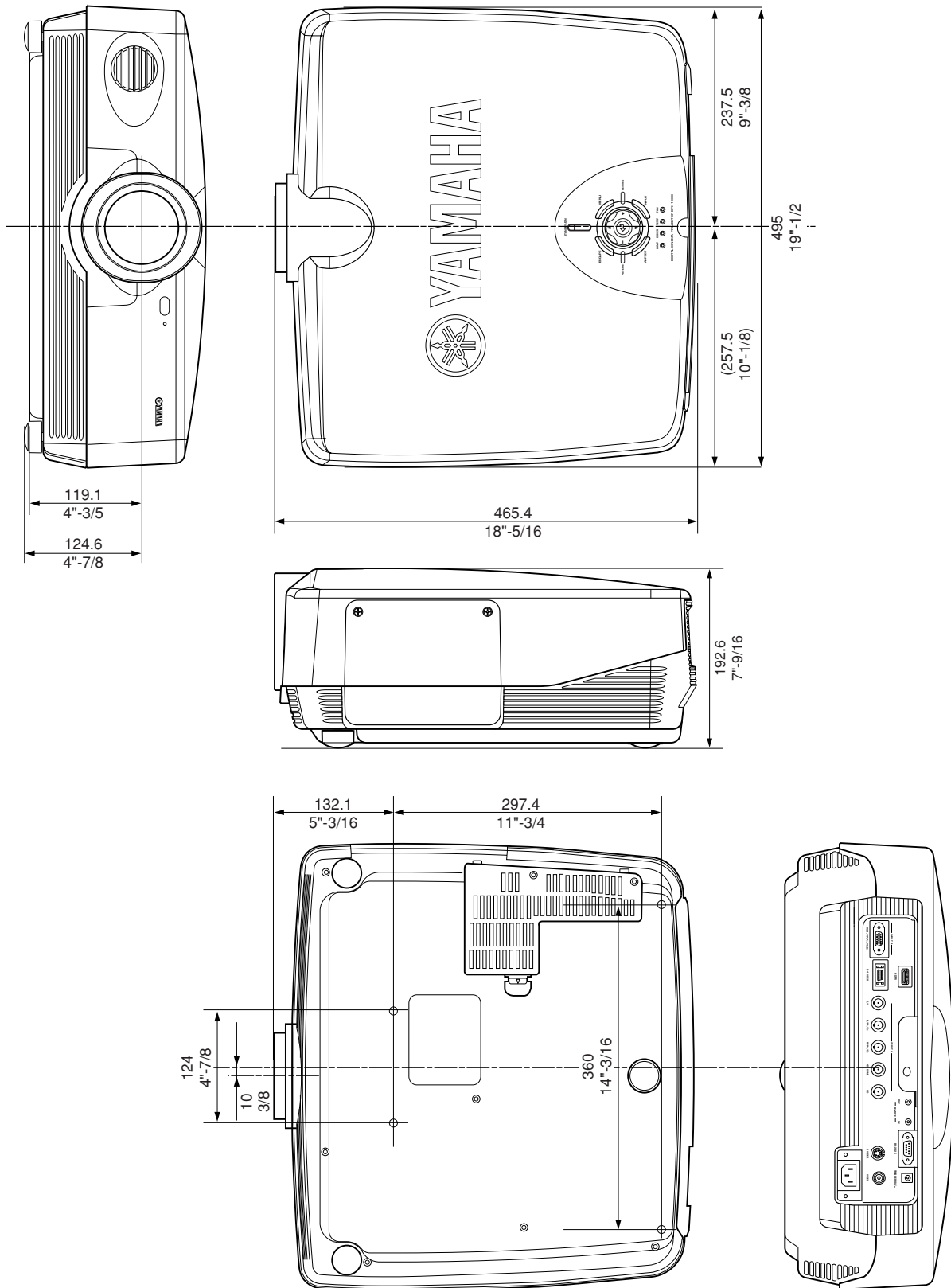

Specifications are subject to change without notice.

- This unit may interfere with reception if placed in close proximity to a radio or television receiver. Follow the instructions in this manual to install the unit correctly.



©2004 YAMAHA CORPORATION All Rights Reserved.

YAMAHA ELECTRONICS CORPORATION, USA 6660 ORANGETHORPE AVE., BUENA PARK, CALIF. 90620, U.S.A.
YAMAHA CANADA MUSIC LTD. 135 MILNER AVE., SCARBOROUGH, ONTARIO M1S 3R1, CANADA
YAMAHA ELECTRONIK EUROPA G.m.b.H. SIEMENSSTR. 22-34, 25462 RELLINGEN BEI HAMBURG, FR. OF GERMANY
YAMAHA ELECTRONIQUE FRANCE S.A. RUE AMBROISE CROIZAT BP70 CROISSY-BEAUBOURG 77312 MARNE-LA-VALLEE CEDEX02, FRANCE
YAMAHA ELECTRONICS (UK) LTD. YAMAHA HOUSE, 200 RICKMANSWORTH ROAD WATFORD, HERTS WD18 7GQ, ENGLAND
YAMAHA SCANDINAVIA A.B. J A WETTERGRENS GATA 1, BOX 30053, 400 43 VÄSTRA FRÖLUNDA, SWEDEN
YAMAHA MUSIC AUSTRALIA PTY, LTD. 17-33 MARKET ST., SOUTH MELBOURNE, 3205 VIC., AUSTRALIA

YAMAHA CORPORATION
Printed in Japan  WC71040