

User's Guide

Multimedia Projector

EB-G6750WU

EB-G6650WU

EB-G6550WU

EB-G6450WU

EB-G6350

EB-G6250W



EB-G6150

EB-G6050W





Notations Used in This Guide

- **Safety indications**

The documentation and the projector use graphical symbols to show how to use the projector safely. Please understand and respect these caution symbols in order to avoid injury to persons or property.

 Warning	This symbol indicates information that, if ignored, could possibly result in personal injury or even death due to incorrect handling.
 Caution	This symbol indicates information that, if ignored, could possibly result in personal injury or physical damage due to incorrect handling.

- **General information indications**

Attention	Indicates procedures which may result in damage or injury if sufficient care is not taken.
	Indicates additional information and points which may be useful to know regarding a topic.
	Indicates a page where detailed information regarding a topic can be found.
	Indicates that an explanation of the underlined word or words in front of this symbol appears in the glossary of terms. See the "Glossary" section of the "Appendix".  "Glossary" p.176
[Name]	Indicates the name of the buttons on the remote control or the control panel. Example: [Esc] button
Menu Name	Indicates Configuration menu items. Example: Select Brightness from Image . Image - Brightness



Notations Used in This Guide 2

Introduction

Part Names and Functions 8

Front/Top	8
Rear	9
Interface	9
Base	10
Control Panel	11
Remote Control	12
Replacing the remote control batteries	14
Remote control operating range	15
Removing and Attaching the Projector Lens Unit	16
Attaching	16
Removing	17

Preparing the Projector

Installing the Projector 20

Installation Requirements	20
Changing the direction of the image (projection mode)	21
Screen Settings	22
Adjusting the position of the image on the projected screen	23
Displaying a Test Pattern	23
Adjusting the Position of the Projected Image (Lens Shift)	24
Adjusting the Image Size	26
Correcting the Focus	26
When using the short throw zoom lens ELPLU01	26
Adjusting the Image Position	27
Adjusting the Horizontal Tilt	27
ID Settings	28
Set the projector ID	28
Checking the Projector ID	29
Setting the remote control ID	29

Setting the Time	29
------------------	----

Connecting Equipment 31

Connecting a Computer	31
Connecting Image Sources	33
Connecting External Equipment	35
Connecting a LAN Cable	36
Connecting an HDBaseT Transmitter (EB-G6750WU Only)	36
Installing the Wireless LAN Unit	38
Attaching the Cable Cover	39
Attaching	39

Basic Usage

Projecting Images 41

Automatically Detect Input Signals and Change the Projected Image (Source Search)	41
Switching to the Target Image by Remote Control	42
Adjusting the Volume	42

Adjusting Projected Images 43

Correcting Distortion in the Projected Image	43
H/V-Keystone	43
Quick Corner	44
Arc Correction	45
Selecting the Projection Quality (Selecting Color Mode)	46
Projecting 3D images	47
Changing the Aspect Ratio of the Projected Image	47
Changing methods	47
Adjusting the Image	49
Hue, Saturation, and Brightness Adjustment	49
Gamma Adjustment	49
Frame Interpolation (EB-G6750WU/EB-G6650WU/EB-G6550WU/EB-G6450WU only)	50



Useful Functions

Multi-Projection Function	53
Adjusting the Position of the Projected Image	53
Point Correction	53
Checking the Color Mode	55
Adjust the Edges of the Images (Edge Blending)	55
Adjusting the brightness of the lamp	55
Performing edge blending	55
Adjusting to Match Colors	57
Scaling an Image (Scale)	58
Projection Functions	60
Projecting Two Images Simultaneously (Split Screen)	60
Operating procedures	60
Restrictions during split screen projection	62
Hiding the Image and Sound Temporarily (A/V Mute)	63
Freezing the Image (Freeze)	64
Enlarging Part of the Image (E-Zoom)	64
Saving a User's Logo	65
Memory Function	67
Saving/Loading/Erasing the Memory	67
Scheduling Function	69
Saving a Schedule	69
Setting Methods	69
Editing a schedule	70
Security Functions	72
Managing Users (Password Protection)	72
Kinds of Password Protection	72
Setting Password Protection	72
Entering the Password	73
Restricting Operation	74
Control Panel Lock	74
Remote control button lock	75
Anti-Theft Lock	75

Installing the wire lock	76
--------------------------------	----

Configuration Menu

Using the Configuration Menu	78
---	-----------

List of Functions	79
--------------------------------	-----------

Configuration Menu Table	79
Network menu	80
Image Menu	81
Signal Menu	82
Settings Menu	84
Extended Menu	86
Network Menu	89
Notes on operating the Network menu	90
Soft keyboard operations	91
Basic menu	91
Wireless LAN menu	92
Security menu	94
Wired LAN menu	97
Administrator Settings menu	98
Reset menu	101
Info Menu (Display Only)	102
Reset Menu	103

Troubleshooting

Using the Help	105
-----------------------------	------------

Problem Solving	106
------------------------------	------------

Reading the Indicators	106
When the Indicators Provide No Help	110
Problems Relating to Images	111
No images appear	111
Moving images are not displayed	111
Projection stops automatically	112



The message Not supported is displayed 112

The message No Signal is displayed 112

Images are fuzzy, out of focus, or distorted 113

Interference or distortion appear in images 113

The image is truncated (large) or small, the aspect is not suitable, or the image has been reversed 114

Image colors are not right 115

Images appear dark 116

Problems when Projection Starts 116

 The projector does not turn on 116

Other Problems 117

 No sound can be heard or the sound is faint 117

 The remote control does not work 118

 Nothing appears on the external monitor 119

 I want to change the language for messages and menus 119

 The authentication setting of wireless LAN fails 120

 Email is not received even if a problem occurs in the projector 120

 The battery that saves your clock settings is running low. is displayed 120

 Cannot change settings using a Web browser 121

About Event ID 122

Maintenance

Cleaning 125

Cleaning the Projector's Surface 125

Cleaning the Lens 125

Cleaning the Air Filter 125

 Cleaning the air filter 125

Replacing Consumables 128

Replacing the Lamp 128

 Lamp replacement period 128

 How to replace the lamp 129

 Resetting the lamp hours 131

Replacing the Air Filter 131

 Air filter replacement period 131

How to replace the air filter 131

Notes on Transportation 133

Moving Nearby 133

When Transporting 133

 Preparing packaging 133

 Notes when packing and transporting 133

Image Maintenance 134

Panel Alignment 134

Color Uniformity 135

Adjusting the Lens Balance 137

Appendix

Network Functions 142

Projecting with "Connect to a Network Projector" 142

Making a WPS (Wi-Fi Protected Setup) Connection with a Wireless LAN Access Point 142

 Connection Setup Method 142

 Using the Quick Wireless Connection USB Key 143

Monitoring and Controlling 145

About EasyMP Monitor 145

 About Message Broadcasting 145

Changing Settings Using a Web Browser (Web Control) 145

 Projector setup 145

 Displaying the Web Control screen 145

 Setting Certificates 146

 Secure HTTP Notes 147

 List of supported certificates 147

Using the Mail Notification Function to Report Problems 148

 Reading Error Notification Mail 148

Management Using SNMP 149

Displaying the Web Remote Screen 149

ESC/VP21 Commands 150

 Command list 150

Cable layouts	150
About PJLink	151
About Crestron RoomView®	152
Operating a projector from your computer	152
Optional Accessories and Consumables	156
Optional Accessories	156
Consumables	157
Screen Size and Projection Distance	158
Projection Distance (For EB-G6750WU/EB-G6650WU/EB-G6550WU/EB-G6450WU/ EB-G6250W/EB-G6050W)	158
Standard zoom lens ELPLS06	158
Short throw zoom lens ELPLU01	159
Rear projection wide lens ELPLR03	159
Middle throw zoom lens ELPLM04	160
Middle throw zoom lens ELPLM05	161
Long throw zoom lens ELPLL06	162
Projection Distance (For EB-G6350/EB-G6150)	163
Standard zoom lens ELPLS06	163
Short throw zoom lens ELPLU01	164
Rear projection wide lens ELPLR03	165
Middle throw zoom lens ELPLM04	165
Middle throw zoom lens ELPLM05	166
Long throw zoom lens ELPLL06	167
Supported Monitor Displays	169
Supported Resolutions	169
Computer signals (analog RGB)	169
Component Video	169
Composite video	169
Input signal from the HDMI port and DisplayPort (EB-G6750WU/EB-G6650WU/EB- G6550WU/EB-G6450WU/EB-G6250W/EB-G6050W)	170
Input signal from the HDMI port and DisplayPort (EB-G6350/EB-G6150)	170
Specifications	171
Projector General Specifications	171

Appearance	175
Glossary	176
General Notes	178
Trademarks and Copyrights	178
Index	179





Introduction





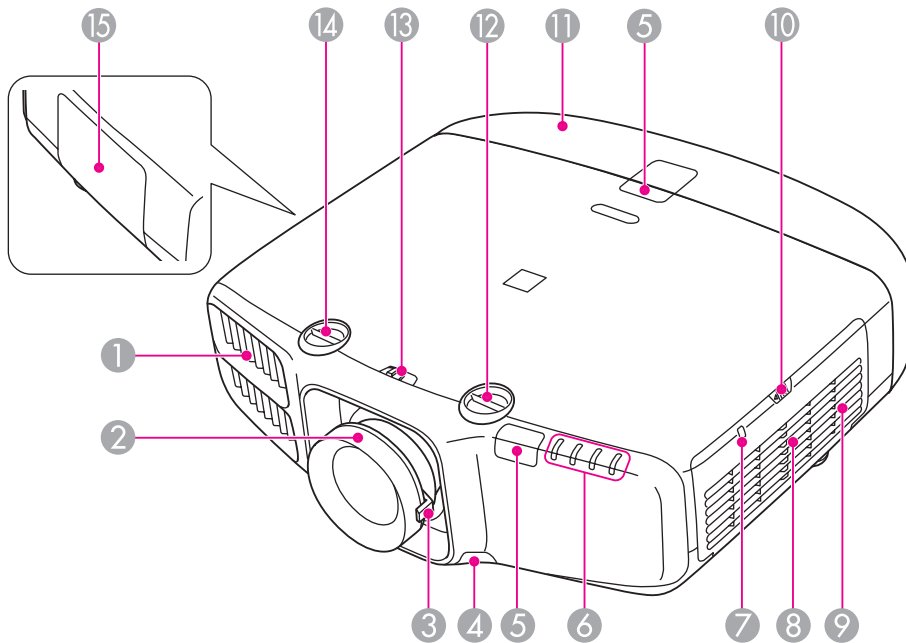





This chapter explains the names for each part.

The illustrations in this guide are for EB-G6750WU (with the standard zoom lens ELPLS06 attached).

Front/Top



Name	Function
1 Air exhaust vent	Exhaust vent for air used to cool the projector internally. <div style="border: 1px solid black; padding: 5px; margin-top: 10px;">  Caution While projecting, do not put your face or hands near the air exhaust vent, and do not place objects that may become warped or damaged by heat near the vent. Hot air from the air exhaust vent could cause burns, warping, or accidents to occur. </div>

Name	Function
2 Focus ring	Adjusts the image focus.  "Correcting the Focus" p.26
3 Zoom ring	Adjusts the image size.  "Adjusting the Image Size" p.26
4 Lens unit removal button	When replacing the lens unit, press this button and then remove the lens unit.  "Removing and Attaching the Projector Lens Unit" p.16
5 Remote receiver	Receives signals from the remote control.
6 Status indicators	The color of the indicators and whether they are flashing or lit indicate the status of the projector.  "Reading the Indicators" p.106
7 Wireless LAN indicator	Indicates the access status of the supplied or optional wireless LAN unit.  "Optional Accessories" p.156
8 Air intake vent (air filter)	Takes in air to cool the projector internally.  "Cleaning the Air Filter" p.125
9 Speaker	Outputs audio.
10 Air filter cover operation knob	Use this knob to open the air filter cover.  "Replacing the Air Filter" p.131
11 Cable cover	Cover for the rear interface cable connection section.  "Attaching the Cable Cover" p.39
12 Vertical lens shift dial	Turn the dial to move the position of the projected image up or down.  "Adjusting the Position of the Projected Image (Lens Shift)" p.24
13 Lens shift dial lock	Locks or releases the lens shift dials.
14 Horizontal lens shift dial	Turn the dial to move the position of the projected image left or right.  "Adjusting the Position of the Projected Image (Lens Shift)" p.24

Name	Function
15 Lamp cover	Open when replacing the projector's lamp. ☛ "Replacing the Lamp" p.128

Rear

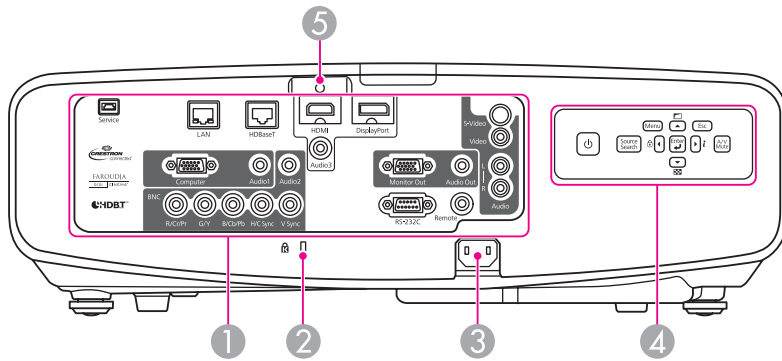

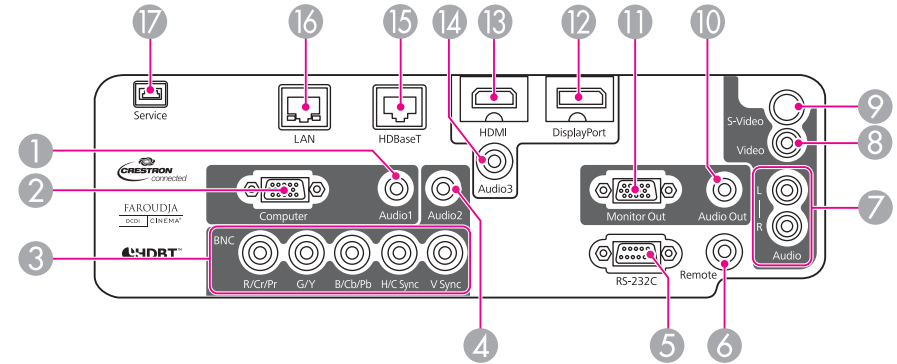

Name	Function
1 Interface	☛ "Interface" p.9
2 Security slot	The security slot is compatible with the Microsaver Security System manufactured by Kensington. ☛ "Anti-Theft Lock" p.75
3 Power inlet	Connects to the power cable.
4 Control panel	☛ "Control Panel" p.11
5 Cable holder	Insert the supplied cable clamp here to prevent the HDMI cable from falling out. ☛ <i>Quick Reference</i>

Interface





Name	Function
1 Audio1 port	Inputs audio from equipment connected to the Computer port.
2 Computer port	For analog RGB signals from a computer and component video signals from other video sources.
3 BNC port	For analog RGB signals from a computer and component video signals from other video sources.
4 Audio2 port	Inputs audio from equipment connected to the BNC port.
5 RS-232C port	When controlling the projector from a computer, connect it to the computer with an RS-232C cable. This port is for control use and should not normally be used. ☛ "ESC/VP21 Commands" p.150
6 Remote port	Connects the optional remote control cable set and inputs signals from the remote control. When the remote control cable is plugged into the Remote port, the remote receiver on the projector is disabled. ☛ "Optional Accessories" p.156
7 Audio-L/R port	Inputs audio from equipment connected to the Video port or the S-Video port.
8 Video port	Inputs composite video signals from video sources.

Name	Function
9 S-Video port	For S-video signals from video sources.
10 Audio Out port	Outputs audio from the currently projected image to an external speaker.
11 Monitor Out port	Outputs to an external monitor the analog signal from the computer connected to the Computer port or the BNC port. You cannot output signals input from other ports or component video signals.
12 DisplayPort	Inputs video signals from DisplayPort compatible computers. This projector is compatible with HDCP .
13 HDMI port	Inputs video signals from HDMI compatible video equipment and computers. This projector is compatible with HDCP .
14 Audio3 port	Inputs audio from equipment connected to the DisplayPort or the HDMI port.
15 HDBaseT port (EB-G6750WU only)	Connects a LAN cable to the optional HDBaseT Transmitter.  "Connecting an HDBaseT Transmitter (EB-G6750WU Only)" p.36  "Optional Accessories" p.156
16 LAN port	Connects a LAN cable to connect to a network.
17 Service port	This port is used by maintenance personnel to control the projector. This should not normally be used.

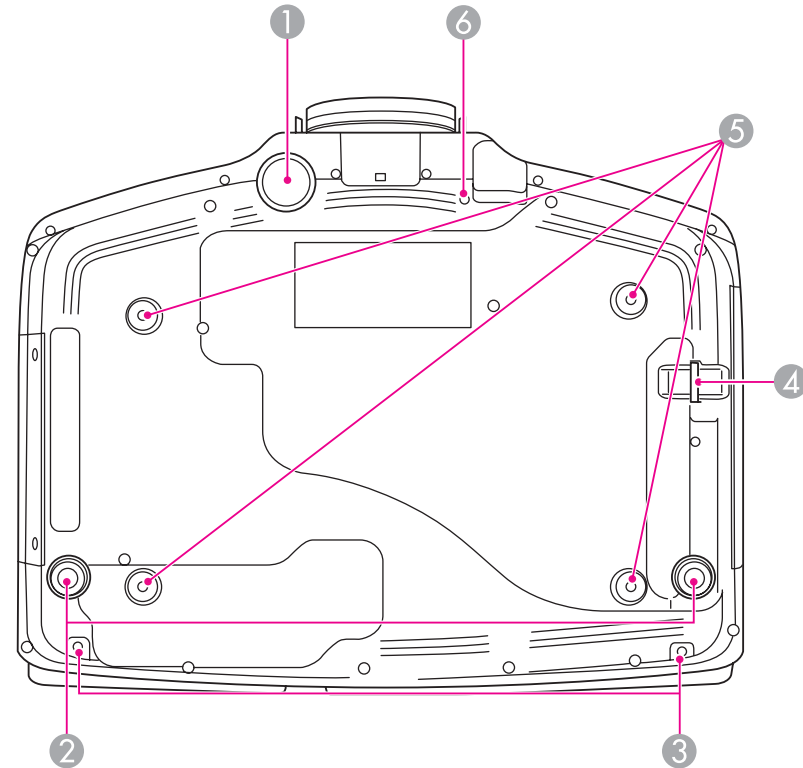
Base



Name	Function
1 Front adjustable foot	When setup on a surface such as a desk, extend the foot to adjust the position of the image.  "Adjusting the Image Position" p.27
2 Rear feet	When setup on a surface such as a desk, turn to extend and retract to adjust the horizontal tilt.  "Adjusting the Horizontal Tilt" p.27
3 Screw holes to fix the cable cover	Screw holes to fix the cable cover in place.  "Attaching the Cable Cover" p.39

Name	Function
4 Security cable installation point	Pass a commercially available wire lock through here and lock it in place. ☛ "Installing the wire lock" p.76
5 Ceiling mount fixing points (four points)	Attach the optional Ceiling Mount here when suspending the projector from a ceiling. ☛ "Installing the Projector" p.20 ☛ "Optional Accessories" p.156
6 Screw hole for the screw to fix the lens unit removal button	When installing a lens unit, use this screw hole to fix the lens unit removal button using the screw supplied. ☛ "Removing and Attaching the Projector Lens Unit" p.16

Control Panel

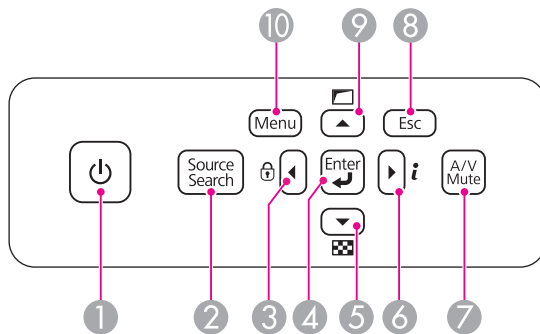







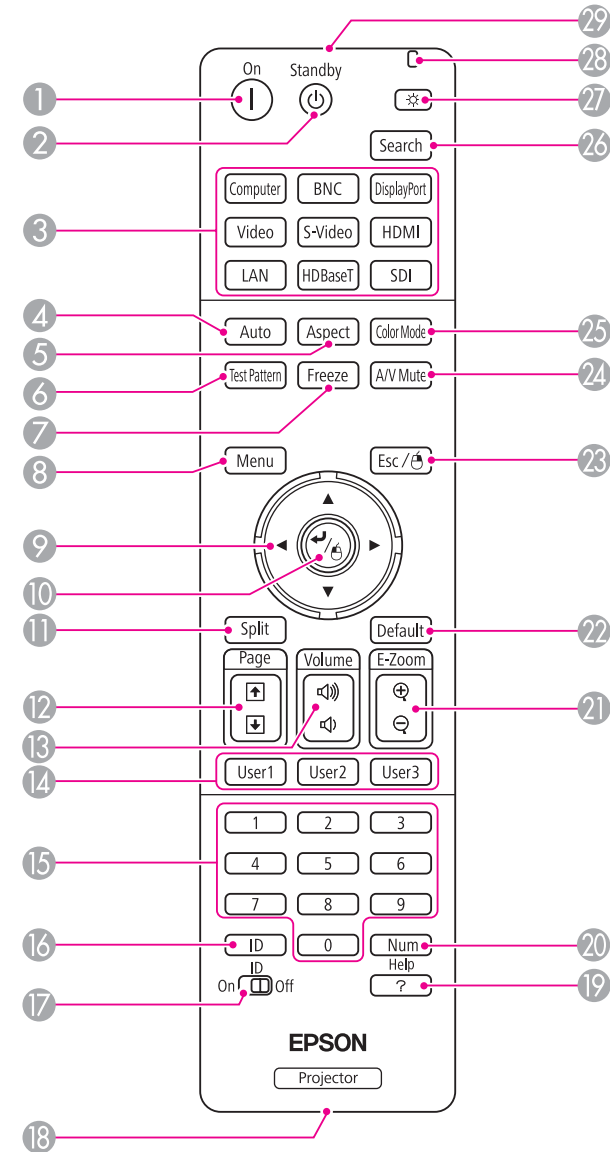

Name	Function
1 [Power] button	Turns the projector power on or off.
2 [Source Search] button	Changes to the next input source that is sending an image. ☛ "Automatically Detect Input Signals and Change the Projected Image (Source Search)" p.41







Name	Function
3 [Left Arrow]/[Lock] buttons	<ul style="list-style-type: none"> Displays the Control Panel Lock screen allowing you to make settings to lock the control panel buttons. ☛ "Restricting Operation" p.74 If pressed when the Configuration menu or the Help screen is displayed, this button selects menu items and setting values. ☛ "Using the Configuration Menu" p.78 ☛ "Using the Help" p.105
4 [Enter] button	<ul style="list-style-type: none"> When the Configuration menu or the Help screen is displayed, it accepts and enters the current selection and moves to the next level. If pressed while projecting analog RGB signals from the Computer port or the BNC port, you can automatically optimize Tracking, Sync., and Position.
5 [Down Arrow]/[Test Pattern] buttons	<ul style="list-style-type: none"> Displays a test pattern. ☛ "Displaying a Test Pattern" p.23 If pressed when the Configuration menu or the Help screen is displayed, this button selects menu items and setting values. ☛ "Using the Configuration Menu" p.78 ☛ "Using the Help" p.105
6 [Right Arrow]/[Info] buttons	<ul style="list-style-type: none"> Displays the Info menu from the Configuration menu. ☛ "Info Menu (Display Only)" p.102 If pressed when the Configuration menu or the Help screen is displayed, this button selects menu items and setting values. ☛ "Using the Configuration Menu" p.78 ☛ "Using the Help" p.105
7 [A/V Mute] button	Turns the video and audio on or off. ☛ "Hiding the Image and Sound Temporarily (A/V Mute)" p.63

Name	Function
8 [Esc] button	<ul style="list-style-type: none"> Stops the current function. If pressed when the Configuration menu is displayed, it moves to the previous menu level. <ul style="list-style-type: none"> "Using the Configuration Menu" p.78
9 [▲]/[▼] buttons	<ul style="list-style-type: none"> Performs screen adjustments using the settings in Geometric Correction from the Configuration menu. <ul style="list-style-type: none"> Settings - Geometric Correction p.84 If pressed when the Configuration menu or the Help screen is displayed, this button selects menu items and setting values. <ul style="list-style-type: none"> "Using the Configuration Menu" p.78 "Using the Help" p.105
10 [Menu] button	<p>Displays and closes the Configuration menu.</p> <ul style="list-style-type: none"> "Using the Configuration Menu" p.78

Remote Control



Name	Function
① [⏻] button	Turns the projector on.
② [⏻] button	Turns the projector off.
③ Change input buttons	Changes to images from each input port.  "Switching to the Target Image by Remote Control" p.42 The [HDBaseT] button is only available for EB-G6750WU. The [SDI] button is not available for this projector.
④ [Auto] button	If pressed while projecting analog RGB signals from the Computer port or the BNC port, you can automatically optimize Tracking, Sync., and Position.
⑤ [Aspect] button	Each time the button is pressed, the aspect mode changes.  "Changing the Aspect Ratio of the Projected Image " p.47
⑥ [Test Pattern] button	Displays a test pattern.  "Displaying a Test Pattern" p.23
⑦ [Freeze] button	Images are paused or unpaused.  "Freezing the Image (Freeze)" p.64
⑧ [Menu] button	Displays and closes the Configuration menu.  "Using the Configuration Menu" p.78
⑨ [▲][▼][◀][▶] buttons	<ul style="list-style-type: none"> When the Configuration menu or the Help screen is displayed, pressing these buttons selects menu items and setting values.  "Using the Configuration Menu" p.78 When using the optional wireless mouse receiver, pressing these buttons moves the pointer.  "Optional Accessories" p.156

Name	Function
⑩ [↵] button	<ul style="list-style-type: none"> When the Configuration menu or the Help screen is displayed, it accepts and enters the current selection and moves to the next level.  "Using the Configuration Menu" p.78 Acts as a mouse's left button when using the optional wireless mouse receiver.  "Optional Accessories" p.156
⑪ [Split] button	Each time the button is pressed, the image changes between projecting two images simultaneously by splitting the projected screen, or projecting one image as normal.  "Projecting Two Images Simultaneously (Split Screen)" p.60
⑫ [Page] buttons [⏪][⏩]	Moves to the previous or next image file when projecting images from a computer connected via a network.
⑬ [Volume] buttons [◀][▶]	[◀] Decreases the volume. [▶] Increases the volume.  "Adjusting the Volume" p.42
⑭ [User1] button [User2] button [User3] button	Select any frequently used item from the eight available Configuration menu items, and assign it to one of these buttons. By pressing the button, the assigned menu item selection/adjustment screen is displayed, allowing you to make one-touch settings/adjustments.  "Settings Menu" p.84
⑮ Numeric buttons	<ul style="list-style-type: none"> Enter the Password.  "Setting Password Protection" p.72 Use this button to enter numbers in Network settings from the Configuration menu.
⑯ [ID] button	Hold down this button and press the numeric buttons to select the ID for the projector you want to operate using the remote control.  "ID Settings" p.28

Name	Function
17 [ID] switch	Use this switch to enable (On)/disable (Off) ID settings for the remote control. ☛ "ID Settings" p.28
18 Remote port	Connects the optional remote control cable set and outputs signals from the remote control. ☛ "Optional Accessories" p.156 When the remote control cable is plugged into this remote port, the remote control light-emitting is disabled.
19 [Help] button	Displays and closes the Help screen which shows you how to deal with problems if they occur. ☛ "Using the Help" p.105
20 [Num] button	Hold down this button and press the numeric buttons to enter passwords and numbers. ☛ "Setting Password Protection" p.72
21 [E-Zoom] buttons [⊕][⊖]	Enlarges or reduces the image without changing the projection size. ☛ "Enlarging Part of the Image (E-Zoom)" p.64
22 [Default] button	Enabled when [Default]: Reset is displayed on the configuration menu guide. The settings being adjusted are returned to their default values. ☛ "Using the Configuration Menu" p.78
23 [Esc] button	<ul style="list-style-type: none"> • Stops the current function. • If pressed when the Configuration menu is displayed, it moves to the previous level. ☛ "Using the Configuration Menu" p.78 • Acts as a mouse's right button when using the optional wireless mouse receiver. ☛ "Optional Accessories" p.156
24 [A/V Mute] button	Turns the video and audio on or off. ☛ "Hiding the Image and Sound Temporarily (A/V Mute)" p.63

Name	Function
25 [Color Mode] button	Each time the button is pressed, the Color Mode changes. ☛ "Selecting the Projection Quality (Selecting Color Mode)" p.46
26 [Search] button	Changes to the next input source that is sending an image. ☛ "Automatically Detect Input Signals and Change the Projected Image (Source Search)" p.41
27 [☀] button	Illuminates the buttons on the remote control for approximately 15 seconds. This is useful when using the remote control in the dark.
28 Indicator	A light is emitted when outputting remote control signals.
29 Remote control light-emitting area	Outputs remote control signals.

Replacing the remote control batteries

If delays in the responsiveness of the remote control occur or if it does not operate after it has been used for some time, it probably means that the batteries are becoming flat. When this happens, replace them with new batteries. Have two AA size alkaline or manganese batteries ready. You cannot use other batteries except for the AA size alkaline or manganese.

Attention

Make sure you read the following manual before handling the batteries.

☛ *Safety Instructions*

1 Remove the battery cover.

While pushing the battery compartment cover catch, lift the cover up.

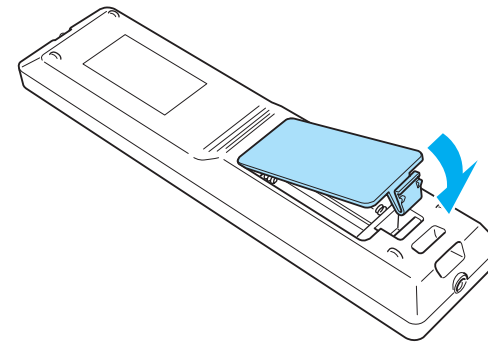
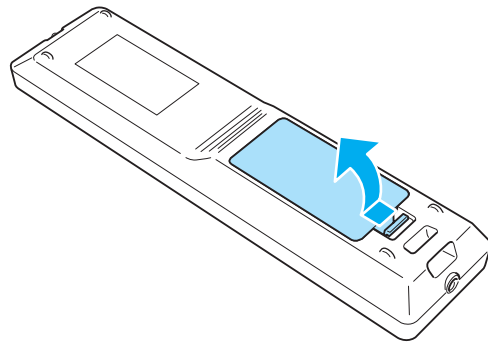

2 Replace the old batteries with new batteries.

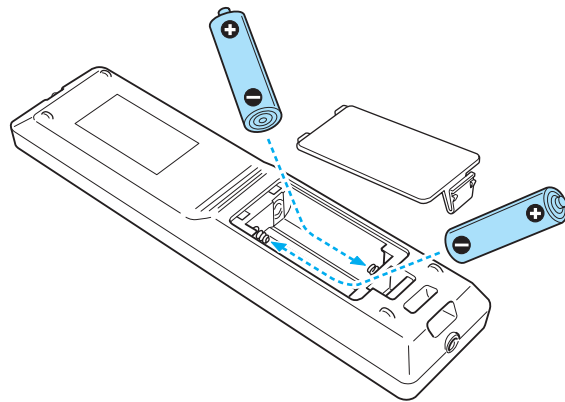

⚠ Caution

Check the positions of the (+) and (-) marks inside the battery holder to ensure the batteries are inserted the correct way.

If the batteries are not used correctly, they could explode or leak causing a fire, injury, or damage to the product.

3 Replace the battery cover.
Press the battery compartment cover until it clicks into place.

Remote control operating range

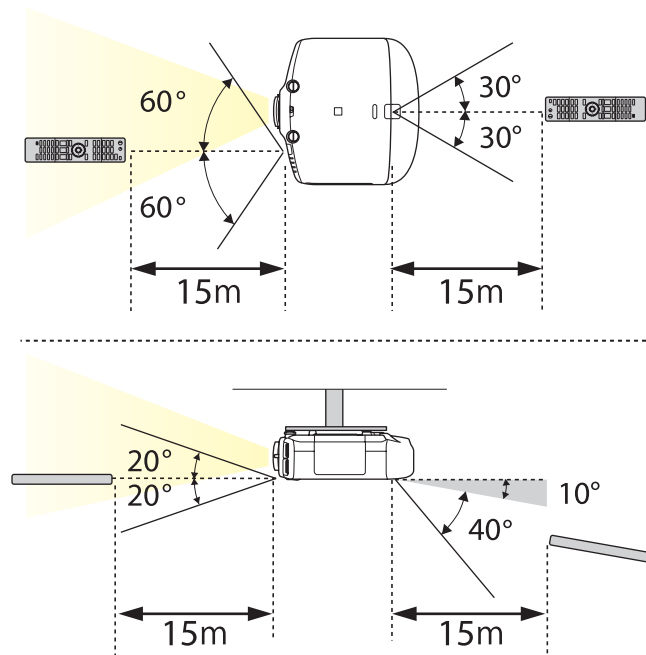



- To restrict reception of the operation signals from the remote control, set **Remote Receiver**.
 ⚙️ **Settings - Remote Receiver** p.84
- When using a remote control provided with other Epson projectors, set the **Remote Control Type**.
 ⚙️ **Extended - Operation - Remote Control Type** p.86
 The operating range depends on the remote control that you use.

Removing and Attaching the Projector Lens Unit

Attaching

Attention

- Do not attach the lens unit when the projector's lens insertion section is facing up. Dust or dirt could enter the projector.
- Only use the specified lens. See the following for a list of lenses that can be used with the projector.
 ⚙️ "Optional Accessories" p.156

- 1 Turn the focus ring clockwise until it cannot go any further.

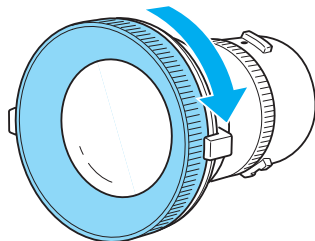

- 2 Insert the lens unit straight into the projector's lens socket with the white dot at the top, and then turn it clockwise until you hear it click into place.

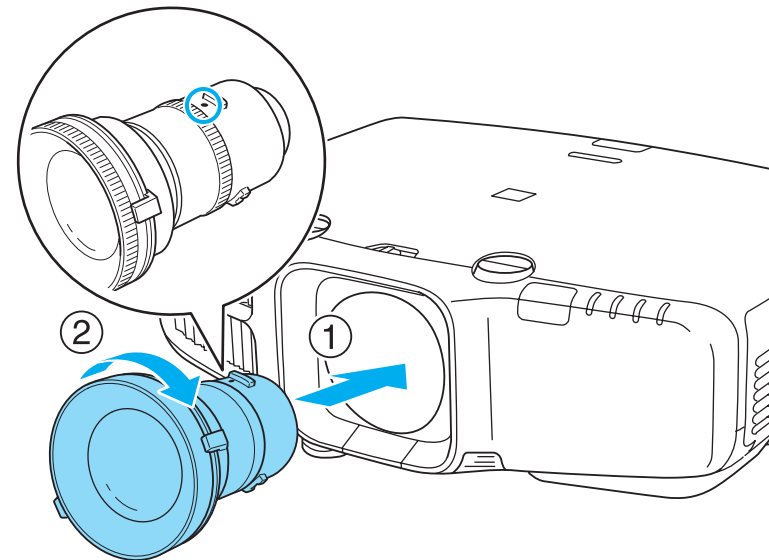

Turn the torque ring on the lens unit to adjust the torque for the zoom ring.

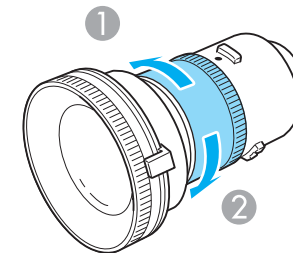

- 1 Tighter
- 2 Looser

- 3 Turn the lens unit counterclockwise and make sure that it does not come out of the socket.
- 4 Fix the lens unit removal button with the screw supplied with the lens unit.

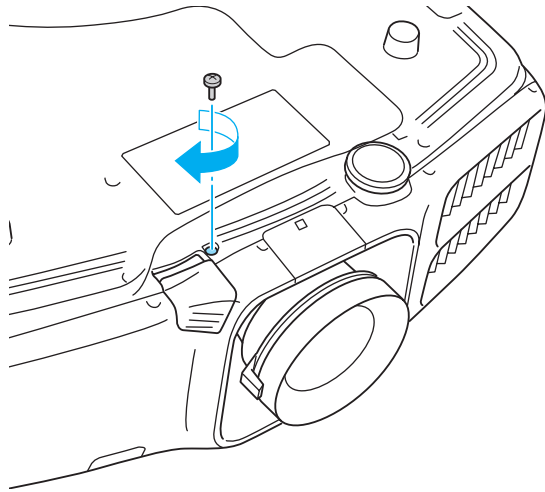

Make sure you fix the lens unit removal button with the screw to prevent the lens unit from being stolen.

Attention

- Store the projector with the lens unit installed. If the projector is stored without the lens unit, dust and dirt may get inside the projector and cause malfunctions or lower the quality of projection.
- When the projector is facing up (35 to 150 degrees) or down (-35 to -150 degrees), tighten the lens torque ring. Note that it could malfunction if it is over tightened.

Removing

Attention

- Only remove the lens unit when necessary. If dust or dirt enter the projector, projection quality deteriorates and it could cause a malfunction.
- Try not to touch the lens section with your hand or fingers. If fingerprints or oils are left on the surface of the lens, projection quality deteriorates.
- If the lens shift has been done, set the lens shift to the center before replacing the lens unit.
 - ☛ "Adjusting the Position of the Projected Image (Lens Shift)" p.24

- 1** When the lens unit removal button is fixed with a screw, remove the screw.

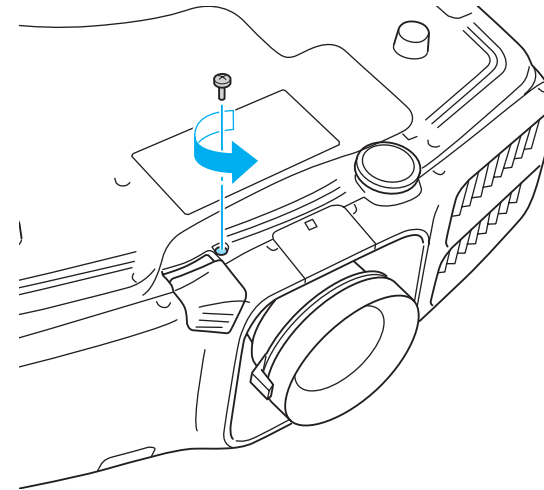

- 2** While pressing the lens unit removal button, turn the lens unit counterclockwise until you hear it click.

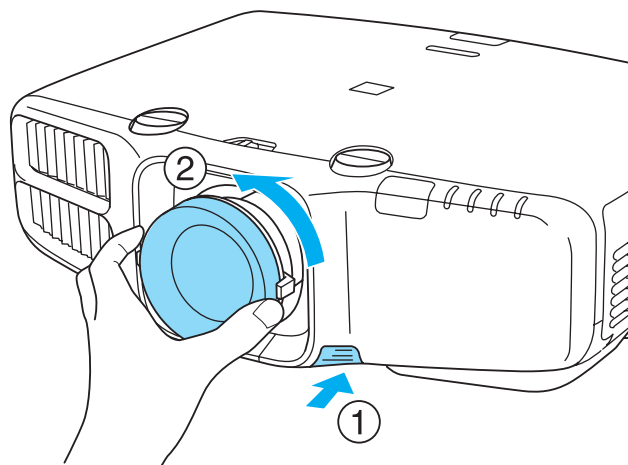

- 3** Pull the lens unit straight out as it is released.



Preparing the Projector

This chapter explains how to install the projector and connect projection sources.







Installation Requirements

The projector can be mounted on a ceiling or placed on a desk. Also, it can be mounted at a tilted angle, so you can flexibly project images to various places.

Warning

- A special method of installation is required when suspending the projector from a ceiling (ceiling mount). If installation work is not carried out correctly, the projector could fall down. This may result in injury or accidents.
Contact your dealer or the nearest address provided in the Support and Service Guide if you want to use this installation method.  [Epson Projector Contact List](#)
- If you use adhesives on the Ceiling mount fixing points to prevent the screws from loosening, or if you use things such as lubricants or oils on the projector, the projector case may crack causing it to fall from its ceiling mount. This could cause serious injury to anyone under the ceiling mount and could damage the projector.
When installing or adjusting the ceiling mount, do not use adhesives to prevent the screws from loosening and do not use oils or lubricants and so on.
- Do not cover the projector's air intake vent or air exhaust vent. If either of the vents are covered, the internal temperature could rise and cause a fire.



- An optional ceiling mount is required when suspending the projector from a ceiling.
 "Optional Accessories" [p.156](#)
- When mounted on a ceiling, set **Inv Direction Button** to On so that the operations and movement of the [, [, [, and [] buttons on the control panel match.
 **Extended - Operation - Inv Direction Button** [p.86](#)

The projector can be installed at the following angles.

Vertical: Can be installed at any angle in a complete 360 degrees.

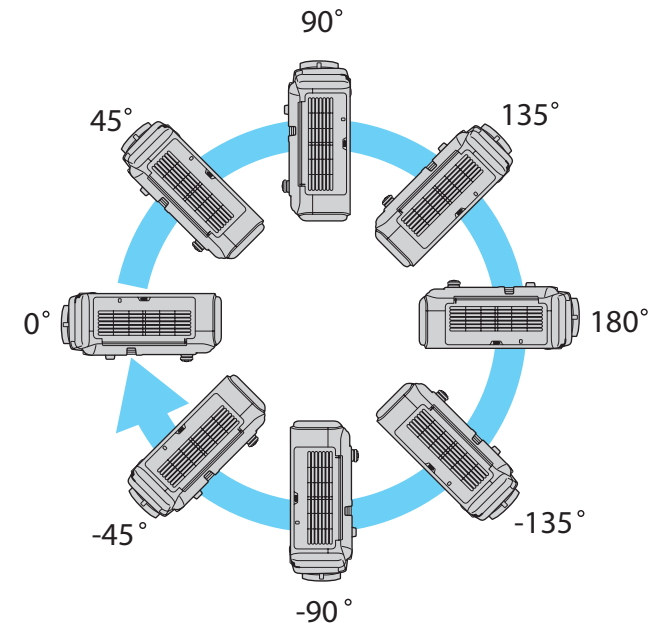

Horizontal: Can be tilted within the range of expansion and contraction for the rear feet.

 "Adjusting the Horizontal Tilt" [p.27](#)

Make sure there is a gap of at least 50 cm between the wall and the air exhaust vent and the air intake vent.

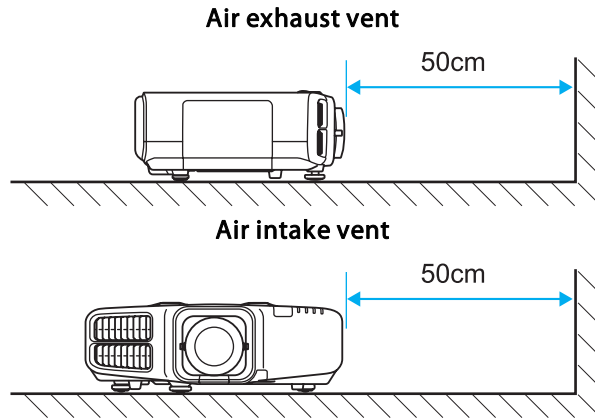

When setting up multiple projectors, make sure there is a gap of at least 50 cm between the projectors.

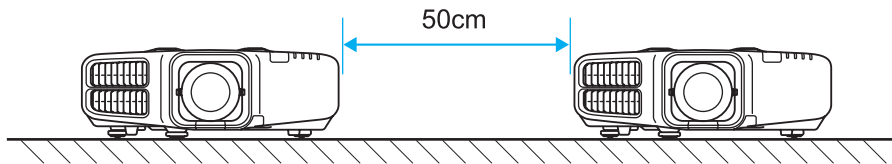

When installation is complete, set the **Direction** from the configuration menu according to the vertical installation angle.

Attention

Make sure you set **Direction** correctly. The lamp's operating life may be reduced if it is not set.

- 1 Press the [Menu] button while projecting.
- 2 Select **Direction** from **Extended**.

- 3 Use the [◀][▶] buttons to set the projector's installation angle. Each time you press one of the buttons, the angle of tilt changes by 15 degrees. Set as close to the actual setup angle as possible.

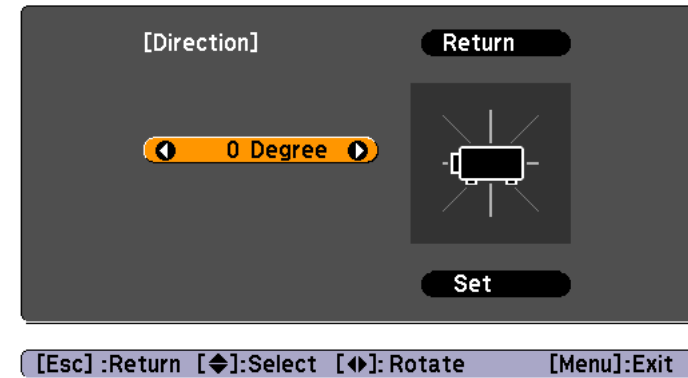

- 4 When you have finished making settings, use the [▼] button to select **Set**, and then press the [↵] button.

Changing the direction of the image (projection mode)

You can change the direction of the image using **Projection** mode from the Configuration menu.

☛ **Extended - Projection** p.86

When Front is the standard, the image directions for each projection mode are as follows.

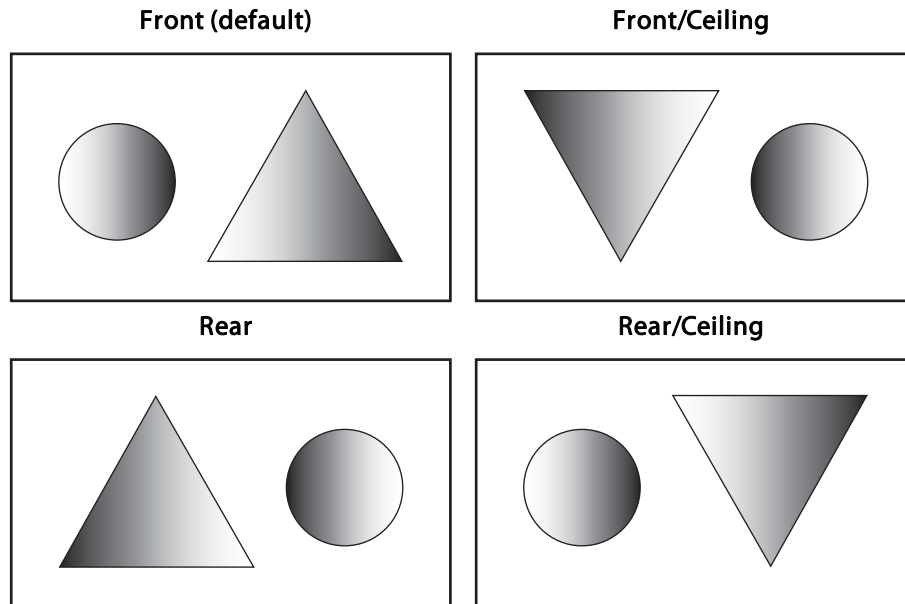

- You can change the setting as follows by pressing down the [A/V Mute] button on the remote control for about five seconds.
Front ↔ Front/Ceiling
- Make sure you check the **Direction** setting when you change the projector's installation position.
☛ **Extended - Direction** p.86

Screen Settings

Set the Screen Type according to the aspect ratio of the screen being used.
The area where the image is displayed matches the shape of the screen.

1 Press the [Menu] button while projecting.
☛ "Using the Configuration Menu" p.78

2 Select **Display** from **Extended**.

3 Select **Screen Type** from **Screen**.

4 Select the screen's aspect ratio.

The shape of the background test pattern changes depending on the setting.

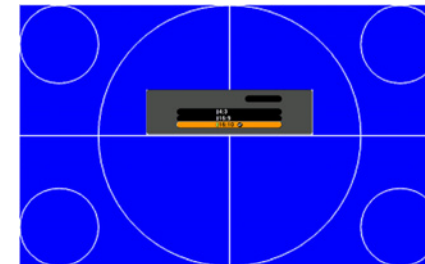

5 Press the [Menu] button to finish making settings.



- When you change the Screen Type, adjust the aspect ratio for the projected image as well.
☛ "Changing the Aspect Ratio of the Projected Image" p.47
- Make sure you install the applications EasyMP Network Projection and EasyMP Multi PC Projection from the EPSON Projector Software CD-ROM. When using older versions of the applications, images are not projected correctly. You can download the latest versions of EasyMP Network Projection and EasyMP Multi PC Projection from the following Web site.
<http://www.epson.com/>
- This function does not support Message Broadcasting (an EasyMP Monitor plugin).

Adjusting the position of the image on the projected screen

You can adjust the position of the image if there are margins between the edge of the image and the projected screen frame due to the Screen Type setting.

Example: When the **Screen Type** is set to **4:3** for EB-G6750WU



You can move the image to the left and right.

- 1** Press the [Menu] button while projecting.
 ☛ "Using the Configuration Menu" [p.78](#)
- 2** Select **Display** from **Extended**.
- 3** Select **Screen Position** from **Screen**.
- 4** Use the [▲], [▼], [◀], and [▶] buttons to adjust the position of the image.

You can check the current display position by using the background test pattern.

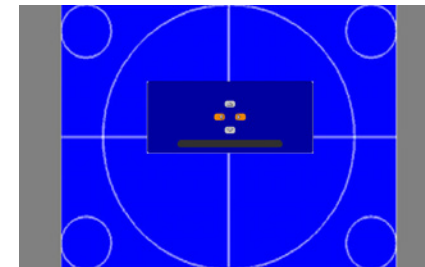

- 5** Press the [Menu] button to finish making settings.



The **Screen Position** cannot be adjusted in the following situations.

- If the **Screen Type** is set to **16:10** when using EB-G6750WU/EB-G6650WU/EB-G6550WU/EB-G6450WU/EB-G6250W/EB-G6050W
- If the **Screen Type** is set to **4:3** when using EB-G6350/EB-G6150

Displaying a Test Pattern

A test pattern can be displayed to adjust the projection status without connecting video equipment.

The shape of a test pattern is according to the setting of **Screen Type**. Set **Screen Type** first.

☛ "Screen Settings" [p.22](#)

- 1** Press the [Test Pattern] button on the remote control or the [⏏] button on the control panel while projecting.

2 Press the [◀][▶] buttons on the remote control or the [↵] button on the control panel to change the test pattern.

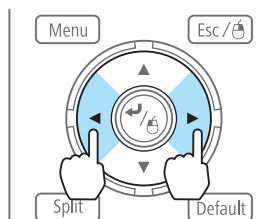

Using the remote control



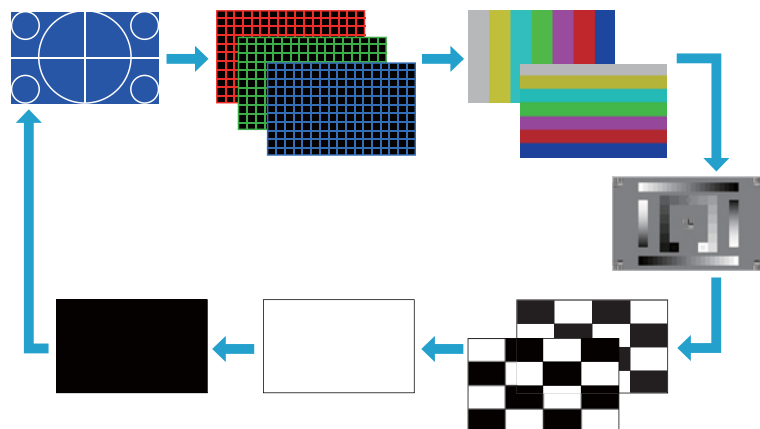
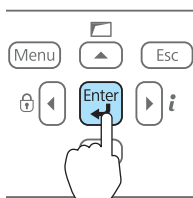

Using the control panel



The following image adjustments can be made while the test pattern is being displayed.

Top Menu Name	Sub Menu/Items
Image	Color Mode  p.46
	Abs. Color Temp.
	Advanced
	- Gamma*  p.49
	- RGB
	- RGBCMY  p.49
	Reset

Top Menu Name	Sub Menu/Items
Signal	Auto Setup
Settings	Geometric Correction  p.43
Extended	Multi-Projection
	- Brightness Level
	- Edge Blending  p.55
	- Multi-screen  p.57

* Except for custom settings of gamma



To set menu items that cannot be set while the test pattern is being displayed or to fine-tune the projected image, project an image from the connected device.

3 Press the [Esc] button to close the test pattern.

Adjusting the Position of the Projected Image (Lens Shift)

The lens can be shifted to adjust the position of the projected image, for example, when the projector cannot be installed directly in front of the screen.

1 Release the lens shift dial lock.

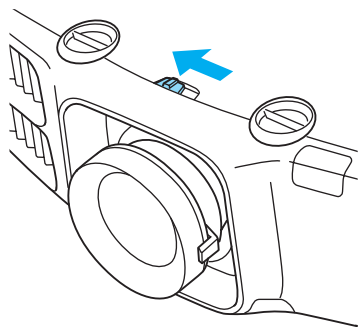

2 Turn the vertical and horizontal lens shift dials on the projector to adjust the position of the projected image.

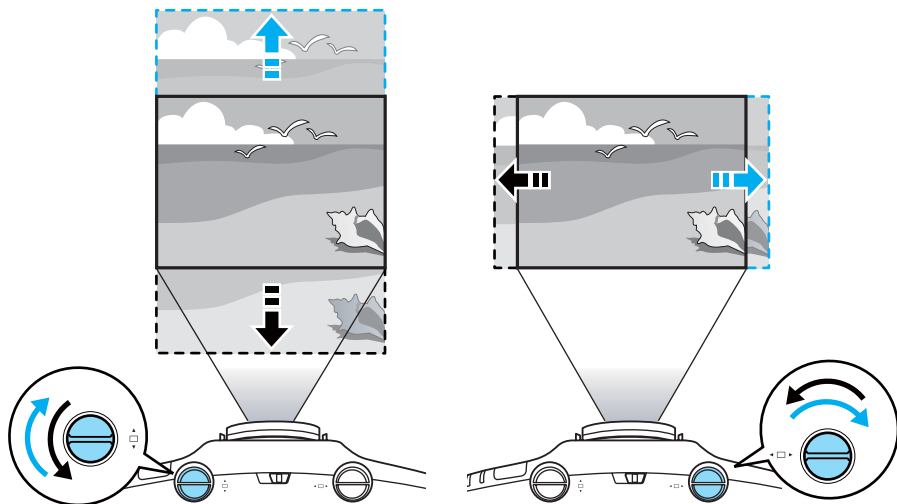

Attention

When adjusting the image height with the vertical lens shift dial, adjust by moving the image from the bottom to the top. If it is adjusted from the top to the bottom, the image position may move down slightly after adjusting.



- We recommend setting the focus, zoom, and lens shift at least 30 minutes after you start the projection, because images are not stable right after turning on the projector.
- The image will be clearest when both the vertical and horizontal lens shift are set in the center.

The ranges within which the image can be moved are shown below.

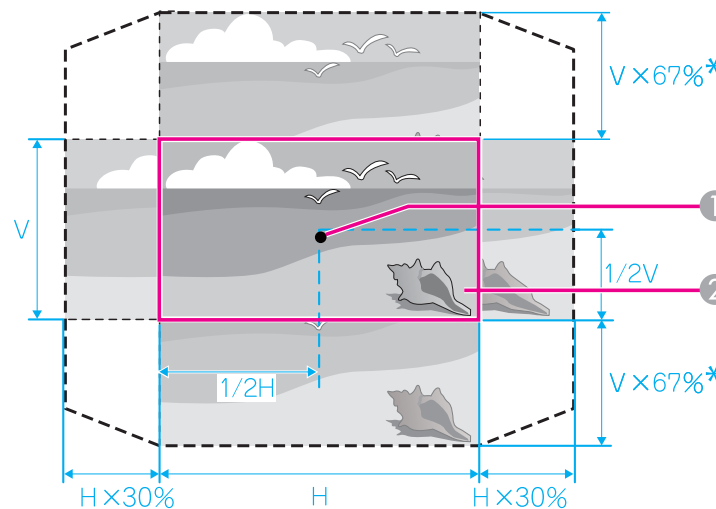

*EB-G6350/EB-G6150:57%

- ① Center of lens
- ② Projected image when lens shift is set in the center

The position of the projected image cannot be moved to both the horizontal and vertical maximum values.

3 When you have finished making adjustments, lock the lens shift dial lock.

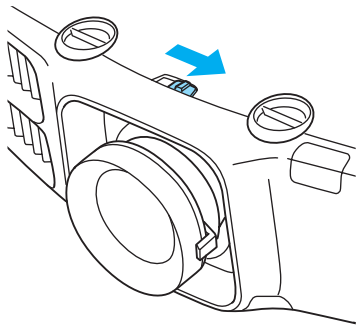

Adjusting the Image Size

Turn the zoom ring to adjust the size of the projected image.

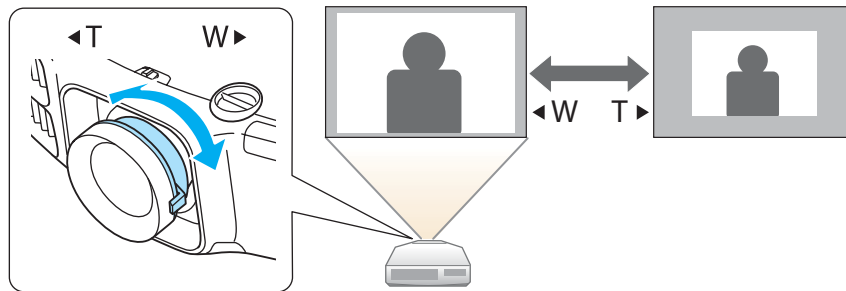

Correcting the Focus

You can correct the focus using the focus ring.

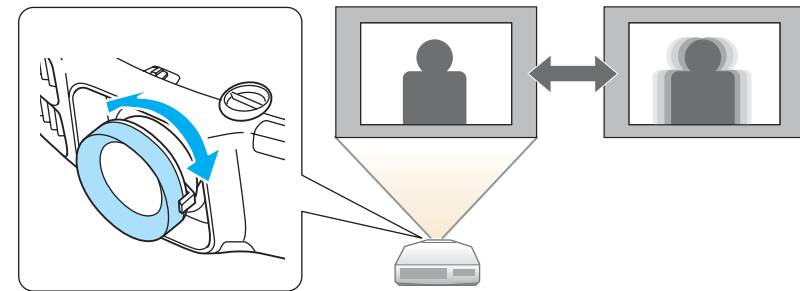

When using the short throw zoom lens ELPLU01

Follow the steps below to adjust the focus when the lens is shifted up, down, left, or right using the lens shift function.

- 1 Turn the distortion ring anti-clockwise until it cannot go any further.

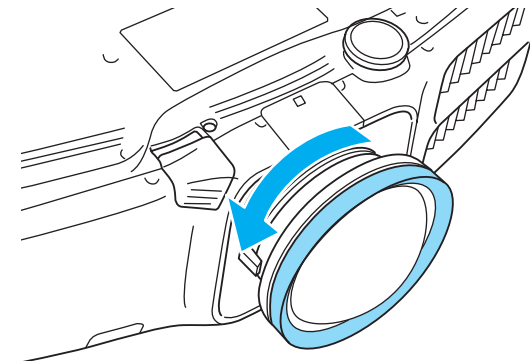

- 2 Focus the image around the axis of the lens using the focus ring. Example: When the lens shift is turned all the way down.

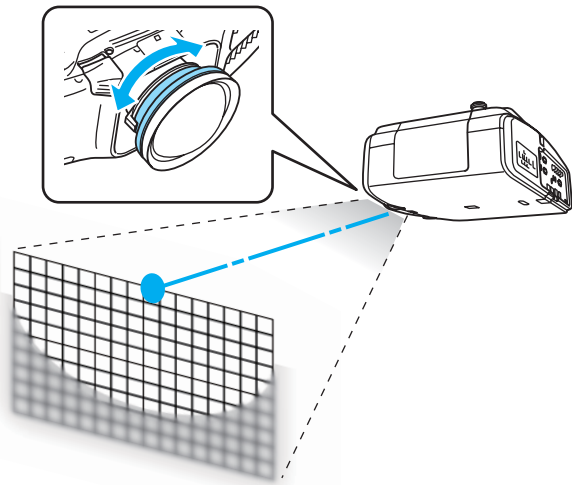

- 3** Correct screen distortion using the distortion ring.
When correcting distortion, the area around the edges of the image is also focused.

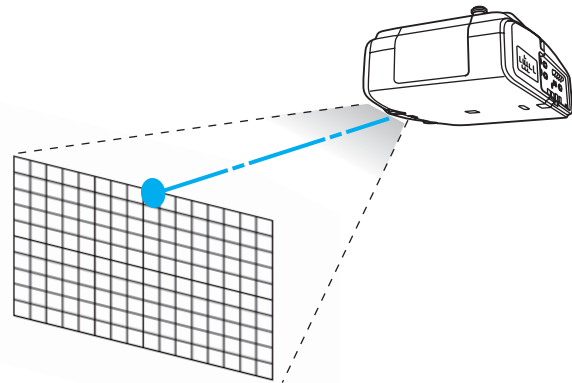

- 4** Turn the focus ring to focus the entire screen.
If the area around the lens axis is out of focus, fine-tune by turning the distortion ring.

 When using the short throw zoom lens ELPLU01, set **Lens Type** to **ELPLU01** from the Configuration menu so that keystone correction is performed correctly.

 **Extended - Operation - Lens Type p.86**

Adjusting the Image Position

Extend or retract the front foot to make adjustments. You can adjust the position of the image by tilting the projector up to 10 degrees.

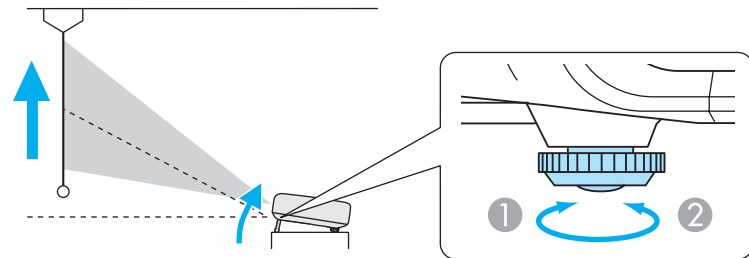

- 1 Extend the front foot.
- 2 Retract the front foot.

 The larger the angle of tilt, the harder it becomes to focus. Install the projector so that it only needs to be tilted at a small angle.

Adjusting the Horizontal Tilt

Extend and retract the rear feet to adjust the projector's horizontal tilt.

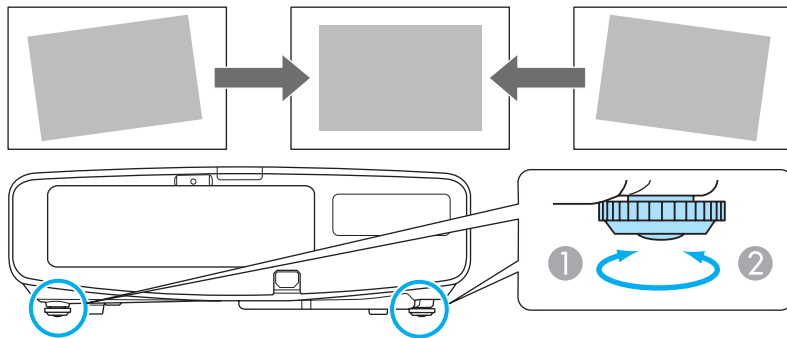

- ① Extend the rear foot.
- ② Retract the rear foot.

Attention

The rear feet can be attached and removed. Note that the feet will detach if they are extended more than 10 mm.

ID Settings

When an ID is set for the projector and the remote control, you can use the remote control to operate only the projector with a matching ID. This is very useful when managing multiple projectors.



- Operation using the remote control is possible only for projectors that are within the operating range of the remote control.
 ☛ "Remote control operating range" p.15
- When **Remote Control Type** is set to **Simple** from **Operation** in the configuration menu, you cannot set the remote control ID.
 ☛ p.86
- IDs are ignored when the projector ID is set to **Off** or the remote control ID is set to **0**.

Set the projector ID

- ① Press the [Menu] button while projecting.
 ☛ "Using the Configuration Menu" p.78
- ② Select **Multi-Projection** from **Extended**.
- ③ Select **Projector ID**, and then press the [↵] button.
- ④ Select the ID you want to set, and then press the [↵] button.

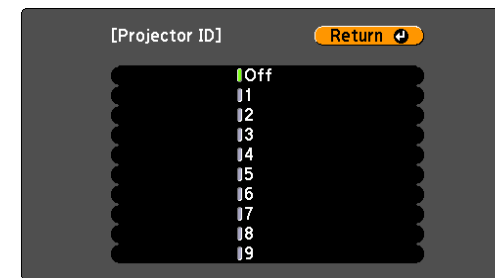

- ⑤ Press the [Menu] button to close the configuration menu.

Checking the Projector ID

During projection, press the [Help] button while holding the [ID] button.

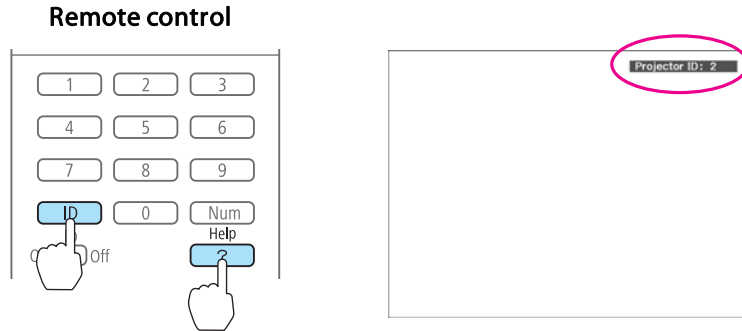

When you press the buttons, the current Projector ID is displayed on the projection screen. It disappears in about three seconds.

Setting the remote control ID

- 1 Set the remote control [ID] switch to On.

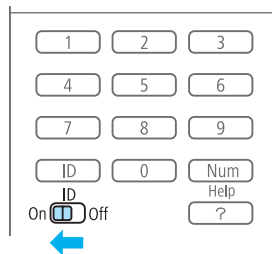

- 2 While holding the [ID] button, press a number button to select a number to match the ID of the projector you want to operate.

☛ "Checking the Projector ID" p.29

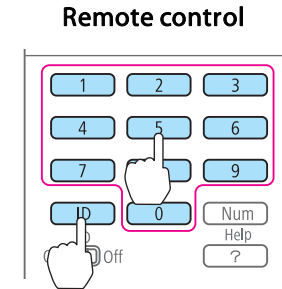

Once this setting has been made, the projector that can be operated by the remote control is limited.



The remote control ID setting is saved in the remote control. Even if the remote control batteries are removed to replace them and so on, the stored ID setting is retained. However, if the batteries are left out for a long time, it is reset to the default value (ID0).



Setting the Time

You can set the time for the projector. The set time is used for scheduling and for wireless LAN authentication.

☛ "Scheduling Function" p.69



- When you turn on the projector for the first time, the message "Do you want to set the time?" is displayed. When you select **Yes**, the screen from step 4 is displayed.
- When **Time/Schedule Protection** is set to **On** in **Password Protection**, settings related to the date and time cannot be changed. You can make changes after setting **Time/Schedule Protection** to **Off**.
 "Managing Users (Password Protection)" [p.72](#)

- 1** Press the [Menu] button while projecting.
 "Using the Configuration Menu" [p.78](#)
- 2** Select **Operation** from **Extended**.
- 3** Select **Date & Time**, and then press the [**↵**] button.
- 4** Make settings for the date and time.
 Use the soft keyboard to enter the date and time.
 "Soft keyboard operations" [p.91](#)

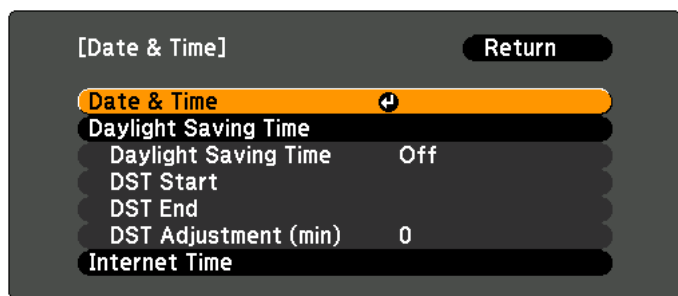

Date & Time

Submenu	Function
Date	Set today's date.
Time	Set the current time.

Submenu	Function
Time Difference (UTC)	Set the time difference from Coordinated Universal Time.
Set	The settings made in Date & Time are applied.

Daylight Saving Time

Submenu	Function
Daylight Saving Time	Set whether or not (On/Off) to activate the daylight saving time. DST Adjustment (min) adjusts the time difference between the standard time and the daylight saving time.
DST Start	Set the date and time to start the daylight saving time.
DST End	Set the date and time to end the daylight saving time.
Set	The settings made in Daylight Saving Time are applied.

Internet Time

Submenu	Function
Internet Time	Set to On to update the time automatically through an Internet time server.
Internet Time Server	Input the IP address for an Internet time server.
Set	The settings made in Internet Time are applied.



When changing settings, make sure you select **Set**, and then press the [**↵**] button.

- 5** Press the [Menu] button to finish making settings.

The port name, location, and connector orientation differ depending on the source being connected.

Connecting a Computer

To project images from a computer, connect the computer using one of the following methods.

① **When using the supplied computer cable**

Connect the computer's display output port to the projector's Computer port.

You can output audio from the projector's speaker by connecting the audio output port on the computer to the projector's Audio1 port using a commercially available audio cable.

② **When using a commercially available 5BNC cable**

Connect the computer's display output port to the projector's BNC port.

You can output audio from the projector's speaker by connecting the audio output port on the computer to the projector's Audio2 port using a commercially available audio cable.

③ **When using a commercially available HDMI cable**

Connect the HDMI port on the computer to the projector's HDMI port.

You can send the computer's audio with the projected image.

④ **When using a commercially available DisplayPort cable**

Connect the computer's DisplayPort to the projector's DisplayPort.

You can send the computer's audio with the projected image.

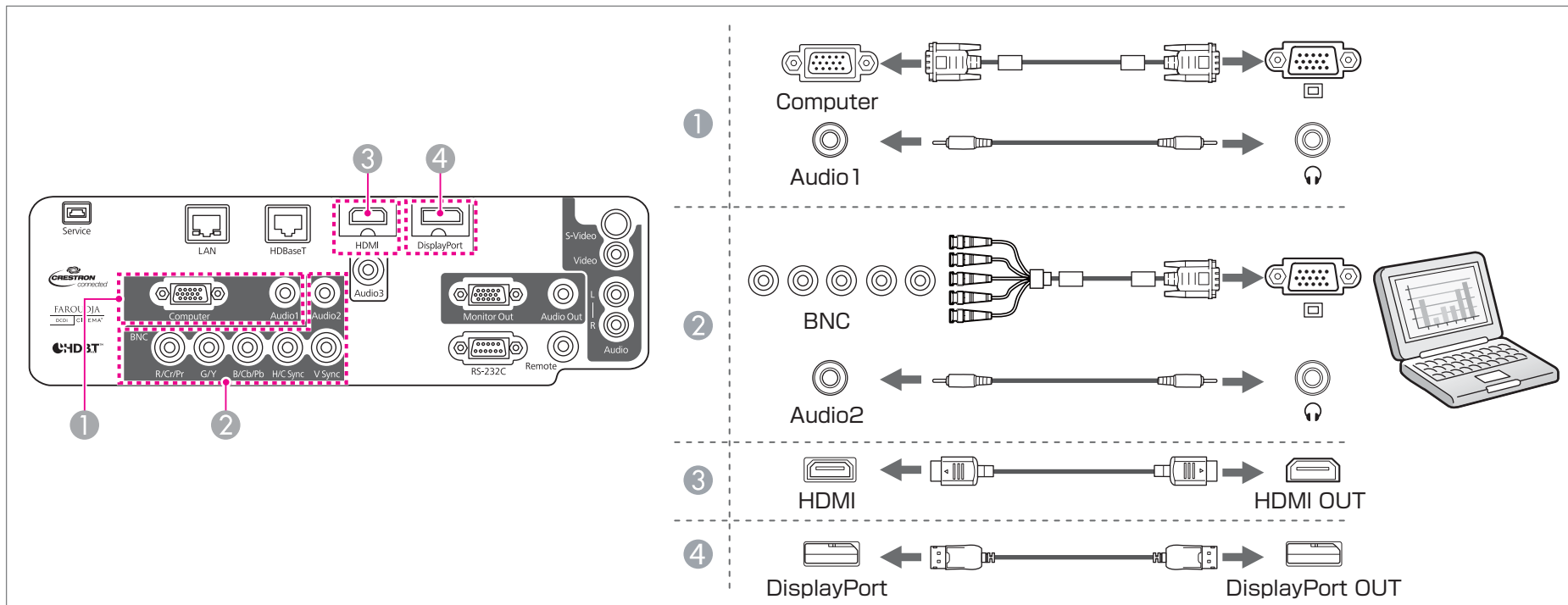

- Change the audio output from **Audio Settings**.
 ➔ **Extended - A/V Settings - Audio Settings p.86**
- If audio is not sent using an HDMI or DisplayPort cable, connect a commercially available audio cable to the Audio3 port to send the audio. Set **HDMI Audio Output** or **DisplayPort Audio Output** to **Audio3**.
 ➔ **Extended - A/V Settings - Audio Settings - HDMI Audio Output, DisplayPort Audio Output p.86**
- Some commercially available DisplayPort cables come with a lock. When removing the cable, press the button on the cable's connector section and pull out the cable.

Connecting Image Sources

To project images from DVD players or VHS video and so on, connect to the projector using one of the following methods.

① **When using a commercially available video cable**

Connect the video output port on the image source to the projector's Video port.

You can output audio from the projector's speaker by connecting the audio output port on the image source to the projector's Audio-L/R port using a commercially available audio cable.

② **When using a commercially available S-video cable**

Connect the S-video output port on the image source to the projector's S-Video port.

You can output audio from the projector's speaker by connecting the audio output port on the image source to the projector's Audio-L/R port using a commercially available audio cable.

③ **When using an optional component video cable (D-sub/component converter)**

☛ "Optional Accessories" [p.156](#)

Connect the component output port on the image source to the projector's Computer port.

You can output audio from the projector's speaker by connecting the audio output port on the video equipment to the projector's Audio1 port using a commercially available audio cable.

④ **When using a commercially available component video cable (RCA) and a BNC/RCA adapter**

Connect the component output port on the video equipment to the projector's BNC port (R/Cr/Pr, G/Y, B/Cb/Pb).

You can output audio from the projector's speaker by connecting the audio output port on the video equipment to the projector's Audio2 port using a commercially available audio cable.

⑤ **When using a commercially available HDMI cable**

Connect the HDMI port on the image source to the projector's HDMI port.

You can send the image source's audio with the projected image.

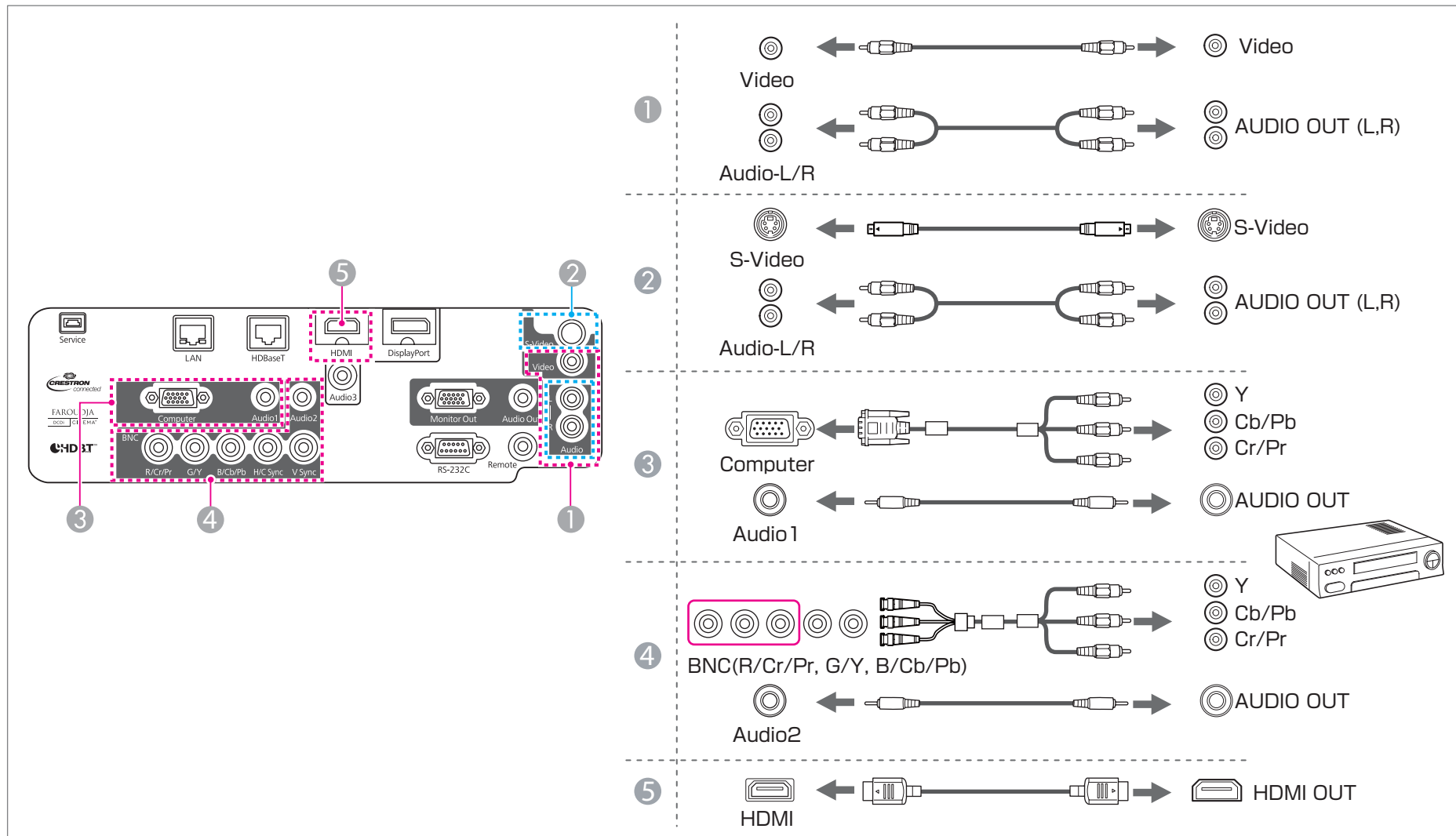

Attention

- If the input source is on when you connect it to the projector, it could cause a malfunction.
- If the orientation or shape of the plug differs, do not try to force it in. The device could be damaged or could malfunction.



- Change the audio output from **Audio Settings**.
 ➔ **Extended - A/V Settings - Audio Settings** [p.86](#)
- If audio is not sent using an HDMI cable, connect a commercially available audio cable to the Audio3 port to send the audio. Set **HDMI Audio Output** to **Audio3**.
 ➔ **Extended - A/V Settings - Audio Settings - HDMI Audio Output** [p.86](#)
- If the source you want to connect to has an unusually shaped port, use the cable supplied with the device or an optional cable to connect to the projector.
- When using a commercially available 2RCA(L/R)/stereo mini-pin audio cable, make sure it is labeled "No resistance".

Connecting External Equipment

You can output images and audio by connecting an external monitor or speaker.

1 When outputting images to an external monitor

Connect the external monitor to the projector's Monitor Out port using the cable supplied with the external monitor.

2 When outputting audio to an external speaker

Connect the external speaker to the projector's Audio Out port using a commercially available audio cable.

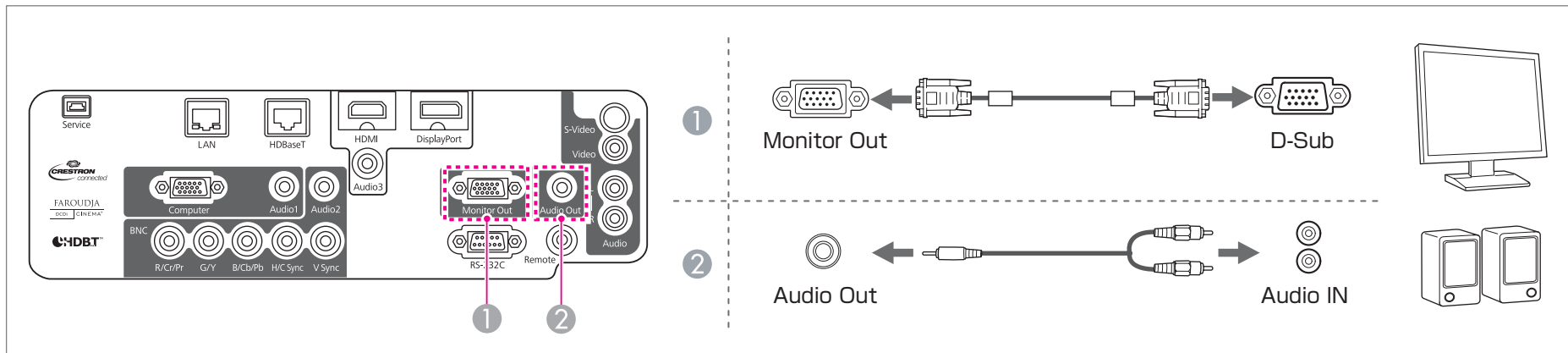



- Make the following settings to output image and audio even when the projector is in standby mode.
Set **Standby Mode** to **Communication On**.
 - ☛ **Extended - Standby Mode** [p.86](#)
- Set **A/V Output** to **Always On**.
 - ☛ **Extended - A/V Settings - A/V Output** [p.86](#)
- When the audio cable jack is inserted into the Audio Out port, audio stops being output from the projector's built-in speakers and switches to external output.

Connecting a LAN Cable

Connect a LAN port on network hubs or other equipment to the projector's LAN port with a commercially available 100BASE-TX or 10BASE-T LAN cable.

By connecting a computer to the projector over a network, you can project images and check the status of the projector.

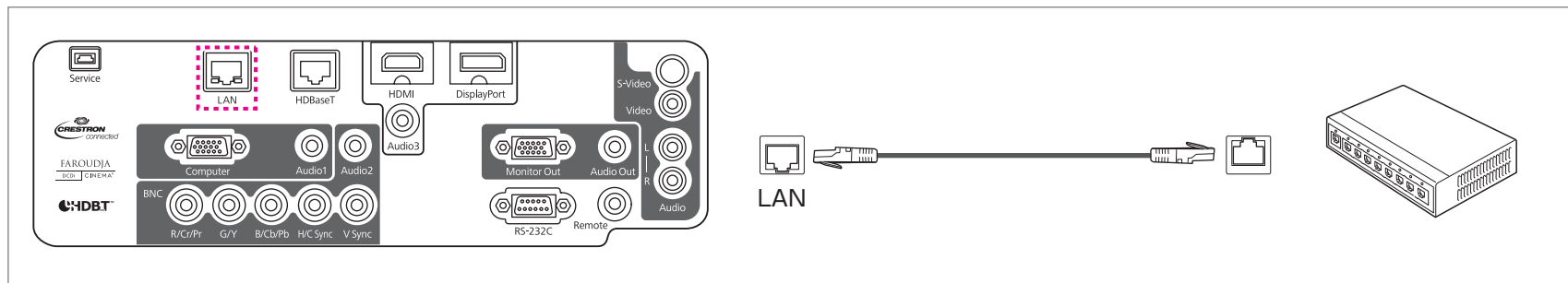

To prevent malfunctions, use a category 5 or higher shielded LAN cable.

Connecting an HDBaseT Transmitter (EB-G6750WU Only)

Connect the optional HDBaseT Transmitter with a commercially available 100BASE-TX LAN cable.

☛ "Optional Accessories" [p.156](#)

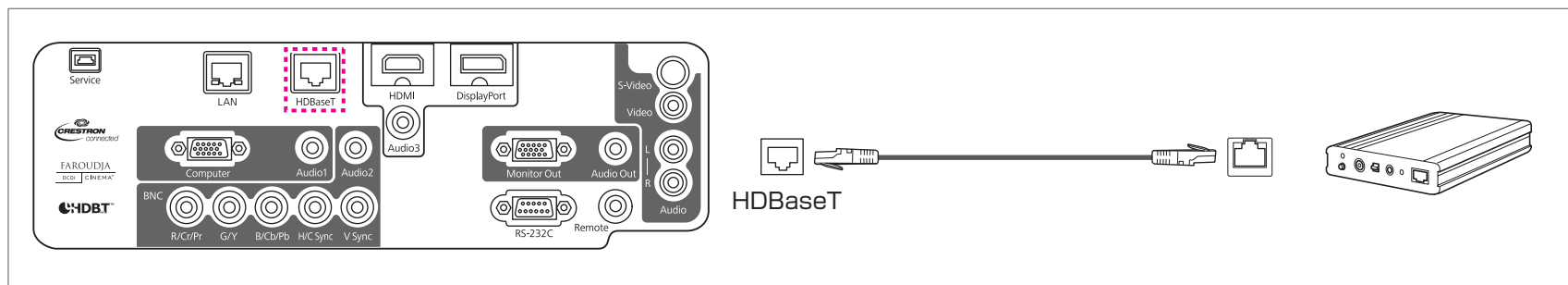

- Make sure you read the User's Guide supplied with the HDBaseT transmitter carefully before use.
 - Use a category 5e or category 6 shielded LAN cable.
 - When connecting or disconnecting the LAN cable, make sure you turn off the power for the projector and the HDBaseT transmitter.
 - When performing Ethernet communication or serial communication, or when using the wired remote control via HDBaseT port, set **Control Communications** to **On** from the Configuration menu.
 - ☛ **Extended - HDBaseT - Control Communications** [p.86](#)
- Note that when **Control Communications** is set to **On**, the projector's LAN port, RS-232C port, and Remote port are disabled.

Installing the Wireless LAN Unit

- 1** Open the air filter cover.
Slide the air filter cover operation knob, and open the air filter cover.

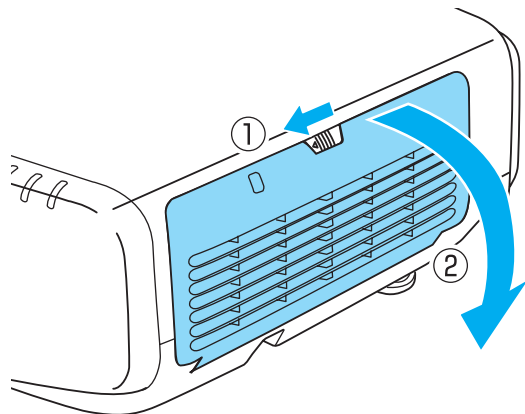

- 2** Remove the stopper for the Wireless LAN unit.

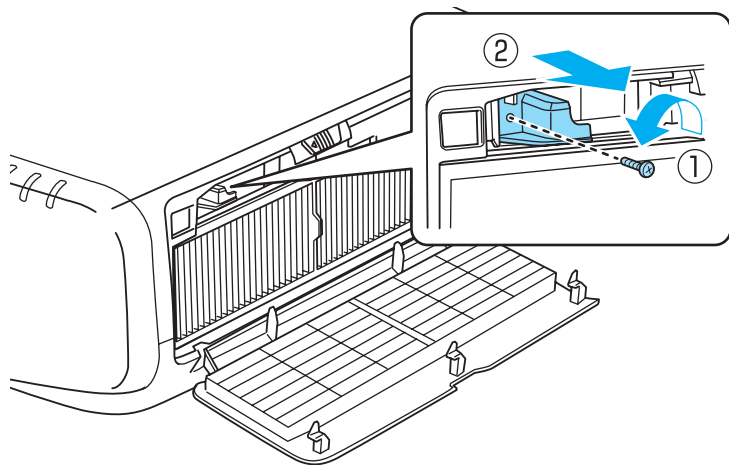

- 3** Install the Wireless LAN unit.

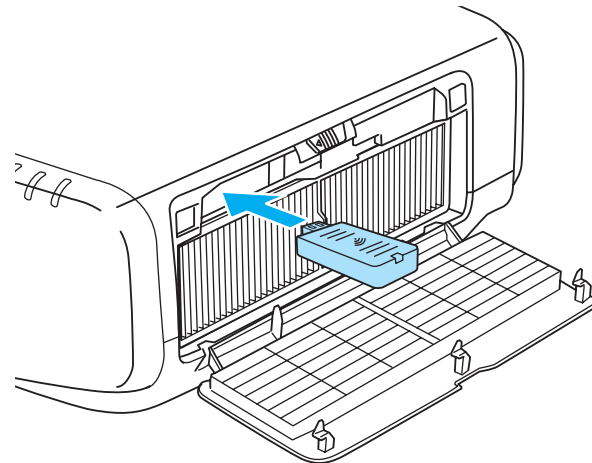

- 4** Secure the stopper with a screw.

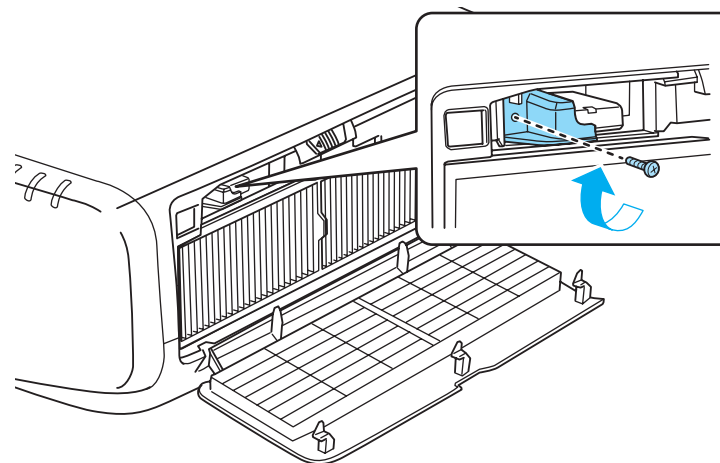

- 5** Close the air filter cover.

Attaching the Cable Cover

By attaching the cable cover, you can hide the connected cables giving a nice, clean finish to the projector installation. (The illustrations are of a projector installed on a ceiling.)

Attaching

- 1** Bundle the cables together with a commercially available tie.

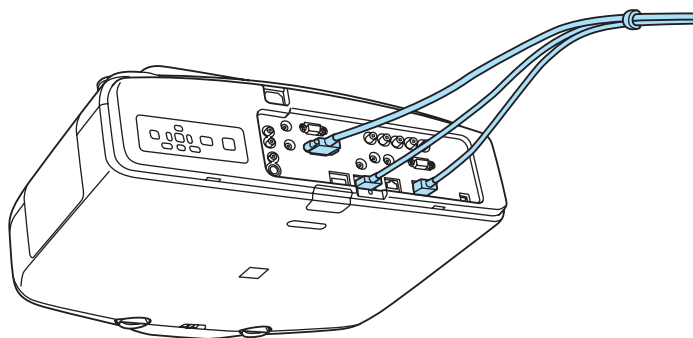

- 2** Insert the tabs on the cable cover into the two slots on the back of the projector.

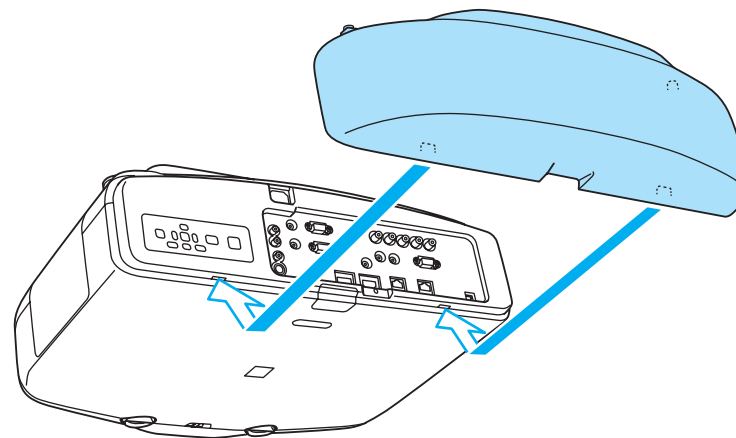

- 3** Tighten the two screws on the cable cover. (You can tighten the screws with your fingers.)

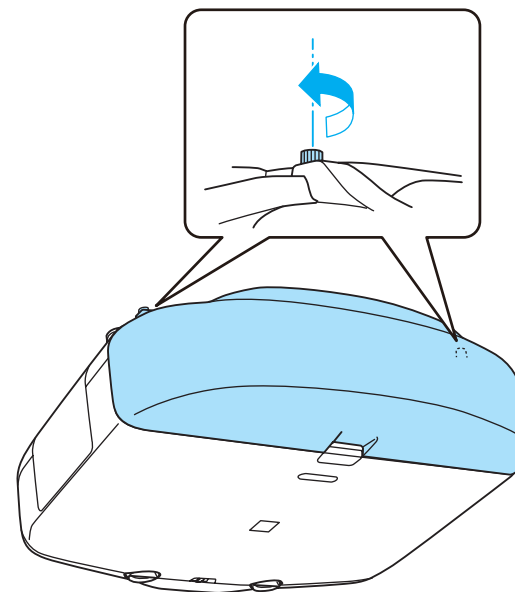



Basic Usage

This chapter explains how to project and adjust images.

Automatically Detect Input Signals and Change the Projected Image (Source Search)

Press the [Search] button on the remote control or the [Source Search] button on the control panel to project images from the port currently receiving an image.

Using the remote control

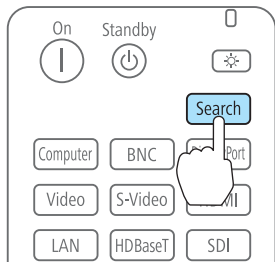

Using the control panel

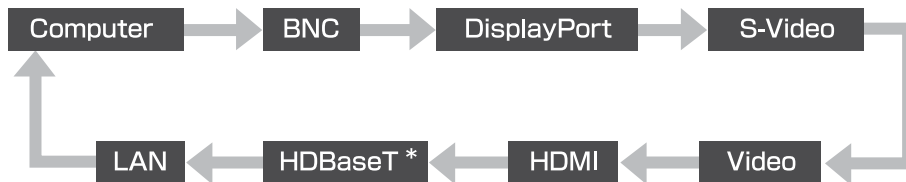
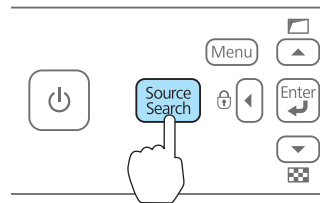

*EB-G6750WU only

When two or more image sources are connected, press the [Search] button on the remote control or the [Source Search] button on the control panel until the target image is projected.

When your video equipment is connected, start playback before beginning this operation.



The following screen is displayed while no image signals are input.

[Source Search]

	Signal Status
Computer	Off
BNC	Off
DisplayPort	Off
S-Video	Off
Video	Off
HDMI	Off
HDBaseT	Off
LAN	Off

· Input an image signal.
· Press to select the source.

[Left Arrow]:Select [Enter]:Enter [Esc]:Exit

Switching to the Target Image by Remote Control

You can change directly to the target image by pressing the following buttons on the remote control.

The input ports for each button are shown below.

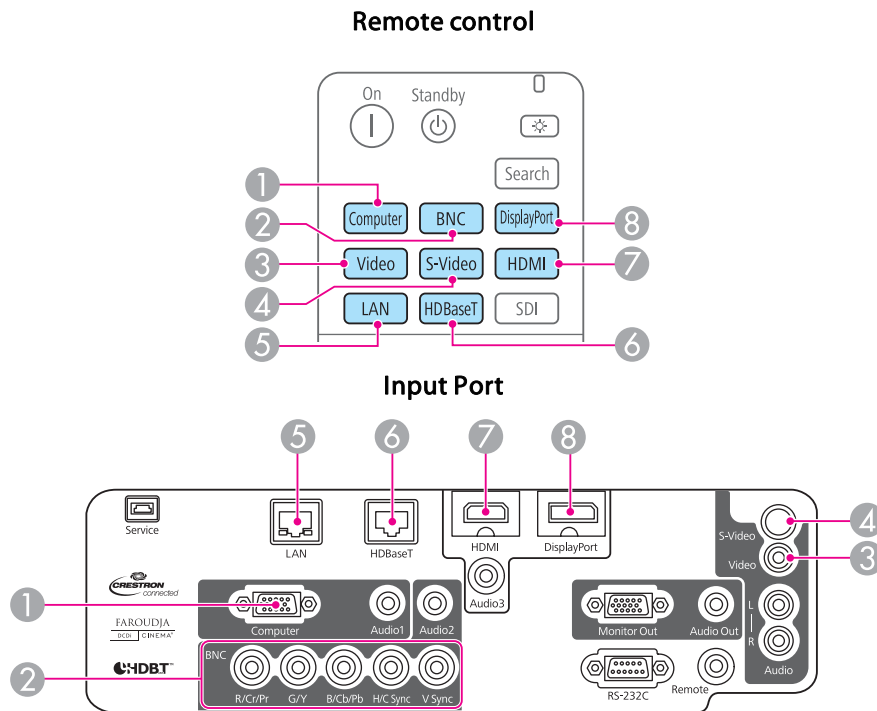

- 5 Changes to images from a computer connected via the network.
- 6 EB-G6750WU only

Adjusting the Volume

You can adjust the volume using one of the following methods.

- Press the [Volume] button on the remote control to adjust the volume.
 - [<] Decreases the volume.
 - [>] Increases the volume.

Remote control

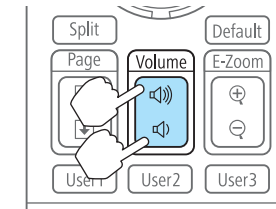

- Adjust the volume from the Configuration menu.
 - ☛ **Settings - Volume p.84**

Caution

Do not start at high volume.
A sudden excessive volume may cause loss of hearing. Always lower the volume before powering off, so that you can power on and then gradually increase the volume.

Correcting Distortion in the Projected Image

You can correct keystone distortion in projected images using one of the following methods.

- H/V-Keystone

Manually correct distortion in the horizontal and vertical directions independently.

☛ "H/V-Keystone" [p.43](#)

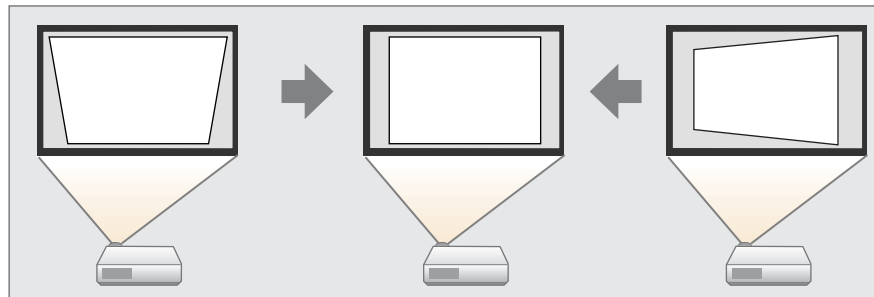

- Quick Corner

Manually correct the four corners independently.

☛ "Quick Corner" [p.44](#)

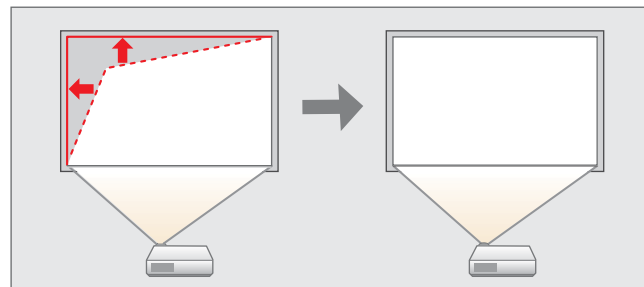

- Arc Correction

Fine adjustment of the curved distortion caused by slack or shrinkage of the screen.

☛ "Arc Correction" [p.45](#)

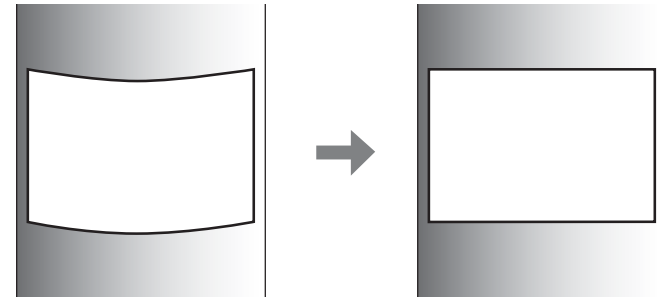

- Point Correction

Corrects slight distortion which occurs partially, or adjusts the image position in an overlapping area when projecting from multiple projectors.

☛ "Point Correction" [p.53](#)



- By pressing the [] button on the control panel, you can perform the selected adjustment method directly.
- You cannot combine multiple adjustment methods.

H/V-Keystone

Manually correct distortion in the horizontal and vertical directions independently. The angle of vertical and horizontal tilt for the projector can be corrected up to 30 degrees against the screen.

- 1 Press the [Menu] button while projecting.
- 2 Select **Geometric Correction** from **Settings**.

- 3 Select **H/V-Keystone**, and then press the [↵] button.
If the message "If this setting is changed, the image may be distorted." is displayed, press the [↵] button.

- 4 Use the [▲][▼] buttons to select the correction method, and then use the [◀][▶] buttons to make the corrections.

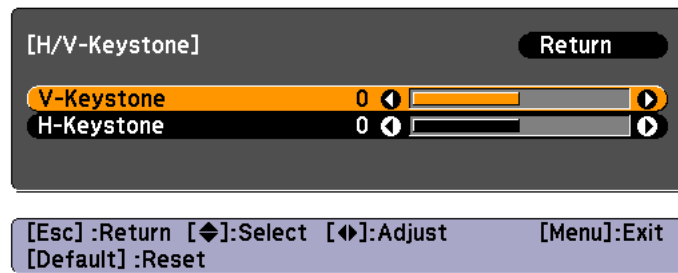

V-Keystone

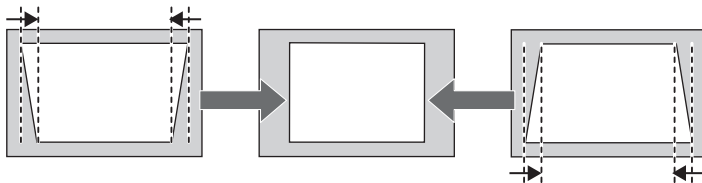

H-Keystone

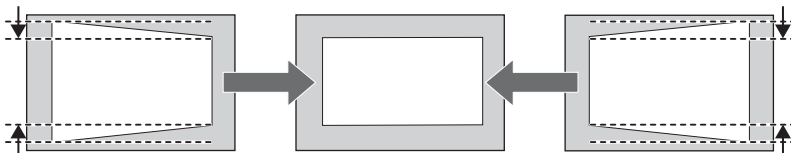

When you correct keystone distortion, the projected image may be reduced.

- 5 When you are done, press the [Menu] button to exit the correction menu.

Quick Corner

This allows you to manually correct each of the four corners of the projected image separately.

- 1 Press the [Menu] button while projecting.
- 2 Select **Geometric Correction** from **Settings**.
- 3 Select **Quick Corner**, and then press the [↵] button.
If the message "If this setting is changed, the image may be distorted." is displayed, press the [↵] button.
- 4 Use the [▲], [▼], [◀], and [▶] buttons to select the corner you want to adjust, and then press the [↵] button.

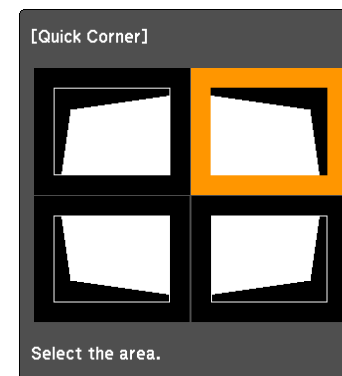

[◆/◀]:Select
[◆]:Enter
[Esc]:Return (press for 2 seconds to reset/switch)



If the [Esc] button is pressed for at least 2 seconds, the confirm default reset screen is displayed.

Select **Yes** to reset the result of Quick Corner corrections.

- 5 Use the [▲], [▼], [◀], and [▶] buttons to correct the position of the corner.

When you press the [↵] button, the screen shown in step 4 that allows you to select the area to be corrected is displayed.

If the message "Cannot adjust any further." is displayed while adjusting, you cannot adjust the shape any further in the direction indicated by the gray triangle.

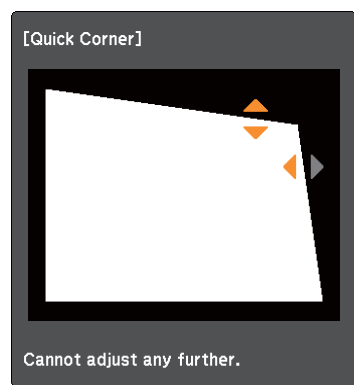

[◀/▶]: Adjust
[Esc]/[⏪]: Return

- 6 Repeat procedures 4 and 5 as needed to adjust any remaining corners.
- 7 When you are done, press the [Menu] button to exit the correction menu.

Arc Correction

- 1 Press the [Menu] button while projecting.
- 2 Select **Geometric Correction** from **Settings**.
- 3 Select **Arc Correction**, and then press the [↵] button. If the message "If this setting is changed, the image may be distorted." is displayed, press the [↵] button.
- 4 Use the [▲], [▼], [◀], and [▶] buttons to select the area you want to adjust, and then press the [↵] button.

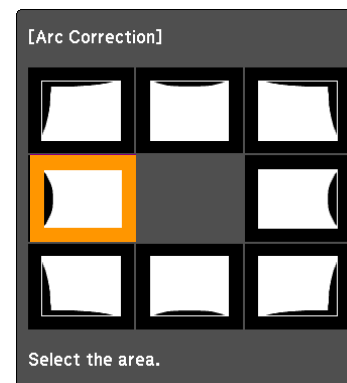

When selecting a corner, you can adjust the two sides next to the corner.



If the [Esc] button is pressed for at least 2 seconds, the confirm default reset screen is displayed.

Select **Yes** to reset the result of Arc Correction.

- 5 Use the [▲], [▼], [◀], and [▶] buttons to adjust the shape.

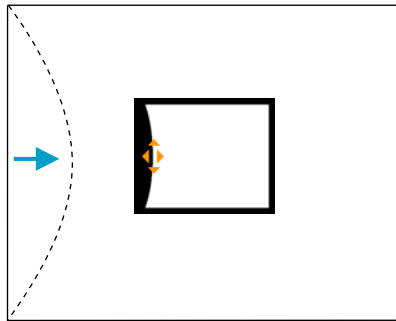

If the triangle in the direction you are adjusting the shape turns gray, as shown in the screenshot below, you cannot adjust the shape any further in that direction.

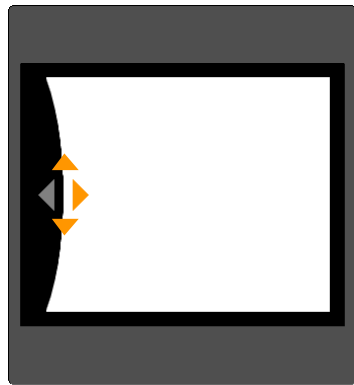

- 6** Press the [Esc] button to return to the previous screen.
- 7** Repeat procedures from 4 to 6 as needed to adjust any remaining parts.
- 8** When you are done, press the [Menu] button to exit the correction menu.

Selecting the Projection Quality (Selecting Color Mode)

You can easily obtain the optimum image quality simply by selecting the setting that best corresponds to your surroundings when projecting. The brightness of the image varies depending on the mode selected.

Mode	Application
Dynamic	Ideal for use in a bright room. This is the brightest mode.
Presentation	Ideal for making presentations using color materials in a bright room.
Theatre	Ideal for watching films in a dark room. Gives images a natural tone.
Photo*1	Ideal for projecting still pictures, such as photos, in a bright room. The images are vivid and brought into contrast.
Sports*2	Ideal for watching TV programmes in a bright room. The images are vivid and brought to life.
sRGB	Ideal for images that conform to the <u>sRGB</u> color standard.
DICOM SIM*1	Ideal for projecting X-ray photographs and other medical images. This produces images with clear shadows. The projector is not a medical device and cannot be used for medical diagnosis.
Multi-Projection	Ideal for projecting from multiple projectors. Minimize the color tone difference between each projected image.

*1 This can only be selected when inputting RGB signals, or when LAN is selected as the input source.

*2 This can only be selected when inputting component video signals, or when the source is Video or S-Video.

Each time you press the [Color Mode] button, the Color Mode name is displayed on the screen and the Color Mode changes.

Remote control

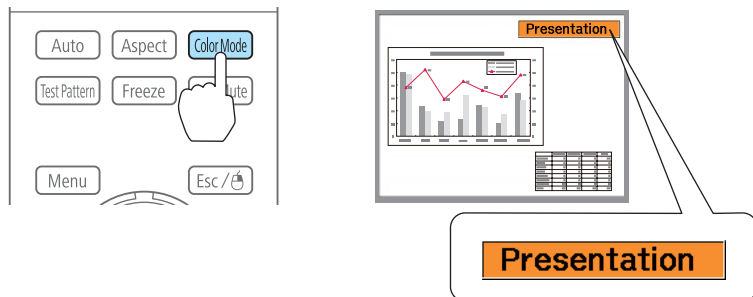

 You can set Color Mode from the Configuration menu.
 🖱️ **Image - Color Mode** [p.81](#)

Projecting 3D images

By using two projectors, you can project passive 3D images. You need the following optional items to project and view 3D images. Make sure you read the notes in the user's guides supplied with the optional items.

- Polarizer (ELPPL01)
- Passive 3D Glasses (ELPGS02A/ELPGS02B)
- 🖱️ "Optional Accessories" [p.156](#)

When projecting 3D images, set **3D Images** to **On** from the Configuration menu.

🖱️ **Signal - 3D Setup - 3D Images** [p.82](#)

The following color modes are available when projecting 3D images. When projecting using the optional polarizers (ELPPL01), you can view images at their optimal color tint.

- 3D Dynamic

- 3D Presentation
- 3D Theatre
- 3D Multi-Projection

 This projector arranges the direction of polarizing projection for R (red), G (green), and B (blue). It is not necessary to inverse left and right eye G (green) image signals.

Changing the Aspect Ratio of the Projected Image

You can change the Aspect Ratio of the projected image to suit the type, the ratio of height and width, and the resolution of the input signals.

Available aspect modes vary depending on the Screen Type currently set.

 Set the **Screen Type** before changing the aspect ratio.
 🖱️ "Screen Settings" [p.22](#)

Changing methods

Each time you press the [Aspect] button on the remote control, the aspect mode name is displayed on the screen and the aspect ratio changes.

Remote control

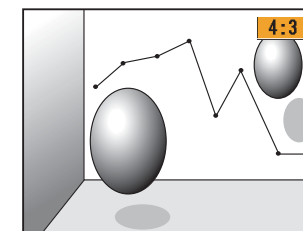
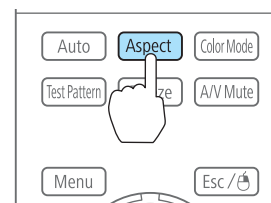

The aspect mode changes as follows.

Screen Type: 4:3

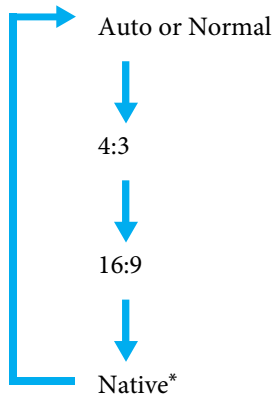

*Only computer images and images from the HDMI port/HDBaseT port

Screen Type: 16:9

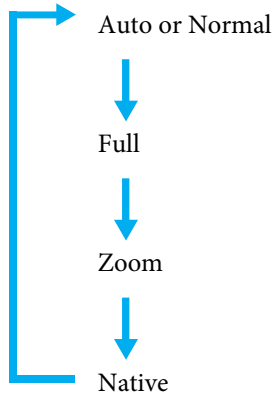

Screen Type: 16:10

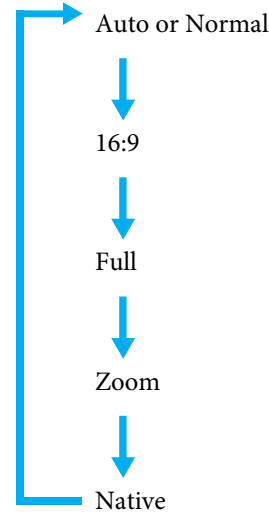

Aspect Mode	Explanation
Auto	Projects in an appropriate aspect ratio based on information from the signal being input.
Normal	Projects while retaining the aspect ratio of the input image.
4:3	Projects at an aspect ratio of 4:3.
16:9	Projects at an aspect ratio of 16:9.
Full	Projects at the full size of the projected screen.
Zoom	Projects by enlarging the input image to the full width of the projected screen while retaining the aspect ratio. Areas that exceed the edges of the projected screen are not projected.
Native	Projects to the center of the projected screen at the resolution of the input image. Areas that exceed the edges of the projected screen are not projected.



- You can also set the aspect ratio from the Configuration menu.
 - ☛ **Signal - Aspect** p.82
- If parts of the computer image are missing, set the **Resolution** setting to **Wide** or **Normal** from the Configuration menu, according to the resolution of the computer.
 - ☛ **Signal - Resolution** p.82

Adjusting the Image

Hue, Saturation, and Brightness Adjustment

The Hue, Saturation, and Brightness for each of the R (red), G (green), B (blue), C (cyan), M (magenta) and Y (yellow) color components can be adjusted.

Make settings from the configuration menu.

- ☛ **Image - Advanced - RGBCMY** p.81

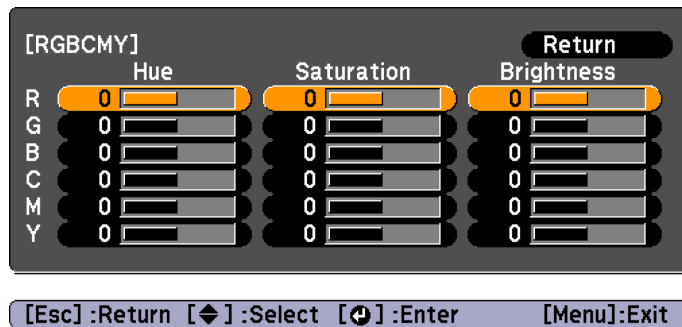

Gamma Adjustment

Adjusts differences in the coloring for the projected image that occurs depending on the connected device.

Make settings from the configuration menu.

- ☛ **Image - Advanced - Gamma** p.81

Select and adjust the correction value

- ☛ **Image - Advanced - Gamma** p.81

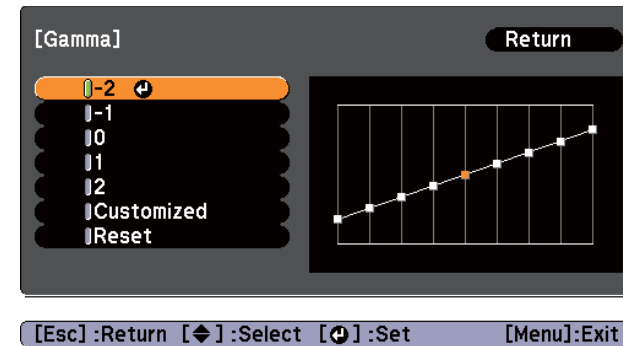

When a smaller value is selected, the dark areas of images become brighter, but the color saturation for lighter areas may become weaker. When a larger value is selected, you can reduce the overall brightness of the image to make the image sharper.

If you select **DICOM SIM** from **Color Mode** on the **Image** menu, select the adjustment value according to the projection size.

- If the projection size is 120 inches or less, select a large value.
- If the projection size is 120 inches or more, select a small value.



Medical images may not be reproduced correctly according to your settings and screen specifications.

Adjust while viewing the image

- ☛ **Image - Advanced - Gamma - Customized - Adjust it from the image** p.81

Move the cursor on the projected image to the part where you want to change the brightness, then press the [↵] button. Use the [▲][▼] buttons to adjust the value.

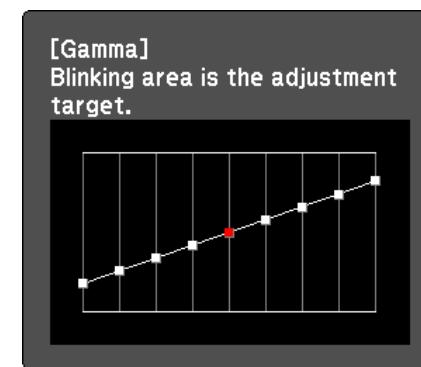
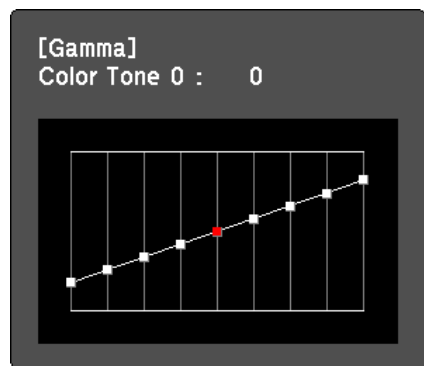
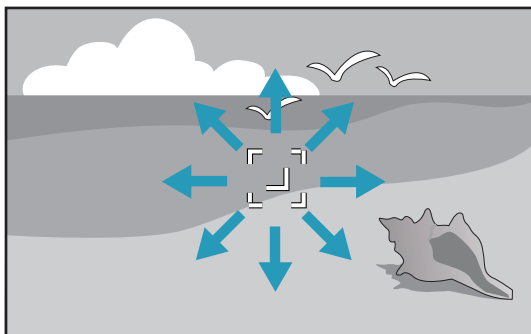

Frame Interpolation (EB-G6750WU/EB-G6650WU/EB-G6550WU/EB-G6450WU only)

The current and previous frames are used to create intermediate frames, interpolating to produce smooth-moving images. You can resolve clumsy-moving images, such as frame skipping when projecting a fast moving image.

Make settings from the configuration menu.

☛ **Signal - Frame Interpolation** [p.82](#)

Adjust using the gamma adjustment graph

☛ **Image - Advanced - Gamma - Customized - Adjust it from the graph** [p.81](#)

Adjust while looking at the gamma adjustment graph.

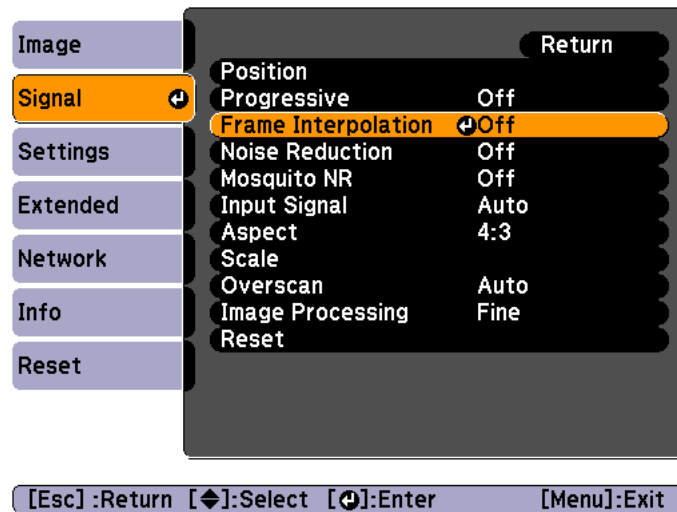

You can select the level of interpolation: **Low**, **Normal** or **High**. Set to **Off** if noise occurs after setting them.



Useful Functions

This chapter explains useful tips for giving presentations, and the Security functions.

When projecting to a wide screen from multiple projectors, you can adjust the difference of brightness and color tone between each projected image to create a seamless screen.

There are two general methods of projecting from multiple projectors.

- Ⓐ Projecting different images from each projector, and creating a seamless screen

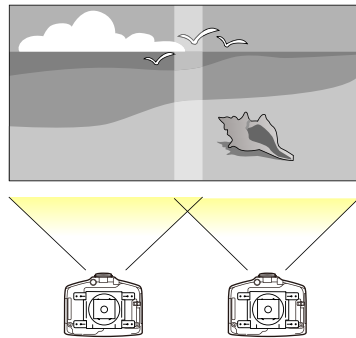

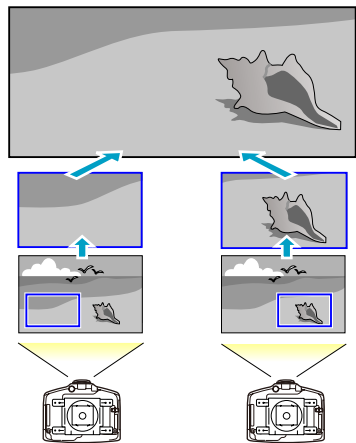

- Ⓑ Projecting the same image from each projector, using the Scale function to project a large image



Here we will take Ⓐ as an example.





The steps for Ⓑ are the same, but use the Scale function to adjust the position of the projected image.  [p.58](#)

Follow the steps below.

1. Set an ID for the projector and the remote control  [p.28](#)
2. Adjust the position of the projected image  [p.53](#)
3. Checking the Color Mode
4. Adjust the edges of the images (edge blending)  [p.55](#)
5. Adjusting to match colors

Adjusting the Position of the Projected Image

Adjust the position of the projected image, starting from the adjustments that have larger corrections.

1. Projector's position (angle)  [p.20](#)
2. Lens shift/Zoom  [p.24](#)
3. Geometric Correction
 - Quick Corner  [p.44](#)
 - Point Correction  [p.53](#)



- We recommend setting the focus, zoom, and lens shift at least 30 minutes after you start the projection, because images are not stable right after turning on the projector.
- The Test Pattern can be displayed to adjust the projection status without connecting video equipment.  [p.23](#)
- When projecting from multiple projectors, the correction is easier if you use the image in dot by dot format, that can be displayed without being enlarged or reduced.

Point Correction

Corrects slight distortion which occurs partially, or adjusts the image position in an overlapping areas.

Divides the projected image by the grid and corrects the distortion by moving the point of intersection from side to side and up and down.

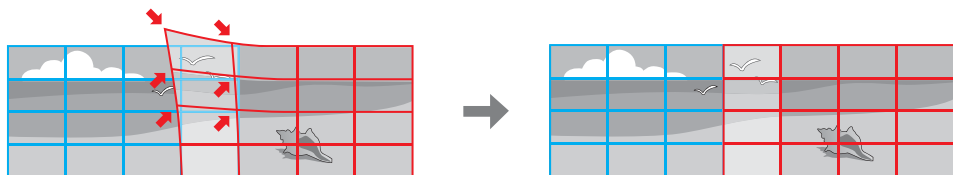

- 1 Press the [Menu] button while projecting.
- 2 Select **Geometric Correction** from **Settings**.
- 3 Select **Point Correction**, and then press the [↵] button.
If the message "If this setting is changed, the image may be distorted." is displayed, press the [↵] button.
- 4 Select **Point Correction**, and then press the [↵] button.

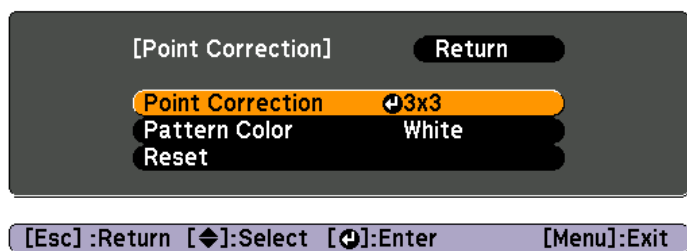

Point Correction: Performs point correction.

Pattern Color: Select the color of the grid when performing corrections.

Reset: Resets all corrections for **Point Correction** to their default values.

- 5 Select the number of grid lines (**3x3**, **5x5**, or **9x9**), and then press the [↵] button.

- 6 Use the [▲], [▼], [◀], and [▶] buttons to move to the point you want to correct, and then press the [↵] button.

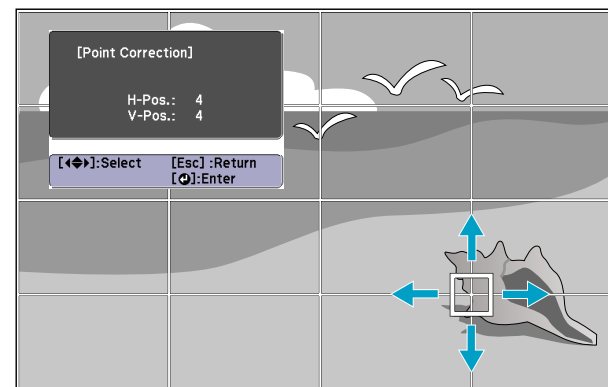

- 7 Use the [▲], [▼], [◀], and [▶] buttons to correct distortion.

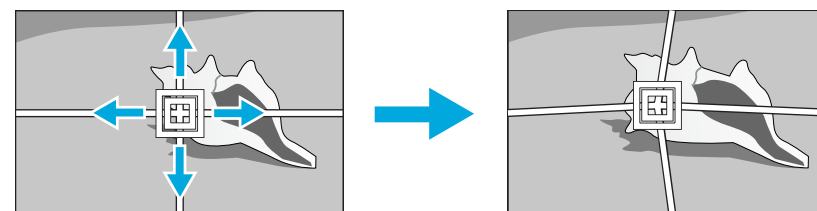

To continue to correct another point, press the [Esc] button to return to the previous screen, and then repeat steps 6 and 7.



Each time you press the [↵] button, you can show or hide the image and the grid.

- 8 When you are done, press the [Menu] button to exit the correction menu.

Checking the Color Mode

Set the Color Mode to **Multi-Projection** (or **3D Multi-Projection** for 3D images).  [p.46](#)

Adjust the Edges of the Images (Edge Blending)

When multiple projectors are lined up and projecting images, you can create a seamless screen.

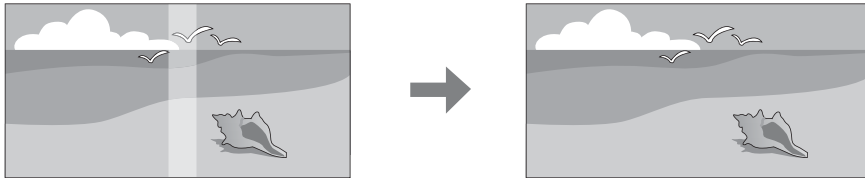

Adjusting the brightness of the lamp

Before performing edge blending, adjust so that the lamp brightness is the same for each projector.

Adjust so that all projectors are the same brightness as the darkest lamp. You can adjust the brightness in five levels.



- Set **Power Consumption** to **Normal**.
- Even if you adjust the **Brightness Level**, the brightness of each lamp may not match exactly.
- **Brightness Level** is not available for EB-G6450WU.

- 1** Press the [Menu] button while projecting.
- 2** Select **Multi-Projection** from **Extended**.

- 3** Select **Brightness Level**, and then press the [↵] button.
- 4** Select **1** to **5** as the brightness.
- 5** Press the [Esc] button to return to the previous screen.

Performing edge blending

- 1** Press the [Menu] button while projecting.
 "Using the Configuration Menu" [p.78](#)
- 2** Select **Multi-Projection** from **Extended**.
- 3** Select **Edge Blending**, and then press the [↵] button.
The following screen is displayed.

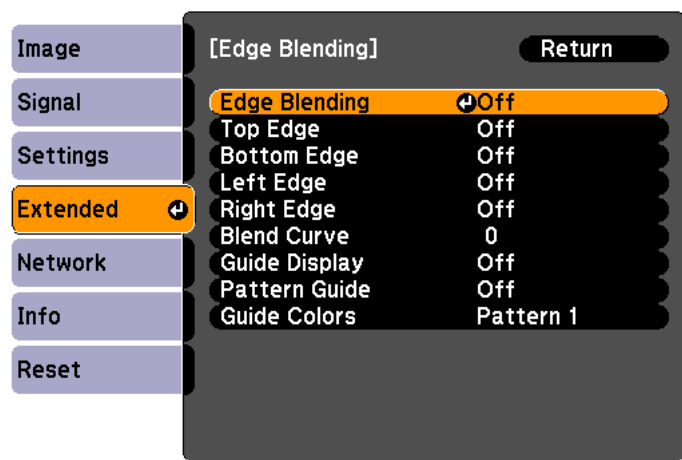

[Esc]:Return [↩]:Select [↵]:Enter [Menu]:Exit

Submenu	Function
Edge Blending	Set to On to activate the edge blending function. Set to Off when not projecting from multiple projectors.
Top Edge/Bottom Edge/Right Edge/Left Edge	Blending: Set to On to activate the edge blending function towards where you are setting, and the blend range will be shaded. Blend Range: Adjusts the range to be shaded. Adjustment is possible at the level of one pixel. The maximum range is 45% of the resolution.
Blend Curve	You can select from three ways of shading.
Guide Display	Set to On to display the guide on the edge blending setting range.
Pattern Guide	Set to On to display a guide to match the position of the edge blending setting range.
Guide Colors	You can select the combination of guide colors from the three.

- 4** Turn on Edge Blending.
- (1) Select **Edge Blending**, and then press the [↵] button.
 - (2) Select **On**, and then press the [↵] button.
 - (3) Press the [Esc] button.

- 5** Display the guide.
- (1) Select **Guide Display**, and then press the [↵] button.
 - (2) Select **On**, and then press the [↵] button.
 - (3) Press the [Esc] button.



If the guide is not clear, you can change the color of the guide on **Guide Colors**.

- 6** Display a pattern.
- (1) Select **Pattern Guide**, and then press the [↵] button.
 - (2) Select **On**, and then press the [↵] button.
 - (3) Press the [Esc] button.
- 7** Set Top Edge/Bottom Edge/Right Edge/Left Edge.
- (1) Select **Top Edge/Bottom Edge/Right Edge/Left Edge** to set the edge blending, and then press the [↵] button.
 - (2) Select **Blending**, and then press the [↵] button.
 - (3) Select **On**, and then press the [↵] button.
 - (4) Press the [Esc] button.

- (5) In **Blend Range**, adjust the range to be shaded.
The value for when the overlapped range and the guide are in the same position is the best.

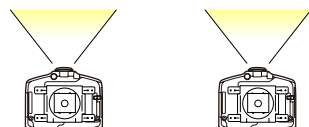
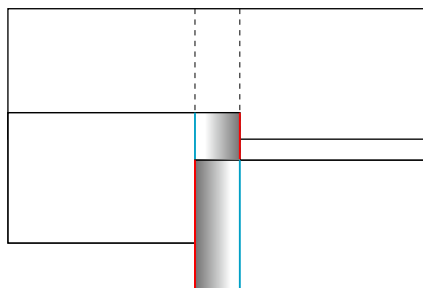

- (6) Press the [Esc] button.
(7) Set **Guide Display** and **Pattern Guide** to Off.

8 Set Blend Curve.

- (1) Select **Blend Curve**, and then press the [**↵**] button.
(2) Select the amount of shading from **1** to **3**, and then press the [**↵**] button.
The edges of the images are adjusted.
(3) Press the **Menu** button to finish making settings.

Adjusting to Match Colors

Follow the steps below to adjust the brightness of the projected image and the color balance that was adjusted by performing edge blending.



The brightness and color may not be uniform even after making adjustments.

- 1** Press the [Menu] button while projecting.
2 Select **Multi-Projection** from **Extended**.
3 Select **Multi-screen**, and then press the [**↵**] button.
The following screen is displayed.

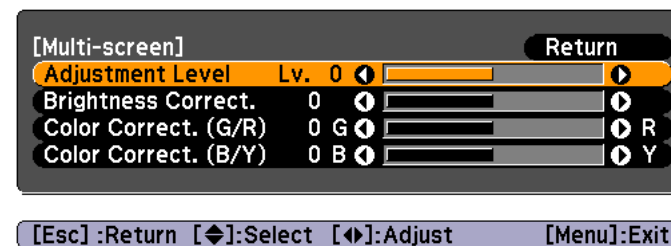

Adjustment Level: There are five levels from white, gray, and up to black. Adjust each level individually.

Brightness Correct.: Adjust from black to white for each color tone.

Color Correct. (G/R): Adjust the color tone for green and red.

Color Correct. (B/Y): Adjust the color tone for blue and yellow.



Whenever the [**↵**] button is pressed, the screen changes between the projected image and the adjustment screen.

- 4** Select **Adjustment Level**, and then use the [**◀**][**▶**] buttons to set the adjustment level.
5 Select **Brightness Correct.**, and then use the [**◀**][**▶**] buttons to adjust the brightness.
6 Select **Color Correct. (G/R)** or **Color Correct. (B/Y)**, and then use the [**◀**][**▶**] buttons to adjust the color.

- 7 Return to step 4 and adjust each level.
- 8 When you are done, press the [Menu] button to exit the correction menu.

Scaling an Image (Scale)

A section of the image is cropped and displayed. This allows you to create one large image by combining images projected from multiple projectors.

- 1 Press the [Menu] button while an image is being projected.
 - ☛ "Using the Configuration Menu" [p.78](#)
- 2 Select **Scale** from **Signal**.
- 3 Set **Scale** to **On**.
 - (1) Select **Scale**, and then press the [↵] button.
 - (2) Select **On**, and then press the [↵] button.
 - (3) Press the [Esc] button to return to the previous screen.
- 4 Set **Scale Mode**.
 - (1) Select **Scale Mode**, and then press the [↵] button.

- (2) Select **Zoom Display** or **Full Display**, and then press the [↵] button.

Zoom Display: Adjusts according to the image currently displayed.

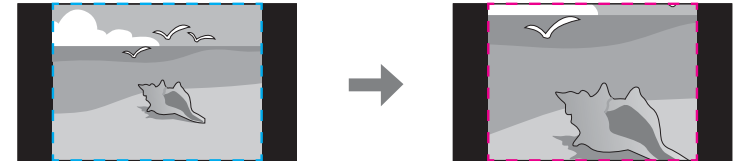

Full Display: Adjusts according to the projector's panel size (the maximum area in which an image can be displayed).



- (3) Press the [Esc] button to return to the previous screen.

5 Adjust the scale.

Select the adjustment method with the [▲][▼] buttons, then adjust using the [◀][▶] buttons.

- +: Enlarges or reduces an image horizontally and vertically at the same time.

Scale Vertically: Enlarges or reduces an image vertically.

Scale Horizontally: Enlarges or reduces an image horizontally.

6 Adjust the **Image Display Range**.

- (1) Select **Image Display Range**, and then press the [↵] button.
- (2) Use the [▲], [▼], [◀], and [▶] buttons to scroll the image.
Adjust the coordinates and size of each image while viewing the screen.
- (3) Press the [Menu] button to finish making settings.

Projecting Two Images Simultaneously (Split Screen)

You can simultaneously project images from two sources on the right and left of the screen.

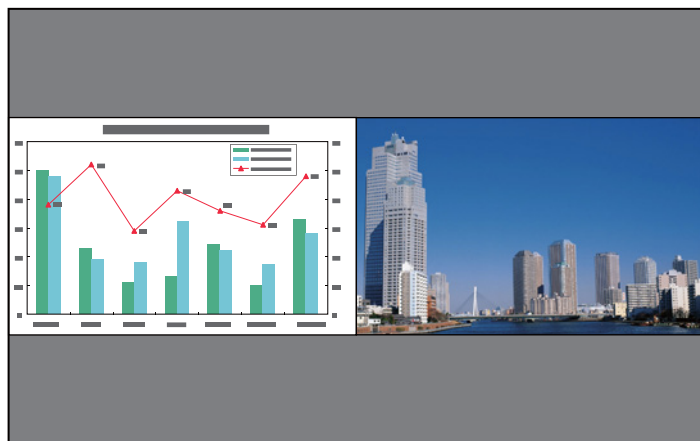

- The following input source combinations cannot be projected using the split screen function.
Computer - BNC, S-Video - Video, HDMI - HDBaseT (EB-G6750WU only)
- You cannot project the same input source on both sides (left and right) of the screen.

Operating procedures

Projecting on a split screen

- 1 Press the [Split] button while projecting.
The currently selected input source is projected on the left of the screen.

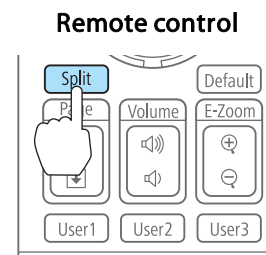

You can perform the same operations from the configuration menu.

➡ **Settings - Split Screen** p.84

- 2 Press the [Menu] button.
The Split Screen Setup screen is displayed.

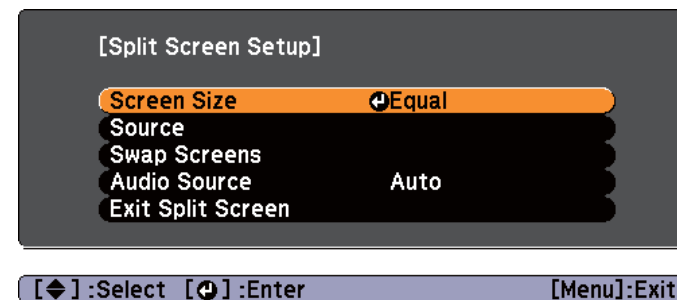

- 3 Select **Source**, and then press the [] button.

- 4 Select each input source for **Left** and **Right**.

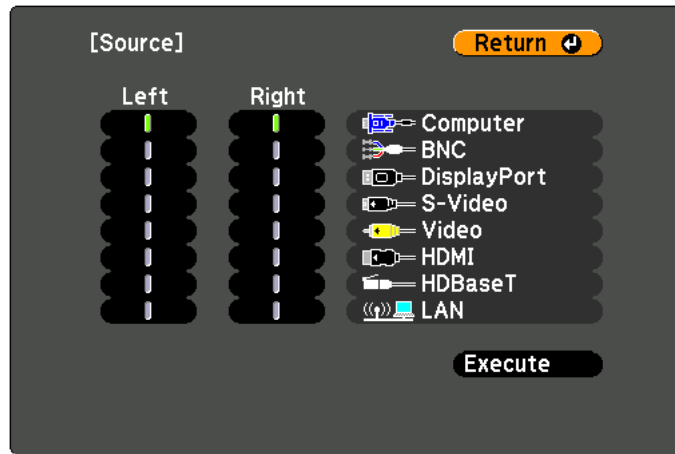

[Esc] / [⏪]:Return [⏩]:Select [Menu]:Exit



You can perform the same operations using the following procedure.

- ☛ "Automatically Detect Input Signals and Change the Projected Image (Source Search)" [p.41](#)
- ☛ "Switching to the Target Image by Remote Control" [p.42](#)

- 5 Select **Execute**, and then press the [↵] button.

To switch the source during split screen projection, start the procedure from step 2.

Switching the left and right screens

Use the following procedure to switch the projected images displayed on the left and right screens.

- 1 Press the [Menu] button during split screen projection.

- 2 Select **Swap Screens**, and then press the [↵] button.
The projected images on the left and right are swapped.



Switching the left and right image sizes

- 1 Press the [Menu] button during split screen projection.
- 2 Select **Screen Size**, and then press the [↵] button.
- 3 Select the screen size you want to display, and then press the [↵] button.

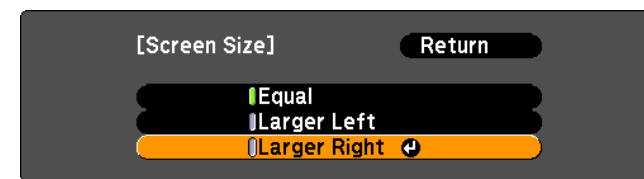

The projected images will appear as shown below after setting the screen size.

Equal

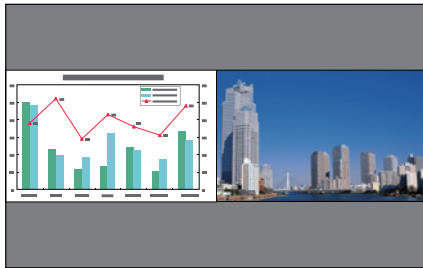

Larger Left

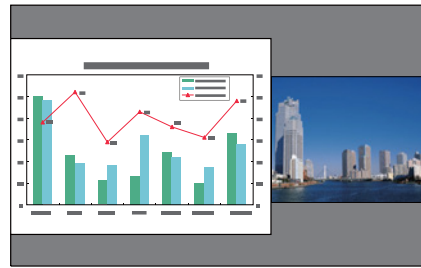

Larger Right

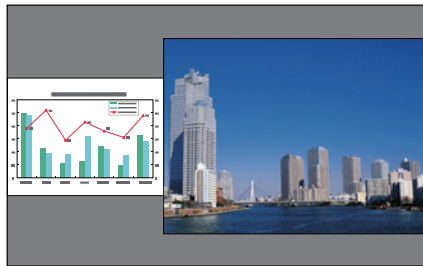

- You cannot enlarge both the left screen and right screen images at the same time.
- When one image is enlarged, the other image is reduced.
- Depending on the video signals that are input, the images on the left and right may not appear to be the same size even if **Equal** is set.

Changing the audio

- 1 Press the [Menu] button during split screen projection.
- 2 Select **Audio Source**, and then press the [↵] button.

- 3 Select the audio you want to output, and then press the [↵] button.

When you select **Auto**, audio is output for the largest screen.

If the screens are the same size, audio is output for the screen on the left.

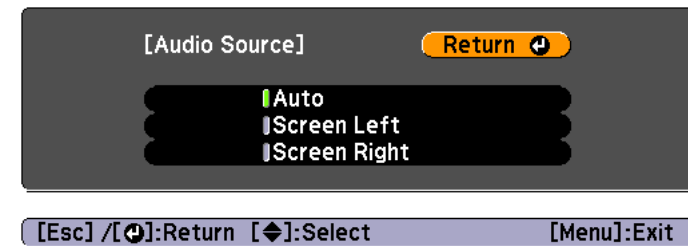

Ending the split screen

Press the [Esc] button to end split screen.

The following steps can also be used to end the split screen.

- Press the [Split] button on the remote control.
- Select **Exit Split Screen** on the Split Screen Setup screen.  p.60

Restrictions during split screen projection

Operating restrictions

The following operations cannot be performed during split screen projection.

- Setting the configuration menu
- E-Zoom
- Changing the aspect mode
- Using the [User1], [User2], or [User3] buttons on the remote control
- Help can be displayed only when image signals are not input or when an error or warning notification is displayed.

- The user's logo is not displayed.

Restriction relating to images

- The default values for the **Image** menu are applied to the image on the right screen. However, the settings for the image projected on the left screen are applied to the image on the right screen for **Color Mode**, **Abs. Color Temp.**, and **Advanced**. Also, the **Frame Interpolation** settings from the **Signal** menu are applied to the image projected on the left screen.
- **Auto Iris** is not available.
 - ☞ **Image - Auto Iris** p.81

Hiding the Image and Sound Temporarily (A/V Mute)

You can use this when you want to focus the audience's attention on what you are saying, or if you do not want to show details such as when you are changing between files during presentations from a computer.

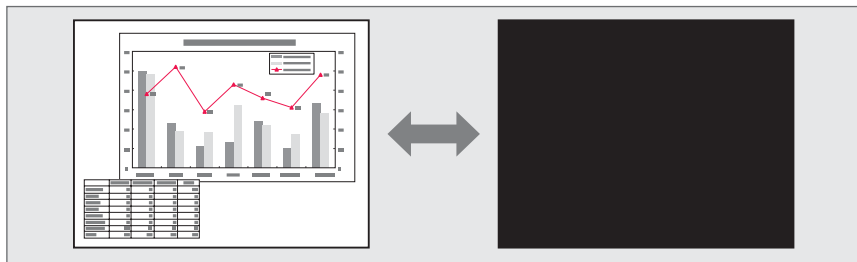

A/V Mute is applied or released each time you press the [A/V Mute] button.

Remote control

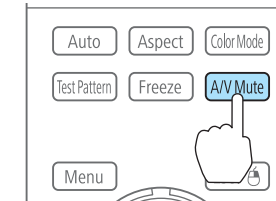

- When **A/V Mute Release** is set to **A/V Mute** from the configuration menu, the following operations can still be performed without releasing A/V mute.
 - ☞ **Extended - Operation - A/V Mute Release** p.86
 - Change the source with the change input buttons on the remote control.
 - ☞ "Switching to the Target Image by Remote Control" p.42
 - Control the projector from a computer using communication commands.
 - ☞ "Monitoring and Controlling" p.145
- A/V mute is only released by pressing the [A/V Mute] button, or by sending an A/V mute Off command.
- When projecting moving images, the images and sound continue to be played back while A/V Mute is on. It is not possible to resume projection from the point where A/V Mute was activated.
- You can select the screen displayed when the [A/V Mute] button is pressed from the Configuration menu.
 - ☞ **Extended - Display - A/V Mute** p.86
- The lamp is still lit during A/V Mute, so the lamp hours continue to accumulate.

Freezing the Image (Freeze)

When Freeze is activated on moving images, the frozen image continues to project on the screen, so you can project a moving image one frame at a time like a still photo. Also, you can perform operations such as changing between files during presentations from a computer without projecting any images if the Freeze function is activated beforehand.

Each time you press the [Freeze] button, Freeze turns on or off.

Remote control

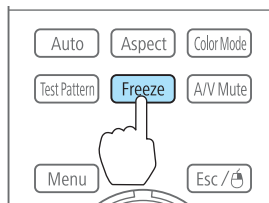

- Audio does not stop.
- When projecting moving images, the images continue to be played back while the screen is frozen. It is not possible to resume projection from the point where the screen was frozen.
- If the [Freeze] button is pressed while the Configuration menu or the Help screen is displayed, the menu or the Help screen that is displayed is closed.
- Freeze still works while E-Zoom is being used.

Enlarging Part of the Image (E-Zoom)

This is useful when you want to expand images to see them in greater detail, such as graphs and tables.

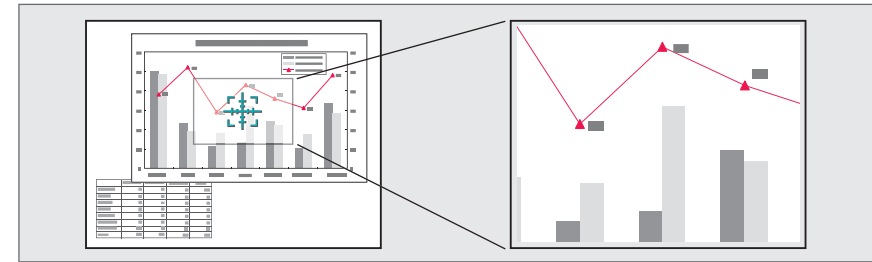

1 Start E-Zoom.

Press the [⊕] button to display the Cross (⊕).

Remote control

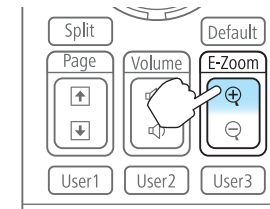

2 Move the Cross (⊕) to the area of the image that you want to enlarge.

Remote control

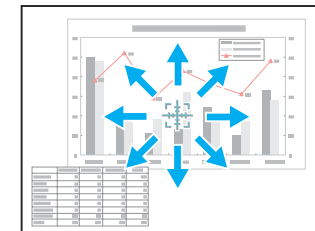
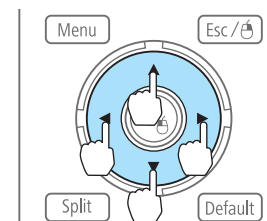

3 Enlarge.

Remote control

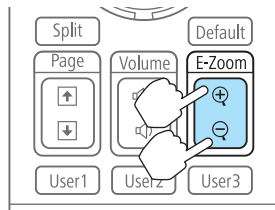

[⊕] button: Expands the area each time it is pressed. You can expand quickly by holding the button down.

[⊖] button: Reduces images that have been enlarged.

[Esc] button: Cancels E-Zoom.



- During enlarged projection, press the [▲], [▼], [◀], or [▶] buttons to scroll the image.
- E-Zoom is unavailable when **Scale** is set to **On**.
 🗨️ **Signal - Scale** p.82



- When **User's Logo Protection** from **Password Protection** is set to **On**, a message is displayed and the User's Logo cannot be changed. You can make changes after setting **User's Logo Protection** to **Off**.
 🗨️ "Managing Users (Password Protection)" p.72
- If **User's Logo** is selected when Geometric Correction, E-Zoom or Aspect are being performed, the function currently being performed is temporarily cancelled.

3

When the message "Choose this image as the User's Logo?" is displayed, select **Yes**.



When you press the [↩] button, the screen size may change depending on the signal to match the actual resolution of the image signal.

Saving a User's Logo

You can save the image that is currently being projected as a User's Logo.



Once a User's Logo has been saved, the logo cannot be returned to the factory default.

1

Project the image you want to save as the User's Logo, and then press the [Menu] button.

🗨️ "Using the Configuration Menu" p.78

2

Select **User's Logo** from **Extended**.

4

Move the box to select the part of the image to use as the User's Logo.

You can perform the same operations from the projector's control panel.

Remote control

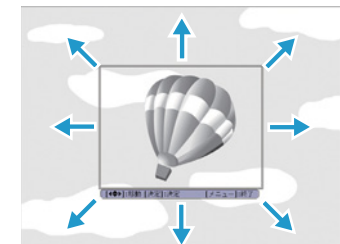
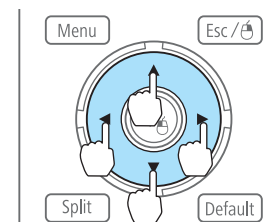

You can save at 400x300 dots in size.

5 When you press the [] button and the message "Select this image?" is displayed, select **Yes**.

6 Select the zoom factor from the zoom setting screen.

7 When the message "Save this image as the User's Logo?" is displayed, select **Yes**.

The image is saved. After the image has been saved, the message "Completed." is displayed.



When a User's Logo is saved, the previous User's Logo is erased.

The settings for the image currently displayed are saved as a memory, allowing you to load them when necessary. Settings for the following menu items are saved in the memory.

Top Menu	Submenu
Image	All setting items
Signal	3D Setup Progressive Frame Interpolation Noise Reduction Mosquito NR Video Range Scale Overscan Image Processing
Settings	Power Consumption
Extended	Brightness Level Edge Blending Multi-screen

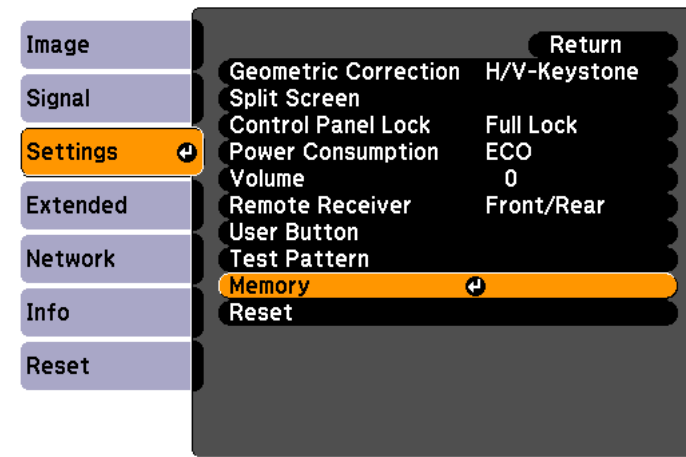

- 3 Select the function you want to perform, then press the [↵] button.

You can only perform **Load Memory** and **Save Memory** when an image is displayed.

Saving/Loading/Erasing the Memory

- 1 Press the [Menu] button while an image is being displayed.
 ➔ "Using the Configuration Menu" p.78
- 2 Select **Memory** from **Settings**.

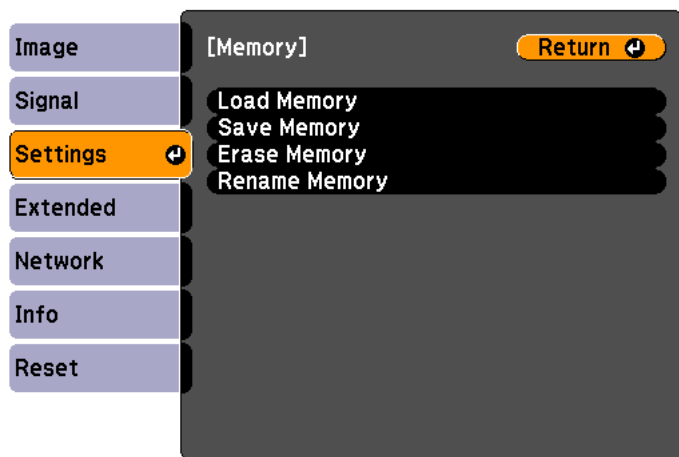

Function	Explanation
Load Memory	Loads the saved memory. When you select a memory and press the [↵] button, the settings applied to the current image are replaced with the settings from the memory.
Save Memory	The settings for the image currently displayed are saved as a memory. When you select a memory name and press the [↵] button, the settings are saved.
Erase Memory	Erases the registered memory. When you select a memory name and press the [↵] button, a message is displayed. Select Yes , and then press the [↵] button to erase the selected memory. You can erase all memories from Reset Memory . ☛ Reset - Reset Memory p.101

Function	Explanation
Rename Memory	Changes the memory name. Select the memory name you want to change, and then press the [↵] button. Enter the memory name using the soft keyboard. ☛ "Soft keyboard operations" p.91 When you have finished, move the cursor over Finish , and then press the [↵] button.

When a memory has already been saved, the memory name and its color mode are displayed.

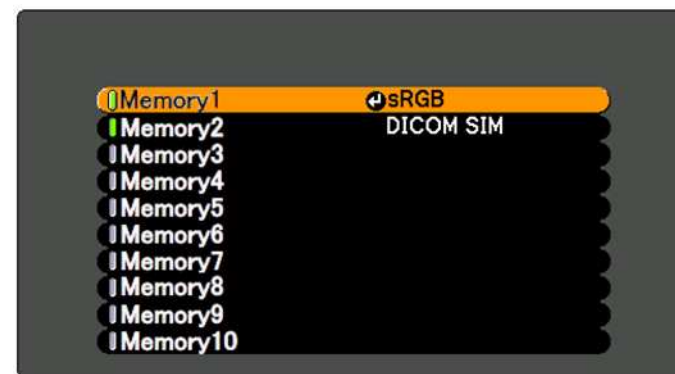

If the mark on the left of the memory name is turned green, it means the memory has already been registered. When you select a registered memory, a message is displayed asking you to confirm that you want to overwrite the memory. If you select **Yes**, the previous settings are deleted and the current settings are registered.

You can schedule turning the projector power on/off and switching the input source, as events in the schedule. Registered events are executed automatically at the specified time on the specified dates or weekly.

Warning

Do not place flammable objects in front of the lens. If you set the schedule to turn on the projector automatically, any flammable objects placed in front of the lens could cause a fire.

Saving a Schedule



- You can set or adjust the date and time for the projector in **Date & Time** from the configuration menu.
 - "Setting the Time" [p.29](#)
- When **Time/Schedule Protection** is set to **On** in **Password Protection**, settings related to the scheduling function cannot be changed. You can make changes after setting **Time/Schedule Protection** to **Off**.
 - "Managing Users (Password Protection)" [p.72](#)

Setting Methods

- Press the [Menu] button while projecting.
 - "Using the Configuration Menu" [p.78](#)
- Select **Schedule Settings** from **Extended**.
- Select **Add New** from **Schedule**.



4 Set the schedule.

Submenu Name	Function
Event Settings	Select an operation of the projector when the event is executed. Select No Change for items that you do not want to change when the event occurs. You can set the following item operations. <ul style="list-style-type: none"> • Power • Source • Power Consumption • A/V Mute • Volume
Date / Time Settings	Set the date, day of the week, and time to execute the event. Use the soft keyboard to enter the date and time. <ul style="list-style-type: none"> "Soft keyboard operations" p.91 When you have finished, move the cursor over Finish , and then press the [] button.

- 5 Select **Save**, and then press the [**↵**] button.
To register additional schedules, repeat steps 3 to 5.
- 6 Select **Setup complete**, and then select **Yes** to finish saving.

 A calendar is displayed on the **Schedule Settings** screen (the screen in step 3). The indicator turns on when an event is saved. (■ : one-time event; ■ : periodic event; ■ : communication on/off; : event invalid)

Use the [**◀**][**▶**] buttons to highlight and check the schedule registered for that day.

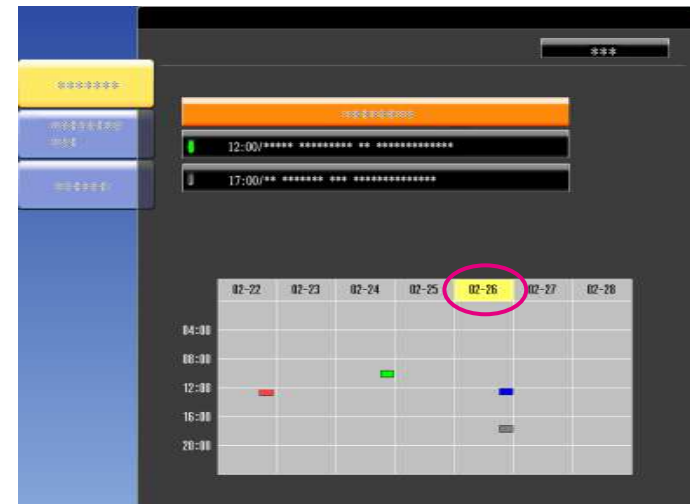

- 4 Highlight the schedule you want to edit, and then press the [Esc] button.

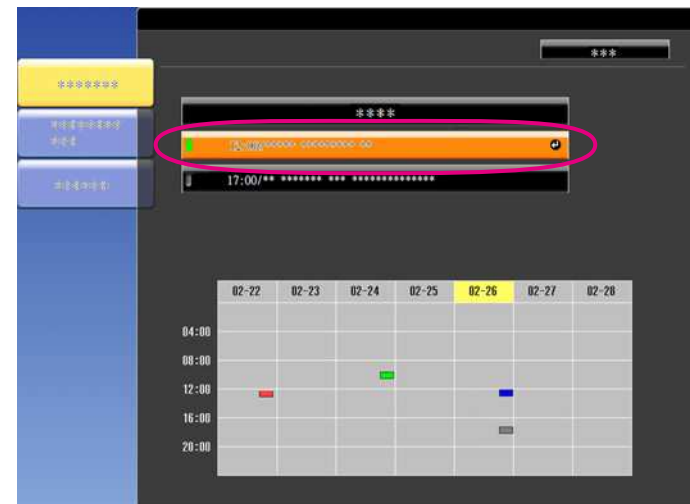

Editing a schedule

- 1 Press the [Menu] button while projecting.
☛ "Using the Configuration Menu" p.78
- 2 Select **Schedule Settings** from **Extended**.
- 3 Use the [**◀**][**▶**] buttons to highlight the date containing the schedule you want to edit.



A repeat icon is displayed for periodic schedules.



To delete all registered schedules, select **Schedule Reset**, and then select **Yes**. Select **Setup complete**, and then select **Yes** to delete the schedules.

5 Perform editing from the menu displayed.



Submenu Name	Function
On/Off	Enable or disable the selected schedule. When a schedule is enabled, the indicator turns green.
Edit	Edit the content of the selected schedule. Select Save , and then press the [↵] button to complete the editing.
Clear	Deletes the selected schedule.
Add New	Save a new schedule. Select Save , and then press the [↵] button to complete the saving.

6 Select **Setup complete**, and then select **Yes** to finish editing.

The projector has the following enhanced security functions.

- **Password Protection**
You can limit who can use the projector.
- **Control Panel Lock/Remote Control Button Lock**
You can prevent people changing the settings on the projector without permission.
☛ "Restricting Operation" [p.74](#)
- **Anti-Theft Lock**
The projector is equipped with the following anti-theft security device.
☛ "Anti-Theft Lock" [p.75](#)

Managing Users (Password Protection)

When Password Protection is activated, people who do not know the password cannot use the projector to project images even if the projector power is on. Furthermore, the user's logo that is displayed when you turn on the projector cannot be changed. This acts as an anti-theft function as the projector cannot be used even if it is stolen. At the time of purchase, Password Protection is not activated.

Kinds of Password Protection

The following three kinds of Password Protect settings can be made according to how the projector is being used.

- **Power On Protection**
When **Power On Protection** is **On**, you need to enter a preset password after the projector is plugged in and turned on (this also applies to Direct Power On). If the correct password is not entered, projection does not start.

- **User's Logo Protection**

Even if someone tries to change the User's Logo set by the owner of the projector, it cannot be changed. When **User's Logo Protection** is set to **On**, the following setting changes for the User's Logo are prohibited.

- Capturing a User's Logo
- Setting **Display Background**, **Startup Screen**, or **A/V Mute** from **Display**
☛ **Extended - Display** [p.86](#)

- **Network Protection**

When **Network Protection** is set to **On**, changing the settings for **Network** is prohibited.

- ☛ "Network Menu" [p.89](#)

- **Time/Schedule Protection**

When **Time/Schedule Protection** is set to **On**, changing settings for the projector's system time or schedules is prohibited.

Setting Password Protection

Use the following procedure to set Password Protect.

- 1** During projection, hold down the [Freeze] button for about five seconds.

The Password Protection setting menu is displayed.

Remote control

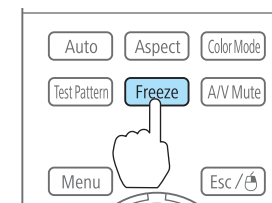



If Password Protection is already activated, you must enter the password.
If the password is entered correctly, the Password Protection setting menu is displayed.

👁️ "Entering the Password" [p.73](#)

- 2** Select the type of Password Protect you want to set, and then press the [**↵**] button.

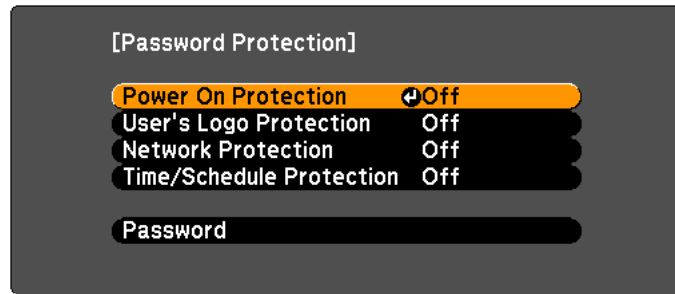

- 3** Select **On**, and then press the [**↵**] button.
Press the [Esc] button to return to the screen in step 2.

- 4** Set the password.
 - (1) Select **Password**, and then press the [**↵**] button.
 - (2) When the message "Change the password?" is displayed, select **Yes** and then press the [**↵**] button. The default password is set to "0000". Change this to your own desired Password. If you select **No**, the screen displayed in step 2 is displayed again.
 - (3) While holding down the [Num] button, enter a four digit number using the numeric buttons. The number entered is displayed as "* * * *". When you enter the fourth digit, the confirmation screen is displayed.

Remote control

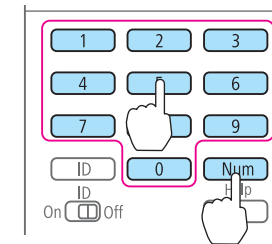

- (4) Re-enter the password.
The message "Password accepted." is displayed.
If you enter the password incorrectly, a message is displayed prompting you to re-enter the password.

Entering the Password

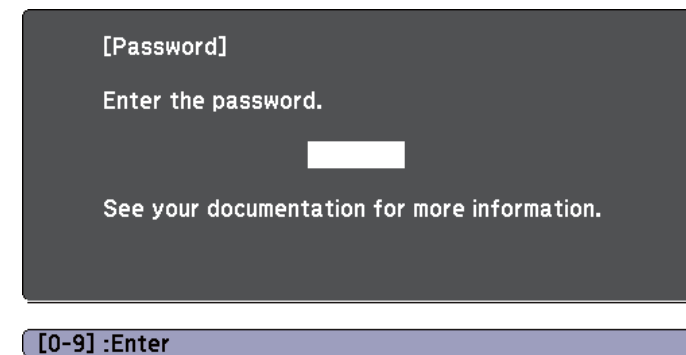

When the password entry screen is displayed, enter the password using the remote control.

While holding down the [Num] button, enter the password by pressing the numeric buttons.



When you enter the correct password, Password Protect is temporarily released.

Attention

- If an incorrect password is entered three times in succession, the message "The projector's operation will be locked." is displayed for approximately five minutes, and then the projector switches to standby mode. If this happens, disconnect the power plug from the electrical outlet and then reinsert it and turn the projector's power back on. The projector displays the password entry screen again so that you can enter the correct password.
- If you have forgotten the password, make a note of the "Request Code: xxxxx" number that appears on the screen and contact the nearest address provided in the Epson Projector Contact List.
 [Epson Projector Contact List](#)
- If you continue to repeat the above operation and input the wrong password thirty times in succession, the following message is displayed and the projector does not accept any more password entries. "The projector's operation will be locked. Contact Epson as described in your documentation."
 [Epson Projector Contact List](#)

Restricting Operation

The following two kinds of operation restriction functions are available with the projector.

- **Control Panel Lock**
This is useful at events or shows when you want to deactivate all buttons during projection or at schools when you want to limit button operation.
- **Remote control button lock**
This function deactivates buttons except for main buttons needed for basic remote control operation, to prevent mistakes in operations.

Control Panel Lock

Perform one of the following to lock the operation buttons on the control panel. Even if the control panel is locked, you can still use the remote control as usual.

- **Full Lock**
All of the buttons on the control panel are locked. You cannot perform any operations from the control panel, including turning the power on or off.
- **Partial Lock**
All of the buttons on the control panel, except for the [⏻] button, are locked.

- 1** Press the [⏻] button on the control panel during projection to display the Control Panel Lock screen.



You can also make settings in **Control Panel Lock** from the configuration menu.

 [Settings - Control Panel Lock p.84](#)

- 2** Select either **Full Lock** or **Partial Lock** according to your purpose.

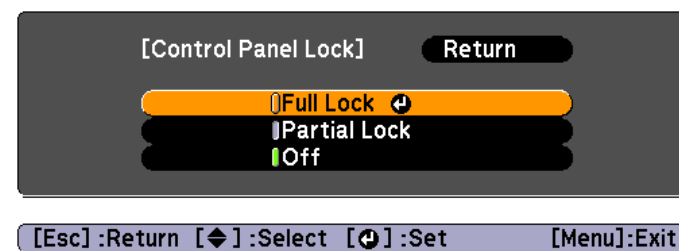

- 3** Select **Yes** when the confirmation message is displayed.
The control panel buttons are locked according to the setting you chose.



You can release the control panel lock by one of the following two methods.

- Use the remote control to set **Control Panel Lock** to **Off** from the configuration menu.
 - ☛ **Settings - Control Panel Lock p.84**
- Press and hold down the [] button on the control panel for about seven seconds, a message is displayed and the lock is released.

Remote control button lock

This function locks the following buttons on the remote control.

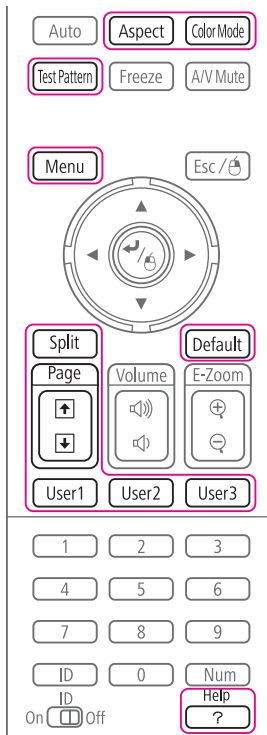

Each time the [Help] button is pressed for at least 5 seconds, the remote control button lock turns on or off.

Remote control

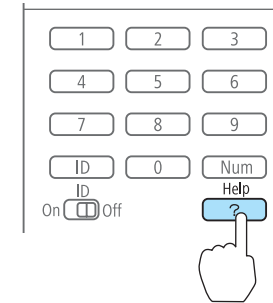

Even if the remote control button lock is on, the following operations are possible.

- Resetting default for the Remote Receiver setting
- Releasing the remote control button lock

Anti-Theft Lock

The projector is equipped with the following types of anti-theft security devices.

- Security slot
 - The security slot is compatible with the Microsaver Security System manufactured by Kensington.
 - See the following for more details on the Microsaver Security System.
 - ☛ <http://www.kensington.com/>
- Security cable installation point
 - A commercially available theft-prevention wire lock can be passed through the installation point to secure the projector to a desk or pillar.

Installing the wire lock

Pass an anti-theft wire lock through the installation point.

See the documentation supplied with the wire lock for locking instructions.

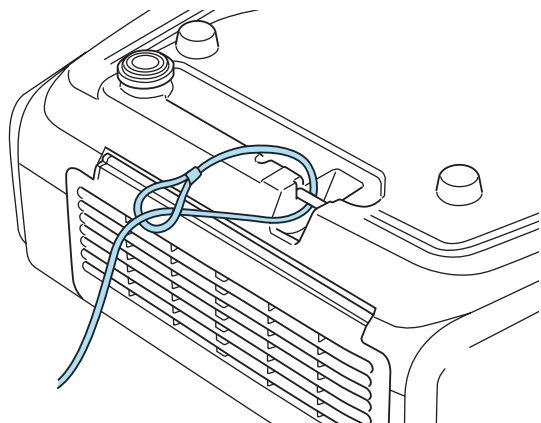



Configuration Menu

This chapter explains how to use the Configuration menu and its functions.

This section explains how to use the Configuration menu.

Although steps are explained using the remote control as an example, you can perform the same operations from the control panel. Check the guide under the menu for the available buttons and their operations.

1 Display the Configuration menu screen.

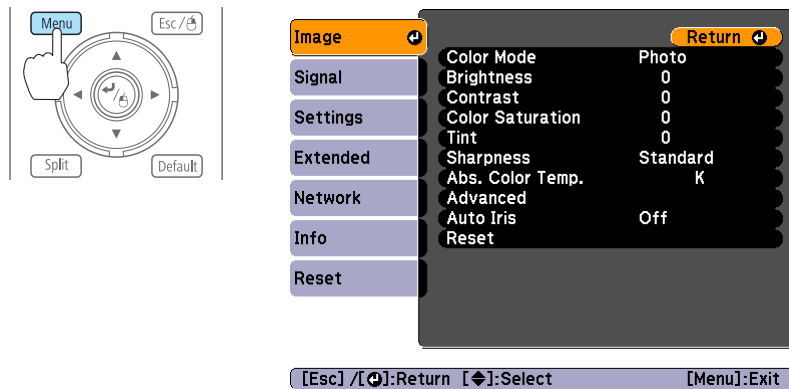

2 Select a top menu item.

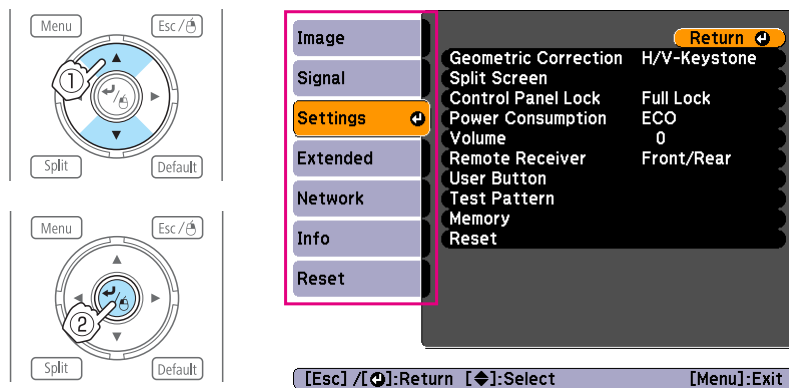

3 Select a submenu item.

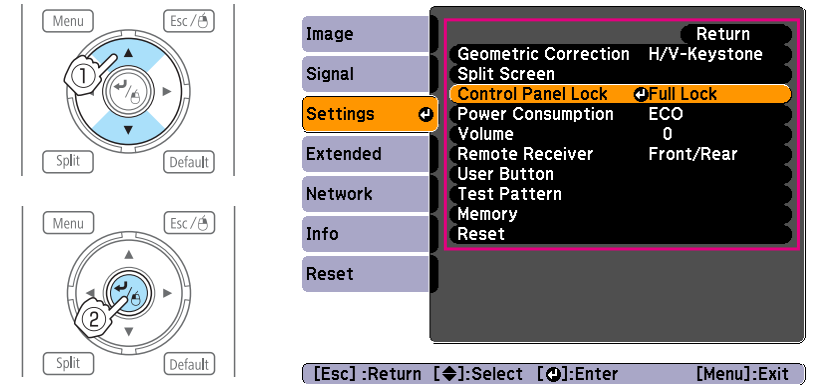

4 Change settings.

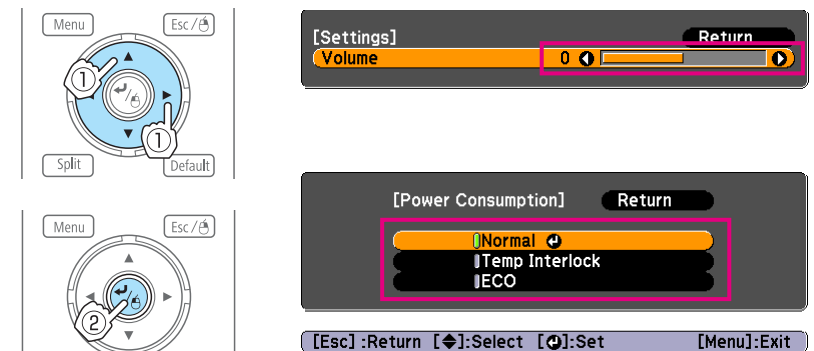

When [Default]: Reset is displayed on the guide, and you press the [Default] button on the remote control, the settings being adjusted are returned to their default values.

5 Press the [Menu] button to finish making settings.

Configuration Menu Table

Settable items vary depending on the model being used and the image signal and source being projected.

Top Menu Name	Submenu Name	Items or Setting Values
Image menu ☛ p.81	Color Mode	Dynamic, Presentation, Theatre, Photo, Sports, sRGB, DICOM SIM, Multi-Projection, 3D Dynamic, 3D Presentation, 3D Theatre, and 3D Multi-Projection
	Brightness	-24 - 24
	Contrast	-24 - 24
	Color Saturation	-32 - 32
	Tint	-32 - 32
	Sharpness	-5 to 5, and Advanced
	Abs. Color Temp.	5000K to 10000K
	Advanced	Gamma, RGB, and RGBCMY
	Auto Iris	On and Off
Signal menu ☛ p.82	Auto Setup	On and Off
	Resolution	Auto, Wide, Normal, Manual
	Tracking	-
	Sync.	-
	Position	-
	3D Setup	3D Images
	Progressive	Off, Video, and Film/Auto
	Frame Interpolation (EB-G6750WU/EB-G6650WU/EB-G6550WU/EB-G6450WU only)	Off, Low, Normal, High

Top Menu Name	Submenu Name	Items or Setting Values
	Noise Reduction	Off, NR1, and NR2
	Mosquito NR	On and Off
	Video Range	Auto, Normal, and Expanded
	Input Signal	Auto, RGB, and Component
	Video Signal	Auto, NTSC, NTSC4.43, PAL, M-PAL, N-PAL, PAL60, and SECAM
	Aspect	Normal, Auto, 4:3, 16:9, Full, Zoom, and Native
	Scale	-
	Overscan	Auto, Off, 4%, and 8%
	Image Processing	Fast, Fine
	DisplayPort EQ Setting	1, 2
Settings menu ☛ p.84	Geometric Correction	H/V-Keystone, Quick Corner, Arc Correction, Point Correction
	Split Screen	-
	Control Panel Lock	Full Lock, Partial Lock, and Off
	Power Consumption	Normal, Temp Interlock, and ECO
	Volume	0 - 20
	Remote Receiver	Front/Rear, Front, Rear, and Off
	User Button	User Button 1, User Button 2, and User Button 3
	Test Pattern	-
Extended menu ☛ p.86	Memory	Load Memory, Save Memory, Erase Memory, Rename Memory
	Display	Menu Position, Messages, Display Background, Startup Screen, A/V Mute, Air Filter Notice, Screen, Panel Alignment, and Color Uniformity

Top Menu Name	Submenu Name	Items or Setting Values
	User's Logo	-
	Projection	Front, Front/Ceiling, Rear, and Rear/Ceiling
	Direction	0 Degree to 180 Degree to -15 Degree
	Operation	Direct Power On, Sleep Mode, Sleep Mode Timer, High Altitude Mode, BNC Sync Termination, Remote Control Type, Inv Direction Button, Startup Source Search, A/V Mute Release, Beep, Lens Type, and Date & Time
	A/V Settings	A/V Output, Monitor Out, and Audio Settings
	Standby Mode	Communication On and Communication Off
	HDBaseT (EB-G6750WU only)	Control Communications
	Multi-Projection	Brightness Level (not available for EB-G6450WU), Edge Blending, Multi-screen, and Projector ID
	Schedule Settings	-
	Language	27 languages
Info menu ☛ p.102	Lamp Hours	-
	Source	-
	Input Signal	-
	Resolution	-
	Video Signal	-
	Refresh Rate	-
	Sync Info	-

Top Menu Name	Submenu Name	Items or Setting Values
	Status	-
	Serial Number	-
	Event ID	-
Reset menu ☛ p.103	Reset All	-
	Reset Lamp Hours	-
	Reset Memory	-

Network menu

Top Menu Name	Submenu Name	Items or Setting Values
Basic menu ☛ p.91	Projector Name	-
	Web Remote Password	-
	Projector Keyword	On and Off
Wireless LAN menu ☛ p.92	Wireless LAN Power	On and Off
	Wi-Fi Protected Setup	-
	Wireless LAN system	802.11b/g and 802.11b/g/n
	Connection Mode	Quick and Advanced
	SSID Auto Setting	On and Off
	SSID	-
	Search Access Point	-
	Channel	1ch, 6ch, and 11ch
	SSID Display	On and Off
	DHCP	On and Off
	IP Address	-
Subnet Mask	-	
Gateway Address	-	





Top Menu Name	Submenu Name	Items or Setting Values
	IP Address Display	On and Off
	Region Code	-
Security menu  p.94	Security	Open, WPA/WPA2-PSK, WPA/WPA2-EAP
Wired LAN menu  p.97	DHCP	On and Off
	IP Address	-
	Subnet Mask	-
	Gateway Address	-
	IP Address Display	On and Off
Administrator Settings menu  p.98	Administrator Password	-
	Network Host Name	-
	PJLink Password	-
	Web Control Password	-
	Monitor Password	-
	Secure HTTP	On and Off
	Mail Notification	-
	Manage Certificates	-
	SNMP	-
	Priority Gateway	Wired, Wireless
	AMX Device Discovery	On and Off
	Crestron RoomView	On and Off
	Bonjour	On and Off
	EPSON Message Broadcasting	On and Off

Image Menu

Settable items vary depending on the image signal and source currently being projected. Setting details are saved for each image signal.

 "Automatically Detect Input Signals and Change the Projected Image (Source Search)" p.41

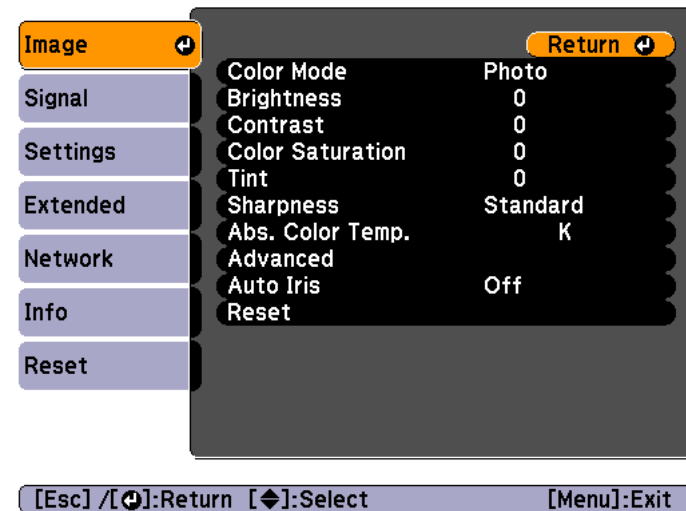

Submenu	Function
Color Mode	You can select the quality of the image to suit your surroundings.  "Selecting the Projection Quality (Selecting Color Mode)" p.46
Brightness	You can adjust the image brightness.
Contrast	You can adjust the difference between light and dark in the images.
Color Saturation	(Adjustment is only possible when component video or composite video images are being input.) You can adjust the color saturation for the images.

Submenu	Function
Tint	(Adjustment is possible when a component video signal is being input. If a composite video signal is input, adjustment is only possible when NTSC signals are being input.) You can adjust the image tint.
Sharpness	Standard: You can adjust the image sharpness. To make more-detailed settings, select Advanced . Advanced: The following four items can be set. Thin Line Enhancement: If this parameter is set to a positive value, details such as hair or fabric patterns will be enhanced. Thick Line Enhancement: If this parameter is set to a positive value, the outline, background, and the other main parts of the objects in the image will be enhanced to show them clearly. Vert. Line Enhancement: If this parameter is set to a positive value, vertical lines in the image are enhanced. Horiz. Line Enhancement: If this parameter is set to a positive value, horizontal lines in the image are enhanced.
Abs. Color Temp.	You can adjust the overall tint of the image. You can adjust tints in 10 stages from 5000 K to 10000 K. The image is tinted blue when a high value is selected and tinted red when a low value is selected.
Advanced	You can make adjustments by choosing the following items. Gamma: You can adjust the coloring by selecting one of the gamma correction values, or referring to the projected image or a gamma graph. RGB: You can adjust the individual R (red), G (green), and B (blue) components of the offset and gain. RGBCMY: You can adjust the hue, saturation, and brightness of each color R (red), G (green), B (blue), C (cyan), M (magenta), Y (yellow) individually.

Submenu	Function
Auto Iris	(This item can be set only if Color Mode is set to Dynamic , Theatre , 3D Dynamic or 3D Theatre . It cannot be set if Edge Blending is set to On .) Set to On to adjust the iris to obtain the optimum light for images being projected. The setting is stored for each Color Mode.
Reset	You can reset all adjustment values for the Image menu to their default settings. See the following to return all menu items to their default settings. ☛ "Reset Menu" p.103

Signal Menu

Settable items vary depending on the image signal and source currently being projected. Setting details are saved for each image signal.

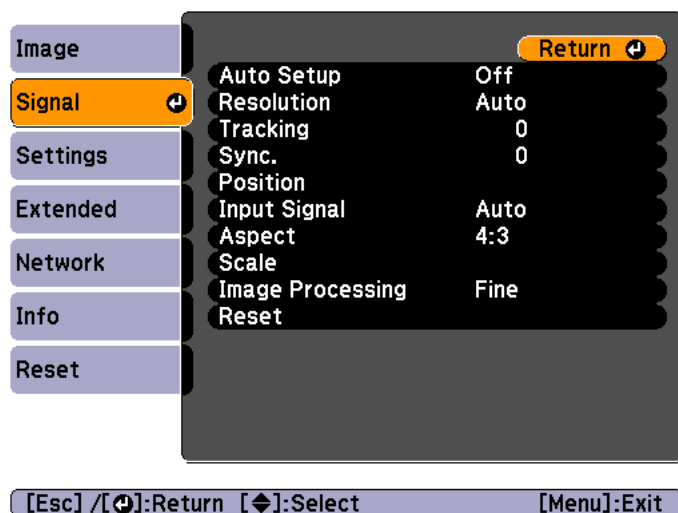

Submenu	Function
Auto Setup	(Only available when an analog RGB computer signal is being input.) Set to On to automatically adjust Tracking, Sync., and Position to the optimum state when the input signal changes.
Resolution	(Only available when an analog RGB computer signal is being input.) Set to Auto to automatically identify the resolution of the input signal. If images are not projected correctly when set to Auto , for example if some of the image is missing, set to Wide for wide screens, or set to Normal for 4:3 or 5:4 screens depending on the connected computer. Manual allows you to specify the resolution. This is ideal when connected computer is fixed.
Tracking	(Only available when an analog RGB computer signal is being input.) You can adjust computer images when vertical stripes appear in the images.

Submenu	Function
Sync.	(Only available when an analog RGB computer signal is being input.) You can adjust computer images when flickering, fuzziness, or interference appear in the images.
Position	You can adjust the display position up, down, left, and right when a part of the image is missing so that the whole image is projected.
3D Setup	When projecting passive 3D images using two projectors, set 3D Images to On .
Progressive	<u>Interlace</u> (i) signal is converted to <u>Progressive</u> (p). (IP conversion) Off : Ideal for images with a large amount of movement. Video : Ideal for general video images. Film/Auto : This is ideal for movie films, computer graphics, and animation.
Frame Interpolation (EB-G6750WU/EB-G6650WU/EB-G6550WU/EB-G6450WU only)	You can play fast moving images smoothly by producing intermediate frames between the original frames.
Noise Reduction	(This cannot be set when Image Processing is set to Fast .) Smooths out the roughness in progressive images. There are two modes. Select your favorite setting. It is recommended that this is set to Off when viewing image sources in which noise is very low, such as for DVDs.
Mosquito NR	(This cannot be set when Image Processing is set to Fast .) When a progressive signal is being input, you can reduce the wavy noise that occurs in lines between areas with dramatic changes in colors.
Video Range	Select the video range for the input signal from the HDMI port, the DisplayPort, HDBaseT port (EB-G6750WU only). Set to Expanded if you are concerned about misadjusted black levels or blown out highlights in the image.

Submenu	Function
Input Signal	You can select an input signal from the Computer port or BNC port. If set to Auto , the input signal is set automatically according to the connected equipment. If colors do not appear correctly when set to Auto , select the appropriate signal according to the connected equipment.
Video Signal	You can select an input signal from the Video port or S-Video port. If set to Auto , video signals are recognized automatically. If interference appears in the image or a problem occurs such as no image is being projected when set to Auto , select the appropriate signal according to the connected equipment.
Aspect	You can set the aspect ratio for projected images. ☛ "Changing the Aspect Ratio of the Projected Image" p.47
Scale	When using multiple projectors to project one image, adjust the range of the image displayed by each projector. ☛ "Scaling an Image (Scale)" p.58
Overscan	(This setting can only be adjusted when a component video signal is being input.) Changes the output image ratio (the range of the projected image). You can set the cropping range to 4% or 8% . When set to Auto , this is automatically adjusted according to the input signal.
Image Processing	Changes settings for image processing. Fast: Images are displayed quicker. Fine: Images are displayed in higher quality.
DisplayPort EQ Setting	Adjusts the DisplayPort input signal level depending on the devices connected to the DisplayPort. If there is a lot of interference in the image, or if a problem such as no image being projected occurs, select 1 or 2 , and then confirm the selection.

Submenu	Function
Reset	You can reset all adjustment values on the Signal menu to their default settings, except for Input Signal , Image Processing and DisplayPort EQ Setting . See the following to return all menu items to their default settings. ☛ "Reset Menu" p.103

Settings Menu

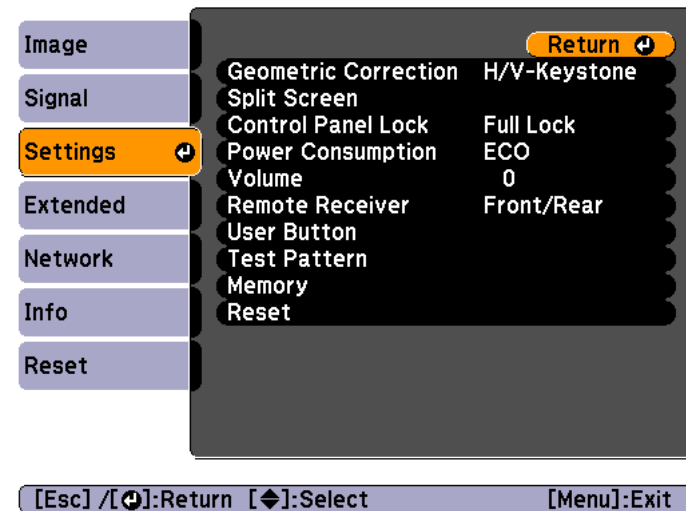

Submenu	Function
Geometric Correction	<p>You can correct distortion.</p> <p>☛ "Correcting Distortion in the Projected Image" p.43</p> <ul style="list-style-type: none"> • H/V-Keystone: Adjust V-Keystone and H-Keystone to correct horizontal and vertical keystone distortion. • Quick Corner: Select and correct the four corners of the projected image. • Arc Correction: Fine adjustment of the curved distortion caused by slack or shrinkage of the screen. • Point Correction: Divides the projected image into a grid and corrects the distortion by moving the selected point of intersection from side to side and up and down.
Split Screen	<p>You can split the screen into two screens.</p> <p>☛ "Projecting Two Images Simultaneously (Split Screen)" p.60</p>
Control Panel Lock	<p>You can use this to restrict operation of the projector's control panel.</p> <p>☛ "Control Panel Lock" p.74</p>
Power Consumption	<p>When set to Normal, the lamp is at its brightest.</p> <p>When set to Temp Interlock, if the surrounding temperature* gets too high, the lamp automatically dims to control the operating temperature.</p> <p>When set to ECO, the power consumption during projection drops and the fan noise is reduced.</p>
Volume	<p>You can adjust the volume. Setting values are saved for each source.</p>

Submenu	Function
Remote Receiver	<p>You can limit the reception of the operation signal from the remote control.</p> <p>When set to Off, you cannot perform any operations from the remote control. If you want to make operations from the remote control, hold down the [Menu] button on the remote control for at least 15 seconds to reset the setting to its default value.</p>
User Button	<p>Select the items from the Configuration menu that you want to assign to the [User1], [User2], and [User3] buttons on the remote control. The following items can be assigned.</p> <p>Power Consumption, Info, Progressive, Geometric Correction, Multi-Projection, Resolution, Memory, or Image Processing</p>
Test Pattern	<p>You can display a test pattern to adjust the projection without connecting other equipment when you set up the projector.</p> <p>☛ "Displaying a Test Pattern" p.23</p>
Memory	<p>Perform operations and make settings for the memory function.</p> <p>☛ "Memory Function" p.67</p>
Reset	<p>You can reset all adjustment values on the Settings menu to their default settings, except for User Button and Memory.</p> <p>See the following to return all menu items to their default settings.</p> <p>☛ "Reset Menu" p.103</p>

* Operating temperature of +40°C at an altitude of 0 to 1499 m, and +35°C at an altitude of 1500 to 3048 m.

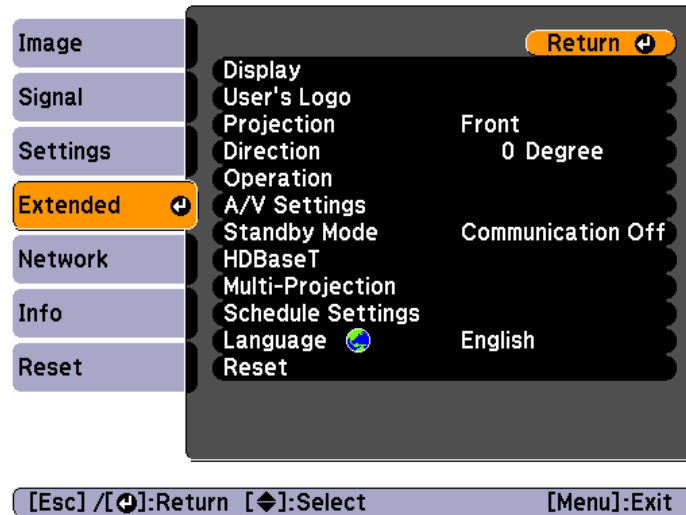

Extended Menu



Submenu	Function
Display	<p>You can make settings related to the projector's display.</p> <p>Menu Position: Select the position to display the menu on the projected screen.</p> <p>Messages: When set to Off, the following items will not be displayed.</p> <p>Item names when the Source, Color Mode, or Aspect is changed, messages when no signal is being input, and warnings such as High Temp Warning.</p> <p>Display Background*: You can set the screen background to Black, Blue, or Logo when no image signal is available.</p> <p>Startup Screen*: Set to On to display the User's Logo when projection starts.</p> <p>A/V Mute*: You can set the screen displayed when the [A/V Mute] button is pressed to Black, Blue, or Logo.</p> <p>Air Filter Notice: You can set whether or not (On/Off) to enable Air Filter Notice. When this is set to On and a clog in the air filter is detected, the message is displayed on the screen.</p> <p>Screen: (This setting is unavailable when projecting images from a computer over a network.) Set the aspect ratio and position of the projected screen according to the type of screen being used.</p> <p>☛ "Screen Settings" p.22</p> <p>Panel Alignment: Correct color misalignments (red and blue) in the screen.</p> <p>☛ "Panel Alignment" p.134</p> <p>Color Uniformity: Adjusts the color tone balance for the whole screen.</p> <p>☛ "Color Uniformity" p.135</p>
User's Logo*	<p>You can change the user's logo that is displayed as a background during Display Background, A/V Mute, and so on.</p> <p>☛ "Saving a User's Logo" p.65</p>

Submenu	Function
Projection	<p>Select from one of the following projection methods depending on how the projector is installed.</p> <p>Front, Front/Ceiling, Rear, and Rear/Ceiling</p> <p>You can change the setting as follows by pressing down the [A/V Mute] button for about five seconds.</p> <p>Front ↔ Front/Ceiling</p> <p>Rear ↔ Rear/Ceiling</p>
Direction	<p>Set this parameter according to the installation status of the projector.</p> <p> "Installation Requirements" p.20</p>

Submenu	Function
Operation	<p>Direct Power On: Set to On to turn on the projector simply by plugging it in.</p> <p>When the power cord is plugged in, note that the projector turns on automatically in cases such as a power outage being restored.</p> <p>Sleep Mode: When set to On, this automatically stops projection when no image signal is being input and no operations are carried out.</p> <p>Sleep Mode Timer: When Sleep Mode is set to On, you can set the time before the projector automatically turns off within a range of 1 to 30 minutes.</p> <p>High Altitude Mode: Set to On when using the projector above an altitude of 1500 m.</p> <p>BNC Sync Termination: Set the termination for the signal from the BNC port. This should usually be set to Off. Set to On when analog (75Ω) termination such as for switchers is necessary.</p> <p>Remote Control Type: You can select Normal or Simple depending on the type of remote control.</p> <p>Set this item to Normal to use the remote control provided with this projector. When Simple is selected, you can use the remote control provided with other Epson projectors to operate this projector. This is useful if you want to use a remote control that you are already familiar with to operate the projector.</p> <p>However, you cannot use the remote control provided with this projector if this is set to Simple. Make sure that the setting is correct because, if the projector is mounted on the ceiling or somewhere hard to reach, changing it back to Normal may be difficult. Additionally, you cannot use the functions that are not equipped with this projector or the remote control which you use.</p> <p>Inv Direction Button: Set this to On when the projector is installed on a ceiling.</p>

Submenu	Function
	<p>Startup Source Search: Set whether or not (On/Off) to automatically detect the image signal being input when the projector is turned on.</p> <p>A/V Mute Release: (This item cannot be set if User's Logo Protection from Password Protection is set to On.  p.72)</p> <p>When set to A/V Mute, you can only release A/V mute by pressing the [A/V Mute] button (or by sending an A/V mute Off command).</p> <p>When set to Any Button, A/V mute is released when any operation is performed on the projector.</p> <p> "Hiding the Image and Sound Temporarily (A/V Mute)" p.63</p> <p>Beep: When this is set to On, the confirmation buzzer beeps to notify you that the power turns on or off, or cooling down is finished.</p> <p>Lens Type: Set this to ELPLU01 when the optional short throw zoom lens (ELPLU01) is attached. When using another lens, set this to Others.</p> <p>Date & Time: Make system time settings for the projector.  "Setting the Time" p.29</p>

Submenu	Function
A/V Settings	<p>A/V Output: (This item can be set only if Standby Mode is set to Communication On) Set this to Always On when the projector is in standby status and you want to output audio and images to an external device.</p> <p>Monitor Out: Select the image source output to an external monitor when the projector is in standby status. When set to Auto, analog RGB signals from the Computer port or the BNC port are output depending on which source was selected when the projector was turned off.</p> <p>Audio Settings: Perform the following audio related settings.</p> <ul style="list-style-type: none"> • Audio Output: Select the audio to be output when projecting images from the Computer port, BNC port, S-Video port or Video port. When set to Auto, audio is output from the audio input port corresponding to each image input port.  "Connecting Equipment" p.31 • DisplayPort Audio Output: Select the audio source when projecting images from the DisplayPort. If you select DisplayPort, audio for the image is output as it is. If you select Audio3, audio is output from the Audio3 port. • HDMI Audio Output: Select the audio source when projecting images from the HDMI port. If you select HDMI, audio for the image is output as it is. If you select Audio3, audio is output from the Audio3 port.
Standby Mode	<p>If you set Communication On, you can perform the following operations even if the projector is in standby mode.</p> <ul style="list-style-type: none"> • Monitor and control the projector over a network. • Output audio and images to an external device. (Only when A/V Output is set to Always On.) • Communication from the HDBaseT port is enabled. (Only when Control Communications is set to On.)

Submenu	Function
HDBaseT (EB-G6750WU only)	<p>Make settings when the optional HDBaseT Transmitter is connected to the HDBaseT port.</p> <p>Control Communications: When set to On, Ethernet communication from the HDBaseT port, serial communication, and control using the wired remote control connected to the optional HDBaseT Transmitter are all enabled. (When this is enabled, the projector's LAN port, RS-232C port, and Remote port are disabled.)</p>
Multi-Projection	<p>Make settings when projecting from multiple projectors.</p> <p>☛ "Multi-Projection Function" p.53</p> <p>Brightness Level (not available for EB-G6450WU): When the brightness of each lamp differs, set the lamp brightness level between 1 and 5. This item can be adjusted only when Power Consumption is set to Normal from the Settings menu.</p> <p>Edge Blending: Corrects a border between multiple images to create a seamless screen.</p> <p>☛ "Adjust the Edges of the Images (Edge Blending)" p.55</p> <p>Multi-screen: You can adjust the tint and brightness of each projected image.</p> <p>☛ "Adjusting to Match Colors" p.57</p> <p>Projector ID: Set the ID from 1 to 9. Off indicates that no ID is set.</p> <p>☛ "ID Settings" p.28</p>
Schedule Settings	<p>You can set the projector's schedule so that it performs a specific operation at a pre-scheduled time.</p> <p>☛ "Scheduling Function" p.69</p>
Language	<p>You can set the language for messages and menus.</p>

Submenu	Function
Reset	<p>You can reset all adjustment values for the Extended menu to their default settings. However, the following items are not reset.</p> <p>Screen Type, Screen Position, Projection, Direction, High Altitude Mode, Remote Control Type, Inv Direction Button, Startup Source Search, Lens Type, A/V Output, Monitor Out, Standby Mode, Control Communications, Multi-screen, Projector ID, and Language</p> <p>See the following to return all menu items to their default settings.</p> <p>☛ "Reset Menu" p.103</p>

* When **User's Logo Protection** is set to **On** in **Password Protection**, settings related to user's logo cannot be changed. You can make changes after setting **User's Logo Protection** to **Off**.

☛ "Managing Users (Password Protection)" [p.72](#)

Network Menu

When **Network Protection** is set to **On** in **Password Protection**, a message is displayed and the network settings cannot be changed. Set **Network Protection** to **Off** and then configure the network.

☛ "Setting Password Protection" p.72

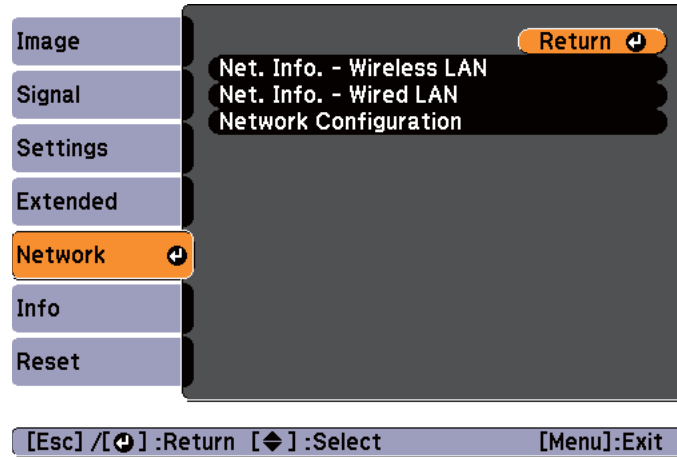

Submenu	Function
Network Configuration	The following menus are available for setting Network items. Basic, Wireless LAN, Security, Wired LAN, Administrator Settings, and Reset

By using a Web browser of a computer connected to the projector on a network, you can set functions and control the projector. This function is called Web Control. You can easily enter text using a keyboard to make settings for Web Control such as Security settings.

☛ "Changing Settings Using a Web Browser (Web Control)" p.145

Submenu	Function
Net. Info. - Wireless LAN	Displays the following network setting status information. <ul style="list-style-type: none"> • Connection Mode • Antenna Level • Projector Name • SSID • DHCP • IP Address • Subnet Mask • Gateway Address • MAC Address • Region Code
Net. Info. - Wired LAN	Displays the following network setting status information. <ul style="list-style-type: none"> • Projector Name • DHCP • IP Address • Subnet Mask • Gateway Address • MAC Address

Notes on operating the Network menu

Selecting from the top menu and sub menus, and changing selected items is the same as making operations from the Configuration menu.

When done, make sure you go to the **Setup complete** menu, and select **Yes**, **No**, or **Cancel**. When you select **Yes** or **No**, you are returned to the Configuration menu.

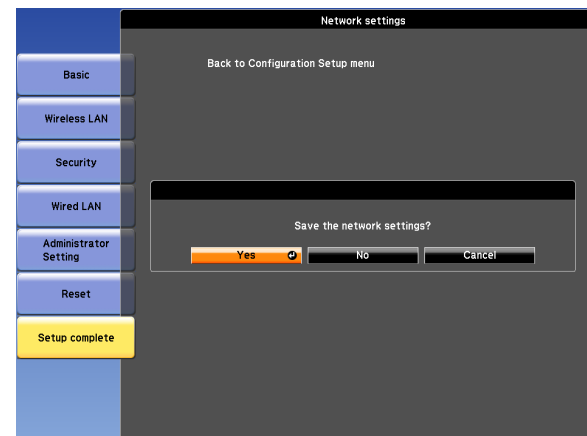

Yes: Saves the settings and exits the Network menu.

No: Does not save the settings and exits the Network menu.

Cancel: Continues displaying the Network menu.

Soft keyboard operations

The Network menu contains items that require input of alphanumerics during setup. In this case, the following software keyboard is displayed. Use the [▲][▼][◀][▶] buttons to move the cursor to the desired key, and then press the [↵] button to enter the selected character. Enter figures by holding down the [Num] button on the remote control, and pressing the numeric buttons. After inputting, press **Finish** on the keyboard to confirm your input. Press **Cancel** on the keyboard to cancel your input.



- Each time the **CAPS** key is selected and the [↵] button is pressed, it sets and changes between upper case and lower case letters.
- Each time the **SYM1/2** key is selected and the [↵] button is pressed, it sets and changes the symbol keys for the section enclosed by the frame.

The following types of character can be entered.

Numbers	0123456789
Letters	ABCDEFGHIJKLMNOPQRSTUVWXYZ abcdefghijklmnopqrstuvwxyz
Symbols	! # \$ % & ' () + - . / < = > ? [¥] ` ^ _ { } ~



- You cannot use colons (:) for Network menu items.
- Except for **SSID**, you cannot use spaces for Network menu items.
- The following four characters cannot be entered using the soft keyboard. Enter these characters using a Web browser.
“ * , ;
 "Changing Settings Using a Web Browser (Web Control)"
[p.145](#)

Basic menu

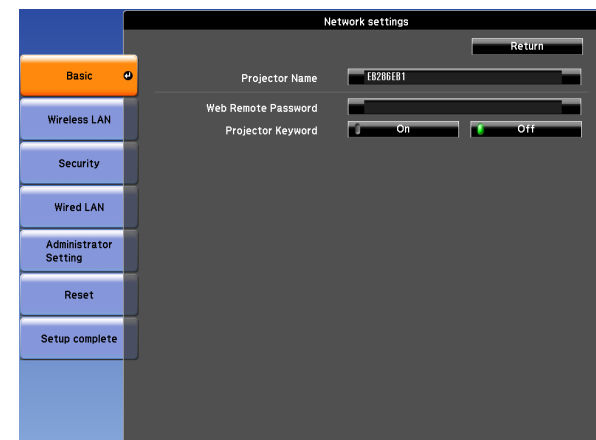

Submenu	Function
Projector Name	The projector's name is displayed when using the supplied application EasyMP Network Projection and EasyMP Multi PC Projection. When editing, you can enter up to 16 single-byte alphanumeric characters. (" * + , / ; < = > ? [¥] ` ^ _ { } ~ cannot be used.)

Submenu	Function
Web Remote Password	<p>Set a password to use Web Remote. You can enter up to 8 single-byte alphanumeric characters. (* cannot be used)</p> <p>Web Remote is a computer function that allows you to operate the projector by using the Web browser on a computer connected on a network.</p> <p>☛ "Changing Settings Using a Web Browser (Web Control)" p.145</p>
Projector Keyword	<p>When set to On, you have to enter the keyword when you try to connect the projector to a computer via a network. As a result, you can prevent presentations from being interrupted by connections from other computers.</p> <p>Normally this should be set to On.</p> <p>☛ EasyMP Network Projection Operation Guide</p>

☛ "Installing the Wireless LAN Unit" [p.38](#)

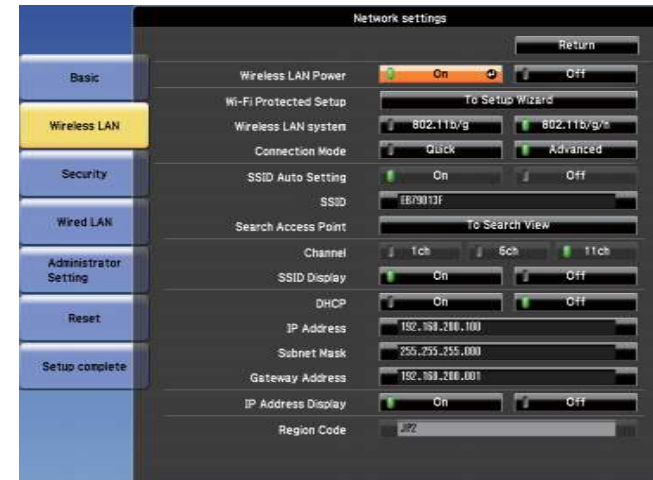

Wireless LAN menu

To connect the projector to a computer using a wireless LAN, install the Wireless LAN unit (ELPAP07).

Submenu	Function
Wireless LAN Power	<p>Set this to On when connecting the projector and a computer via a wireless LAN. If you do not want to connect via wireless LAN, turn it Off to prevent unauthorized access by others.</p>
Wi-Fi Protected Setup	<p>Set this when connecting to a network via a wireless LAN access point compatible with WPS (Wi-Fi Protected Setup) ▶. You can easily connect the projector to the access point and make security settings.</p> <p>☛ "Making a WPS (Wi-Fi Protected Setup) Connection with a Wireless LAN Access Point " p.142</p>
Wireless LAN system	<p>Sets the wireless LAN system. Normally this should be set to 802.11b/g/n. The connection method is selected automatically according to the access point settings.</p> <p>In an area that does not support 802.11n, only 802.11b/g is displayed.</p>





Submenu	Function
Connection Mode	<p>Set the connection mode to use when connecting the projector and a computer via a wireless LAN.</p> <p>If you select Quick, a small network is created automatically by the projector and computer. It is used with EasyMP Network Projection. If SSID Auto Setting is set to On, the projector becomes an easy access point; if it is set to Off, the network is created in Ad hoc mode.</p> <p>If you select Advanced, the connection is established in infrastructure mode through the access point installed.</p>
SSID Auto Setting	<p>If Connection Mode is set to Quick, when you set this to On, you can search for the projector more quickly from among multiple projectors. SSID is set automatically.</p> <p>When connecting to multiple projectors from 1 computer in Quick, set this to Off, and set the same SSID in all the projectors that will connect.</p>
SSID	<p>Enter an SSID. When an SSID is provided for the wireless LAN system in which the projector participates, enter the SSID.</p> <p>You can enter up to 32 single-byte alphanumeric characters. (^ cannot be used.) Set SSID to blank or ANY to establish an ANY connection.</p>
Search Access Point	<p>When Connection Mode is set to Advanced, you can search for surrounding access points, and set the SSID to be connected from those access points. Depending on the access point settings, they may not be displayed in the list. You must set security separately.</p> <p> "Search Access Point screen" p.94</p>
Channel	<p>You can select the channels used to connect in Quick mode. If interference from other signals occurs, use a different channel.</p>
SSID Display	<p>To prevent the SSID from being displayed on the LAN Standby screen, set this to Off.</p>
DHCP	<p>You can set whether or not (On/Off) to use DHCP.</p> <p>If this is set to On, you cannot set any more addresses.</p>

Submenu	Function
IP Address	<p>You can input the IP address assigned to the projector.</p> <p>You can enter a number from 0 to 255 in each field of the address. However, the following IP addresses cannot be used. 0.0.0.0, 127.x.x.x, 224.0.0.0 to 255.255.255.255 (where x is a number from 0 to 255)</p>
Subnet Mask	<p>You can input the Subnet Mask for the projector. You can enter a number from 0 to 255 in each field of the address. However, the following subnet masks cannot be used.</p> <p>0.0.0.0, 255.255.255.255</p>
Gateway Address	<p>You can input the IP address for the gateway for the projector.</p> <p>You can enter a number from 0 to 255 in each field of the address. However, the following Gateway addresses cannot be used.</p> <p>0.0.0.0, 127.x.x.x, 224.0.0.0 to 255.255.255.255 (where x is a number from 0 to 255)</p>
IP Address Display	<p>To prevent the IP address from being displayed on the LAN Standby screen, set this to Off.</p>
Region Code	<p>This is a specific string of the wireless LAN module.</p>

Search Access Point screen

Detected access points are displayed in a list.



Submenu	Function
Refresh	Searches for the access point again.
	Indicates an already set access point.
	Indicates the access points where security is set. If you select an access point where security has not been set, the Wireless LAN menu is displayed. If you select an access point where security has been set, the Security menu is displayed. Select a type of security according to the security settings for the access point.

Security menu

When the Wireless LAN unit is installed, it is strongly recommended that you set security.

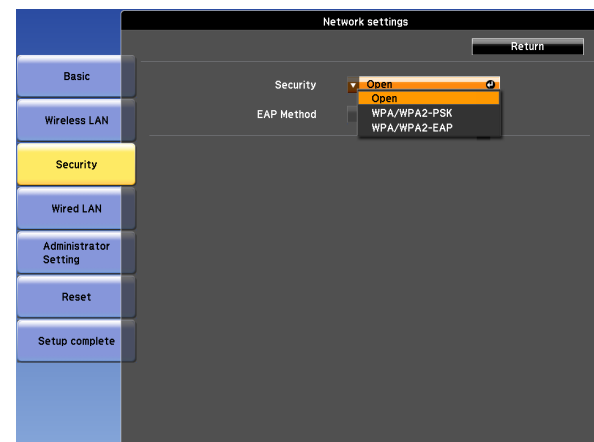

Submenu	Function
Security	<p>You can select a type of security.</p> <ul style="list-style-type: none"> When Quick is selected Open: Security is not set. WPA2-PSK(AES) (only when SSID Auto Setting is set to On): Communication is performed using WPA2 security. Uses AES method for encryption. When establishing a connection from a computer to the projector, enter the value set in the passphrase. When Advanced is selected Open: Security is not set. WPA2-PSK(AES): Connects in WPA personal mode. Encryption method is selected automatically according to the access point settings. Set a passphrase which is the same for the access point. WPA/WPA2-EAP: Connects in WPA enterprise mode. Encryption method is selected automatically according to the access point settings. Select this item when using LEAP.



You cannot set WEP as an encryption method for this projector.

When WPA/WPA2-PSK is selected

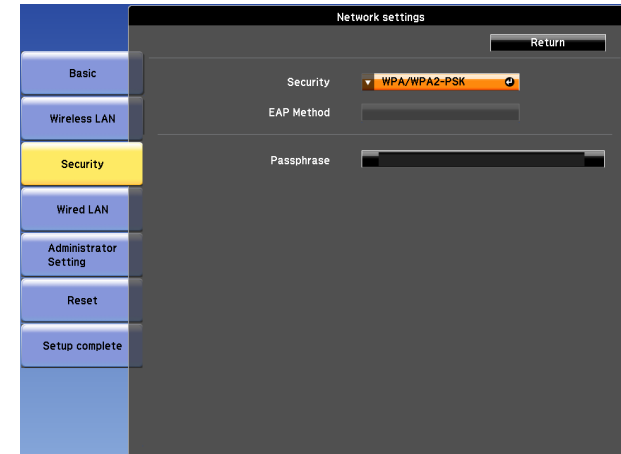



Submenu	Function
Passphrase	<p>Enter the passphrase. You can enter at least 8 and up to 63 single-byte alphanumeric characters. When the passphrase is entered and the [↵] button is pressed, the value is set and displayed as an asterisk (*).</p> <p>When using it with EasyMP Network Projection, you do not need to input the passphrase in the computer if it is the initial (default) passphrase.</p> <p>It is recommended to change the passphrase periodically for the purpose of security. If the network settings are initialized, it returns to the initial passphrase.</p> <p>☛ "Reset menu" p.101</p> <p>You can enter up to 32 characters on the Configuration menu. When entering more than 32 characters, use your Web browser to enter the text.</p> <p>☛ "Changing Settings Using a Web Browser (Web Control)" p.145</p> <p>In Quick mode, the initial passphrase is set.</p>

When WPA/WPA2-EAP is selected



Submenu	Function
EAP Method	<p>Set the protocol for authentication.</p> <p>PEAP: Authentication protocol widely used in Windows Server.</p> <p>PEAP-TLS: Authentication protocol used in Windows Server. Set when using client certificate.</p> <p>EAP-TLS: Authentication protocol widely used to use a client certificate.</p> <p>EAP-Fast, LEAP: Select this when these authentication protocols are used.</p>

Submenu	Function
User name	<p>Enter a user name to be used for authentication. You can enter up to 64 single-byte alphanumeric characters.</p> <p>If you select PEAP-TLS or EAP-TLS, the user name obtained automatically from the client certificate is displayed. You can change the user name if the authentication server requires another user name.</p> <p>You can enter up to 32 characters on the Configuration menu. When entering more than 32 characters, use your Web browser to enter the text.</p> <p> "Changing Settings Using a Web Browser (Web Control)" p.145</p> <p>If you also need to enter a domain name, add the domain name before the user name separated by a backslash.</p>
Password	<p>Enter a password to be used for authentication. You can enter up to 64 single-byte alphanumeric characters. When the password is entered and Finish is selected, the value is set and displayed as an asterisk (*).</p> <p>You can enter up to 32 characters on the Configuration menu. When entering more than 32 characters, use your Web browser to enter the text.</p> <p> "Changing Settings Using a Web Browser (Web Control)" p.145</p>
Client Certificate	<p>Displays the Issued to, Issued by, and Validity period information set in the stored client certificate. It is blank if the certificate is not set.</p>
Verify Server Certificate	<p>Set to On to perform verification for the authentication server certificate. To verify a server certificate, you need to set CA certificate.</p> <p> "Setting Certificates" p.146</p>
CA certificate	<p>Displays the Issued to, Issued by, and Validity period information set in the stored CA certificate. It is blank if the certificate is not set.</p>

Submenu	Function
Setting RADIUS Server Name	Set to On to perform authentication of the server name during server certificate verification. By specifying the server name, you can reduce the risk of connecting to an invalid authentication server.
RADIUS Server Name	Specify the authentication server name. You can enter up to 32 single-byte alphanumeric characters. (^ cannot be used.)
Verify Exp. date of Server Cert.	Set to On to perform verification of the certificate's validity period during server certificate verification.

Wired LAN menu

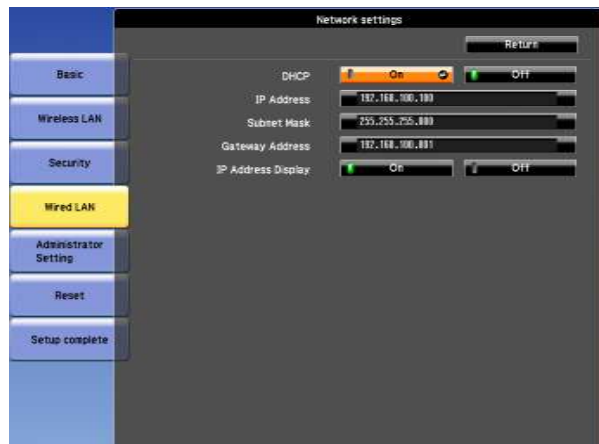

Submenu	Function
DHCP	You can set whether or not (On/Off) to use <u>DHCP</u> . If this is set to On , you cannot set any more addresses.

Submenu	Function
IP Address	You can input the <u>IP address</u> assigned to the projector. You can enter a number from 0 to 255 in each field of the address. However, the following IP addresses cannot be used. 0.0.0.0, 127.x.x.x, 224.0.0.0 to 255.255.255.255 (where x is a number from 0 to 255)
Subnet Mask	You can input the <u>Subnet Mask</u> for the projector. You can enter a number from 0 to 255 in each field of the address. However, the following subnet masks cannot be used. 0.0.0.0, 255.255.255.255
Gateway Address	You can input the IP address for the gateway for the projector. You can enter a number from 0 to 255 in each field of the address. However, the following <u>Gateway addresses</u> cannot be used. 0.0.0.0, 127.x.x.x, 224.0.0.0 to 255.255.255.255 (where x is a number from 0 to 255)
IP Address Display	To prevent the IP address from being displayed on the LAN Standby screen, set this to Off .

Administrator Settings menu



Submenu	Function
Administrator Password	Enter the password for the Administrator Settings menu for network settings. You can enter up to 16 single-byte alphanumeric characters. (* cannot be used.) If the administrator password is not set, click OK with an empty password box.
Network Host Name	This name is used to identify the projector on a network. Use for Web control, "Connect to a Network Projector" and so on. When editing, you can enter up to 15 single-byte alphanumeric characters. (The only symbols you can use are - _ . The first character should be a letter, and the last character should be a letter or a number.)
PJLink Password	Set a password to use when you access the projector using compatible PJLink software. You can enter up to 32 single-byte alphanumeric characters. (Symbols cannot be used.) ☛ "About PJLink" p.151

Submenu	Function
Web Control Password	Set a password to use when making settings and controlling the projector using Web Control. You can enter up to 8 single-byte alphanumeric characters. (* cannot be used.) Web Control is a computer function that allows you to set up and control the projector by using the Web browser on a computer connected on a network. ☛ "Changing Settings Using a Web Browser (Web Control)" p.145
Monitor Password	Set a password to use EasyMP Monitor. You can enter up to 16 single-byte alphanumeric characters. (* cannot be used.)
Secure HTTP	To strengthen security, communication between the projector and computer in Web control is encrypted. When setting security with Web control, it is recommended to set this to On .
Mail Notification	Goes to the Mail Notification setting menu. ☛ "Mail Notification menu" p.99
Manage Certificates	Goes to the Manage Certificates settings menu. ☛ "Manage Certificates menu" p.100
SNMP	Goes to the SNMP settings menu. ☛ "SNMP menu" p.100
Priority Gateway	For the priority gateway, select either Wired or Wireless .
AMX Device Discovery	When you want to allow the projector to be detected by <u>AMX Device Discovery</u>  , set this to On . Set this to Off if you are not connected to an environment controlled by a controller from AMX or AMX Device Discovery.
Crestron Room-View	Set this to On only when monitoring or controlling the projector over the network using Crestron RoomView®. Otherwise, set this to Off . ☛ "About Crestron RoomView®" p.152 Changes in projector settings take effect upon restarting. When this is set to On , the following functions are not available. <ul style="list-style-type: none"> • Web control • Message Broadcasting (EasyMP Monitor plugin)

Submenu	Function
Bonjour	Set this to On when connecting to the network using Bonjour. See Apple's Web site for more information on the Bonjour service. http://www.apple.com/
EPSON Message Broadcasting	You can switch the EPSON Message Broadcasting function to enable or disable. You can download Message Broadcasting and its Operation Guide from the following Web site. http://www.epson.com

Mail Notification menu

When this is set, you receive an email notification if a problem or warning occurs in the projector.

☛ "Reading Error Notification Mail" [p.148](#)



Submenu	Function
Mail Notification	Set to On to send an email to the preset addresses when a problem or warning occurs with a projector.

Submenu	Function
SMTP Server	You can input the <u>IP address</u> for the SMTP server for the projector. You can enter a number from 0 to 255 in each field of the address. However, the following IP addresses cannot be used. 127.x.x.x, 224.0.0.0 to 255.255.255.255 (where x is a number from 0 to 255)
Port Number	You can input the port number for the SMTP server. The default value is 25. You can input numbers between 1 to 65535.
Email Address 1/ Email Address 2/ Email Address 3	You can input the email address of the destination to send the notification email to. You can register up to three destinations. You can enter up to 64 single-byte alphanumeric characters for the email addresses. (" () , ; < > [¥] cannot be used.) You can enter up to 32 characters on the Configuration menu. When entering more than 32 characters, use your Web browser to enter the text. ☛ "Changing Settings Using a Web Browser (Web Control)" p.145 The address for destination 1 is the mail notification sender's address.
Setting a Notifi- cation Event	You can select the problems or warnings to be notified about by email. When the selected problem or warning occurs in the projector, an email is sent to the specified Email Address notifying that a problem or warning has occurred. You can select multiple items from the displayed items.

Manage Certificates menu



Submenu	Function
Web Server Certificate	(This item can only be set when Secure HTTP is set to On .) The Issued to , Issued by , and Validity period information on the certificate set in the projector is displayed. This information is not displayed when a Self-signed Certificate is set. Select Clear to delete the stored certificate.

Web Control is used to set certificates.
 "Setting Certificates" [p.146](#)

Submenu	Function
Client Certificate	Displays the Issued to , Issued by , and Validity period information set in the stored client certificate. It is blank if the certificate is not set. You need to set Client Certificate when WPA/WPA2-EAP is selected in Security , and PEAP-TLS or EAP-TLS are selected in EAP Method . Select Clear to delete the stored certificate.
CA certificate	Displays the Issued to , Issued by , and Validity period information set in the stored CA certificate. It is blank if the certificate is not set. You need to set CA certificate when WPA/WPA2-EAP is selected in Security , when verifying the authentication server certificate. Select Clear to delete the stored certificate.
Self-signed Certificate	(This item can only be set when Secure HTTP is set to On .) The Issued to , Issued by , and Validity period information on the certificate maintained by the server function in the projector is displayed. This information is not displayed if Web Server Certificate is set. Select Refresh to update the self-signed certificate.

SNMP menu

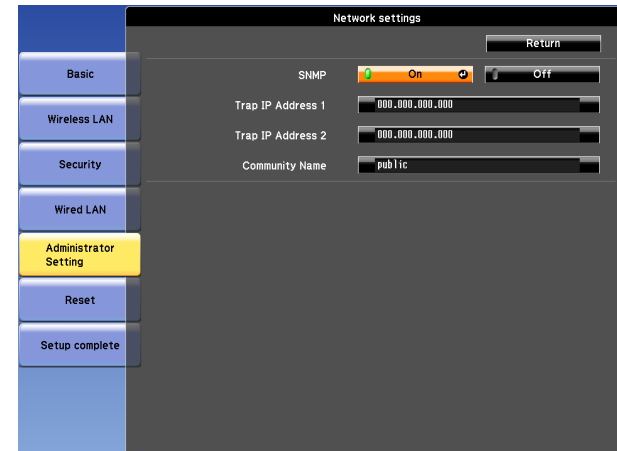

Submenu	Function
SNMP	Set to On to monitor the projector using SNMP . To monitor the projector, you need to install the SNMP manager program on your computer. SNMP should be managed by a network administrator. The default value is Off .

Submenu	Function
Trap IP Address 1/Trap IP Address 2	You can register up to two IP addresses for the SNMP trap notification destination. You can enter a number from 0 to 255 in each field of the address. However, the following IP addresses cannot be used. 127.x.x.x, 224.0.0.0 to 255.255.255.255 (where x is a number from 0 to 255)
Community Name	Set the community name of SNMP. You can enter up to 32 single-byte alphanumeric characters. (The only symbol you can use is @.)

Reset menu

Resets all of the network settings.

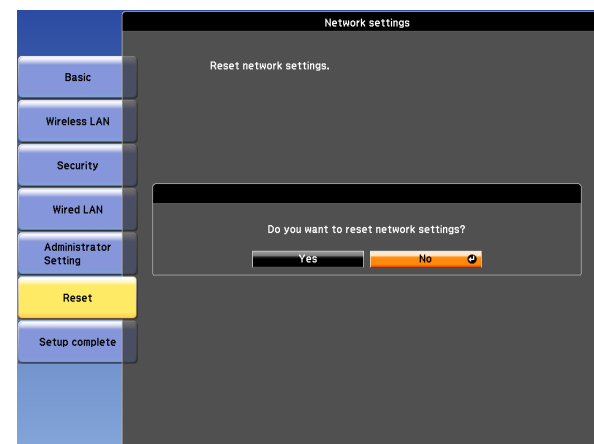

Submenu	Function
Reset network settings.	To reset all of the Network settings, select Yes . When you reset the network settings, the Passphrase, Administrator Password and Manage Certificates menu settings change back to their default values, and the certificates are deleted. After you reset all the settings, the Basic menu appears.

Info Menu (Display Only)

Lets you check the status of the image signals being projected and the status of the projector. Items that can be displayed vary depending on the source currently being projected.

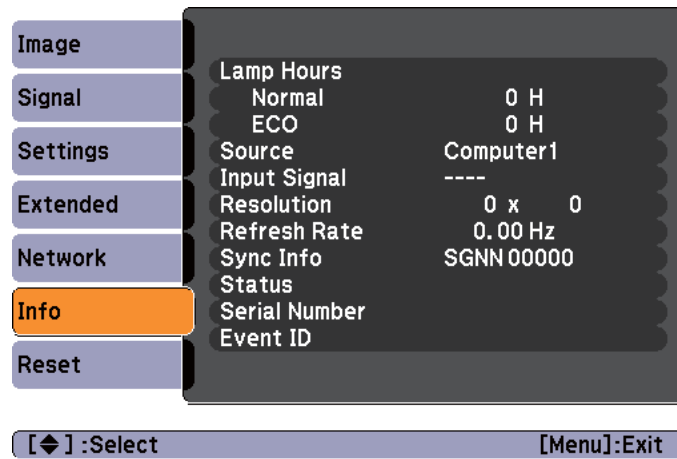

Submenu	Function
Status	This is information about errors that have occurred on the projector. This information may be needed if service is required.
Serial Number	Displays the projector's serial number.
Event ID	Displays the application error log. ☞ "About Event ID" p.122

* The cumulative use time is displayed as "0H" for the first 10 hours. 10 hours and above is displayed as "10H", "11H", and so on.

Submenu	Function
Lamp Hours	You can display the cumulative lamp operating time*. When the lamp replacement time is reached, the characters are displayed in yellow.
Source	You can display the source name for the connected equipment currently being projected.
Input Signal	You can display the content of Input Signal set in the Signal menu according to the source.
Resolution	You can display the resolution.
Video Signal	You can display the settings for Video Signal in the Signal menu.
Refresh Rate	You can display the <u>refresh rate</u> ▶▶.
Sync Info	You can display the image signal information. This information may be needed if service is required.

Reset Menu

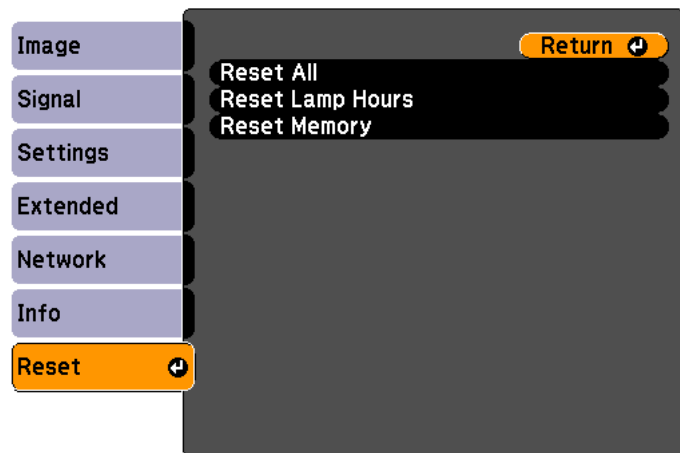

[Esc] / [↩]:Return [⬇]:Select [Menu]:Exit

Submenu	Function
Reset All	You can reset all items in the Configuration menu to their default settings. The following items are not reset to their defaults: Input Signal , User's Logo , all items for Network menus, Lamp Hours , Language , Password , Multi-screen , Date & Time , Panel Alignment , and Color Uniformity .
Reset Lamp Hours	Clears the cumulative lamp hours use time. Reset when you replace the lamp.
Reset Memory	The name and settings saved in Save Memory are reset. ☛ "Memory Function" p.67



Troubleshooting

This chapter explains how to identify problems and what to do if a problem is found.

If a problem occurs with the projector, the Help screen is displayed to assist you by pressing the Help button. You can solve problems by answering the questions.

- 1 Press the [Help] button.
The Help screen is displayed.

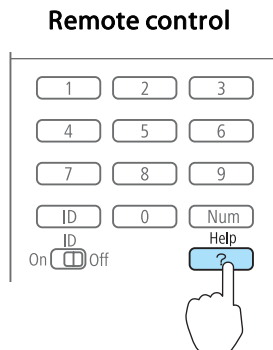

- 2 Select a menu item.

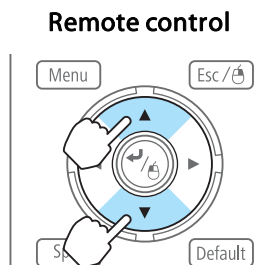
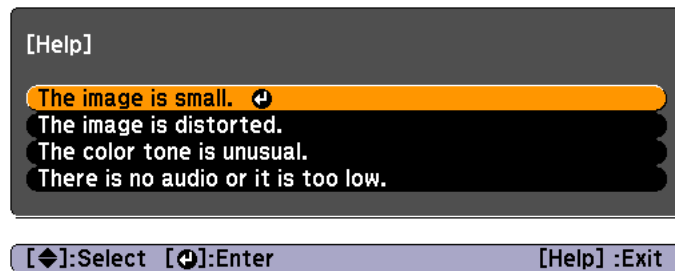

- 3 Confirm the selection.

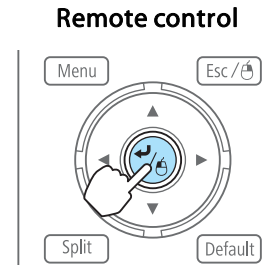

Questions and solutions are displayed as shown on the screen below. Press the [Help] button to exit the Help.

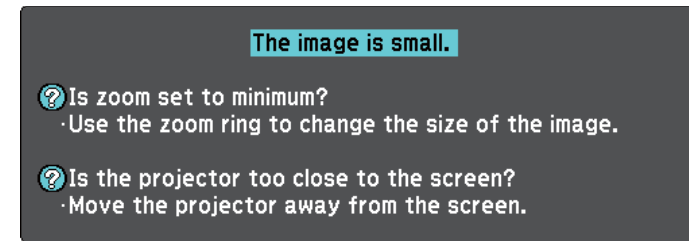

[Esc] :Return [Help] :Exit

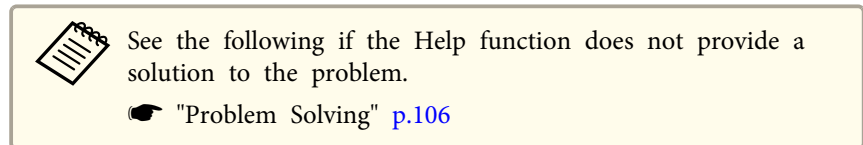

If you are having a problem with the projector, first check the projector's indicators and refer to "Reading the Indicators" below.

See the following if the indicators do not show clearly what the problem might be.

☛ "When the Indicators Provide No Help" [p.110](#)

Reading the Indicators

The projector is provided with the following four indicators that indicate the operating status of the projector.

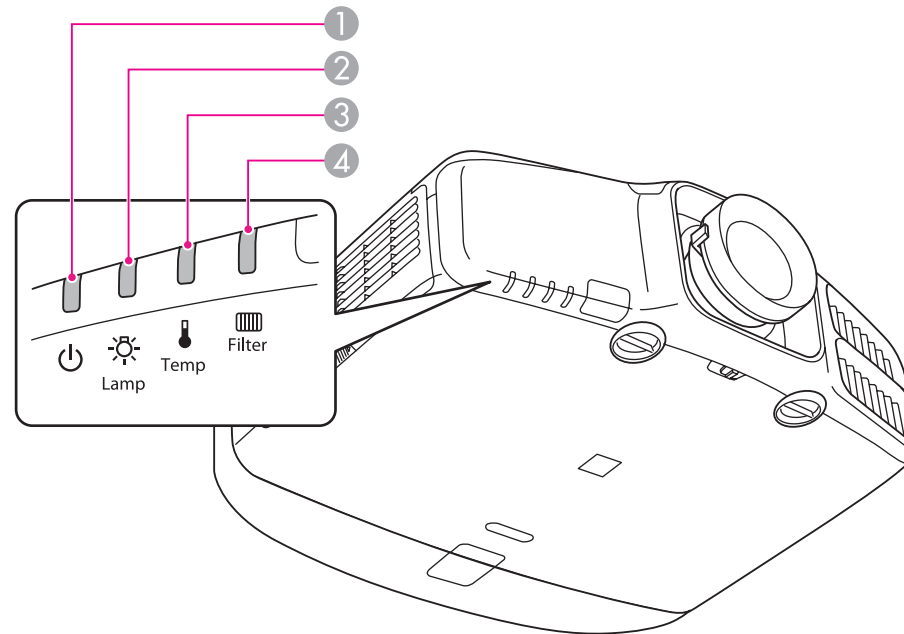

1 Power indicator

Indicates the operating status.

 Standby condition

In this status, you can start projecting by pressing the [⏻] button on the remote control, or the [⏻] button on the control panel.



Preparing for network monitoring or cool down in progress
All buttons are disabled while the indicator is flashing.



Warming up

Warm-up time is about 30 seconds. After warm-up is complete, the indicator stops flashing. The [⏻] button is disabled during warm-up.



Projecting

- ② Lamp indicator
- ③ Temp indicator
- ④ Filter indicator

Indicates the projection lamp status.

Indicates the internal temperature status.

Indicates the air filter status.























Refer to the following table to see what the indicators mean and how to remedy problems that they indicate.



If all indicators are off, check that the power cord is connected correctly and that the power is being supplied normally.

Sometimes, when the power cord is unplugged, the [⏻] indicator remains lit for a short period, but this is not a fault.

■ : Lit ■■■ : Flashing □ : Off □□ : Varies according to the projector status

Status	Cause	Remedy or Status
■ ■■ ■■■ ■■ ■■■ ■■ □ □□	Internal Error	Stop using the projector, remove the power plug from the electrical outlet, and contact your local dealer or the nearest address provided in the Epson Projector Contact List. 🖱 Epson Projector Contact List
■ ■■ □ ■■ ■■■ ■■ □ □□	Fan Error Sensor Error	Stop using the projector, remove the power plug from the electrical outlet, and contact your local dealer or the nearest address provided in the Epson Projector Contact List. 🖱 Epson Projector Contact List
■ ■■ □ ■■ ■ ■■ □ □□	High Temp Error (Overheating)	The lamp turns off automatically and projection stops. Wait for about five minutes. After about five minutes the projector switches to standby mode, so check the following two points. <ul style="list-style-type: none"> • Check that the air filter and air exhaust vent are clear, and that the projector is not positioned against a wall. • If the air filter is clogged, clean or replace it. <ul style="list-style-type: none"> 🖱 "Cleaning the Air Filter" p.125 🖱 "Replacing the Air Filter" p.131 If the error continues after checking the points above, stop using the projector, remove the power plug from the electrical outlet, and contact your local dealer or the nearest address provided in the Epson Projector Contact List. 🖱 Epson Projector Contact List

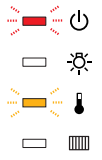
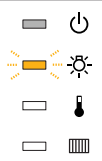
Status	Cause	Remedy or Status
		When using at an altitude of 1500 m or more, set High Altitude Mode to On .  "Extended Menu" p.86
    	Lamp Error Lamp Failure	Check the following two points. <ul style="list-style-type: none"> • Take out the lamp and check if it is cracked.  "Replacing the Lamp" p.128 • Clean the air filter.  "Cleaning the Air Filter" p.125 <p>If the lamp is not cracked: Reinstall the lamp and turn on the power.</p> <p>If the error continues: Replace the lamp with a new one and then turn on the power.</p> <p>If the error continues: Stop using the projector, remove the power plug from the electrical outlet, and contact your local dealer or the nearest address provided in the Epson Projector Contact List.  Epson Projector Contact List</p> <p>If the lamp is cracked: Contact your local dealer or the nearest address provided in the Epson Projector Contact List. (Images cannot be projected until the lamp is replaced.)  Epson Projector Contact List</p> <p>When using at an altitude of 1500 m or more, set High Altitude Mode to On.  "Extended Menu" p.86</p>
   	Auto Iris Error Power Err. (Ballast)	Stop using the projector, remove the power plug from the electrical outlet, and contact your local dealer or the nearest address provided in the Epson Projector Contact List.  Epson Projector Contact List
   	Filter Airflow Error	Check the following two points. <ul style="list-style-type: none"> • Check that the air filter and air exhaust vent are clear, and that the projector is not positioned against a wall. • If the air filter is clogged, clean or replace it.  "Cleaning the Air Filter" p.125  "Replacing the Air Filter" p.131 <p>If the error continues after checking the points above, stop using the projector, remove the power plug from the electrical outlet, and contact your local dealer or the nearest address provided in the Epson Projector Contact List.  Epson Projector Contact List</p>

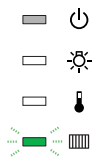
Status	Cause	Remedy or Status
	High Temp Warning	(This is not an abnormality. However, if the temperature rises too high again, projection stops automatically.) <ul style="list-style-type: none"> • Check that the air filter and air exhaust vent are clear, and that the projector is not positioned against a wall. • If the air filter is clogged, clean or replace it. <ul style="list-style-type: none"> ☛ "Cleaning the Air Filter" p.125 ☛ "Replacing the Air Filter" p.131
	Replace Lamp	Replace it with a new lamp. <ul style="list-style-type: none"> ☛ "Replacing the Lamp" p.128 If you continue to use the lamp after the replacement period has passed, the possibility that the lamp may explode increases. Replace it with a new lamp as soon as possible.
	Low Air Flow	Check the following two points. <ul style="list-style-type: none"> • Check that the air filter and air exhaust vent are clear, and that the projector is not positioned against a wall. • If the air filter is clogged, clean or replace it. <ul style="list-style-type: none"> ☛ "Cleaning the Air Filter" p.125 ☛ "Replacing the Air Filter" p.131 If the error continues after checking the points above, stop using the projector, remove the power plug from the electrical outlet, and contact your local dealer or the nearest address provided in the Epson Projector Contact List. <ul style="list-style-type: none"> ☛ Epson Projector Contact List
	Air Filter Notice	"Time to clean the air filter. Clean or replace the air filter." is displayed. Clean the air filter. <ul style="list-style-type: none"> ☛ "Cleaning the Air Filter" p.125 The indicators or messages regarding Air Filter Notice are displayed only when Air Filter Notice is set to On from the Configuration menu. <ul style="list-style-type: none"> ☛ Extended - Display - Air Filter Notice p.86













- See the following if the projector is not operating properly, even though the indicators are all showing normal.
 - ☛ "When the Indicators Provide No Help" [p.110](#)
- If the indicators are in a state not shown in this table, stop using the projector, remove the power plug from the electrical outlet, and contact your local dealer or the nearest address provided in the Epson Projector Contact List.
 - ☛ [Epson Projector Contact List](#)

When the Indicators Provide No Help

If any of the following problems occur and the indicators do not offer a solution, refer to the pages given for each problem.

Problems Relating to Images







<ul style="list-style-type: none"> • No images appear Projection does not start, the projection area is completely black, or the projection area is completely blue. 	 p.111
<ul style="list-style-type: none"> • Moving images are not displayed Videos played back on a computer are black or no image is projected, or the video is not played back on the computer. 	 p.111
<ul style="list-style-type: none"> • Projection stops automatically 	 p.112
<ul style="list-style-type: none"> • The message "Not supported" is displayed 	 p.112
<ul style="list-style-type: none"> • The message "No Signal" is displayed 	 p.112
<ul style="list-style-type: none"> • Images are fuzzy, out of focus, or distorted 	 p.113
<ul style="list-style-type: none"> • Interference or distortion appear in images 	 p.113
<ul style="list-style-type: none"> • The image is truncated (large) or small, the aspect ratio is not suitable, or the image has been reversed Only part of the image is displayed, the height and width ratios of the image are not correct, or the image may appear reversed from top to bottom or left to right. 	 p.114
<ul style="list-style-type: none"> • Image colors are not right The whole image appears purplish or greenish, images are black & white, or colors appear dull. 	 p.115
<ul style="list-style-type: none"> • Images appear dark 	 p.116

Problems when projection starts

<ul style="list-style-type: none"> • The projector does not turn on 	 p.116
---	---

Other Problems

<ul style="list-style-type: none"> • No sound can be heard or the sound is faint 	 p.117
--	---

<ul style="list-style-type: none"> • The remote control does not work 	 p.118
<ul style="list-style-type: none"> • Nothing appears on the external monitor 	 p.119
<ul style="list-style-type: none"> • I want to change the language for messages and menus 	 p.119
<ul style="list-style-type: none"> • The authentication setting of wireless LAN fails 	 p.120
<ul style="list-style-type: none"> • Email is not received even if a problem occurs in the projector 	 p.120
<ul style="list-style-type: none"> • "The battery that saves your clock settings is running low." is displayed 	 p.120
<ul style="list-style-type: none"> • Cannot change settings using a Web browser 	 p.121

Problems Relating to Images

No images appear



Check	Remedy
Did you press the [ⓘ] button on the remote control or the [⏻] button on the control panel?	Press the [ⓘ] button on the remote control or the [⏻] button on the control panel to turn on the projector.
Are the indicators switched off?	The power cord is not connected correctly or power is not being supplied. Connect the projector's power cord correctly. Check that your electrical outlet or power source is functioning correctly.
Is A/V Mute active?	Press the [A/V Mute] button to release A/V Mute. ☛ "Hiding the Image and Sound Temporarily (A/V Mute)" p.63
Are the Configuration menu settings correct?	Reset all of the settings. ☛ Reset - Reset All p.103
Is the image to be projected completely black? (Only when projecting computer images)	Some input images, such as screen savers, may be completely black.
Is the image signal format setting correct? (Only when projecting images from a video source)	Change the setting according to the signal for the connected equipment. ☛ Signal - Video Signal p.82
Is Windows Media Center displayed in full screen? (Only during network connection)	When Windows Media Center is displayed at full screen, you cannot project using a network connection. Reduce the screen size.
Is an application using the Windows DirectX function displayed? (Only during network connection)	Applications using the Windows DirectX function may not display images correctly.

Moving images are not displayed

Check	Remedy
Is the computer's image signal being output to the LCD and the monitor? (Only when projecting images from a laptop computer or a computer with a built-in LCD screen)	Change the image signal from the computer to external output only. Check your computer's documentation, or contact the computer's manufacturer.

Check	Remedy
Are the contents of the moving image you are trying to project copyright protected?	The projector may not be able to project copyright protected moving images that are being played back on a computer. For more details, see the user's guide supplied with the player.

Projection stops automatically

Check	Remedy
Is Sleep Mode set to On ?	Press the [] button on the remote control or the [] button on the control panel to turn on the projector. If you do not want to use Sleep Mode, change the setting to Off . ☛ Extended - Operation - Sleep Mode p.86

The message "Not supported" is displayed

Check	Remedy
Is the image signal format setting correct? (Only when projecting images from a video source)	Change the setting according to the signal for the connected equipment. ☛ Signal - Video Signal p.82
Do the image signal resolution and the refresh rate correspond to the mode? (Only when projecting computer images)	Refer to the computer's documentation for how to change the image signal resolution and the refresh rate output from the computer. ☛ "Supported Monitor Displays" p.169

The message "No Signal" is displayed

Check	Remedy
Are the cables connected correctly?	Check that all the cables required for projection are securely connected. Check that no cables are disconnected and that there are no poor contacts in the cables.
Is the correct port selected?	Press the [Search] button or the [Source Search] button to change the image. ☛ "Automatically Detect Input Signals and Change the Projected Image (Source Search)" p.41
Is the power for the computer or video source turned on?	Turn the power on for the equipment.

Check	Remedy
Are the image signals being output to the projector? (Only when projecting images from a laptop computer or a computer with a built-in LCD screen)	If the image signals are only being output to the computer's LCD monitor or to the accessory monitor, you need to change the output to an external destination as well as the computer's own monitor. For some computer models, when the image signals are output externally, they no longer appear on the LCD monitor or accessory monitor. If the connection is made while the power of the projector or computer is already turned on, the Fn key (Function key) that changes the computer's image signal to external output may not work. Turn the power for the computer and the projector off and then back on again. 🖱️ Computer's documentation

Images are fuzzy, out of focus, or distorted

Check	Remedy
Is the focus adjusted correctly?	Turn the focus ring to adjust the focus. 🖱️ "Correcting the Focus" p.26
Is the projector at the correct distance?	Is it projecting outside of the recommended projection distance range? Setup within the recommended range. 🖱️ "Screen Size and Projection Distance" p.158
Has condensation formed on the lens?	If the projector is suddenly taken from a cold environment to a warm environment, or if sudden ambient temperature changes occur, condensation may form on the surface of the lens, and this may cause the images to appear fuzzy. Set the projector up in the room about one hour before it is used. If condensation forms on the lens, turn the projector off and wait for the condensation to disappear.
Are you using the optional short throw zoom lens (ELPLU01)?	Set the Lens Type to ELPLU01 from the configuration menu. 🖱️ Extended - Operation - Lens Type p.86 See the following for more information on focus correction methods. 🖱️ "When using the short throw zoom lens ELPLU01" p.26

Interference or distortion appear in images

Check	Remedy
Is the image signal format setting correct? (Only when projecting images from a video source)	Change the setting according to the signal for the connected equipment. 🖱️ Signal - Video Signal p.82

Check	Remedy
Are the cables connected correctly?	Check that all the cables required for projection are securely connected. ☛ "Connecting Equipment" p.31
Is an extension cable being used?	If an extension cable is used, electrical interference may affect the signals. Use the cables supplied with the projector to check if the cables you are using may be causing the problem.
Is the correct resolution selected? (Only when projecting computer images)	Set the computer so that the signals being output are compatible with the projector. ☛ "Supported Monitor Displays" p.169 ☛ Computer's documentation
Are the <u>Sync</u> and <u>Tracking</u> settings adjusted correctly? (Only when projecting computer images)	Press the [Auto] button on the remote control or the [↵] button on the control panel to perform automatic adjustment. If the images are not adjusted correctly even after performing automatic adjustment, you can also make adjustments from the Configuration menu. ☛ Signal - Tracking, Sync. p.82
Is the Resolution set to anything other than Auto ? (Only when projecting on a split screen)	The image may be collapsed if the Resolution on the Configuration menu and the resolution of the projected image are not the same. If the image is collapsed, set the Resolution to Auto . ☛ Signal - Resolution p.82

The image is truncated (large) or small, the aspect is not suitable, or the image has been reversed

Check	Remedy
Have the Screen been set correctly?	Make the appropriate Screen for the screen being used. ☛ "Screen Settings" p.22
Is the aspect adjusted correctly?	Press [Aspect] button, and then select the aspect according to the input signal. ☛ "Changing the Aspect Ratio of the Projected Image" p.47
Is a wide panel computer image being projected? (Only when projecting computer images)	Change the setting according to the signal for the connected equipment. ☛ Signal - Resolution p.82
Is the image still being enlarged by E-Zoom?	Press the [Esc] button on the remote control to cancel E-Zoom. ☛ "Enlarging Part of the Image (E-Zoom)" p.64
Is Scale set to On ?	Set Scale to Off on the configuration menu. ☛ Signal - Scale p.82

Check	Remedy
Is the image position adjusted correctly?	(Only when projecting analog RGB signals input from the Computer port) Press the [Auto] button on the remote control or the [↵] button on the control panel to adjust the position. You can also adjust the position from the Configuration menu. 🖱️ Signal - Position p.82
Is the computer set for dual display? (Only when projecting computer images)	If dual display is activated in the Display Properties of the computer's Control Panel, only about half of the image on the computer screen is projected. To display the entire image on the computer screen, turn off the dual display setting. 🖱️ Computer video driver documentation
Is the correct resolution selected? (Only when projecting computer images)	Set the computer so that the signals being output are compatible with the projector. 🖱️ "Supported Monitor Displays" p.169 🖱️ Computer's documentation
Is the image direction correct?	Make the correct settings in Projection from the Configuration menu. 🖱️ "Installation Requirements" p.20

Image colors are not right

Check	Remedy
Do the input signal settings match the signals from the connected device?	Change the following settings according to the signal for the connected equipment. <ul style="list-style-type: none"> • When the image is from a device connected to the Computer port or the BNC port 🖱️ Signal - Input Signal p.82 • When the image is from a device connected to the Video port or the S-Video port 🖱️ Signal - Video Signal p.82
Is the image brightness adjusted correctly?	Adjust the Brightness setting from the Configuration menu. 🖱️ Image - Brightness p.81
Are the cables connected correctly?	Check that all the cables required for projection are securely connected. Check that no cables are disconnected and that there are no poor contacts in the cables. 🖱️ "Connecting Equipment" p.31
Is the <u>contrast</u>  adjusted correctly?	Adjust the Contrast setting from the Configuration menu. 🖱️ Image - Contrast p.81

Check	Remedy
Is the color adjustment set correctly?	Adjust the Gamma , RGB , or RGBCMY setting from the Configuration menu. 🖱️ Image - Advanced p.81 🖱️ "Adjusting the Image" p.49
Are the color saturation and tint adjusted correctly? (Only when projecting images from a video source)	Adjust the Color Saturation and Tint settings from the Configuration menu. 🖱️ Image - Color Saturation, Tint p.81

Images appear dark

Check	Remedy
Is the image brightness set correctly?	Check the Brightness and Power Consumption settings from the Configuration menu. 🖱️ Image - Brightness p.81 🖱️ Settings - Power Consumption p.84
Is the <u>contrast</u> adjusted correctly?	Adjust the Contrast setting from the Configuration menu. 🖱️ Image - Contrast p.81
Is it time to replace the lamp?	When the lamp is nearly ready for replacement, the images become darker and the color quality becomes poorer. When this happens, replace the lamp with a new lamp. 🖱️ "Replacing the Lamp" p.128
Is only one projector being used?	Check if the following items are set to dark. 🖱️ Extended - Multi-Projection - Brightness Level p.86 🖱️ Extended - Multi-Projection - Multi-screen p.86

Problems when Projection Starts

The projector does not turn on

Check	Remedy
Did you press the [⏻] button on the remote control or the [⏻] button on the control panel?	Press the [⏻] button on the remote control or the [⏻] button on the control panel to turn on the projector.

Check	Remedy
Are the indicators switched off?	The power cord is not connected correctly or power is not being supplied. Disconnect and then reconnect the power cord. Check that your electrical outlet or power source is functioning correctly.
Do the indicators turn on and off when the power cord is touched?	There is probably a poor contact in the power cable, or the power cable may be defective. Reinsert the power cable. If this does not solve the problem, stop using the projector, disconnect the power cable from the electrical outlet, and contact your local dealer or the nearest address provided in the Epson Projector Contact List. ☛ Epson Projector Contact List
Is the Control Panel Lock set to Full Lock ?	Press the [Ⓜ] button on the remote control. If you do not want to use Control Panel Lock , change the setting to Off . ☛ "Control Panel Lock" p.74
Is the correct setting for the remote receiver selected?	Check the Remote Receiver from the Configuration menu. ☛ Settings - Remote Receiver p.84
Was the power cable plugged back in or was the breaker turned on immediately after Direct Power Off?	When the operation to the left is performed when Direct Power On is set to On , the power may not turn back on. Press the [Ⓜ] button on the remote control or the [Ⓜ] button on the control panel to turn on the projector.
Is the [ID] switch on the remote control set to On?	When the switch is set to On, you can use the remote control to operate only a projector with a matching ID. Set the [ID] switch to Off. ☛ "Setting the remote control ID" p.29
Are the lamp cover and lamps installed correctly?	If the lamp or lamp cover is installed incorrectly, the projector cannot be turned on. Check how it is installed. ☛ "How to replace the lamp" p.129

Other Problems

No sound can be heard or the sound is faint

Check	Remedy
Check that the audio/video cable is securely attached to both the projector and audio source.	Disconnect the cable from the Audio port, and then reconnect the cable.

Check	Remedy
Is the projector volume set to the minimum?	Adjust the volume so that sound can be heard. ⚙️ Settings - Volume p.84 ⚙️ "Adjusting the Volume" p.42
Is the volume for the computer or from the image source set to the minimum?	Adjust the volume so that sound can be heard.
Is A/V Mute active?	Press the [A/V Mute] button to release A/V Mute. ⚙️ "Hiding the Image and Sound Temporarily (A/V Mute)" p.63
Is the audio cable's specification "No resistance"?	When using a commercially available audio cable, make sure it is labeled "No resistance".
Is it connected with an HDMI cable?	If no audio is output when connecting via an HDMI cable, set the connected equipment to PCM output.
Is the correct audio input selected?	Check the Audio Settings from the configuration menu. ⚙️ Extended - A/V Settings - Audio Settings p.86

The remote control does not work

Check	Remedy
Is the remote control light-emitting area pointing towards the remote receiver on the projector during operation?	Point the remote control towards the remote receiver. ⚙️ "Remote control operating range" p.15
Is the remote control too far from the projector?	The operating range for the remote control is about 15 m. ⚙️ "Remote control operating range" p.15
Is direct sunlight or strong light from fluorescent lamps shining onto the remote receiver?	Set the projector up in a location where strong light does not shine onto the remote receiver.
Is the correct setting for the Remote Receiver selected?	Check the Remote Receiver from the Configuration menu. ⚙️ Settings - Remote Receiver p.84
Are the batteries dead or have the batteries been inserted correctly?	Make sure the batteries are inserted correctly or replace the batteries with new ones if necessary. ⚙️ "Replacing the remote control batteries" p.14
Are the remote control ID and the projector ID matched?	Make sure the ID for the projector you want to operate and the ID for the remote control match. To operate all projectors by remote control regardless of the ID setting, set the [ID] switch on the remote control to Off. ⚙️ "ID Settings" p.28

Check	Remedy
Does Remote Control Type match the remote control that you are using?	Check the Remote Control Type on the configuration menu. ☛ Extended - Operation - Remote Control Type p.86
Is the optional remote control cable connected to the projector's Remote port?	When the remote control cable is connected, the projector's remote receiver is disabled. When not using the remote control cable set, disconnect it from the Remote port.
Is Control Communications set to On ? (EB-G6750WU only)	The Remote port is disabled. When using the optional remote control cable set, set Control Communications to Off . ☛ Extended - HDBaseT - Control Communications p.86
Is the remote control button lock set?	When the remote control button lock is set, buttons except for those needed for basic remote control operations are deactivated. Hold down the [Help] button to cancel the remote control button lock. ☛ "Remote control button lock" p.75

Nothing appears on the external monitor

Check	Remedy
Are images input from a port other than the Computer port or BNC port?	Only RGB signals from the Computer port or the BNC port can be displayed on an external monitor.
Are you projecting a split screen?	Only RGB signals projected on the left screen from the Computer port or the BNC port can be displayed on an external monitor. ☛ "Projecting Two Images Simultaneously (Split Screen) " p.60
Is the projector in standby status?	Check that Standby Mode , A/V Output , and Monitor Out from the Configuration menu are set correctly. ☛ Extended - Standby Mode p.86 ☛ Extended - A/V Settings p.86

I want to change the language for messages and menus

Check	Remedy
Change the Language setting.	Adjust the Language setting from the Configuration menu. ☛ Extended - Language p.86

The authentication setting of wireless LAN fails

Check	Remedy
Is the time set correctly?	If the wireless LAN is set correctly but the authentication setting fails, the time may not be set correctly. Check if it is set correctly. ☛ "Setting the Time" p.29

Email is not received even if a problem occurs in the projector

Check	Remedy
Is Standby Mode set to Communication On ?	To use the Mail Notification function when the projector is in standby, set Communication On in Standby Mode from the Configuration menu. ☛ Extended - Standby Mode p.86
Did a fatal abnormality occur and the projector come to a sudden stop?	When the projector comes to a sudden stop, email cannot be sent. If the abnormal state continues, contact your local dealer or the nearest address provided in the Epson Projector Contact List. ☛ Epson Projector Contact List
Is power being supplied to the projector?	Check that your electrical outlet or power source is functioning correctly.
Is the Mail Notification function set correctly in the Configuration menu?	An error notification email is sent according to the Mail settings in the Configuration menu. Check if it is set correctly. ☛ "Administrator Settings menu" p.98

"The battery that saves your clock settings is running low." is displayed

Check	Remedy
The internal power supply that saves your clock settings is running low.	Contact your local dealer or the nearest address provided in the Epson Projector Contact List. ☛ Epson Projector Contact List







Cannot change settings using a Web browser

Check	Remedy
Are the user ID and password correct?	Enter "EPSONWEB" as the user ID. This cannot be changed. Enter the user ID even if the password setting is disabled. Enter the characters set for the Web Control Password as the password. The default password is "admin".

Check the numbers and then apply the following countermeasures. If you cannot resolve the problem, contact your network administrator, or contact your local dealer or the nearest address provided in the Epson Projector Contact List.

 [Epson Projector Contact List](#)

Event ID	Cause	Remedy
0432 0435	Failed to startup EasyMP Network Projection.	Restart the projector.
0434 0481 0482 0485	Network communication is unstable.	Check the network communication status, and reconnect after waiting for a while.
0433	Cannot play transferred images.	Restart EasyMP Network Projection.
0484	Communication was disconnected from the computer.	
04FE	EasyMP Network Projection ended unexpectedly.	Check the status of network communications. Restart the projector.
04FF	A system error occurred in the projector.	Restart the projector.
0891	Cannot find an access point with the same SSID.	Set the computer, the access point, and the projector to the same SSID.
0892	The WPA/WPA2 authentication type does not match.	Check that the wireless LAN security settings are correct.
0893	The WEP/TKIP/AES encryption type does not match.	 "Security menu " p.94
0894	Communication was disconnected because the projector connected to an unauthorized access point.	Contact your network administrator for more information.
0898	Failed to acquire DHCP.	Check the DHCP server to see if it is operating correctly and check the LAN cable to see if it is connected correctly. If you are not using DHCP, turn off the DHCP setting.  "Network Menu" p.89
0899	Other communication errors	If restarting the projector or EasyMP Network Projection does not solve the problem, contact your local dealer or the nearest address provided in the Epson Projector Contact List.  Epson Projector Contact List
089A	The EAP authentication type is not the same.	Check that the wireless LAN security settings are correct. Also, check if the certificate is installed correctly.
089B	EAP server authentication failed.	 "Security menu " p.94
089C	EAP client authentication failed.	



Event ID	Cause	Remedy
089D	Key exchange failed.	



Maintenance

This chapter provides information on maintenance procedures to ensure the best level of performance from the projector for a long time to come.

You should clean the projector if it becomes dirty or if the quality of projected images starts to deteriorate.



Caution

When cleaning, unplug the power cable from the electric outlet. Otherwise, it could cause an electric shock.

Cleaning the Projector's Surface

Clean the projector's surface by wiping it gently with a soft cloth.

If the projector is particularly dirty, moisten the cloth with water containing a small amount of neutral detergent, and then firmly wring the cloth dry before using it to wipe the projector's surface.

Attention

Do not use volatile substances such as wax, alcohol, or thinner to clean the projector's surface. The quality of the case may change or become discolored.

Cleaning the Lens

Use a commercially available cloth for cleaning glasses to gently wipe the lens.



Warning

Do not use sprays that contain flammable gas to remove dust and lint from the lens. The projector may catch fire due to the high internal temperature of the lamp.

Attention

Do not rub the lens with harsh materials or subject the lens to shocks, as it can easily become damaged.

Cleaning the Air Filter

When the following message is displayed and the filter indicator flashes green, clean the air filter and the air intake vent.

"Time to clean the air filter. Clean or replace the air filter."

"The projector is overheating. Make sure nothing is blocking the air vent, and clean or replace the air filter."

"The air filter is clogged. Clean or replace the air filter."

Attention

- If dust collects on the air filter, it can cause the internal temperature of the projector to rise, and this can lead to problems with operation and shorten the optical engine's service life. Clean the air filter immediately when the message is displayed.
- Do not rinse the air filter in water. Do not use detergents or solvents.
- When using a brush for cleaning, use one with long soft bristles, and brush it lightly. If it is brushed too strongly, dust will be ground into the air filter and cannot be removed.

Cleaning the air filter

The air filter can be replaced even when the projector is suspended from a ceiling.



After you turn off the projector's power and the confirmation buzzer beeps twice, disconnect the power cable.

- 2** Open the air filter cover.
Slide the air filter cover operation knob, and open the air filter cover.

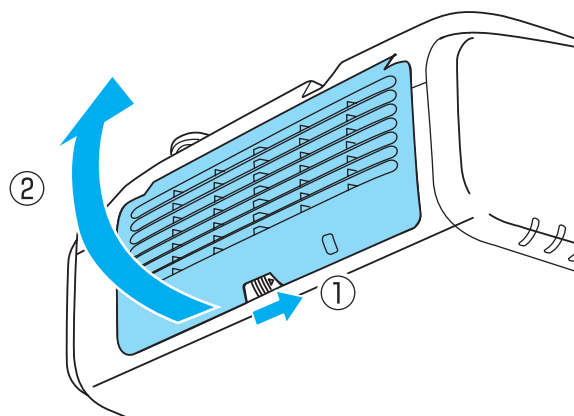

- 3** Remove the air filter.
Grip the tab in the center of the air filter, and pull it straight out.

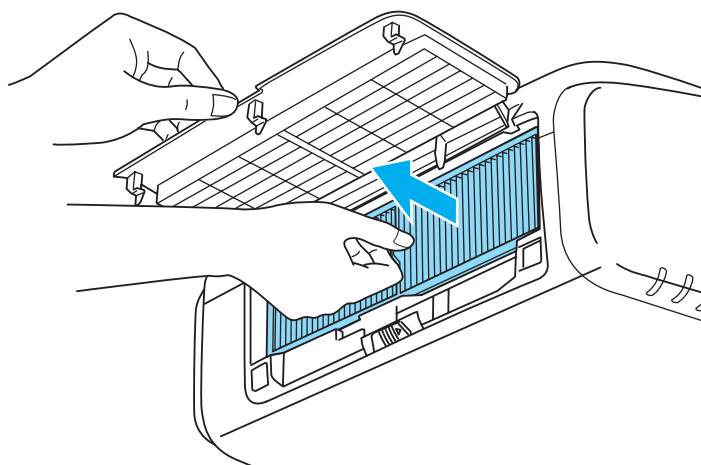

- 4** With the front (the side with tabs) of the air filter facing down, tap the air filter four or five times to shake off the dust.
Turn it over and tap the other side in the same way.

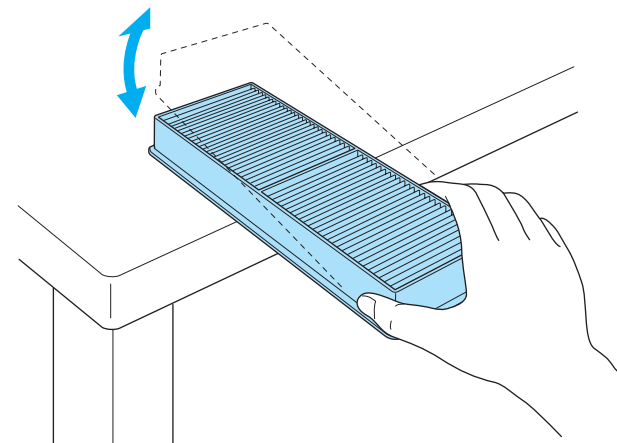

Attention

If the air filter is hit too hard, it may become unusable due to deformities and cracks.

- 5** Remove any dust remaining on the air filter by using a vacuum cleaner from the front side.

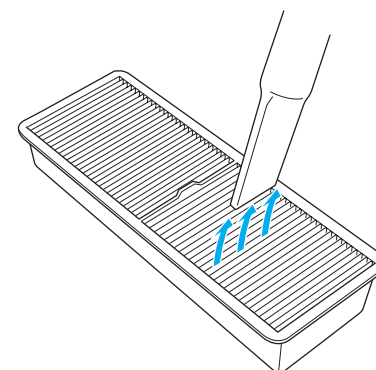

- 6** Replace the air filter.
Press until it clicks into place.

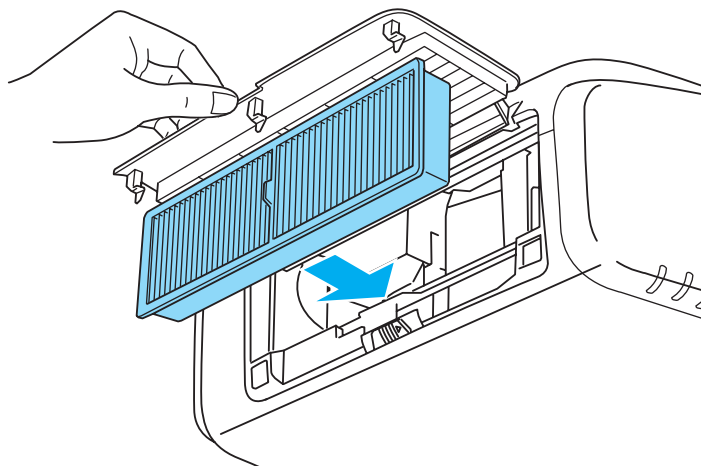

- 7** Close the air filter cover.



- If a message is frequently displayed, even after cleaning, it is time to replace the air filter. Replace it with a new air filter.
 - ☛ "Replacing the Air Filter" [p.131](#)
- It is recommended that you clean these parts at least once every three months. Clean them more often than this if using the projector in a particularly dusty environment.
- The indicators or messages regarding Air Filter Notice are displayed only when **Air Filter Notice** is set to **On** from the Configuration menu.
 - ☛ **Extended - Display - Air Filter Notice** [p.86](#)

This section explains how to replace the lamp and the air filter.

Replacing the Lamp

Lamp replacement period

It is time to replace the lamp when:

- The following message is displayed.
"It is time to replace your lamp. Please contact your Epson projector reseller or visit www.epson.com to purchase."



The message is displayed for 30 seconds.

- The lamp indicator flashes orange.

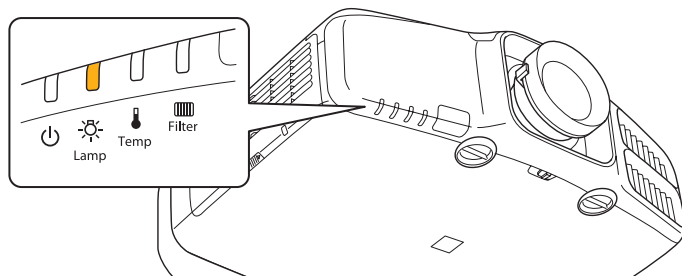

- The projected image gets darker or starts to deteriorate.

Attention

- The lamp replacement message is set to appear after the following time periods in order to maintain the initial brightness and quality of the projected images.

For EB-G6750WU/EB-G6650WU/EB-G6350/EB-G6250W

When using **Power Consumption** continually at **Normal**: About 1900 hours

When using **Power Consumption** continually at **ECO**: About 3900 hours

For EB-G6550WU/EB-G6150

When using **Power Consumption** continually at **Normal**: About 2400 hours

When using **Power Consumption** continually at **ECO**: About 3900 hours

For EB-G6450WU/EB-G6050W

When using **Power Consumption** continually at **Normal**: About 2900 hours

When using **Power Consumption** continually at **ECO**: About 3900 hours

☛ Settings - Power Consumption [p.84](#)

- If you continue to use the lamp after the replacement period has passed, the possibility that the lamp may explode increases. When the lamp replacement message appears, replace the lamp with a new one as soon as possible, even if it is still working.
- Do not repeatedly turn off the power and immediately back on. Turning the power on and off frequently may shorten the lamp's operating life.
- Depending on the characteristics of the lamp and the way it has been used, the lamp may become darker or stop working before the lamp warning message appears. You should always have a spare lamp unit ready in case it is needed.
- We recommend the use of genuine EPSON spare lamps. The use of non-genuine lamps may affect projection quality and safety. Any damage or malfunction caused by the use of non-genuine lamps may not be covered by Epson's warranty.



- We recommend that you clean the air filter whenever you replace the lamp.
 - ☛ "Cleaning the Air Filter" p.125
- Replace the air filter if it is discolored or if a message appears even after cleaning the air filter.
 - ☛ "Replacing the Air Filter" p.131

How to replace the lamp

The lamp can be replaced even when the projector is suspended from a ceiling.

Warning

- When replacing the lamp because it has stopped illuminating, there is a possibility that the lamp may be broken. If replacing the lamp of a projector which has been installed on the ceiling, you should always assume that the lamp is cracked, and you should stand to the side of the lamp cover, not underneath it. Remove the lamp cover gently. Be careful when removing the lamp cover as shards of glass may fall out and could cause an injury. If any shards of glass get into your eyes or mouth, contact your local physician immediately.
- Never disassemble or remodel the lamp. If a modified or disassembled lamp is installed in the projector and used, it could cause a fire, electric shock, or an accident.

Caution

Wait until the lamp has cooled down sufficiently before removing the lamp cover. If the lamp is still hot, burns or other injuries may result. It takes about one hour after the power has been turned off for the lamp to be cool enough.

- 1** After you turn off the projector's power and the confirmation buzzer beeps twice, disconnect the power cord.

- 2** Wait until the lamp has cooled down, then remove the projector's lamp cover.

Loosen the Lamp cover fixing screw with the screwdriver supplied with the new lamp unit or a cross-head screwdriver, and then remove the lamp cover. Because there is a string attached to the lamp cover to prevent it from falling, you can replace the lamp even when the projector is installed on a ceiling without the lamp cover falling down.

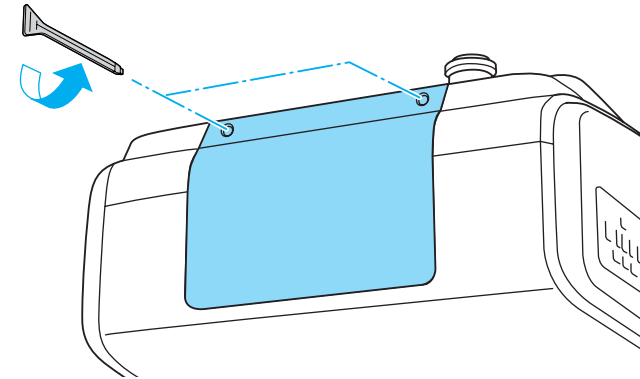

- 3** Loosen the two lamp fixing screws.

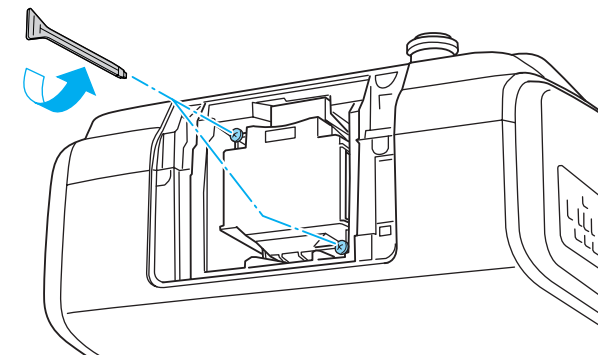

- 4** Take out the old Lamp by pulling the handle.
If the Lamp is cracked, replace it with a new lamp, or contact your local dealer for further advice.

☛ [Epson Projector Contact List](#)

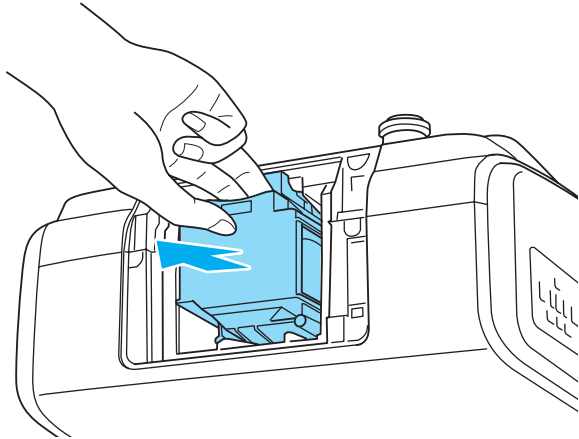

- 5** Install the new lamp.
Insert the lamp along the guide rail in the correct direction so that it fits in place and press it firmly to the back.

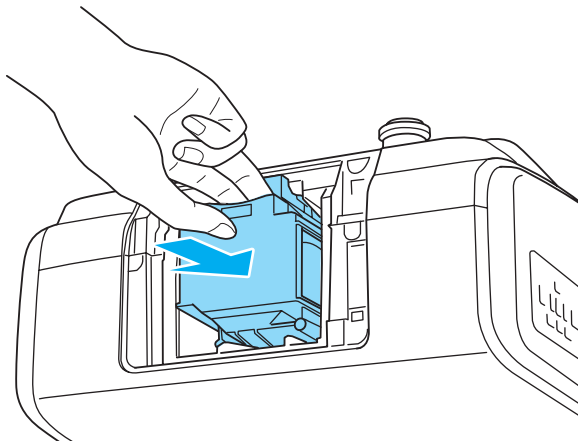

- 6** Tighten the two lamp fixing screws.

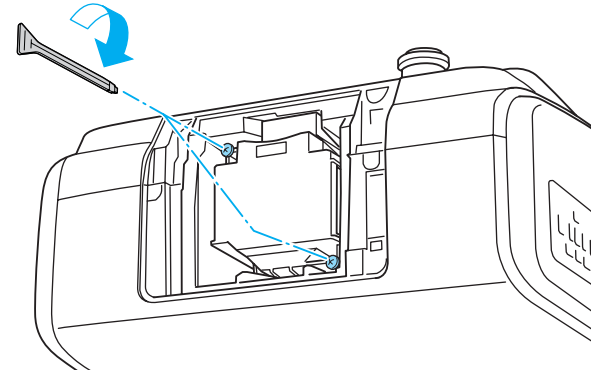

- 7** Replace the lamp cover.

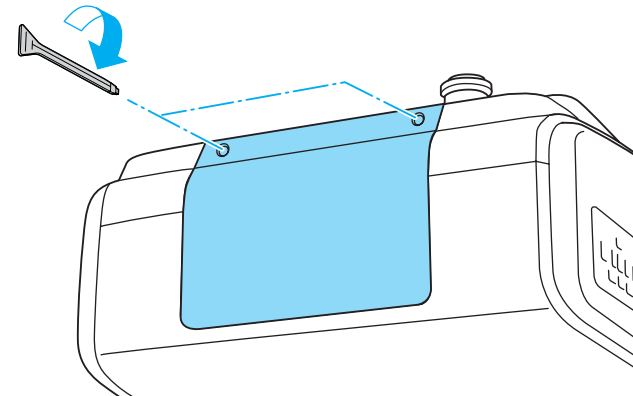

Attention

- Make sure you install the lamp securely. If the lamp cover is removed, the power turns off automatically as a safety precaution. If the lamp or the lamp cover is not installed correctly, the power does not turn on.
- This product includes a lamp component that contains mercury (Hg). Please consult your local regulations regarding disposal or recycling. Do not dispose of it with normal waste.

Resetting the lamp hours

The projector records how long the lamp is turned on and a message and indicator notify you when it is time to replace the lamp. After replacing the lamp, make sure you reset the **Lamp Hours** from the Configuration menu.

☛ "Reset Menu" p.103



Only reset the **Lamp Hours** after the lamp has been replaced. Otherwise the lamp replacement period is not indicated correctly.

Replacing the Air Filter

Air filter replacement period

If the message is displayed frequently even though the air filter has been cleaned, replace the air filter.

How to replace the air filter

The air filter can be replaced even when the projector is suspended from a ceiling.

- 1** After you turn off the projector's power and the confirmation buzzer beeps twice, disconnect the power cord.
- 2** Open the air filter cover.
Slide the air filter cover operation knob, and open the air filter cover.

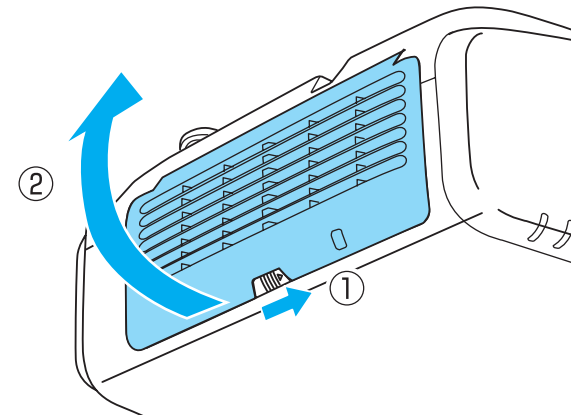

- 3** Remove the air filter.
Grip the tab in the center of the air filter, and pull it straight out.

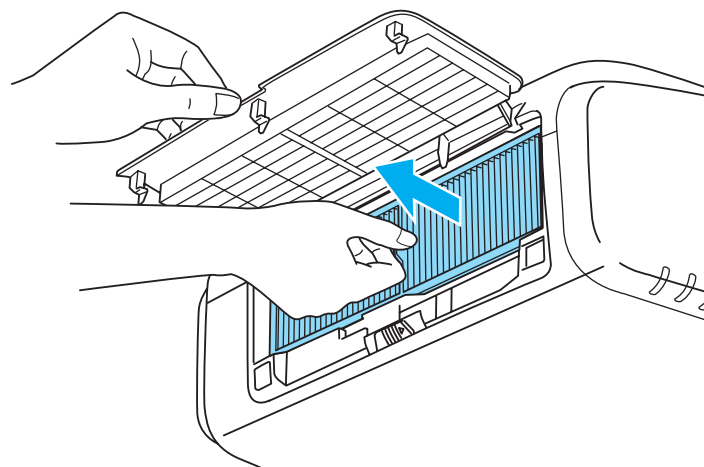

- 4** Install the new air filter.
Press until it clicks into place.

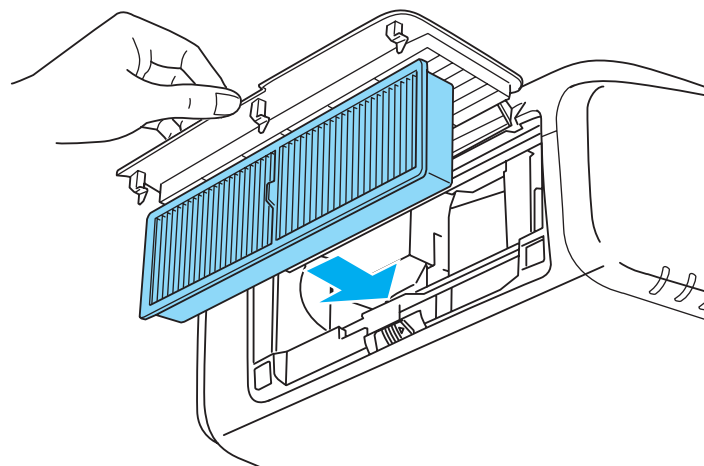

- 5** Close the air filter cover.



Dispose of used air filters properly in accordance with your local regulations.

Material of the frame part: Polypropylene

Material of the filter part: Polypropylene

There are many glass parts and precision components inside the projector. To prevent damage due to impacts when transporting, handle the projector as follows.

Moving Nearby

Check the following points, and move the projector carefully.

- Turn off the power to the projector and disconnect all cables.
- Attach the cover to the lens.



Caution

Do not carry the projector by one person.
Two people are needed to unpack or carry the projector.

When Transporting

Preparing packaging

After checking the points in "Moving Nearby", prepare the following and then pack up the projector.

- Remove the lens unit if an option lens, other than the standard zoom lens, is installed. Attach the standard zoom lens if the projector has a built-in lens. If the projector does not have a lens, attach the cover that was on the lens mount when you purchased the projector.
- Set the vertical lens shift to the lowest position.
 - ☛ "Adjusting the Position of the Projected Image (Lens Shift)" [p.24](#)

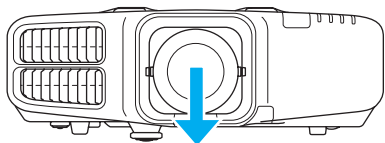

- Fit the protective lens pad that was used at the time of purchase.

Notes when packing and transporting

Enclose the projector securely in buffer material to protect it from shock, and place it into a strong cardboard container. Be sure to notify the carrier company that the contents are fragile.

Panel Alignment

Adjusts the pixel color shift for the LCD panel. You can adjust the pixels horizontally and vertically by 0.25 pixels within a range of ± 1 pixel.



- Image quality may decline after performing LCD alignment.
- Images for pixels that extend beyond the edge of the projected screen are not displayed.

- 1 Press the [Menu] button while projecting.
- 2 Select **Display** from **Extended**.
- 3 Select **Panel Alignment**, and then press the [\leftarrow] button.

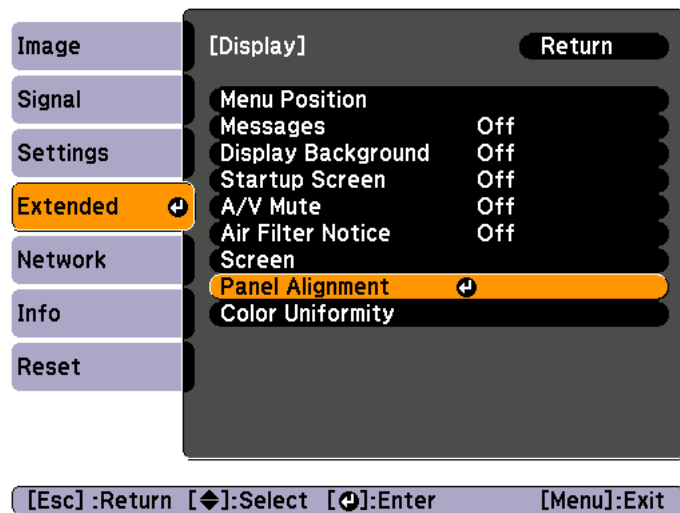

- 4 Enable **Panel Alignment**.

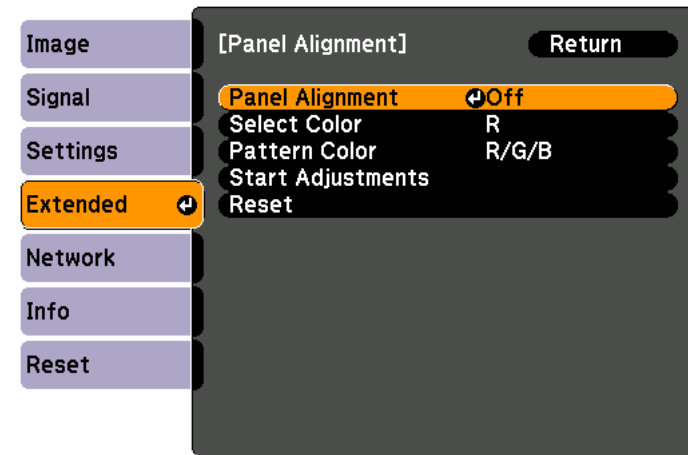

- (1) Select **Panel Alignment**, and then press the [\leftarrow] button.
- (2) Select **On**, and then press the [\leftarrow] button.
- (3) Press the [Esc] button to return to the previous screen.

- 5 Select the color you want to adjust.
 - (1) Select **Select Color**, and then press the [\leftarrow] button.
 - (2) Select **R** (red) or **B** (blue), and then press the [\leftarrow] button.
 - (3) Press the [Esc] button to return to the previous screen.
- 6 Select the grid color displayed when making adjustments from **Pattern Color**.
 - (1) Select **Pattern Color**, and then press the [\leftarrow] button.

- (2) Select a combination of R (red), G (green), and B (blue) for the grid color.
- R/G/B:** Displays a combination all three colors; red, green and blue. The actual color of the grid is white.
- R/G:** This is available when **R** is selected from **Select Color**. Displays a combination of two colors; red and green. The actual color of the grid is yellow.
- G/B:** This is available when **B** is selected from **Select Color**. Displays a combination of two colors; green and blue. The actual color of the grid is cyan.
- (3) Press the [Esc] button to return to the previous screen.

- 7** Select **Start Adjustments**, and then press the [**↵**] button. When the message is displayed, press the [**↵**] button again.
- Adjustment starts. All four corners are adjusted in order starting at the top left.



The image may become distorted while adjusting. The image is restored once adjustments are complete.

- 8** Use the [**▲**], [**▼**], [**◀**], and [**▶**] buttons to make adjustments, and then press the [**↵**] button to move to the next adjustment point.
- 9** When you have adjusted all four corners, select **Exit**, and then press the [**↵**] button.

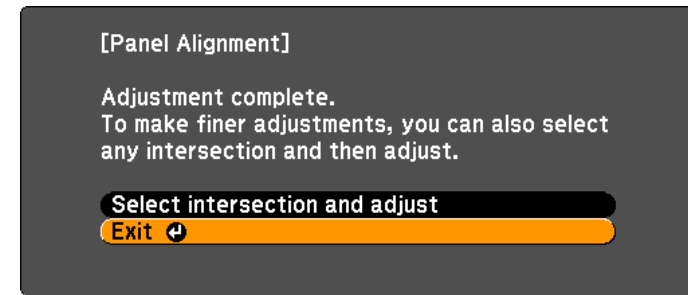

[**◆**]:Select [**⏎**]:Enter [**Menu**]:Exit

If you feel you still need to make adjustments after correcting all four points, select **Select intersection and adjust** and then continue making adjustments.

Color Uniformity

Adjusts the color tone for the whole screen.



The color tone may not be uniform even after performing color uniformity.

- 1** Press the [Menu] button while projecting.
- 2** Select **Display** from **Extended**.
- 3** Select **Color Uniformity**, and then press the [**↵**] button. The following screen is displayed.

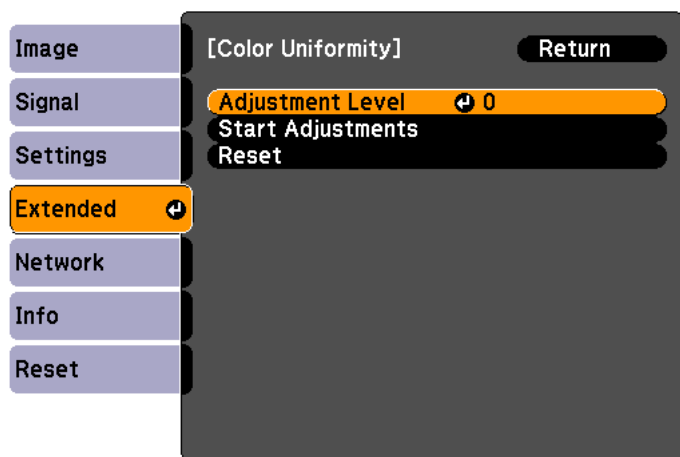

[Esc]:Return [◆]:Select [⏎]:Enter [Menu]:Exit

Adjustment Level: There are five levels from white, through gray, and up to black. You can adjust each level individually.

Start Adjustments: Starts making color uniformity adjustments.

Reset: Resets all adjustments and settings for **Color Uniformity** to their default values.



The image may become distorted while adjusting **Color Uniformity**. The image is restored once adjustments are complete.

- 4 Select **Adjustment Level**, and then press the [↵] button.
- 5 Use the [◀][▶] buttons to set the adjustment level.
- 6 Press the [Esc] button to return to the previous screen.
- 7 Select **Start Adjustments**, and then press the [↵] button.

- 8 Use the [▲], [▼], [◀], and [▶] buttons to select the area you want to adjust, and then press the [↵] button.

If you select the center, the whole screen is adjusted. Adjust the outer areas first, and then adjust the whole screen.

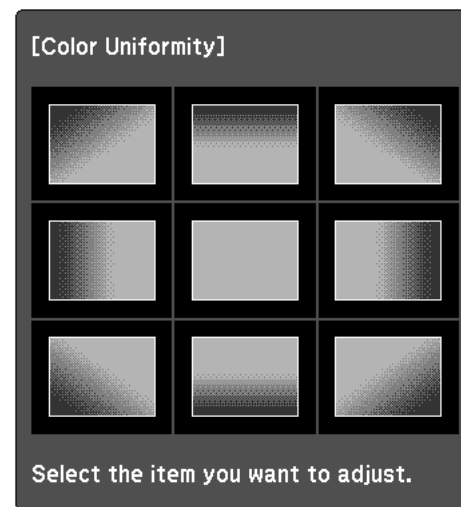

- 9 Use the [▲][▼] buttons to select the color you want to adjust, and then use the [◀][▶] buttons to adjust.

Press the [◀] button to weaken the color tone. Press the [▶] button to strengthen the color tone.

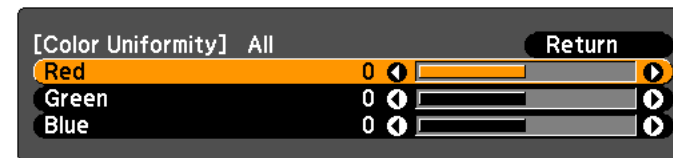

[Esc]:Return [◆]:Select [◀▶]:Adjust [Menu]:Exit [Default]:Reset

- 10 Return to step 4 and adjust each level.

- 11** When you are done, press the [Menu] button.

Adjusting the Lens Balance

The lens may tilt depending on the projector's installation angle or the weight of the lens unit that is attached. If the lens is tilted, images may be out of focus. Adjust the lens balance if some areas of the projected image are out of focus.

Special techniques are necessary to adjust the lens balance. Contact your local dealer or the nearest address provided in the Epson Projector Contact List.

Warning

When adjusting the lens balance, make sure you follow the steps in this User's Guide to prevent light from the projector from shining into your eyes. If you do not follow the steps correctly, the bright light can damage your eyes.

- 1** Turn off the projector if it is on.
- 2** Remove the projector lens unit.
 "Removing" [p.17](#)
- 3** Press a screwdriver and so on down into the clip on the lens installation section (on the opposite side of the lens shift dial), and then remove the cover.

The illustration shows the projector mounted on a ceiling.

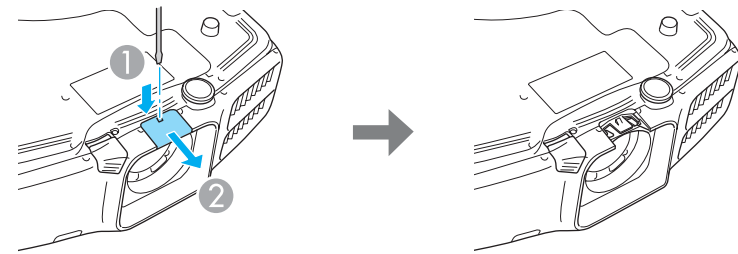

- 4** Remove the inner cap by pushing the two clips on the inner cap in the direction shown by the arrows.

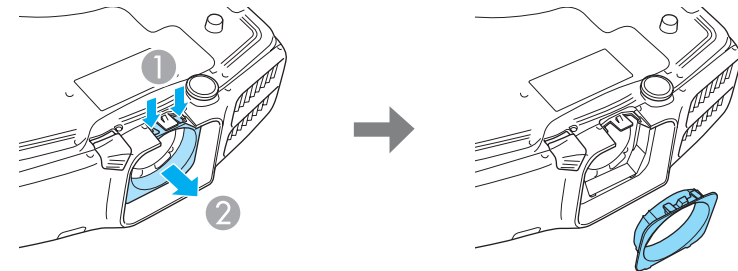

- 5** Use a cross-head screwdriver #1 to remove the fixing screws (four points).

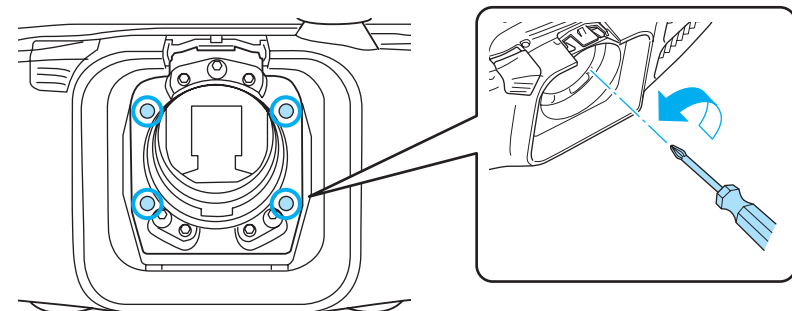

Attention

Keep the screws in a safe place as you will need these when transporting the projector.

- 6** Loosen the locking screws (three points) by 1/4 of a turn (45°) with a ball point hexagonal wrench.

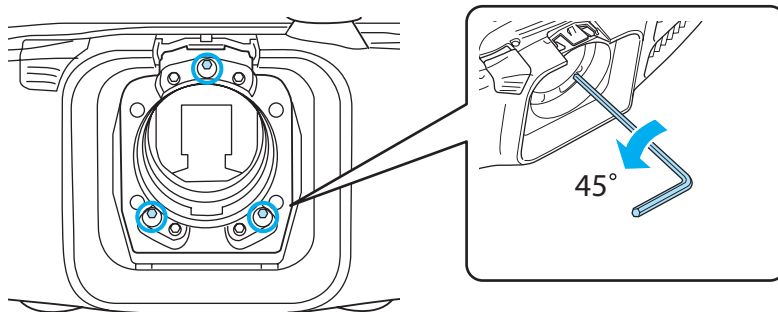
**Attention**

Do not rotate the locking screw more than 1/4 of a turn (45°). This may cause malfunctions to occur.

- 7** Attach the projector lens unit.
 • "Attaching" p.16
- 8** Turn on the projector in a position that prevents you from looking directly into the lens.
- 9** Press the [Test Pattern] button on the remote control or the [] button on the control panel to display the test pattern.
 Press the [◀][▶] buttons on the remote control or the [↵] button on the control panel to change the test pattern.



Use the following pattern to adjust the lens balance.

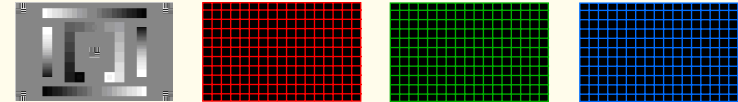

- 10** Adjust the focus with the focus ring.
 • "Correcting the Focus" p.26
 Check the areas that are out of focus on the projection screen.
- 11** Press the [A/V Mute] button to temporarily hide the images.
- 12** Insert the ball point hexagonal wrench into the adjustment screw holes. Cover the lens with your hand so that you cannot look directly into it.

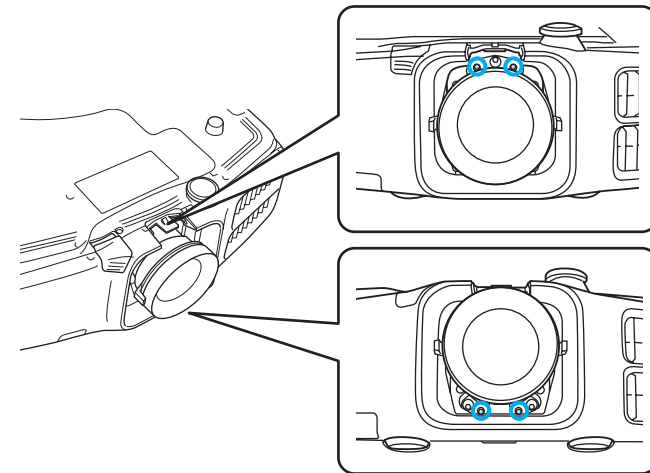

- 13** Move around to the back of the projector so that the light cannot shine into your eyes, and then press the [A/V Mute] button to release A/V Mute.

14 Press the [Test Pattern] button on the remote control or the [] button on the control panel to display the test pattern.

15 Adjust the lens balance by turning the adjustment screws with the ball point hexagonal wrench.

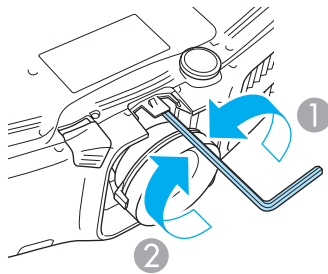

- ① Loosen
- ② Tighten

When the screws are loosened the focus moves to the rear, and when the screws are tightened the focus is brought to the front. The following illustration shows the adjustment screws and their relative adjustment positions when viewed from the rear of the projector.

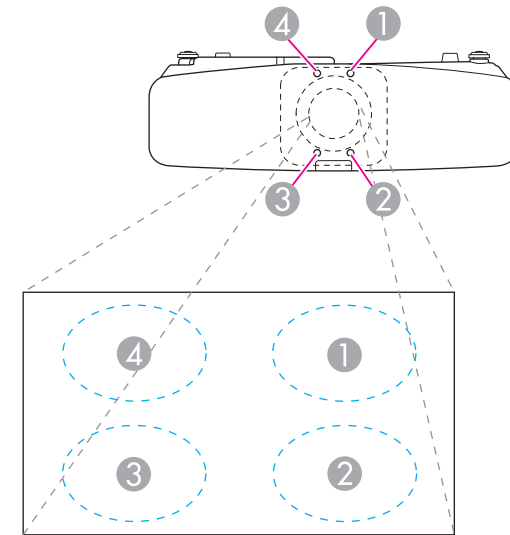

16 Repeat steps 11 to 15 to make further adjustments.

Whenever you make adjustments, adjust the focus with the focus ring and check the projected image.

17 When you have finished making adjustments, turn off the projector and remove the projection lens unit.

18 Tighten the locking screws (three points).

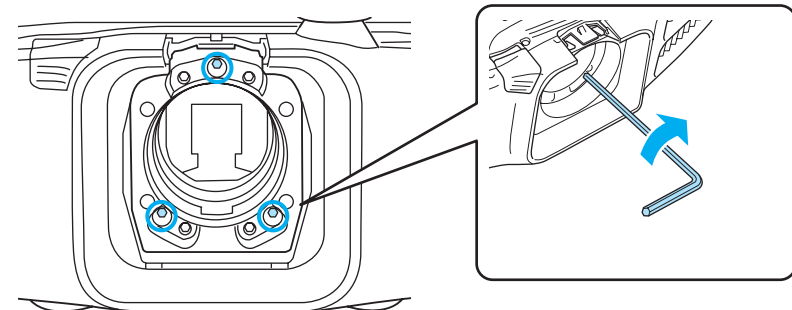

19 See step 4 to attach the inner cap, and then see step 3 to attach the cover.

20 Attach the projector lens unit.

Attention

When performing the following operations, attach the fixing screws, and then tighten all screws to their initial positions.

- When transporting
- When readjusting the lens balance

If the screws are not tightened to their initial positions, a malfunction could occur.



Appendix

This chapter explains the additional functions for networks.

Projecting with "Connect to a Network Projector"

The projector supports the Windows "Connect to a Network Projector" function. For more information about the "Connect to a Network Projector" function, see the documentation supplied with your computer or the Microsoft's Web site.



- Make sure the computer and projector are ready to connect to the network.
- When using "Connect to a Network Projector", change the projector's source to LAN.
- When the projector password screen is displayed, enter the keyword shown at the bottom of the LAN standby screen.
- You can connect only one projector to a computer.
- When using Network Projector from Options in Windows Meeting Space, set the colors for the computer screen you are using to the highest level (32bit). If it is not capable of a 32bit display, a message is displayed and you cannot connect.

Making a WPS (Wi-Fi Protected Setup) Connection with a Wireless LAN Access Point

There are two methods for setting WPS».

- Push Button Method

SSID and security are set automatically when the [↵] button is pressed on the projector's control panel and the dedicated button on the access point equipment. This method is recommended when the projector and access point are close together.

- PIN Code Method

SSID and security are set automatically by inputting an 8-digit code that was assigned to the projector from the computer to the access point in advance. Make connection settings between the computer and the access point in advance. For details on how to make this connection, refer to the manual provided with the access point. This method is recommended when the projector is mounted on the ceiling.



Refer to the documentation for the access point device and to the following section when using any connection method other than WPS.

☞ "Wireless LAN menu" [p.92](#)

Connection Setup Method

1

Press the [Menu] button.

☞ "Using the Configuration Menu" [p.78](#)

2

Select **Network Configuration** from **Network**.

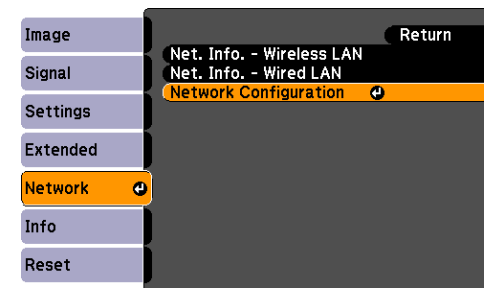

The Network Configuration screen is displayed.

3

From **Wireless LAN** select **To Setup Wizard**.



The following screen is displayed.

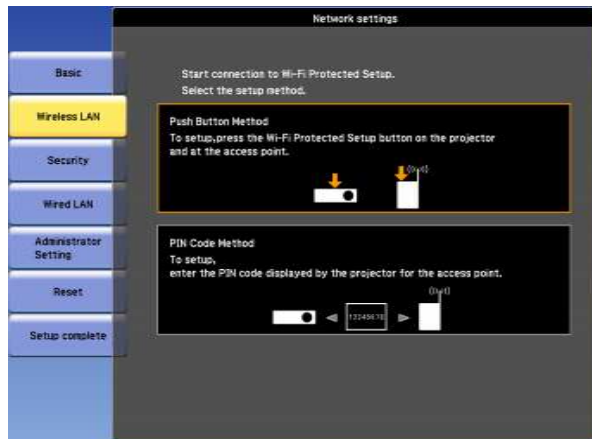

Follow the on-screen instructions.

- The wireless LAN unit (ELPAP07) is connected to the projector.
- The projector is setup to connect to the network using wireless LAN.
 "Wireless LAN menu" [p.92](#)

1 Turn on the projector, and then press the [LAN] button on the remote control.

The following screen is displayed.

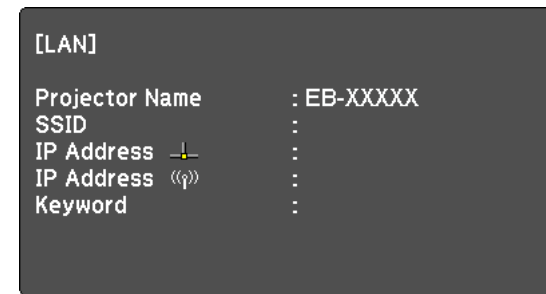

2 Check that the SSID and IP address information are displayed, and then remove the wireless LAN unit.

 "Installing the Wireless LAN Unit" [p.38](#)

3 Insert the Quick Wireless Connection USB Key in the wireless LAN unit installation section.

Using the Quick Wireless Connection USB Key

Connect the optional Quick Wireless Connection USB Key to the wireless LAN unit installation section. Check the following points when connecting a computer to the projector using wireless LAN.

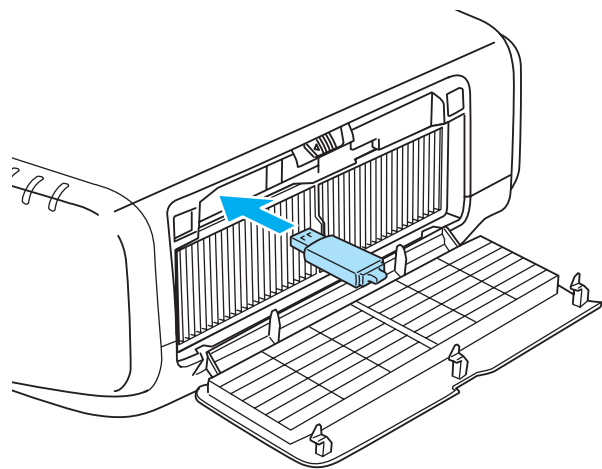

- 4** When the message "Network information update complete. Remove the Quick Wireless Connection USB Key Adapter." is displayed, remove the Quick Wireless Connection USB Key.
After removing the Quick Wireless Connection USB Key, reattach the wireless LAN unit.
- 5** Connect the Quick Wireless Connection USB Key to the computer.
From this point on, see the user's guide supplied with the Quick Wireless Connection USB Key.

About EasyMP Monitor

EasyMP Monitor lets you carry out operations such as checking the status of multiple Epson projectors that are connected to a network at a computer monitor, and controlling the projectors from the computer.

You can download EasyMP Monitor from the following Web site.

<http://www.epson.com>

About Message Broadcasting

Message Broadcasting is plugin software for EasyMP Monitor.

Message Broadcasting can be used to send a message (JPEG file) to project on all Epson projectors or specified projectors connected on the network.

The data can be sent manually, or sent automatically using Timer Settings of EasyMP Monitor.

Download the Message Broadcasting software from the following website.

<http://www.epson.com>

Changing Settings Using a Web Browser (Web Control)

By using the Web browser of a computer connected to the projector on a network, you can make settings and control the projector. This function allows you to perform setup and control operations remotely. In addition, since you can use the computer's keyboard, entering characters required for the setup is easier.

Use Internet Explorer 8.0 or later as the Web browser. If using a Mac OS X, use Safari.



If you set **Standby Mode** to **Communication On**, you can use the Web browser to make settings and perform control even if the projector is in standby mode (when the power is off).

☛ **Extended - Standby Mode** [p.86](#)

Projector setup

In the Web browser, you can set items that are usually set in the projector's Configuration menu. The settings are reflected in the Configuration menu.

Items in the Configuration menu that cannot be set by the Web browser

- Settings Menu - User Button
- Extended Menu - Display - Menu Position, Panel Alignment, Color Uniformity
- Extended Menu - User's Logo
- Extended Menu - Operation - High Altitude Mode, BNC Sync Termination
- Extended Menu - Language
- Reset Menu

The settings for items on each menu are the same as the projector's Configuration menu.

☛ "Configuration Menu" [p.77](#)

Displaying the Web Control screen

Use the following procedure to display the Web Control screen.

Make sure the computer and projector are connected to the network.

Set **Connection Mode** to **Advanced** from the Configuration menu.

☛ **Network - Wireless LAN - Connection Mode** [p.92](#)



If your Web browser is set up to connect via a proxy server, the Web Control screen cannot be displayed. To display Web Control, you need to make settings so that a proxy server is not used for a connection.

- 1** Start the Web browser on the computer.
- 2** Enter the IP address of the projector in the address input box of the Web browser, and press the Enter key on the computer's keyboard.

The Web Control screen is displayed.

When Web Control Password is set in the Network menu from the projector's Configuration menu, the password entry screen is displayed.

- 3** The user ID and password entry screen is displayed.
Enter "EPSONWEB" as the user ID.
The default password is "admin".



- Enter the user ID even if the password setting is disabled. You cannot change the user ID.
- You can change the password in the Network menu from the Configuration menu.
 **Network - Administrator Settings - Web Control Password** [p.98](#)

Setting Certificates

You can use a Web browser to set the certificate settings used for wireless LAN authentication.

Install the following certificates in the projector: Client Certificate and CA certificate for wireless LAN security settings, and Web Server Certificate for the Secure HTTP function.

- 1** Display Web Control.
 "Displaying the Web Control screen" [p.145](#)
- 2** Click **Administrator Settings - Manage Certificates** from **Network**.
- 3** The Manage Certificates screen appears.

Submenu Name	Items or Setting Values
Client Certificate	Refresh/Clear
	Issued to
	Issued by
	Validity period
CA certificate	Refresh/Clear
	Issued to
	Issued by
	Validity period
Self-signed Certificate	Refresh/Clear
	Issued to
	Issued by
	Validity period
Web Server Certificate	Refresh/Clear
	Issued to
	Issued by
	Validity period



When installing a certificate, make sure the projector supports its format.

☞ "List of supported certificates" [p.147](#)

Secure HTTP Notes

When **Secure HTTP** in **Administrator Settings** from the **Network** menu is set to **On**, security using HTTPS protocol is automatically applied. You can use this function to increase security between the projector and a Web browser.

A certificate is used in communication using HTTPS protocol to certify reliability of the server. Create a server certificate to verify reliability from a Web browser, and install it on the projector.

If there is no server certificate, the projector automatically creates a self-signed certificate and communicates. Because this self-signed certificate cannot verify reliability from a Web browser, a warning about the server's reliability is generated when the projector is accessed from a Web browser. Although the security level is decreased when compared to a server certificate, you can continue to communicate by ignoring the warning.

List of supported certificates

Client Certificate (PEAP-TLS/EAP-TLS)

Item	Explanation
Supported format	PKCS#12
Extension	PKCS, P12
Encryption	RSA
Hashes	MD5/SHA-1/SHA-256/SHA-384/SHA-512
Key length	512/1024/2048/4096 bit

Item	Explanation
Password	Required. Up to 32 alphanumeric characters

Server Certificate (PEAP/PEAP-TLS/EAP-TLS/EAP-Fast)

Item	Explanation
Supported format	X509v3
Extension	DER/CER/PEM
Encryption	RSA
Hashes	MD5/SHA-1/SHA-256/SHA-384/SHA-512
Key length	512/1024/2048/4096 bit
Encode	BASE64/Binary

Web Server Certificate (Secure HTTP)

Item	Explanation
Supported format	PKCS#12
Extension	PKCS, P12
Encryption	RSA
Hashes	MD5/SHA-1/SHA-256/SHA-384/SHA-512
Key length	512/1024/2048/4096 bit
Common Name	Network host name
Organization	Optional
Password	Required. Up to 32 alphanumeric characters

Using the Mail Notification Function to Report Problems

When you set Mail Notification, notification messages are sent to the preset email addresses when a problem or warning occurs with a projector. This will enable the operator to be notified of problems with projectors even at locations away from the projectors.

☛ **Network - Administrator Settings - Mail Notification** [p.98](#)



- Up to a maximum of three notification destinations (addresses) can be registered, and notification messages can be sent to all three destinations at once.
- If a projector develops a critical problem and suddenly stops working, it may not be able to send a message notifying an operator of the problem.
- If you set **Standby Mode** to **Communication On**, you can control the projector even if it is in standby mode (when the power is off).

☛ **Extended - Standby Mode** [p.86](#)

Reading Error Notification Mail

When the Mail Notification function is set to On and a problem or warning occurs in the projector, the following email will be sent.

Mail sender: Address for Address 1

Subject: EPSON Projector

Line 1: The projector name where the problem has occurred

Line 2: The IP address set for the projector where the problem has occurred.

Line 3 and on: Details of the problem

The details of the problem are listed line by line. The main message contents are listed below.

- Clean Air Filter (Air Filter Notice)
- Internal error
- Fan related error
- Sensor error
- Lamp cover is open. (Lamp Cover Open)
- Lamp timer failure
- Lamp out
- Internal temperature error
- High-speed cooling in progress
- Lamp replacement notification
- Low Air Flow (Low Air Flow)
- Low Air Flow Error (Filter Airflow Error)
- No-signal
No Signal is input to the projector. Check the connection status or check that the power for the signal source is turned on.
- Auto Iris Error
- Power Err. (Ballast)

See the following to deal with problems or warnings.

☛ "Reading the Indicators" [p.106](#)

Management Using SNMP

By setting **SNMP** to **On** in the Configuration menu, notification messages are sent to the specified computer when a problem or warning occurs. This will enable the operator to be notified of problems with projectors even at locations away from the projectors.

Network - Administrator Settings - SNMP [p.98](#)



- SNMP should be managed by a network administrator or someone who is familiar with the network.
- To use the SNMP function to monitor the projector, you need to install the SNMP manager program on your computer.
- Up to two destination IP addresses can be saved.

Displaying the Web Remote Screen



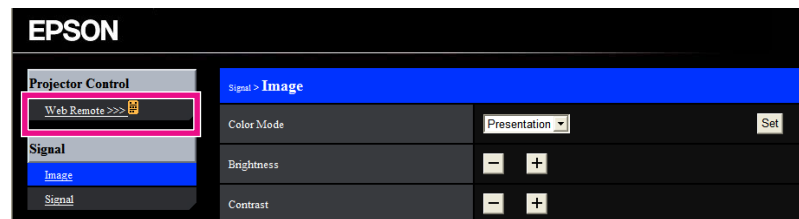

The Web Remote function allows you to perform projector remote control operations with a Web browser.

- 1 Display the Web Control screen.
- 2 Click **Web Remote**.

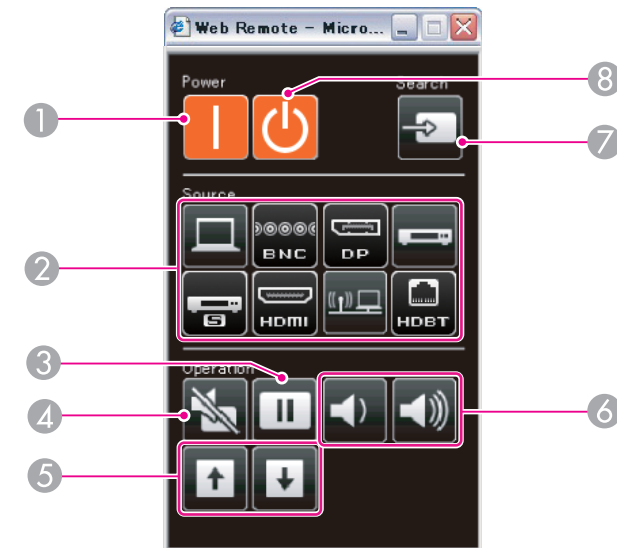

- 3 The Web Remote screen is displayed.



- 1 **[⏻] button**
Turns the projector on.
- 2 **Change input buttons**
 "Switching to the Target Image by Remote Control" [p.42](#)
- 3 **[Freeze] button**
 "Freezing the Image (Freeze)" [p.64](#)
- 4 **[A/V Mute] button**
 "Hiding the Image and Sound Temporarily (A/V Mute)" [p.63](#)
- 5 **[Page] buttons**
 "Remote Control" [p.12](#)
- 6 **[Volume] buttons**
- 7 **[Source Search] button**
 "Automatically Detect Input Signals and Change the Projected Image (Source Search)" [p.41](#)
- 8 **[⏻] button**
Turns the projector off.

ESC/VP21 Commands

You can control the projector from an external device using ESC/VP21.

Command list

When the power ON command is transmitted to the projector, the power turns on and it enters warm-up mode. When the projector's power has turned on, a colon ":" (3Ah) is returned.

When a command is input, the projector executes the command and returns a ":", and then accepts the next command.

If the command being processed terminates abnormally, an error message is output and a ":" is returned.

The main contents are listed below.

Item		Command	
Power ON/OFF	On	PWR ON	
	Off	PWR OFF	
Signal selection	Computer	Auto	SOURCE 1F
		RGB	SOURCE 11
		Component	SOURCE 14
	BNC	Auto	SOURCE BF
		RGB	SOURCE B1
		Component	SOURCE B4
	HDMI	SOURCE 30	
	Video	SOURCE 41	
	S-Video	SOURCE 42	
	LAN	SOURCE 53	
	DisplayPort	SOURCE 70	
HDBaseT (EB-G6750WU only)	SOURCE 80		

Item		Command
A/V Mute On/Off	On	MUTE ON
	Off	MUTE OFF

Add a Carriage Return (CR) code (0Dh) to the end of each command and transmit.

For more details, contact your local dealer or the nearest address provided in the Epson Projector Contact List.

 [Epson Projector Contact List](#)

Cable layouts

Serial connection

- Connector shape: D-Sub 9-pin (male)

- Projector input port name: RS-232C

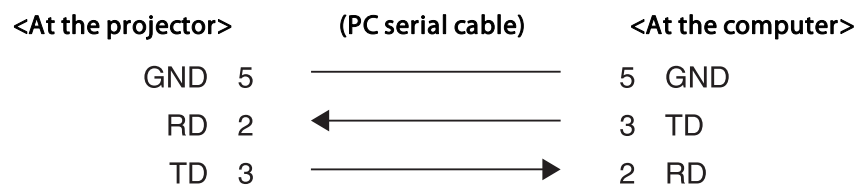
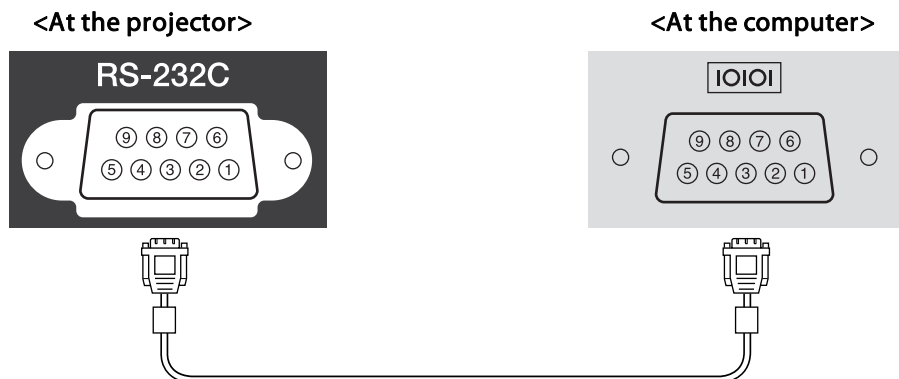

Signal Name	Function
GND	Signal wire ground
TD	Transmit data
RD	Receive data

Communications protocol

- Default baud rate setting: 9600 bps
- Data length: 8 bit
- Parity: None
- Stop-bit: 1 bit
- Flow control: None

About PJLink

PJLink Class1 was established by the JBMIA (Japan Business Machine and Information System Industries Association) as a standard protocol for controlling network-compatible projector's as part of their efforts to standardize projector control protocols.

The projector complies with the PJLink Class1 standard established by the JBMIA.

You need to make network settings before you can use PJLink. See the following for more information on network settings.

☛ "Network Menu" [p.89](#)

It complies with all commands except for the following commands defined by PJLink Class1, and agreement was confirmed by the PJLink standard adaptability verification.

URL:<http://pjlink.jbmia.or.jp/english/>

- **Non-compatible commands**

	Function	PJLink Command
Mute settings	Image muting set	AVMT 11
	Audio muting set	AVMT 21

- **Input names defined by PJLink and corresponding projector sources**

Source	PJLink Command
Computer	INPT 11
BNC	INPT 13
Video	INPT 21
S-Video	INPT 22
HDMI	INPT 32
DisplayPort	INPT 35

Source	PJLink Command
LAN	INPT 52
HDBaseT	INPT 56 (EB-G6750WU only)

- Manufacturer name displayed for "Manufacture name information query"
EPSON
- Model name displayed for "Product name information query"
EPSON 6750
EPSON 6650
EPSON 6550
EPSON 6450
EPSON 6350
EPSON 6250
EPSON 6150
EPSON 6050

About Crestron RoomView®

Crestron RoomView® is an integrated control system provided by Crestron®. It can be used to monitor and control multiple devices connected on a network.

The projector supports the control protocol, and can therefore be used in a system built with Crestron RoomView®.

Visit the Crestron® Web site for details on Crestron RoomView®. (Only English-language displays are supported.)

<http://www.crestron.com>

The following provides an overview of Crestron RoomView®.

• Remote operation using a Web browser

You can operate a projector from your computer just like using a remote control.

• Monitoring and control with application software

You can use Crestron RoomView® Express or Crestron RoomView® Server Edition provided by Crestron® to monitor devices in the system, to communicate with the help desk, and to send emergency messages. See the following Web site for details.

<http://www.crestron.com/getroomview>

This manual describes how to perform operations on your computer using a Web browser.



- You can only enter single-byte alphanumeric characters and symbols.
- The following functions cannot be used while using Crestron RoomView®.
 - ☛ "Changing Settings Using a Web Browser (Web Control)"
[p.145](#)
 - Message Broadcasting (EasyMP Monitor plug-in)
 - If you set **Standby Mode** to **Communication On**, you can control the projector even if it is in standby mode (when the power is off).
 - ☛ **Extended - Standby Mode** [p.86](#)

Operating a projector from your computer

Displaying the operation window

Check the following before carrying out any operations.

- Make sure the computer and projector are connected to the network.
- Set **Crestron RoomView** to **On** from the **Network** menu.
 - ☛ **Network - Administrator Settings - Crestron RoomView** [p.98](#)

- 1 Start the Web browser on the computer.
- 2 Enter the IP address of the projector in the address field of the Web browser, and press the Enter key on the keyboard.
The operation window is displayed.

Using the operation window

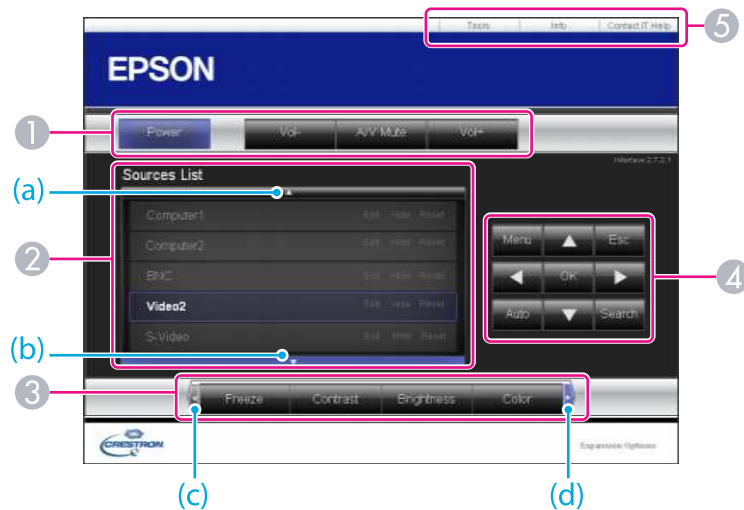

- 1 You can perform the following operations when you click the buttons.

Button	Function
Power	Turns the projector power on or off.
Vol-/Vol+	Adjusts the volume.

Button	Function
A/V Mute	Turns the video and audio on or off. ☛ "Hiding the Image and Sound Temporarily (A/V Mute)" p.63

- 2 Switch to the image from the selected input source. To display input sources that are not shown in Source List, click (a) or (b) to scroll up or down. The current video signal input source is displayed in blue. You can change the source name if necessary.
- 3 You can perform the following operations when you click the buttons. To display buttons that are not shown in Source List, click (c) or (d) to scroll left or right.

Button	Function
Freeze	Images are paused or unpaused. ☛ "Freezing the Image (Freeze)" p.64
Contrast	Adjusts the difference between light and shade in the images.
Brightness	Adjusts the image brightness.
Color	Adjusts the color saturation for the images.
Sharpness	Adjusts the image sharpness.
Zoom	Click the [⊕] button to enlarge the image without changing the projection size. Click the [⊖] button to reduce an image that was enlarged with the [⊕] button. Click the [▲], [▼], [◀], or [▶] buttons to change the position of an enlarged image. ☛ "Enlarging Part of the Image (E-Zoom)" p.64

- 4 The [▲], [▼], [◀], and [▶] buttons perform the same operations as the [▲], [▼], [◀], and [▶] buttons on the remote control. You can perform the following operations when you click the other buttons.

Button	Function
OK	Performs the same operation as the [↵] button on the remote control. ☛ "Remote Control" p.12
Menu	Displays and closes the Configuration menu.
Auto	If clicked while projecting analog RGB signals from the Computer port, you can automatically optimize Tracking, Sync., and Position.
Search	Changes to the next input source that is sending an image. ☛ "Automatically Detect Input Signals and Change the Projected Image (Source Search)" p.41
Esc	Performs the same operation as the [Esc] button on the remote control. ☛ "Remote Control" p.12

5 You can perform the following operations when you click the tabs.

Tab	Function
Contact IT Help	Displays the Help Desk window. Used to send messages to, and receive messages from, the administrator using Crestron RoomView® Express.
Info	Displays information on the projector that is currently connected.
Tools	Changes settings in the projector that is currently connected. See the next section.

Using the tools window

The following window is displayed when you click the **Tools** tab on the operation window. You can use this window to change settings in the projector that is currently connected.

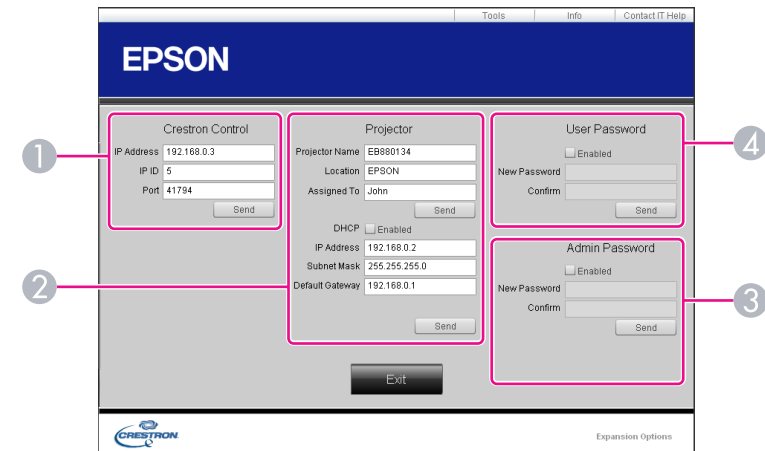

- 1 **Crestron Control**
Make settings for Crestron® central controllers.
- 2 **Projector**
The following items can be set.

Item	Function
Projector Name	Enter a name to differentiate the projector that is currently connected from other projectors on the network. (The name can contain up to 15 single-byte alphanumeric characters.)
Location	Enter an installation location name for the projector that is currently connected on the network. (The name can contain up to 32 single-byte alphanumeric characters and symbols.)
Assigned To	Enter a user name for the projector. (The name can contain up to 32 single-byte alphanumeric characters and symbols.)



Item	Function
DHCP	Select the Enabled check box to use DHCP. You cannot enter an IP address if DHCP is enabled.
IP Address	Enter the IP address to assign to the currently connected projector.
Subnet Mask	Enter a subnet mask for the currently connected projector.
Default Gateway	Enter the gateway address for the currently connected projector.
Send	Click this button to confirm the changes made to the Projector .

Item	Function
New Password	Enter the new password when changing the password to open the operation window. (The name can contain up to 26 single-byte alphanumeric characters.)
Confirm	Enter the same password as you entered in New Password . If the passwords are not the same, an error is displayed.
Send	Click this button to confirm the changes made to the User Password .

3 Admin Password

Select the **Enabled** check box to require a password to open the Tools window. The following items can be set.

Item	Function
New Password	Enter the new password when changing the password to open the Tools window. (The name can contain up to 26 single-byte alphanumeric characters.)
Confirm	Enter the same password as you entered in New Password . If the passwords are not the same, an error is displayed.
Send	Click this button to confirm the changes made to the Admin Password .

4 User Password

Select the **Enabled** check box to require a password to open the operation window on the computer. The following items can be set.

The following optional accessories and consumables are available. Please purchase these products as and when needed. The following list of optional accessories and consumables is current as of: January 2013. Details of accessories are subject to change without notice and availability may vary depending on the country of purchase.

Optional Accessories

Standard zoom lens ELPLS06

The lens equipped to models with lenses.

Short throw zoom lens ELPLU01

Rear projection wide lens ELPLR03

Middle throw zoom lens ELPLM04

Middle throw zoom lens ELPLM05

Long throw zoom lens ELPLL06

See the following for more information on the projection distance for each lens.

 "Screen Size and Projection Distance" [p.158](#)

Computer cable ELPKC02

(1.8 m - for mini D-Sub15-pin/mini D-Sub 15pin)

This is the same as the computer cable supplied with the projector.

Computer cable ELPKC09

(3 m - for mini D-Sub15-pin/mini D-Sub 15pin)

Computer cable ELPKC10

(20 m - for mini D-Sub15-pin/mini D-Sub 15pin)

Use one of these longer cables if the computer cable supplied with the projector is too short.

Component video cable ELPKC19

(3 m - for mini D-Sub 15-pin/RCA male×3)

Use to connect a [component video](#)  source.

Remote control cable set ELPKC28

(10 m 2 piece set)

Use this to guarantee operation from the remote control from a distance.

Wireless mouse receiver ELPST16

Use this to use the projector's remote control to control the mouse pointer on the computer or to page up and down.

HDBaseT Transmitter ELPHD01 (for EB-G6750WU only)

This transmitter performs long distance transmissions for HDMI signals and control signals for 1 LAN cable. Based on the [HDBaseT](#)  standard.

Wireless LAN unit ELPAP07

Use when connecting the projector to a computer wirelessly and projecting.

Quick Wireless Connection USB Key ELPAP09

Use when you want to quickly establish one-to-one connection between the projector and a computer with Windows installed.

Polarizer ELPLL01

Attach to this projector when stacking two projectors and projecting 3D images.

Passive 3D Glasses (standard five piece set) ELPGS02A

Passive 3D Glasses (five piece set for children) ELPGS02B

Passive polarized 3D glasses. Use these when viewing 3D images with the projectors.

Document Camera ELPDC11/ELPDC20

Use when projecting images such as books, OHP documents, or slides.

Ceiling pipe (450 mm)* ELFPF13

Ceiling pipe (700 mm)* ELFPF14

Use when installing the projector on a high ceiling.

Ceiling mount* ELPMB22

Use when installing the projector on a ceiling.

* Special expertise is required to suspend the projector from a ceiling. Contact your local dealer or the nearest address provided in the Epson Projector Contact List.

 [Epson Projector Contact List](#)



Consumables

Lamp unit ELPLP76

Use as a replacement for used lamps.

Air filter ELPAF43

Use as a replacement for used air filters.

Projection Distance (For EB-G6750WU/EB-G6650WU/EB-G6550WU/EB-G6450WU/EB-G6250W/EB-G6050W)

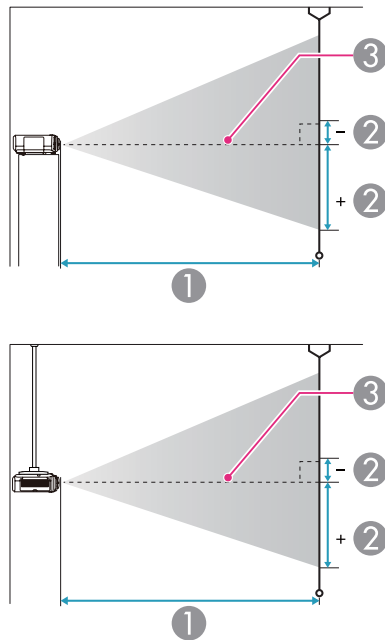

- ① Projection distance
- ② is the distance from the center of the lens to the base of the screen. This changes depending on the setting for vertical lens shift.
- ③ Center of lens

Standard zoom lens ELPLS06

This section shows the projection distances for models equipped with standard lenses.

Unit: cm

4:3 Screen Size		①	②
		Minimum (Wide) to Maximum (Tele)	Vertical Lens Shift Top to Bottom
50"	102x76	154 - 280	-13 - +90
60"	122x91	185 - 337	-16 - +108
70"	142x107	217 - 393	-19 - +126
80"	163x122	249 - 450	-22 - +143
100"	203x152	312 - 564	-27 - +179
150"	305x229	471 - 848	-40 - +269
200"	406x305	630 - 1132	-54 - +359
250"	508x381	788 - 1415	-67 - +448

Unit: cm

16:9 Screen Size		①	②
		Minimum (Wide) to Maximum (Tele)	Vertical Lens Shift Top to Bottom
50"	111x62	139 - 254	-16 - +78
60"	133x75	168 - 305	-19 - +94
80"	177x100	226 - 408	-25 - +125
100"	221x125	283 - 511	-31 - +156
150"	332x187	427 - 769	-47 - +234
200"	443x249	571 - 1027	-63 - +312
250"	553x311	715 - 1285	-78 - +390
290"	642x361	830 - 1491	-91 - +452

Unit: cm

16:10 Screen Size		①	②
		Minimum (Wide) to Maximum (Tele)	Vertical Lens Shift Top to Bottom
50"	108x67	135 - 247	-12 - +79
60"	130x81	163 - 297	-14 - +95
80"	172x108	219 - 397	-19 - +127
100"	215x135	275 - 498	-24 - +158
150"	323x202	416 - 748	-36 - +238
200"	431x269	556 - 999	-48 - +317
250"	538x337	696 - 1250	-59 - +396
300"	646x404	836 - 1501	-71 - +475

Unit: cm

16:9 Screen Size		①	②
		Minimum (Wide) to Maximum (Tele)	Vertical Lens Shift Top to Bottom
60"	133x75	84 - 101	-19 - +94
80"	177x100	113 - 136	-25 - +125
100"	221x125	143 - 171	-31 - +156
150"	332x187	216 - 259	-47 - +234
200"	443x249	290 - 347	-63 - +312
250"	553x311	363 - 434	-78 - +390
290"	642x361	422 - 505	-91 - +452

Unit: cm

Short throw zoom lens ELPLU01

Unit: cm

4:3 Screen Size		①	②
		Minimum (Wide) to Maximum (Tele)	Vertical Lens Shift Top to Bottom
60"	122x91	93 - 112	-16 - +108
70"	142x107	109 - 131	-19 - +126
80"	163x122	125 - 151	-22 - +143
100"	203x152	158 - 189	-27 - +179
150"	305x229	238 - 286	-40 - +269
200"	406x305	319 - 382	-54 - +359
250"	508x381	400 - 479	-67 - +448

16:10 Screen Size		①	②
		Minimum (Wide) to Maximum (Tele)	Vertical Lens Shift Top to Bottom
60"	130x81	81 - 98	-14 - +95
80"	172x108	110 - 132	-19 - +127
100"	215x135	139 - 167	-24 - +158
150"	323x202	210 - 252	-36 - +238
200"	431x269	282 - 337	-48 - +317
250"	538x337	353 - 423	-59 - +396
300"	646x404	425 - 508	-71 - +475

Rear projection wide lens ELPLR03

Lens shift is not supported.

Unit: cm

4:3 Screen Size		①	②
50"	102x76	91	+38
60"	122x91	110	+46
70"	142x107	129	+53
80"	163x122	148	+61
100"	203x152	186	+76
150"	305x229	280	+114

Unit: cm

16:9 Screen Size		①	②
50"	111x62	82	+31
60"	133x75	99	+37
80"	177x100	134	+50
100"	221x125	168	+62
150"	332x187	254	+93

Unit: cm

16:10 Screen Size		①	②
50"	108x67	80	+34
60"	130x81	96	+40
80"	172x108	130	+54
100"	215x135	163	+67
150"	323x202	247	+101
200"	431x269	331	+135

Middle throw zoom lens ELPLM04

Unit: cm

4:3 Screen Size		①	②
		Minimum (Wide) to Maximum (Tele)	Vertical Lens Shift Top to Bottom
50"	102x76	275 - 421	-13 - +90
60"	122x91	332 - 507	-16 - +108
70"	142x107	389 - 593	-19 - +126
80"	163x122	446 - 679	-22 - +143
100"	203x152	560 - 851	-27 - +179
150"	305x229	844 - 1282	-40 - +269
200"	406x305	1129 - 1713	-54 - +359
250"	508x381	1414 - 2143	-67 - +448

Unit: cm

16:9 Screen Size		①	②
		Minimum (Wide) to Maximum (Tele)	Vertical Lens Shift Top to Bottom
50"	111x62	249 - 381	-16 - +78
60"	133x75	300 - 459	-19 - +94
80"	177x100	404 - 616	-25 - +125
100"	221x125	507 - 772	-31 - +156
150"	332x187	766 - 1163	-47 - +234
200"	443x249	1024 - 1554	-63 - +312
250"	553x311	1283 - 1945	-78 - +390
290"	642x361	1490 - 2258	-91 - +452



Unit: cm

16:10 Screen Size		①	②
		Minimum (Wide) to Maximum (Tele)	Vertical Lens Shift Top to Bottom
50"	108x67	242 - 371	-12 - +79
60"	130x81	292 - 447	-14 - +95
80"	172x108	392 - 599	-19 - +127
100"	215x135	493 - 751	-24 - +158
150"	323x202	754 - 1131	-36 - +238
200"	431x269	996 - 1512	-48 - +317
250"	538x337	1248 - 1892	-59 - +396
300"	646x404	1499 - 2272	-71 - +475

Unit: cm

16:9 Screen Size		①	②
		Minimum (Wide) to Maximum (Tele)	Vertical Lens Shift Top to Bottom
50"	111x62	371 - 571	-16 - +78
60"	133x75	449 - 689	-19 - +94
80"	177x100	604 - 924	-25 - +125
100"	221x125	759 - 1159	-31 - +156
150"	332x187	1146 - 1746	-47 - +234
200"	443x249	1534 - 2334	-63 - +312
250"	553x311	1921 - 2921	-78 - +390
290"	642x361	2231 - 3391	-91 - +452

Middle throw zoom lens ELPLM05

Unit: cm

4:3 Screen Size		①	②
		Minimum (Wide) to Maximum (Tele)	Vertical Lens Shift Top to Bottom
50"	102x76	410 - 631	-13 - +90
60"	122x91	496 - 760	-16 - +108
70"	142x107	581 - 890	-19 - +126
80"	163x122	667 - 1019	-22 - +143
100"	203x152	837 - 1278	-27 - +179
150"	305x229	1264 - 1925	-40 - +269
200"	406x305	1691 - 2572	-54 - +359
250"	508x381	2118 - 3219	-67 - +448

Unit: cm

16:10 Screen Size		①	②
		Minimum (Wide) to Maximum (Tele)	Vertical Lens Shift Top to Bottom
50"	108x67	361 - 555	-12 - +79
60"	130x81	436 - 670	-14 - +95
80"	172x108	587 - 898	-19 - +127
100"	215x135	738 - 1127	-24 - +158
150"	323x202	1115 - 1699	-36 - +238
200"	431x269	1492 - 2270	-48 - +317
250"	538x337	1869 - 2842	-59 - +396
300"	646x404	2246 - 3414	-71 - +475



Long throw zoom lens ELPLL06

Unit: cm

4:3 Screen Size		①	②
		Minimum (Wide) to Maximum (Tele)	Vertical Lens Shift Top to Bottom
50"	102x76	620 - 842	-13 - +90
60"	122x91	748 - 1015	-16 - +108
70"	142x107	876 - 1187	-19 - +126
80"	163x122	1003 - 1359	-22 - +143
100"	203x152	1259 - 1703	-27 - +179
150"	305x229	1897 - 2564	-40 - +269
200"	406x305	2536 - 3425	-54 - +359
250"	508x381	3175 - 4285	-67 - +448

Unit: cm

16:10 Screen Size		①	②
		Minimum (Wide) to Maximum (Tele)	Vertical Lens Shift Top to Bottom
50"	108x67	546 - 742	-12 - +79
60"	130x81	659 - 894	-14 - +95
80"	172x108	884 - 1198	-19 - +127
100"	215x135	1110 - 1502	-24 - +158
150"	323x202	1674 - 2263	-36 - +238
200"	431x269	2238 - 3023	-48 - +317
250"	538x337	2802 - 3783	-59 - +396
300"	646x404	3366 - 4544	-71 - +475

Unit: cm

16:9 Screen Size		①	②
		Minimum (Wide) to Maximum (Tele)	Vertical Lens Shift Top to Bottom
50"	111x62	561 - 763	-16 - +78
60"	133x75	677 - 919	-19 - +94
80"	177x100	909 - 1232	-25 - +125
100"	221x125	1141 - 1545	-31 - +156
150"	332x187	1721 - 2326	-47 - +234
200"	443x249	2301 - 3107	-63 - +312
250"	553x311	2880 - 3889	-78 - +390
290"	642x361	3344 - 4514	-91 - +452

Projection Distance (For EB-G6350/EB-G6150)

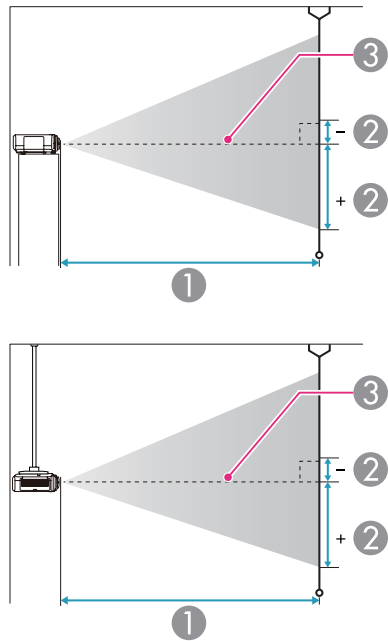

- ① Projection distance
- ② is the distance from the center of the lens to the base of the screen. This changes depending on the setting for vertical lens shift.
- ③ Center of lens

Standard zoom lens ELPLS06

This section shows the projection distances for models equipped with lenses.

Unit: cm

4:3 Screen Size		①	②
		Minimum (Wide) to Maximum (Tele)	Vertical Lens Shift Top to Bottom
30"	61x46	76 - 141	-3 - +49
40"	81x61	103 - 189	-5 - +66
50"	102x76	130 - 238	-6 - +82
60"	122x91	157 - 286	-7 - +98
80"	163x122	211 - 383	-9 - +131
100"	203x152	265 - 479	-12 - +164
150"	305x229	400 - 721	-17 - +246
200"	406x305	535 - 963	-23 - +328
250"	508x381	670 - 1205	-29 - +410
300"	610x457	804 - 1447	-35 - +492

Unit: cm

16:9 Screen Size		①	②
		Minimum (Wide) to Maximum (Tele)	Vertical Lens Shift Top to Bottom
28"	62x35	77 - 143	-9 - +44
30"	66x37	83 - 154	-10 - +47
40"	89x50	113 - 207	-13 - +63
50"	111x62	142 - 259	-17 - +79
60"	133x75	171 - 312	-20 - +95
80"	177x100	230 - 417	-27 - +126
100"	221x125	289 - 523	-33 - +158
150"	332x187	436 - 786	-50 - +237
200"	443x249	583 - 1050	-67 - +316



16:9 Screen Size		①	②
		Minimum (Wide) to Maximum (Tele)	Vertical Lens Shift Top to Bottom
250"	553x311	730 - 1313	-83 - +395
275"	609x342	803 - 1445	-92 - +434

Unit: cm

16:10 Screen Size		①	②
		Minimum (Wide) to Maximum (Tele)	Vertical Lens Shift Top to Bottom
29"	62x39	78 - 145	-7 - +47
30"	65x40	81 - 150	-8 - +48
50"	108x67	138 - 252	-13 - +80
60"	130x81	167 - 303	-15 - +96
70"	151x94	195 - 355	-18 - +112
80"	172x108	224 - 406	-21 - +128
100"	215x135	281 - 508	-26 - +160
150"	323x202	424 - 765	-39 - +241
200"	431x269	567 - 1021	-51 - +321
250"	538x337	710 - 1277	-64 - +401
280"	603x377	796 - 1431	-72 - +449

Unit: cm

Short throw zoom lens ELPLU01

4:3 Screen Size		①	②
		Minimum (Wide) to Maximum (Tele)	Vertical Lens Shift Top to Bottom
60"	122x91	78 - 95	-7 - +98

4:3 Screen Size		①	②
		Minimum (Wide) to Maximum (Tele)	Vertical Lens Shift Top to Bottom
80"	163x122	105 - 127	-9 - +131
100"	203x152	133 - 160	-12 - +164
150"	305x229	201 - 242	-17 - +246
200"	406x305	270 - 324	-23 - +328
250"	508x381	338 - 407	-29 - +410
300"	610x457	407 - 489	-35 - +492

Unit: cm

16:9 Screen Size		①	②
		Minimum (Wide) to Maximum (Tele)	Vertical Lens Shift Top to Bottom
60"	133x75	85 - 103	-20 - +95
80"	177x100	115 - 139	-27 - +126
100"	221x125	145 - 175	-33 - +158
150"	332x187	220 - 264	-50 - +237
200"	443x249	294 - 354	-67 - +316
250"	553x311	369 - 443	-83 - +395
275"	609x342	407 - 489	-92 - +435

Unit: cm

16:10 Screen Size		①	②
		Minimum (Wide) to Maximum (Tele)	Vertical Lens Shift Top to Bottom
60"	130x81	83 - 101	-15 - +96
70"	151x94	97 - 118	-18 - +112
80"	172x108	112 - 135	-21 - +128

16:10 Screen Size		①	②
		Minimum (Wide) to Maximum (Tele)	Vertical Lens Shift Top to Bottom
100"	215x135	141 - 170	-26 - +160
150"	323x202	214 - 257	-39 - +241
200"	431x269	286 - 344	-51 - +321
250"	538x337	359 - 431	-64 - +401
283"	610x381	407 - 489	-73 - +454

16:9 Screen Size		①	②
50"	111x62	83	+31
60"	133x75	101	+37
80"	177x100	136	+50
100"	221x125	171	+62
150"	332x187	259	+93
184"	407x229	318	+114

Unit: cm

Rear projection wide lens ELPLR03

Lens shift is not supported.

Unit: cm

4:3 Screen Size		①	②
30"	61x46	44	+23
40"	81x61	60	+30
50"	102x76	76	+38
60"	122x91	92	+46
80"	163x122	125	+61
100"	203x152	157	+76
150"	305x229	237	+114
200"	406x305	318	+152

16:10 Screen Size		①	②
29"	62x39	45	+20
30"	65x40	47	+20
50"	108x67	81	+34
60"	130x81	98	+40
70"	151x94	115	+47
80"	172x108	132	+54
100"	215x135	166	+67
150"	323x202	252	+101
189"	407x254	318	+127

Unit: cm

16:9 Screen Size		①	②
28"	62x35	45	+17
30"	66x37	48	+19
40"	89x50	66	+25

Middle throw zoom lens ELPLM04

Unit: cm

4:3 Screen Size		①	②
		Minimum (Wide) to Maximum (Tele)	Vertical Lens Shift Top to Bottom
40"	81x61	184 - 283	-5 - +66
50"	102x76	232 - 357	-6 - +82
60"	122x91	281 - 430	-7 - +98



4:3 Screen Size		①	②
		Minimum (Wide) to Maximum (Tele)	Vertical Lens Shift Top to Bottom
80"	163x122	378 - 577	-9 - +131
100"	203x152	475 - 723	-12 - +164
150"	305x229	717 - 1090	-17 - +246
200"	406x305	959 - 1456	-23 - +328
250"	508x381	1202 - 1823	-29 - +410
300"	610x457	1444 - 2190	-35 - +492

Unit: cm

16:9 Screen Size		①	②
		Minimum (Wide) to Maximum (Tele)	Vertical Lens Shift Top to Bottom
37"	82x46	184 - 283	-12 - +58
40"	89x50	201 - 310	-13 - +63
50"	111x62	254 - 390	-17 - +79
60"	133x75	307 - 469	-20 - +95
80"	177x100	412 - 629	-27 - +126
100"	221x125	518 - 789	-33 - +158
150"	332x187	782 - 1188	-50 - +237
200"	443x249	1046 - 1588	-67 - +316
250"	553x311	1310 - 1987	-83 - +395
275"	609x342	1444 - 2189	-92 - +435

Unit: cm

16:10 Screen Size		①	②
		Minimum (Wide) to Maximum (Tele)	Vertical Lens Shift Top to Bottom
38"	82x51	184 - 284	-10 - +61
50"	108x67	247 - 379	-13 - +80
60"	130x81	298 - 456	-15 - +96
70"	151x94	350 - 534	-18 - +112
80"	172x108	401 - 612	-21 - +128
100"	215x135	504 - 767	-26 - +160
150"	323x202	761 - 1156	-39 - +241
200"	431x269	1017 - 1544	-51 - +321
250"	538x337	1274 - 1933	-64 - +401
283"	610x381	1444 - 2189	-73 - +454

Middle throw zoom lens ELPLM05

Unit: cm

4:3 Screen Size		①	②
		Minimum (Wide) to Maximum (Tele)	Vertical Lens Shift Top to Bottom
40"	81x61	274 - 424	-5 - +66
50"	102x76	347 - 535	-6 - +82
60"	122x91	419 - 645	-7 - +98
80"	163x122	565 - 865	-9 - +131
100"	203x152	710 - 1086	-12 - +164
150"	305x229	1073 - 1637	-17 - +246
200"	406x305	1436 - 2188	-23 - +328
250"	508x381	1799 - 2738	-29 - +410

4:3 Screen Size		①	②
		Minimum (Wide) to Maximum (Tele)	Vertical Lens Shift Top to Bottom
300"	610x457	2162 - 3289	-35 - +492

Unit: cm

16:9 Screen Size		①	②
		Minimum (Wide) to Maximum (Tele)	Vertical Lens Shift Top to Bottom
37"	82x46	274 - 424	-12 - +58
40"	89x50	300 - 464	-13 - +63
50"	111x62	379 - 584	-17 - +79
60"	133x75	458 - 704	-20 - +95
80"	177x100	617 - 944	-27 - +126
100"	221x125	775 - 1184	-33 - +158
150"	332x187	1170 - 1784	-50 - +237
200"	443x249	1566 - 2385	-67 - +316
250"	553x311	1962 - 2985	-83 - +395
275"	609x342	2162 - 3289	-92 - +435

Unit: cm

16:10 Screen Size		①	②
		Minimum (Wide) to Maximum (Tele)	Vertical Lens Shift Top to Bottom
38"	82x51	274 - 424	-10 - +61
50"	108x67	368 - 568	-13 - +80
60"	130x81	445 - 685	-15 - +96
70"	151x94	522 - 801	-18 - +112
80"	172x108	599 - 918	-21 - +128

16:10 Screen Size		①	②
		Minimum (Wide) to Maximum (Tele)	Vertical Lens Shift Top to Bottom
100"	215x135	753 - 1152	-26 - +160
150"	323x202	1138 - 1736	-39 - +241
200"	431x269	1523 - 2320	-51 - +321
250"	538x337	1908 - 2904	-64 - +401
283"	610x381	2162 - 3289	-73 - +454

Long throw zoom lens ELPLL06

Unit: cm

4:3 Screen Size		①	②
		Minimum (Wide) to Maximum (Tele)	Vertical Lens Shift Top to Bottom
40"	81x61	416 - 568	-5 - +66
50"	102x76	525 - 714	-6 - +82
60"	122x91	634 - 861	-7 - +98
80"	163x122	851 - 1154	-9 - +131
100"	203x152	1068 - 1447	-12 - +164
150"	305x229	1612 - 2179	-17 - +246
200"	406x305	2155 - 2912	-23 - +328
250"	508x381	2699 - 3644	-29 - +410
300"	610x457	3242 - 4376	-35 - +492



Unit: cm

16:9 Screen Size		①	②
		Minimum (Wide) to Maximum (Tele)	Vertical Lens Shift Top to Bottom
37"	82x46	416 - 568	-12 - +58
40"	89x50	455 - 620	-13 - +63
50"	111x62	574 - 780	-17 - +79
60"	133x75	692 - 939	-20 - +95
80"	177x100	929 - 1259	-27 - +126
100"	221x125	1166 - 1578	-33 - +158
150"	332x187	1758 - 2376	-50 - +237
200"	443x249	2350 - 3174	-67 - +316
250"	553x311	2942 - 3972	-83 - +395
275"	609x342	3242 - 4376	-92 - +435

16:10 Screen Size		①	②
		Minimum (Wide) to Maximum (Tele)	Vertical Lens Shift Top to Bottom
283"	610x381	3242 - 4376	-73 - +454

Unit: cm

16:10 Screen Size		①	②
		Minimum (Wide) to Maximum (Tele)	Vertical Lens Shift Top to Bottom
38"	82x51	416 - 568	-10 - +61
50"	108x67	558 - 758	-13 - +80
60"	130x81	673 - 913	-15 - +96
70"	151x94	788 - 1069	-18 - +112
80"	172x108	903 - 1224	-21 - +128
100"	215x135	1134 - 1535	-26 - +160
150"	323x202	1710 - 2311	-39 - +241
200"	431x269	2286 - 3087	-51 - +321
250"	538x337	2862 - 3864	-64 - +401

Supported Resolutions

Computer signals (analog RGB)

Signal	Refresh Rate (Hz)	Resolution (Dots)
VGA	60/72/75/85	640x480
SVGA	56/60/72/75/85	800x600
XGA	60/70/75/85	1024x768
WXGA	60	1280x768
	60	1366x768
	60/75/85	1280x800
WXGA+	60/75/85	1440x900
WXGA++	60	1600x900
SXGA	70/75/85	1152x864
	60/75/85	1280x1024
	60/75/85	1280x960
SXGA+	60/75	1400x1050
WSXGA+*1	60	1680x1050
UXGA	60	1600x1200
WUXGA*2	60	1920x1200
MAC13"	67	640x480
MAC16"	75	832x624
MAC19"	75	1024x768
	59	1024x768

Signal	Refresh Rate (Hz)	Resolution (Dots)
MAC21"	75	1152x870

*1 Only compatible when **Wide** is selected as the **Resolution** from the Configuration menu. (This is not available for EB-G6350/EB-G6150.)

*2 EB-G6750WU/EB-G6650WU/EB-G6550WU/EB-G6450WU only. Only compatible when VESA CVT-RB (Reduced Blanking) signal is input.

Even when signals other than those mentioned above are input, it is likely that the image can be projected. However, not all functions may be supported.

Component Video

Signal	Refresh Rate (Hz)	Resolution (Dots)
SDTV (480i)	60	720x480
SDTV (576i)	50	720x576
SDTV (480p)	60	720x480
SDTV (576p)	50	720x576
HDTV (720p)	50/60	1280x720
HDTV (1080i)	50/60	1920x1080
HDTV (1080p)*	50/60	1920x1080

* EB-G6750WU/EB-G6650WU/EB-G6550WU/EB-G6450WU only

Composite video

Signal	Refresh Rate (Hz)	Resolution (Dots)
TV (NTSC)	60	720x480
TV (SECAM)	50	720x576
TV (PAL)	50/60	720x576

**Input signal from the HDMI port and DisplayPort (EB-G6750WU/
EB-G6650WU/EB-G6550WU/EB-G6450WU/EB-G6250W/EB-G6050W)**

Signal	Refresh Rate (Hz)	Resolution (Dots)
VGA	60	640x480
SVGA	60	800x600
XGA	60	1024x768
WXGA	60	1280x800
	60	1280x768*1
	60	1366x768
WXGA+	60	1440x900
WXGA++	60	1600x900
WSXGA+	60	1680x1050
SXGA	60	1280x960
	60	1280x1024
SXGA+	60	1400x1050
UXGA	60	1600x1200
WUXGA*2	60	1920x1200
SDTV (480i*3/480p)	60	720x480
SDTV (576i*3/576p)	50	720x576
HDTV (720p)	50/60	1280x720
HDTV (1080i)	50/60	1920x1080
HDTV (1080p)	24*3/30*3/50/60	1920x1080

*1 DisplayPort input only

*2 EB-G6750WU/EB-G6650WU/EB-G6550WU/EB-G6450WU only. Only compatible when VESA CVT-RB (Reduced Blanking) signal is input.

*3 HDMI input only

**Input signal from the HDMI port and DisplayPort (EB-G6350/EB-
G6150)**

Signal	Refresh Rate (Hz)	Resolution (Dots)
VGA	60	640x480
SVGA	60	800x600
XGA	60	1024x768
WXGA	60	1280x800
	60	1280x768*1
	60	1366x768*2
WXGA+	60	1440x900
WXGA++	60	1600x900
SXGA	60	1280x960
	60	1280x1024
SXGA+	60	1400x1050
UXGA	60	1600x1200
SDTV (480i*2/480p)	60	720x480
SDTV (576i*2/576p)	50	720x576
HDTV (720p)	50/60	1280x720
HDTV (1080i)	50/60	1920x1080
HDTV (1080p)	24*2/30*2/50/60	1920x1080

*1 DisplayPort input only

*2 HDMI input only

Projector General Specifications

Product name	EB-G6750WU	EB-G6650WU	EB-G6550WU	EB-G6450WU	EB-G6350	EB-G6250W	EB-G6150	EB-G6050W
Dimensions	505 (W) x 144 (H) x 382 (D) mm (not including raised section)							
LCD panel size	0.76" Wide				0.79"	0.76" Wide	0.79"	0.76" Wide
Display method	Polysilicon TFT active matrix							
Resolution	2,304,000 pixels WUXGA (1920 (W) x 1200 (H) dots) x 3				786,432 pixels XGA (1024 (W) x 768 (H) dots) x 3	1,024,000 pixels WXGA (1280 (W) x 800 (H) dots) x 3	786,432 pixels XGA (1024 (W) x 768 (H) dots) x 3	1,024,000 pixels WXGA (1280 (W) x 800 (H) dots) x 3
Focus adjustment	Manual							
Zoom adjustment*1	Manual (1 - 1.8)							
Lens shift*2	Manual (Vertical direction: Maximum approx. 67%, Horizontal direction: Maximum approx. 30%)				Manual (Vertical direction: Maximum approx. 57%, Horizontal direction: Maximum approx. 30%)	Manual (Vertical direction: Maximum approx. 67%, Horizontal direction: Maximum approx. 30%)	Manual (Vertical direction: Maximum approx. 57%, Horizontal direction: Maximum approx. 30%)	Manual (Vertical direction: Maximum approx. 67%, Horizontal direction: Maximum approx. 30%)
Lamp	UHE lamp, 380 W Model No.: ELPLP76							
Max. audio output	10 W monaural							
Speaker	1							
Power supply	100-240V AC±10% 50/60Hz 5.7-2.5A	100-240V AC ±10% 50/60Hz 5.3-2.3A	100-240V AC ±10% 50/60Hz 4.7-2.1A		100-240V AC±10% 50/60Hz 5.7-2.5A		100-240V AC ±10% 50/60Hz 5.3-2.3A	100-240V AC ±10% 50/60Hz 5.0-2.2A

Power consumption	100 to 120 V area	Operating: 568 W Standby power consumption (Communication On): 2.8 W Standby power consumption (Communication Off): 0.31 W	Operating: 528 W Standby power consumption (Communication On): 2.8 W Standby power consumption (Communication Off): 0.31 W	Operating: 468 W Standby power consumption (Communication On): 2.8 W Standby power consumption (Communication Off): 0.31 W	Operating: 568 W Standby power consumption (Communication On): 2.8 W Standby power consumption (Communication Off): 0.31 W	Operating: 528 W Standby power consumption (Communication On): 2.8 W Standby power consumption (Communication Off): 0.31 W	Operating: 498 W Standby power consumption (Communication On): 2.8 W Standby power consumption (Communication Off): 0.31 W
	220 to 240 V area	Operating: 542 W Standby power consumption (Communication On): 3.3 W Standby power consumption (Communication Off): 0.41 W	Operating: 504 W Standby power consumption (Communication On): 3.3 W Standby power consumption (Communication Off): 0.41 W	Operating: 449 W Standby power consumption (Communication On): 3.3 W Standby power consumption (Communication Off): 0.41 W	Operating: 542 W Standby power consumption (Communication On): 3.3 W Standby power consumption (Communication Off): 0.41 W	Operating: 504 W Standby power consumption (Communication On): 3.3 W Standby power consumption (Communication Off): 0.41 W	Operating: 477 W Standby power consumption (Communication On): 3.3 W Standby power consumption (Communication Off): 0.41 W
Operating altitude	Altitude 0 to 3048 m						
Operating temperature	0 to +45°C*3 (No condensation)						
Storage temperature	-10 to +60°C (No condensation)						
Mass	Approx. 9.7 kg	Approx. 9.7 kg	Approx. 9.7 kg	Approx. 9.7 kg	Approx. 9.7 kg	Approx. 9.7 kg	Approx. 9.7 kg

*1 The specifications are when a standard zoom lens is attached.

*2 The rear projection wide lens ELPLR03 does not support lens shift.

*3 The operating temperature is 0 to +45°C when Power Consumption is set to ECO or Temp Interlock, and 0 to +40°C when it is set to Normal at an altitude of 0 to 1499m.

The operating temperature is 0 to +40°C when Power Consumption is set to ECO or Temp Interlock, and 0 to +35°C when it is set to Normal at an altitude of 1500 to 3048m.

Product name	EB-G6750WU	EB-G6650WU	EB-G6550WU	EB-G6450WU	EB-G6350	EB-G6250W	EB-G6150	EB-G6050W
---------------------	------------	------------	------------	------------	----------	-----------	----------	-----------

Connectors	Computer Port	1	Mini D-Sub15-pin (female) blue		
	Audio1 port	1	Stereo mini jack (3.5Φ)		
	BNC port	1	5BNC (female)		
	Audio2 port	1	Stereo mini jack (3.5Φ)		
	DisplayPort	1	DisplayPort		
	HDMI port	1	HDMI HDCP supported (Audio is only supported by PCM)		
	Audio3 port	1	Stereo mini jack (3.5Φ)		
	S-Video port	1	Mini DIN 4-pin		
	Video port	1	RCA pin jack		
	Audio-L/R port	1	RCA pin jack x 2 (L-R)		
	Audio Out port	1	Stereo mini jack (3.5Φ)		
	Monitor Out port	1	Mini D-Sub15-pin (female) black		
	HDBaseT port	1	RJ-45	-	
	LAN port	1	RJ-45		
	Service port*	1	Mini USB Connector (Type B)		
	RS-232C port	1	Mini D-Sub 9-pin (male)		
	Remote port	1	Stereo mini jack (3.5Φ)		
USB port (Only for Wireless LAN unit)*	1	USB connector (Type A)			

* USB 2.0 is supported. However, USB ports are not guaranteed to operate all devices that support USB.

This product is also designed for IT power distribution system with phase-to-phase voltage 230V.

DECLARATION of CONFORMITY

According to 47CFR, Part 2 and 15

Class B Personal Computers and Peripherals; and/or
CPU Boards and Power Supplies used with Class B Personal Computers

We: Epson America, Inc.
Located at: 3840 Kilroy Airport Way
MS: 3-13
Long Beach, CA 90806
Tel: 562-981-3840

Declare under sole responsibility that the product identified herein, complies with 47CFR Part 2 and 15 of the FCC rules as a Class B digital device. Each product marketed, is identical to the representative unit tested and found to be compliant with the standards. Records maintained continue to reflect the equipment being produced can be expected to be within the variation accepted, due to quantity production and testing on a statistical basis as required by 47CFR 2.909. Operation is subject to the following two conditions : (1) this device may not cause harmful interference, and (2) this device must accept any interference received, including interference that may cause undesired operation.

Trade Name: EPSON
Type of Product: LCD Projector
Model: H508C/H509C/H510C/H511C/H512C/H513C/
H535C/H542C

**FCC Compliance Statement
For United States Users**

This equipment has been tested and found to comply with the limits for a Class B digital device, pursuant to Part 15 of the FCC Rules. These limits are designed to provide reasonable protection against harmful interference in a residential installation. This equipment generates, uses, and can radiate radio frequency energy and, if not installed and used in accordance with the instructions, may cause harmful interference to radio communications. However, there is no guarantee that interference will not occur in a particular installation. If this equipment does cause interference to radio or television reception, which can be determined by turning the equipment off and on, the user is encouraged to try to correct the interference by one or more of the following measures.

- Reorient or relocate the receiving antenna.
- Increase the separation between the equipment and receiver.
- Connect the equipment into an outlet on a circuit different from that to which the receiver is connected.
- Consult the dealer or an experienced radio/TV technician for help.

WARNING

The connection of a non-shielded equipment interface cable to this equipment will invalidate the FCC Certification or Declaration of this device and may cause interference levels which exceed the limits established by the FCC for this equipment. It is the responsibility of the user to obtain and use a shielded equipment interface cable with this device. If this equipment has more than one interface connector, do not leave cables connected to unused interfaces. Changes or modifications not expressly approved by the manufacturer could void the user's authority to operate the equipment.

Units: mm

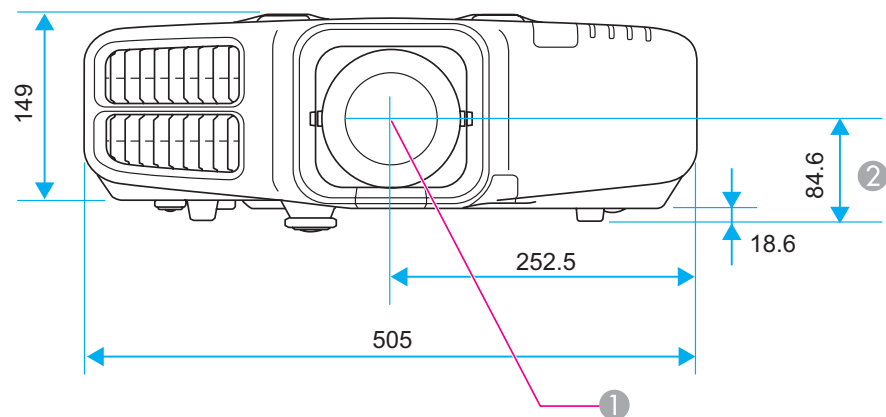

- ① Center of lens
- ② Distance from center of lens to suspension bracket fixing point

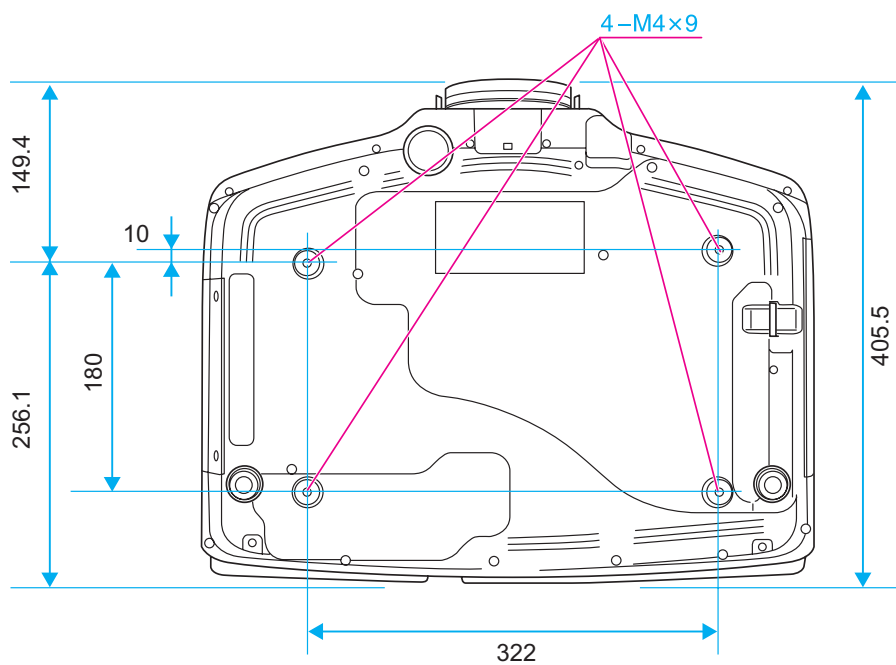

This section briefly explains the difficult terms that are not explained in the text of this guide. For details, refer to other commercially available publications.

Ad hoc mode	A method of wireless LAN connection that communicates with wireless LAN clients without using an access point.
AMX Device Discovery	AMX Device Discovery is a technology developed by AMX to facilitate AMX control systems for easy operation of the target equipment. Epson have implemented this protocol technology, and have provided a setting to enable the protocol function (ON). See the AMX Web site for more details. URL http://www.amx.com/
Aspect Ratio	The ratio between an image's length and its height. Screens with a horizontal:vertical ratio of 16:9, such as HDTV screens, are known as wide screens. SDTV and general computer displays have an aspect ratio of 4:3.
Component Video	A method that separates the video signal into a luminance component (Y), and a blue minus luminance (Cb or Pb) and a red minus luminance (Cr or Pr).
Composite video	A method that combines the video signal into a luminance component and a color component for transmission down a single cable.
Contrast	The relative brightness of the light and dark areas of an image can be increased or decreased to make text and graphics stand out more clearly, or to make them appear softer. Adjusting this particular property of an image is called contrast adjustment.
DHCP	An abbreviation of Dynamic Host Configuration Protocol, this protocol automatically assigns an IP address to equipment connected to a network.
DICOM	An acronym for Digital Imaging and Communications in Medicine. An international standard that defines image standards and a communications protocol for medical images.
Gateway Address	This is a server (router) for communicating across a network (subnet) divided according to subnet mask .
HDBaseT	The connection standard for consumer electronics determined by the HDBaseT Alliance. Communicates various control signals such as uncompressed HD video, audio and 100BASE-TX Ethernet using a LAN cable.
HDCP	HDCP is an abbreviation for High-bandwidth Digital Content Protection. It is used to prevent illegal copying and protect copyrights by encrypting digital signals sent over DVI and HDMI ports. Because the HDMI port and DisplayPort on this projector supports HDCP, it can project digital images protected by HDCP technology. However, the projector may not be able to project images protected with updated or revised versions of HDCP encryption.
HDTV	An abbreviation for High-Definition Television that refers to high-definition systems which satisfy the following conditions. <ul style="list-style-type: none"> • Vertical resolution of 720p or 1080i or greater (p = Progressive, i = Interlace) • Screen aspect ratio of 16:9
Infrastructure mode	A method for wireless LAN connection in which devices communicate through access points.
Interlace	Transmits information needed to create one screen by sending every other line, starting from the top of the image and working down to the bottom. Images are more likely to flicker because one frame is displayed every other line.

IP Address	A number to identify a computer connected to a network.
Progressive	Projects information to create one screen at a time, displaying the image for one frame. Even though the number of scan lines is the same, the amount of flicker in images decreases because the volume of information has doubled compared with an interlace system.
Refresh Rate	The light-emitting element of a display maintains the same luminosity and color for an extremely short time. Because of this, the image must be scanned many times per second to refresh the light-emitting element. The number of refresh operations per second is called the Refresh rate and is expressed in hertz (Hz).
SDTV	An abbreviation for Standard Definition Television that refers to standard television systems which do not satisfy the conditions for HDTV ▶ High-Definition Television.
SNMP	An abbreviation for Simple Network Management Protocol, which is the protocol for monitoring and controlling devices such as routers and computers connected to a TCP/IP network.
sRGB	An international standard for color intervals that was formulated so that colors that are reproduced by video equipment can be handled easily by computer operating systems (OS) and the Internet. If the connected source has an sRGB mode, set both the projector and the connected signal source to sRGB.
Subnet Mask	This is a numerical value that defines the number of bits used for the network address on a divided network (subnet) from the IP address.
Sync.	The signals output from computers have a specific frequency. If the projector frequency does not match this frequency, the resulting images are not of a good quality. The process of matching the phases of these signals (the relative position of the crests and the troughs in the signal) is called Synchronization. If the signals are not synchronized, flickering, blurriness, and horizontal interference occur.
Tracking	The signals output from computers have a specific frequency. If the projector frequency does not match this frequency, the resulting images are not of a good quality. The process of matching the frequency of these signals (the number of crests in the signal) is called Tracking. If Tracking is not carried out correctly, wide vertical stripes appear in the signal.
Trap IP Address	This is the IP address ▶ for the destination computer used for error notification in SNMP.
WPS (Wi-Fi Protected Setup)	Wi-Fi Protected Setup has been devised by the Wi-Fi Alliance as a means of easily setting up and securing a wireless LAN.