

EPSON
EXCEED YOUR VISION

User's Guide

Multimedia Projector

EB-1410Wi



EB-1400Wi

Notations Used in This Guide





- **Safety indications**

The documentation and the projector use graphical symbols to show how to use the projector safely.

The indications and their meaning are as follows. Make sure you understand them properly before reading the guide.

 Warning	This symbol indicates information that, if ignored, could possibly result in personal injury or even death due to incorrect handling.
 Caution	This symbol indicates information that, if ignored, could possibly result in personal injury or physical damage due to incorrect handling.

- **General information indications**

Attention	Indicates procedures which may result in damage or injury if sufficient care is not taken.
	Indicates additional information and points which may be useful to know regarding a topic.
	Indicates a page where detailed information regarding a topic can be found.
	Indicates that an explanation of the underlined word or words in front of this symbol appears in the glossary of terms. See the "Glossary" section of the "Appendices".  "Glossary" p.209
[Name]	Indicates the name of the buttons on the remote control or the control panel. Example: [Esc] button
Menu Name	Indicates Configuration menu items. Example: Select Brightness from Image . Image - Brightness

Notations Used in This Guide 2

Introduction

Projector Features 9

- Interactive Function (Easy Interactive Function) 9
- Easily Perform Operations from the Control Pad 9
- Connecting to a Network and Projecting Images from the Computer's Screen 9
- Project Two Images Simultaneously (Split Screen) 9

Part Names and Functions 10

- Front/Top 10
- Side 11
- Interface 12
- Base 13
 - Attaching the feet (Only models with feet supplied) 14
- Control Panel 15
- Remote Control 16
 - Replacing the remote control batteries 19
 - Remote control operating range 20
- Easy Interactive Pen 20
 - Replacing the battery for the Easy Interactive Pen 21
 - Replacing the tip of the Easy Interactive Pen 22
- Pen Tray 22
- Control Pad 23
 - Replacing the batteries for the Control Pad 24

Preparing the Projector

Installing the Projector 27

- Installation Methods 27

Connecting Equipment 29

- Connecting to the Projector 31
 - Connecting a computer 31

- Connecting image sources 33
- Connecting USB devices 35
- Connecting external equipment 37
- Connecting a LAN cable 39
- Installing the wireless LAN unit 40
- Connecting to the Control Pad 41
 - Connecting when using the PC Interactive function 41
 - Connecting using USB Display 42
 - Connecting using PC Free 43
 - Connecting a printer 44

Basic Projection Methods

Projecting images 46

- From Installation to Projection 46
- Automatically Detect Input Signals and Change the Projected Image (Source Search) 47
- Projecting with USB Display 48
 - Necessary settings 48
 - System requirements 48
 - Connecting for the first time 49
 - Uninstalling 50

Adjusting Projected Images 51

- Correcting Keystone Distortion 51
 - H/V-Keystone 51
 - Quick Corner 52
- Adjusting the Image Size 54
- Adjusting the Position of the Image (Image Shift) 54
- Adjusting the Vertical Position of the Image (Models Supplied with the Feet Only) 55
 - Raising the height of the image 55
 - Lowering the height of the image 56
- Adjusting the Horizontal Position of the Image (Models Supplied with the Feet Only) 56
- Correcting the Focus 56
- Adjusting the Volume 56

Adjusting the Image 57
 Hue, Saturation, and Brightness adjustment 57
 Gamma adjustment 57
 Selecting the Projection Quality (Selecting Color Mode) 58
 Setting Auto Iris 59
 Changing the Aspect Ratio of the Projected Image 59
 Changing methods 60
 Changing the aspect mode 60

Interactive Function

Summary of the Interactive Function 63

Performing a Variety of Tasks with the Interactive Function 63
 Three Modes 64

Before Using the Interactive Function 65

Auto Calibration 65
 Manual Calibration 66
 When You Need to Calibrate the Pen 67
 Using the Pen 67

Drawing 69

Drawing on a Whiteboard Screen (Whiteboard Mode) 69
 Starting Whiteboard Mode 69
 Toolbar functions 70
 Bottom toolbar functions 72
 Read paper documents from a scanner 73
 Opening files and reading into Whiteboard Mode 74
 Drawing on the Projected Image (PC Free Annotation) 75
 Starting PC Free Annotation 75
 Toolbar functions 76
 Bottom toolbar functions 78

Using Drawing Content 80

Saving 80
 For Whiteboard Mode 80
 For PC Free Annotation 80

Printing 81
 For Whiteboard Mode 81
 For PC Free Annotation 82
 Sending Emails (Whiteboard Mode Only) 82

Operating a Computer from the Projected Screen (PC Interactive) 84

Preparing the Projector 84
 Install Easy Interactive Driver (Mac OS X only) 85
 Changing to PC Interactive 86
 Adjusting the Pen Operation Area 87
 Manual Adjust Pen Area 87

Useful Functions

Projection Functions 90

Projecting Two Images Simultaneously (Split Screen) 90
 Input sources for split screen projection 90
 Operating procedures 91
 When using the interactive function 93
 Restrictions during split screen projection 95
 Projecting Images Stored on a USB Storage Device (PC Free) 95
 Specifications for files that can be projected using PC Free 95
 PC Free examples 97
 PC Free operating methods 97
 Projecting the selected images or movies 99
 Projecting PDF files 100
 Projecting image files in a folder in sequence (Slideshow) 102
 Playing a scenario 103
 Operations while playing a scenario 103
 Image file display settings and Slideshow operation settings 104
 Hiding the Image and Sound Temporarily (A/V Mute) 105
 Freezing the Image (Freeze) 105
 Pointer Function (Pointer) 105
 Enlarging Part of the Image (E-Zoom) 107
 Using the Remote Control to Operate the Mouse Pointer (Wireless Mouse) 108
 Saving a User's Logo 109



Saving User Pattern	111
Security Functions	113
Managing Users (Password Protect)	113
Kinds of Password Protect	113
Setting Password Protect	113
Entering the Password	114
Restricting Operation (Control Panel Lock)	115
Anti-Theft Lock	117
Installing the wire lock	117
Network Functions	118
Using the Interactive Function over a Network	118
Starting	118
Restrictions	118
Projecting with "Connect to a Network Projector"	118
Making a WPS (Wi-Fi Protected Setup) Connection with a Wireless LAN Access Point	120
Connection setup method	120
Monitoring and Controlling	122
About EasyMP Monitor	122
Changing Settings Using a Web Browser (Web Control)	122
Projector setup	122
Displaying the Web Control screen	123
Displaying the Web Remote screen	123
Setting Certificates	125
Secure HTTP Notes	125
List of supported certificates	126
Using the Mail Notification Function to Report Problems	126
Reading Error Notification Mail	126
Management Using SNMP	127
ESC/VP21 Commands	127
Command list	127
Cable layouts	128
About PJLink	129
About Crestron RoomView®	129
Operating a projector from your computer	130
Setting Schedule	133

Setting Methods	133
Clock	134
Schedule	134

Configuration Menu

Using the Configuration Menu	136
---	------------

List of Functions	137
--------------------------------	------------

Configuration Menu Table	137
Network menu	138
Image Menu	139
Signal Menu	140
Settings Menu	142
Extended Menu	144
Easy Interactive Function setting items	146
Whiteboard Settings screen	147
Network Menu	150
Notes on operating the Network menu	151
Soft keyboard operations	152
Basic menu	152
Wireless LAN menu	153
Security menu	155
Wired LAN menu	157
Administrator Settings menu	158
Reset menu	162
Info Menu (Display Only)	162
Reset Menu	163

Troubleshooting

Using the Help	165
-----------------------------	------------

Problem Solving	166
------------------------------	------------

Reading the Indicators	166
When the Indicators Provide No Help	170

- Problems Relating to Images 171
 - No images appear 171
 - Moving images are not displayed (only the moving image portion turns black) 172
 - Projection stops automatically 172
 - The message Not supported is displayed 172
 - The message No Signal is displayed 172
 - Images are fuzzy, out of focus, or distorted 173
 - Interference or distortion appear in images 174
 - The mouse cursor flickers (only when projecting USB Display) 174
 - The image is truncated (large) or small, the aspect is not suitable, or the image has been reversed 175
 - Image colors are not right 175
 - Images appear dark 176
- Problems when Projection Starts 177
 - The projector does not turn on 177
- Problems with the Interactive Function 177
 - Cannot use the projector's drawing function 177
 - Cannot operate as a mouse and draw by connecting to a computer 178
 - The message An error occurred in the Easy Interactive Function. is displayed 178
 - Computer's mouse does not work correctly 178
 - The Easy Interactive Pen does not work 179
 - The response time for the Easy Interactive Pen is slow 179
 - The dot does not move to the next position 179
 - The dot moves automatically 180
 - Cannot perform operations while capturing, printing, or saving 180
 - Cannot paste the capture of the projected screen correctly 180
 - Cannot print normally 180
 - Cannot scan normally 181
 - The time is out of sync, settings for the internal storage are not reflected correctly 181
 - Cannot change the source 181
- Other Problems 182
 - No sound can be heard or the sound is faint 182
 - There is noise in the audio (only when projecting USB Display) 182
 - The remote control does not work 183
 - I want to change the language for messages and menus 183
 - The authentication setting of wireless LAN fails 183

- Mail is not received even if an error occurs with the projector 184
- The message The battery that saves your clock settings is running low. is displayed 184
- Image file names are not displayed correctly in PC Free 184
- Cannot change settings using a web browser 185

About Event ID 186

Maintenance

Cleaning 189

- Cleaning the Projector's Surface 189
- Cleaning the Projection Window 189
- Cleaning the Obstacle Sensor 189
- Cleaning the Air Filter 190

Replacing Consumables 191

- Replacing the Lamp 191
 - Lamp replacement period 191
 - How to replace the lamp 192
 - Resetting the lamp hours 194
- Replacing the Air Filter 194
 - Air filter replacement period 194
 - How to replace the air filter 194

Appendix

Optional Accessories and Consumables 198

- Optional Accessories 198
- Consumables 198

Screen Size and Projection Distance 199

Supported Monitor Displays 201

- Supported Resolutions 201
 - Computer signals (analog RGB) 201
 - Component Video 201



Composite video	201
Input signal from the HDMI port and DisplayPort	201
Specifications	203
Projector General Specifications	203
Appearance	207
Glossary	209
General Notes	211
Wireless Telegraphy Act Regulations	211
About Notations	211
General Notice:	212
Index	213



Introduction

This chapter explains the projector's features and the part names.

Interactive Function (Easy Interactive Function)

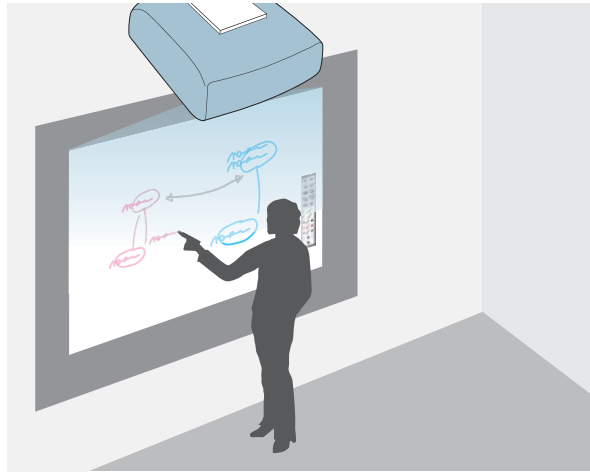

You can perform the following operations with the electronic pen (Easy Interactive Pen).

- Draw on plain screens such as whiteboards
 - Draw on documents being projected
 - Perform computer mouse operations on the projected screen
 - Read paper documents from a scanner
 - Save the projected screen
 - Print the projected screen
 - Attach the projected screen to an email and send
- ☛ "Interactive Function" [p.62](#)

Easily Perform Operations from the Control Pad

By installing the Control Pad supplied, you can easily perform frequently used operations such as turning the projector on or off and changing the source. You can also connect a USB storage or USB cables for a printer and so on.

☛ "Control Pad" [p.23](#)

☛ "Connecting to the Control Pad" [p.41](#)

Connecting to a Network and Projecting Images from the Computer's Screen

When connected to the network, you can perform the following operations.

You can connect the projector to a computer on a network and project the computer's screen using the supplied EasyMP Network Projection (application software).

☛ [EasyMP Network Projection Operation Guide](#)

Content drawn using the interactive function can also be projected from projectors in other conference rooms.

☛ "Using the Interactive Function over a Network" [p.118](#)

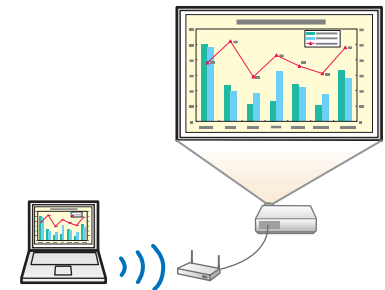

Project Two Images Simultaneously (Split Screen)

This function divides the projected screen in two and projects two types of image side-by-side. By simultaneously projecting images from two sources on one screen, you can raise the impact of your message or proposition during video conferences or presentations.

☛ "Projecting Two Images Simultaneously (Split Screen)" [p.90](#)



Front/Top

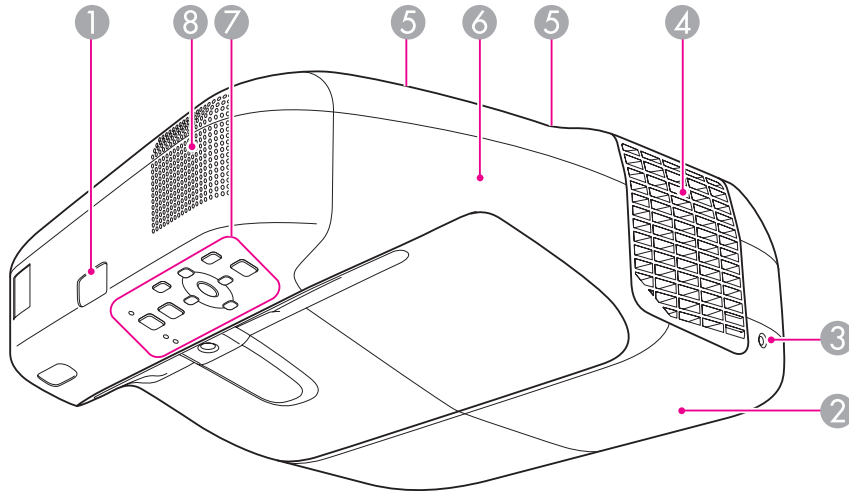

	Name	Function
⑥	Cable cover	Open by loosening both of the screws when connecting to an input port or installing the wireless LAN unit.
⑦	Control panel	Operates the projector. ☛ "Control Panel" p.15
⑧	Speaker	Outputs audio.

	Name	Function
①	Remote receiver	Receives signals from the remote control.
②	Lamp cover	Open when replacing the projector's lamp. ☛ "Replacing the Lamp" p.191
③	Lamp cover fixing screw	Screw to fix the lamp cover in place. ☛ "Replacing the Lamp" p.191
④	Air exhaust vent	Exhaust vent for air used to cool the projector internally. <div style="border: 1px solid black; padding: 5px; margin-top: 10px;"> <p>⚠ Caution</p> <p>While projecting, do not put your face or hands near the air exhaust vent, and do not place objects that may become warped or damaged by heat near the vent. Hot air from the air exhaust vent could cause burns, warping, or accidents to occur.</p> </div>
⑤	Cable cover fixing screws	Screws to fix the cable cover in place.

Side

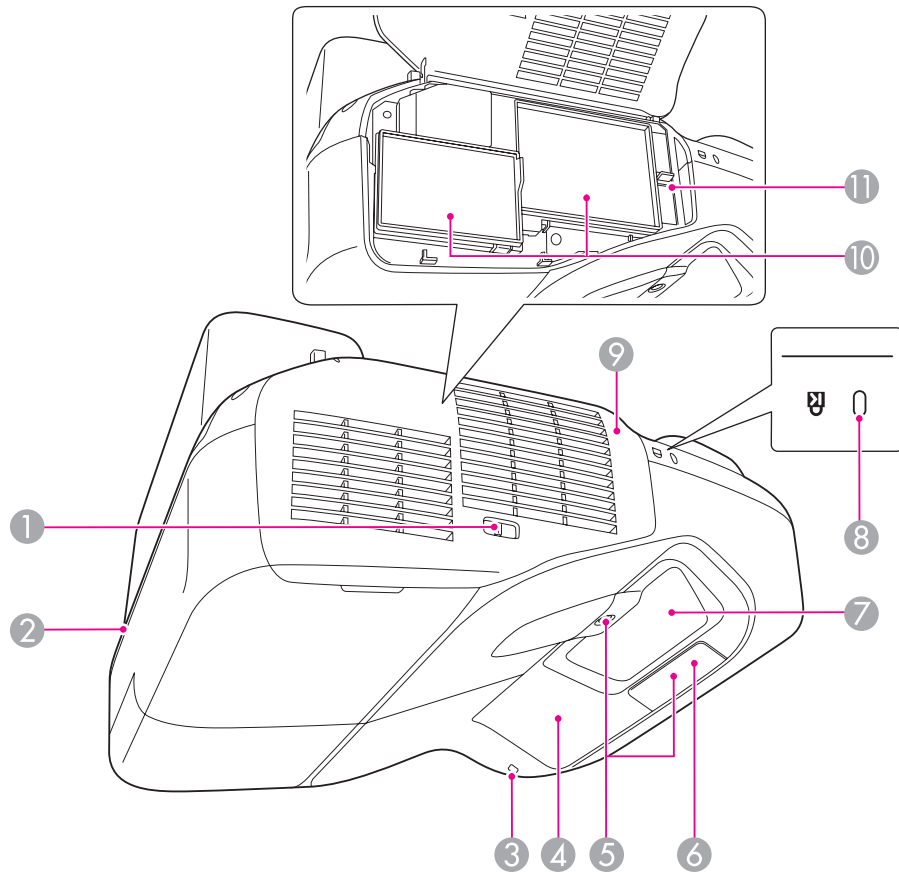

Name	Function
① Air filter cover open/close lever	Opens and closes the air filter cover.
② Security cable installation point	Pass a commercially available wire lock through here and lock it in place. ☛ "Installing the wire lock" p.117

Name	Function
③ Wireless LAN indicator	Indicates the access status to the supplied wireless LAN unit.
④ Easy Interactive Function receiver	Receives signals from the Easy Interactive Pen. ☛ "Interactive Function" p.62
⑤ Obstacle sensor	Detects obstacles that are interfering with the projection area. ☛ "Cleaning the Obstacle Sensor" p.189
⑥ Remote receiver	Receives signals from the remote control.
⑦ Projection window	Projects images. <div style="border: 1px solid black; padding: 5px; margin-top: 10px;"> <p>⚠ Warning</p> <ul style="list-style-type: none"> Do not look into the projection window while projecting. Do not place any objects or put your hand near the projection window. It could cause burns, fire, or the object to warp because this area reaches a high temperature due to the concentrated projection light. </div>
⑧ Security slot	The security slot is compatible with the Microsaver Security System manufactured by Kensington. ☛ "Anti-Theft Lock" p.117
⑨ Air filter cover	Open when changing the air filter or operating the focus lever.
⑩ Air intake vent (air filter)	Takes in air to cool the projector internally. ☛ "Cleaning the Air Filter" p.190 ☛ "Replacing the Air Filter" p.194
⑪ Focus lever	Adjusts the image focus. Open the air filter cover to operate.

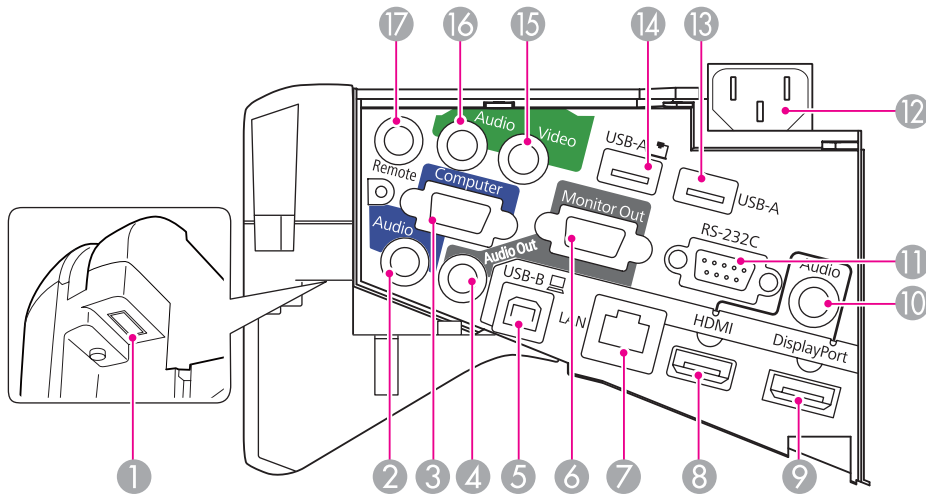

Interface

The following ports are available under the cable cover.



Name	Function
① Wireless LAN unit installation section	Install the supplied wireless LAN unit here. ☛ "Installing the wireless LAN unit" p.40
② Audio1 port	<ul style="list-style-type: none"> Inputs audio from equipment connected to the Computer port. Inputs audio from other devices when projecting images from the device connected to the USB-A port.
③ Computer port	Inputs image signals from a computer and component video signals from other video sources.
④ Audio Out port	Outputs audio from the currently projected image to an external speaker.

Name	Function
⑤ USB-B port	<ul style="list-style-type: none"> Connects the projector to a computer via the supplied USB cable, and projects the images on the computer. ☛ "Projecting with USB Display" p.48 Connects the projector to a computer via the supplied USB cable to use the Wireless Mouse function. ☛ "Using the Remote Control to Operate the Mouse Pointer (Wireless Mouse)" p.108 Connects the projector to a computer via the supplied USB cable to use the Easy Interactive Pen as a mouse or as a pen to draw on the projected screen. ☛ "Operating a Computer from the Projected Screen (PC Interactive)" p.84 By connecting the projector to the Control Pad via the supplied USB cable, you can connect to a computer from the Control Pad. ☛ "Connecting to the Control Pad" p.41
⑥ Monitor Out port	Outputs analog RGB signals input from the Computer port to an external monitor. You cannot output signals input from other ports or component video signals.
⑦ LAN port	Connects a LAN cable to connect to a network.
⑧ HDMI port	Inputs video signals from HDMI compatible video equipment and computers. This projector is compatible with HDCP ». ☛ "Connecting Equipment" p.29
⑨ DisplayPort	Inputs video signals from DisplayPort compatible computers. This projector is compatible with HDCP ».
⑩ Audio3 port	Inputs audio for the specific source set in Extended - Audio Input Setup .
⑪ RS-232C port	When controlling the projector from a computer, connect it to the computer with an RS-232C cable. This port is for control use and should not normally be used. ☛ "ESC/VP21 Commands" p.127
⑫ Power inlet	Connects the power cord to the projector. ☛ "From Installation to Projection" p.46

Name	Function
13 USB-A port	<ul style="list-style-type: none"> Connects a USB memory device or a digital camera and projects PDFs, movies, or images using PC Free. <ul style="list-style-type: none"> "Projecting Images Stored on a USB Storage Device (PC Free)" p.95 By connecting a USB memory, you can store and view content drawn using the interactive function. <ul style="list-style-type: none"> "Using Drawing Content" p.80 You can connect USB printers. By connecting the projector to the Control Pad via the supplied USB cable, you can connect to a USB memory or a printer from the Control Pad. <ul style="list-style-type: none"> "Connecting to the Control Pad" p.41
14 USB-A port 	Projects images from the optional Document Camera. You cannot project using other devices from this port.
15 Video port	Inputs composite video signals from video sources.
16 Audio2 port	Inputs audio from equipment connected to the Video port.
17 Remote port	Connects to the Control Pad.  "Control Pad" p.23

Base

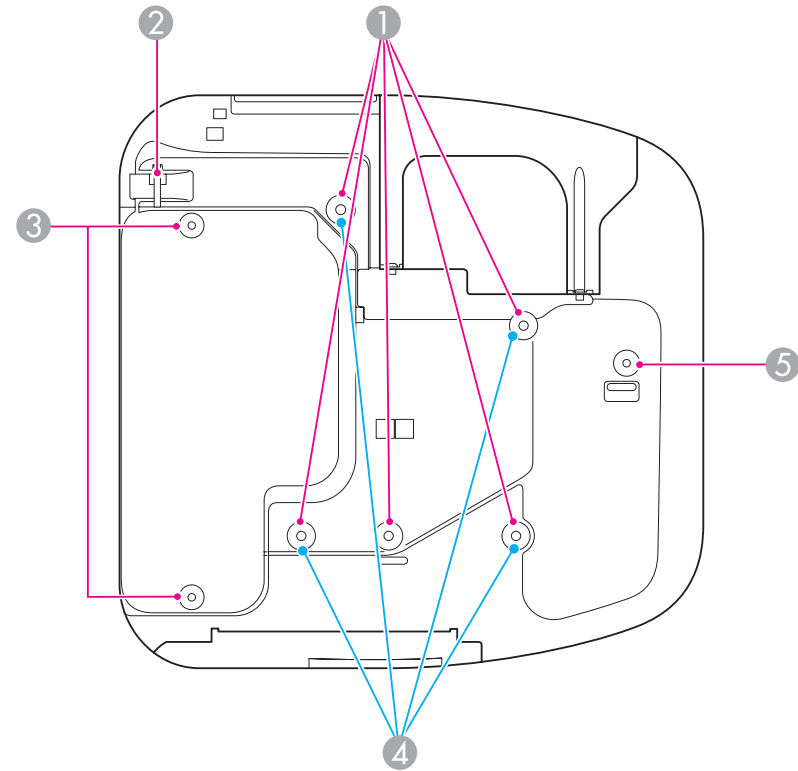

Name	Function
1 Ceiling mount fixing points (five points)	Attach the optional Ceiling Mount here when suspending the projector from a ceiling. <ul style="list-style-type: none"> "Installing the Projector" p.27 "Optional Accessories" p.198
2 Security cable installation point	Pass a commercially available wire lock through here and lock it in place. <ul style="list-style-type: none"> "Installing the wire lock" p.117

	Name	Function
3	Rear foot fixing points (two points)	Attach the feet when using the projector on a surface such as a desk. (Only models with feet supplied) ☛ "Attaching the feet (Only models with feet supplied)" p.14
4	Wall mount fixing points (four points)	Attach the setting plate when mounting on a wall. (Only models with setting plate supplied) ☛ <i>Installation Guide</i> ☛ "Optional Accessories" p.198
5	Front foot fixing point	Attach the foot with a spacer when using the projector on a surface such as a desk. (Only models with feet supplied) ☛ "Attaching the feet (Only models with feet supplied)" p.14

2 Insert the rear feet (x2) into the foot fixing points.



You can install this projector vertically on a desk.

☛ "Installation Methods" p.27

Attaching the feet (Only models with feet supplied)

Insert the feet into the foot fixing points.

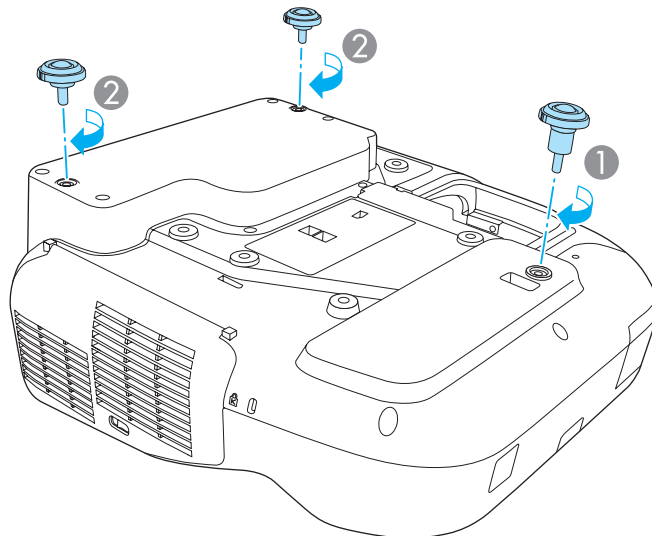

1 Insert the foot with the spacer into the front foot fixing point.

Control Panel

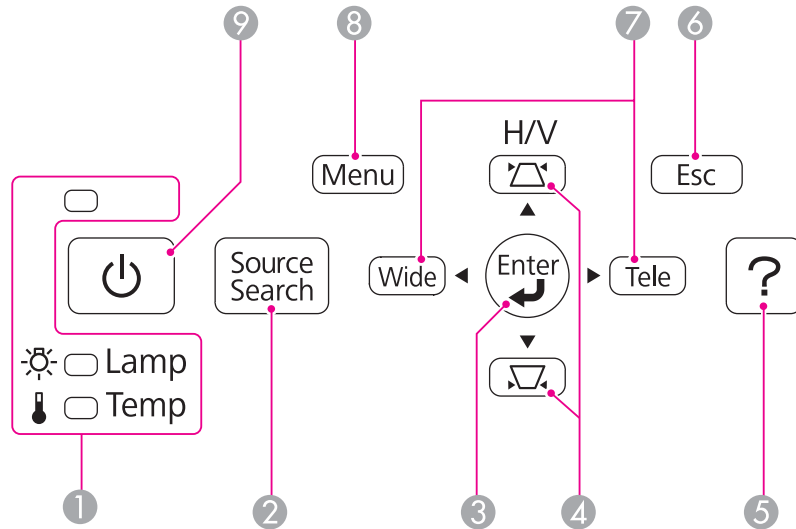



Name	Function
1 Status indicators	Indicates the projector's status using color, and by being lit or flashing. ☛ "Reading the Indicators" p.166
2 [Source Search] button	Switches to the image from the input port where video signals are being input. ☛ "Automatically Detect Input Signals and Change the Projected Image (Source Search)" p.47
3 [Enter] button [↵]	<ul style="list-style-type: none"> When the Configuration menu or the Help screen is displayed, it accepts and enters the current selection and moves to the next level. If pressed while projecting analog RGB signals from the Computer port, you can automatically optimize Tracking, Sync., and Position.

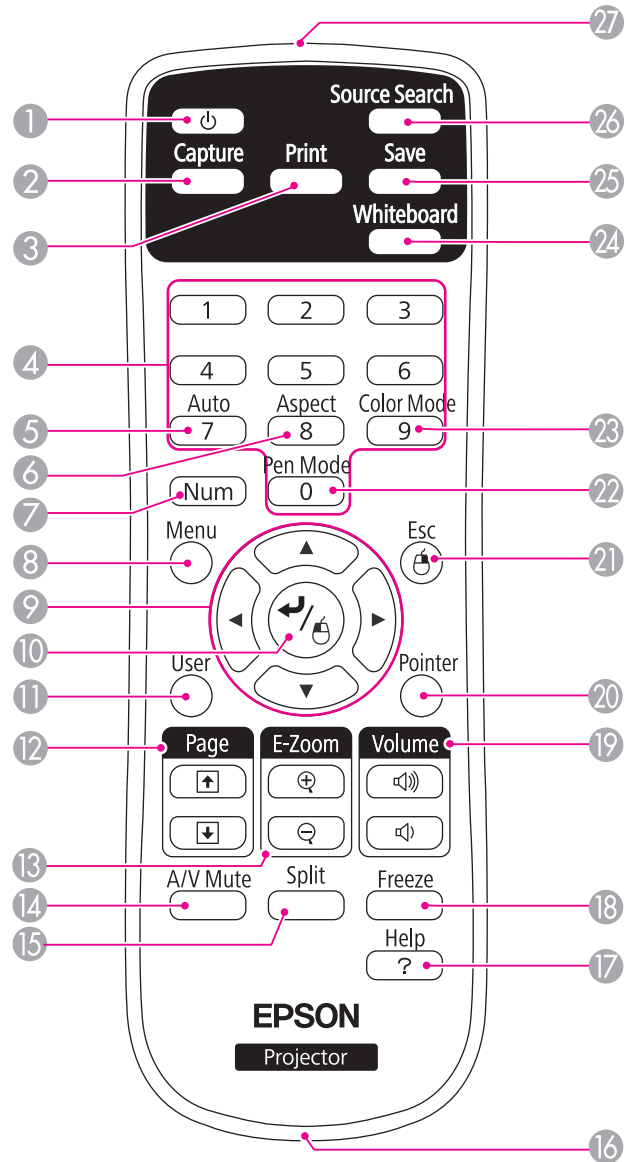

Name	Function
4 [△][▽] button	<ul style="list-style-type: none"> Displays the Keystone screen. ☛ "H/V-Keystone" p.51 If pressed when the Configuration menu or the Help screen is displayed, these buttons select menu items and setting values. ☛ "Using the Configuration Menu" p.136 ☛ "Using the Help" p.165
5 [Help] button	Displays and closes the help screen which shows you how to deal with problems if they occur. ☛ "Using the Help" p.165
6 [Esc] button	<ul style="list-style-type: none"> Stops the current function. If pressed when the Configuration menu is displayed, it moves to the previous menu level. ☛ "Using the Configuration Menu" p.136
7 [Tele]/[Wide] buttons	<ul style="list-style-type: none"> Adjusts the size of the projection screen. Press the [Tele] button to reduce the size of the projection screen and press the [Wide] button to increase the size of the projection screen. Corrects keystone distortion in the horizontal direction when the Keystone screen is displayed. ☛ "H/V-Keystone" p.51 If pressed when the Configuration menu or the Help screen is displayed, these buttons select menu items and setting values. ☛ "Using the Configuration Menu" p.136 ☛ "Using the Help" p.165
8 [Menu] button	Displays and closes the Configuration menu. ☛ "Using the Configuration Menu" p.136
9 [⏻] button	Turns the projector power on or off. ☛ "From Installation to Projection" p.46

Remote Control



	Name	Function
①	[Power] button	Turns the projector power on or off. ☛ "From Installation to Projection" p.46
②	[Capture] button	Takes a snapshot of the projected screen. After taking the snapshot, the image is pasted onto a new page in Whiteboard Mode. (This button cannot be used in Whiteboard Mode.) ☛ "Using Drawing Content" p.80
③	[Print] button	Prints the projected screen. ☛ "Using Drawing Content" p.80
④	Numeric buttons	<ul style="list-style-type: none"> • Enter the Password. ☛ "Setting Password Protect" p.113 • Use this button to enter numbers in Network settings from the Configuration menu.
⑤	[Auto] button	If pressed while projecting analog RGB signals from the Computer port, you can automatically optimize Tracking, Sync., and Position.
⑥	[Aspect] button	Each time the button is pressed, the aspect mode changes. ☛ "Changing the Aspect Ratio of the Projected Image" p.59
⑦	[Num] button	Hold down this button and press the numeric buttons to enter passwords and numbers. ☛ "Setting Password Protect" p.113
⑧	[Menu] button	Displays and closes the Configuration menu. ☛ "Using the Configuration Menu" p.136

	Name	Function
9	 button	<ul style="list-style-type: none"> When the Configuration menu or Help screen is displayed, pressing these buttons selects menu items and setting values. <ul style="list-style-type: none"> "Using the Configuration Menu" p.136 When projecting a PC Free, pressing these buttons displays the previous/next image, rotates the image, and so on. <ul style="list-style-type: none"> "Projecting Images Stored on a USB Storage Device (PC Free)" p.95 During Wireless Mouse function, the mouse pointer moves in the direction of the button that was pushed. <ul style="list-style-type: none"> "Using the Remote Control to Operate the Mouse Pointer (Wireless Mouse)" p.108
10	 button	<ul style="list-style-type: none"> When the Configuration menu or the Help screen is displayed, it accepts and enters the current selection and moves to the next level. <ul style="list-style-type: none"> "Using the Configuration Menu" p.136 Acts as a mouse's left button when using the Wireless Mouse function. <ul style="list-style-type: none"> "Using the Remote Control to Operate the Mouse Pointer (Wireless Mouse)" p.108
11	[User] button	Select any frequently used item from the seven available Configuration menu items, and assign it to this button. By pressing the [User] button, the assigned menu item selection/adjustment screen is displayed, allowing you to make one-touch settings/adjustments. <ul style="list-style-type: none"> "Settings Menu" p.142 Auto Calibration is assigned as the default setting.

	Name	Function
12	[Page] buttons 	Changes pages in files such as PowerPoint files when using the following projection methods. (This button cannot be used in Whiteboard Mode.) <ul style="list-style-type: none"> When using the Wireless Mouse function <ul style="list-style-type: none"> "Using the Remote Control to Operate the Mouse Pointer (Wireless Mouse)" p.108 When using USB Display <ul style="list-style-type: none"> "Projecting with USB Display" p.48 When connecting to a network When projecting images using PC Free, pressing these buttons displays the previous/next screen.
13	[E-Zoom] buttons 	Enlarges or reduces the image without changing the projection size. (This button cannot be used in Whiteboard Mode.) <ul style="list-style-type: none"> "Enlarging Part of the Image (E-Zoom)" p.107
14	[A/V Mute] button	<ul style="list-style-type: none"> Turns the video and audio on or off. <ul style="list-style-type: none"> "Hiding the Image and Sound Temporarily (A/V Mute)" p.105 You can change the Projection mode as follows by pressing the button for about five seconds. <ul style="list-style-type: none"> Front ↔ Front/UpSide Down Rear ↔ Rear/UpSide Down
15	[Split] button	Each time the button is pressed, the image changes between projecting two images simultaneously by splitting the projected screen, or projecting one image as normal. (This button cannot be used in Whiteboard Mode.) <ul style="list-style-type: none"> "Projecting Two Images Simultaneously (Split Screen)" p.90
16	Strap attachment hole	Allows you to attach a commercially available strap to the remote control.

Name		Function
17	[Help] button	Displays and closes the help screen which shows you how to deal with problems if they occur. ☛ "Using the Help" p.165
18	[Freeze] button	Pauses or resumes image playback. ☛ "Freezing the Image (Freeze)" p.105
19	[Volume] buttons [◀] [▶]	[◀] Decreases the volume. [▶] Increases the volume. ☛ "Adjusting the Volume" p.56
20	[Pointer] button	Displays the on-screen pointer. ☛ "Pointer Function (Pointer)" p.105
21	[Esc] button	<ul style="list-style-type: none"> • Stops the current function. • If pressed when the Configuration menu is displayed, it moves to the previous level. ☛ "Using the Configuration Menu" p.136 • Acts as a mouse's right button when using the Wireless Mouse function. ☛ "Using the Remote Control to Operate the Mouse Pointer (Wireless Mouse)" p.108
22	[Pen Mode] button	Changes between using the PC interactive function or drawing for Easy Interactive Pen. (This button cannot be used in Whiteboard Mode.) ☛ "Summary of the Interactive Function" p.63
23	[Color Mode] button	Each time the button is pressed, the color mode changes. ☛ "Selecting the Projection Quality (Selecting Color Mode)" p.58
24	[Whiteboard] button	<ul style="list-style-type: none"> • Press this when the projector is off to turn on the projector and start the interactive function in Whiteboard Mode. • Press this when the projector is on to change to Whiteboard Mode. If you press it in Whiteboard Mode, the image changes to the previous image source. ☛ "Before Using the Interactive Function" p.65

Name		Function
25	[Save] button	Saves the projected screen. ☛ "Using Drawing Content" p.80
26	[Source Search] button	Switches to the image from the input port where video signals are being input. ☛ "Automatically Detect Input Signals and Change the Projected Image (Source Search)" p.47
27	Remote control light-emitting area	Outputs remote control signals.

Replacing the remote control batteries

If the remote control becomes unresponsive or inoperable after it has been used for some time, the batteries may have reached the end of their service life. When this happens, replace them with new batteries. Obtain two AA size manganese or alkaline batteries. You cannot use other batteries except for the AA size manganese or alkaline.

Attention

Make sure you read the following manual before handling the batteries.

 [Safety Instructions](#)

1 Remove the battery cover.

While pushing the battery cover catch, lift the cover up.

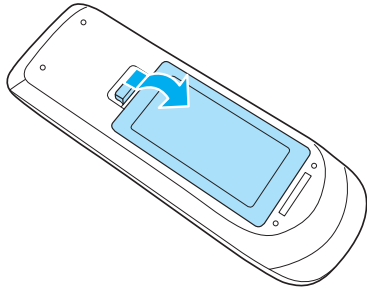

2 Replace the old batteries with new batteries.

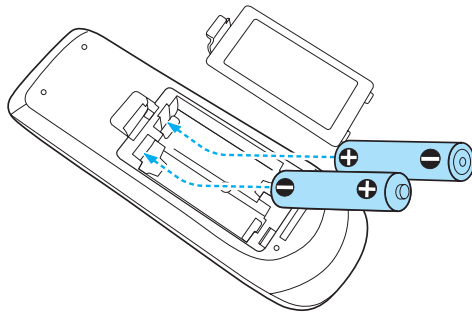

Caution

Check the positions of the (+) and (-) marks inside the battery holder to ensure the batteries are inserted the correct way.

3 Reattach the battery cover.

Press the battery cover until it clicks into place.

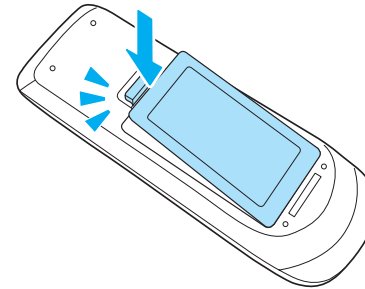

Remote control operating range

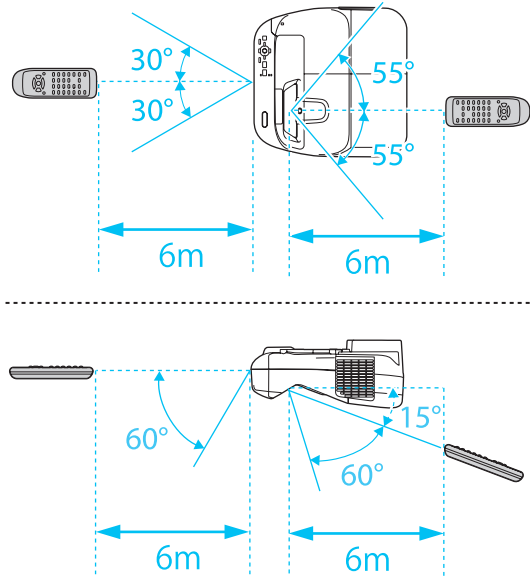



Easy Interactive Pen

There are two types of Easy Interactive Pens with different colored bottom sections. You cannot use Easy Interactive Pens with the same colored bottom sections at the same time.

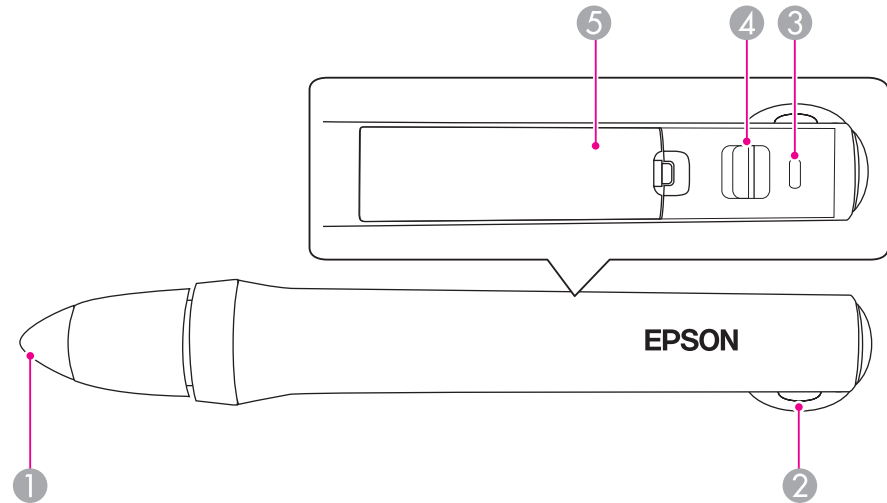
☞ "Optional Accessories" p.198



	Name	Function
①	Pen tip button	Hold the pen close to the projected screen, and press to use. ☞ "Using the Pen" p.67 ☞ "Optional Accessories" p.198
②	Strap attachment hole	Allows you to attach a commercially available strap.

Name	Function
3 Battery indicator	<p>Indicates the remaining battery power when the power is turned on.</p> <ul style="list-style-type: none"> • Turns green for several seconds when the battery is charged. • Flashes green for several seconds when the battery is low. • Does not light when the battery is exhausted. Change the battery. <p> "Replacing the battery for the Easy Interactive Pen" p.21</p>
4 Slide switch	<p>Switches the Easy Interactive Pen on and off. When turned on, it takes a few seconds before the Easy Interactive Pen is operational.</p>
5 Battery cover	<p>Open this cover when replacing the battery.</p> <p> "Replacing the battery for the Easy Interactive Pen" p.21</p>



The Easy Interactive Pen will turn off automatically if it is unused for a long time.

Turn the Easy Interactive Pen on again with the slide switch to use the pen.

Replacing the battery for the Easy Interactive Pen

The battery indicator on the Easy Interactive Pen lights or flashes when the power is turned on. Does not light or flash when the battery is exhausted. When the indicator no longer lights or flashes, replace the battery. Use one of the following types of battery. Other chargeable batteries cannot be used.

- AA size manganese battery
- AA size alkaline manganese battery
- SANYO eneloop®*(HR-3UTG/HR-3UTGA/HR-3UTGB)

Attention

Make sure you read the following manual before handling batteries.

 [Safety Instructions](#)

- 1 Remove the battery cover.

While pushing the battery cover catch, lift the cover up.

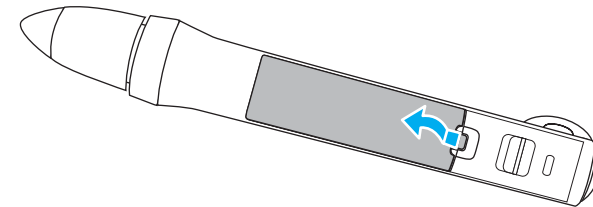

- 2 Replace the old battery with a new battery.

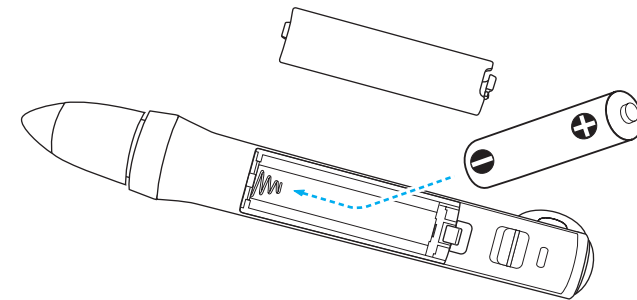

Caution

Check the positions of the (+) and (-) marks inside the battery holder to ensure the battery is inserted the correct way.

- 3 Replace the battery cover.

Press the battery cover until it clicks into place.

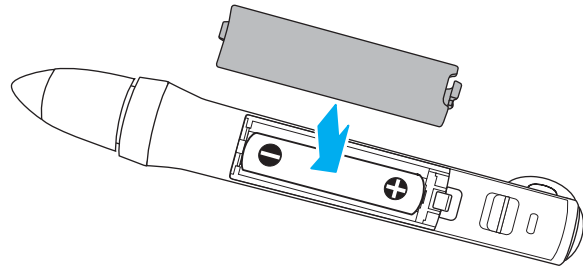

Replacing the tip of the Easy Interactive Pen

Replace the tip of the Easy Interactive Pen when it is worn.

☛ "Optional Accessories" p.198

- 1 Turn the tip of the pen to remove it.

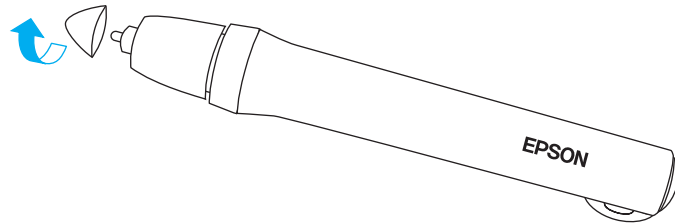

- 2 Turn the new tip to attach it.

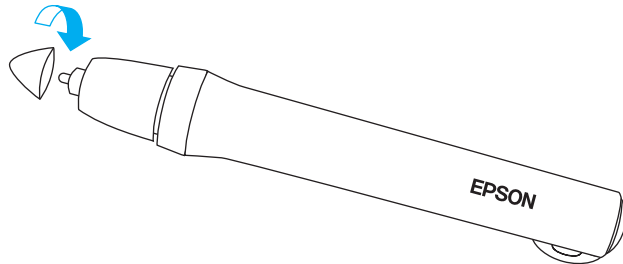

Pen Tray

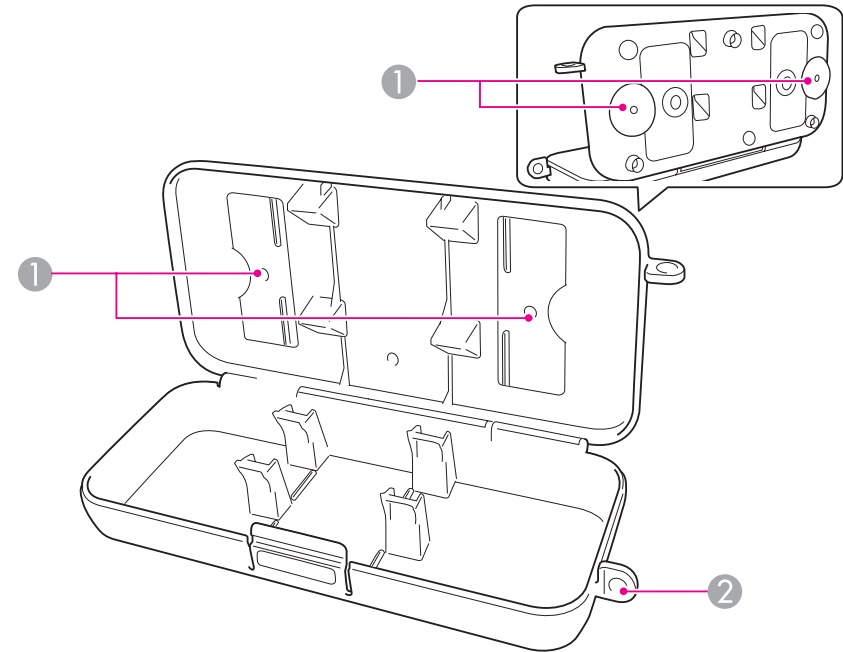

	Name	Function
①	Fixing points	Attach the pen tray to a whiteboard or wall.
②	Security hole	Pass a commercially available lock through here.



It is recommended that the pen tray be tightened with two commercially available M5 bolts.

Control Pad

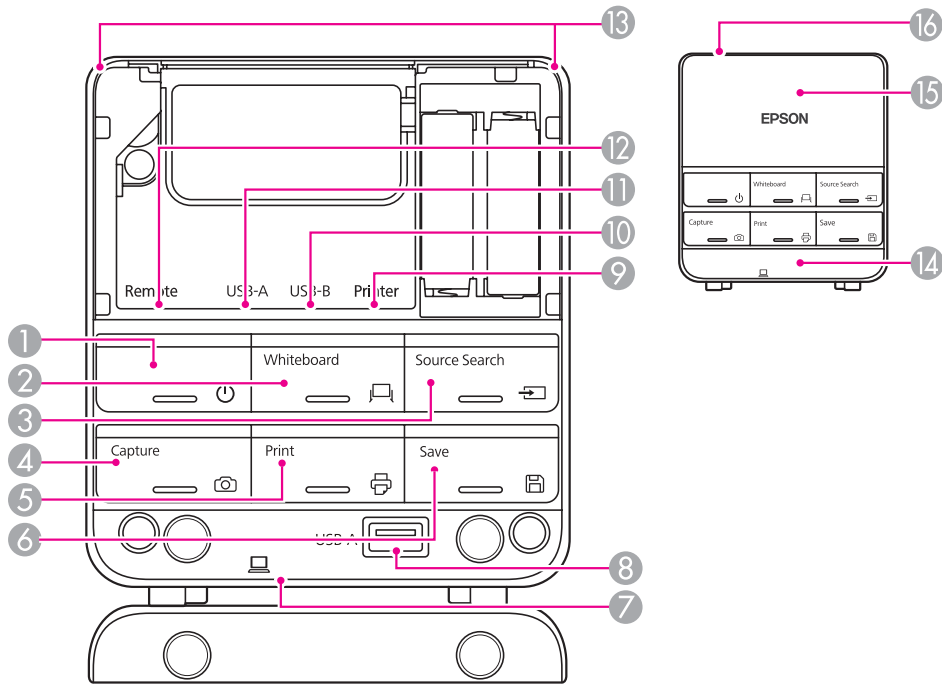

Name	Function
1 [Power] button	Turns the projector power on or off. ☛ "From Installation to Projection" p.46
2 [Whiteboard] button	<ul style="list-style-type: none"> Press this when the projector is off to turn on the projector and start the interactive function in Whiteboard Mode. Press this when the projector is on to change to Whiteboard Mode. If you press it in Whiteboard Mode, the image changes to the previous image source. ☛ "Drawing" p.69

Name	Function
3 [Source Search] button	Switches to the image from the input port where video signals are being input. ☛ "Automatically Detect Input Signals and Change the Projected Image (Source Search)" p.47
4 [Capture] button	Takes a snapshot of the projected screen. After taking the snapshot, the image is pasted onto a new page in Whiteboard Mode. (This button cannot be used in Whiteboard Mode.) ☛ "Interactive Function" p.62
5 [Print] button	Prints the projected screen. ☛ "Using Drawing Content" p.80
6 [Save] button	Saves the projected screen. ☛ "Using Drawing Content" p.80
7 USB-B port (for connecting a computer)	Connects to a computer via a USB cable to use the interactive function or USB Display. ☛ "Connecting to the Control Pad" p.41
8 USB-A port (for connecting USB storage)	Connects a USB storage device. ☛ "Connecting to the Control Pad" p.41
9 USB-A port (for connecting a printer)	Connects to a printer via a USB cable. ☛ "Connecting to the Control Pad" p.41
10 USB-B port (for connecting a projector)	Connects to the projector via a USB cable when a USB storage device or printer is connected to the Control Pad. ☛ "Connecting to the Control Pad" p.41
11 USB-A port (for connecting a projector)	Connects to a projector via a USB cable to use the interactive function or USB Display. ☛ "Connecting to the Control Pad" p.41

Name	Function
12 Remote port	Power is supplied to the Control Pad from the projector when they are connected with the optional remote control cable set. When connected, remote control signals are also sent to the projector via the cable. <div style="border: 1px solid black; padding: 5px; width: fit-content; margin: 5px auto;">  When not connected using the remote control cable set, power is supplied by the batteries. Remote control signals are sent to the projector via infrared rays. </div>
13 Remote control light-emitting area	Outputs remote control signals.
14 Bottom cover	Open to connect a USB storage device.
15 Top cover	Open to connect cables and replace the batteries.
16 Cable cover	Open this cover when cables are wired along a wall.

Replacing the batteries for the Control Pad

If the Control Pad becomes unresponsive or inoperable after it has been used for some time, the batteries may have reached the end of their service life. When this happens, replace them with new batteries. Obtain two AA size manganese or alkaline batteries. We recommend using alkaline batteries for the Control Pad. You cannot use other batteries except for the AA size manganese or alkaline.

Attention

Make sure you read the following manual before handling the batteries.

 [Safety Instructions](#)



Because power is supplied to the Control Pad when it is connected to the projector with the remote control cable set, you do not need batteries.

- 1 Remove the top cover.
Place your finger into the groove on the top cover, and then lift it up and out.

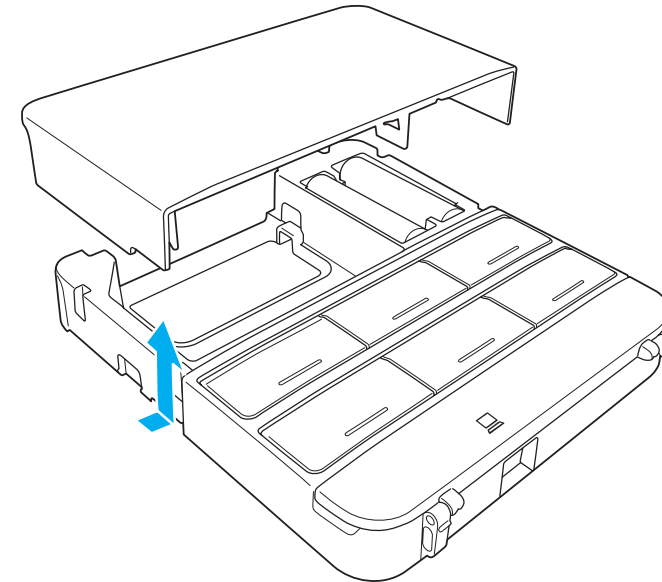

- 2 Replace the old batteries with new batteries.

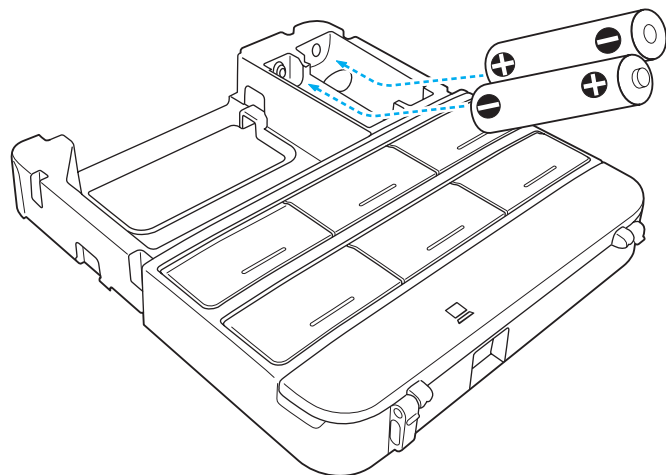

See the following for the operating range for the Control Pad.

 [Control Pad Installation Guide](#)



Caution

Check the positions of the (+) and (-) marks inside the battery holder to ensure the batteries are inserted the correct way.

3

Replace the top cover.

Press the battery cover until it clicks into place.

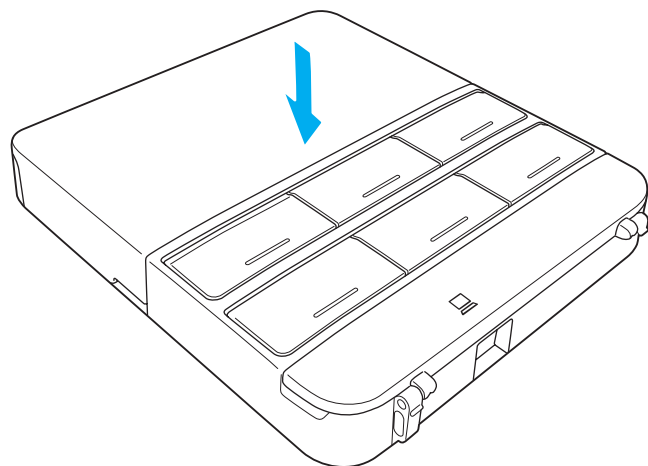



Preparing the Projector

This chapter explains how to install the projector and connect projection sources.

Installation Methods

The projector supports the following six different projection methods. Install the projector according to the installation location.

Turn the projector off when you are changing the installation method. Turn the projector back on after changing the installation method.



- When mounting the projector on a wall or ceiling, or placing the projector vertically, make sure you use the correct tools for the installation method.
 - ☛ "Optional Accessories" [p.198](#)
- The default Projection setting is **Front/Upside Down**. You can change to other Projection settings from the Configuration menu.
 - ☛ **Extended - Projection** [p.144](#)
- You can change the Projection setting as follows by pressing down the [A/V Mute] button on the remote control for about five seconds.
Front↔Front/Upside Down
Rear↔Rear/Upside Down
- When using the interactive function, install so that the projected screen is a rectangle without any distortion.
- You cannot use the interactive function while the Projection setting is **Rear/Upside Down** or **Rear**.
 - ☛ "Interactive Function" [p.62](#)
- When installing multiple projectors in the same room, set **Distance of Projectors** according to the distance between the projectors.
 - ☛ **Extended - Easy Interactive Function - Distance of Projectors** [p.144](#)

- Mount the projector on a wall or ceiling and project images from in front of a screen. (Front/Upside Down projection)

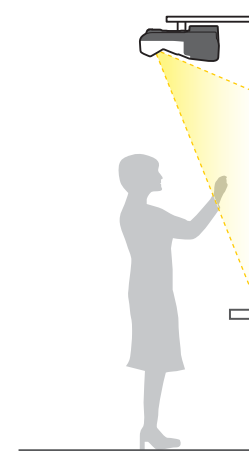

- Mount the projector on a wall or ceiling and project images from behind a translucent screen. (Rear/Upside Down projection)

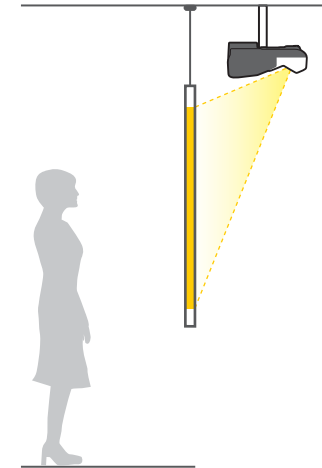

- Project images from in front of the screen. (Front projection)

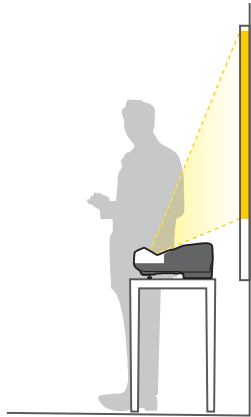

- Project images from behind a translucent screen. (Rear projection)

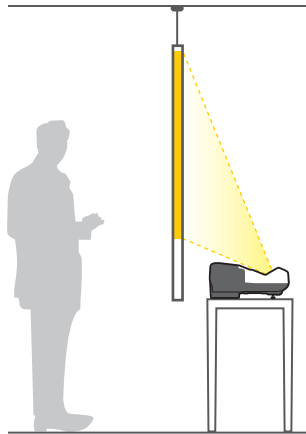

Attach the feet when using the projector on a surface such as a desk.

☛ "Attaching the feet (Only models with feet supplied)" [p.14](#)

- Place the projector vertically and project images from in front of the screen. (Front/Upside Down projection)

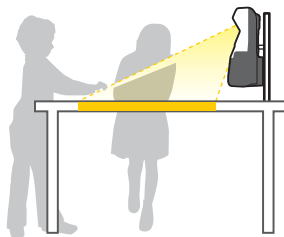

- Place the projector vertically and project images from behind the screen (Rear/Upside Down projection)

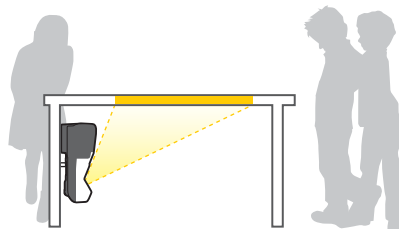

Warning

- A special method of installation is required when suspending the projector from a wall or ceiling. If it is not installed correctly, it could fall causing an accident and injury.
- If you use adhesives on the wall mount plate fixing points or the ceiling mount fixing points to prevent the screws from loosening, or if you use things such as lubricants or oils on the projector, the projector case may crack causing it to fall from its mount. This could cause serious injury to anyone under the mount and could damage the projector. When installing or adjusting the mount, do not use adhesives to prevent the screws from loosening and do not use lubricant or oil and so on.
- Do not cover the projector's air intake vent or air exhaust vent. If either of the vents are covered, the internal temperature could rise and cause a fire.

This chapter explains how to connect the projector to peripheral devices.

You can connect devices directly to the projector, or connect to the projector via the Control Pad.

When connecting USB cables or USB storage devices, we recommend using the Control Pad.

☛ "Connecting to the Control Pad" [p.41](#)

When connecting devices except for USB cables or USB storage devices, connect directly to the projector.

☛ "Connecting to the Projector" [p.31](#)

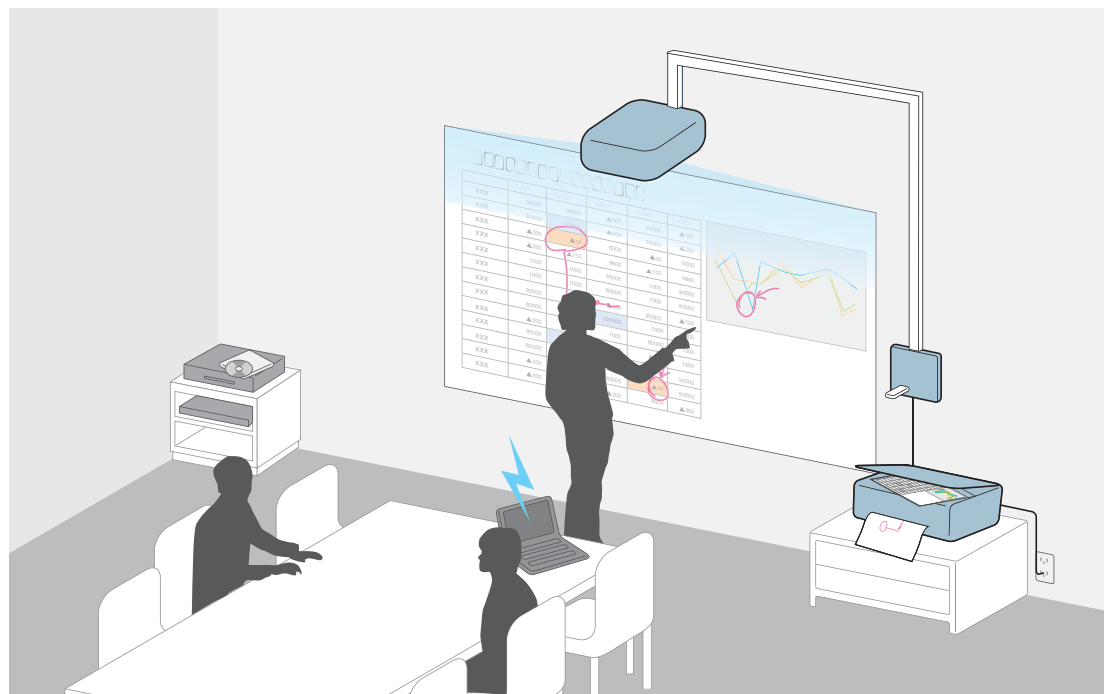

Attention

If you use a USB hub, operation may not be performed correctly. Connect directly to the projector or the Control Pad.



- You can connect to the network by wired or wireless communication.
To connect to the network using a cable, connect a LAN cable to the projector.
 - ☛ "Connecting a LAN cable" [p.39](#)
 - ☛ "Installing the wireless LAN unit" [p.40](#)
- The port name, location, and connector orientation differ depending on the source being connected.

Connecting to the Projector

This section explains how to connect peripheral devices directly to the projector.

Connecting a computer

To project images from a computer, connect the computer using one of the following methods.

① **When using a commercially available computer cable**

Connect the computer's display output port to the projector's Computer port.

You can output audio from the projector's speaker by connecting the audio output port on the computer to the projector's Audio1 port using a commercially available audio cable.

② **When using the supplied USB cable**

Connect the computer's USB port to the projector's USB-B port.

You can send the computer's audio with the projected image.

③ **When using a commercially available HDMI cable**

Connect the computer's HDMI port to the projector's HDMI port.

You can send the computer's audio with the projected image.

④ **When using a commercially available DisplayPort cable**

Connect the computer's DisplayPort to the projector's DisplayPort.

You can send the computer's audio with the projected image.

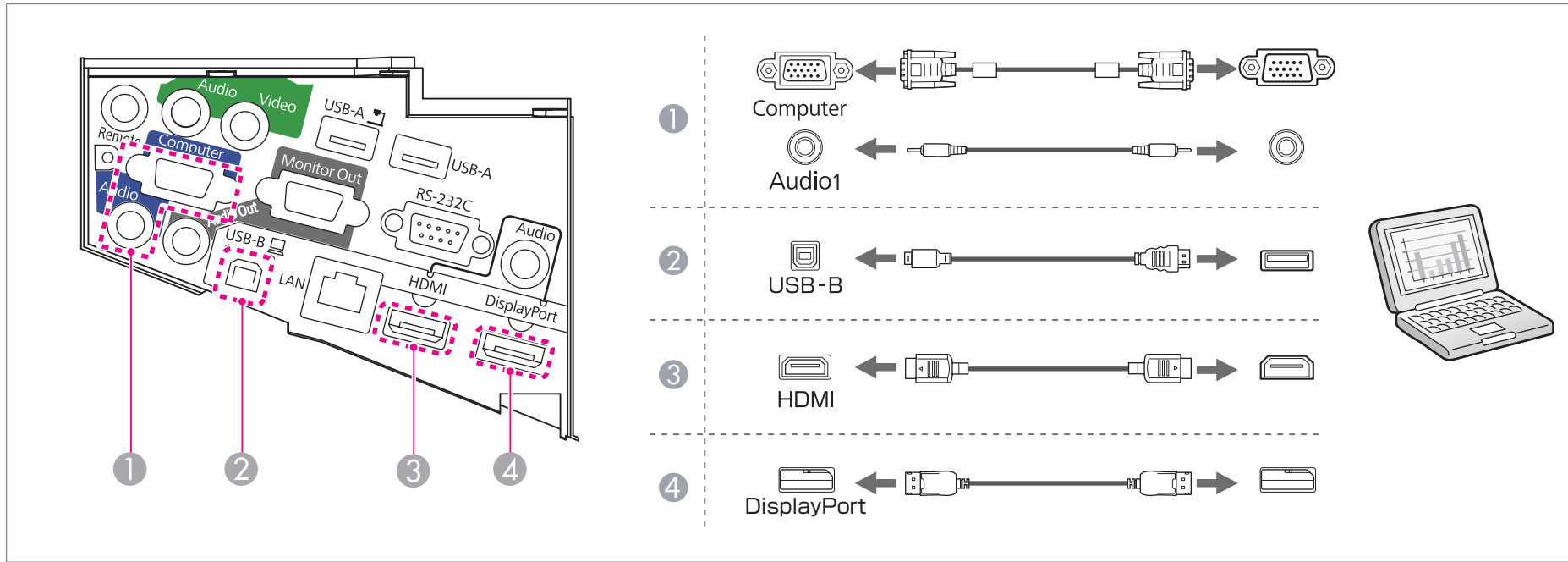

- When connecting to the Audio1, Audio Out, and Computer port, we recommend connecting cables to the ports in the following order: Audio1, Audio Out and then Computer port.
- You can switch the audio input source by using **Audio Input**.
 🖱️ **Extended - Audio Input Setup - Audio Input** [p.144](#)
- You can use a USB cable to connect the projector to a computer to project images from the computer. This function is called USB Display.
 🖱️ "Projecting with USB Display" [p.48](#)
- Some commercially available DisplayPort cables come with a lock. When removing the cable, press the button on the cable's connector section and pull out the cable.

Connecting image sources

To project images from DVD players or VHS video and so on, connect to the projector using one of the following methods.

1 When using a commercially available video cable

Connect the video output port on the image source to the projector's Video port using a commercially available video cable.

You can output audio from the projector's speaker by connecting the audio output port on the image source to the projector's Audio2 port using a commercially available audio cable.

2 When using the optional component video cable

☛ "Optional Accessories and Consumables" [p.198](#)

Connect the component output port on the image source to the projector's Computer input port.

You can output audio from the projector's speaker by connecting the audio output port on the image source to the projector's Audio1 port using a commercially available audio cable.

3 When using a commercially available HDMI cable

Connect the HDMI port on the image source to the projector's HDMI port using a commercially available HDMI cable.

You can send the image source's audio with the projected image.

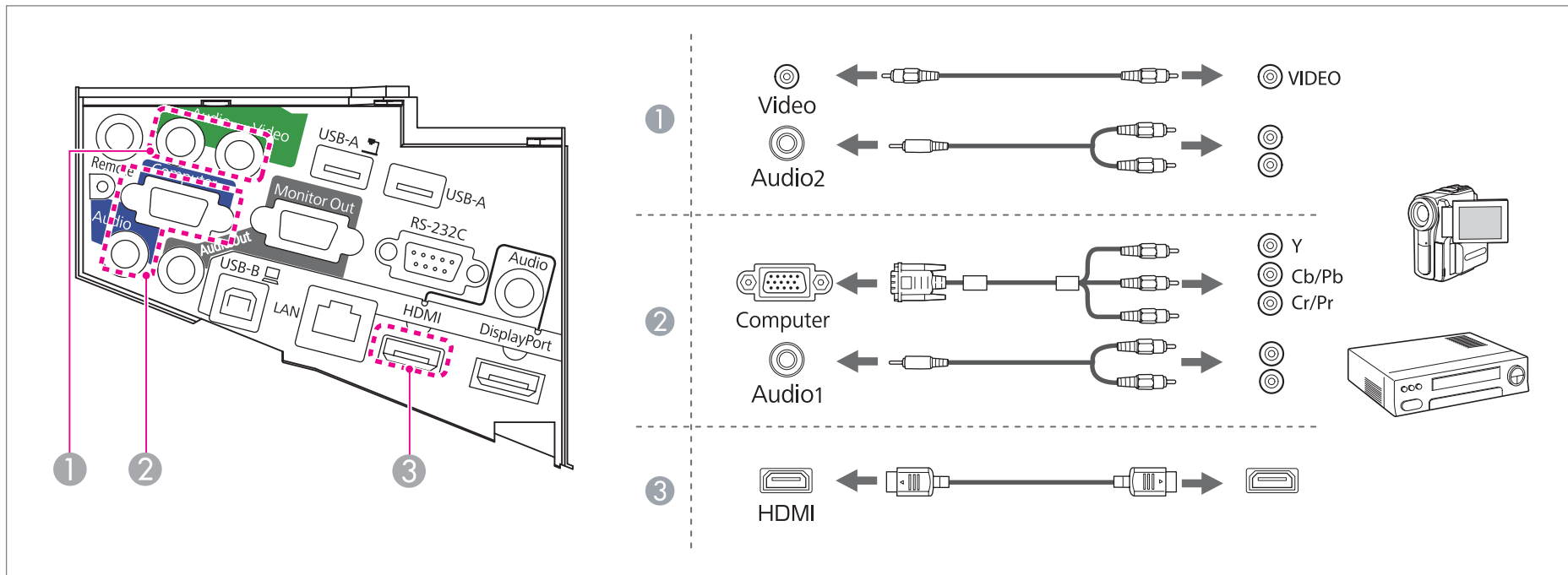

Attention

- If the input source is on when you connect it to the projector, it could cause a malfunction.
- If the orientation or shape of the plug differs, do not try to force it in. The device could be damaged or could malfunction.



- You can switch the audio input source by using **Audio Input**.

☛ **Extended - Audio Input Setup - Audio Input** [p.144](#)

- If the source you want to connect to has an unusually shaped port, use the cable supplied with the device or an optional cable to connect to the projector.
- When using a commercially available 2RCA(L/R)/stereo mini-pin audio cable, make sure it is labeled "No resistance".

Connecting USB devices

You can connect devices such as USB memory, the optional Document Camera, and USB compatible hard disks and digital cameras.

① When using the optional document camera

Connect the Document Camera to the  port on the projector using a USB cable.

② When using a USB device such as a USB memory or digital camera

Connect the USB device to the projector's USB-A port using a USB cable.

③ When using PC interactive for the interactive function

 "Interactive Function" [p.62](#)

Connect the computer's display output port to the projector's Computer port using a computer cable.

Connect the computer's USB port to the projector's USB-B port using a USB cable.

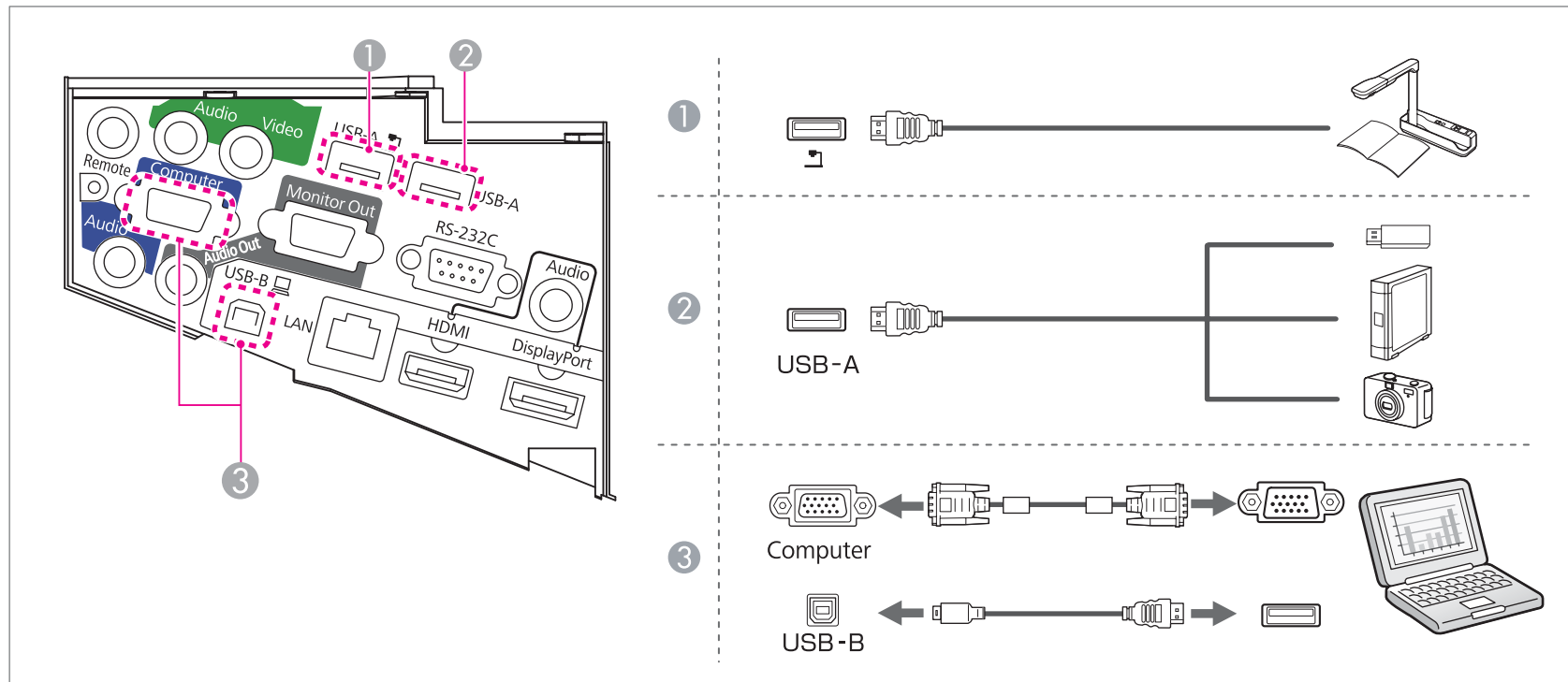

When the USB device is connected, you can project image files on the USB memory or digital camera using PC Free.

☛ "Projecting Images Stored on a USB Storage Device (PC Free)" [p.95](#)

If the Document Camera is connected while projecting images from another input port, press the [Source Search] button on the remote control, control panel, or the Control Pad, to switch to images from the Document Camera.

☛ "Automatically Detect Input Signals and Change the Projected Image (Source Search)" [p.47](#)



While projecting images from a Document Camera, if you want to connect an audio output device, connect it to the Audio1 port.

Attention

- When connecting and using a USB-compatible hard disk, make sure you connect the AC adaptor supplied with the hard disk.
- Connect a digital camera or hard disk to the projector using a USB cable supplied with or specified for use with the device.

Removing USB devices

After finishing projecting, remove USB devices from the projector. For devices such as digital cameras or hard disks, turn off the device and then remove it from the projector.

Connecting external equipment

You can output images and audio by connecting an external monitor or speaker.

1 When outputting images to an external monitor

Connect the external monitor to the projector's Monitor Out port using the cable supplied with the external monitor.

2 When outputting audio to an external speaker

Connect the external speaker to the projector's Audio Out port using a commercially available audio cable.

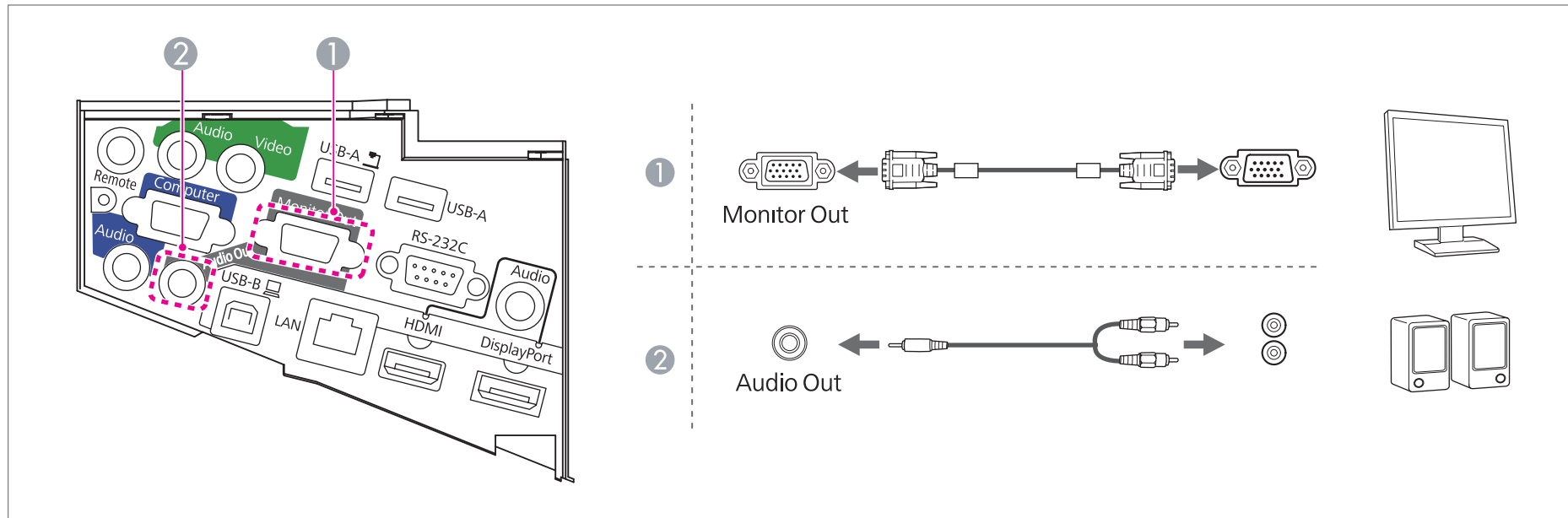



- If you set **Standby Mode** to **A/V Standby**, you can output images to an external monitor even if the projector is in standby mode. You can also output audio to an external speaker. Audio input from DisplayPort, HDMI, USB Display, USB1, USB2, or LAN cannot be output.
 - ☛ **Extended - Standby Mode** [p.144](#)
- Only analog RGB signals from the Computer port can be output to an external monitor. You cannot output signals input from other ports or component video signals.
- Setting gauges for functions such as Keystone, Configuration menu, or Help screens are not output to the external monitor.
- When the audio cable jack is inserted into the Audio Out port, audio stops being output from the projector's built-in speakers and switches to external output.

Connecting a LAN cable

Connect a LAN port on network hubs or other equipment to the projector's LAN port with a commercially available 100BASE-TX or 10BASE-T LAN cable.

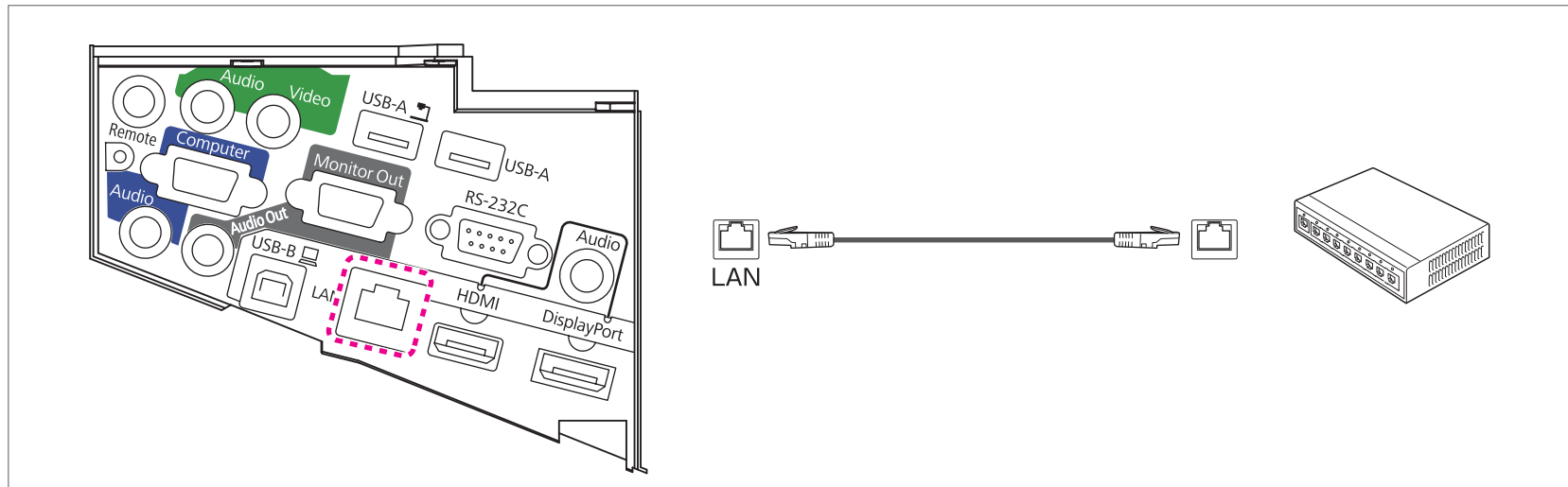

To prevent malfunctions, use a category 5 shielded LAN cable.

Installing the wireless LAN unit

- 1** Remove both of the cable cover fixing screws to open the cable cover.

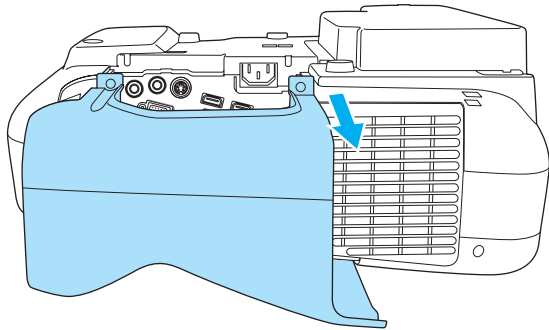
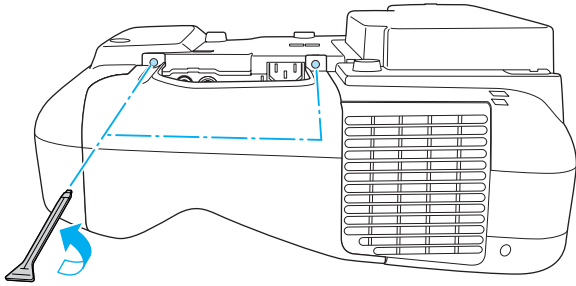

- 2** Install the Wireless LAN unit.

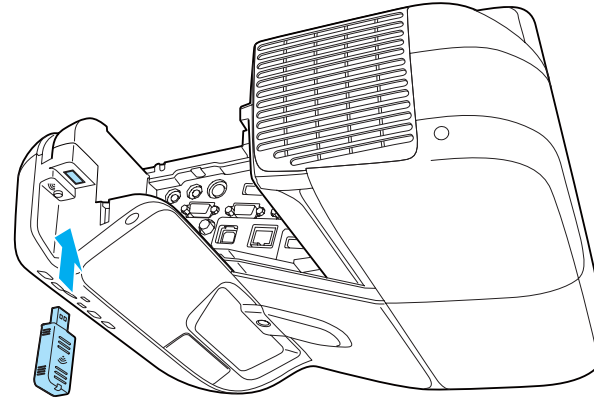

Connecting to the Control Pad

This section explains how to connect peripheral devices to the projector using the Control Pad.

Connecting when using the PC Interactive function

- 🖱️ "Operating a Computer from the Projected Screen (PC Interactive)" [p.84](#)
- ① Connect the projector's USB-B port to the Control Pad's USB-A port using a USB cable.
- ② Connect the Control Pad's USB-B port to the computer's USB-A port using a USB cable.

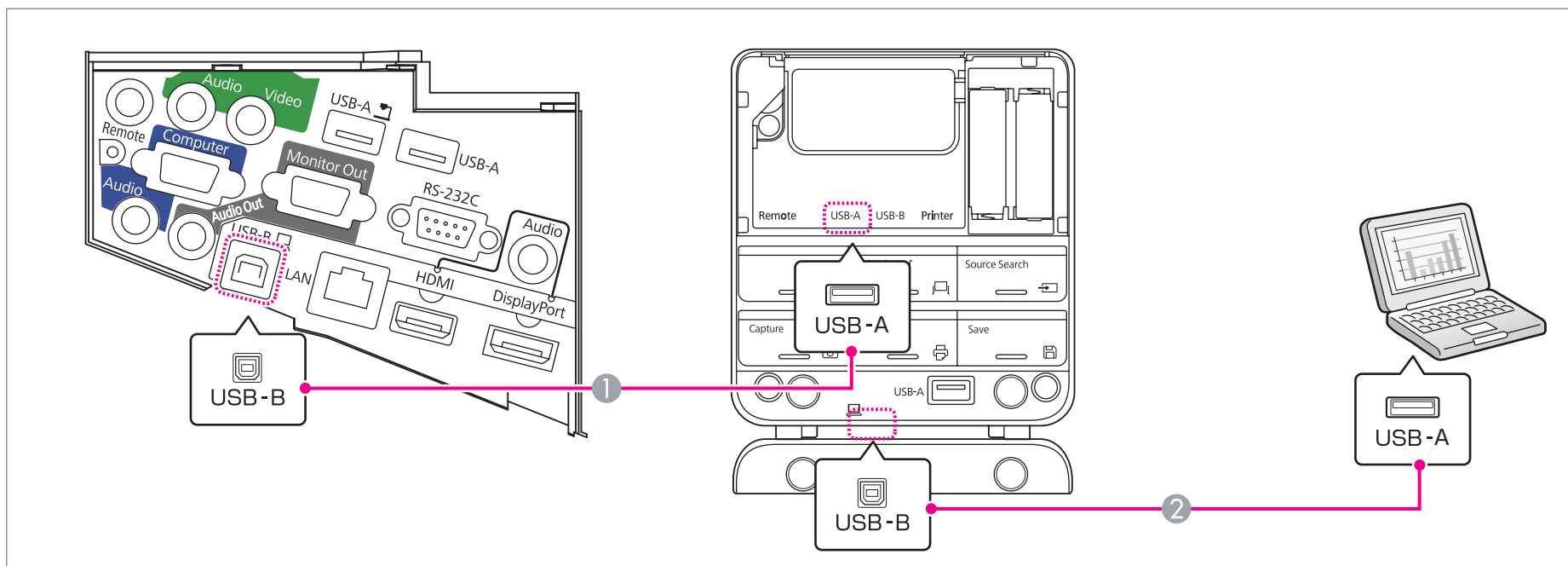

To project the computer's screen, you need to connect the computer to the projector using a computer cable.

🖱️ "Connecting a computer" [p.31](#)

Connecting using USB Display

☛ "Projecting with USB Display" p.48

- 1 Connect the projector's USB-B port to the Control Pad's USB-A port using a USB cable.
- 2 Connect the Control Pad's USB-B port to the computer's USB-A port using a USB cable.

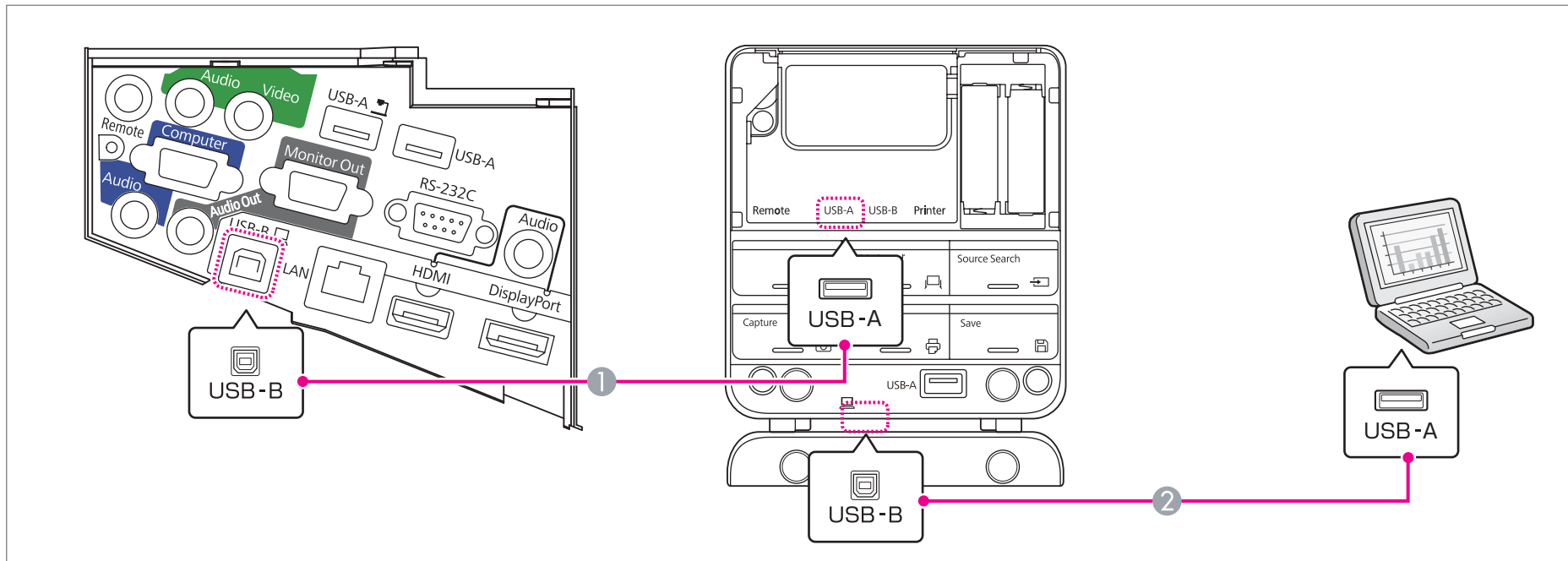

Connecting using PC Free

🖱️ "Projecting Images Stored on a USB Storage Device (PC Free)" [p.95](#)

- 1 Connect the projector's USB-A port to the Control Pad's USB-B port using a USB cable.
- 2 Connect the USB storage device to the Control Pad's USB-A port (for USB storage).

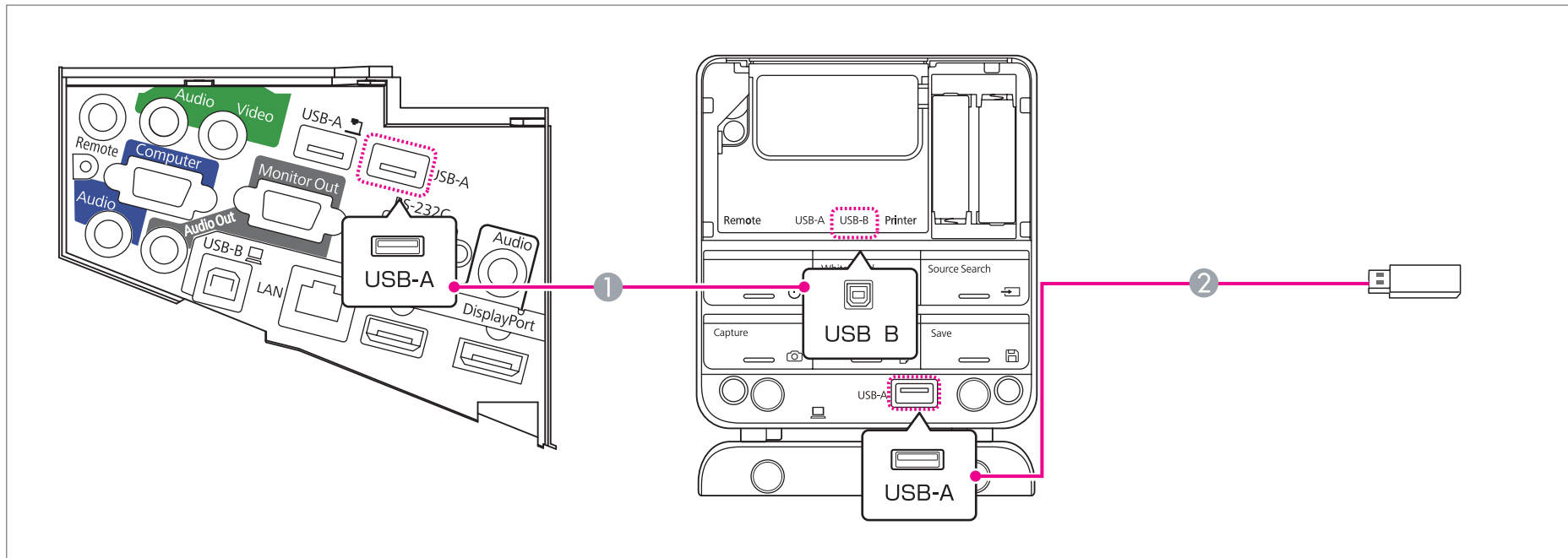

Connecting a printer

☞ "Using Drawing Content" p.80

- 1 Connect the projector's USB-A port to the Control Pad's USB-B port using a USB cable.
- 2 Connect the printer to the Control Pad's USB-A port (for printers) using a USB cable.

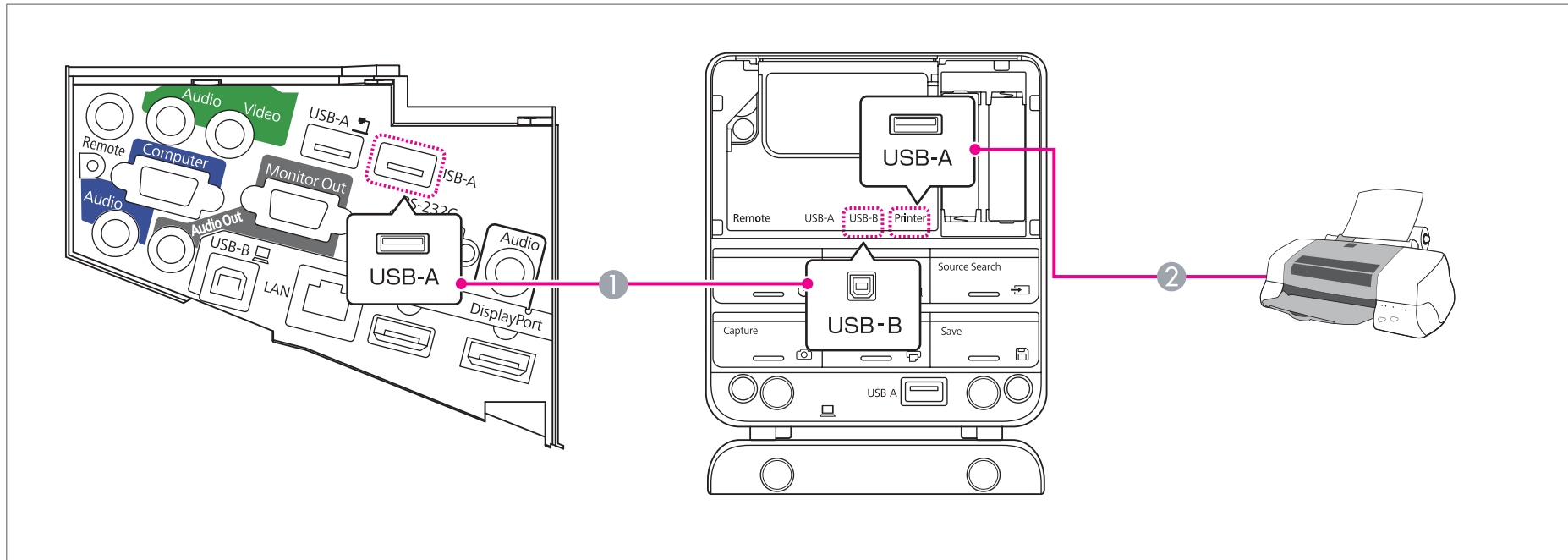

- You cannot connect a document camera to the Control Pad.
- Stick the supplied port protection stickers on the Control Pad's ports that are not being used.



Basic Projection Methods

This chapter explains how to project and adjust images.

From Installation to Projection

This section explains the procedure for connecting the projector to a computer via a computer cable and projecting images.

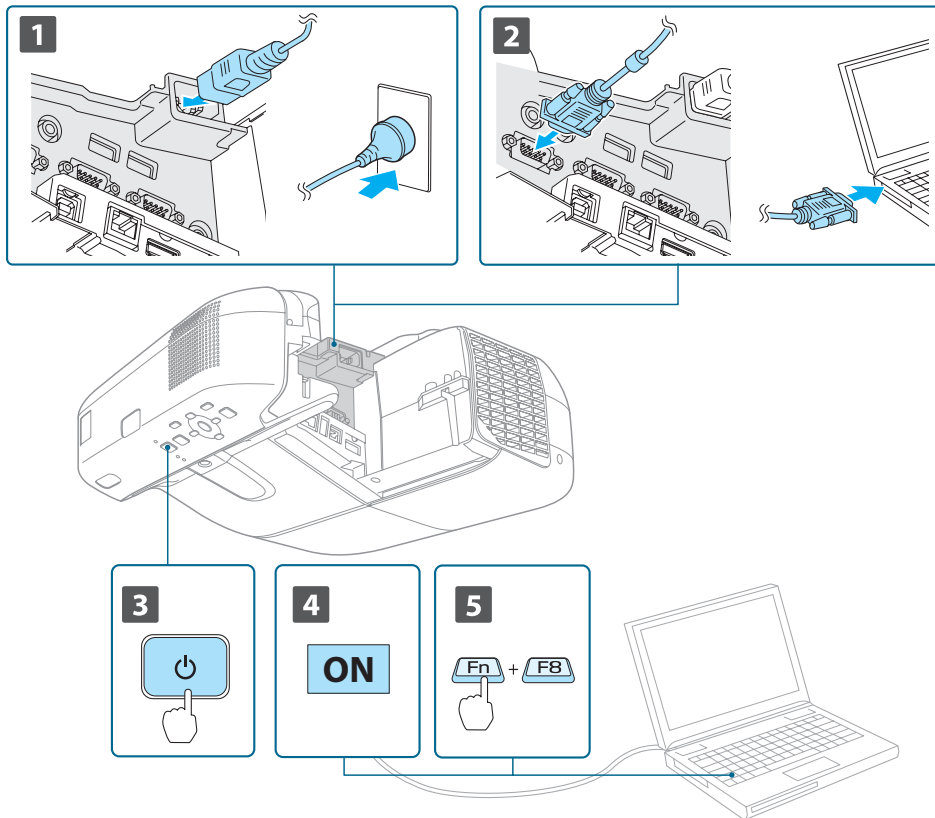

- 1** Connect the projector to an electrical outlet with the power cord.
- 2** Connect the projector to the computer with the computer cable.
- 3** Turn on the projector.

- 4** Turn on the computer.

- 5** Change the computer's screen output.

When using a laptop computer, you need to change the screen output from the computer.

Hold down the Fn key (function key), and press the /□ key.



- The method for changing differs depending on the computer being used. See the documentation supplied with the computer.
- Press the [⏻] button twice to turn the projector off.

If no image is projected, press the [Source Search] button on the remote control, control panel, or the Control Pad. When there is no image signal input, Whiteboard Mode is displayed.

☛ "Automatically Detect Input Signals and Change the Projected Image (Source Search)" [p.47](#)



After projecting the image, adjust the image if necessary.

- ☛ "Correcting Keystone Distortion" [p.51](#)
- ☛ "Correcting the Focus" [p.56](#)

Automatically Detect Input Signals and Change the Projected Image (Source Search)

Press the [Source Search] button to project images from the port currently receiving an image.

Using Remote Control

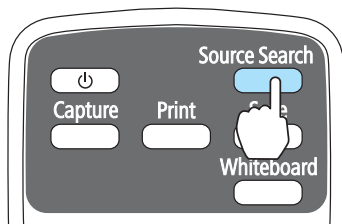

Using the Control Panel

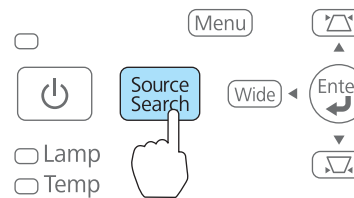

Using the Control Pad

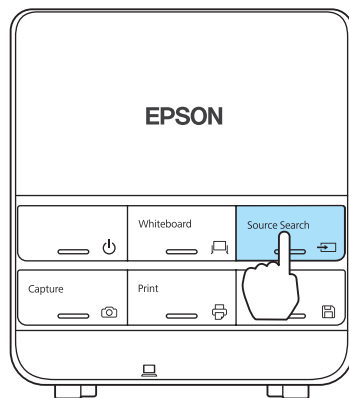

The input source changes in the following order.

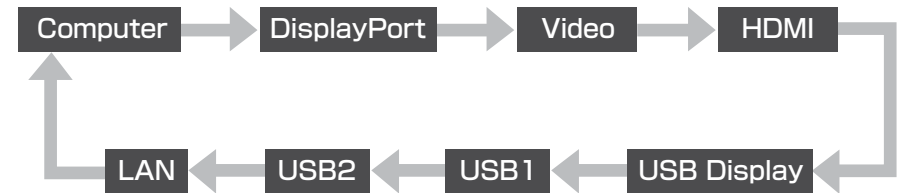

When two or more image sources are connected, press the [Source Search] button until the target image is projected.

When your video equipment is connected, start playback before beginning this operation.



If no image signal is being input, the following screen is displayed when you press [Source Search] on the remote control or control panel.

Change to Whiteboard when no image signal is being input.

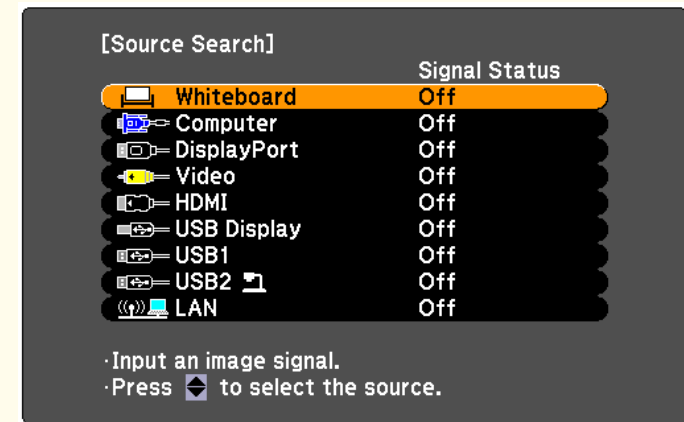

: Select : Enter [Esc] : Exit

Projecting with USB Display

You can use the supplied USB cable to connect the projector to a computer to project images from the computer.

You can send the computer's audio with the projected image.

Necessary settings

Set **USB Type B** to **USB Display/Easy Interactive Function** or **Wireless Mouse/USB Display** to use USB Display.

☛ **Extended - USB Type B** [p.144](#)

System requirements

For Windows

OS	Windows 2000*1	
	Windows XP*2	Professional 32 bit Home Edition 32 bit Tablet PC Edition 32 bit
	Windows Vista	Ultimate 32 bit Enterprise 32 bit Business 32 bit Home Premium 32 bit Home Basic 32 bit
	Windows 7	Ultimate 32/64 bit Enterprise 32/64 bit Professional 32/64 bit Home Premium 32/64 bit Home Basic 32 bit Starter 32 bit

CPU	Mobile Pentium III 1.2 GHz or faster Recommended: Pentium M 1.6 GHz or faster
Amount of Memory	256 MB or more Recommended: 512 MB or more
Hard Disk Space	20 MB or more
Display	Resolution of no less than 640x480 and no higher than 1600x1200. Display color of 16-bit color or greater

*1 Service Pack 4 only

*2 Service Pack 1 is not supported

For Mac OS X

OS	Mac OS X 10.5.x 32 bit Mac OS X 10.6.x 32/64 bit Mac OS X 10.7.x 32/64 bit
CPU	Power PC G4 1GHz or faster Recommended: Core Duo 1.83GHz or faster
Amount of Memory	512 MB or more
Hard Disk Space	20 MB or more
Display	Resolution of no less than 640x480 and no higher than 1680x1200. Display color of 16-bit color or greater

Connecting for the first time

The first time you connect the projector and the computer using the USB cable, the driver needs to be installed. The procedure is different for Windows and Mac OS X.



- You do not need to install the driver the next time you connect.
- When inputting images from multiple sources, change the input source to USB Display.
- If you are using a USB hub, operations may not be performed correctly. Connect directly to the projector or the Control Pad.
- You cannot change option settings while using USB Display.

For Windows

- 1 Connect the computer's USB port to the projector's USB-B port using the supplied USB cable.



For Windows 2000 or Windows XP, a message asking you if you want to restart your computer may be displayed. Select **No**.

For Windows 2000

Double-click **Computer**, **EPSON PJ_UD**, and then **EMP_UDSE.EXE**.

For Windows XP

Driver installation starts automatically.

For Windows Vista/Windows 7

When the dialog box is displayed, click **Run EMP_UDSE.exe**.

- 2 When the License Agreement screen is displayed, click **Agree**.

- 3 Computer images are projected.

It may take a while for computer images to be projected. Until the computer images are projected, leave the equipment as is and do not disconnect the USB cable or turn off the power of the projector.

- 4 Disconnect the USB cable when you are finished.

When disconnecting the USB cable, there is no need to use **Safely Remove Hardware**.



- If it is not installed automatically, double-click **My Computer - EPSON_PJ_UD - EMP_UDSE.EXE** on your computer.
- If nothing is projected for some reason, click **All Programs - EPSON Projector - Epson USB Display - Epson USB Display Vx.xx** on your computer.
- When using a computer running Windows 2000 under user authority, a Windows error message is displayed and you may not be able to use the software. In this case, try updating Windows to the latest version, restart, and then try to connect again.

For more details, contact your local dealer or the nearest address provided in the following document.

 [Epson Projector Contact List](#)

For Mac OS X

- 1 Connect the computer's USB port to the projector's USB-B port using the supplied USB cable.

The Setup folder of USB Display is displayed in the Finder.

- 2 Double-click the **USB Display Installer** icon.

- 3 Follow the on-screen instructions to install.

- 4** When the License Agreement screen is displayed, click **Agree**. Enter the administrator authority password and start the installation. When the installation is complete, the USB Display icon is displayed in the Dock and menu bar.
- 5** Computer images are projected. It may take a while for computer images to be projected. Until the computer images are projected, leave the equipment as is and do not disconnect the USB cable or turn off the power of the projector.
- 6** When you have finished, select **Disconnect** from the menu bar or from the **USB Display** icon on the Dock. You can then disconnect the USB cable.



- If the USB Display setup folder is not displayed automatically in the Finder, double-click **EPSON PJ_UD - USB Display Installer** on your computer.
- If nothing is projected for some reason, click the **USB Display** icon in the Dock.
- If there is no **USB Display** icon in the Dock, double-click **USB Display** from the Applications folder.
- If you select **Exit** from the **USB Display** icon menu on the Dock, USB Display does not start automatically when you connect the USB cable.

Uninstalling

For Windows 2000

- 1** Click **Start**, select **Settings**, and then click **Control Panel**.
- 2** Double-click **Add/Remove Programs**.
- 3** Click **Change or Remove Programs**.
- 4** Select **Epson USB Display** and click **Change/Remove**.

For Windows XP

- 1** Click **Start**, and then click **Control Panel**.
- 2** Double-click **Add or Remove Programs**.
- 3** Select **Epson USB Display** and click **Remove**.

For Windows Vista/Windows 7

- 1** Click **Start**, and then click **Control Panel**.
- 2** Click **Uninstall a program** under **Programs**.
- 3** Select **Epson USB Display** and click **Uninstall**.

For Mac OS X

- 1** Open the **Applications** folder, double-click **USB Display**, and then double-click **Tool**.
- 2** Run **USB Display Uninstaller**.

Correcting Keystone Distortion

You can correct keystone distortion using one of the following methods.

- **H/V-Keystone**
Manually correct distortion in the horizontal and vertical directions independently.

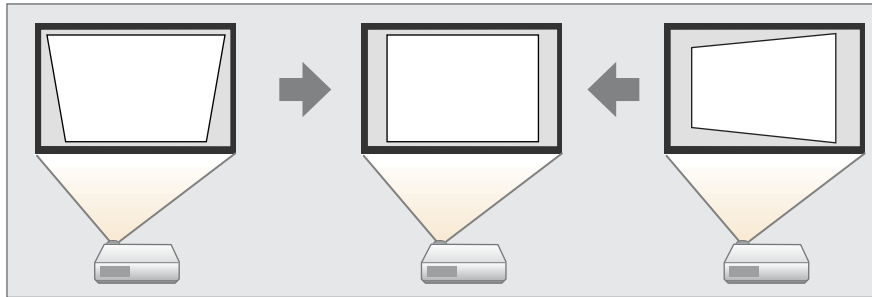

- **Quick Corner**
Manually correct the four corners independently.

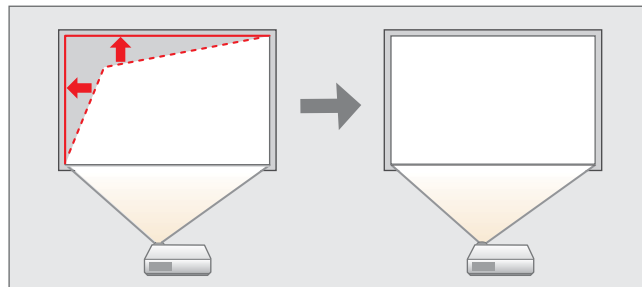

When you correct keystone distortion, the projected image may be reduced.

H/V-Keystone

Manually correct distortion in the horizontal and vertical directions independently. H/V-Keystone correction is ideal for fine-tuning keystone distortion.

You can use H/V-Keystone to correct the projected image under the following conditions.

Correction angle: Approx. 3° right and left/Approx. 3° up and down

Fine tune H/V-keystone correction: Up to ± 6

- 1** Press the [↖] or [↗] buttons on the control panel during projection to display the Keystone screen.

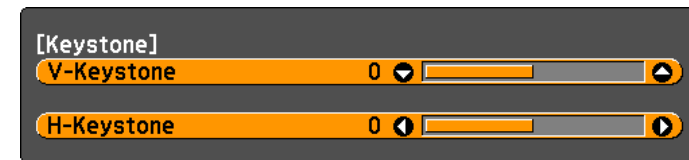

[↖] :V-Keystone [↗] :H-Keystone

- 2** Press the following buttons to correct keystone distortion.
Press the [↖] or [↗] buttons to correct vertical distortion.

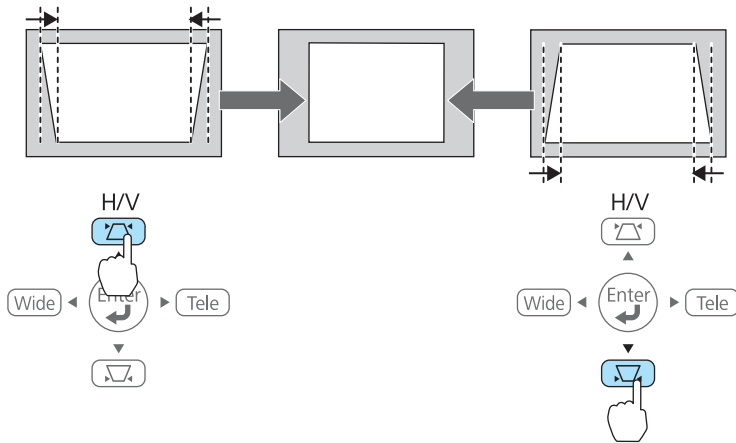

Press the [Tele] or [Wide] buttons to correct horizontal distortion.

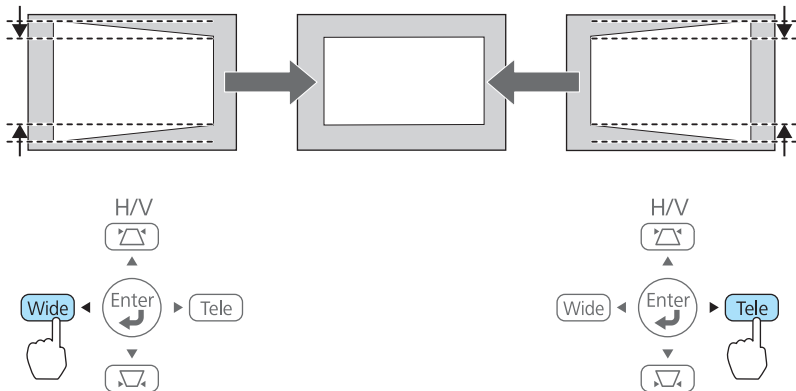

You can set H/V-Keystone from the Configuration menu.

Settings - Keystone - H/V-Keystone [p.142](#)

- 1 Press the [Menu] button while projecting.
 ➔ "Using the Configuration Menu" [p.136](#)

Using Remote Control

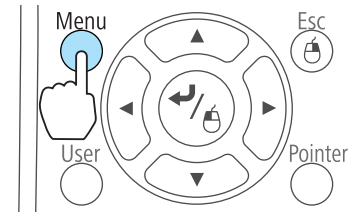

Using the Control Panel

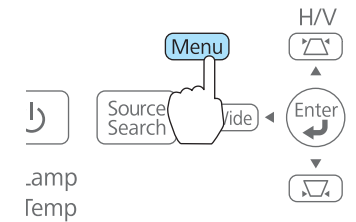

- 2 Select **Keystone** from **Settings**.

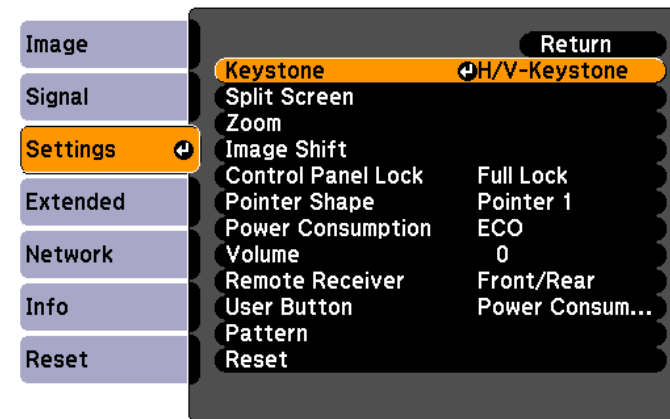

[Esc]:Return [◀]:Select [↵]:Enter [Menu]:Exit

- 3 Select **Quick Corner**, and then press the [↵] button.

Quick Corner

This allows you to manually correct each of the four corners of the projected image separately.

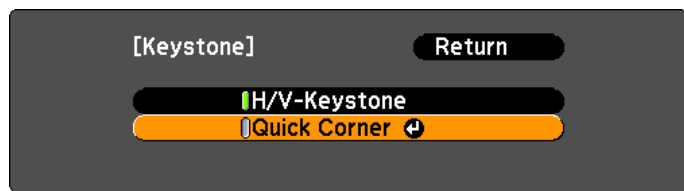

[Esc]:Return [◀]:Select [↵]:Enter [Menu]:Exit

- 4** Select the corner to correct using the [▲], [▼], [◀], and [▶] buttons on the remote control, or the [△], [▽], [Wide], and [Tele] buttons on the control panel, and then press the [↵] button.

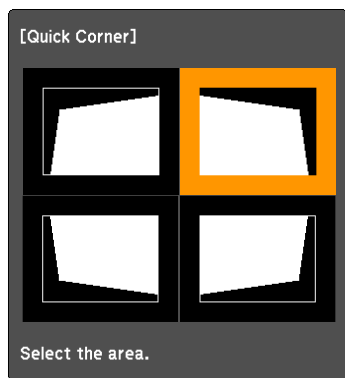

[◀/▶]:Select
[↵]:Enter
[Esc]:Return (press for 2 seconds to reset/switch)

- 5** Correct the position of the corner using the [▲], [▼], [◀], and [▶] buttons on the remote control, or the [△], [▽], [Wide], and [Tele] buttons on the control panel.

When you press the [↵] button, the screen shown in step 4 is displayed.

If the message "Cannot adjust any further." is displayed while adjusting, you cannot adjust the shape any further in the direction indicated by the gray triangle.

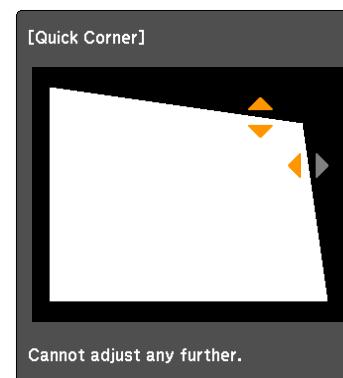

[◀/▶]:Select
[↵]:Enter
[Esc]:Return (press for 2 seconds to reset/switch)

- 6** Repeat procedures 4 and 5 as needed to adjust any remaining corners.

- 7** When you are done, press the [Esc] button to exit the correction menu.

Because **Keystone** was changed to **Quick Corner**, the corner selection screen shown in step 4 is displayed the next time you press the [△] or [▽] buttons on the control panel. Change **Keystone** to

H/V-Keystone if you want to perform horizontal and vertical correction using the [↔] and [↕] buttons on the control panel.

☛ **Settings - Keystone - H/V-Keystone** p.142



If the [Esc] button is held down for about two seconds while the corner selection screen from step 4 is displayed, the following screen is displayed.

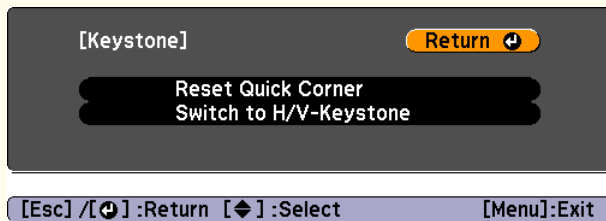

Reset Quick Corner: Resets the result of Quick Corner corrections.

Switch to H/V-Keystone: Switches the correction method to H/V-Keystone.

☛ "Settings Menu" p.142



You can also make adjustments from the configuration menu.

☛ **Settings - Zoom** p.142

Adjusting the Position of the Image (Image Shift)

You can fine tune the position of the image without moving the projector.

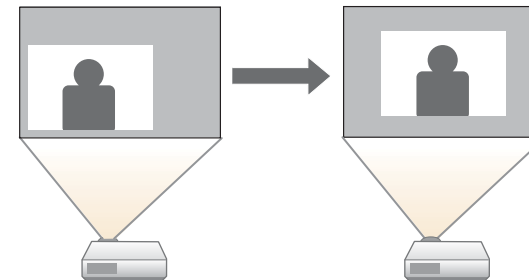

1 Perform Adjust Zoom or Keystone.

☛ "Adjusting the Image Size" p.54

☛ "Correcting Keystone Distortion" p.51

The Image Shift screen is displayed after you have made adjustments.

2 Adjust the position of the projected image.

Adjusting the Image Size

Press the [Wide] and [Tele] buttons on the control panel to adjust the size of the projected image.

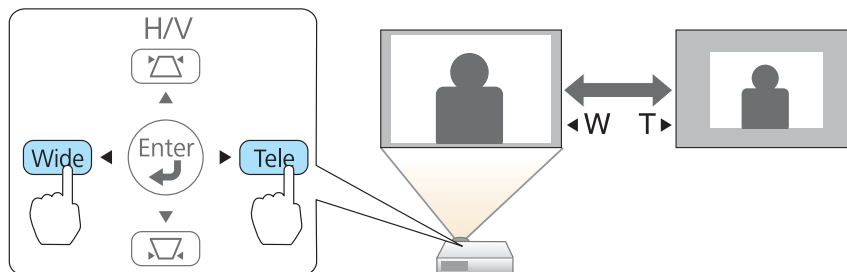

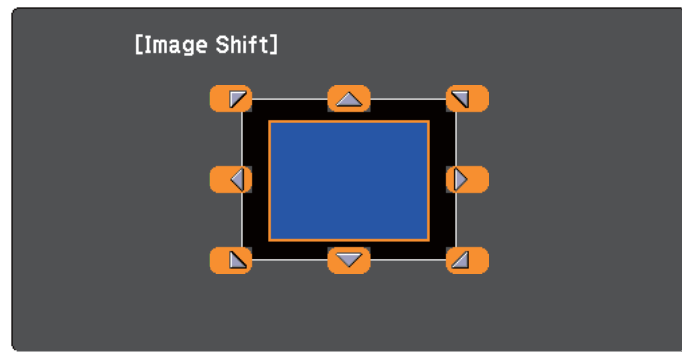

[◀▶] :Move

[Esc] :Exit

Using Remote Control

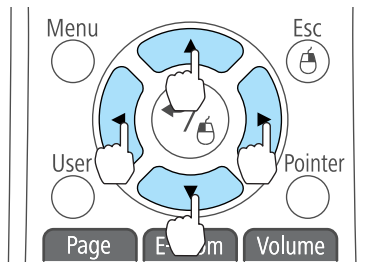

Using the Control Panel

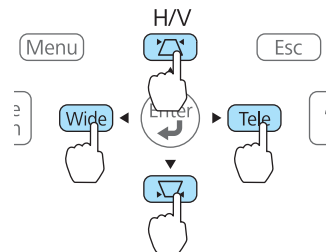

You can shift the image diagonally by pressing any pair of adjacent [▲], [▼], [◀], and [▶] buttons, or a combination of [△], [▽], [Wide], and [Tele] buttons.

- 3 Press the [Esc] button to close the adjustment screen. The adjustment screen disappears if no operation is performed after approximately 10 seconds.



- You cannot adjust the image position when Zoom is set to the maximum **Wide** position.
- The Image Shift setting is retained even if the projector is turned off. You need to re-adjust the position if you change the installation location or angle of the projector.
- You can also use the Configuration menu to adjust the position of the image.
 🖱️ **Settings - Image Shift** [p.142](#)

Adjusting the Vertical Position of the Image (Models Supplied with the Feet Only)

Extend the feet. You can adjust the vertical position of the image by tilting the projector up to 1.5°.



The larger the angle of tilt, the harder it becomes to focus. Install the projector so that it only needs to be tilted at a small angle.

Raising the height of the image

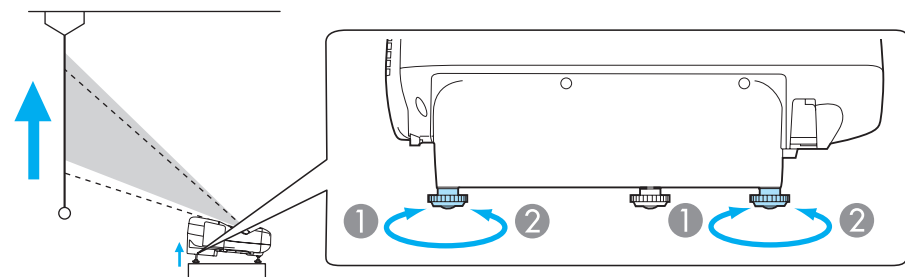

- 1 You can raise the height of the image by extending the rear feet.
- 2 Retract the rear feet to return the image to its original height.

Lowering the height of the image

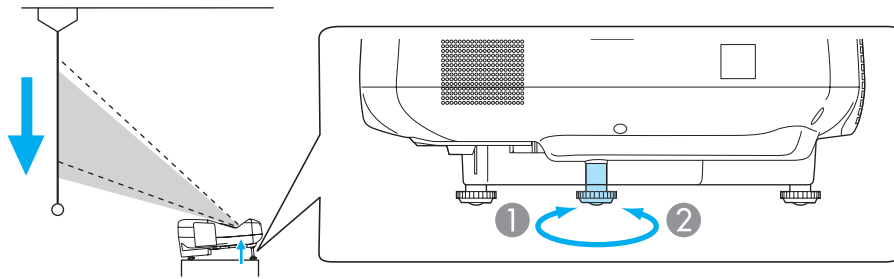

- 1 You can lower the height of the image by extending the front foot.
- 2 Retract the front foot to return the image to its original height.

Adjusting the Horizontal Position of the Image (Models Supplied with the Feet Only)

Extend and retract the rear feet to adjust the projector's horizontal tilt.

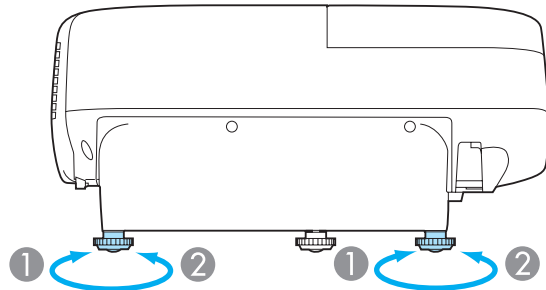

- 1 Extend the rear foot.

- 2 Retract the rear foot.

Correcting the Focus

You can correct the focus using the focus lever.

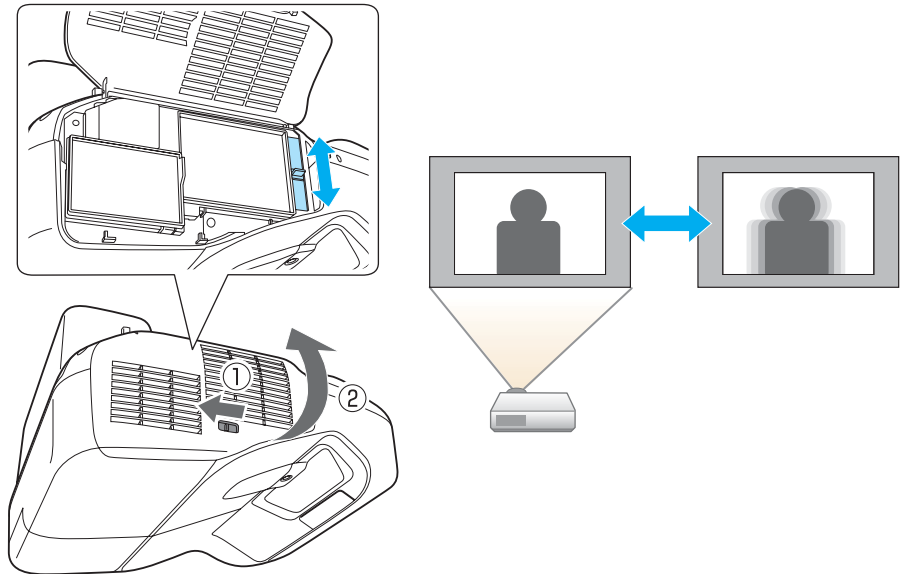

Adjusting the Volume

You can adjust the volume using one of the following methods.

- Press the [Volume] buttons on the remote control to adjust the volume.
 [🔊] Decreases the volume.
 [🔊] Increases the volume.

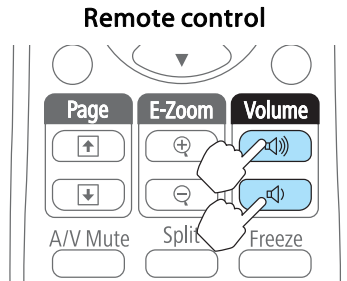

- Adjust the volume from the Configuration menu.
 🖱️ **Settings - Volume** p.142

⚠ Caution

Do not start when the volume is set too high. A sudden increase in volume may cause loss of hearing. Always lower the volume before powering off, so that you can power on and then gradually increase the volume.

Adjusting the Image

Hue, Saturation, and Brightness adjustment

The Hue, Saturation, and Brightness for each of the R (red), G (green), B (blue), C (cyan), M (magenta) and Y (yellow) color components can be adjusted.

Make settings from the configuration menu.

- 🖱️ **Image - Advanced - RGBCMY** p.139

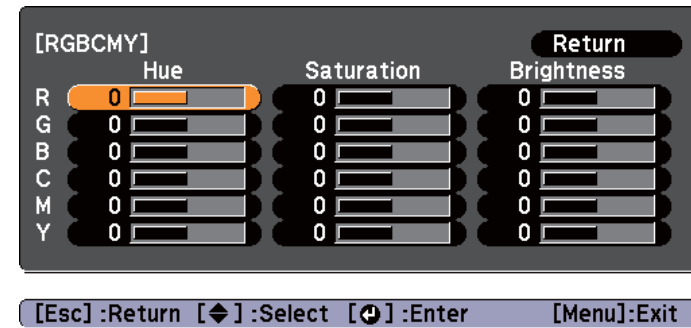

Hue	Adjusts the overall hue of the image, bluish - greenish - reddish.
Saturation	Adjusts the overall vividness of the image.
Brightness	Adjusts the overall color brightness of the image.

Gamma adjustment

Adjusts differences in the coloring for the projected image that occurs depending on the connected device.

Make settings from the configuration menu.

- 🖱️ **Image - Advanced - Gamma** p.139

Select and adjust the correction value

☛ **Image - Advanced - Gamma** p.139

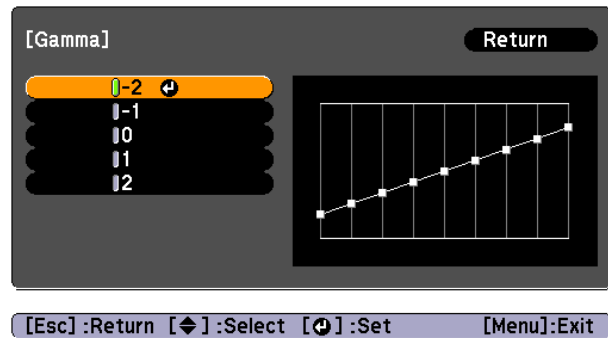

When a smaller value is selected, the dark areas of images become brighter, but the color saturation for lighter areas may become weaker. When a larger value is selected, you can reduce the overall brightness of the image to make the image sharper.

If you select **DICOM SIM** or **Customized** from **Color Mode** on the **Image** menu, select the adjustment value according to the projection size.

- If the projection size is 80 inches or less, select a large value.
- If the projection size is 80 inches or more, select a small value.



Medical images may not be reproduced correctly according to your settings and screen specifications.

Selecting the Projection Quality (Selecting Color Mode)

You can easily obtain the optimum image quality simply by selecting the setting that best corresponds to your surroundings when projecting. The brightness of the image varies depending on the mode selected.

Mode	Application
Dynamic	Ideal for use in a bright room. This is the brightest mode, and reproduces shadow tones well.
Presentation	Ideal for making presentations using color materials in a bright room.
Theatre	Ideal for watching films in a dark room. Gives images a natural tone.
Photo*1	Ideal for projecting still pictures, such as photos, in a bright room. The images are vivid and brought into contrast.
Sports*2	Ideal for watching TV programmes in a bright room. The images are vivid and brought to life.
sRGB	Ideal for images that conform to the <u>sRGB</u> color standard.
Whiteboard	Ideal for making presentations using a whiteboard.
DICOM SIM*1	Ideal for projecting X-ray photographs and other medical images. This produces images with clear shadows. The projector is not a medical device and cannot be used for medical diagnosis.
Customized	Adjusts the RGBCMY. ☛ "Adjusting the Image" p.57

*1 This selection is only available when the input signal is RGB or when the source is USB Display, USB1, USB2, or LAN.

*2 This selection is only available when the input signal is component video, or when the source is Video.

Each time you press the [Color Mode] button, the Color Mode name is displayed on the screen and the Color Mode changes.

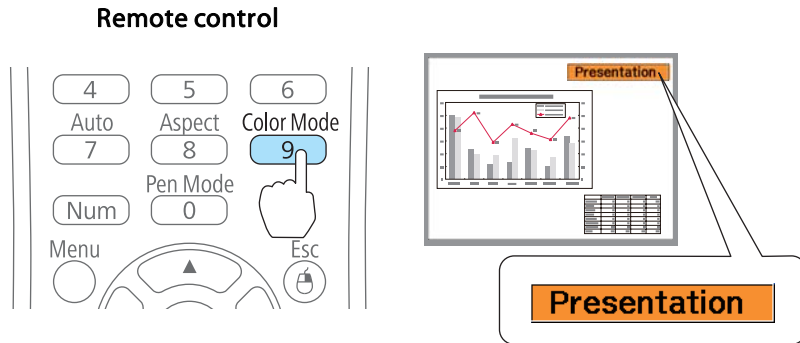

You can set Color Mode from the Configuration menu.
 🖱️ Image - Color Mode [p.139](#)

Setting Auto Iris

By automatically setting the luminance according to the brightness of the displayed image, it lets you enjoy deep and rich images.

- 1 Press the [Menu] button.
 🖱️ "Using the Configuration Menu" [p.136](#)

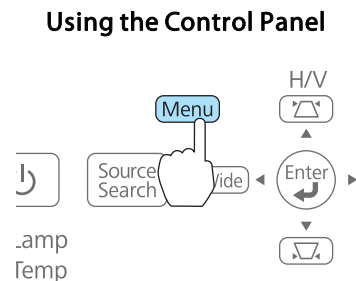
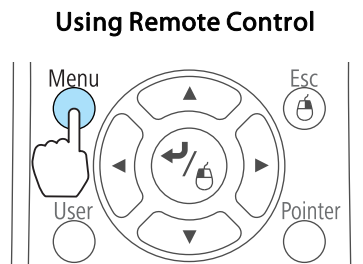

- 2 Select **Auto Iris** from **Image**.

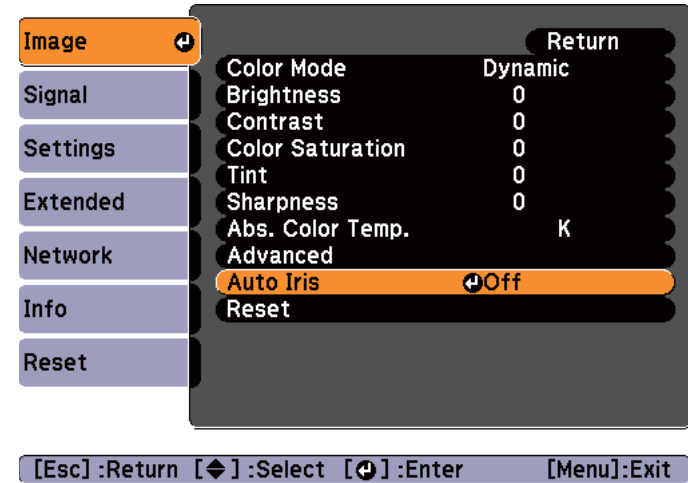

- 3 Select **On**.
 The setting is stored for each Color Mode.
- 4 Press the [Menu] button to finish making settings.

Auto Iris can only be set when the **Color Mode** is set to **Dynamic**, **Theatre**, or **Customized**.

Changing the Aspect Ratio of the Projected Image

You can change the Aspect Ratio of the projected image to suit the type, the ratio of height and width, and the resolution of the input signals.

Available Aspect Modes vary depending on the image signal currently being projected.

Changing methods

Each time you press the [Aspect] button on the remote control, the aspect mode name is displayed on the screen and the aspect ratio changes.

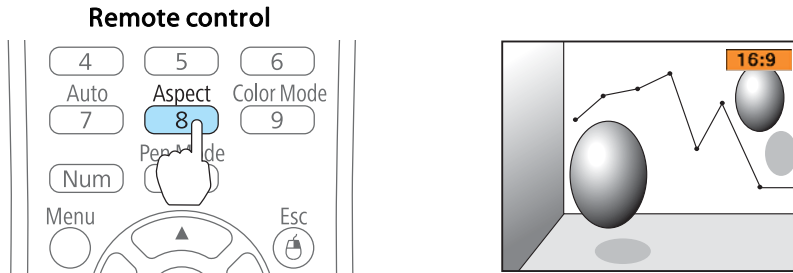

 You can set the aspect ratio from the Configuration menu.
 🖱️ **Signal - Aspect** [p.140](#)

Changing the aspect mode

Projecting images from video equipment or from the HDMI or DisplayPort ports

Each time the [Aspect] button on the remote control is pressed, the aspect mode changes in the order **Normal** or **Auto**, **16:9**, **Full**, **Zoom**, and **Native**.

Example: 1080p signal input (resolution: 1920x1080, aspect ratio: 16:9)

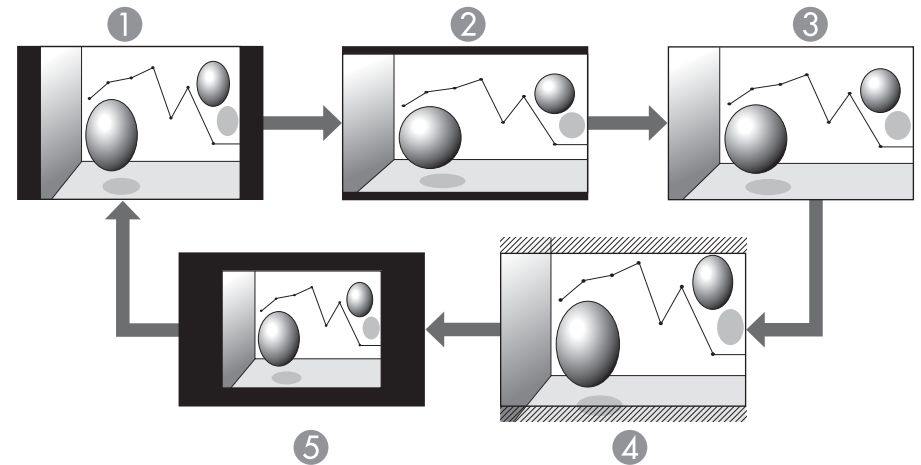

- ① Normal or Auto
- ② 16:9
- ③ Full
- ④ Zoom
- ⑤ Native

Projecting images from a computer

The following shows projection examples for each aspect mode.

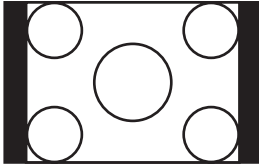
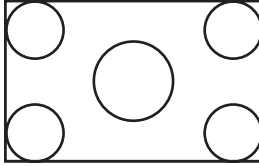
Aspect mode	Input Signal	
	XGA 1024X768(4:3)	WXGA 1280X800(16:10)
Normal		

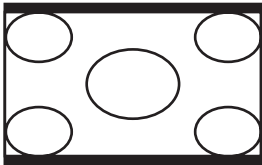
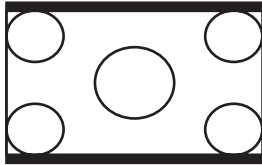
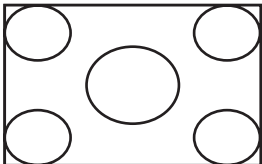
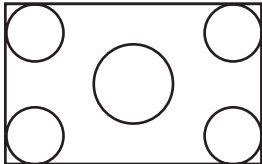
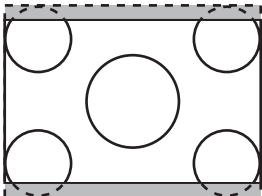
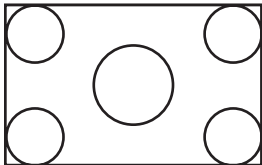
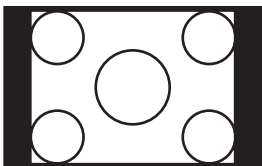
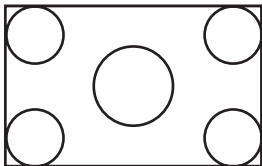
Aspect mode	Input Signal	
	XGA 1024X768(4:3)	WXGA 1280X800(16:10)
16:9		
Full		
Zoom		
Native		



If parts of the image are missing, set the **Resolution** setting to **Wide** or **Normal** from the Configuration menu, according to the size of the computer panel.

☛ **Signal - Resolution** [p.140](#)



Interactive Function

This chapter explains the interactive function (Easy Interactive Function).

Performing a Variety of Tasks with the Interactive Function



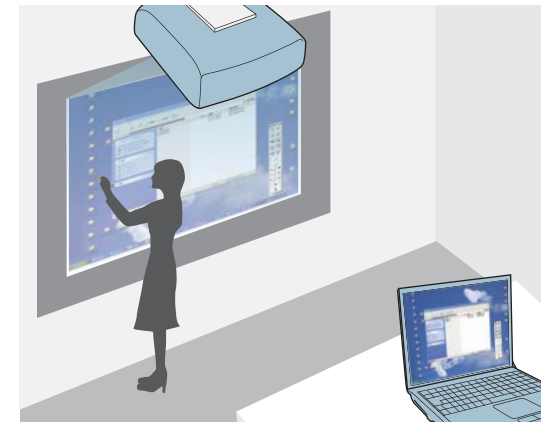
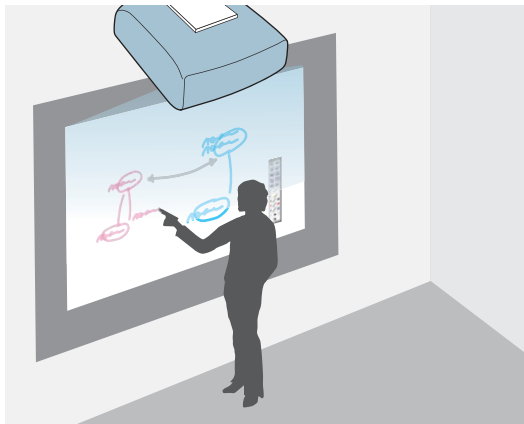

- Draw on plain screens such as whiteboards
 - ☛ "Drawing on a Whiteboard Screen (Whiteboard Mode)" [p.69](#)
- Draw on documents being projected
 - ☛ "Drawing on the Projected Image (PC Free Annotation)" [p.75](#)
- Perform computer mouse operations with the pen
 - ☛ "Operating a Computer from the Projected Screen (PC Interactive)" [p.84](#)

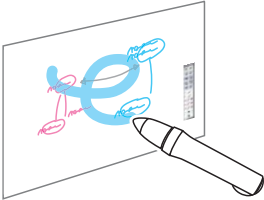

- Save the projected screen
 - ☛ "Saving" [p.80](#)
 - Print the projected screen
 - ☛ "Printing" [p.81](#)
 - Read paper documents from a scanner
 - ☛ "Read paper documents from a scanner" [p.73](#)
 - Attach the projected screen to an email and send
 - ☛ "Sending Emails (Whiteboard Mode Only)" [p.82](#)
- Save the projected screen
 - ☛ "Saving" [p.80](#)
 - Print the projected screen
 - ☛ "Printing" [p.81](#)

Three Modes

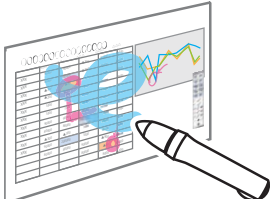
The interactive function has three modes.

	Function Name	Type of Function	Explanation
①	Whiteboard Mode 	Drawing function	Projects a plain surface that looks like a whiteboard. Using the Easy Interactive Pen, you can draw letters and shapes on the screen. This is useful in meetings as a substitute for a whiteboard. "Drawing on a Whiteboard Screen (Whiteboard Mode)" p.69 <div style="border: 1px solid black; padding: 5px; margin-top: 10px;">  In Whiteboard Mode, one screen is treated as one page like a notebook. You can create up to 50 pages. </div>
②	PC Free Annotation 	Drawing function	Using the Easy Interactive Pen, you can draw letters and shapes on the projected screen. This is useful when you need to emphasize an important point during a meeting, or to provide additional notes. "Drawing on the Projected Image (PC Free Annotation)" p.75
③	PC Interactive 	Computer operations function	By using the Easy Interactive Pen, you can perform computer mouse operations on the projected screen. This allows you to draw and perform PC Interactive functions from the projected screen which helps to move meetings and presentations along smoothly. "Operating a Computer from the Projected Screen (PC Interactive)" p.84

Make sure you perform pen calibration when using the Easy Interactive Pen for the first time so that the projector recognizes the position of the pen correctly.

Auto Calibration and Manual Calibration are also available.



Turn off the unused Easy Interactive Pen or move it away from the projection screen when calibrating a pen.

Auto Calibration

This function automatically calibrates the pen.

- 1 Set **Extended - Easy Interactive Function** to **Auto Calibration** from the configuration menu.

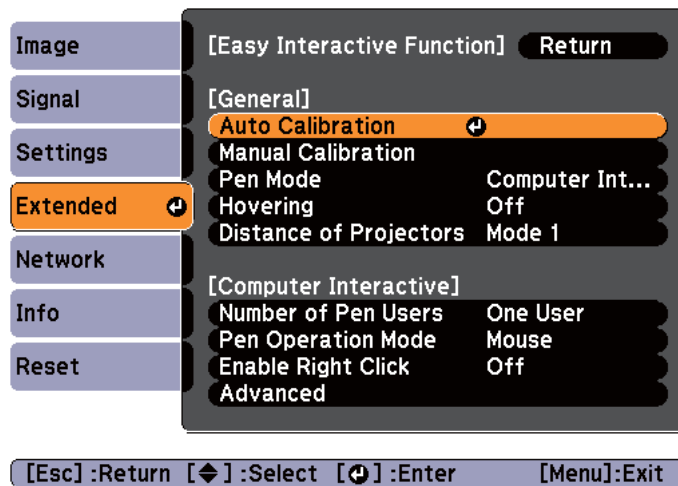

- 2 Adjust the focus by following the on-screen instructions.

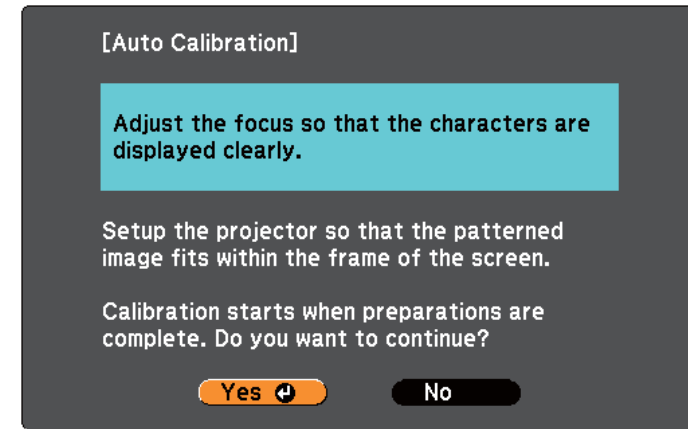

☛ "Correcting the Focus" [p.56](#)

- 3 Select "Yes".
Use the [↵] button on the remote control or control panel to select "Yes".
- 4 The pattern image is projected and calibration starts.
Wait until calibration is complete.
Do not obstruct the projected light while the pattern image is being projected.



- At the time of purchase, Auto Calibration is assigned to the [User] button on the remote control. By pressing the [User] button on the remote control, you can start from step 2 .
 - ☛ "Remote Control" [p.16](#)
- If you start pen positioning using the remote control, make all operations using the remote control. If you start pen positioning using the Easy Interactive Pen, make all operations using the Easy Interactive Pen.

An error is displayed if Auto Calibration is not successful. Perform Manual Calibration.

☛ "Manual Calibration" [p.66](#)

Manual Calibration

This function allows you to manually calibrate the pen.

- 1 Set **Extended - Easy Interactive Function** to **Manual Calibration** from the configuration menu.

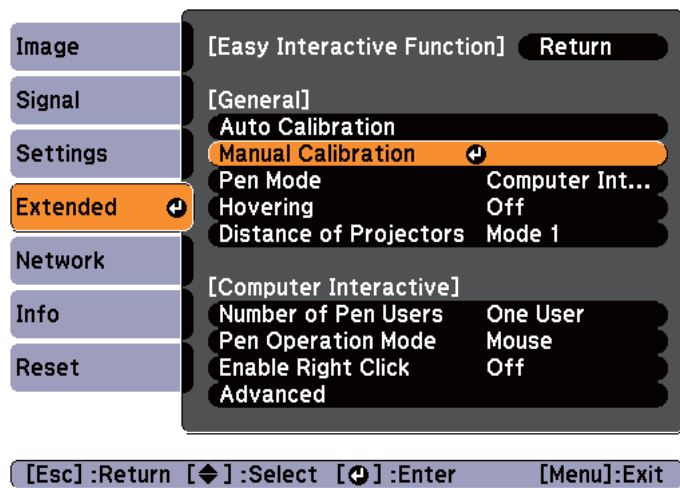

- 2 Adjust the focus by following the on-screen instructions.

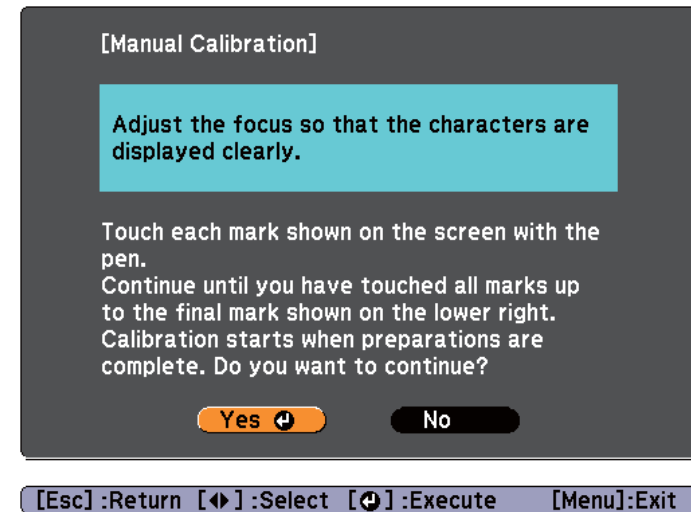

- 3 Use the [↵] button on the remote control or control panel to select "Yes".
- 4 A dot is displayed on the projected screen. Touch the center of the dot with the tip of the Easy Interactive Pen. The dot disappears and then appears at the next position.

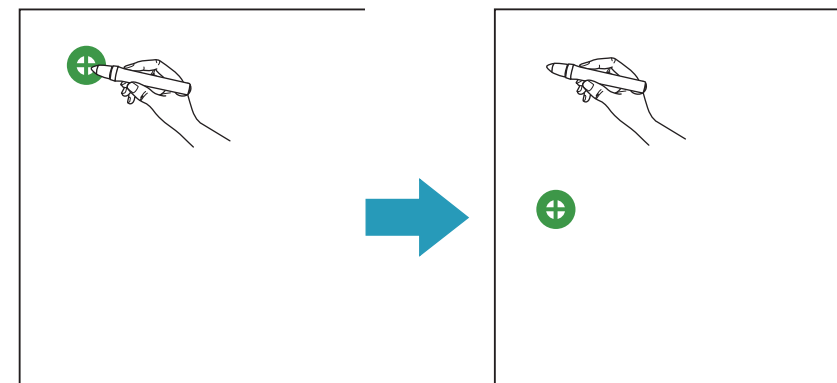



Make sure you touch the center of the dot. Otherwise, it may not be positioned correctly.

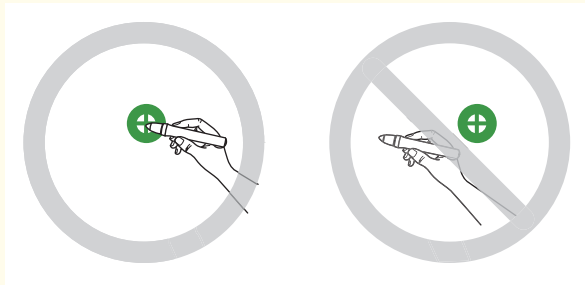

5 The dot appears at the top left first and then moves towards the bottom right.

Repeat step 4 until all of the dots disappear.

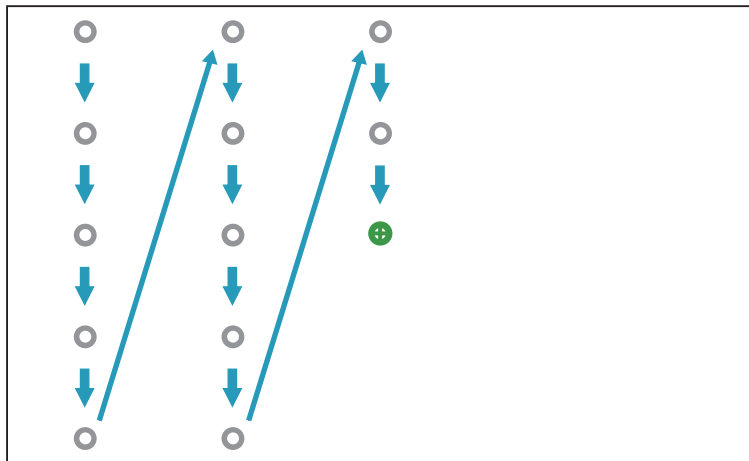

- If you touch the wrong position, press the [Esc] button on the remote control or control panel to return to the previous dot. You cannot go back further than the previous dot.
- Press and hold the [Esc] button to cancel the calibration.
- It may take several seconds after all of the dots have disappeared until calibration is complete.

When You Need to Calibrate the Pen

The position where you are drawing with the Easy Interactive Pen and where the drawing is displayed may not match in the following situations.

- After performing Keystone correction.
- After adjusting the image size.
- After performing Image Shift.
- After changing the projector's position.

Calibrate the pen again if you notice any discrepancy in positioning.

Using the Pen

Check that the battery is installed, and then turn on the Easy Interactive Pen.

☛ "Easy Interactive Pen" [p.20](#)

Touch the pen tip button to the screen to select an item such as an icon.

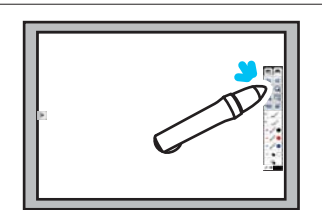

Touch the screen and move to draw on the projected screen.

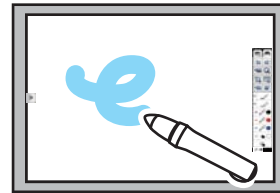

Move over the screen without touching to move the pointer. This is known as "hovering".

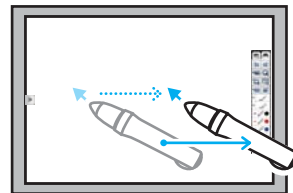

Attention

The interactive function operates by infrared communication. Note the following important points when using this function.

- Make sure there is no strong light or sunlight shining on the Easy Interactive Function receiver or the projection screen.
- If there is any dust stuck to the Easy Interactive Function receiver, it could interfere with infrared communication and you may not be able to use the function normally.
- Do not put paint or any stickers on the cover of the Easy Interactive Function receiver.
- Install the projector so that the Easy Interactive Function receiver is not too close to fluorescent lights.
- Do not use an infrared remote control or infrared microphone in the same room because the Easy Interactive Pen may malfunction.
- The Easy Interactive Function may be interrupted by electromagnetic interference from nearby equipment (such as electric motors or transformers).
- The Easy Interactive Pen is not waterproof. Do not use it with wet hands, or in locations where it may get wet.
- Do not hold section (a) of the pen tip of the Easy Interactive Pen, and make sure this section does not get damaged or soiled. Otherwise, the Easy Interactive Pen may not work.

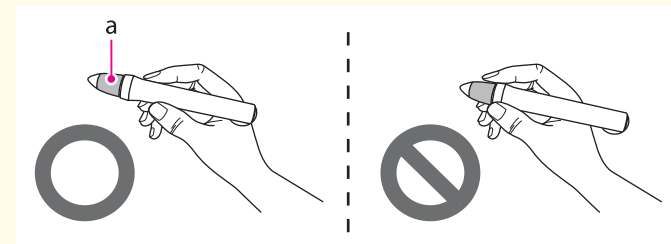

The following projector drawing functions are available.

Change the mode to suit your needs.

☛ "Drawing on a Whiteboard Screen (Whiteboard Mode)" [p.69](#)

☛ "Drawing on the Projected Image (PC Free Annotation)" [p.75](#)



You can use two Easy Interactive Pens at the same time.

Drawing on a Whiteboard Screen (Whiteboard Mode)

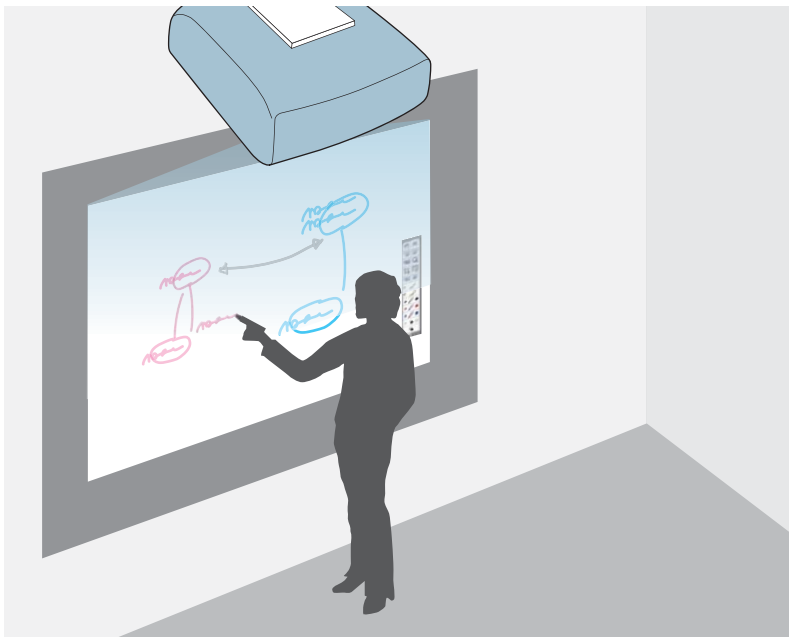

Projects a plain surface that looks like a whiteboard. Using the Easy Interactive Pen, you can draw letters and shapes on the screen.

This is useful in meetings as a substitute for a whiteboard.

Starting Whiteboard Mode

- 1** Turn on the Easy Interactive Pen.
- 2** Press the [Whiteboard] button on the Control Pad or the remote control.

The toolbar and the bottom toolbar are displayed on the projected screen.

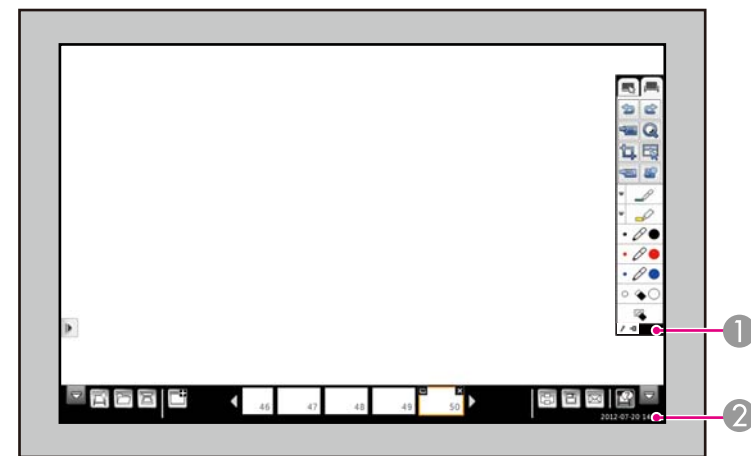

1 Toolbar

2 Bottom toolbar

When the toolbars are displayed, you can write on the projected screen using the Easy Interactive Pen.



The toolbar provides drawing functions such as a pen, drawing tools, and so on.

The bottom toolbar provides functions such as scanning documents and saving the screen.

☞ "Toolbar functions" p.70

☞ "Bottom toolbar functions" p.72







- You can also change to Whiteboard Mode using one of the following methods.
 - Click  on the toolbar (only when using PC Free Annotation)
 - Select **Whiteboard** as the Web Remote source setting
 - ☞ "Displaying the Web Remote screen" p.123
- To change to PC Free Annotation or PC Interactive from Whiteboard Mode, press the [Whiteboard] button on the remote control or the Control Pad, or click the  on the toolbar.
- Any drawings that you make in Whiteboard Mode are kept if you change to PC Free Annotation.



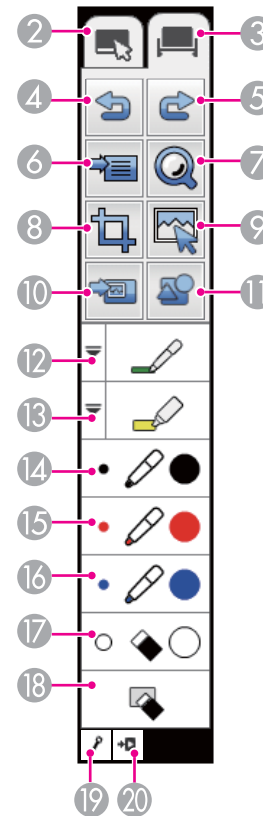













Attention













- If the power is accidentally turned off while drawing, the drawings are saved, but they will be removed after a certain amount of time has passed.
- On the Whiteboard Settings screen, you can make settings to prevent data leakage. Make settings according to your environment.
 - ☞ **Extended - Whiteboard Settings** p.144







Toolbar functions



1		Toolbar Tab Shows or hides the toolbar. The tab can be moved up and down.
2		Annotation Mode Changes to PC Free Annotation or PC Interactive.
3		Whiteboard Mode Switches to Whiteboard Mode.





4		Undo Undoes the previous operation.
5		Redo Cancels an undo operation and restores the previous status.
6		Template You can choose the background for Whiteboard Mode from a set of available patterns. []: Displays a ruler. []: Displays grid lines. []: Displays a list of selectable preset templates and customized templates that have been registered. You can set customized templates using a Web browser. 🖱️ "Changing Settings Using a Web Browser (Web Control)" p.122 <div style="border: 1px solid black; padding: 5px; margin-top: 10px;">  You can change the line width by clicking the ruler icon or the grid lines icon. </div>
7		Zoom []: Enlarges the image. You can draw while enlarged. []: Reduces the image. You cannot reduce more than once. []: Increases the magnification by one. []: You can move the enlarged area up, down, left, or right.
8		Trim Trims the image in the shape of the area you specified. You can change the area you want to trim by dragging the corner of the image. You can also move an image by dragging the inside of the selected image. The target for operation is the image pasted from [], [], [], or []. When you click this icon, the image is chosen automatically.



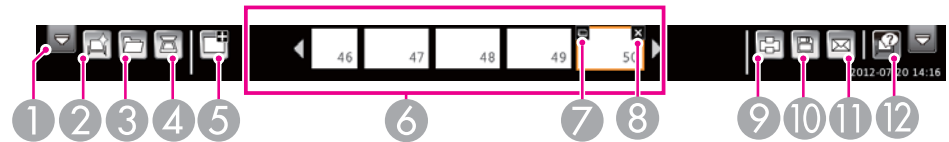
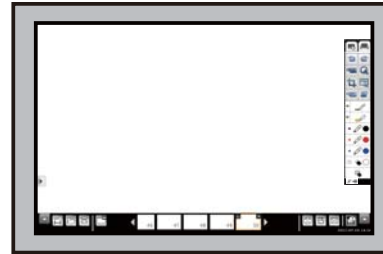



9		Select Moves, resizes, and turns the image. The target for operation is the image pasted from [], [], [], or []. When you click this icon, the image is chosen automatically. <ul style="list-style-type: none"> • Move image: Touch the inside of the selected image with the Easy Interactive Pen and drag to move. • Resize image: Touch the edge of the selected image with the Easy Interactive Pen and drag to resize. • Rotate image: Touch the top of the selected image with the Easy Interactive Pen and drag in the direction you want to rotate.
10		Insert Image You can select images from the USB storage device or a network folder. You can select the following files. Format: PNG, JPEG Resolution: 2048 x 2048 maximum Images larger than a page are reduced to fit. When you insert an image, the previous image is removed.
11		Shapes You can select shapes from the shapes provided. You can select the color of the shape and the thickness of the lines.
12		Pen Switches to a pen to draw freely. Click [] on the left of the icon to change the color and width of the pen line.
13		Highlighter pen Switches to a highlighter pen that can draw translucent lines. Click [] on the left of the icon to change the color and width of the highlighter pen.
14		Black pen Switches to a black pen to draw freely. Click on the right of the icon to draw thick lines, and click on the left of the icon to draw fine lines.

15		Red pen Switches to a red pen to draw freely. Click on the right of the icon to draw thick lines, and click on the left of the icon to draw fine lines.
16		Blue pen Switches to a blue pen to draw freely. Click on the right of the icon to draw thick lines, and click on the left of the icon to draw fine lines.
17		Eraser Switches to an eraser. Click on the right of the icon to erase wider areas, and click on the left of the icon to erase narrower areas.
18		Clear screen Clears everything drawn on the displayed page.
19		Always show toolbar Click to hide the toolbar each time you draw something. By default, the toolbar is always displayed.
20		Close Hides the toolbar.

Bottom toolbar functions



1		Bottom Toolbar Tab Shows or hides the bottom toolbar.
2		New meeting Saves or cancels the current editing content, and returns Whiteboard Mode to its default status.
3		Open Selects a file and pastes it on a new page. ☛ "Opening files and reading into Whiteboard Mode" p.74
4		Scan You can capture images from a scanner and paste on a new page. ☛ "Read paper documents from a scanner" p.73
5		New Page Opens a new page.

6		<p>Thumbnail</p> <p>Displays a list of the page thumbnails being edited.</p> <p>You can scroll by dragging the Easy Interactive Pen. Moves to the page for the selected thumbnail. When you select a page using the Easy Interactive Pen and wait for a while, you can drag to change the page.</p> <p>Click [◀] to move to the previous page.</p> <p>Click [▶] to move to the next page.</p>
7		<p>Duplicate Page</p> <p>Duplicates the current page, and adds it after the last page.</p>
8		<p>Delete Page</p> <p>Deletes the current page.</p>
9		<p>Print</p> <p>Sends the projected screen to the printer.</p> <p>☛ "Printing" p.81</p>
10		<p>Save</p> <p>Saves the projected screen to the connected USB storage device or network folder.</p> <p>☛ "Saving" p.80</p>
11		<p>Mail</p> <p>Sends the projected screen by email. You need to make mail server settings in advance.</p> <p>☛ "Sending Emails (Whiteboard Mode Only)" p.82</p>
12		<p>Guidance</p> <p>Displays the help screen for the toolbar and the bottom toolbar functions. Click anywhere on the projected screen with the Easy Interactive Pen to hide the help screen.</p>



- You can make detailed settings for Whiteboard Mode on the Whiteboard Settings screen from the Configuration menu.
 - ☛ **Extended - Whiteboard Settings** p.144
- The following functions cannot be used in Whiteboard Mode.
 - E-Zoom
 - Page Up/Down
 - Split Screen

Read paper documents from a scanner

Scan data such as paper documents and paste it on a new page as an image in Whiteboard Mode. This function supports the scanner function for printers connected by a USB cable or over a network.

You need to make settings for network printers in advance.

☛ "Whiteboard Settings screen" p.147

Printers* with scanning functions and the following printer control commands are supported. Stand-alone scanners are not supported.

- ESC/P-R

* Not all printers are supported. For more details on supported models, contact your local dealer or the nearest address provided in the Epson Projector Contact List.

☛ *Epson Projector Contact List*



- You cannot scan using the button on the printer.
- The entire area for the scanner is always read.
- Double sided scanning with the Automatic Document Feeder (ADF) is not supported.

1 Load paper in the scanner.

2 Click [] on the bottom toolbar.

The Scan screen is displayed.

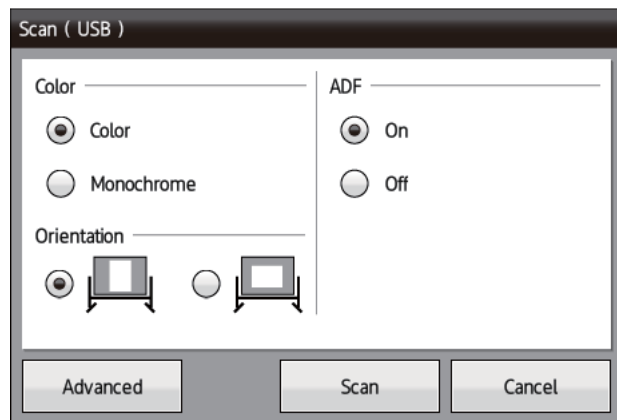

3 Make necessary settings on the Scan screen.
Click **Advanced** to open the detailed menu.

Item	Explanation
Color	Select Color or Monochrome.
Orientation	Select the orientation for the scanned document.
ADF	Select the import device. For scanners that do not support ADF, the document is scanned from the document table regardless of this setting.
Scanner	Select the scanner you want to use.

4 Click [Scan].

The Scan screen is displayed.

5 After scanning, the image is pasted onto a new page in Whiteboard Mode.



When using a scanner with a built-in ADF, up to 10 sheets can be read. Repeat the procedure if you need to scan documents of more than 10 sheets.

Opening files and reading into Whiteboard Mode

Press [] to open a file and read it into Whiteboard Mode. The opened file is added as a new page.

The following types of file can be read into the Whiteboard Mode. Images larger than a page are reduced to fit.

Type	File Type (Extension)	Notes
Image	.jpg	The following cannot be read. <ul style="list-style-type: none"> • Images with a resolution greater than 2048 x 2048 • Files with the extension ".jpeg" • CMYK color mode formats • Progressive formats
	.png	Cannot read images with a resolution greater than 2048 x 2048.
PDF	.pdf	You can open PDF files for version 1.7 or earlier. Set the number of pages when opening a PDF file. If the file is password protected, enter the password.

Drawing on the Projected Image (PC Free Annotation)

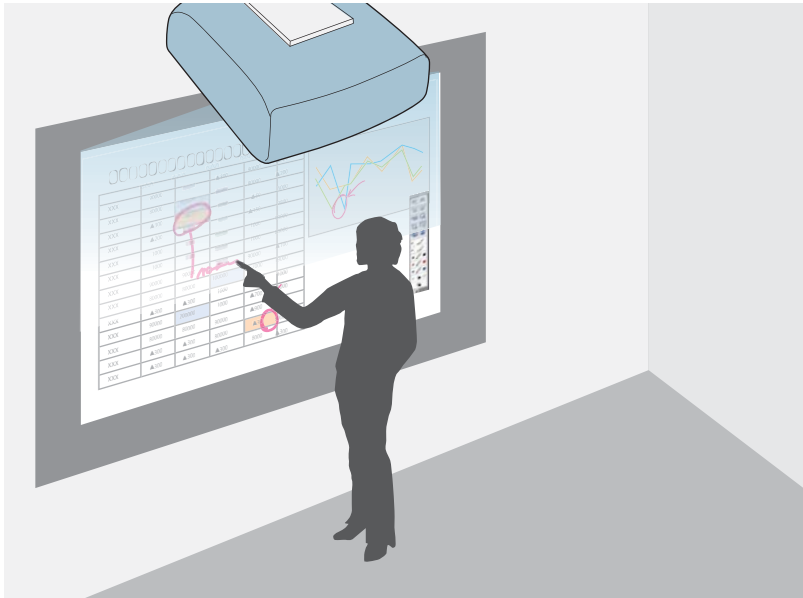

Using the Easy Interactive Pen, you can draw letters and shapes on the projected screen.

This is useful when you need to emphasize an important point during a meeting, or to provide additional notes.

Starting PC Free Annotation

- 1 Project an image from a connected device.
 ☛ "Automatically Detect Input Signals and Change the Projected Image (Source Search)" [p.47](#)

- 2 Set **Pen Mode** to **PC Free Annotation** from the Configuration menu.
 ☛ **Extended - Easy Interactive Function - Pen Mode** [p.144](#)
- 3 Turn on the Easy Interactive Pen, and hold it close to the projected screen.
 The toolbar and the bottom toolbar are displayed on the projected screen.

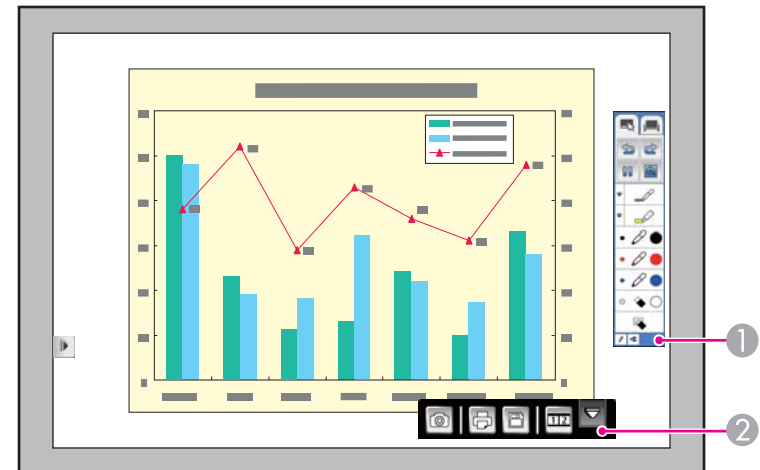

- 1 Toolbar
- 2 Bottom Toolbar

When the toolbars are displayed, you can write on the projected screen using the Easy Interactive Pen.

The toolbar provides drawing functions such as a pen, drawing tools, and so on.

The bottom toolbar provides functions such as saving the screen.



- ☛ "Toolbar functions" [p.76](#)
- ☛ "Bottom toolbar functions" [p.78](#)





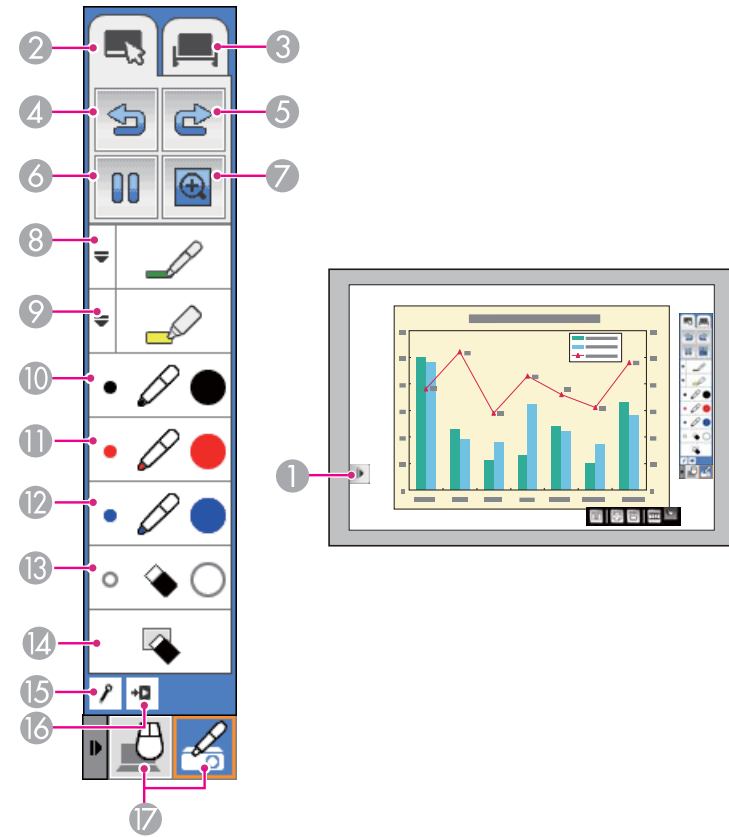

















- To change from PC Free Annotation to Whiteboard Mode, press the [Whiteboard] button on the remote control or the Control Pad, or click the  on the toolbar.
- See the following for information on changing from PC Interactive to PC Free Annotation.
 - "Changing to PC Interactive" p.86

Toolbar functions







<p>①</p>		<p>Toolbar Tab Shows or hides the toolbar. The tab can be moved up and down.</p>
<p>②</p>		<p>Annotation Mode Switches to PC Free Annotation.</p>

3		<p>Whiteboard Mode</p> <p>Switches to Whiteboard Mode.</p>
4		<p>Undo</p> <p>Undoes the previous operation.</p>
5		<p>Redo</p> <p>Cancels an undo operation and restores the previous status.</p>
6		<p>Freeze</p> <p>Pauses the projected image. Each time you touch the icon, Freeze turns on or off.</p> <div data-bbox="353 686 1048 833" style="border: 1px solid black; padding: 5px; margin-top: 10px;"> <p> You can also use the [Freeze] button on the remote control.</p> <p> "Freezing the Image (Freeze)" p.105</p> </div>
7		<p>E-Zoom</p> <p>Displays a target allowing you to enlarge the image at the center of the target. You can move the target with the Easy Interactive Pen. You cannot draw on the screen when enlarged.</p> <div data-bbox="353 1002 1048 1318" style="border: 1px solid black; padding: 5px; margin-top: 10px;"> <p> • You can scroll the enlarged image by dragging it with the Easy Interactive Pen.</p> <p>• You cannot use E-Zoom from the remote control, document camera, or Crestron RoomView® while operating the Easy Interactive Pen in E-Zoom.</p> <p> "Enlarging Part of the Image (E-Zoom)" p.107</p> <p> "About Crestron RoomView®" p.129</p> </div>
8		<p>Pen</p> <p>Switches to a pen to draw freely. Click [] on the left of the icon to change the color and width of the pen line.</p>

9		<p>Highlighter pen</p> <p>Switches to a highlighter pen that can draw translucent lines. Click [] on the left of the icon to change the color and width of the highlighter pen.</p>
10		<p>Black pen</p> <p>Switches to a black pen to draw freely. Click on the right of the icon to draw thick lines, and click on the left of the icon to draw fine lines.</p>
11		<p>Red pen</p> <p>Switches to a red pen to draw freely. Click on the right of the icon to draw thick lines, and click on the left of the icon to draw fine lines.</p>
12		<p>Blue pen</p> <p>Switches to a blue pen to draw freely. Click on the right of the icon to draw thick lines, and click on the left of the icon to draw fine lines.</p>
13		<p>Eraser</p> <p>Switches to an eraser. Click on the right of the icon to erase wider areas, and click on the left of the icon to erase narrower areas.</p>
14		<p>Clear screen</p> <p>Clears everything drawn on the displayed page.</p>
15		<p>Always show toolbar</p> <p>Click to hide the toolbar each time you draw something. By default, the toolbar is always displayed.</p>
16		<p>Close</p> <p>Hides the toolbar.</p>

17  **Pen Mode**

This icon allows you to easily switch between PC Free Annotation and PC Interactive if you want to operate the computer while drawing.

- To change from PC Free Annotation to PC Interactive, press [] and then select [].
After changing to PC Interactive, content drawn using PC Free Annotation is retained.
- To change from PC Interactive to PC Free Annotation, press [] and then select [].





☞ "Changing to PC Interactive" p.86

 The Pen Mode icon is displayed when **Pen Mode Icon** is set to **Right** or **Left**.

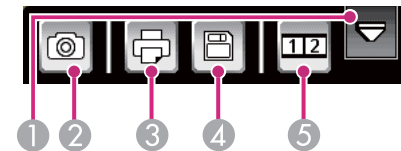
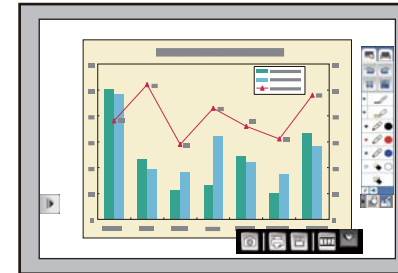
☞ **Extended - Display - Pen Mode Icon** p.144

Bottom toolbar functions



1		Bottom toolbar tab Shows or hides the bottom toolbar.
2		Capture Takes a snapshot of the projected screen. After taking the snapshot, the image is pasted onto a new page in Whiteboard Mode.
3		Print Sends the projected screen to the printer. ☞ "Printing" p.81 Items that can be set differ from the Whiteboard Mode print function.
4		Save Saves the projected screen in PNG format. ☞ "Saving" p.80 Items that can be set differ from the Whiteboard Mode save function.

5		Split Screen Each time the button is pressed, the image changes between projecting two images simultaneously by splitting the projected screen, or projecting one image as normal. ☛ "Projecting Two Images Simultaneously (Split Screen)" p.90
---	---	--

Saving

You can save the projected screen on a USB storage device or a network folder.

The functions and procedures differ for Whiteboard Mode and PC Free Annotation. You can make more detailed settings in Whiteboard Mode.

Attention

If you are using a multi-card reader or USB hub, operations may not be performed correctly. Connect directly to the projector or the Control Pad.



You may not be able to use USB storage devices that incorporate security functions.

For Whiteboard Mode

You can save in the following file formats.

- PNG (Resolution: 1280 x 800)
- PDF (set a password if necessary)

1 Press the [Save] button on the Control Pad or the remote control.



You can also save from [] on the bottom toolbar.

2 Make necessary settings on the Save screen displayed.

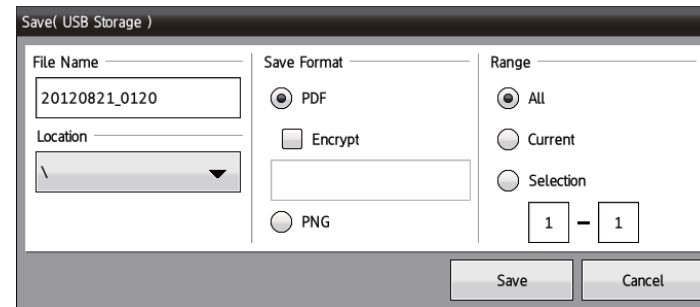

Item	Explanation
File Name	Enter the file name. Click the text box to display the soft keyboard, and then enter the file name.
Range	Set the range of pages that you want to save. You cannot select All if the save format is PNG.
Location	When pressed, a dialog box is displayed allowing you to select the folder in which to save the image.
Save Format	Select the save format (PDF or PNG). For PDFs, you can set whether or not to encrypt the file. Enter a password when you want to encrypt the file.

3 Click **Save**.

Attention

- When you enter the password, it is displayed on the screen.
- When encrypting a file, make sure you do not forget the password.

For PC Free Annotation

You can save in PNG format. The save location is the location set on the Whiteboard settings screen from the Configuration menu. An error occurs if you cannot use the set location. Also, the file name is set automatically.

- 1 Press the [Save] button on the Control Pad or the remote control.



You can also save from [] on the bottom toolbar.

- 2 The file is saved automatically.

Printing

Sends the projected screen to the printer and prints the data.

You need to make settings for network printers in advance.

☛ "Whiteboard Settings screen" [p.147](#)

Printers* with the following printer control commands are supported. You cannot connect via a network print adapter.

Control commands	Connection method
ESC/P-R	USB or over a network
ESC/Page, ESC/Page-Color	Over a network
PCL6	

* Not all printers are supported. For more details on supported models, contact your local dealer or the nearest address provided in the Epson Projector Contact List.

☛ [Epson Projector Contact List](#)

The functions and procedures differ for Whiteboard Mode and PC Free Annotation. You can make more detailed settings in Whiteboard Mode.

For Whiteboard Mode

- 1 Press the [Print] button on the Control Pad or the remote control.



You can also print from [] on the bottom toolbar.

- 2 Make necessary settings on the Print screen displayed. Click the **Advanced** button to display the detailed settings menu.

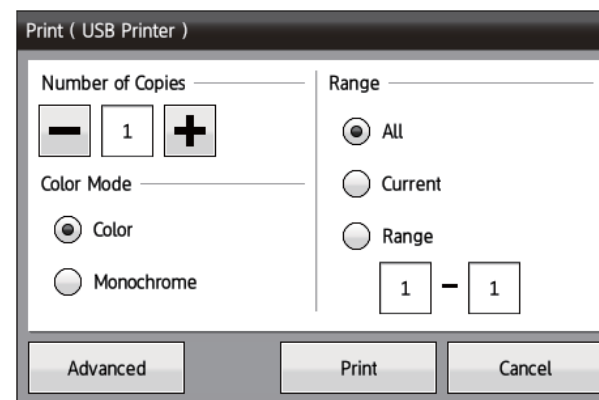

Item	Explanation
Number of Copies	Specifies the number of copies.
Color Mode	Specifies the print color.
Range	Set the range of pages that you want to print.
Printer	Displays a list of the connected printer names. Select the printer you want to use.
Paper Size	Set the print paper size.
Pages per sheet	Set the number of pages per sheet.
Page Border	Set whether or not to add a border to each page.

Item	Explanation
Page Number	Set whether or not to print a page number on each page.
Date & Time	Set whether or not to print a date and time on each page.
Collate	Set whether or not to collate pages when printing.

3 Click **Print**.

For PC Free Annotation

Prints using the settings for the printer set on the Whiteboard settings screen from the Configuration menu. An error occurs if a printer is not connected.

1 Press the [Print] button on the Control Pad or the remote control.



You can also print from [] on the bottom toolbar.

2 Specify the number of copies on the Print screen displayed.

3 Click **Print**.

Sending Emails (Whiteboard Mode Only)

The projected screen drawn in Whiteboard Mode can be attached and sent by email.



- To send emails, you need to make mail server settings in advance.
- The address for the sender and the recipient is the same.
- You cannot specify multiple addresses at the same time. There is no address book function.
- You cannot edit the text in the email.

1 Click [] on the bottom toolbar.

2 Make necessary settings on the Email sending screen displayed.

Item	Explanation
E-mail Address	Enter the email address for the sender. The email address that you set is stored until you perform New meeting.
Subject	Enter the subject for the email.
File Name	Enter the file name for the attachment.
File Format	Select the format for the attached file (PDF or PNG). For PDFs, you can set whether or not to encrypt the file. Enter a password when you want to encrypt the file.
Range	Set the page that you want to send.

3 Click **Send**.

Attention

- When you enter the password, it is displayed on the screen.
- When encrypting a file, make sure you do not forget the password.

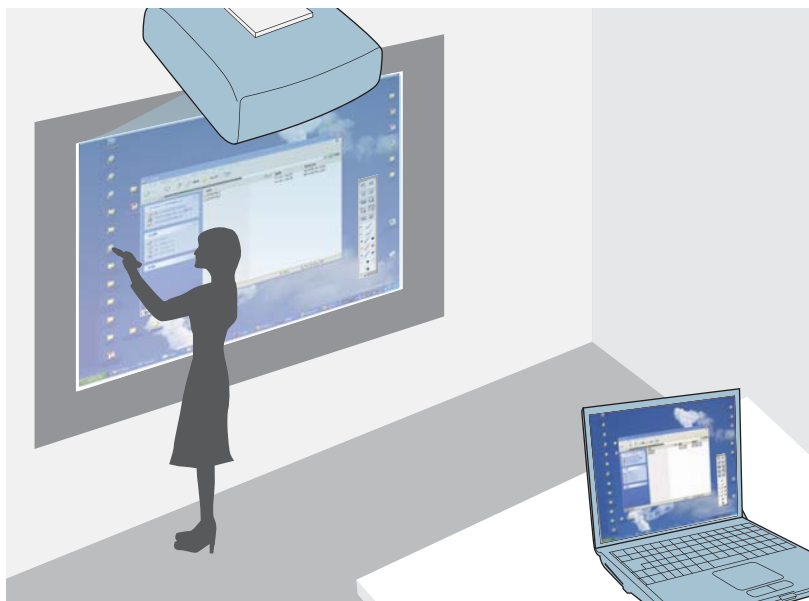

When the projector is connected to a computer, you can operate the computer from the projected screen.

- Using the Easy Interactive Pen, you can perform mouse operations such as clicking, right-clicking, or dragging and dropping.

Click	Tap the pen tip to the projected screen.
Right Click	Hold the pen tip to the screen for a few seconds, and then move it away.
Drag and drop	Hold the pen tip to the icon and so on that you want to move, and then drag the pen tip on the projected screen to the location you want to move to, and then remove the pen tip from the projected screen.

☛ "Easy Interactive Pen" [p.20](#)

- You can swap Right Click and Left Click in **Advanced - Pen Tip Button**.
- You cannot draw while using PC Interactive.

- You can easily switch between PC Interactive and PC Free Annotation.
☛ "Changing to PC Interactive" [p.86](#)

 When connected to the network, you can perform the following operations.

- By using the Easy Interactive Pen you can perform mouse operations for the computer over a network
- Project images from a projector that is operating in another conference room, and share screens across multiple projectors
- By using the Easy Interactive Pen, you can draw on projected screens that are being shared by other projectors (you need dedicated drawing software)

☛ "Using the Interactive Function over a Network" [p.118](#)

Preparing the Projector

You need to make the following preparations in advance to use the PC Interactive function.

You also need to perform the following operations when using the supplied software Easy Interactive Tools.

- 1** Projects images from the computer.

 For Mac OS X, you need to install Easy Interactive Driver on the computer.
☛ "Install Easy Interactive Driver (Mac OS X only)" [p.85](#)

- 2** Connect the projector to the computer using a USB cable. See the following when using the Control Pad.

☛ "Connecting when using the PC Interactive function" [p.41](#)



You do not need a USB cable when using PC Interactive over a network.

☞ "Using the Interactive Function over a Network" [p.118](#)

3 Set **Extended - USB Type B** from the Configuration menu.

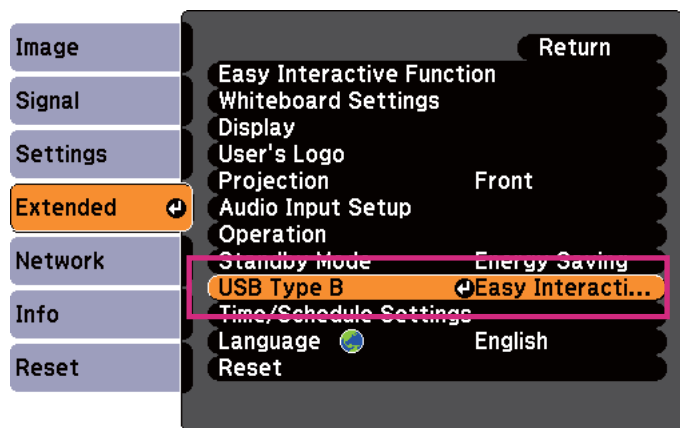

[Esc] :Return [◆] :Select [↵] :Enter [Menu]:Exit

Setting	Available Functions
Easy Interactive Function	PC Interactive
USB Display/Easy Interactive Function	<ul style="list-style-type: none"> • USB Display • PC Interactive
Wireless Mouse/USB Display	<ul style="list-style-type: none"> • Wireless Mouse • USB Display



- In step 1, you can also connect using USB Display. The performance of the Easy Interactive Pen may decline depending on the computer being used, the movie content, and so on.

- To use two Easy Interactive Pens with the PC Interactive function, set **Number of Pen Users** to **Two Users** from the Configuration menu.

☞ **Extended - Easy Interactive Function - Number of Pen Users** [p.144](#)

- Set **Pen Operation Mode** to **Mouse** from the Configuration menu to perform PC Interactive. (This can only be set if **Number of Pen Users** is set to **One User**)

☞ **Extended - Easy Interactive Function - Pen Operation Mode** [p.144](#)

Attention

Using two Easy Interactive Pens at the same time may cause interference in some application software.

Turn off the unused Easy Interactive Pen or move it away from the projection screen.

Install Easy Interactive Driver (Mac OS X only)

System Requirements

OS	Mac OS X 10.3.9 or later Mac OS X 10.4.x Mac OS X 10.5.x Mac OS X 10.6.x Mac OS X 10.7.x
CPU	Power PC G3 900 MHz or faster Recommended: Intel Core Duo 1.5 GHz or faster

Amount of Memory	256 MB or more Recommended: 512 MB or more
Hard Disk Space	100 MB or more
Display	Resolutions no lower than XGA (1024 x 768) and no higher than WUXGA (1920 x 1200) Display color of 16-bit color or greater

Installing



You can skip the following procedure if you installed Easy Interactive Tools using the Easy Install option as this already installs the Easy Interactive Driver.

 [Easy Interactive Tools Ver.2.1 Operation Guide](#)



- 1** Turn on your computer.
- 2** Insert the "EPSON Projector Software for Easy Interactive Function" CD-ROM into your computer.
- 3** Double-click the Install Navi icon in the EPSON window.
- 4** Select **Custom Install**, and then follow the on-screen instructions to install.
- 5** Restart the computer.

Changing to PC Interactive



You can change between the PC Free Annotation and PC Interactive using one of the following methods.

- Press the [Pen Mode] button on the remote control



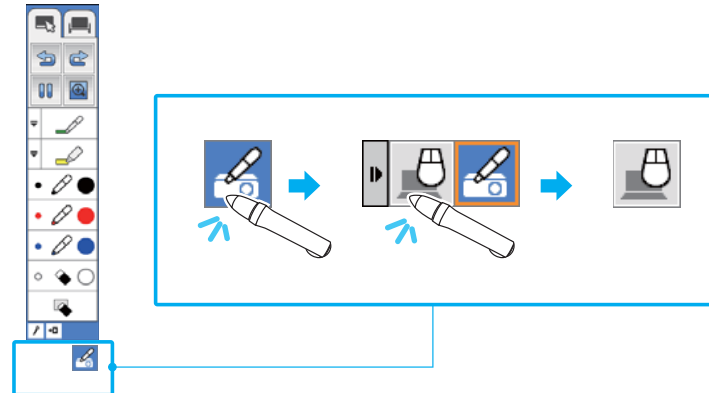

- Press the Pen Mode icon on the projected screen using the Easy Interactive Pen

To change from PC Free Annotation to PC Interactive, press [] and then select [].

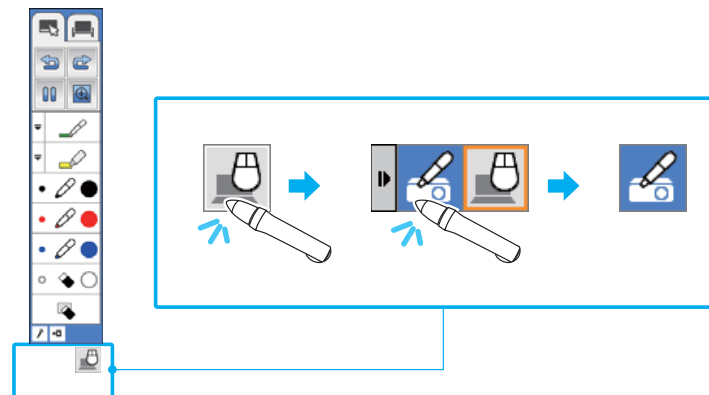

To change from PC Interactive to PC Free Annotation, press [] and then select [].



- 
 - The Pen Mode icon is displayed when **Pen Mode Icon** is set to **Right** or **Left**.
 -  **Extended - Display - Pen Mode Icon** p.144
 - When the source is Whiteboard, Video, USB1, or USB2, [] and [] are not displayed.
 - You can change PC Free Annotation and PC Interactive from the Configuration menu.
 -  **Extended - Easy Interactive Function - Pen Mode** p.144
 - Set **Pen Operation Mode** to **Pen** to enable the pen function in Windows Vista/7. (This can only be set if **Number of Pen Users** is set to **One User**)

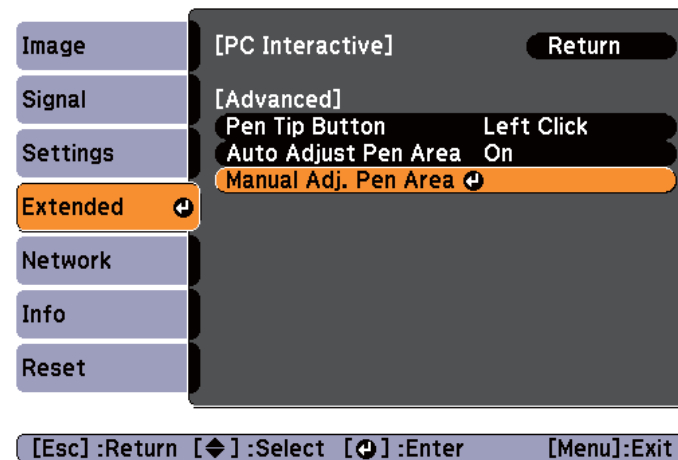

Adjusting the Pen Operation Area

When using the interactive function by connecting to a computer, the pen operation area is automatically adjusted if the resolution of the computer changes. You do not need to perform pen alignment again.

- 

You can turn this function On or Off in **Auto Adjust Pen Area** from the configuration menu. The default setting is On.

 -  **Extended - Easy Interactive Function - Advanced** p.144

If you notice the Easy Interactive Pen is out of position even when **Auto Adjust Pen Area** is set to On, you can try Manual Adj. Pen Area.

 "Manual Adjust Pen Area" p.87

Manual Adjust Pen Area

1 Select **Manual Adj. Pen Area** for **Easy Interactive Function** from the configuration menu.

- 
 - Adjust to fit the projected image within the screen.
 - Display the computer's desktop screen so that you can check the position of the mouse pointer easily.

2 Use the [] button on the remote control to select "Yes".

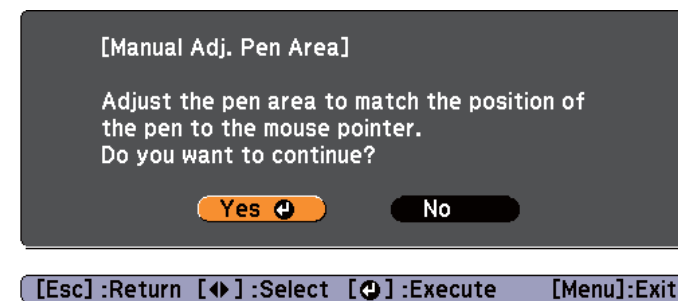

The mouse pointer moves towards the top left.

3 When the mouse pointer stops at the top left, touch the tip of the mouse pointer with the Easy Interactive Pen. The mouse pointer moves towards the bottom right.



- 4 When the mouse pointer stops at the bottom right, touch the tip of the mouse pointer with the Easy Interactive Pen.



Useful Functions

This chapter explains useful functions for giving presentations and so on, and the security functions.

Projecting Two Images Simultaneously (Split Screen)

You can simultaneously project images from two sources on the right and left of the screen.

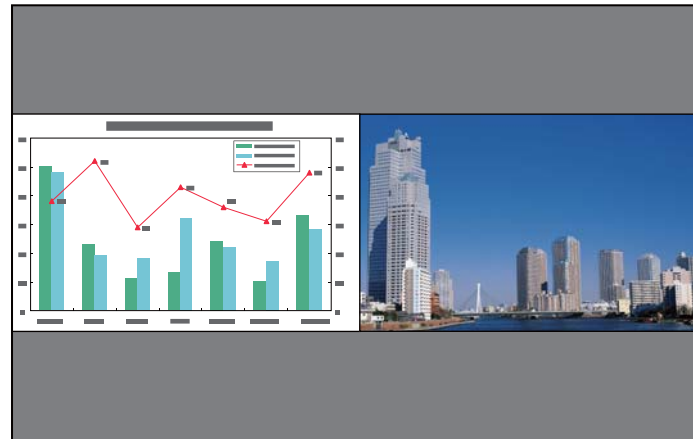

Input sources for split screen projection

The combinations of input sources that can be projected on a split screen are listed below.

Left Screen	Right Screen								
	Computer	DisplayPort	Video	HDMI	USB Display	USB1	USB2	LAN	Whiteboard
Computer	-	✓	✓	✓	✓	✓	✓	✓	-
DisplayPort	✓	-	✓	-	✓	✓	✓	✓	-
Video	✓	✓	-	✓	✓	✓	✓	✓	-
HDMI	✓	-	✓	-	✓	✓	✓	✓	-
USB Display	✓	✓	✓	✓	-	-	-	-	-

Left Screen	Right Screen								
	Computer	DisplayPort	Video	HDMI	USB Display	USB1	USB2	LAN	Whiteboard
USB1	✓	✓	✓	✓	-	-	-	-	-
USB2	✓	✓	✓	✓	-	-	-	-	-
LAN	✓	✓	✓	✓	-	-	-	-	-
Whiteboard	-	-	-	-	-	-	-	-	-

Operating procedures

Projecting on a split screen

- 1 Press the [Split] button while projecting.
The currently selected input source is projected on the left of the screen.

Remote control

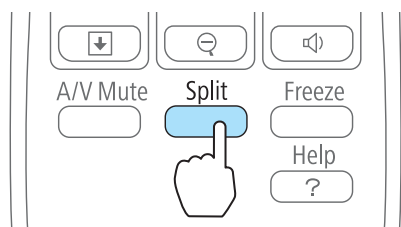

 You can perform the same operations from the configuration menu.

 [Settings - Split Screen p.142](#)

- 2 Press the [Menu] button.
The Split Screen Setup screen is displayed.

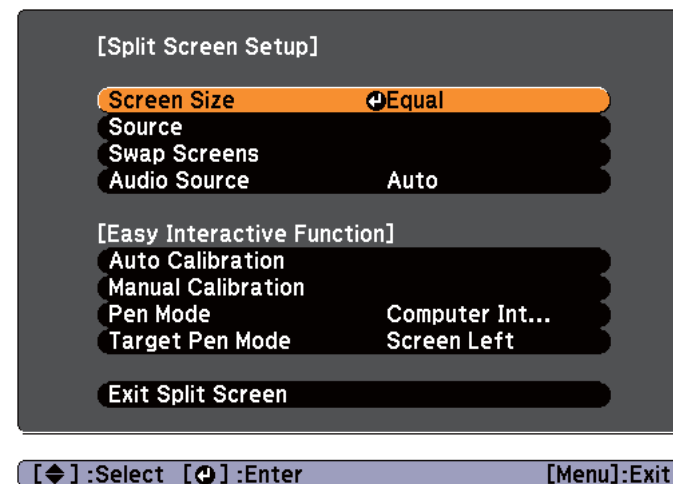

- 3 Select the **Source**, and then press the [] button.
- 4 Select each input source for **Left** and **Right**.

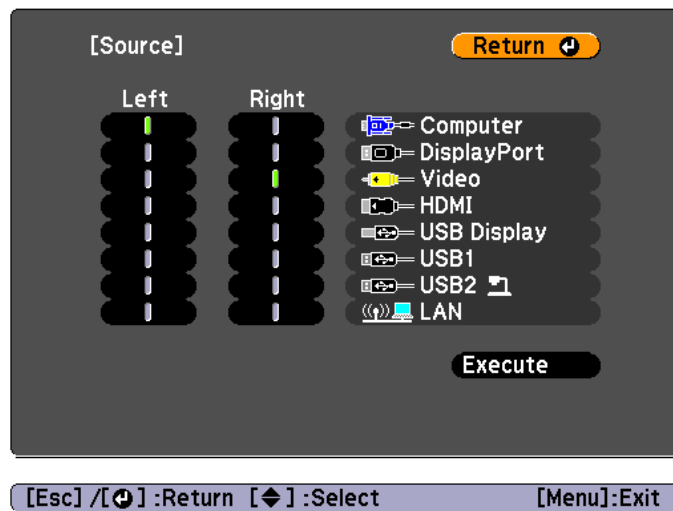

Only input sources that can be combined can be selected.

☛ "Input sources for split screen projection" p.90



The Source screen is also displayed when the [Source Search] button is pressed during split screen projection.

- 5 Select **Execute**, and then press the [↵] button.
To switch the source during split screen projection, start the procedure from step 2.

Switching the left and right screens

Use the following procedure to switch the projected images displayed on the left and right screens.

- 1 Press the [Menu] button during split screen projection.

- 2 Select **Swap Screens**, and then press the [↵] button.
The projected images on the left and right are swapped.



Switching the left and right image sizes

- 1 Press the [Menu] button during split screen projection.
- 2 Select **Screen Size**, and then press the [↵] button.
- 3 Select the screen size you want to display, and then press the [↵] button.

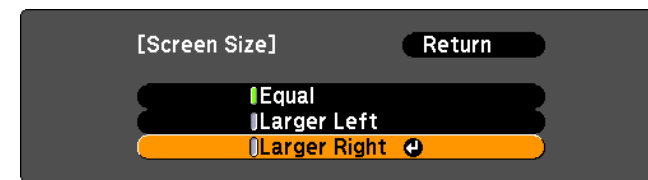

The projected images will appear as shown below after setting the screen size.

Equal

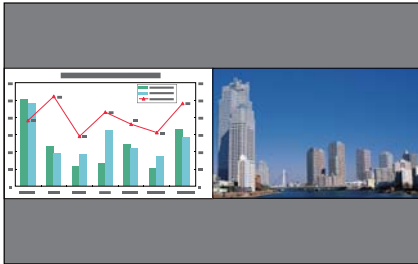

Larger Left

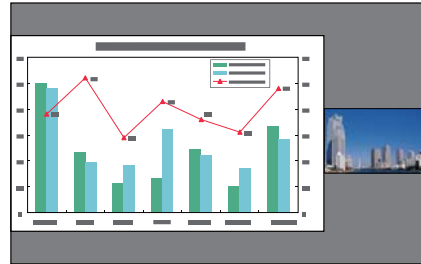

Larger Right

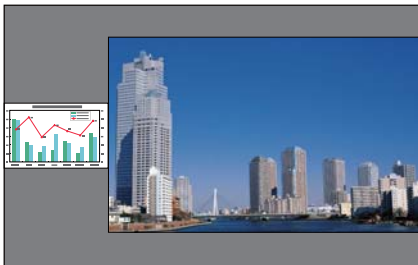

- You cannot enlarge both the left screen and right screen images at the same time.
- When one image is enlarged, the other image is reduced.
- Depending on the video signals that are input, the images on the left and right may not appear to be the same size even if **Equal** is set.

Ending the split screen

Press the [Esc] button to end split screen.

The following steps can also be used to end the split screen.

- Press the [Split] button on the remote control.
- Select **Exit Split Screen** from the configuration menu.
 **Settings - Split Screen - Split Screen Setup** [p.142](#)

When using the interactive function

You can use the following interactive functions during split screen projection.

- PC Free Annotation
 - PC Interactive
 - Interactive functions over a network
- Whiteboard Mode is not supported.
-  "Interactive Function" [p.62](#)

Using PC Free Annotation

Set the whole screen as the target for PC Free Annotation.

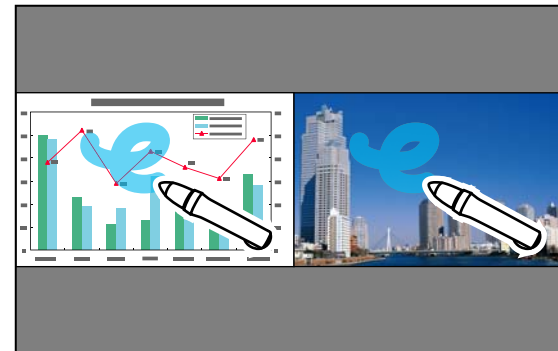

You can use all input sources except for Whiteboard.

In the following example, we will make settings for the screen on the right. You can set the screen on the left in the same way.

- 1** Display the Split Screen Setup screen.
☛ "Projecting on a split screen" [p.91](#)
- 2** Set **Screen Right** as the **Target Pen Mode**.
- 3** In **Source**, set the source that you want to use for the screen on the right.
- 4** Set the **Pen Mode** for the source set in step 3 as **PC Free Annotation**.

Using PC Interactive

Set one of the split screens as the target for PC Interactive.

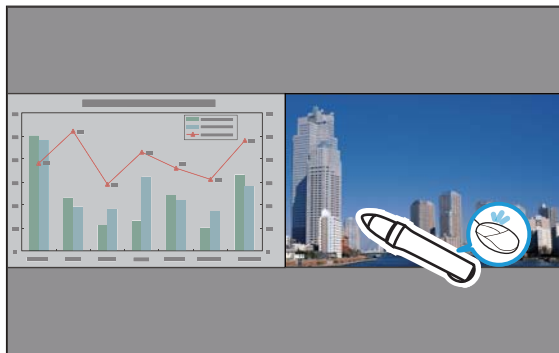

The available sources are Computer, DisplayPort, HDMI, USB Display, and LAN.

In the following example, we will make settings for the screen on the right. You can set the screen on the left in the same way.

- 1** Display the Split Screen Setup screen.
☛ "Projecting on a split screen" [p.91](#)
- 2** Set **Screen Right** as the **Target Pen Mode**.

- 3** In **Source**, set the source that you want to use for the screen on the right.
- 4** Set the **Pen Mode** for the source set in step 3 as **PC Interactive**.

Using the interactive function over a network

Set one of the split screens as the target for the interactive function.

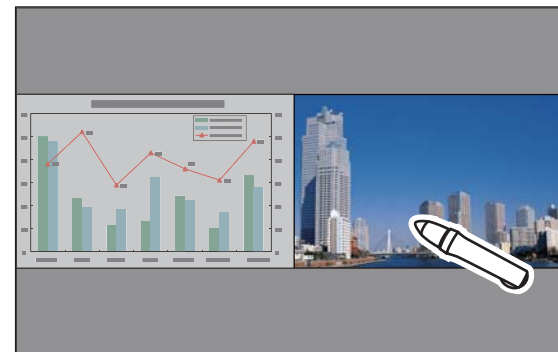

The available source is LAN.

In the following example, we will make settings for the screen on the right. You can set the screen on the left in the same way.

- 1** Display the Split Screen Setup screen.
☛ "Projecting on a split screen" [p.91](#)
- 2** Set **Screen Right** as the **Target Pen Mode**.
- 3** In **Source**, set **LAN** as the source for **Screen Right**. (You cannot change Pen Mode.)

Restrictions during split screen projection

Operating restrictions

The following operations cannot be performed during split screen projection.

- Setting the configuration menu
- E-Zoom
- Switching the aspect mode (The aspect mode will be set to **Normal**.)
- Operations using the [User] button on the remote control
- Auto Iris

Help can be displayed only when image signals are not input or when an error or warning notification is displayed.

Restrictions relating to images

- The default values for the **Image** menu are applied to the image on the right screen. However, the settings for the image projected on the left screen are applied to the image on the right screen for **Color Mode**, **Abs. Color Temp.**, and **Advanced**.
- The setting value **Off** for **Progressive** and **Noise Reduction** is applied to the image on the right screen.
 - ☛ "Signal Menu" p.140
- When there is no image signal input, the display screen will be the color that is set in Display Background. When **Logo** is selected, the display is **Blue**.
- When A/V Mute is performed, the display is **Black**.

Projecting Images Stored on a USB Storage Device (PC Free)

By connecting a USB storage device such as a USB memory or a USB hard disk to the projector, you can project the files stored on the device without using a computer. This function is called PC Free.

Attention

If you are using a multi-card reader or USB hub, operations may not be performed correctly. Connect directly to the projector or the Control Pad.



- You may not be able to use USB storage devices that incorporate security functions.
- You cannot correct keystone distortion while projecting in PC Free, even if you press the [↖] and [↗] buttons on the control panel.

Specifications for files that can be projected using PC Free

Type	File Type (Extension)	Notes
Scenario file	.fse .sit*	This is the file format created by converting PowerPoint files using EasyMP Slide Converter so that they can be played by PC Free. In this Guide these files are known as scenarios.

Type	File Type (Extension)	Notes
Image	.jpg	The following cannot be projected. <ul style="list-style-type: none"> • Images with a resolution greater than 8192 x 8192 • Images with a file size greater than 12 MB • Files with the extension ".jpeg" • CMYK color mode formats • Progressive formats Due to the characteristics of JPEG files, images may not be projected clearly if the compression ratio is too high.
	.bmp	Cannot project images with a resolution greater than 2048 x 2048.
	.gif	<ul style="list-style-type: none"> • Cannot project images with a resolution greater than 2048 x 2048. • Cannot project animated GIFs.
	.png	Cannot project images with a resolution greater than 2048 x 2048.
PDF	.pdf	<ul style="list-style-type: none"> • You can project PDF files version 1.7 or earlier. • Cannot project encrypted PDFs.

* You can also project scenarios (SIT files) created using the application software EMP SlideMaker and EMP SlideMaker2.

See the following for more information on projecting each file type.

- Projecting scenario files
 - ☛ "Playing a scenario" [p.103](#)
- Projecting image files
 - ☛ "Projecting the selected images or movies" [p.99](#)
- Projecting PDF files
 - ☛ "Projecting PDF files" [p.100](#)

Supported movie files

File Type (Extension)	Movie Codec	Audio Codec	Recording Quality
.mpg*	MPEG-2	MPEG-1 Layer1/2 MPEG contents with no sound can be played back. Linear PCM and AC-3 audio cannot be played back.	Maximum bit rate: 12 Mbps Maximum resolution: 1280×720
.mp4*	MPEG-4 ASP MPEG-4 AVC	MPEG-4 AAC-LC	
.wmv	WMV9	WMA	
.avi	Motion JPEG	Linear PCM ADPCM	

* Files with the extension .mpeg cannot be projected.

See the following for more information on projecting movie files.

☛ "Projecting the selected images or movies" [p.99](#)



- You may not be able to use USB storage devices that incorporate security functions.
- Files to which DRM (Digital Rights Management) is applied cannot be projected.
- If you use a USB storage device with a slow access speed when playing back movies (when transmitting at higher bit rates), the movie files may not playback correctly, or the sound may skip or not be output.
- The projector does not support media formatted on some file systems. If you have trouble when projecting, use media formatted under Windows.
- Format the media in FAT16/32.

PC Free examples

Projecting images and movies stored on a USB storage device



You can use PC Free to project individual movie or image files or to continuously project Slideshow using more than one file.

- ☛ "Projecting the selected images or movies" [p.99](#)
- ☛ "Projecting image files in a folder in sequence (Slideshow)" [p.102](#)

Project PowerPoint files converted using EasyMP Slide Converter

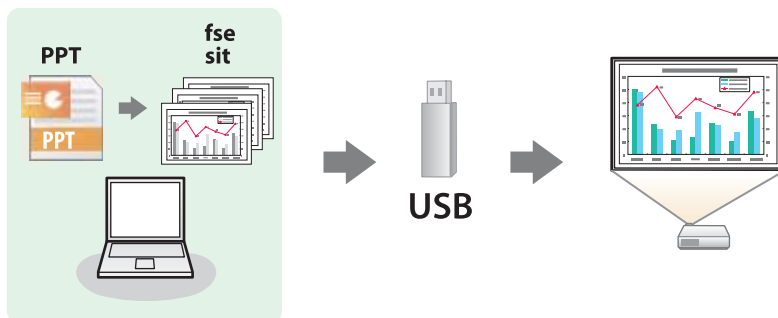

See the following for more information on converting PowerPoint files to scenarios using EasyMP Slide Converter.

- ☛ [EasyMP Slide Converter Operation Guide](#)















PC Free operating methods

The following steps are explained using the remote control as an example, when the USB storage device is connected to the Control Pad. USB storage devices can also be connected directly to the projector. You can also perform remote control operations from the projector's control panel.

Starting PC Free

- 1** Change the source to USB1.
 - ☛ "Automatically Detect Input Signals and Change the Projected Image (Source Search)" [p.47](#)
- 2** Connect the USB storage device or digital camera to the Control Pad.
 - ☛ "Connecting to the Control Pad" [p.41](#)
 - PC Free starts and the file list screen is displayed.
 - The following files are displayed as thumbnails (file contents are displayed as small images).
 - JPEG files
 - FSE/SIT files (an image of the first slide)
 - PDF files (an image of the first page of the PDF)
 - MPEG/WMV/AVI files (an image 15 seconds from the start of the movie)

- Other files or folders are displayed as icons as shown in the following table.

Icon	File	Icon	File
	FSE files*		MPEG files
	SIT files*		WMV files
	JPEG files*		PFX files (Client Certificate/Web Server Certificate)
	BMP files		P12 files (Client Certificate/Web Server Certificate)
	GIF files		CER files (CA certificate)
	PNG files		DER files (CA certificate)
	AVI (Motion JPEG) files*		PEM files (CA certificate)
	PDF files*		

* When it cannot be displayed as a thumbnail, it is displayed as an icon.



- When AutoRun is set for a scenario, it is automatically played back with the highest priority over other input sources. To stop playback, press the [Esc] button on the remote control.
 - "Operations while playing a scenario" [p.103](#)
- You can also insert a memory card into a USB card reader and then connect the reader to the projector. However, some commercially available USB card readers may not be compatible with the projector.
- If the following screen (Select Drive screen) is displayed, press the [A], [V], [L], or [R] button to select the drive you want to use, and then press the [Enter] button.

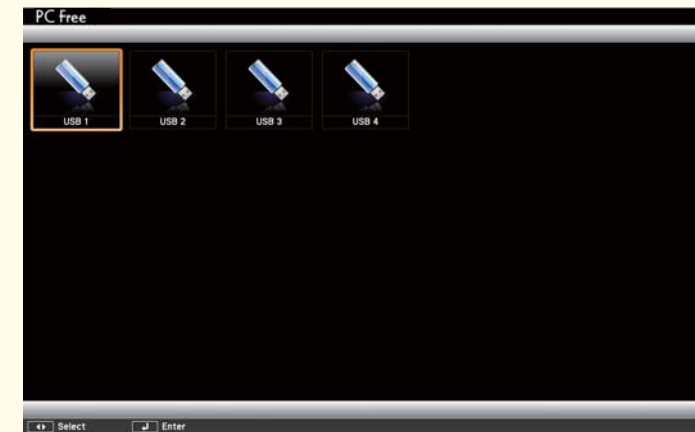

- You can display the Select Drive screen by positioning the cursor on **Select Drive** at the top of the file list screen, and then press the [Enter] button.
- The projector can recognize up to eight media at a time.

Projecting images

- 1 Use the [A], [V], [L], and [R] buttons to select the file or folder you want to project.



If not all of the files and folders are displayed on the current screen, press the [↓] button on the remote control, or position the cursor on **Next Page** at the bottom of the screen and press the [↵] button.

To return to the previous screen, press the [↑] button on the remote control, or position the cursor on **Previous Page** at the top of the screen and press the [↵] button.

2 Press the [↵] button.

The selected image is displayed.

When a folder is selected, the files in the selected folder are displayed. To return to the screen which was displayed before opening the folder, position the cursor on **Back to Top** and press the [↵] button.

Rotating images

You can rotate the image in 90° increments when projecting an image file with PC Free.

- 1 Display images or run PC Free.
- 2 While projecting, press the [▲] or [▼] button.

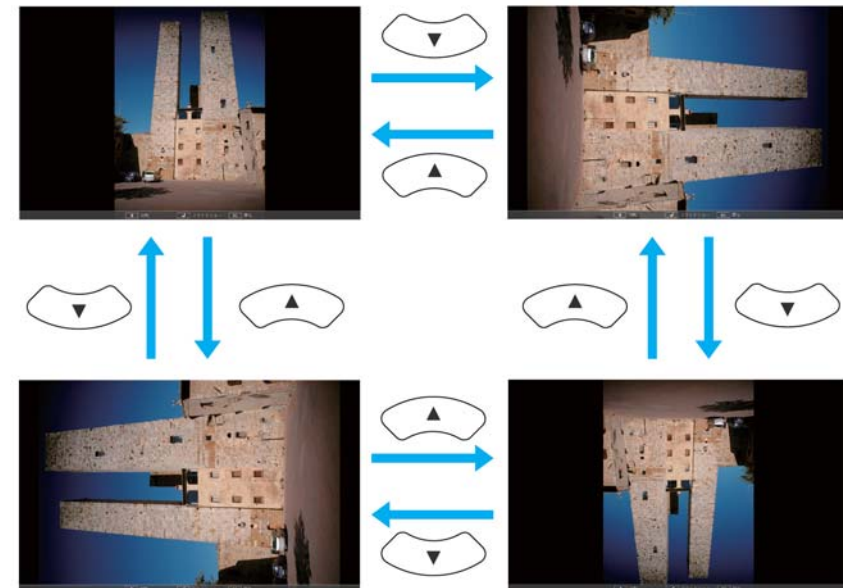

Stopping PC Free

To close PC Free, disconnect the USB device from the USB port on the Control Pad. For devices such as digital cameras or hard disks, turn off the device and then remove it from the projector.

Projecting the selected images or movies

Attention

Do not disconnect the USB storage device while it is being accessed. PC Free may not operate correctly.

- 1** Start PC Free.
The file list screen is displayed.
☛ "Starting PC Free" p.97
- 2** Press the [⏪], [⏩], [⏴], and [⏵] buttons to select the image file you want to project.



- 3** Press the [↵] button.
The image is displayed or the movie is played back.



Press the [⏴] or [⏵] buttons to move to the next or previous image file.

- 4** To finish projecting, perform one of the following operations.
 - Projecting an image: Press the [Esc] button.
 - Projecting a movie: Press the [Esc] button to display the message screen, select **Exit**, and then press the [↵] button.
 When projection is finished, you are returned to the file list screen.

Projecting PDF files

You can project PDF files using PC Free. In PDF files, you can move pages up or down, enlarge, or rotate.

- 1** Start PC Free.
The file list screen is displayed.
☛ "Starting PC Free" p.97
- 2** Press the [⏪], [⏩], [⏴], or [⏵] button to select the PDF file you want to project.





If the file extension is not .pdf, the file is not displayed in the file list.

3 Press the [↵] button.

The first page in the PDF file is displayed at full screen size.



You can perform the following operations while a PDF file is displayed.

- Page Up/Down

While a page is displayed at full screen size, press the [⏪] or [⏩] button to go to the previous or next page.

- Selecting a page

Press the [Esc] button to display the select page menu.



Select the page you want to project using the [⏪] or [⏩] button, and then press the [↵] button to display the selected page.

If you press the [Esc] button while the select page menu is displayed, the menu closes.

- Expanding a page

While a page is displayed at full screen size, press the [↵] button to expand the image.

Portrait pages are expanded horizontally to fit the width of the screen, and landscape pages are expanded vertically to fit the height of the screen.

While a page is displayed at expanded size, press the [↵] button to return to standard full screen size display.

- Scrolling a page

While a page is displayed at expanded size, press the [⏪][⏩][⏪][⏩] button to scroll the page.

- Rotating a page

While a page is displayed at full screen size, press the [◀] or [▶] button to rotate all pages in the PDF by 90 degrees.

Closing PDF file display

1 Press the [Esc] button while a PDF file is being displayed.
The select page menu is displayed.

2 Press the [▲] or [▼] button, and then select **Exit**.



3 Press the [↵] button.
The PDF file being displayed closes and the file select screen is displayed.



The following operations cannot be performed while viewing a PDF in PC Free.

- Releasing a password
- Displaying e-signatures
- Displaying transparent effects
- Playing multi media contents
- Displaying 3D artwork
- Displaying comments

Projecting image files in a folder in sequence (Slideshow)

You can project the image files in a folder in sequence, one at a time. This function is called Slideshow. Use the following procedure to run Slideshow.



You can set display conditions, such as projecting repeatedly and adding display effects while switching between files. To change movie or image files automatically when you run Slideshow, set **Screen Switching Time** from the Option screen in PC Free to anything other than **No**. The default setting is **No**.

☞ "Image file display settings and Slideshow operation settings"
[p.104](#)

1 Start PC Free.
☞ "Starting PC Free" [p.97](#)
The file list screen is displayed.

2 Use the [▲], [▼], [◀], and [▶] buttons to position the cursor on the folder you want to run the Slideshow, and then press the [↵] button.

- 3 Select **Slideshow** at the bottom of the file list screen, and then press the [↵] button.

Slideshow starts, and the image and movie files in the folder are automatically projected in sequence, one at a time.

When the last file is projected, the file list is displayed again automatically. If you set **Continuous Play** to **On** in the Option screen, projection starts again from the beginning when it reaches the end.

☛ "Image file display settings and Slideshow operation settings" p.104

You can proceed to the next screen, return to the previous screen, or stop playback while projecting a Slideshow.



If **Screen Switching Time** on the Option screen is set to **No**, files do not change automatically when you select Play Slideshow. Press the [⏪] button, the [↵] button, or the [⏩] button to continue to the next file.

Playing a scenario

- 1 Start PC Free.
☛ "Starting PC Free" p.97
The file list screen is displayed.
- 2 Press the [⏪], [⏩], [⏴], or [⏵] button to select the scenario you want to playback.
- 3 Press the [↵] button.
Playback starts.

Operations while playing a scenario

You can perform the following operations using the remote control while playing a scenario.

To switch screens

FSE files

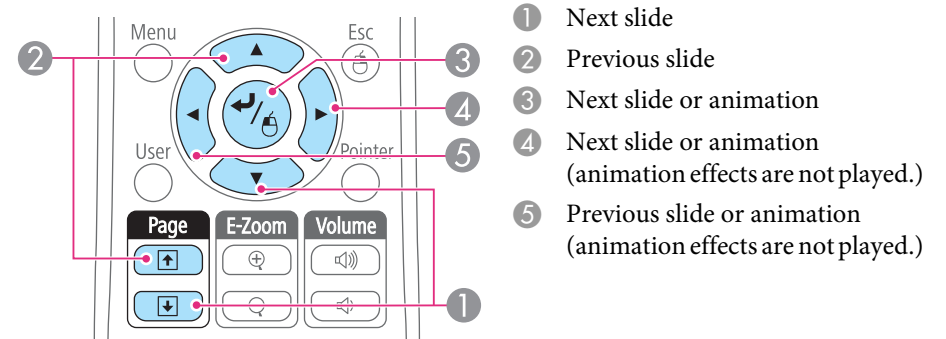

- 1 Next slide
- 2 Previous slide
- 3 Next slide or animation
- 4 Next slide or animation (animation effects are not played.)
- 5 Previous slide or animation (animation effects are not played.)

SIT files

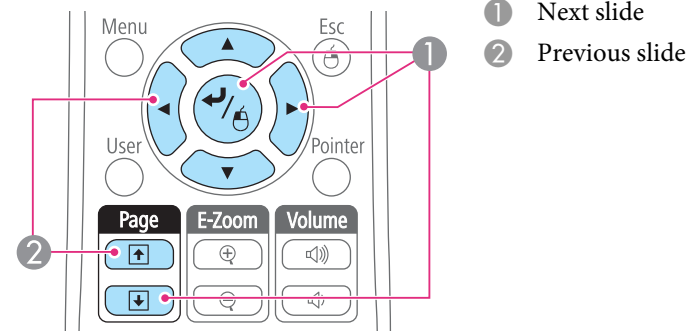

- 1 Next slide
- 2 Previous slide

To stop playback

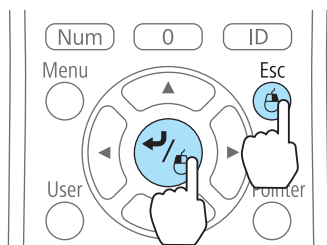

When you press the [Esc] button, the message "Do you want to quit playing the scenario?" is displayed. Select **Exit**, and then press the [↵] button to stop playback.

Select **Return**, and then press the [↵] button to continue playing the file.

You can use the following functions when projecting a file with PC Free.

- Freeze
 ☛ "Freezing the Image (Freeze)" [p.105](#)
- A/V Mute
 ☛ "Hiding the Image and Sound Temporarily (A/V Mute)" [p.105](#)
- E-Zoom
 ☛ "Enlarging Part of the Image (E-Zoom)" [p.107](#)
- Pointer
 ☛ "Pointer Function (Pointer)" [p.105](#)

Image file display settings and Slideshow operation settings

You can set the file display order and Slideshow operations on the Option screen.

- 1** Select **Option** at the bottom of the file list screen, and then press the [↵] button.
- 2** When the Option screen is displayed, set each of the items. Enable the settings by positioning the cursor on the target item and pressing the [↵] button.

The following table shows the details for each item.

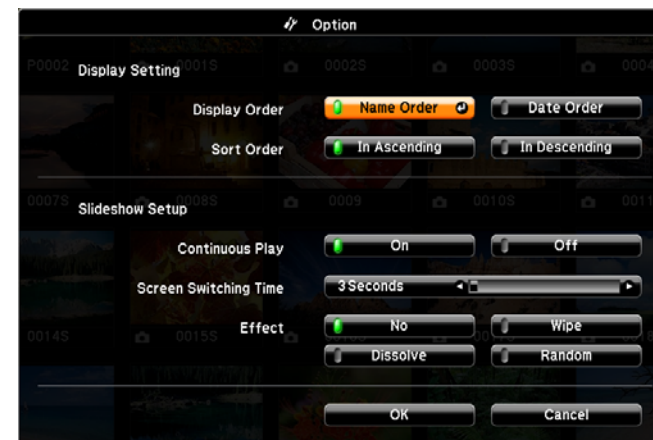

Display Order	You can select to display the files in Name Order or Date Order .
Sort Order	You can select to sort the files In Ascending or In Descending order.
Continuous Play	You can set whether to repeat the Slideshow.
Screen Switching Time	You can set the time for a single file to be displayed in Play Slideshow. You can set a time between No (0) to 60 Seconds. When you set No , auto play is disabled.
Effect	You can set the screen effects when changing slides.

- 3** Use the [⏪], [⏩], [⏴], and [⏵] buttons to position the cursor over **OK**, and then press the [↵] button.

The settings are applied.

If you do not want to apply the settings, position the cursor on **Cancel**, and then press the [↵] button.

Hiding the Image and Sound Temporarily (A/V Mute)

You can switch off the image on the screen when you want to focus the audience's attention on what you are saying, or when you do not want to display operations such as changing files.

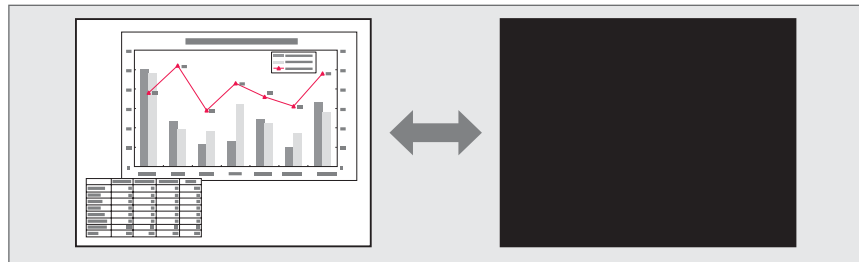

Each time you press the [A/V Mute] button, A/V Mute turns on or off.

Remote control

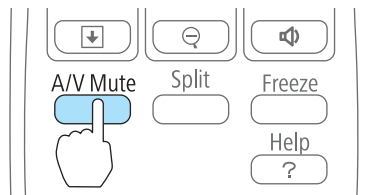

- If you use this function when projecting moving images, the images and sound continue to be played back by the source, and you cannot return to the point where A/V Mute was activated.
- You can select the screen displayed when the [A/V Mute] button is pressed from the Configuration menu.
 - ☛ **Extended - Display - A/V Mute** [p.144](#)
- The lamp is still lit during A/V Mute, so the lamp hours continue to accumulate.

Freezing the Image (Freeze)

When Freeze is activated on moving images, the frozen image continues to project on the screen, so you can project a moving image one frame at a time like a still photo. Also, you can perform operations such as changing between files during presentations from a computer without projecting any images if the Freeze function is activated beforehand.

Each time you press the [Freeze] button, Freeze turns on or off.

Remote control

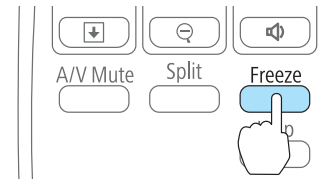

- Audio does not stop.
- For moving images, the images continue to play back while the screen is frozen, so it is not possible to resume projection from the point where the screen was frozen.
- If the [Freeze] button is pressed while the Configuration menu or the Help screen is displayed, the menu or the Help screen that is displayed is closed.
- Freeze still works while E-Zoom is being used.

Pointer Function (Pointer)

This allows you to move a pointer icon on the projected image, and helps you draw attention to the area you are talking about.

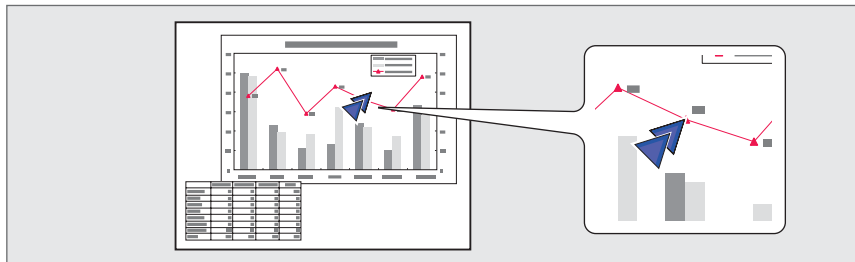

You can select the shape of the pointer icon from the Configuration menu.

☛ **Settings - Pointer Shape** [p.142](#)

1 Display the Pointer.

Each time you press the [Pointer] button, the pointer appears or disappears.

Remote control

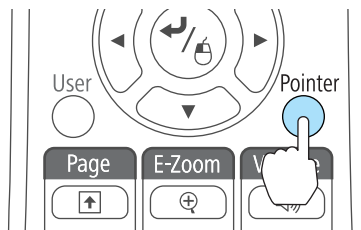

2 Move the Pointer icon (↗).

Remote control

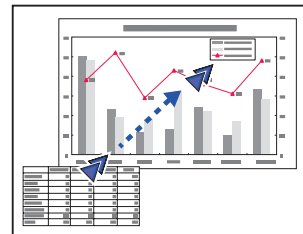
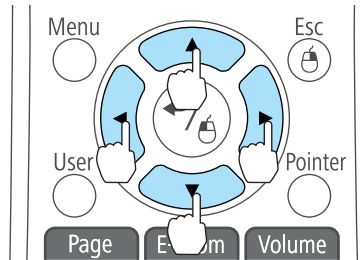

When any pair of adjacent [↖], [↗], [↘], or [↙] buttons are pressed at the same time, the pointer can be moved diagonally.

Enlarging Part of the Image (E-Zoom)

This is useful when you want to expand images to see them in greater detail, such as graphs and tables.

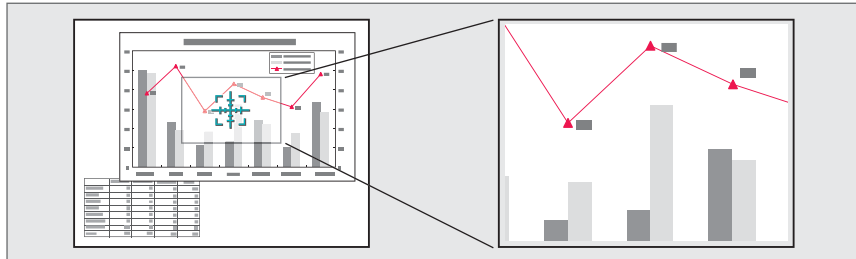

1 Start E-Zoom.

Press the [⊕] button to display the Cross (⊕).

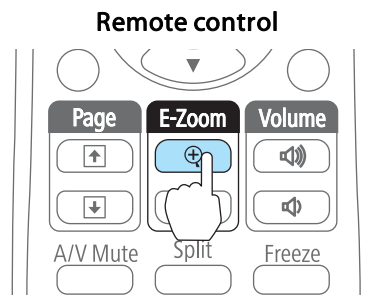

2 Move the Cross (⊕) to the area of the image that you want to enlarge.

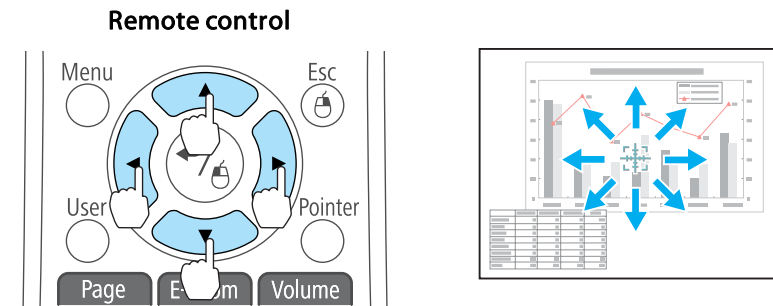

When any pair of adjacent [⬆], [⬇], [⬅], or [➤] buttons are pressed at the same time, the pointer can be moved diagonally.

3 Enlarge.

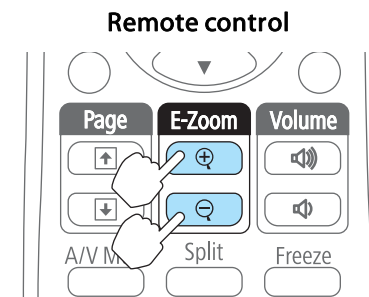

[⊕] button: Expands the area each time it is pressed. You can expand quickly by holding the button down.

[⊖] button: Reduces images that have been enlarged.

[Esc] button: Cancels E-Zoom.



- The enlargement ratio appears on the screen. The selected area can be enlarged to between 1 to 4 times in 25 incremental steps.
- During enlarged projection, press the [⬆], [⬇], [⬅], and [➤] buttons to scroll the image.

Using the Remote Control to Operate the Mouse Pointer (Wireless Mouse)

You can control the computer's mouse pointer from the projector's remote control. This function is called Wireless Mouse.

The following operating systems support the wireless mouse function.

OS	Windows	Mac OS X
	Windows 98	Mac OS X 10.3.x
	Windows 98SE	Mac OS X 10.4.x
	Windows Me	Mac OS X 10.5.x
	Windows 2000	Mac OS X 10.6.x
	Windows XP	Mac OS X 10.7.x
	Windows Vista	
	Windows 7	

* It may not be possible to use the Wireless Mouse function under some versions of the operating systems.

Use the following procedure to enable the Wireless Mouse function.

- 1** Set **USB Type B** to **Wireless Mouse/USB Display** from the configuration menu.
 - **Extended - USB Type B** [p.144](#)
- 2** Connect the projector to the computer with the supplied USB cable.
 - "Connecting a computer" [p.31](#)
- 3** Change the source to one of the following.
 - USB Display
 - Computer
 - HDMI

- DisplayPort

- "Automatically Detect Input Signals and Change the Projected Image (Source Search)" [p.47](#)

Once set, the mouse pointer can be controlled as follows.

Moving the mouse pointer

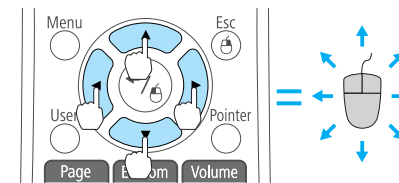

[Left Arrow] [Right Arrow] [Up Arrow] [Down Arrow] buttons:

Moves the mouse pointer.

Mouse clicks

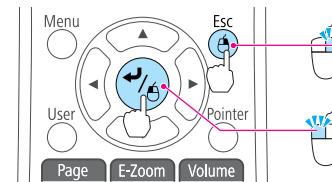

[Esc] button: Right click.

[Left Arrow] button: Left click. Press quickly twice to double-click.

Drag and drop

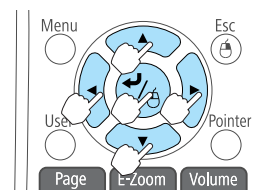

While holding down the [Left Arrow] button, press the [Left Arrow], [Right Arrow], [Up Arrow], or [Down Arrow] button to drag.

Release the [Left Arrow] button to drop at the desired location.

Page Up/Down

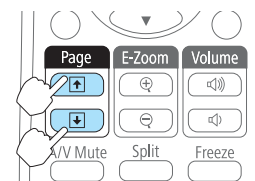

[Up Arrow] button: Moves to the previous page.

[Down Arrow] button: Moves to the next page.



- When any pair of adjacent [▲], [▼], [◀], or [▶] buttons are pressed at the same time, the pointer can be moved diagonally.
- If the mouse button settings are set to reverse on the computer, the operation of the remote control buttons will also be reversed.
- The Wireless Mouse function does not work under the following conditions.
 - When **Extended - USB Type B** is set to anything other than **Wireless Mouse/USB Display**.
 - When displaying the configuration menu or help.
 - When operating functions other than the Wireless Mouse function (such as adjusting the volume).
 However, when using the E-Zoom or Pointer function, the page up or down function is available.

Saving a User's Logo

You can save the image that is currently being projected as a User's Logo. You can use the registered user's logo as a display when projection starts or no image signal is being input.

☛ **Extended - Display** p.144



Once a User Logo has been saved, the logo cannot be returned to the factory default.

1 Project the image you want to save as the User's Logo, and then press the [Menu] button.

☛ "Using the Configuration Menu" p.136

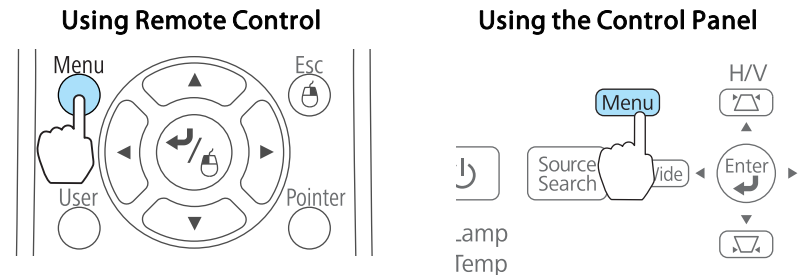

2 Select **User's Logo** from **Extended**.

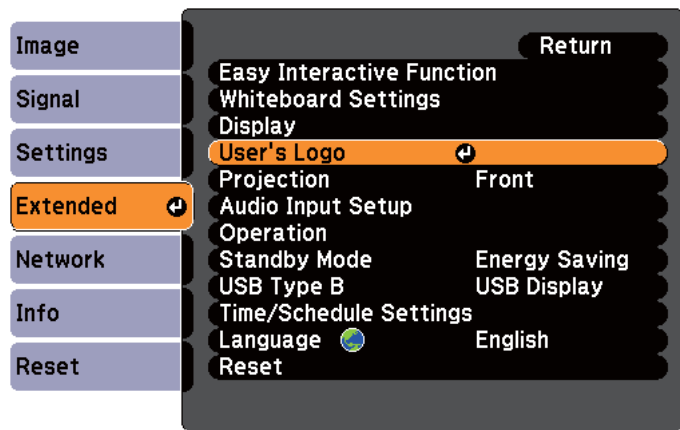

[Esc]:Return [↕]:Select [↵]:Enter [Menu]:Exit



- When **User's Logo Protect** from **Password Protect** is set to **On**, a message is displayed and the User's Logo cannot be changed. You can make changes after setting **User's Logo Protect** to **Off**.
 - ☛ "Managing Users (Password Protect)" p.113
- If **User's Logo** is selected when Keystone, E-Zoom, Aspect, or Adjust Zoom is being performed, the function currently being performed is cancelled.

3 When the message "Choose this image as the User's Logo?" is displayed, select **Yes**.



When you press the [↵] button on the remote control or the control panel, the screen size may change depending on the signal to match the actual resolution of the image signal.

4 Move the box to select the part of the image to use as the User's Logo.

You can perform the same operations from the projector's control panel.

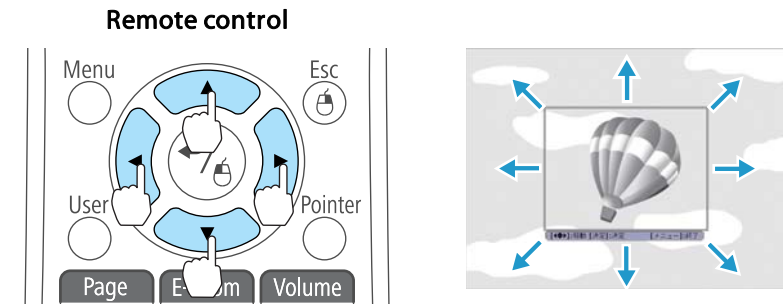

You can save at 400x300 dots in size.

5 When you press the [↵] button and the message "Select this image?" is displayed, select **Yes**.

6 Select the zoom factor from the zoom setting screen.

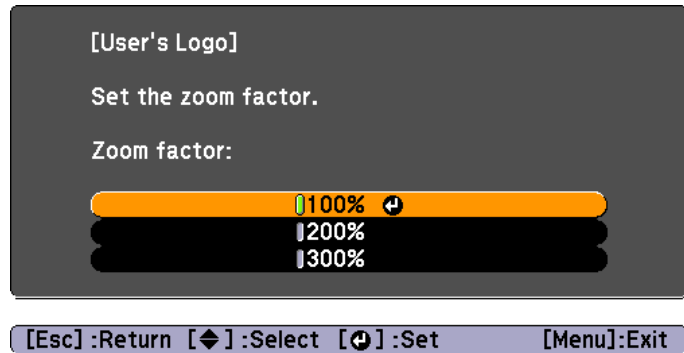

7 When the message "Save this image as the User's Logo?" is displayed, select **Yes**.

The image is saved. After the image has been saved, the message "Completed." is displayed.



- When a User's Logo is saved, the previous User's Logo is erased.
- It takes a while to save. Do not operate the projector or any connected equipment while it is saving, otherwise malfunctions may occur.

Saving User Pattern

There are four types of patterns registered to the projector, such as ruled lines and grid patterns.

☛ **Settings - Pattern - Pattern Type** p.142

You can also save the image that is currently being projected as a User Pattern.



When a User Pattern is saved, the previous User Pattern is erased.

1 Project the image you want to use as the User Pattern, and then press the [Menu] button.

☛ "Using the Configuration Menu" p.136

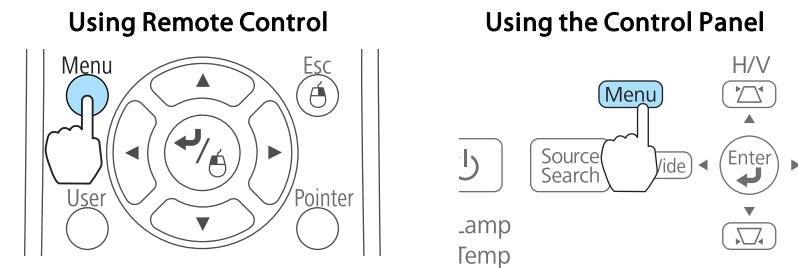

2 Select **Pattern** from **Settings**.

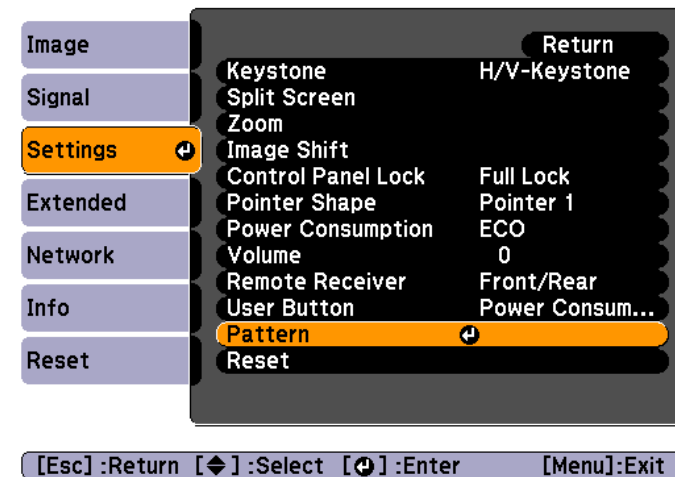

3 Select **User Pattern**.

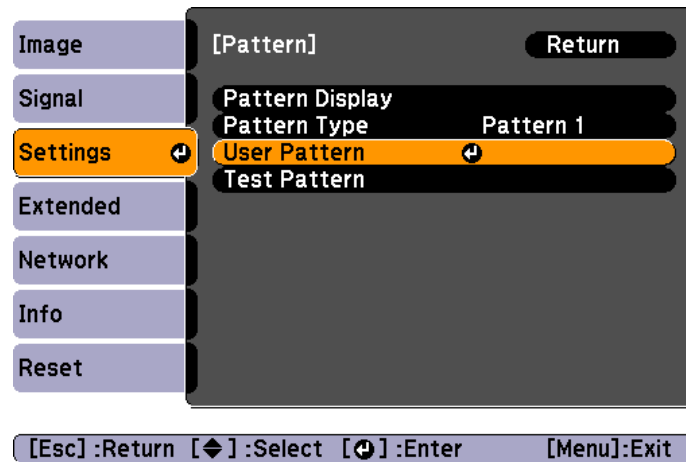

If **User Pattern** is selected when Keystone, E-Zoom, Aspect, Adjust Zoom, or Image Shift are being performed, the function currently being performed is temporarily canceled.

4 When "Do you want to use the currently projected image as the User Pattern?" is displayed, select **Yes**.

5 When you press the [↵] button, the message "Do you save this image as the User Pattern?" is displayed. Select **Yes**.

The image is saved. After the image has been saved, the message "The User Pattern setting is complete." is displayed.



- Once a User Pattern has been saved, User Pattern cannot be returned to the factory default.
- It takes a while to save a User Pattern. Do not operate the projector or any connected equipment while saving the user pattern, otherwise malfunctions may occur.

The projector has the following enhanced security functions.

- **Password Protect**
You can limit who can use the projector.
- **Control Panel Lock**
You can prevent people changing the settings on the projector without permission.
☛ "Restricting Operation (Control Panel Lock)" [p.115](#)
- **Anti-Theft Lock**
The projector is equipped with the following anti-theft security device.
☛ "Anti-Theft Lock" [p.117](#)

Managing Users (Password Protect)

When Password Protect is activated, people who do not know the password cannot use the projector to project images even if the projector power is on. Furthermore, the user's logo that is displayed when you turn on the projector cannot be changed. This acts as an anti-theft device as the projector cannot be used even if it is stolen. At the time of purchase, Password Protect is not activated.

Kinds of Password Protect

The following three kinds of Password Protect settings can be made according to how the projector is being used.

- **Power On Protect**
When **Power On Protect** is **On**, you need to enter a preset password after the projector is plugged in and turned on (this also applies to Direct Power On). If the correct password is not entered, projection does not start.

- **User's Logo Protect**

Even if someone tries to change the User's Logo set by the owner of the projector, it cannot be changed. When **User's Logo Protect** is set to **On**, the following setting changes for the User's Logo are prohibited.

- Capturing a User's Logo
- Setting **Display Background**, **Startup Screen**, or **A/V Mute** from **Display**
☛ **Extended - Display** [p.144](#)

- **Network Protect**

When **Network Protect** is set to **On**, changing the settings for **Network** is prohibited.

- ☛ "Network menu" [p.138](#)

Setting Password Protect

Use the following procedure to set Password Protect.

- 1** During projection, hold down the [Freeze] button for about five seconds.

The Password Protect setting menu is displayed.

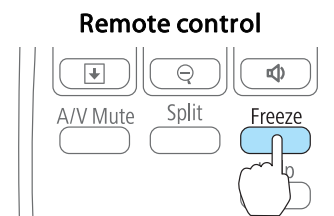



- If Password Protect is already activated, you must enter the password.
If the password is entered correctly, the Password Protect setting menu is displayed.
 - ☞ "Entering the Password" p.114
- When the password is set, stick the supplied password protect sticker in a visible position on the projector as a further theft deterrent.
 - ☞ [Password Protect Sticker](#)

- 2 Select the type of Password Protect you want to set, and then press the [↵] button.

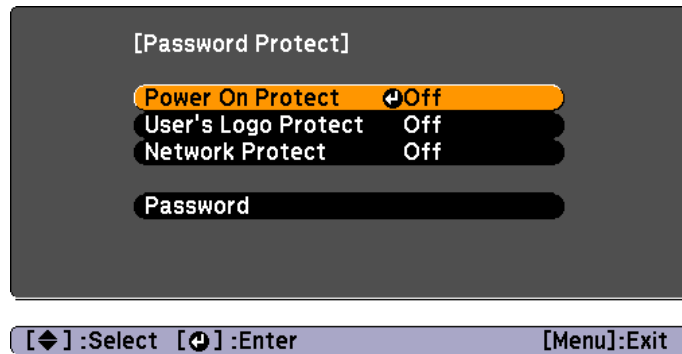

- 3 Select **On**, and then press the [↵] button.
Press the [Esc] button, the screen displayed in step 2 is displayed again.
- 4 Set the password.
 - (1) Select **Password**, and then press the [↵] button.

- (2) When the message "Change the password?" is displayed, select **Yes** and then press the [↵] button. The default password is set to "0000". Change this to your own desired Password. If you select **No**, the screen displayed in step 2 is displayed again.
- (3) While holding down the [Num] button, enter a four digit number using the numeric buttons. The number entered is displayed as "* * * *". When you enter the fourth digit, the confirmation screen is displayed.

Remote control

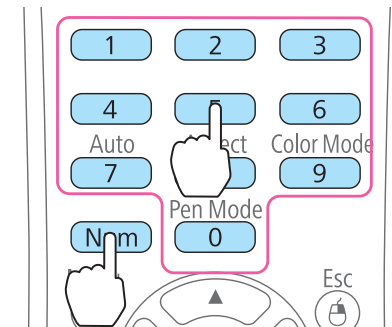

- (4) Re-enter the password.
The message "Password accepted." is displayed.
If you enter the password incorrectly, a message is displayed prompting you to re-enter the password.

Entering the Password

When the password entry screen is displayed, enter the password using the remote control.

While holding down the [Num] button, enter the password by pressing the numeric buttons.

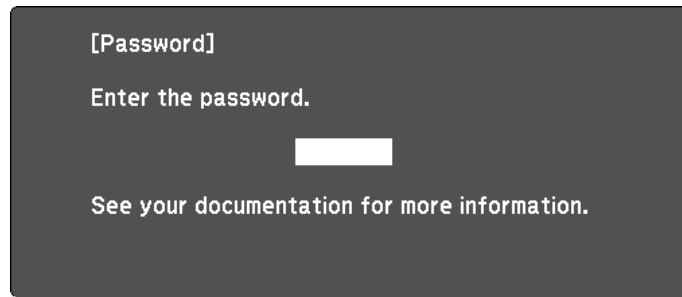

[0-9] :Enter

When you enter the correct password, Password Protect is temporarily released.

Attention

- If an incorrect password is entered three times in succession, the message "The projector's operation will be locked." is displayed for approximately five minutes, and then the projector switches to standby mode. If this happens, disconnect the power plug from the electrical outlet and then reinsert it and turn the projector's power back on. The projector displays the password entry screen again so that you can enter the correct password.
 - ☛ [Epson Projector Contact List](#)
- If you have forgotten the password, make a note of the "**Request Code:** xxxxx" number that appears on the screen and contact the nearest address provided in the Epson Projector Contact List.
 - ☛ [Epson Projector Contact List](#)
- If you continue to repeat the above operation and input the wrong Password 30 times in succession, the following message is displayed and the projector does not accept any more Password entries. "The projector's operation will be locked. Contact Epson as described in your documentation."
 - ☛ [Epson Projector Contact List](#)

Restricting Operation (Control Panel Lock)

Do one of the following to lock the operation buttons on the control panel.

- **Full Lock**
All of the buttons on the control panel are locked. You cannot perform any operations from the control panel, including turning the power on or off.
- **Partial Lock**
All of the buttons on the control panel, except for the [⏻] button, are locked.

This is useful at events or shows when you want to deactivate all buttons during projection or at schools when you want to limit button operation. The projector can still be operated using the remote control.

- 1 Press the [Menu] button while projecting.
 - ☛ "Using the Configuration Menu" [p.136](#)

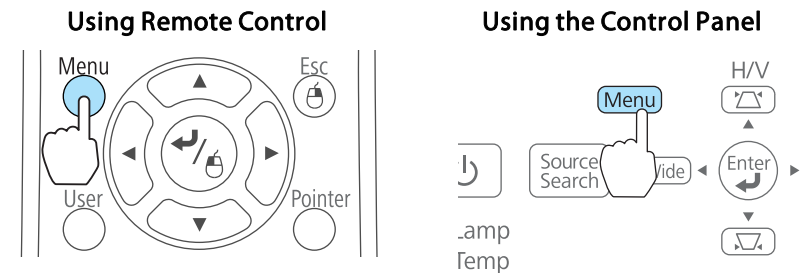

- 2 Select **Control Panel Lock** from **Settings**.

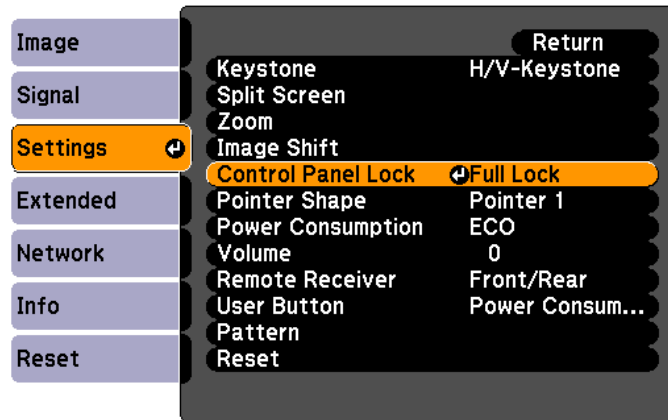

[Esc]:Return [↩]:Select [⏎]:Enter [Menu]:Exit

- 3** Select either **Full Lock** or **Partial Lock** according to your purpose.

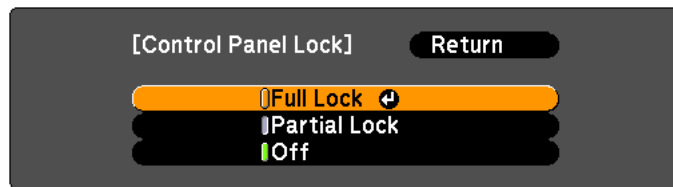

[Esc]:Return [↩]:Select [⏎]:Set [Menu]:Exit

- 4** Select **Yes** when the confirmation message is displayed.
The control panel buttons are locked according to the setting you chose.



You can release the control panel lock by one of the following two methods.

- Select **Off** from **Control Panel Lock**.
 **Settings - Control Panel Lock** p.142
- Press and hold down the [↵] button on the control panel for about seven seconds, a message is displayed and the lock is released.

Anti-Theft Lock

The projector is equipped with the following types of anti-theft security devices.

- Security slot

The security slot is compatible with the Microsaver Security System manufactured by Kensington.

See the following for more details on the Microsaver Security System.

☞ <http://www.kensington.com/>

- Security cable installation point

A commercially available theft-prevention wire lock can be passed through the installation point to secure the projector to a desk or pillar.

Installing the wire lock

Pass an anti-theft wire lock through the installation point.

See the documentation supplied with the wire lock for locking instructions.

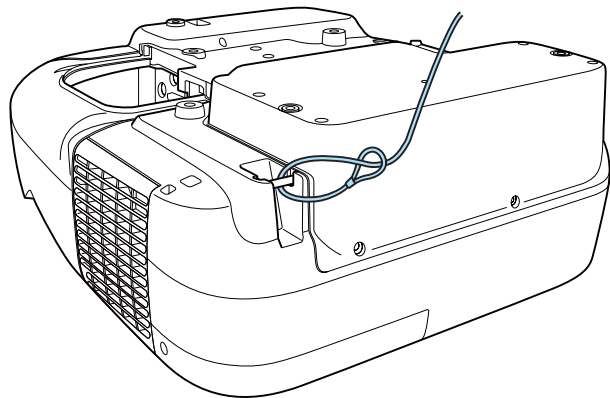

This chapter explains the additional functions for networks.

Using the Interactive Function over a Network

You can use PC Interactive over a network.

☛ "Summary of the Interactive Function" [p.63](#)

You need network applications to use PC Interactive over a network. Install any of the following applications on a computer, and then enable the interactive function setting for each application.

- Easy MP Network Projection Ver.2.81 or later
☛ [EasyMP Network Projection Operation Guide](#)
- Quick Wireless Ver.1.31 or later
☛ Quick Wireless Connection USB Key User's Guide



When using PC Interactive over a network, you need to install an interactive drawing tool on your computer to make annotations. Easy Interactive Tools is supplied with the projector.

☛ [Easy Interactive Tools Ver.2.1 Operation Guide](#)

Starting

Press the [Source Search] button on the remote control, the control panel, or the Control Pad to change the source to LAN.

During split screen projection, change the source for Pen Mode to LAN.

☛ "Projecting Two Images Simultaneously (Split Screen)" [p.90](#)

Restrictions

- You cannot use two Easy Interactive Pens at the same time.

- Whiteboard Mode and PC Free Annotation cannot be used. To use PC Free Annotation with a LAN source, you need to disable the interactive functions for EasyMP Network Projection and Quick Wireless, and then reconnect.
- When using EasyMP Network Projection, you can connect to up to four projectors at the same time. When connected to multiple projectors at the same time, PC Interactive for each projector is united and functions as one PC Interactive function.
- You cannot change Pen Mode from the remote control or the Configuration menu.
- The performance of the Easy Interactive Pen may decline depending on the computer being used, the movie content, and so on.

Projecting with "Connect to a Network Projector"

"Connect to a Network Projector" is a standard function in Windows Vista and Windows 7. You can project images from the computer by detecting the projector on the network only by using a function of the OS without having to install any special software.

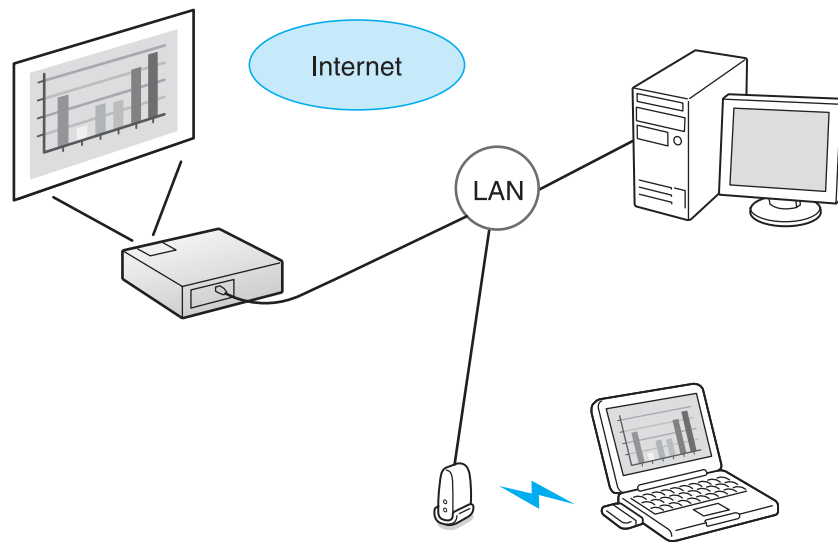

Compatible OS
Windows Vista: Home Premium/Business/Enterprise/Ultimate
Windows 7: Professional/Ultimate

This section provides an easy explanation of "Connect to a Network Projector".

Check that the projector and computer are connected to the network, and perform the following operations.

- 1 Turn on the projector, and change the source to LAN.
 • "Automatically Detect Input Signals and Change the Projected Image (Source Search)" [p.47](#)

- 2 Start the computer, and then click **Start - All Programs - Accessories - Connect to a Network Projector**.

The connection setting screen is displayed.

The projector is identified by inputting its IP address, or by allowing the OS to automatically identify all of the connected projectors.

- 3 Once the OS has identified all of the connected projectors, select the one that you want to use and click **Connect**.

When the projector password screen is displayed, enter the keyword shown at the bottom of the LAN standby screen.

Attention

In Whiteboard Mode, the function to connect to a network projector is disabled. Also, the connection is interrupted if you change to Whiteboard Mode while connected to a network projector.



- You can connect only one projector to a computer.
- When using Network Projector from Options in Windows Meeting Space, set the colors for the computer screen you are using to the highest level (32bit). If it is not capable of a 32bit display, a message is displayed and you cannot connect.

Making a WPS (Wi-Fi Protected Setup) Connection with a Wireless LAN Access Point

There are two methods for setting WPS▶▶.

- Push Button Method

SSID and security are set automatically when you press the [↵] button on the projector's control panel and the dedicated button on the access point equipment. This method is recommended when the projector and access point are close together.

- PIN Code Method

SSID and security are set automatically by inputting an 8-digit code that was assigned to the projector from the computer to the access point in advance. Make connection settings between the computer and the access point in advance. For details on how to make this connection, refer to the manual provided with the access point. This method is recommended when the projector is mounted on the ceiling.



Refer to the documentation for the access point device and to the following section when using any connection method other than WPS.

☞ "Wireless LAN menu" [p.153](#)

Connection setup method

1 Press the [Menu] button.

☞ "Using the Configuration Menu" [p.136](#)

Using Remote Control

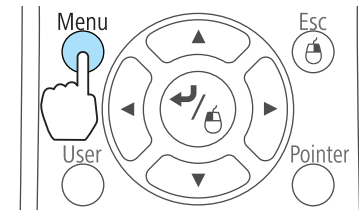

Using the Control Panel

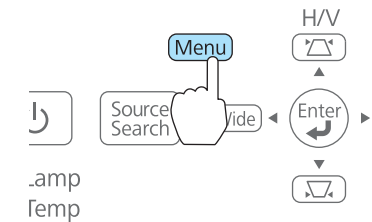

2 Select **Network Configuration** from **Network**.

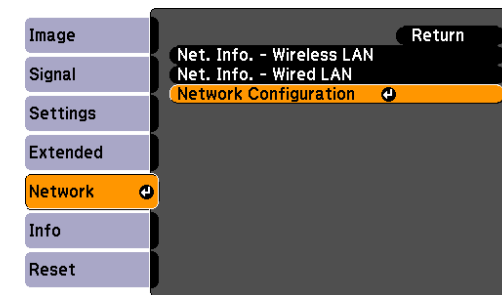

The Network Configuration screen is displayed.

3 Select **To Setup Wizard** from **Wireless LAN**.

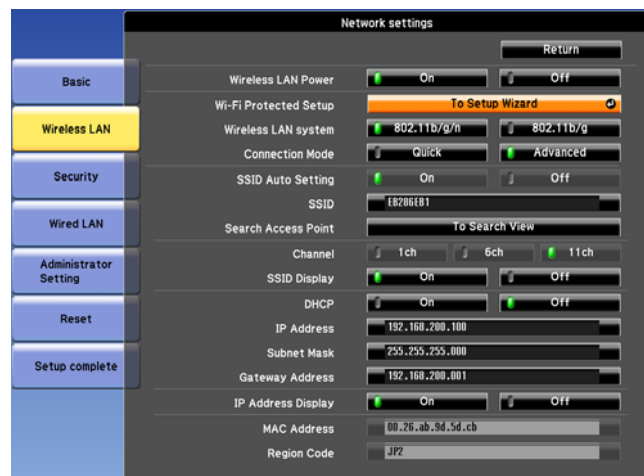

The following screen is displayed.

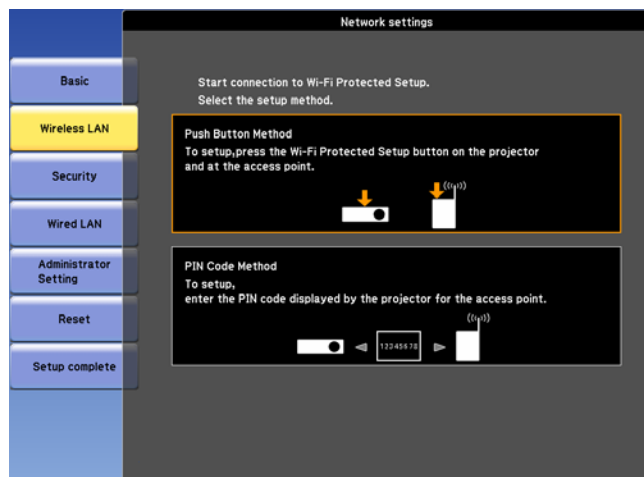

Follow the on-screen instructions.

About EasyMP Monitor

EasyMP Monitor lets you carry out operations such as checking the status of multiple Epson projectors that are connected to a network at a computer monitor, and controlling the projectors from the computer.

You can download EasyMP Monitor from the following Web site.

<http://www.epson.com>

The following provides brief descriptions of the monitoring and control functions that can be carried out using EasyMP Monitor.

- **Registering projectors for monitoring and control**

Projectors on the network can be searched for automatically, and you can then select which projectors you want to register from the projectors that are detected.

You can register target projectors by entering their IP addresses.

- **Registered projectors can also be assigned to groups so that they can be monitored and controlled in groups.**

- **Monitoring the status of registered projectors**

You can check the power status (ON/OFF) for projectors and problems or warnings that require attention by using the icons.

You can select groups of projectors or a single projector and then check the cumulative lamp operating time or information such as input sources, problems, and warnings for the projectors.

- **Controlling registered projectors**

Projectors can be selected in groups or as single projectors, and you can then carry out operations for the selected projectors such as turning the power on and off and switching their input sources.

You can use Web Control functions to change the settings in the projector's configuration menu.

If there are certain control actions which are carried out regularly at particular times or on particular days, you can use Timer Settings to register timer settings.

- **Mail Notification settings**

You can set e-mail addresses to which notifications are sent if a status that requires attention, such as a problem, occurs with a registered projector.

- **Sending messages to registered projectors**

You can use the Message Broadcasting plugin for EasyMP Monitor to send JPEG files to registered projectors.

Download the Message Broadcasting plugin from the Web site address provided at the beginning of this chapter.

Changing Settings Using a Web Browser (Web Control)

By using the Web browser of a computer connected to the projector on a network, you can set the projector's functions and control the projector. This function allows you to perform setup and control operations remotely. In addition, since you can use the computer's keyboard, entering characters required for the setup is easier.

Use Microsoft Internet Explorer 8.0 or later as the Web browser. Use Safari for Mac OS X.



If you set **Standby Mode** to **Networked Standby** or **A/V Standby**, you can use a Web browser to make settings and perform control even if the projector is in standby mode (when the power is off).

☛ **Extended - Standby Mode** [p.144](#)

Projector setup

In a Web browser, you can set items that are usually set in the projector's Configuration menu. The settings are reflected in the Configuration menu. There are also items that can only be set in a Web browser.

Items in the Configuration menu that cannot be set by a Web browser

- Settings menu - Image Shift
- Settings menu - Pointer Shape
- Settings menu - User Button
- Settings menu - Pattern (except Pattern Type)
- Extended menu - Easy Interactive Function
- Extended - Display - Pen Toolbar Tab
- Extended - Display - Pen Mode Icon
- Extended menu - User's Logo
- Extended menu - Operation - High Altitude Mode
- Extended menu - USB Type B
- Extended menu - Language
- Reset menu - Reset All and Reset Lamp Hours

The settings for items on each menu are the same as the projector's Configuration menu.

☛ "Configuration Menu" [p.135](#)

Items that can only be set with a Web browser

Whiteboard Settings menu - Template Settings

Displaying the Web Control screen

Use the following procedure to display the Web Control screen.

Make sure the computer and projector are connected to the network. Set the **Connection Mode** to **Advanced** from the Configuration menu.

☛ **Network - Wireless LAN - Connection Mode** [p.150](#)



If your Web browser is set up to connect via a proxy server, the Web Control screen cannot be displayed. To display Web Control, you need to make settings so that a proxy server is not used for a connection.

- 1** Start a Web browser on the computer.
- 2** Enter the IP address of the projector in the address input box of the Web browser, and press the Enter key on the computer's keyboard.
The Web Control screen is displayed.
When Web Control Password is set in the Network menu from the projector's Configuration menu, the password entry screen is displayed.
- 3** The user ID and password entry screen is displayed.
Enter "**EPSONWEB**" as the user ID.
The default password is "**admin**".



- Enter the user ID even if the password setting is disabled. The user ID cannot be changed.
- You can change the password in Network menu from the Configuration menu.
☛ **Network - Administrator Settings - Web Control Password** [p.138](#)

Displaying the Web Remote screen

The Web Remote function allows you to perform projector remote control operations with a Web browser.

- 1** Display the Web Control screen.
- 2** Click **Web Remote**.

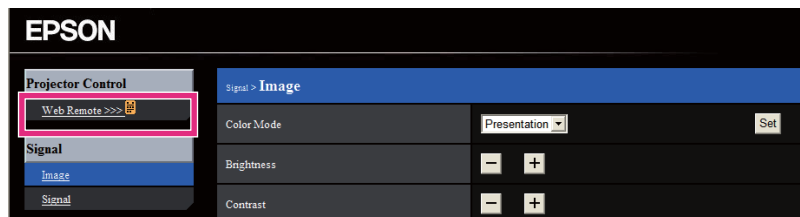

3 The Web Remote screen is displayed.

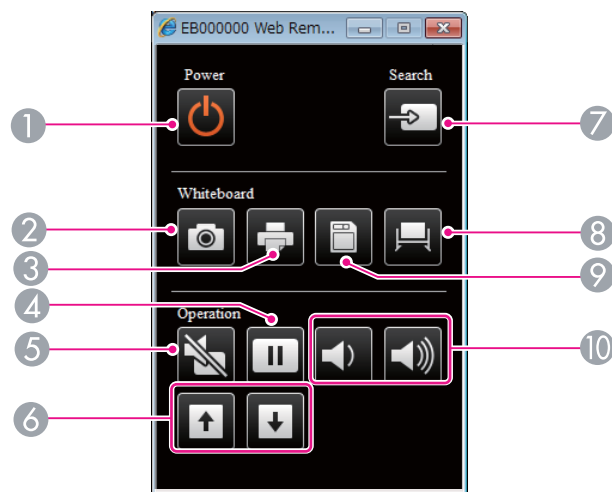

Name	Function
① [Power] button	Turns the projector power on or off. ☞ "From Installation to Projection" p.46
② [Capture] button	Takes a snapshot of the projected screen. After taking the snapshot, the image is pasted onto a new page in Whiteboard Mode. (This button cannot be used in Whiteboard mode.) ☞ "Using Drawing Content" p.80
③ [Print] button	Prints the projected screen. ☞ "Using Drawing Content" p.80

Name	Function
④ [Freeze] button	Pauses or resumes image playback. ☞ "Freezing the Image (Freeze)" p.105
⑤ [A/V Mute] button	Turns the video and audio on or off. ☞ "Hiding the Image and Sound Temporarily (A/V Mute)" p.105
⑥ [Page] buttons [Up] [Down]	Changes pages in files such as PowerPoint files when using the following projection methods. <ul style="list-style-type: none"> • When using the Wireless Mouse function ☞ "Using the Remote Control to Operate the Mouse Pointer (Wireless Mouse)" p.108 • When using USB Display ☞ "Projecting with USB Display" p.48 • When connecting to a network When projecting images using PC Free, pressing these buttons displays the previous/next screen.
⑦ [Source Search] button	Switches to the image from the input port where video signals are being input. ☞ "Automatically Detect Input Signals and Change the Projected Image (Source Search)" p.47
⑧ [Whiteboard] button	<ul style="list-style-type: none"> • Press this when the projector is off to turn on the projector and start the interactive function in Whiteboard Mode. • Press this when the projector is on to change to Whiteboard mode. If you press it in Whiteboard mode, the image changes to the previous image source. ☞ "Before Using the Interactive Function" p.65
⑨ [Save] button	Saves the projected screen. ☞ "Using Drawing Content" p.80
⑩ [Volume] buttons [Left] [Right]	[Left] Decreases the volume. [Right] Increases the volume. ☞ "Adjusting the Volume" p.56

Setting Certificates

You can use a Web browser to set the certificate settings used for wireless LAN authentication.

Install the following certificates in the projector: Client Certificate and CA certificate for wireless LAN security settings, and Web Server Certificate for the Secure HTTP function.

- 1 Display Web Control.
 - ☛ "Displaying the Web Control screen" [p.123](#)
- 2 Click **Administrator Settings - Manage Certificates** from **Network**.
- 3 The Manage Certificates screen appears.

Submenu Name	Items or Setting Values
Client Certificate	Refresh/Clear
	Issued to
	Issued by
	Validity period
CA certificate	Refresh/Clear
	Issued to
	Issued by
	Validity period
Self-signed Certificate	Refresh/Clear
	Issued to
	Issued by
	Validity period

Submenu Name	Items or Setting Values
Web Server Certificate	Refresh/Clear
	Issued to
	Issued by
	Validity period



- When installing a certificate, make sure the projector supports its format.
 - ☛ "List of supported certificates" [p.126](#)
- You can also install digital certificates on the projector from a USB storage device. However, if you install a certificate from both a USB storage device and the network, it may not be installed correctly.

Secure HTTP Notes

When **Secure HTTP** in **Administrator Settings** from the **Network** menu is set to **On**, security using HTTPS protocol is automatically applied. You can use this function to increase security between the projector and a Web browser.

A certificate is used in communication using HTTPS protocol to certify reliability of the server. Create a server certificate to verify reliability from a Web browser, and install it on the projector.

If there is no server certificate, the projector automatically creates a self-signed certificate and communicates. Because this self-signed certificate cannot verify reliability from a Web browser, a warning about the server's reliability is generated when the projector is accessed from a Web browser. Although the security level is decreased when compared to a server certificate, you can continue to communicate by ignoring the warning.

List of supported certificates

Client Certificate (PEAP-TLS/EAP-TLS)

Item	Explanation
Supported format	PKCS#12
Extension	PKCS, P12
Encryption	RSA
Hashes	MD5/SHA-1/SHA-256/SHA-384/SHA-512
Key length	512/1024/2048/4096 bit
Password	Required. Up to 32 alphanumeric characters

Server Certificate (PEAP/PEAP-TLS/EAP-TLS/EAP-Fast)

Item	Explanation
Supported format	X509v3
Extension	DER/CER/PEM
Encryption	RSA
Hashes	MD5/SHA-1/SHA-256/SHA-384/SHA-512
Key length	512/1024/2048/4096 bit
Encode	BASE64/Binary

Web Server Certificate (Secure HTTP)

Item	Explanation
Supported format	PKCS#12
Extension	PKCS, P12
Encryption	RSA
Hashes	MD5/SHA-1/SHA-256/SHA-384/SHA-512

Item	Explanation
Key length	512/1024/2048/4096 bit
Common Name	Network Host Name
Organization	Optional
Password	Required. Up to 32 alphanumeric characters

Using the Mail Notification Function to Report Problems

When you set Mail Notification, notification messages are sent to the preset email addresses when a problem or warning occurs with a projector. This will enable the operator to be notified of problems with projectors even at locations away from the projectors.

 **Network - Administrator Settings - Mail Notification** [p.138](#)



- Up to a maximum of three notification destinations (addresses) can be registered, and notification messages can be sent to all three destinations at once.
- If a projector develops a critical problem and suddenly stops working, it may not be able to send a message notifying an operator of the problem.
- Controlling is possible if **Standby Mode** is set to **Networked Standby** or **A/V Standby**, even if the projector is in standby status (when the power is off).

 **Extended - Standby Mode** [p.144](#)

Reading Error Notification Mail

When the Mail Notification function is set to On and a problem or warning occurs in the projector, the following email will be sent.

Sender: Address for Address 1

Subject: EPSON Projector

Line 1: The name of the projector where the problem occurred

Line 2: The IP address set for the projector where the problem has occurred.

Line 3 and on: Details of the problem

The details of the problem are listed line by line. The main message contents are listed below.

- Internal error
- Fan related error
- Sensor error
- Lamp timer failure
- Lamp out
- Internal temperature error
- High-speed cooling in progress
- Lamp replacement notification
- No-signal
No Signal is input to the projector. Check the connection status or check that the power for the signal source is turned on.
- Auto Iris Error
- Power Err. (Ballast)
- Obstacle Detection Error

See the following to deal with problems or warnings.

☛ "Reading the Indicators" [p.166](#)

Management Using SNMP

By setting **SNMP** to **On** in the Configuration menu, notification messages are sent to the specified computer when a problem or warning occurs. This will enable the operator to be notified of problems with projectors even at locations away from the projectors.

☛ **Network - Administrator Settings - SNMP** [p.150](#)



- SNMP should be managed by a network administrator or someone who is familiar with the network.
- To use the SNMP function to monitor the projector, you need to install the SNMP manager program on your computer.
- The managing function using SNMP cannot be used via wireless LAN in Quick connection mode.
- Up to two destination IP addresses can be saved.

ESC/VP21 Commands

You can control the projector from an external device using ESC/VP21.

Command list

When the power ON command is transmitted to the projector, the power turns on and it enters warm-up mode. When the projector's power has turned on, a colon ":" (3Ah) is returned.

When a command is input, the projector executes the command and returns a ":", and then accepts the next command.

If the command being processed terminates abnormally, an error message is output and a ":" is returned.

The main contents are listed below.

Item		Command	
Power ON/OFF	On	PWR ON	
	Off	PWR OFF	
Signal selection	Computer	Auto	SOURCE 1F
		RGB	SOURCE 11
		Component	SOURCE 14
	HDMI		SOURCE 30
	Video		SOURCE 41
	USB Display		SOURCE 51
	USB1		SOURCE 52
	LAN		SOURCE 53
	USB2		SOURCE 54
	Whiteboard		SOURCE 55
	DisplayPort		SOURCE 70
A/V Mute ON/OFF	On	MUTE ON	
	Off	MUTE OFF	

Add a Carriage Return (CR) code (0Dh) to the end of each command and transmit.

For more details, contact your local dealer or the nearest address provided in the Epson Projector Contact List.

 [Epson Projector Contact List](#)

Cable layouts

Serial connection

- Connector shape: D-Sub 9-pin (male)

- Projector input port name: RS-232C

<At the projector>

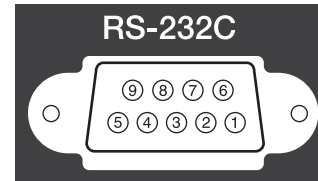

<At the computer>

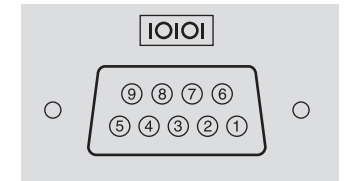

<At the projector>

(PC serial cable)

<At the computer>

GND	5	—————	5	GND
RD	2	←—————	3	TD
TD	3	—————→	2	RD

Signal Name	Function
GND	Signal wire ground
TD	Transmit data
RD	Receive data

Communications protocol

- Default baud rate setting: 9600 bps
- Data length: 8 bit
- Parity: None
- Stop-bit: 1 bit
- Flow control: None

About PLink

PLink Class1 was established by the JBMIA (Japan Business Machine and Information System Industries Association) as a standard protocol for controlling network-compatible projector's as part of their efforts to standardize projector control protocols.

The projector complies with the PLink Class1 standard established by the JBMIA.

You need to make network settings before you can use PLink. See the following for more information on network settings.

☛ "Network Menu" [p.150](#)

It complies with all commands except for the following commands defined by PLink Class1, and agreement was confirmed by the PLink standard adaptability verification.

URL:<http://plink.jbmia.or.jp/english/>

• Non-compatible commands

Function		PLink Command
Mute settings	Image muting set	AVMT 11
	Audio muting set	AVMT 21

• Input names defined by PLink and corresponding projector sources

Source	PLink Command
Computer	INPT 11
Video	INPT 21
HDMI	INPT 32
DisplayPort	INPT 35
USB1	INPT 41
USB2	INPT 42

Source	PLink Command
LAN	INPT 52
USB Display	INPT 53
Whiteboard	INPT 55

- Manufacturer name displayed for "Manufacture name information query"
EPSON
- Model name displayed for "Product name information query"
EPSON 1410/310
EPSON 1400/260

About Crestron RoomView®

Crestron RoomView® is an integrated control system provided by Crestron®. It can be used to monitor and control multiple devices connected on a network.

The projector supports the control protocol, and can therefore be used in a system built with Crestron RoomView®.

Visit the Crestron® Web site for details on Crestron RoomView®. (Only English-language displays are supported.)

<http://www.crestron.com>

The following provides an overview of Crestron RoomView®.

• Remote operation using a Web browser

You can operate a projector from your computer just like using a remote control.

Monitoring and control with application software

You can use Crestron RoomView® Express or Crestron RoomView® Server Edition provided by Crestron® to monitor devices in the system, to communicate with the help desk, and to send emergency messages. See the following Web site for details.

<http://www.crestron.com/getroomview>

This manual describes how to perform operations on your computer using a Web browser.



- You can only enter single-byte alphanumeric characters and symbols.
- The following functions cannot be used while using Crestron RoomView®.
 - "Changing Settings Using a Web Browser (Web Control)" p.122
 - Message Broadcasting (EasyMP Monitor plug-in)
- Controlling is possible if **Standby Mode** is set to **Networked Standby** or **A/V Standby**, even if the projector is in standby status (when the power is off).
 - Extended - Standby Mode p.144

Operating a projector from your computer

Displaying the operation window

Check the following before carrying out any operations.

- Make sure the computer and projector are connected to the network. When communicating with a wireless LAN, connect in Advanced connection mode.
 - "Wireless LAN menu" p.153
- Set **Crestron RoomView** to **On** from the **Network** menu.
 - Network - Administrator Settings - Crestron RoomView p.150

- Start a Web browser on the computer.
- Enter the IP address of the projector in the address field of the Web browser, and press the Enter key on the keyboard. The operation window is displayed.

Using the operation window

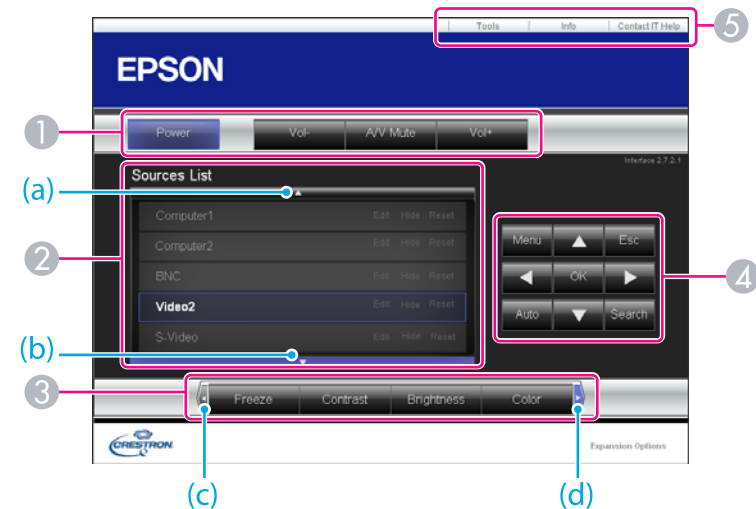







- You can perform the following operations when you click the buttons.



Button	Function
Power	Turns the projector power on or off.
Vol-/Vol+	Adjusts the volume.

Button	Function
A/V Mute	Turns the video and audio on or off.  "Hiding the Image and Sound Temporarily (A/V Mute)" p.105

- Switch to the image from the selected input source. To display input sources that are not shown on the screen, click (a) or (b) to scroll up or down. The current video signal input source is displayed in blue.
You can change the source name if necessary.
- You can perform the following operations when you click the buttons. To display buttons that are not shown on the screen, click (c) or (d) to scroll left or right.

Button	Function
Freeze	Pauses or resumes image playback.  "Freezing the Image (Freeze)" p.105
Contrast	You can adjust the difference between light and dark in the images.
Brightness	You can adjust the image brightness.
Color	You can adjust the color saturation for the images.
Sharpness	You can adjust the image sharpness.
Zoom	Click the [⊕] button to enlarge the image without changing the projection size. Click the [⊖] button to reduce an image that was enlarged with the [⊕] button. Click the [▲], [▼], [◀], or [▶] button to change the position of an enlarged image.  "Enlarging Part of the Image (E-Zoom)" p.107

- [▲], [▼], [◀], and [▶] buttons have the same effects as , , , and  buttons on the remote control respectively. You can perform the following operations when you click the other buttons.

Button	Function
OK	Performs the same operation as the [↵] button on the remote control.  "Remote Control" p.16
Menu	Displays and closes the Configuration menu.
Auto	If clicked while projecting analog RGB signals from the Computer port, you can automatically optimize Tracking, Sync., and Position.
Search	Switches to the image from the input port where video signals are being input.  "Automatically Detect Input Signals and Change the Projected Image (Source Search)" p.47
Esc	Performs the same operation as the [Esc] button on the remote control.  "Remote Control" p.16

- You can perform the following operations when you click the tabs.

Tab	Function
Contact IT Help	Displays the Help Desk window. Used to send messages to, and receive messages from, the administrator using Crestron RoomView® Express.
Info	Displays information on the projector that is currently connected.
Tools	Changes settings in the projector that is currently connected. See the next section.

Using the tools window

The following window is displayed when you click the **Tools** tab on the operation window. You can use this window to change settings in the projector that is currently connected.

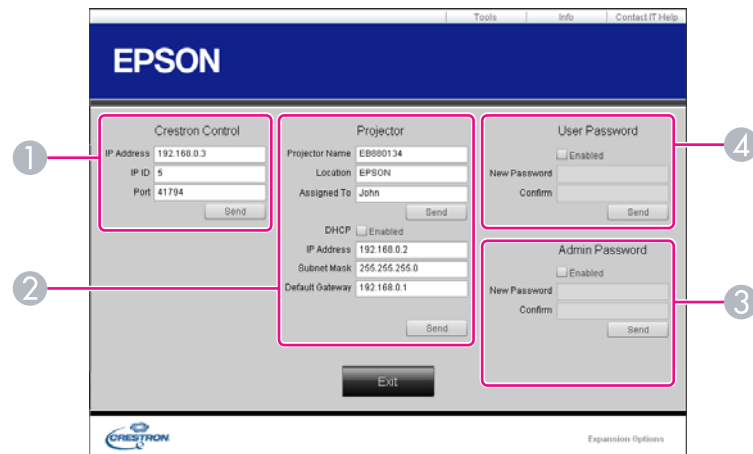

The screenshot shows the EPSON control interface with four numbered callouts:

- 1** Crestron Control: IP Address (192.168.0.3), IP ID (5), Port (41794), Send button.
- 2** Projector: Projector Name (EB880134), Location (EPSON), Assigned To (John), Send button; DHCP (Enabled), IP Address (192.168.0.2), Subnet Mask (255.255.255.0), Default Gateway (192.168.0.1), Send button.
- 3** Admin Password: Enabled checkbox, New Password, Confirm, Send button.
- 4** User Password: Enabled checkbox, New Password, Confirm, Send button.

- 1 Crestron Control**
Make settings for Crestron® central controllers.

- 2 Projector**
The following items can be set.

Item	Function
Projector Name	Enter a name to differentiate the projector that is currently connected from other projectors on the network. (The name can contain up to 15 single-byte alphanumeric characters.)
Location	Enter an installation location name for the projector that is currently connected on the network. (The name can contain up to 32 single-byte alphanumeric characters and symbols.)
Assigned To	Enter a user name for the projector. (The name can contain up to 32 single-byte alphanumeric characters and symbols.)

Item	Function
DHCP	Select the Enabled check box to use DHCP. You cannot enter an IP address if DHCP is enabled.
IP Address	Enter the IP address to assign to the currently connected projector.
Subnet Mask	Enter a subnet mask for the currently connected projector.
Default Gateway	Enter the gateway address for the currently connected projector.
Send	Click this button to confirm the changes made to the Projector .

- 3 Admin Password**
Select the **Enabled** check box to require a password to open the Tools window. The following items can be set.

Item	Function
New Password	Enter the new password when changing the password to open the Tools window. (The name can contain up to 26 single-byte alphanumeric characters.)
Confirm	Enter the same password as you entered in New Password . If the passwords are not the same, an error is displayed.
Send	Click this button to confirm the changes made to the Admin Password .

- 4 User Password**
Select the **Enabled** check box to require a password to open the operation window on the computer. The following items can be set.

Item	Function
New Password	Enter the new password when changing the password to open the operation window. (Up to 26 single-byte alphanumerical characters)
Confirm	Enter the same password as you entered in New Password . If the passwords are not the same, an error is displayed.
Send	Click this button to confirm the changes made to the User Password .

Setting Schedule

You can schedule turning the projector power on/off and switching the input source, as events in the schedule. Registered events are executed automatically at the specified time on the specified dates or weekly.

Warning

Do not place flammable objects in front of the lens. If you set the schedule to turn on the projector automatically, any flammable objects placed in front of the lens could cause a fire.

Setting Methods

- 1 Press the [Menu] button while projecting.
 "Using the Configuration Menu" [p.136](#)

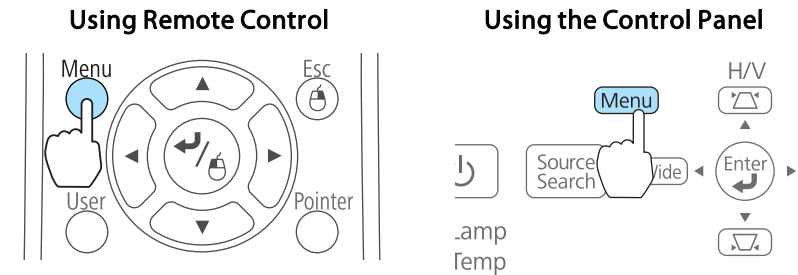

- 2 Select **Time/Schedule Settings** from **Extended**.

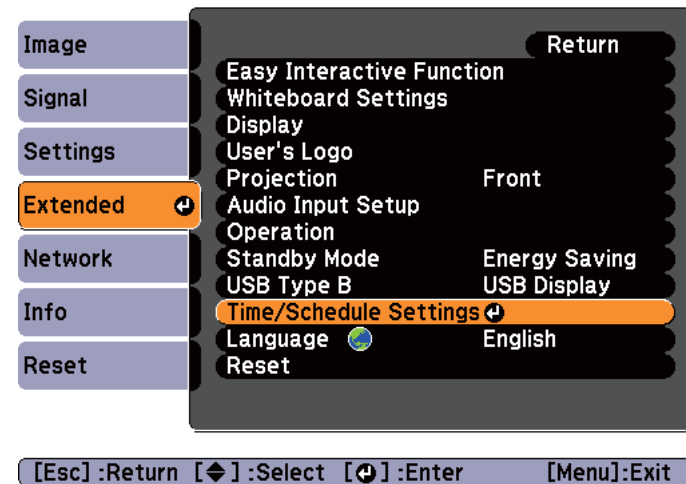

- 3 Set the time and schedule.
 Selecting from the top menu and sub menus, and changing of selected items are the same as operations in the configuration menu.

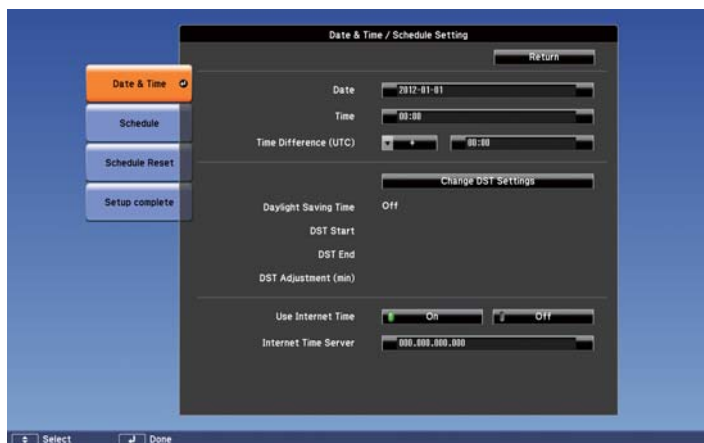

To delete all registered schedules, select **Schedule Reset**, then select **Yes**.

Clock

Submenu Name	Function
Date	Set today's date in the projector.
Time	Set the current time in the projector.
Time Difference (UTC)	Set the time difference from Coordinated Universal Time.
Change DST Settings	Displays the screen to set the daylight saving time.
Use Internet Time	Set to On to update the time automatically through an Internet time server.
Internet Time Server	Input the IP address for an Internet time server.

Daylight Saving Time screen

Submenu Name	Function
Daylight Saving Time	Set whether or not (On/Off) to activate the daylight saving time.
DST Start	Set the date and time to start the daylight saving time.
DST End	Set the date and time to end the daylight saving time.
DST Adjustment (min)	Adjusts the time difference between the standard time and the daylight saving time.

Schedule

You can display the list of registered schedules. The Time/Schedule Settings screen is displayed when you select **Add New**, or if you press [Esc] on a registered schedule, and then select **Edit** or **Add New** from the menu displayed.

You can register up to 30 events.

Clock / Schedule Setting screen

Submenu Name	Function
Event Settings	Select an operation of the projector when the event is executed. You can set the following item operations. <ul style="list-style-type: none"> • Power supply • Source • Power Consumption • A/V Mute • Volume
Date / Time Settings	Set the date, day of the week, and time to execute the event.



Configuration Menu

This chapter explains how to use the Configuration menu and its functions.

This section explains how to use the Configuration menu.

Although steps are explained using the remote control as an example, you can perform the same operations from the control panel. Check the guide under the menu for the available buttons and their operations.

1 Display the Configuration menu screen.

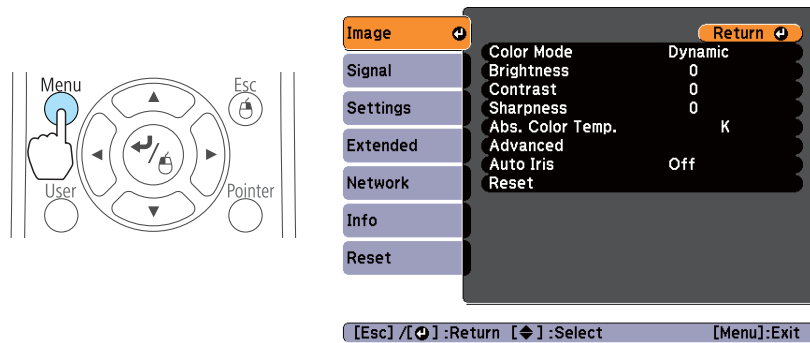

2 Select a top menu item.

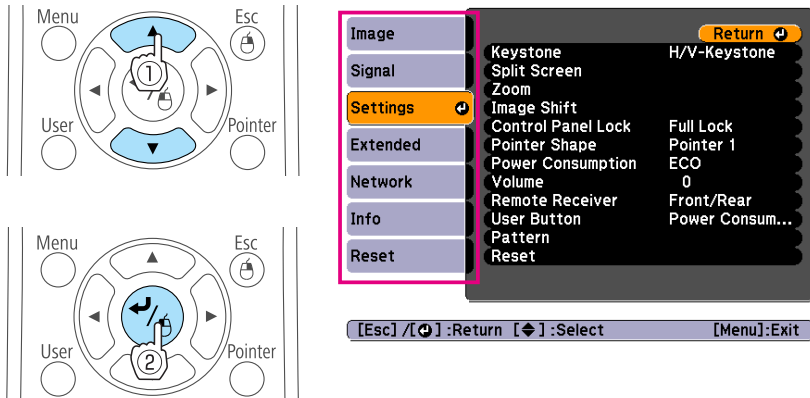

3 Select a submenu item.

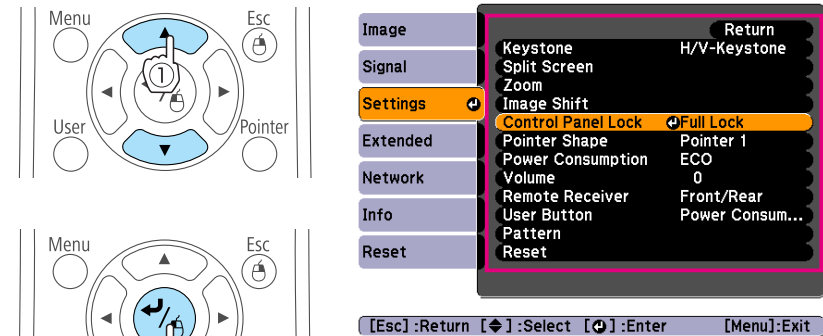

4 Change settings.

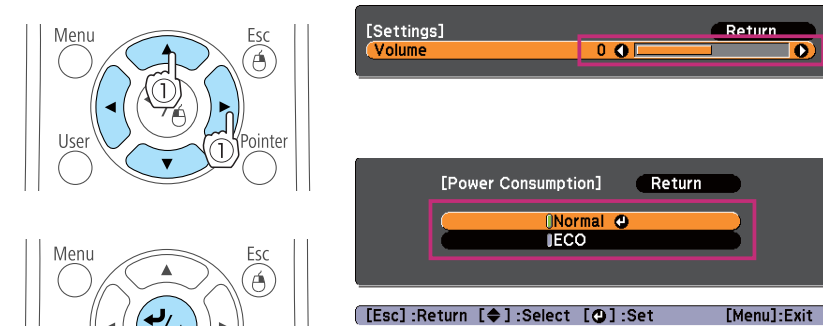

5 Press the [Menu] button to finish making settings.

Configuration Menu Table

Settable items vary depending on the model being used and the image signal and source being projected.

Top Menu Name	Submenu Name	Items or Setting Values
Image menu ☛ p.139	Color Mode	Dynamic, Presentation, Theatre, Photo, Sports, sRGB, Whiteboard, DICOM SIM, and Customized
	Brightness	-24 - 24
	Contrast	-24 - 24
	Color Saturation	-32 - 32
	Tint	-32 - 32
	Sharpness	-5 - 5
	Abs. Color Temp.	5000K to 10000K
	Advanced	Gamma, RGB, and RGBCMY
	Auto Iris	On and Off
	Signal menu ☛ p.140	Auto Setup
Resolution		Auto, Wide, and Normal
Tracking		-
Sync.		-
Position		Up, Down, Left, and Right
Progressive		Off, Video, and Film/Auto
Noise Reduction		Off, NR1, and NR2
HDMI Video Range		Auto, Normal, and Expanded
DisplayPort Video Range		Auto, Normal, and Expanded
Input Signal	Auto, RGB, and Component	

Top Menu Name	Submenu Name	Items or Setting Values
	Video Signal	Auto, NTSC, NTSC4.43, PAL, M-PAL, N-PAL, PAL60, and SECAM
	Aspect	Normal, Auto, 4:3, 16:9, Full, Zoom, and Native
	Overscan	Auto, Off, 4%, and 8%
Settings menu ☛ p.142	Keystone	H/V-Keystone and Quick Corner
	Split Screen	-
	Zoom	0 (Wide) to 40 (Tele)
	Image Shift	-
	Control Panel Lock	Full Lock, Partial Lock, and Off
	Pointer Shape	Pointer 1, Pointer 2, Pointer 3
	Power Consumption	Normal and ECO
	Volume	0 - 20
	Remote Receiver	Front/Rear, Front, Rear and Off
	User Button	Power Consumption, Info, Progressive, Test Pattern, Resolution, Pattern Display, and Auto Calibration
	Pattern	Pattern Display, Pattern Type, User Pattern, and Test Pattern
	Extended menu ☛ p.144	Easy Interactive Function
Whiteboard Settings		-



Top Menu Name	Submenu Name	Items or Setting Values
	Display	Messages, Display Background, Startup Screen, and A/V Mute, Pen Toolbar Tab, and Pen Mode Icon
	User's Logo	-
	Projection	Front, Front/Upside Down, Rear, Rear/Upside Down
	Audio Input Setup	Audio Input, DisplayPort Audio Input, and HDMI Audio Input
	Operation	Direct Power On, Sleep Mode, Sleep Mode Timer, and High Altitude Mode
	Standby Mode	Energy Saving, Networked Standby, and A/V Standby
	USB Type B	Easy Interactive Function, USB Display/Easy Interactive Function, Wireless Mouse/USB Display
	Time/Schedule Settings	-
	Language	15 or 35 languages*
Info menu ☛ p.162	Lamp Hours	-
	Source	-
	Input Signal	-
	Resolution	-
	Video Signal	-
	Refresh Rate	-
	Sync Info	-
	Status	-
	Serial Number	-
	Event ID	-

Top Menu Name	Submenu Name	Items or Setting Values
Reset menu ☛ p.163	Reset All	-
	Reset Lamp Hours	-

* The number of supported languages differs depending on the region where the projector is used.

Network menu

Top Menu Name	Submenu Name	Items or Setting Values
Basic menu ☛ p.152	Projector Name	-
	Web Remote Password	-
	Projector Keyword	On and Off
Wireless LAN menu ☛ p.153	Wireless LAN Power	On and Off
	Wi-Fi Protected Setup	-
	Wireless LAN Sys.	802.11b/g and 802.11b/g/n
	Connection Mode	Quick and Advanced
	SSID Auto Setting	On and Off
	SSID	-
	Search Access Point	-
	Channel	1ch, 6ch, and 11ch
	SSID Display	On and Off
	DHCP	On and Off
	IP Address	-
	Subnet Mask	-
	Gateway Address	-
IP Address Display	On and Off	
Region Code	-	

Top Menu Name	Submenu Name	Items or Setting Values
Security menu  p.155	Security	Open, WPA/WPA2-PSK, WPA/WPA2-EAP
Wired LAN menu  p.157	DHCP	On and Off
	IP Address	-
	Subnet Mask	-
	Gateway Address	-
	IP Address Display	On and Off
Administrator Settings menu  p.158	Administrator Password	-
	Network Host Name	-
	PJLink Password	-
	Web Control Password	-
	Monitor Password	-
	Secure HTTP	On and Off
	Mail Notification	-
	Manage Certificates	-
	SNMP	-
	Priority Gateway	Wired, Wireless
	AMX Device Discovery	On and Off
	Crestron RoomView	On and Off
	Bonjour	On and Off
	EPSON Message Broadcasting	On and Off

 "Automatically Detect Input Signals and Change the Projected Image (Source Search)" p.47

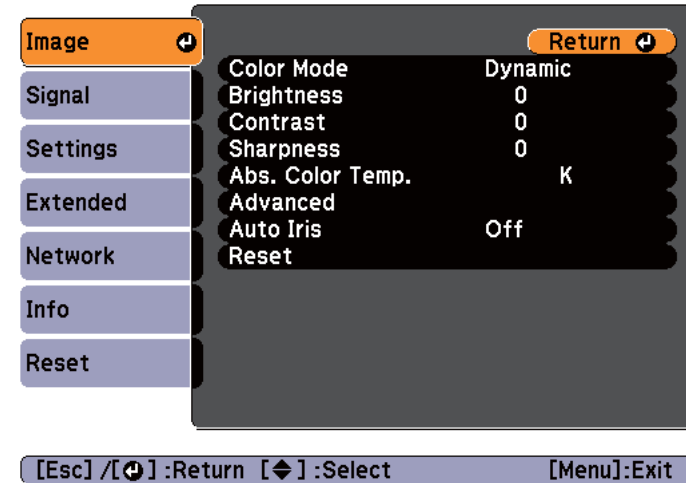



Image Menu

Settable items vary depending on the image signal and source currently being projected. Setting details are saved for each image signal.

Sub-menu	Function
Color Mode	You can select the quality of the image to suit your surroundings.  "Selecting the Projection Quality (Selecting Color Mode)" p.58
Brightness	You can adjust the image brightness.
Contrast	You can adjust the difference between light and dark in the images.
Color Saturation	(Adjustment is only possible when component video or composite video images are being input.) You can adjust the color saturation for the images.
Tint	(Adjustment is possible when component video signals are being input. If a composite video signal is input, adjustment is only possible when NTSC signals are being input.) You can adjust the image tint.
Sharpness	You can adjust the image sharpness.

Sub-menu	Function
Abs. Color Temp.	(This item cannot be selected if Color Mode is set to <u>sRGB</u> ▶.) You can adjust the overall tint of the image. You can adjust tints in 10 stages from 5000 K to 10000 K. The image is tinted blue when a high value is selected and tinted red when a low value is selected.
Advanced	(This item cannot be selected if Color Mode is set to <u>sRGB</u> ▶.) You can make adjustments by choosing the following items. Gamma: You can adjust the coloring by selecting one of the gamma correction values, or referring to the projected image or a gamma graph. RGB: You can adjust the individual R (red), G (green), and B (blue) components of the offset and gain. RGBCMY: You can adjust the hue, saturation, and brightness of each color R (red), G (green), B (blue), C (cyan), M (magenta), Y (yellow) individually.
Auto Iris	(This item can be set only if Color Mode is set to Dynamic , Theatre , or Customized .) Set to On to adjust the iris to obtain the optimum light for images being projected. The setting is stored for each Color Mode. ☛ "Setting Auto Iris" p.59
Reset	You can reset all adjustment values for the Image menu to their default settings. See the following to return all menu items to their default settings. ☛ "Reset Menu" p.163

Signal Menu

Settable items vary depending on the image signal and source currently being projected. Setting details are saved for each image signal.

You cannot make settings on the Signal menu when the source is Whiteboard, USB Display, USB1, USB2 or LAN.

☛ "Automatically Detect Input Signals and Change the Projected Image (Source Search)" [p.47](#)

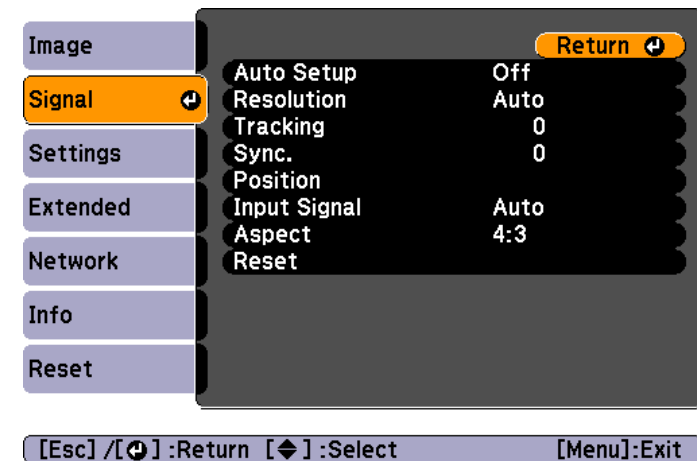

Sub-menu	Function
Auto Setup	(Only available when analog RGB computer signals are being input.) Set to On to automatically adjust Tracking, Sync., and Position to the optimum state when the input signal changes.

Sub-menu	Function
Resolution	(Only available when analog RGB computer signals are being input.) Set to Auto to automatically identify the resolution of the input signal. If images are not projected correctly when set to Auto , for example if some of the image is missing, adjust to Wide for wide screens, or set to Normal for 4:3 or 5:4 screens depending on the connected computer.
Tracking	(Only available when analog RGB computer signals are being input.) You can adjust computer images when vertical stripes appear in the images.
Sync.	(Only available when analog RGB computer signals are being input.) You can adjust computer images when flickering, fuzziness, or interference appear in the images.
Position	(This item cannot be set when the source is HDMI or DisplayPort.) You can adjust the display position up, down, left, and right when a part of the image is missing so that all of the image is projected.
Progressive	(This setting can only be adjusted when a composite video signal is being input. When a component video or RGB video is being input, this setting can only be adjusted if the signal being input is an interlaced signal (480i/576i/1080i.) Interlace (i) signal is converted to Progressive (p). (IP conversion) Off: Ideal for images with a large amount of movement. Video: Ideal for general video images. Film/Auto: This is ideal for movie films, computer graphics, and animation.



Sub-menu	Function
Noise Reduction	(This cannot be set when a digital RGB signal is input, or when an interlace signal is being displayed when Progressive is set to Off .) Smooths out rough images. There are two modes. Select your favorite setting. It is recommended that this is set to Off when viewing image sources in which noise is very low, such as for DVDs.
HDMI Video Range	When the projector's HDMI port is connected to a DVD player, the projector's video range is set according to the DVD player's video range setting.
DisplayPort Video Range	When the projector's DisplayPort port is connected to a computer, set the projector's video range according to the computer's video range setting.
Input Signal	You can select input signal from Computer port. If set to Auto , the input signal is set automatically according to the connected equipment. If colors do not appear correctly when set to Auto , select the appropriate signal according to the connected equipment.
Video Signal	You can select the input signal from the Video port. If set to Auto , video signals are recognized automatically. If interference appears in the image or a problem occurs such as no image is being projected when set to Auto , select the appropriate signal according to the connected equipment.
Aspect	You can set the aspect ratio for projected images. ☛ "Changing the Aspect Ratio of the Projected Image" p.59
Overscan	(This setting can only be adjusted when component video or RGB video signals are being input.) Changes the output image ratio (the range of the projected image). You can set the cropping range to Off , 4% , or 8% . When the source is HDMI, Auto is available. When Auto is selected, it automatically changes to Off or 8% according to the input signal.

Sub-menu	Function
Reset	<p>You can reset all adjustment values on the Signal menu to their default settings, except for Input Signal.</p> <p>See the following to return all menu items to their default settings.</p> <p>☛ "Reset Menu" p.163</p>

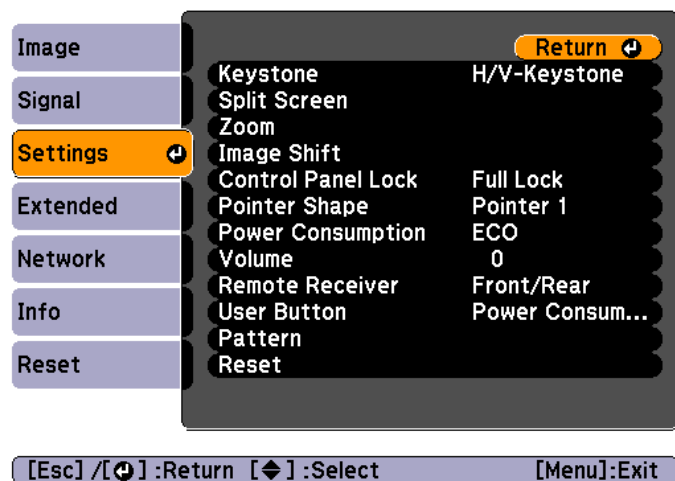





Settings Menu



Sub-menu	Function
Keystone	<p>You can correct keystone distortion.</p> <ul style="list-style-type: none"> When H/V-Keystone is selected: Adjust V-Keystone and H-Keystone to correct horizontal and vertical keystone distortion. When Quick Corner is selected: Select and correct the four corners of the projected image. <p>☛ "Quick Corner" p.52</p>

Sub-menu	Function
Split Screen	<p>(This item cannot be set when the source is Whiteboard.)</p> <p>You can split the screen into two screens.</p> <p>You can change the Screen Size, and select the Source, Swap Screens, Audio Source, and Exit Split Screen.</p> <p>☛ "Projecting Two Images Simultaneously (Split Screen)" p.90</p>
Zoom	Adjusts the projected image size.
Image Shift	<p>Starts Image Shift.</p> <p>☛ "Adjusting the Position of the Image (Image Shift)" p.54</p>
Control Panel Lock	<p>You can use this to restrict operation of the projector's control panel.</p> <p>☛ "Restricting Operation (Control Panel Lock)" p.115</p>
Pointer Shape	<p>You can select the shape of the pointer.</p> <p>Pointer 1: </p> <p>Pointer 2: </p> <p>Pointer 3: </p> <p>☛ "Pointer Function (Pointer)" p.105</p>
Power Consumption	<p>You can set the lamp brightness to one of two settings.</p> <p>Select ECO if the images being projected are too bright, such as when projecting images in a dark room or onto a small screen. When ECO is selected, the amount of electricity consumed and the lamp's operating life are changed as follows, and fan rotation noise during projection is reduced.</p> <p>Electrical consumption: Approx. 40% decrease, lamp life: Approx. 1.4 times longer</p>
Volume	<p>(This item cannot be set when the source is Whiteboard.)</p> <p>You can adjust the volume. Setting values are saved for each source.</p>

Sub-menu	Function
Remote Receiver	<p>You can limit the reception of the operation signal from the remote control.</p> <p>When set to Off, you cannot perform any operations from the remote control. If you want to make operations from the remote control, hold down the [Menu] button on the remote control for at least 15 seconds to reset the setting to its default value.</p>
User Button	<p>You can select the item in the Configuration menu to be assigned to the [User] button on the remote control. By pressing the [User] button the assigned menu item selection/adjustment screen is displayed, allowing you to make one-touch settings/adjustments. You can assign one of the following items to the [User] button.</p> <p>Power Consumption, Info, Progressive, Test Pattern, Resolution, Pattern Display, and Auto Calibration</p>

Sub-menu	Function
Pattern	<p>Pattern Display: Display a pattern.</p> <p>Pattern Type: You can select from Patterns 1 to 4 or User Pattern. Patterns 1 to 4 display projection lines such as ruled lines or a grid.</p> <p>Pattern 1:  Pattern 2: </p> <p>Pattern 3:  Pattern 4: </p> <p>User Pattern: Captures a user pattern.  "Saving User Pattern" p.111</p> <p>Test Pattern: When the projector is set up, a test pattern is displayed so that you can adjust the projection status without connecting equipment. While the test pattern is displayed, zoom, focus adjustments, and keystone correction can be performed. To cancel the Test Pattern, press the [Esc] button on the remote control or the control panel.</p> <div style="border: 1px solid black; background-color: #ffffcc; padding: 5px; margin-top: 10px;"> <p>Attention</p> <p>If a pattern is displayed for a long time, a residual image may be visible in projected images.</p> </div>
Reset	<p>You can reset all adjustment values in the Settings menu to their default settings, except for Zoom and User Button.</p> <p>See the following to return all menu items to their default settings.</p> <p> "Reset Menu" p.163</p>

Extended Menu

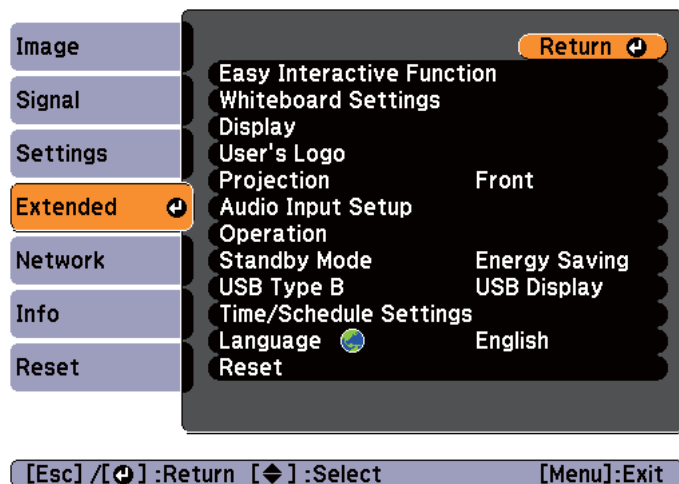

Sub-menu	Function
Easy Interactive Function	Allows you to use and set the interactive function. <ul style="list-style-type: none"> ☛ "Summary of the Interactive Function" p.63 See the following table for more details. ☛ "Easy Interactive Function setting items" p.146
Whiteboard Settings	Sets Whiteboard Mode. <ul style="list-style-type: none"> ☛ "Whiteboard Settings screen" p.147

Sub-menu	Function
Display	<p>You can make settings related to the projector's display.</p> <p>Messages: When set to Off, the following items will not be displayed.</p> <p>Item names when the Source, Color Mode, or Aspect Ratio is changed, messages when no signal is being input, and warnings such as High Temp Warning.</p> <p>Display Background*1: You can set the screen status for when no image signal is available to Black, Blue, or Logo.</p> <p>Startup Screen*1: Set to On to display the User's Logo when projection starts.</p> <p>A/V Mute*1: You can set the screen displayed when the remote control's [A/V Mute] button is pressed to Black, Blue, or Logo.</p> <p>Pen Toolbar Tab: Set whether or not the toolbar tab is always displayed when using PC Free Annotation.</p> <p>Pen Mode Icon: Set the display position for the pen mode icon when using the interactive function. The icon is hidden when set to Off.</p>
User's Logo*1	<p>You can change the user's logo that is displayed as a background during Display Background, A/V Mute, and so on.</p> <ul style="list-style-type: none"> ☛ "Saving a User's Logo" p.109
Projection	<p>Select from one of the following projection methods depending on how the projector is installed.</p> <p>Front, Front/Upside Down, Rear, and Rear/Upside Down</p> <p>You can change the Projection setting as follows by holding down the [A/V Mute] button on the remote control for about five seconds.</p> <p>Front↔Front/Upside Down</p> <p>Rear↔Rear/Upside Down</p> <ul style="list-style-type: none"> ☛ "Installation Methods" p.27

Sub-menu	Function
Audio Input Set-up	<p>Audio Input: Sets the audio input when the image source is Computer, Video, or USB2.</p> <p>DisplayPort Audio Input: Sets the input audio when projecting images from the DisplayPort.</p> <p>HDMI Audio Input: Sets the input audio when projecting images from the HDMI port.</p> <p>When set to Audio1, Audio2, or Audio3, audio is output from the selected port regardless of the input source as long as audio is input from the audio input port.</p>
Operation	<p>Direct Power On: Set to On to turn on the projector simply by plugging it in.</p> <p>When the power cord is plugged in, note that the projector turns on automatically in cases such as a power outage being restored.</p> <p>Sleep Mode: When this is set to On, the power is turned off automatically when no image signal is input and no operation is performed within a certain amount of time.</p> <p>Sleep Mode Timer: When Sleep Mode is set to On, you can set the time before the projector automatically turns off within a range of 1 to 30 minutes.</p> <p>High Altitude Mode: Set to On when using the projector above an altitude of 1500 m.</p>

Sub-menu	Function
Standby Mode	<p>Sets the type of standby status.</p> <p>If you set Networked Standby, you can monitor and control the projector over a network even if the projector is in standby mode.</p> <p>☛ "Monitoring and Controlling" p.122</p> <p>If you set A/V Standby, you can perform the following operations even if the projector is in standby mode.</p> <ul style="list-style-type: none"> • Monitoring and controlling the projector over the network. <ul style="list-style-type: none"> ☛ "Monitoring and Controlling" p.122 • Outputting audio from the input port to an external speaker. <p>You can also change the volume over a network. Audio input from DisplayPort, HDMI, USB Display, USB1, USB2, or LAN cannot be output. Also, audio is not output when Audio Input is set to Auto and the previous source that was being used is DisplayPort, HDMI, USB Display, USB1, USB2, or LAN.</p> <ul style="list-style-type: none"> ☛ "Connecting image sources" p.33 • Outputting analog RGB signals from the Computer port to an external monitor.
USB Type B	<p>Easy Interactive Function: Allows you to use the interactive function (PC Interactive). USB Display and Wireless Mouse functions are not available.</p> <p>USB Display/Easy Interactive Function: Allows you to use the interactive function (PC Interactive) and USB Display. The Wireless Mouse function is not available.</p> <p>Wireless Mouse/USB Display: Allows you to use the Wireless Mouse function and USB Display. The interactive function (PC Interactive) is not available.</p> <p>☛ "Projecting with USB Display" p.48</p> <p>☛ "Using the Remote Control to Operate the Mouse Pointer (Wireless Mouse)" p.108</p> <p>☛ "Operating a Computer from the Projected Screen (PC Interactive)" p.84</p>

Sub-menu	Function
Time/Schedule Settings	You can set the projector's date and time, and the projector's schedule so that it performs a specific operation at a pre-scheduled time. ☛ "Setting Schedule" p.133
Language	Allows you to set the language for messages and menus.
Reset	You can reset the adjustment values for Display *1 and Operation *2 from the Extended menu to their default settings. See the following to return all menu items to their default settings. ☛ "Reset Menu" p.163

*1 When **User's Logo Protect** is set to **On** in **Password Protect**, settings related to user's logo cannot be changed. You can make changes after setting **User's Logo Protect** to **Off**.

☛ "Managing Users (Password Protect)" [p.113](#)

*2 Except for High Altitude Mode.

Easy Interactive Function setting items

Sub-menu	Function
General settings	<ul style="list-style-type: none"> • Auto Calibration: Starts Auto Calibration. • Manual Calibration: Starts Manual Calibration. • Pen Mode: (This item cannot be set when the source is Whiteboard, Video, USB1, or USB2) Select PC Interactive when performing mouse operations using Easy Interactive Pen. • Hovering: When set to On (default setting), the pointer follows the pen tip as you hover it over the screen and move it around. • Distance of Projectors: Adjusts the Easy Interactive Pen operations when using multiple projectors in the same room. Set according to the distance between the projectors. If Easy Interactive Pen operations are unstable, try another mode. The standard set for Mode 2 is the distance 6 m.
PC Interactive	<p>Set when you want to operate a computer from the projected screen.</p> <ul style="list-style-type: none"> • Number of Pen Users: Allows you to set the number of people who can use the Easy Interactive Pens at the same time. • Pen Operation Mode: (Only available when Number of Pen Users is set to One User) Sets the Easy Interactive Pen operation mode. When set to Mouse, you can perform mouse operations using the Easy Interactive Pen. When set to Pen, you can use the pen function in Windows Vista/7. • Enable Right Click: (Only available when Pen Operation Mode is set to Mouse) When this is set to On, a long press of the Easy Interactive Pen acts as a right click.

Sub-menu	Function
PC Interactive - Advanced	<ul style="list-style-type: none"> • Pen Tip Button: Allows you to set operations for the pen tip button of the Easy Interactive Pen. • Auto Adjust Pen Area: When this is set to On, the pen area is automatically adjusted as the resolution for the connected computer changes. • Manual Adj. Pen Area: Starts the manual adjustment pen area.

Whiteboard Settings screen

The operating cautions and the format for alphanumeric text for the Whiteboard Settings screen is also the same for the Network menu.

☞ "Notes on operating the Network menu" [p.151](#)

☞ "Soft keyboard operations" [p.152](#)

Basic menu

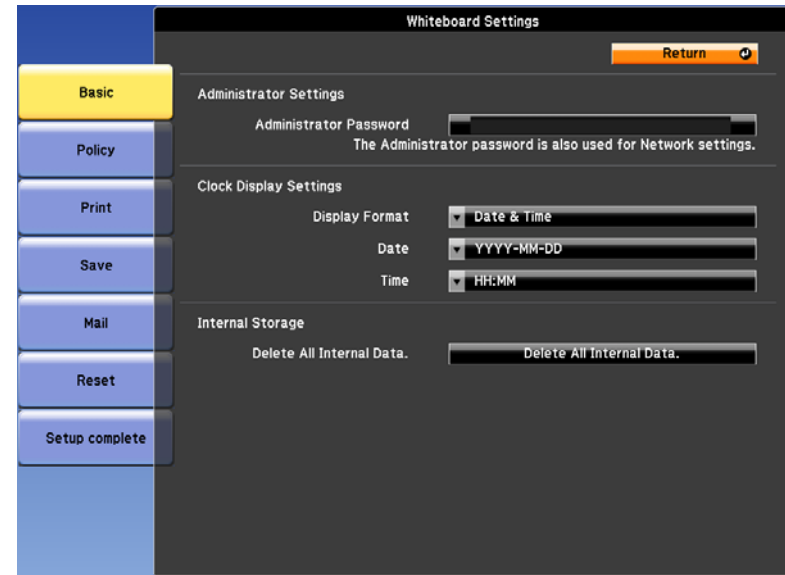

Sub-menu	Function
Administrator Settings	<p>Administrator Password: Sets the administrator password. You can enter up to 16 single-byte alphanumeric characters. The Administrator Password is also used for the Network menu.</p> <p>☞ "Administrator Settings menu" p.158</p>
Clock Display Settings	Sets the clock displayed on the bottom toolbar.
Internal Storage	Delete All Internal Data: Deletes all data from the internal storage. Use this function if any problems occur with the internal storage, or when repairing or disposing of the projector.

Policy menu

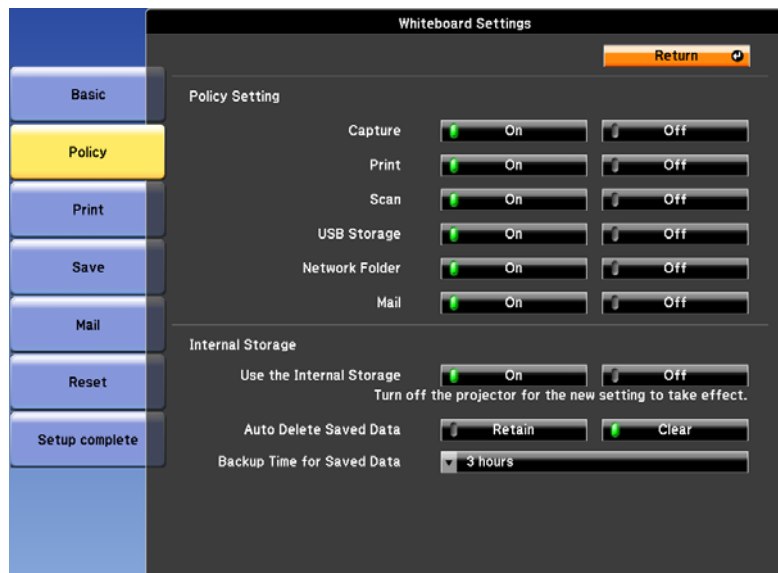

Sub-menu	Function
Policy Setting	Enables or disables functions such as Capture, Print, and Scan.
Internal Storage	<p>Use the Internal Storage: Set to On to save data to the internal storage when using Whiteboard Mode. When set to Off, you can only edit one page at a time, and the internal storage function is limited. Normally, we recommend setting this to On.</p> <p>Auto Delete Saved Data: When set to Clear, all drawing data is deleted from the internal storage when the projector is turned off. Normally, we recommend setting this to Retain.</p> <p>Backup Time for Saved Data: Sets the time to store a backup of drawing data if the power is accidentally turned off. A backup is performed even when Auto Delete Saved Data is set to Clear.</p>

Print menu

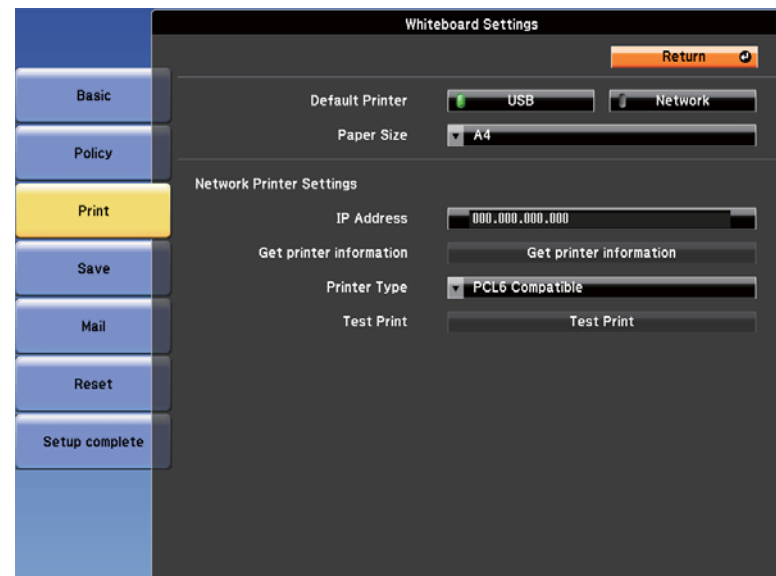

Sub-menu	Function
Default Printer	Set the default printer used when printing. The selected printer is displayed as the default in Whiteboard Mode. In PC Free Annotation, this printer is used automatically.
Paper Size	Sets the paper size.
IP Address	Enter the IP address for the network printer. You can enter a number from 0 to 255 in each field of the address. However, the following IP addresses cannot be used. 127.x.x.x, 192.0.2.x, 224.0.0.0 to 255.255.255.255 (where x is a number from 0 to 255)
Get Printer Information	Communicates with the printer associated with the IP address, and automatically recognizes the printer type.
Printer Type	Sets the type of connected printer. Normally use the values set automatically when printer information is acquired.

Sub-menu	Function
Test Print	Prints a test page.

Save menu

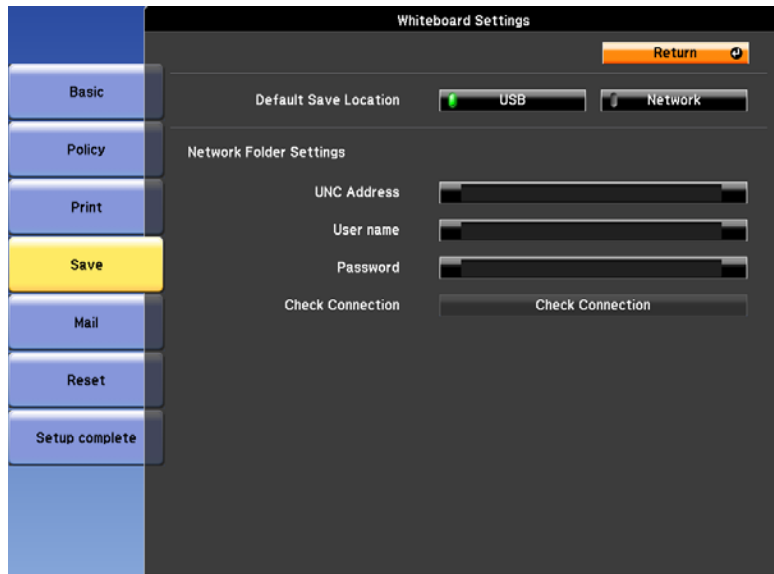

Sub-menu	Function
Default Save Location	Sets the default save location for drawing data. This is displayed as the default save location when saving data in Whiteboard Mode. In PC Free Annotation, data is automatically saved to this location when performing a save.

Sub-menu	Function
UNC Address	<p>Sets the network folder name in UNC "\\host name\share name\relative path". You cannot use an IP address as the host name. You can enter up to 116 single-byte alphanumeric characters (you cannot use spaces).</p> <div style="border: 1px solid black; padding: 5px; background-color: #ffffcc;"> <p> This function uses Windows file sharing. The projector communicates with the file sharing server using the following ports.</p> <ul style="list-style-type: none"> • NetBIOS name service 137/UDP 137/TCP • NetBIOS datagram service 138/UDP • NetBIOS session service 139/TCP </div>
User name	Set the user name that has read/write access authority for the network folder. You can enter up to 64 single-byte alphanumeric characters (you cannot use spaces). If you also need to enter a domain name, add the domain name before the user name separated by a backslash.
Password	Enter a password for the user name. You can enter up to 64 single-byte alphanumeric characters. When the password is entered and Setup complete is selected, the value is set and displayed as an asterisk (*).
Check Connection	Performs a connection check.

Mail menu



Sub-menu	Function
SMTP Server	Enter the Mail Server address. This cannot be set as the host name. You can enter a number from 0 to 255 in each field of the address. However, the following IP addresses cannot be used. 127.x.x.x, 192.0.2.x, 224.0.0.0 to 255.255.255.255 (where x is a number from 0 to 255)
Port Number	You can input the port number for the SMTP server. The default value is 25. You can input numbers between 1 to 65535.
Reply to	Enter the reply email address to use when an error occurs while sending an email. You can enter up to 64 single-byte alphanumeric characters for the email addresses.
Default e-mail Address	Enter the default email address used to send emails. You can enter up to 64 single-byte alphanumeric characters for the email addresses. Set a different address from the address set in Reply to.

Sub-menu	Function
Send a Test e-mail	Connects to the SMTP server and sends a test email to Default e-mail Address.

Reset menu

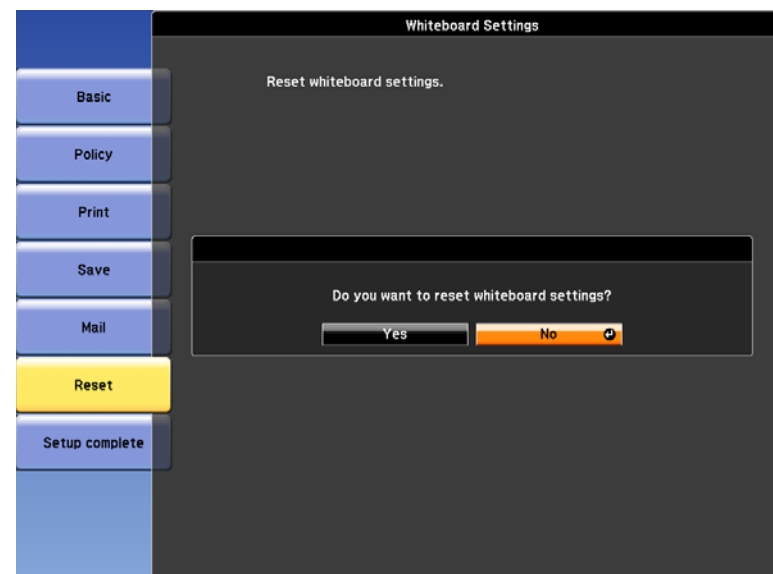

Returns Whiteboard Settings to the default settings.

Network Menu

When **Network Protect** is set to **On** in **Password Protect**, a message is displayed and the network settings cannot be changed. Set **Network Protect** to **Off** and then configure the network.

☛ "Setting Password Protect" p.113

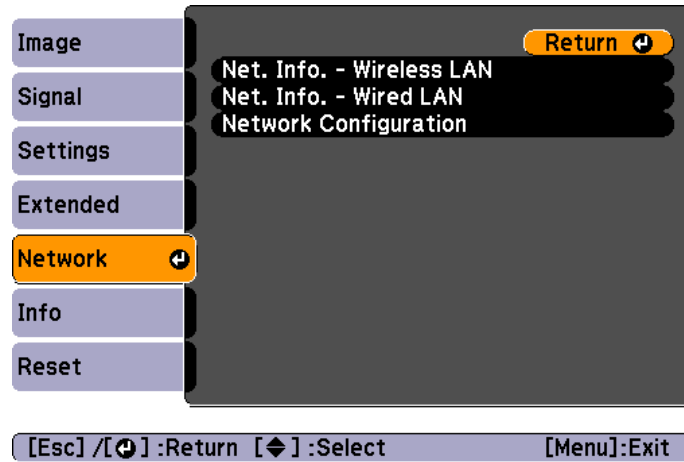

Sub-menu	Function
Net. Info. - Wireless LAN	Displays the following network setting status information. <ul style="list-style-type: none"> • Connection Mode • Antenna Level • Projector Name • SSID • DHCP • IP Address • Subnet Mask • Gateway Address • MAC Address • Region Code*
Net. Info. - Wired LAN	Displays the following network setting status information. <ul style="list-style-type: none"> • Projector Name • DHCP • IP Address • Subnet Mask • Gateway Address • MAC Address

Sub-menu	Function
Network Configuration	The following menus are available for setting network items. Basic, Wireless LAN, Security, Wired LAN, Administrator Settings, and Reset

* Displays available region information for the Wireless LAN unit being used. For more details, contact your local dealer or the nearest address provided in the Epson Projector Contact List.

☛ [Epson Projector Contact List](#)

Notes on operating the Network menu

Selecting from the top menu and sub menus, and changing selected items is the same as making operations from the Configuration menu.

When done, make sure you go to the **Setup complete** menu, and select one of **Yes**, **No**, or **Cancel**. When you select **Yes** or **No**, you return to the Configuration menu.

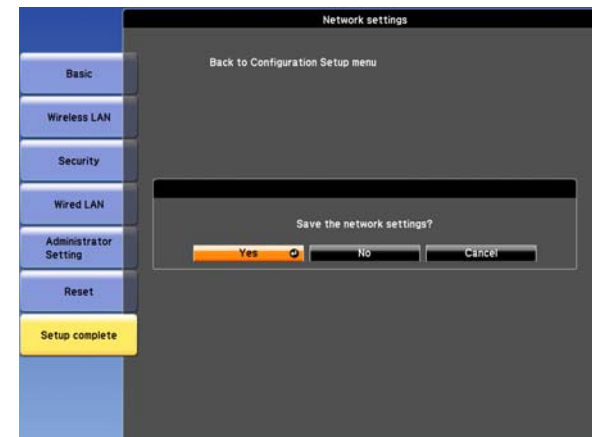

Yes: Saves the settings and exits the Network menu.

No: Does not save the settings and exits the Network menu.

Cancel: Continues displaying the Network menu.

Soft keyboard operations

The Network menu contains items that require input of alphanumerics during setup. In this case, the following software keyboard is displayed. Use the [↶], [↷], [⏪], and [⏩] buttons on the remote control or the [↶], [↷], [⏪], and [⏩] buttons on the control panel to move the cursor to the desired key, and then press the [↵] button to enter the alphanumeric character. Enter figures by holding down the [Num] button on the remote control, and pressing the numeric buttons. After inputting, press **Finish** on the keyboard to confirm your input. Press **Cancel** on the keyboard to cancel your input.



- Each time the **CAPS** key is selected and the [↵] button is pressed, it switches between upper case and lower case.
- Each time the **SYM1/2** key is selected and the [↵] button is pressed, it sets and changes the symbol keys for the section enclosed by the frame.



By using a Web browser of a computer connected to the projector on a network, you can set functions and control the projector. This function is called Web Control. You can easily enter text using a keyboard to make settings for Web Control such as Security settings.

☛ "Changing Settings Using a Web Browser (Web Control)" [p.122](#)

Basic menu

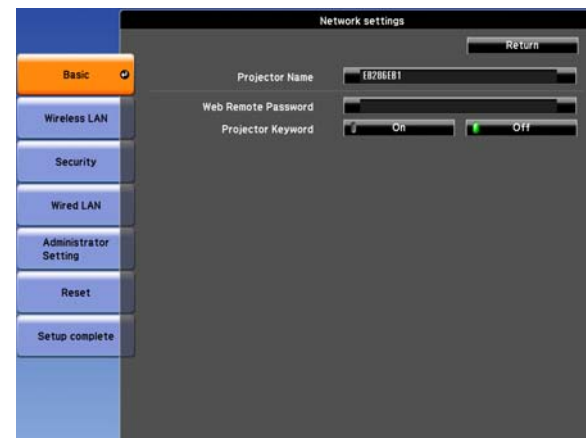

Sub-menu	Function
Projector Name	Displays the projector name used to identify the projector when connected to a network. When editing, you can enter up to 16 single-byte alphanumeric characters.
Web Remote Password	Set a password to use Web Remote. You can enter up to 8 single-byte alphanumeric characters. Web Remote is a computer function that allows you to operate the projector by using the Web browser on a computer connected on a network. ☛ "Changing Settings Using a Web Browser (Web Control)" p.122
Projector Keyword	When set to On , you have to enter the keyword when you try to connect the projector to a computer via a network. As a result, you can prevent presentations from being interrupted by connections from other computers. Normally this should be set to On . ☛ EasyMP Network Projection Operation Guide

Wireless LAN menu

To connect the projector to a computer using a wireless LAN, install the Wireless LAN unit (ELPAP07).

☛ "Installing the wireless LAN unit" [p.40](#)

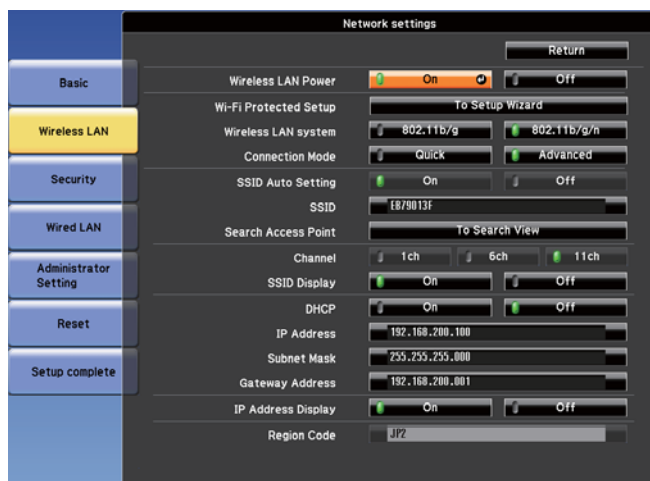

Sub-menu	Function
Wireless LAN Power	Set this to On when connecting the projector and a computer via a wireless LAN. If you do not want to connect via wireless LAN, turn it Off to prevent unauthorized access by others.
Wi-Fi Protected Setup	Set this when connecting to a network via a wireless LAN access point compatible with <u>WPS (Wi-Fi Protected Setup)</u> ▶▶. You can easily connect the projector to the access point and make security settings. ☛ "Making a WPS (Wi-Fi Protected Setup) Connection with a Wireless LAN Access Point " p.120
Wireless LAN Sys.	Sets the wireless LAN system. Normally this should be set to 802.11b/g/n . The connection method is selected automatically according to the access point settings. In an area that does not support 802.11n, only 802.11b/g is displayed.



Sub-menu	Function
Connection Mode	Set the connection mode to use when connecting the projector and a computer via a wireless LAN. If you select Quick , a small network is created automatically by the projector and computer. This is used with EasyMP Network Projection. If SSID Auto Setting is set to On , the projector becomes an easy access point; if it is set to Off , the network is created in <u>Ad hoc mode</u> ▶▶. If you select Advanced , the connection is established in <u>infrastructure mode</u> ▶▶ through the access point installed.
SSID Auto Setting	If Connection Mode is set to Quick , when you set this to On , you can search for the projector more quickly from among multiple projectors. SSID is set automatically. When connecting to multiple projectors from 1 computer in Quick mode, set this to Off , and set the same SSID in all the projectors you want to connect to.
SSID	Enter an SSID. When an SSID is provided for the wireless LAN system in which the projector participates, enter the SSID. You can enter up to 32 single-byte alphanumeric characters. Set SSID to blank or ANY to establish an ANY connection.
Search Access Point	When Connection Mode is set to Advanced , you can search for surrounding access points, and set the SSID to be connected from those access points. Depending on the access point settings, they may not be displayed in the list. You must set security separately. ☛ "Search Access Point screen" p.154
Channel	You can select the channels used to connect in Quick mode. If interference from other signals occurs, use a different channel.
SSID Display	To prevent the SSID from being displayed on the LAN Standby screen, set this to Off .
DHCP	You can set whether or not (On/Off) to use <u>DHCP</u> ▶▶. If this is set to On , you cannot set any more addresses.

Sub-menu	Function
IP Address	You can input the <u>IP address</u> assigned to the projector. You can enter a number from 0 to 255 in each field of the address. However, the following IP addresses cannot be used. 0.0.0.0, 127.x.x.x, 192.0.2.x, 224.0.0.0 to 255.255.255.255 (where x is a number from 0 to 255)
Subnet Mask	You can input the <u>Subnet Mask</u> for the projector. You can enter a number from 0 to 255 in each field of the address. However, the following subnet masks cannot be used. 0.0.0.0, 255.255.255.255
Gateway Address	You can input the IP address for the gateway for the projector. You can enter a number from 0 to 255 in each field of the address. However, the following <u>Gateway addresses</u> cannot be used. 0.0.0.0, 127.x.x.x, 224.0.0.0 to 255.255.255.255 (where x is a number from 0 to 255)
IP Address Display	To prevent the IP address from being displayed on the LAN Standby screen, set this to Off .
Region Code	This is a specific string of the wireless LAN module.

Search Access Point screen

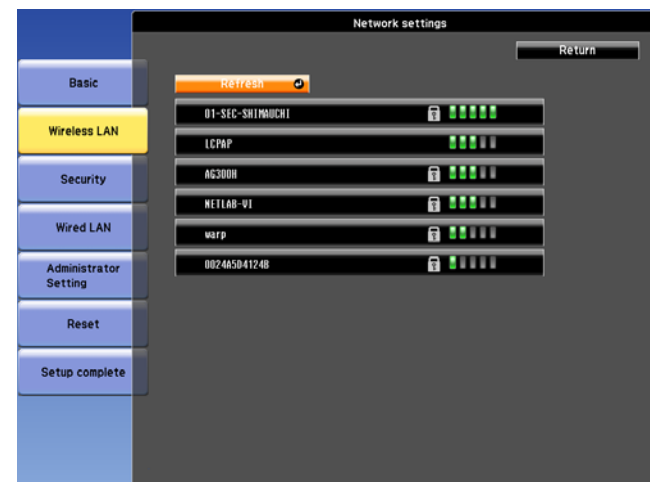
Detected access points are displayed in a list.



Sub-menu	Function
Refresh	Searches for the access point again.
	Indicates an already set access point.
	Indicates the access points where security is set. If you select an access point where security has not been set, the Wireless LAN menu is displayed. If you select an access point where security has been set, the Security menu is displayed. Select a type of security according to the security settings for the access point.

Security menu

When the Wireless LAN unit is installed, it is strongly recommended that you set security.



Sub-menu	Function
Security	<p>You can select a type of security.</p> <ul style="list-style-type: none"> When Quick is selected <ul style="list-style-type: none"> Open: Security is not set. WPA2-PSK(AES) (only when SSID Auto Setting is set to On): Communication is performed using WPA2 security. Uses AES method for encryption. When establishing a connection from a computer to the projector, enter the value set in the passphrase. When Advanced is selected <ul style="list-style-type: none"> Open: Security is not set. WPA2-PSK(AES): Connects in WPA personal mode. Encryption method is selected automatically according to the access point settings. Set a passphrase which is the same for the access point. WPA/WPA2-EAP: Connects in WPA enterprise mode. Encryption method is selected automatically according to the access point settings. Select this item when using LEAP.



You cannot set WEP as an encryption method for this projector.

When WPA/WPA2-PSK is selected



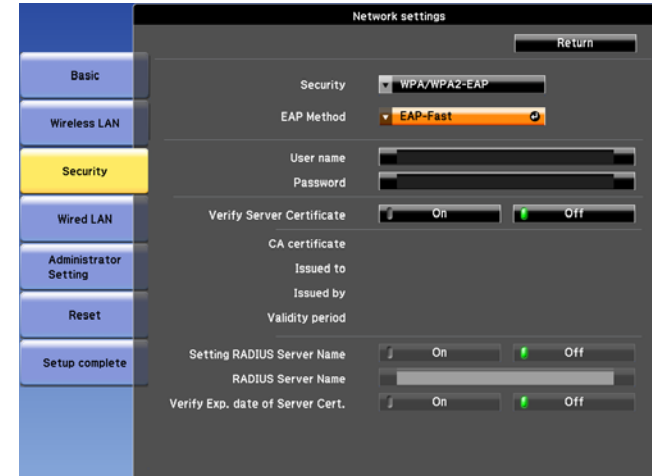

When WPA/WPA2-EAP is selected



Sub-menu	Function
Passphrase	<p>Enter the passphrase. You can enter at least 8 and up to 63 single-byte alphanumeric characters. When the passphrase is entered and the [↵] button is pressed, the value is set and displayed as an asterisk (*).</p> <p>When using it with EasyMP Network Projection, you do not need to input the passphrase in the computer if it is the initial (default) passphrase.</p> <p>It is recommended to change the passphrase periodically for the purpose of security. If the network settings are initialized, it returns to the initial passphrase.</p> <p>☛ "Reset menu" p.162</p> <p>You can enter up to 32 characters on the Configuration menu. When entering more than 32 characters, use your Web browser to enter the text.</p> <p>☛ "Changing Settings Using a Web Browser (Web Control)" p.122</p> <p>In Quick mode, the initial passphrase is set.</p>

Sub-menu	Function
EAP Method	<p>Set the protocol for authentication.</p> <p>PEAP: Authentication protocol widely used in Windows Server.</p> <p>PEAP-TLS: Authentication protocol used in Windows Server. Set when using client certificate.</p> <p>EAP-TLS: Authentication protocol widely used to use a client certificate.</p> <p>EAP-Fast, LEAP: Select this when these authentication protocols are used.</p>

Sub-menu	Function
User name	<p>Enter a user name to be used for authentication. You can enter up to 64 single-byte alphanumeric characters (you cannot use spaces).</p> <p>If you select PEAP-TLS or EAP-TLS, the user name obtained automatically from the client certificate is displayed. You can change the user name if the authentication server requires another user name.</p> <p>You can enter up to 32 characters on the Configuration menu. When entering more than 32 characters, use your Web browser to enter the text.</p> <p> "Changing Settings Using a Web Browser (Web Control)" p.122</p> <p>If you also need to enter a domain name, add the domain name before the user name separated by a backslash.</p>
Password	<p>Enter a password to be used for authentication. You can enter up to 64 single-byte alphanumeric characters. When the password is entered and Finish is selected, the value is set and displayed as an asterisk (*).</p> <p>You can enter up to 32 characters on the Configuration menu. When entering more than 32 characters, use your Web browser to enter the text.</p> <p> "Changing Settings Using a Web Browser (Web Control)" p.122</p>
Client Certificate	Displays the Issued to , Issued by , and Validity period information set in the stored client certificate. It is blank if the certificate is not set.
Verify Server Certificate	<p>Set to On to perform verification for the authentication server certificate. To verify a server certificate, you need to set CA certificate.</p> <p> "Setting Certificates" p.125</p>
CA certificate	Displays the Issued to , Issued by , and Validity period information set in the stored CA certificate. It is blank if the certificate is not set.

Sub-menu	Function
Setting RADIUS Server Name	Set to On to perform authentication of the server name during server certificate verification. By specifying the server name, you can reduce the risk of connecting to an invalid authentication server.
RADIUS Server Name	Specify the authentication server name. You can enter up to 32 single-byte alphanumeric characters.
Verify Exp. date of Server Cert.	Set to On to perform verification of the certificate's validity period during server certificate verification.

Wired LAN menu

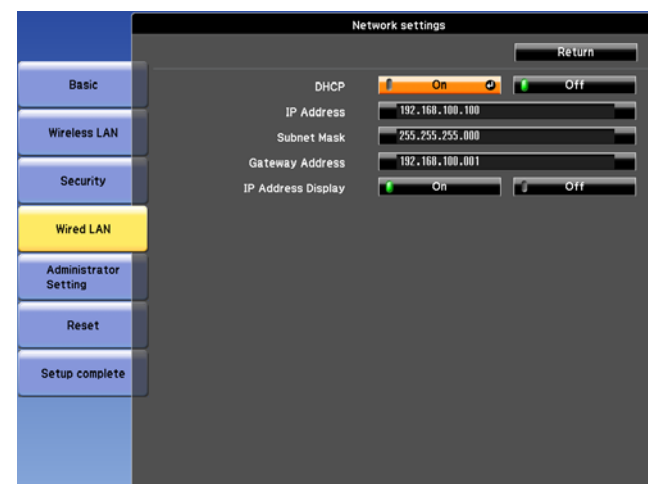

Sub-menu	Function
DHCP	You can set whether or not (On/Off) to use DHCP . If this is set to On , you cannot set any more addresses.

Sub-menu	Function
IP Address	You can input the <u>IP address</u> assigned to the projector. You can enter a number from 0 to 255 in each field of the address. However, the following IP addresses cannot be used. 0.0.0.0, 127.x.x.x, 192.0.2.x, 224.0.0.0 to 255.255.255.255 (where x is a number from 0 to 255)
Subnet Mask	You can input the <u>Subnet Mask</u> for the projector. You can enter a number from 0 to 255 in each field of the address. However, the following subnet masks cannot be used. 0.0.0.0, 255.255.255.255
Gateway Address	You can input the IP address for the gateway for the projector. You can enter a number from 0 to 255 in each field of the address. However, the following <u>Gateway addresses</u> cannot be used. 0.0.0.0, 127.x.x.x, 224.0.0.0 to 255.255.255.255 (where x is a number from 0 to 255)
IP Address Display	To prevent the IP address from being displayed on the LAN Standby screen, set this to Off .

Administrator Settings menu

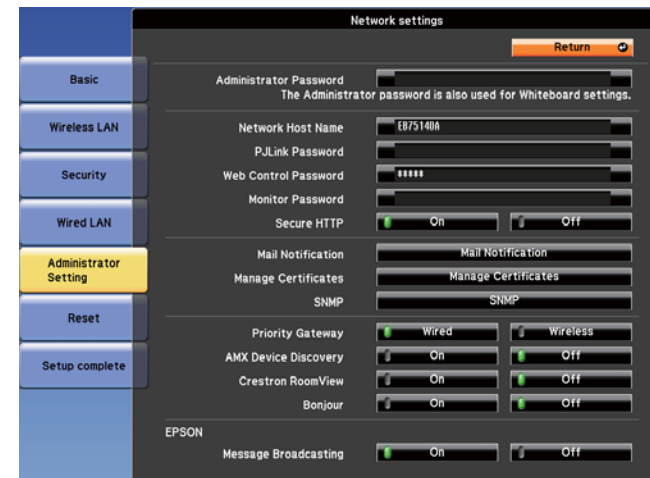

Sub-menu	Function
Administrator Password	Enter the password for the Administrator Settings menu for network settings. You can enter up to 16 single-byte alphanumeric characters. If the administrator password is not set, click OK with an empty password box. The Administrator Password is also used for Whiteboard settings. ☛ "Basic menu" p.147
Network Host Name	Enter the projector's host name. You can enter up to 15 single-byte alphanumeric characters.
PJLink Password	Set a password to use when you access the projector using compatible PJLink software. You can enter up to 32 single-byte alphanumeric characters. ☛ "About PJLink" p.129

Sub-menu	Function
Web Control Password	Set a password to use when making settings and controlling the projector using Web Control. You can enter up to 8 single-byte alphanumeric characters. Web Control is a computer function that allows you to set up and control the projector by using the Web browser on a computer connected on a network. ☛ "Changing Settings Using a Web Browser (Web Control)" p.122
Monitor Password	Set a password to use EasyMP Monitor. You can enter up to 16 single-byte alphanumeric characters.
Secure HTTP	To strengthen security, communication between the projector and computer in Web control is encrypted. When setting security with Web control, it is recommended to set this to On .
Mail Notification	Goes to the Mail Notification setting menu. ☛ "Mail Notification menu" p.159
Manage Certificates	Goes to the Manage Certificates settings menu. ☛ "Manage Certificates menu" p.160
SNMP	Goes to the SNMP settings menu. ☛ "SNMP menu" p.161
Priority Gateway	For the priority gateway, select either Wired or Wireless .
AMX Device Discovery	When you want to allow the projector to be detected by <u>AMX Device Discovery</u>  , set this to On . Set this to Off if you are not connected to an environment controlled by a controller from AMX or AMX Device Discovery.
Crestron RoomView	Set this to On only when monitoring or controlling the projector over the network using Crestron RoomView®. Otherwise, set this to Off . ☛ "About Crestron RoomView®" p.129 Changes in projector settings take effect upon restarting. When this is set to On , the following functions are not available. <ul style="list-style-type: none"> • Web control • Message Broadcasting (EasyMP Monitor plugin)

Sub-menu	Function
Bonjour	Set this to On when connecting to the network using Bonjour. See Apple's Web site for more information on the Bonjour service. http://www.apple.com/
EPSON Message Broadcasting	You can switch the EPSON Message Broadcasting function to enable or disable. You can download Message Broadcasting and its Operation Guide from the following Web site. http://www.epson.com

Mail Notification menu

When this is set, you receive an email notification if a problem or warning occurs in the projector.

☛ "Reading Error Notification Mail" p.126

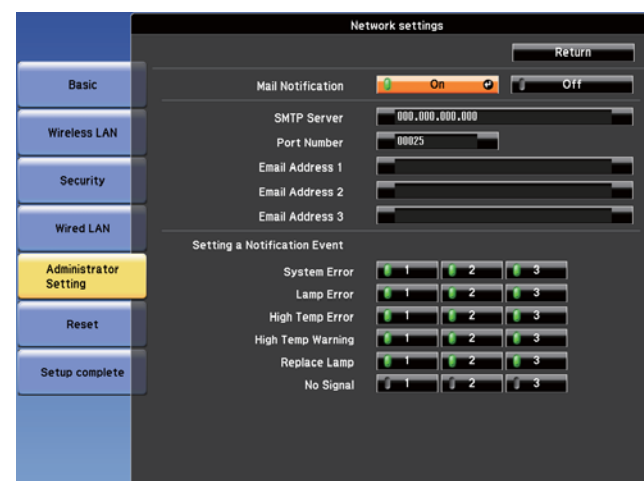

Sub-menu	Function
Mail Notification	Set to On to send an email to the preset addresses when a problem or warning occurs with a projector.

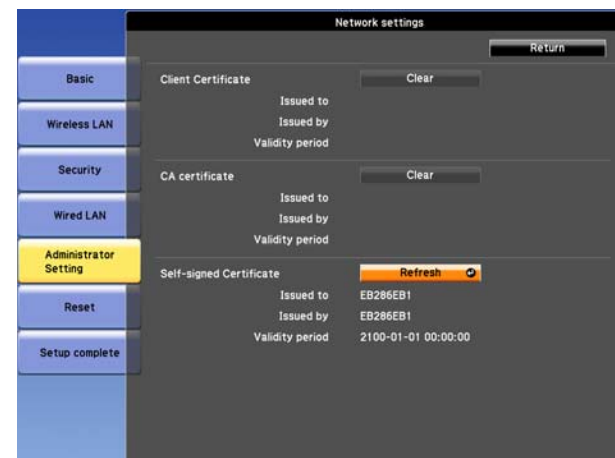

Sub-menu	Function
SMTP Server	You can input the <u>IP address</u> for the SMTP server for the projector. You can enter a number from 0 to 255 in each field of the address. However, the following IP addresses cannot be used. 127.x.x.x, 192.0.2.x, 224.0.0.0 to 255.255.255.255 (where x is a number from 0 to 255)
Port Number	You can input the port number for the SMTP server. The default value is 25. You can input numbers between 1 to 65535.
Email Address 1/ Email Address 2/ Email Address 3	You can input the email address of the destination to send the notification email to. You can register up to three destinations. You can enter up to 64 single-byte alphanumeric characters for the email addresses. You can enter up to 32 characters on the Configuration menu. When entering more than 32 characters, use your Web browser to enter the text.  "Changing Settings Using a Web Browser (Web Control)" p.122 The address for destination 1 is the mail notification sender's address.
Setting a Notification Event	You can select the problems or warnings to be notified about by email. When the selected problem or warning occurs in the projector, an email is sent to the specified Email Address notifying that a problem or warning has occurred. You can select multiple items from the displayed items.

Manage Certificates menu



Sub-menu	Function
Client Certificate	Displays the Issued to , Issued by , and Validity period information set in the stored client certificate. It is blank if the certificate is not set. You need to set Client Certificate when WPA/WPA2-EAP is selected in Security , and PEAP-TLS or EAP-TLS are selected in EAP Method . Select Clear to delete the stored certificate.
CA certificate	Displays the Issued to , Issued by , and Validity period information set in the stored CA certificate. It is blank if the certificate is not set. You need to set CA certificate when WPA/WPA2-EAP is selected in Security , when verifying the authentication server certificate. Select Clear to delete the stored certificate.

Sub-menu	Function
Self-signed Certificate	(This item can only be set when Secure HTTP is set to On .) The Issued to , Issued by , and Validity period information for the certificate maintained by the server function in the projector is displayed. This information is not displayed if Web Server Certificate is set. Select Refresh to update the self-signed certificate.
Web Server Certificate	(This item can only be set when Secure HTTP is set to On .) The Issued to , Issued by , and Validity period information on the certificate set in the projector is displayed. This information is not displayed when a Self-signed Certificate is set. Select Clear to delete the stored certificate.

- 
 Web Control is used to set certificates.
 - 
 "Setting Certificates" [p.125](#)
- You can also install digital certificates on the projector from a USB storage device. However, if you install a certificate from both a USB storage device and the network, it may not be installed correctly.

SNMP menu



Sub-menu	Function
SNMP	Set to On to monitor the projector using SNMP . To monitor the projector, you need to install the SNMP manager program on your computer. SNMP should be managed by a network administrator. The default value is Off .
Trap IP Address 1/Trap IP Address 2	You can register up to two IP addresses for the SNMP trap notification destination. You can enter a number from 0 to 255 in each field of the address. However, the following IP addresses cannot be used. 127.x.x.x, 192.0.2.x, 224.0.0.0 to 255.255.255.255 (where x is a number from 0 to 255)
Community Name	Set the community name of SNMP. You can enter up to 32 single-byte alphanumeric characters.

Reset menu

Resets all of the network settings.



Sub-menu	Function
Reset network settings.	To reset all of the Network settings, select Yes . When you reset the network settings, the Passphrase, Administrator Password and Manage Certificates menu settings change back to their default values, and the certificates are deleted. After you reset all the settings, the Basic menu appears.

Info Menu (Display Only)

Lets you check the status of the image signals being projected and the status of the projector. Items that can be displayed vary depending on the source currently being projected. Depending on the model used, some input sources are not supported.

"Automatically Detect Input Signals and Change the Projected Image (Source Search)" p.47

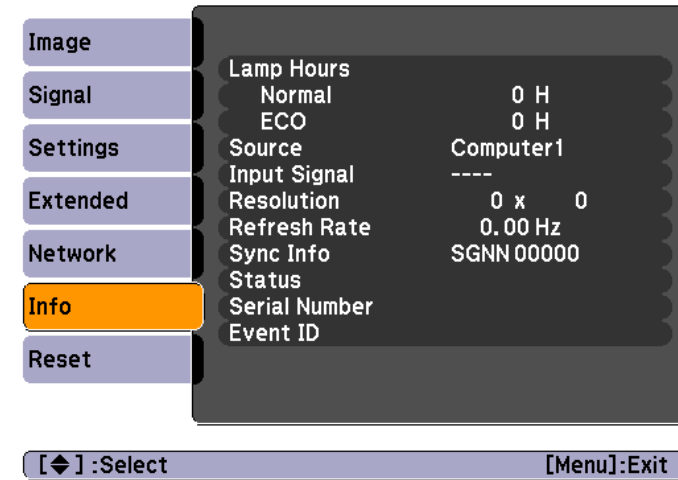

Sub-menu	Function
Lamp Hours	You can display the cumulative lamp operating time*. When it reaches the lamp warning time, the characters are displayed in yellow.
Source	You can display the source name for the connected equipment currently being projected.
Input Signal	You can display the content of Input Signal set in the Signal menu according to the source.
Resolution	You can display the resolution.
Video Signal	You can display the settings for Video Signal in the Signal menu.
Refresh Rate	You can display the <u>refresh rate</u> ▶.
Sync Info	You can display the image signal Information. It may be needed if service is required.

Sub-menu	Function
Status	This information is about errors that have occurred with the projector. It may be needed if service is required.
Serial Number	Displays the projector's serial number.
Event ID	Displays the application error log. ☛ "About Event ID" p.186

* The cumulative use time is displayed as "0H" for the first 10 hours. 10 hours and above is displayed as "10H", "11H", and so on.

Sub-menu	Function
Reset Lamp Hours	Clears the cumulative lamp hours use time. Reset this when you replace the lamp.

Reset Menu

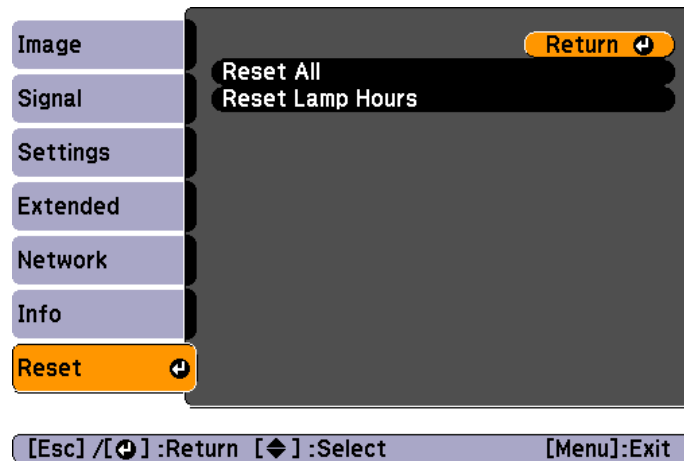

Sub-menu	Function
Reset All	You can reset all items in the Configuration menu to their default settings. The following items are not reset to their defaults: Input Signal , User's Logo , all items for Network menus, Lamp Hours , Language , Password , and User Button .



Troubleshooting

This chapter describes how to identify problems and what to do if a problem is found.

If a problem occurs with the projector, the Help screen is displayed to assist you by pressing the Help button. You can solve problems by answering the questions.

- 1 Press the [Help] button.
The Help screen is displayed.

Using Remote Control

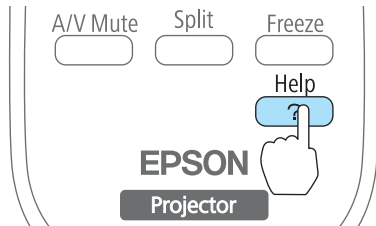

Using the Control Panel

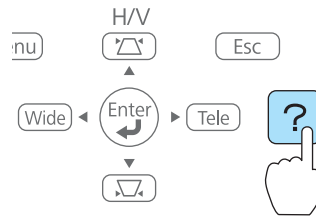

- 2 Select a menu item.

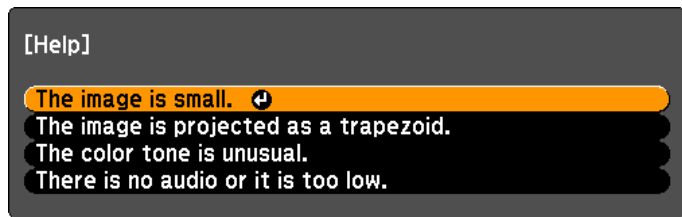

[◀] :Select [▶] :Enter [Help] :Exit

Using Remote Control

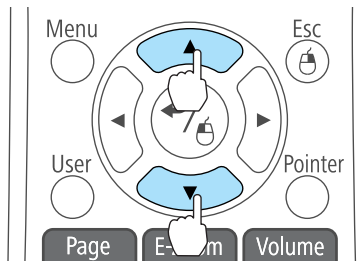

Using the control panel

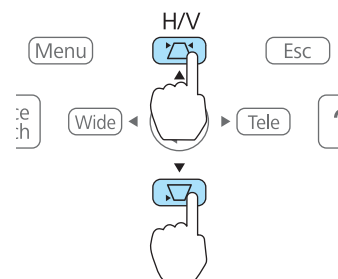

- 3 Confirm the selection.

Using Remote Control

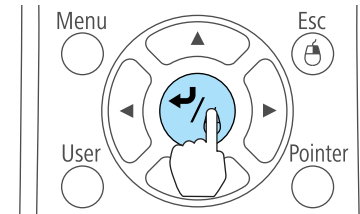

Using the Control Panel

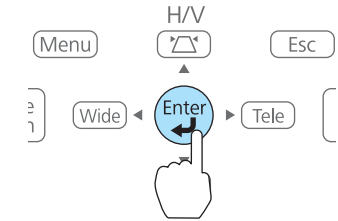

Questions and solutions are displayed as shown on the screen below. Press the [Help] button to exit the Help.

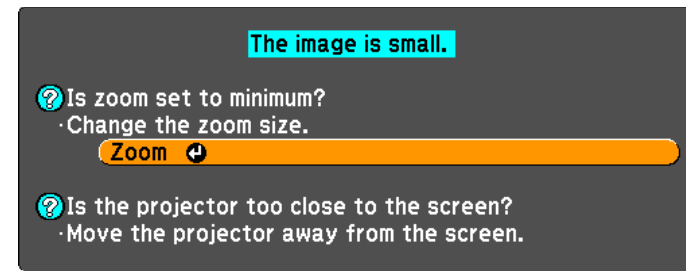

[Esc] :Return [▶] :Enter [Help] :Exit



See the following if the Help function does not provide a solution to the problem.

☞ "Problem Solving" p.166

If you are having a problem with the projector, first check the projector's indicators and see "Reading the Indicators".

See the following if the indicators do not show clearly what the problem might be.

☛ "When the Indicators Provide No Help" [p.170](#)



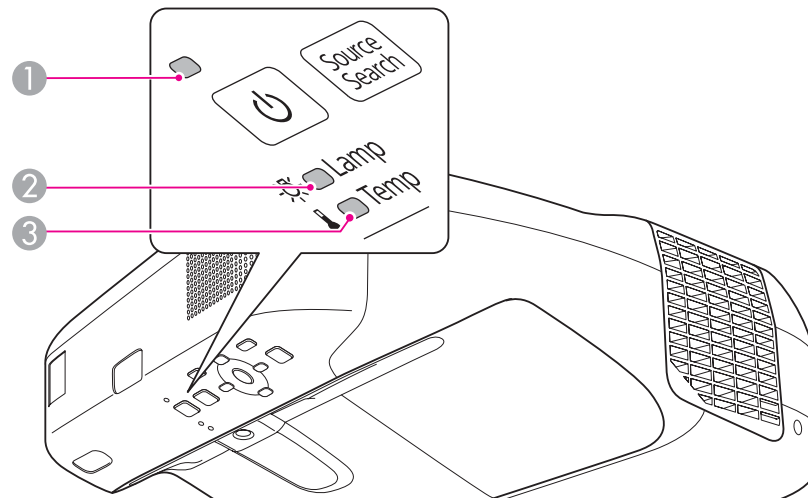

Reading the Indicators

The projector is provided with the following three indicators that indicate the operating status of the projector.



① Power indicator

Indicates the operating status.

-  Standby condition
When the [⏻] button is pressed in this condition, projection starts.
-  Preparing for network monitoring or cool down in progress
All buttons are disabled while the indicator is flashing.
-  Warming up
Warm-up time is about 30 seconds. After warm-up is complete, the indicator stops flashing.
The [⏻] button is disabled during warm-up.
-  Projecting

② Lamp indicator

Indicates the projection lamp status.

③ Temp indicator

































Indicates the internal temperature status.

























See the following table for the status of indicators and how to resolve the problems.

If all indicators are off, check that the power cord is connected correctly and that the power is being supplied normally.

Sometimes, when the power cord is unplugged, the [⏻] indicator remains lit for a short period, but this is not an error.

 : Lit
  : Flashing
  : Off
  : Varies according to the projector status

Status	Cause	Remedy or Status
     	Internal Error	Stop using the projector, remove the power plug from the electrical outlet, and contact your local dealer or the nearest address provided in the Epson Projector Contact List.  Epson Projector Contact List
     	Fan Error Sensor Error	Stop using the projector, remove the power plug from the electrical outlet, and contact your local dealer or the nearest address provided in the Epson Projector Contact List.  Epson Projector Contact List
     	High Temp Error (overheating)	The lamp turns off automatically and projection stops. Wait for approximately five minutes. After approximately five minutes the projector switches to standby mode, so check the following two points. <ul style="list-style-type: none"> • Check that the air filter and air exhaust vent are not blocked, and that the projector is not positioned against a wall. • If the air filter is clogged, clean or replace it. <ul style="list-style-type: none">  "Cleaning the Air Filter" p.190  "Replacing the Air Filter" p.194 If the error continues after checking the points above, stop using the projector, remove the power plug from the electrical outlet, and contact your local dealer or the nearest address provided in the Epson Projector Contact List.  Epson Projector Contact List
		When using at an altitude of 1500 m or more, set High Altitude Mode to On .  "Extended Menu" p.144
     	Lamp Error Lamp Failure	Check the following two points. <ul style="list-style-type: none"> • Take out the lamp and check whether it is cracked. <ul style="list-style-type: none">  "Replacing the Lamp" p.191 • Clean the air filter. <ul style="list-style-type: none">  "Cleaning the Air Filter" p.190

Status	Cause	Remedy or Status
		<p>If it is not cracked: Reinstall the lamp and turn on the power.</p> <p>If the error continues: Replace the lamp with a new one and then turn on the power.</p> <p>If the error continues: Stop using the projector, remove the power plug from the electrical outlet, and contact your local dealer or the nearest address provided in the Epson Projector Contact List.</p> <p>☛ Epson Projector Contact List</p>
		<p>If it is cracked: Contact your local dealer or the nearest address provided in the Epson Projector Contact List. (Images cannot be projected until the lamp is replaced.)</p> <p>☛ Epson Projector Contact List</p>
		<p>When using at an altitude of 1500 m or more, set High Altitude Mode to On.</p> <p>☛ "Extended Menu" p.144</p>
     	Auto Iris Error Power Err.	<p>Stop using the projector, remove the power plug from the electrical outlet, and contact your local dealer or the nearest address provided in the Epson Projector Contact List.</p> <p>☛ Epson Projector Contact List</p>
     	High Temp Warning	<p>(This is not an abnormality. However, if the temperature rises too high again, projection stops automatically.)</p> <ul style="list-style-type: none"> • Check that the air filter and air exhaust vent are not blocked, and that the projector is not positioned against a wall. • If the air filter is clogged, clean or replace it. <ul style="list-style-type: none"> ☛ "Cleaning the Air Filter" p.190 ☛ "Replacing the Air Filter" p.194
     	Replace Lamp	<p>Replace it with a new lamp.</p> <p>☛ "Replacing the Lamp" p.191</p> <p>If you continue to use the lamp after the replacement period has passed, the possibility that the lamp may blow increases. Replace it with a new lamp as soon as possible.</p>
     	Obstacle Detection Error	<p>A warning sound is output and the message "For safety purposes remove any obstacles blocking the lens." is displayed. The projector will turn off automatically if no action is taken.</p> <ul style="list-style-type: none"> • Remove obstacles around the projection window. • Clean the obstacle sensor if there is no obstacle. <p>☛ "Cleaning the Obstacle Sensor" p.189</p> <p>If the error continues: Stop using the projector, remove the power plug from the electrical outlet, and contact your local dealer or the nearest address provided in the Epson Projector Contact List.</p> <p>☛ Epson Projector Contact List</p>













- See the following if the projector is not operating properly, even though the indicators are all showing normal.
 - ☛ "When the Indicators Provide No Help" [p.170](#)
- If the indicators are in a state not shown in this table, stop using the projector, remove the power plug from the electrical outlet, and contact your local dealer or the nearest address provided in the Epson Projector Contact List.
 - ☛ [Epson Projector Contact List](#)

When the Indicators Provide No Help

If any of the following problems occur and the indicators do not offer a solution, refer to the pages given for each problem.

Problems Relating to Images













<ul style="list-style-type: none"> • No images appear Projection does not start, the projection area is completely black 	 p.171
<ul style="list-style-type: none"> • Moving images are not displayed Moving images played back from a computer appear black and the images are not projected 	 p.172
<ul style="list-style-type: none"> • Projection stops automatically 	 p.172
<ul style="list-style-type: none"> • The message "Not supported" is displayed 	 p.172
<ul style="list-style-type: none"> • The message "No Signal" is displayed 	 p.172
<ul style="list-style-type: none"> • Images are fuzzy, out of focus, or distorted 	 p.173
<ul style="list-style-type: none"> • Interference or distortion appear in images 	 p.174
<ul style="list-style-type: none"> • The mouse cursor flickers (only when projecting USB Display) 	 p.174
<ul style="list-style-type: none"> • The image is truncated (large) or small, the aspect ratio is not suitable, or the image has been reversed Only part of the image is displayed, or the height and width ratios of the image are not correct 	 p.175
<ul style="list-style-type: none"> • Image colors are not right The whole image appears purplish or greenish, images are black & white, or colors appear dull 	 p.175
<ul style="list-style-type: none"> • Images appear dark 	 p.176

Problems when Projection Starts









<ul style="list-style-type: none"> • The projector does not turn on 	 p.177
---	---

Problems with the Interactive Function

<ul style="list-style-type: none"> • Cannot use the projector's drawing function 	 p.177
--	---

<ul style="list-style-type: none"> • Cannot operate as a mouse and draw by connecting to a computer 	 p.178
<ul style="list-style-type: none"> • The message "An error occurred in the Easy Interactive Function." is displayed 	 p.178
<ul style="list-style-type: none"> • Computer's mouse does not work correctly 	 p.178
<ul style="list-style-type: none"> • The Easy Interactive Pen does not work 	 p.179
<ul style="list-style-type: none"> • The response time for the Easy Interactive Pen is slow 	 p.179
<ul style="list-style-type: none"> • The dot does not move to the next position 	 p.179
<ul style="list-style-type: none"> • The dot moves automatically 	 p.180
<ul style="list-style-type: none"> • Cannot perform operations while capturing, printing, or saving 	 p.180
<ul style="list-style-type: none"> • Cannot paste the capture of the projected screen correctly 	 p.180
<ul style="list-style-type: none"> • Cannot print normally 	 p.180
<ul style="list-style-type: none"> • Cannot scan normally 	 p.181
<ul style="list-style-type: none"> • The time is out of sync, settings for the internal storage are not reflected correctly 	 p.181
<ul style="list-style-type: none"> • Cannot change the source 	 p.181

Other Problems

<ul style="list-style-type: none"> • No sound can be heard or the sound is faint 	 p.182
<ul style="list-style-type: none"> • There is noise in the audio (only when projecting USB Display) 	 p.182
<ul style="list-style-type: none"> • The remote control does not work 	 p.183
<ul style="list-style-type: none"> • I want to change the language for messages and menus 	 p.183
<ul style="list-style-type: none"> • The authentication setting of wireless LAN fails 	 p.183
<ul style="list-style-type: none"> • Mail is not received even if an error occurs with the projector 	 p.184
<ul style="list-style-type: none"> • The message "The battery that saves your clock settings is running low." is displayed 	 p.184
<ul style="list-style-type: none"> • Image file names are not displayed correctly in PC Free 	 p.184
<ul style="list-style-type: none"> • Cannot change settings using a web browser 	 p.185

Problems Relating to Images

No images appear

Check	Remedy
Did you press the [⏻] button?	Press the [⏻] button to turn the power on.
Are all of the indicators off?	The power cord is not connected correctly or power is not being supplied. Connect the projector's power cord correctly. ☛ "From Installation to Projection" p.46 Check the breaker and so on to ensure power is being supplied.
Is A/V Mute active?	Press the [A/V Mute] button on the remote control to cancel A/V Mute. ☛ "Hiding the Image and Sound Temporarily (A/V Mute)" p.105
Are the Configuration menu settings correct?	Reset all of the settings. ☛ Reset - Reset All p.163
Is the image to be projected completely black? (Only when projecting computer images)	Some input images, such as screen savers, may be completely black.
Is the image signal format setting correct? (Only when projecting images from a video source)	Change the setting according to the signal for the connected equipment. ☛ Signal - Video Signal p.140
Is the USB cable connected correctly? (Only when projecting USB Display)	Check that the USB cable is connected correctly. Reconnect it if it is not connected or not connected properly.
Is Windows Media Center displayed in full screen? (Only when projecting using USB Display or network connection)	When Windows Media Center is displayed at full screen, you cannot project using USB Display or network connection. Reduce the screen size.
Is an application using the Windows DirectX function displayed? (Only when projecting using USB Display or network connection)	Applications using the Windows DirectX function may not display images correctly.

Moving images are not displayed (only the moving image portion turns black)

Check	Remedy
Is the computer's image signal being output to the LCD and the monitor? (Only when projecting images from a laptop computer or a computer with a built-in LCD screen)	Change the image signal from the computer to external output only. Check your computer's documentation, or contact the computer's manufacturer.
Are the contents of the moving image you are trying to project copyright protected?	The projector may not be able to project copyright protected moving images that are being played back on a computer. For more details, see the user's guide supplied with the player.

Projection stops automatically

Check	Remedy
Is Sleep Mode set to On ?	Press the [⏻] button to turn the power on. If you do not want to use Sleep Mode, change the setting to Off . 🖱️ Extended - Operation - Sleep Mode p.144

The message "Not supported" is displayed

Check	Remedy
Is the image signal format setting correct? (Only when projecting images from a video source)	Change the setting according to the signal for the connected equipment. 🖱️ Signal - Video Signal p.140
Do the image signal resolution and refresh rate correspond to the mode? (Only when projecting computer images)	See the documentation supplied with the computer for how to change the image signal resolution and refresh rate output from the computer. 🖱️ "Supported Monitor Displays" p.201

The message "No Signal" is displayed

Check	Remedy
Are the cables connected correctly?	Check that all the cables required for projection are securely connected. 🖱️ "From Installation to Projection" p.46

Check	Remedy
Is the correct port selected?	Change the image by pressing the [Source Search] button on the remote control, control panel, or the Control Pad. ☛ "Automatically Detect Input Signals and Change the Projected Image (Source Search)" p.47
Is the power of the connected computer or video equipment turned on?	Turn the power on for the equipment.
Are the image signals being output to the projector? (Only when projecting images from a laptop computer or a computer with a built-in LCD screen)	If the image signals are only being output to the computer's LCD monitor or accessory monitor, change the output so that the image signals are also output externally. For some computer models, when the image signals are output externally, they no longer appear on the LCD monitor or accessory monitor. If the connection is made while the power of the projector or computer is already turned on, the Fn key (Function key) that changes the computer's image signal to external output may not work. Turn the projector and computer off and then back on again. ☛ "From Installation to Projection" p.46 ☛ Computer's documentation

Images are fuzzy, out of focus, or distorted

Check	Remedy
Is the focus adjusted correctly?	Move the focus lever to adjust the focus. ☛ "Correcting the Focus" p.56
Is the projector at the correct distance?	Is it projecting outside of the recommended projection distance range? Setup within the recommended range. ☛ "Screen Size and Projection Distance" p.199
Is the Keystone adjustment value too large?	Lower the projection angle to reduce the amount of Keystone correction. ☛ "Adjusting the Vertical Position of the Image (Models Supplied with the Feet Only)" p.55
Is the <u>Aspect Ratio</u>  set correctly?	You can change the Aspect Ratio of the projected image to suit the type, the ratio of height and width, and the resolution of the input signals. ☛ "Changing the Aspect Ratio of the Projected Image" p.59
Has condensation formed on the lens?	If the projector is suddenly taken from a cold environment to a warm environment, or if sudden ambient temperature changes occur, condensation may form on the surface of the lens, and this may cause the images to appear fuzzy. Set the projector up in the room about one hour before it is used. If condensation forms on the lens, turn the projector off and wait for the condensation to disappear.

Interference or distortion appear in images

Check	Remedy
Is the image signal format setting correct? (Only when projecting images from a video source)	Change the setting according to the signal for the connected equipment. ☛ Signal - Video Signal p.140
Are the cables connected correctly?	Check that all the cables required for projection are securely connected. ☛ "Connecting Equipment" p.29
Is an extension cable being used?	If an extension cable is used, electrical interference may affect the signals. Use the cables supplied with the projector to check if the cables you are using may be causing the problem.
Is the correct resolution selected? (Only when projecting computer images)	Set the computer so that the signals being output are compatible with the projector. ☛ "Supported Monitor Displays" p.201 ☛ Computer's documentation
Are the Sync and Tracking settings adjusted correctly? (Only when projecting computer images)	Press the [Auto] button on the remote control or the [↵] button on the control panel to perform automatic adjustment. If the images are not adjusted correctly even after performing automatic adjustment, you can also make adjustments from the Configuration menu. ☛ Signal - Tracking, Sync. p.140
Is the Resolution set to anything other than Auto ? (Only when projecting on a split screen)	The image may be collapsed if the Resolution on the Configuration menu and the resolution of the projected image are not the same. If the image is collapsed, set the Resolution to Auto . ☛ Signal - Resolution p.140
Is Transfer layered window selected? (Only when projecting USB Display)	Click All Programs - EPSON Projector - Epson USB Display - Epson USB Display Vx.xx Settings , and then clear the Transfer layered window checkbox.

The mouse cursor flickers (only when projecting USB Display)







Check	Remedy
Is Make the movement of the mouse pointer smooth. selected?	Click All Programs - EPSON Projector - Epson USB Display - Epson USB Display Vx.xx Settings , and then select Make the movement of the mouse pointer smooth. (Windows 2000 is unavailable.) Windows Aero becomes unavailable if this is selected in Windows Vista/7.

The image is truncated (large) or small, the aspect is not suitable, or the image has been reversed





Check	Remedy
Is a wide-panel computer image being projected? (Only when projecting computer images)	Change the setting according to the signal for the connected equipment. ☛ Signal - Resolution p.140
Is the image still being enlarged by E-Zoom?	Press the [Esc] button on the remote control to cancel E-Zoom. ☛ "Enlarging Part of the Image (E-Zoom)" p.107
Is the display position adjusted correctly?	(Only when projecting analog RGB signals input from the Computer port) Press the [Auto] button on the remote control or the [↵] button on the control panel to adjust the position. You can also adjust the position from the Configuration menu. ☛ Signal - Position p.140
Is the computer set for dual display? (Only when projecting computer images)	If dual display is activated in the Display Properties of the computer's Control Panel, only about half of the image on the computer screen is projected. To display the entire image on the computer screen, turn off the dual display setting. ☛ Computer video driver documentation
Is the correct resolution selected? (Only when projecting computer images)	Set the computer so that the signals being output are compatible with the projector. ☛ "Supported Monitor Displays" p.201 ☛ Computer's documentation
Did you adjust the image position after performing Adjust Zoom or Keystone?	Perform Image Shift to adjust the image position after performing Adjust Zoom or Keystone. ☛ "Adjusting the Position of the Image (Image Shift)" p.54
Is the projection mode correct?	Depending on how the projector is installed, set the projection mode from one of the following: Front , Front/Ceiling , Rear , or Rear/Ceiling . ☛ Extended - Projection p.144 ☛ "Installation Methods" p.27

Image colors are not right

Check	Remedy
Do the input signal settings match the signals from the connected device?	Change the following settings according to the signal for the connected equipment. <ul style="list-style-type: none"> • When the image is from a device connected to the Computer port ☛ Signal - Input Signal p.140 • When the image is from a device connected to the Video port ☛ Signal - Video Signal p.140

Check	Remedy
Is the image Brightness adjusted correctly?	Adjust the Brightness setting from the Configuration menu.  Image - Brightness p.139
Are the cables connected correctly?	Check that all the cables required for projection are securely connected.  "Connecting Equipment" p.29
Is the <u>contrast</u>  adjusted correctly?	Adjust the Contrast setting from the Configuration menu.  Image - Contrast p.139
Is color adjustment set to an appropriate value?	Adjust the Gamma, RGB, or RGBCMY setting from the Configuration menu.  Image - Advanced p.139  "Adjusting the Image" p.57
Are the color saturation and tint adjusted correctly? (Only when projecting images from a video source)	Adjust the Color Saturation and Tint settings from the Configuration menu.  Image - Color Saturation, Tint p.139

Images appear dark

Check	Remedy
Is the image brightness set correctly?	Make Brightness and Power Consumption settings from the Configuration menu.  Image - Brightness p.139  Settings - Power Consumption p.142
Is the <u>contrast</u>  adjusted correctly?	Adjust the Contrast setting from the Configuration menu.  Image - Contrast p.139
Is it time to replace the lamp?	When the lamp is nearly ready for replacement, the images become darker and the color quality declines. Replace the lamp with a new one.  "Replacing the Lamp" p.191

Problems when Projection Starts

The projector does not turn on

Check	Remedy
Did you press the [⏻] button?	Press the [⏻] button to turn the power on.
Are all of the indicators off?	The power cord is not connected correctly or power is not being supplied. Disconnect and then reconnect the power cord. ☛ "From Installation to Projection" p.46 Check the breaker and so on to ensure power is being supplied.
Do the indicators turn on and off when the power cord is touched?	There is probably a poor contact in the power cord, or the power cord may be defective. Reinsert the power cord. If this does not solve the problem, stop using the projector, disconnect the power cord from the electrical outlet, and contact your local dealer or the nearest address provided in the Epson Projector Contact List. ☛ Epson Projector Contact List
Is the Control Panel Lock set to Full Lock ?	Press the [⏻] button on the remote control. If you do not want to use Control Panel Lock , change the setting to Off . ☛ Settings - Control Panel Lock p.142
Is the remote receiver set correctly?	Check the Remote Receiver from the Configuration menu. ☛ Settings - Remote Receiver p.142

Problems with the Interactive Function

Cannot use the projector's drawing function

Check	Remedy
Has pen calibration been performed correctly?	Make sure you perform pen calibration when using the Easy Interactive Pen for the first time so that the projector recognizes the position of the pen correctly. Also, calibrate the pen again if you notice any discrepancy in positioning. ☛ "Auto Calibration" p.65
Is Pen Mode set to PC Interactive ?	Set Pen Mode to PC Free Annotation from the Configuration menu. ☛ Extended - Easy Interactive Function - Pen Mode p.144

Cannot operate as a mouse and draw by connecting to a computer

Check	Remedy
Is Extended set correctly?	Set the following to perform PC Interactive. <ul style="list-style-type: none"> • Set Extended - USB Type B to Easy Interactive Function or USB Display/Easy Interactive Function from the configuration menu. When using USB Display, set USB Display/Easy Interactive Function. • Set Pen Mode to PC Interactive from the Configuration menu. 🖱️ Extended - Easy Interactive Function p.144
The projector is not correctly connected to the computer.	Check the USB cable connections. You may be able to resolve the problem by disconnecting and then reconnecting the USB cable.
If you are using a notebook computer when the battery power is running low, the USB port may stop working and you might not be able to use USB devices.	Connect the computer to a power source.
Is Pen Operation Mode set to Pen ?	Set Pen Operation Mode to Mouse from the Configuration menu to perform PC Interactive. 🖱️ Extended - Easy Interactive Function - Pen Operation Mode p.144

The message "An error occurred in the Easy Interactive Function." is displayed

Check	Remedy
An error has occurred in the interactive function.	Contact the nearest address provided in the Epson Projector Contact List. 🖱️ Epson Projector Contact List

Computer's mouse does not work correctly

Check	Remedy
Is the Easy Interactive Pen placed on the projection screen?	Remove the Easy Interactive Pen from the projection screen, or turn it off.

The Easy Interactive Pen does not work

Check	Remedy
There is an obstacle in the signal route between the Easy Interactive Pen and the projector.	Remove the obstacle. Also, do not block the signal route when standing in front of the projection screen.
The signal is interfering with other things such as a light source that is emitting infrared rays.	Do not use an infrared remote control or infrared microphone in the same room because the Easy Interactive Pen may malfunction. Switch off the interfering device such as a light source that is emitting infrared rays.
The battery is low.	Replace the battery.
The surrounding area is too bright.	Do not allow strong light to shine on the projected screen or the projector's Easy Interactive Function receiver.
Has pen calibration been performed correctly?	Make sure you perform pen calibration when using the Easy Interactive Pen for the first time so that the projector recognizes the position of the pen correctly. Also, calibrate the pen again if you notice any discrepancy in positioning. ☛ "Auto Calibration" p.65
Are multiple projectors being used in the same room?	If multiple projectors are being used in the same room, Easy Interactive Pen operations may become unstable depending on the environment. Change the Distance of Projectors setting from the Configuration menu. ☛ Extended - Easy Interactive Function - Distance of Projectors p.144

The response time for the Easy Interactive Pen is slow

Check	Remedy
Is Windows Aero enabled? (Windows Vista/7 only)	The reaction time for the Easy Interactive Pen may be slow when Windows Aero is enabled. Disable the Windows Aero function on the computer. When using USB Display: Click All Programs - EPSON Projector - Epson USB Display - Epson USB Display Vx.xx Settings , and then select Disable Windows Aero and improve the tracking of the interactive pen .

The dot does not move to the next position

Check	Remedy
Information from the projection screen is not correctly received due to other things, such as a light source that is emitting infrared rays.	Move the device, such as a light source that is emitting infrared rays, away from the projector, or move the projector away from the device.

Check	Remedy
Information from the projection screen may not be received correctly if the projector is too close to the screen.	Check the position of the projector.

The dot moves automatically

Check	Remedy
The Easy Interactive Pen is disabled due to unstable conditions in the surrounding area, such as a light source that is emitting infrared rays.	Move the projector or turn off the interfering device, such as a light source that is emitting infrared rays.

Cannot perform operations while capturing, printing, or saving

Check	Remedy
Did you change to operations using the remote control, or Control Pad while making operations using the Easy Interactive Pen or vice-versa?	If you start operations using the Easy Interactive Pen, make all operations using the Easy Interactive Pen. If you start operations using the remote control or the Control Pad, make all operations using the remote control or the Control Pad.

Cannot paste the capture of the projected screen correctly

Check	Remedy
Is the projected image protected?	Protected content cannot be captured.
Is there a black frame around the edge?	If you use the [Wide] or [Tele] buttons or Image Shift, a black frame may appear around the edge of the image.

Cannot print normally

Check	Remedy
Is the printer connected correctly?	For USB connections, check that the projector's USB-A port is connected to the Control Pad's USB-A port (for printers). For network connections, check the current setting on the Whiteboard settings screen. Next, perform Test Print to check that you can print normally.

Check	Remedy
Are two USB printers connected?	Only connect one USB printer.
Has an error occurred in the printer?	Operate the printer and release the error.

Cannot scan normally

Check	Remedy
Is the printer connected correctly?	If the printer is not connected correctly, the scanner function does not work. Also, stand-alone scanner are not supported.
Has an error occurred in the printer?	Operate the printer and release the error. If an error has occurred in the printer, the printer's scanner function does not work.
Is paper loaded in the ADF when scanning from the ADF?	When scanning from the ADF, make sure you load paper in advance.

The time is out of sync, settings for the internal storage are not reflected correctly

Check	Remedy
Is the time set correctly?	The time needs to be set to correctly reflect clock and internal storage settings for Whiteboard Mode. ☛ "Setting Schedule" p.133

Cannot change the source

Check	Remedy
Are the functions Open, Scan, Save, or Print being performed?	Processing may take some time. You cannot change the source during processing. If you want to change the source during processing, cancel the operation that is being processed.

Other Problems

No sound can be heard or the sound is faint

Check	Remedy
Check that the audio/video cable is securely attached to both the projector and audio source.	Disconnect the cable from the audio input port, and then reconnect the cable.
Is the projector volume set to the minimum?	Adjust the volume so that sound can be heard. ☛ Settings - Volume p.142 ☛ "Adjusting the Volume" p.56
Is the volume for the computer or from the image source set to the minimum?	Adjust the volume so that sound can be heard.
Is A/V Mute active?	Press the [A/V Mute] button on the remote control to cancel A/V Mute. ☛ "Hiding the Image and Sound Temporarily (A/V Mute)" p.105
Is the audio cable's specification "No resistance"?	When using a commercially available audio cable, make sure it is labeled "No resistance".
Is it connected with an HDMI cable?	If no audio is output when connecting via an HDMI cable, set the connected equipment to PCM output.
Is Output audio from the projector selected? (Only when projecting USB Display)	Click All Programs - EPSON Projector - Epson USB Display - Epson USB Display Vx.xx Settings , and then select Output audio from the projector .
Is the correct audio input selected?	Check the Audio Input from the configuration menu. ☛ Extended - Audio Input Setup p.144

There is noise in the audio (only when projecting USB Display)

Check	Remedy
Is the volume for the computer set to minimum while the projector's volume is set to maximum?	The audio may contain noise if the volume for the computer is set to minimum while the projector's volume is set to maximum. Increase the volume for the computer, and decrease the volume for the projector.

The remote control does not work

Check	Remedy
Is the remote control light-emitting area pointing towards the remote receiver on the projector during operation?	Point the remote control towards the remote receiver during operation. ☛ "Remote control operating range" p.20
Is the remote control too far from the projector?	The operating range for the remote control is about 6 m. ☛ "Remote control operating range" p.20
Is direct sunlight or strong light from fluorescent lamps shining onto the remote receiver?	Set the projector up in a location where strong light does not shine onto the remote receiver. Or set the remote receiver to Off from Remote Receiver in the Configuration menu. ☛ Settings - Remote Receiver p.142
Is the correct setting for the Remote Receiver selected?	Check the Remote Receiver from the Configuration menu. ☛ Settings - Remote Receiver p.142
Are the batteries dead or have the batteries been inserted in the wrong direction?	Insert new batteries in the correct direction. ☛ "Replacing the remote control batteries" p.19

I want to change the language for messages and menus

Check	Remedy
Change the language setting.	Adjust the Language setting from the Configuration menu. ☛ Extended - Language p.144

The authentication setting of wireless LAN fails

Check	Remedy
Is the time set correctly?	If the wireless LAN is set correctly but the authentication setting fails, the time may not be set correctly. Check if it is set correctly. ☛ Extended - Time/Schedule Settings p.144

Mail is not received even if an error occurs with the projector

Check	Remedy
Is Standby Mode set to Networked Standby or A/V Standby ?	To use the Mail Notification function when the projector is in standby, set Networked Standby or A/V Standby in Standby Mode from the Configuration menu. ☛ Extended - Standby Mode p.144
Did a fatal abnormality occur and the projector come to a sudden stop?	When the projector comes to a sudden stop, email cannot be sent. If the abnormal state continues, contact your local dealer or the nearest address provided in the Epson Projector Contact List. ☛ Epson Projector Contact List
Is power being supplied to the projector?	Check that your electrical outlet or power source is functioning correctly.
Is the Mail Notification function set correctly in the Configuration menu?	An error notification email is sent according to the Mail settings in the Configuration menu. Check if it is set correctly. ☛ "Administrator Settings menu" p.158

The message "The battery that saves your clock settings is running low." is displayed

Check	Remedy
The internal power supply that saves your clock settings is running low.	Contact your local dealer or the nearest address provided in the Epson Projector Contact List. ☛ Epson Projector Contact List

Image file names are not displayed correctly in PC Free

Check	Remedy
Is the file name too long?	The file name can be up to 8 characters long. For file names longer than this, the middle of the name is omitted to shorten the name to 8 characters.







Cannot change settings using a web browser

Check	Remedy
Are the user ID and password correct?	Enter "EPSONWEB" as the user ID. This cannot be changed. Enter the user ID even if the password setting is disabled. Enter the password you set in Web Control Password. The default password is "admin".

Check the numbers and then apply the following countermeasures. If you cannot resolve the problem, contact your network administrator, or contact your local dealer or the nearest address provided in the Epson Projector Contact List.

 [Epson Projector Contact List](#)

Event ID	Cause	Remedy
0432 0435	Failed to startup EasyMP Network Projection.	Restart the projector.
0434 0482 0484 0485	Network communication is unstable.	Check the network communication status, and reconnect after waiting for a while.
0433	Cannot play transferred images.	Restart EasyMP Network Projection.
0481	Communication was disconnected from the computer.	
0483 04FE	EasyMP Network Projection ended unexpectedly.	Check the network communication status, and then restart the projector.
0479 04FF	A system error occurred in the projector.	Restart the projector.
0891	Cannot find an access point with the same SSID.	Set the computer, the access point, and the projector to the same SSID.
0892	The WPA/WPA2 authentication type does not match.	Check that the wireless LAN security settings are correct.
0893	The WEP/TKIP/AES encryption type does not match.	 "Security menu " p.155
0894	Communication was disconnected because the projector connected to an unauthorized access point.	Contact your network administrator for more information.
0898	Failed to acquire DHCP.	Check that the DHCP server is operating correctly. If you are not using DHCP, turn off the DHCP setting.  "Network Menu" p.150
0899	Other communication errors	If restarting the projector or EasyMP Network Projection does not solve the problem, contact your local dealer or the nearest address provided in the Epson Projector Contact List.  Epson Projector Contact List
089A	The EAP authentication type is not the same.	Check that the wireless LAN security settings are correct. Also, check if the certificate is installed correctly.

Event ID	Cause	Remedy
089B	EAP server authentication failed.	 "Security menu " p.155
089C	EAP client authentication failed.	
089D	Key exchange failed.	
0B01	The built-in storage could not be detected correctly.	Perform Delete All Internal Data . When the internal storage is deleted correctly, plugin the power cord for the projector and turn it on. If it is not deleted correctly, contact your local dealer or the nearest address provided in the Epson Projector Contact List.  Epson Projector Contact List
0BFF	An error has occurred in the Whiteboard function.	Restart the projector.



Maintenance

This chapter provides information on maintenance procedures to ensure the best level of performance from the projector for a long time to come.

You should clean the projector if it becomes dirty or if the quality of projected images starts to deteriorate.

Attention

Turn off the projector's power before cleaning. Otherwise, it could cause an electric shock.

Cleaning the Projector's Surface

Clean the projector's surface by wiping it gently with a soft cloth.

If the projector is particularly dirty, moisten the cloth with water containing a small amount of neutral detergent, and then firmly wring the cloth dry before using it to wipe the projector's surface.

Attention

Do not use volatile substances such as wax, alcohol, or thinner to clean the projector's surface. The quality of the case may change or become discolored.

Cleaning the Projection Window

Use a commercially available cloth for cleaning glasses to gently wipe the projection window.

Warning

Do not use sprays that contain flammable gas to remove dirt and dust from the lens. The projector may catch fire because of the high temperature of the lamp inside the projector.

Attention

Do not rub the lens with harsh materials or subject the lens to shocks, as it can easily become damaged.

Cleaning the Obstacle Sensor

Clean the obstacle sensor when the message "Remove any obstacles that are interfering with the projection area." is displayed along with a warning sound. Use a commercially available cloth for cleaning glasses to gently wipe the obstacle sensor.

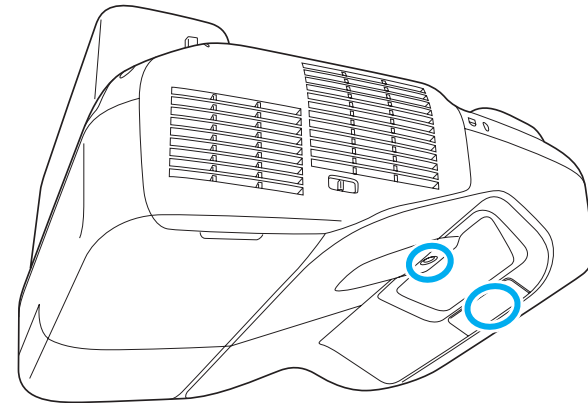

Warning

Do not use sprays that contain flammable gas to remove dirt and dust from the obstacle sensor. The projector may catch fire because of the high temperature of the lamp inside the projector.

Attention

Do not rub the obstacle sensor with harsh materials or subject the sensor to shocks.

Damage on the surface of the sensor may cause malfunctions.



- If a message is frequently displayed, even after cleaning, it is time to replace the air filter. Replace it with a new air filter.
 - "Replacing the Air Filter" [p.194](#)
- It is recommended that you clean these parts at least once every three months. Clean them more often than this if using the projector in a particularly dusty environment.

Cleaning the Air Filter

Clean the air filter and the air intake vent when the following message is displayed.

"The projector is overheating. Make sure nothing is blocking the air vent, and clean or replace the air filter."

Attention

- Dust collecting on the air filter may cause the internal temperature of the projector to rise, leading to a malfunction or early deterioration of optical parts. Clean the air filter immediately when the message is displayed.
- Do not rinse the air filter in water. Do not use detergents or solvents.

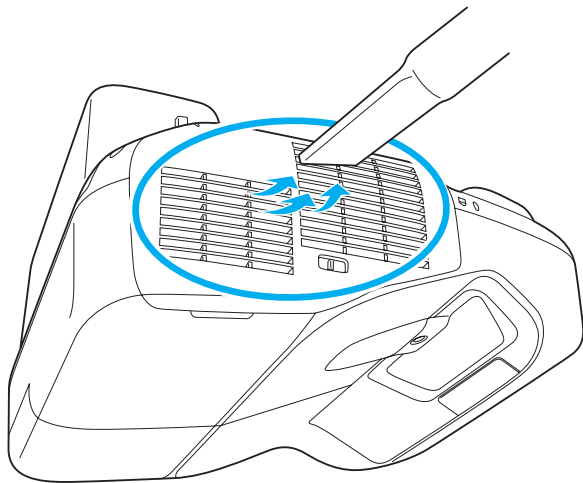

This section explains how to replace the lamp and the air filter.

Replacing the Lamp

Lamp replacement period

It is time to replace the lamp when:

- The following message is displayed.
"It is time to replace your lamp. Please contact your Epson projector reseller or visit www.epson.com to purchase."



The message is displayed for 30 seconds.

- The lamp indicator flashes orange.

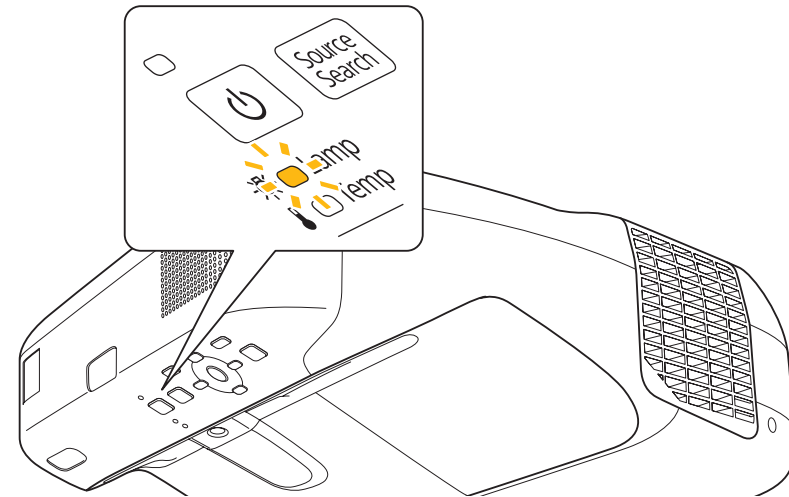

- The projected image gets darker or starts to deteriorate.

Attention

- The lamp replacement message is set to appear after the following time periods in order to maintain the initial brightness and quality of the projected images.
When using **Power Consumption** continually at **Normal**: About 3400 hours
When using **Power Consumption** continually at **ECO**: About 4900 hours
☛ **Settings - Power Consumption** [p.142](#)
- If you continue to use the lamp after the replacement period has passed, the possibility that the lamp may blow increases. When the lamp replacement message is displayed, replace the lamp with a new one as soon as possible, even if it is still working.
- Do not repeatedly turn off the power and immediately back on. Turning the power on and off frequently may shorten the lamp's operating life.
- Depending on the individual characteristics of the lamp and the way it has been used, the lamp may become darker or stop working before the message is displayed. You should always have a spare lamp unit ready in case it is needed.

How to replace the lamp

The lamp can be replaced even when the projector is suspended from a wall or ceiling.

Warning

- When replacing the lamp because it has stopped working, there is a possibility that the lamp may be cracked. When replacing the lamp of a projector that has been installed on a wall or ceiling, assume that the lamp is cracked and stand to the side of the lamp cover, not underneath it. Also, remove the lamp cover gently. Be careful when removing the lamp cover as shards of glass may fall out and could cause an injury. If any shards of glass get into your eyes or mouth, contact your local physician immediately.
- Never disassemble or modify a lamp. If a modified or disassembled lamp is installed in the projector and used, it could cause a fire, electric shock, or an accident.

Caution

Wait until the lamp has cooled down sufficiently before removing the lamp cover. If the lamp is still hot, burns or other injuries may result. It takes approximately one hour after the power has been turned off for the lamp to sufficiently cool down.

- 1** After you turn off the projector's power and the confirmation buzzer beeps twice, disconnect the power cord.
- 2** Wait until the lamp has sufficiently cooled down, and then remove the lamp cover at the top of the projector.
Loosen the lamp cover fixing screw with the screwdriver supplied with the new lamp unit or a cross-head screwdriver. Then slide the lamp cover straight forward and lift to remove it.

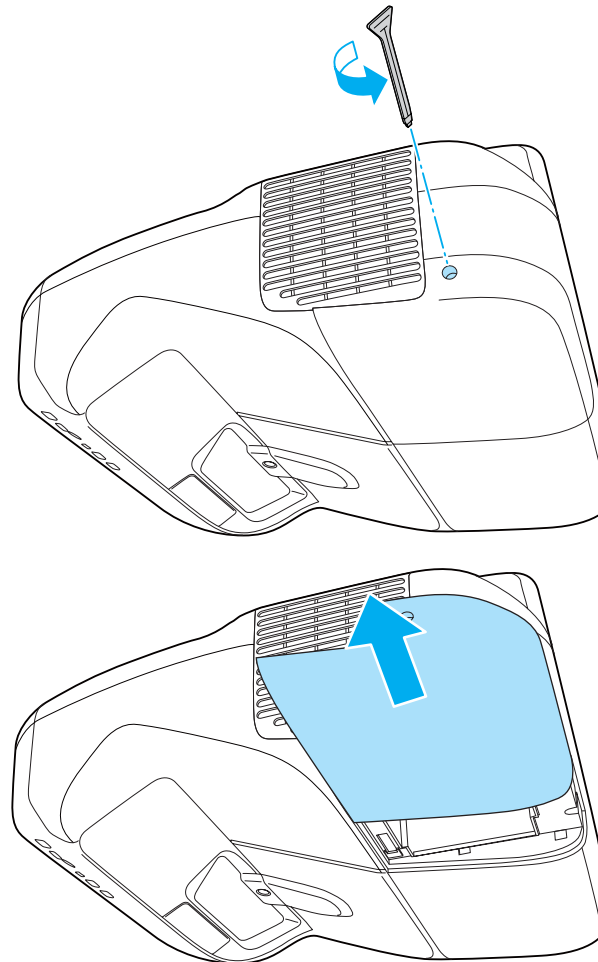

- 3** Loosen the two lamp fixing screws.

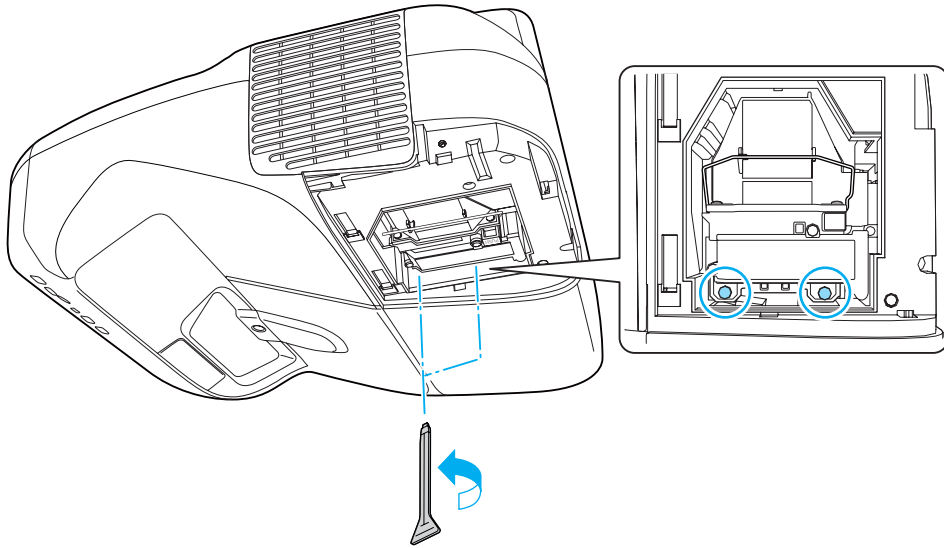

- 4** Remove the old lamp by pulling the handle.
If the lamp is cracked, replace it with a new lamp, or contact your local dealer for further advice.

 [Epson Projector Contact List](#)

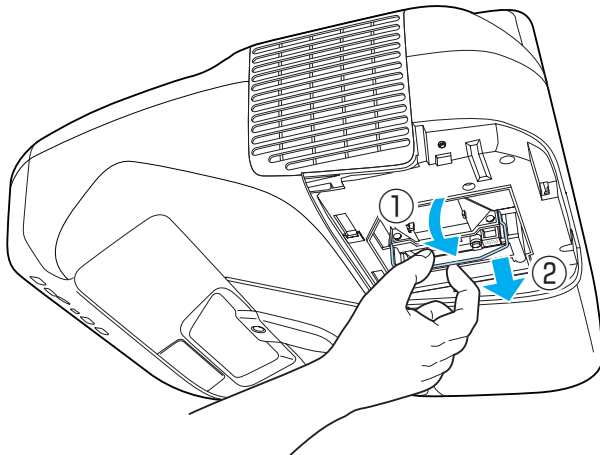

- 5** Install the new lamp.
Insert the new lamp along the guide rail in the correct direction so that it fits in place, push in firmly, and then press the handle down. Tighten the two lamp fixing screws.

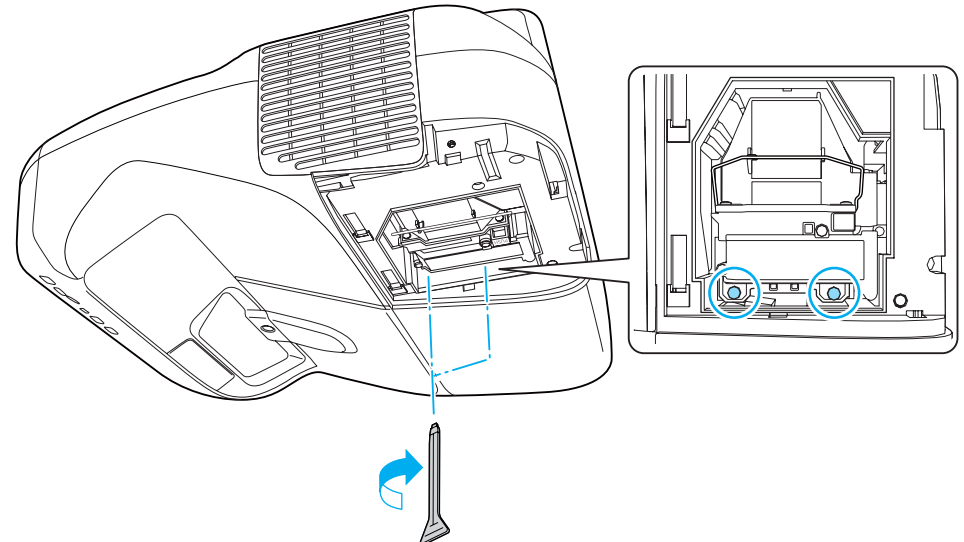
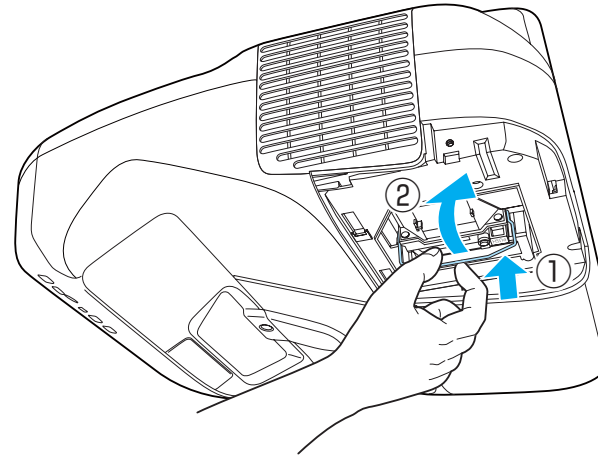

- 6** Attach the lamp cover.

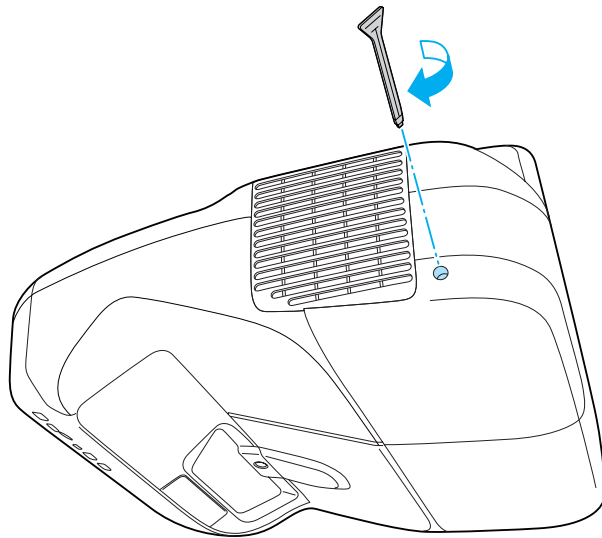

Attention

- Make sure you install the lamp securely. If the lamp cover is removed, the power turns off automatically as a safety precaution. If the lamp or the lamp cover is not installed correctly, the power does not turn on.
- This product includes a lamp component that contains mercury (Hg). Please consult your local regulations regarding disposal or recycling. Do not dispose of it with normal waste.



Only reset the lamp hours after the lamp has been replaced. Otherwise, the lamp replacement period will not be indicated correctly.

Replacing the Air Filter

Air filter replacement period

If the message is displayed frequently even though the air filter has been cleaned, replace the air filter.

How to replace the air filter

The air filter can be replaced even when the projector is suspended from a wall or ceiling.

- 1** After you turn off the projector's power and the confirmation buzzer beeps twice, disconnect the power cord.
- 2** Open the air filter cover.
Press the tabs on the air filter cover and open the cover.

Resetting the lamp hours

The projector records how long the lamp is on and a message and indicator notify you when it is time to replace the lamp. After replacing the lamp, make sure you reset the lamp hours from the Configuration menu.

☛ "Reset Menu" [p.163](#)

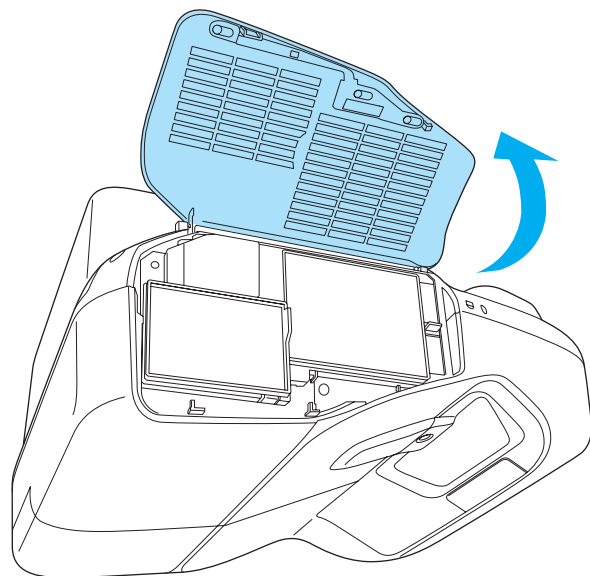
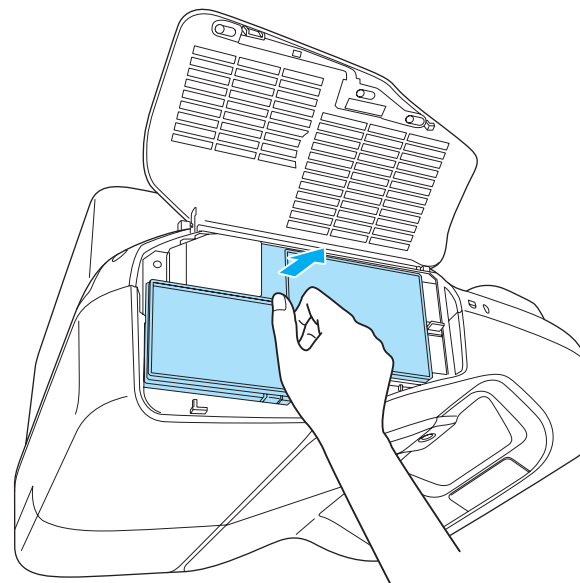
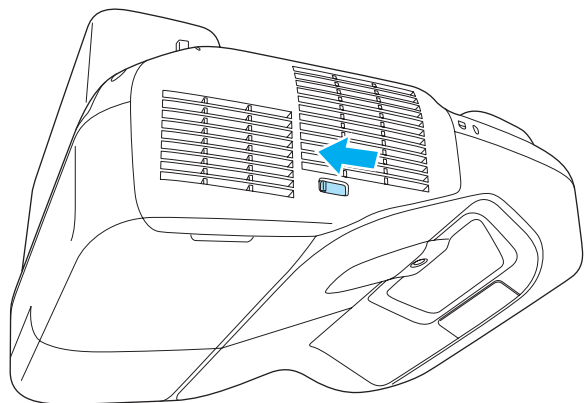

- 3** Remove the air filter.
Grip the tab in the center of the air filter, and pull the air filter straight out.

- 4** Install the new air filter.

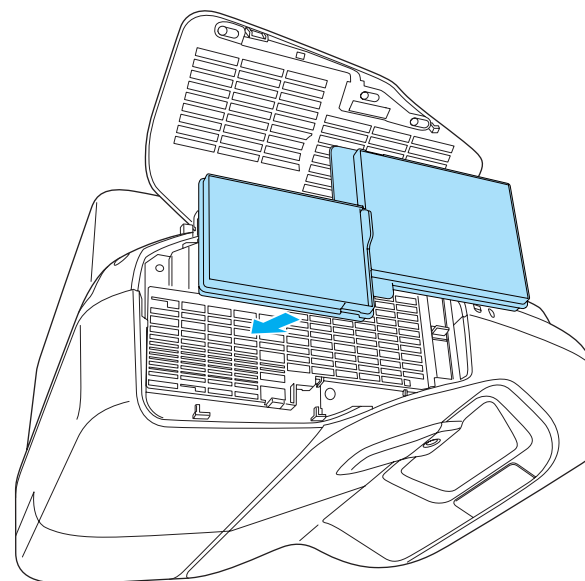

5 Close the air filter cover.

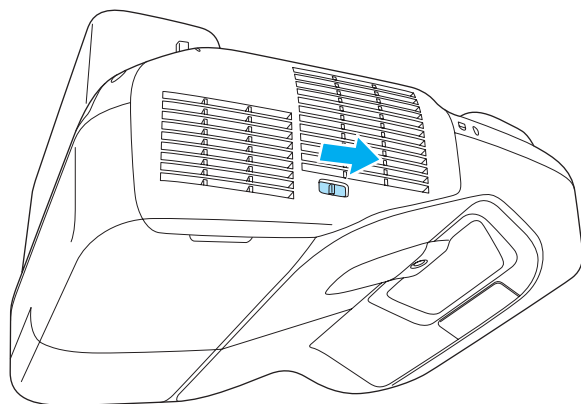
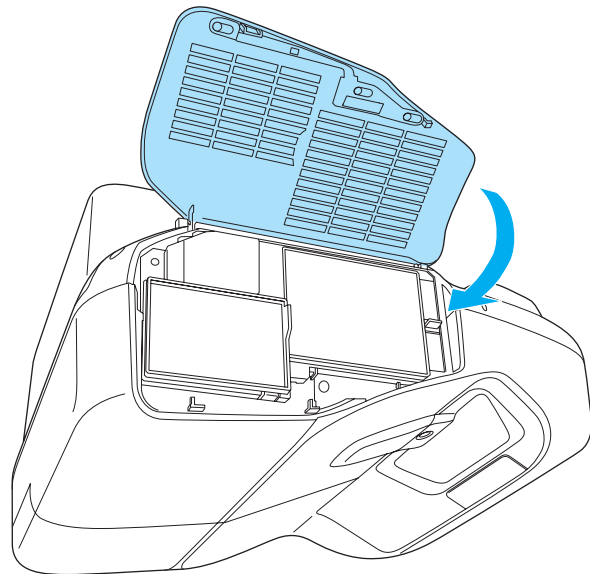

Dispose of used air filters properly in accordance with your local regulations.

Material of the frame part: Polypropylene

Material of the filter part: Polypropylene



Appendix

The following optional accessories and consumables are available. Please purchase these products as and when needed. The following list of optional accessories and consumables is current as of: September 2012. Details of accessories are subject to change without notice.

Optional Accessories

Document Camera ELPDC06/ELPDC11/ELPDC20 Use when projecting images such as books, OHP documents, or slides.
Computer cable ELPKC02 (1.8 m - for mini D-Sub15-pin/mini D-Sub 15pin)
Computer cable ELPKC09 (3 m - for mini D-Sub15-pin/mini D-Sub 15pin)
Computer cable ELPKC10 (20 m - for mini D-Sub15-pin/mini D-Sub 15pin)
D port cable ELPKC22 (Mini D-Sub 15-pin/3 m for D port) Use when connecting to the D port on an image source.
Component video cable ELPKC19 (3 m - for mini D-Sub 15-pin/RCA male×3) Use to connect a Component Video source.
Quick Wireless Connection USB Key ELPAP09 Use when you want to quickly establish one-to-one connection between the projector and a computer with Windows installed.
Interactive Table Mount ELPMB29 Use when installing the projector on a table.
Ceiling mount* ELPMB23 Use when installing the projector on a ceiling.
Easy Interactive Pen ELPPN03A/ELPPN03B Pens for the interactive function. You cannot use Easy Interactive Pens with the same model number at the same time.

Interactive Pen Extension ELPPE01

Attach to the Easy Interactive Pen to extend the pen and use it as a pointer.

Replacement Pen Tips ELPPS01

Replacement pen tips for the Easy Interactive Pen.

Remote control cable set ELPKC28

Cable to connect the projector to the Control Pad.

* Special expertise is required to suspend the projector. Contact your local dealer or the nearest address provided in the Epson Projector Contact List.

 [Epson Projector Contact List](#)

Consumables

Lamp unit ELPLP71

Use as a replacement for a used lamp.

Air Filter ELPAF40

Use as a replacement for a used air filter.

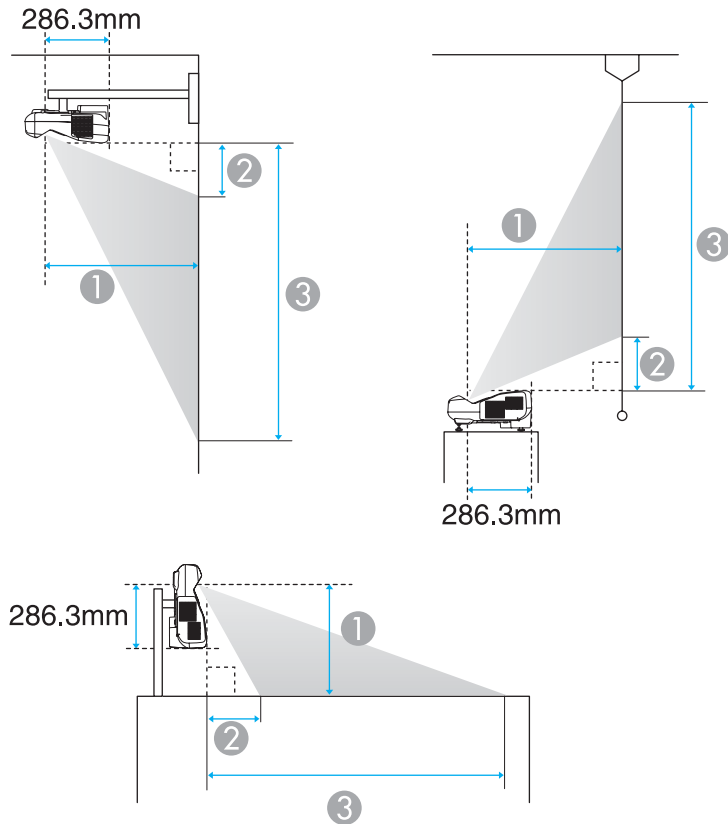

① Projection distance

② The distance between the projector and the top of the screen (when mounting on a wall or ceiling, or installing vertically)
The distance between the projector and the bottom of the screen (when placing on a surface such as a desk)

③ The distance between the projector and the bottom of the screen (when mounting on a wall or ceiling, or installing vertically)
The distance between the projector and the top of the screen (when placing on a surface such as a desk)

Unit: cm

16:10 Screen Size		①	②	③
		Minimum (Wide) to Maximum (Tele)	Minimum (Wide)	Minimum (Wide)
60"	129x81	35 ~ 48	8	89
70"	151x94	41 ~ 56	11	105
80"	172x108	47 ~ 60	13	121
90"	194x121	53 ~ 60	16	137
100"	215x135	60*	19	153

* Project using Wide (maximum zoom).

Unit: cm

4:3 Screen Size		①	②	③
		Minimum (Wide) to Maximum (Tele)	Minimum (Wide)	Minimum (Wide)
53"	108x81	35 ~ 48	8	89
60"	122x91	40 ~ 55	10	102
70"	142x107	47 ~ 60	13	120
80"	163x122	54 ~ 60	16	138
88"	179x134	59 ~ 60	19	153

Unit: cm

16:9 Screen Size		①	②	③
		Minimum (Wide) to Maximum (Tele)	Minimum (Wide)	Minimum (Wide)
59"	131x74	35 ~ 48	12	86
60"	133x75	36 ~ 49	13	87
70"	155x87	42 ~ 58	16	103
80"	177x100	49 ~ 60	19	119

16:9 Screen Size		①	②	③
		Minimum (Wide) to Maximum (Tele)	Minimum (Wide)	Minimum (Wide)
90"	199x112	55 ~ 60	23	135
97"	215x121	60*	25	146

* Project using Wide (maximum zoom).

Supported Resolutions

Computer signals (analog RGB)

Signal	Refresh Rate (Hz)	Resolution (dots)
VGA	60/72/75/85	640x480
SVGA	56/60/72/75/85	800x600
XGA	60/70/75/85	1024x768
WXGA	60	1280x768
	60	1366x768
	60/75/85	1280x800
WXGA+	60/75/85	1440x900
WXGA++	60	1600x900
SXGA	70/75/85	1152x864
	60/75/85	1280x960
	60/75/85	1280x1024
SXGA+	60/75	1400x1050
WSXGA+*1	60	1680x1050
UXGA	60	1600x1200
MAC13"	67	640x480
MAC16"	75	832x624
MAC19"	75	1024x768
	59	1024x768
MAC21"	75	1152x870

*1 Only compatible when **Wide** is selected as the **Resolution** from the Configuration menu.

Images may also be projected when signals other than the above are input. However, some functions may be limited.

Component Video

Signal	Refresh Rate (Hz)	Resolution (dots)
SDTV (480i)	60	720x480
SDTV (576i)	50	720x576
SDTV (480p)	60	720x480
SDTV (576p)	50	720x576
HDTV (720p)	50/60	1280x720
HDTV (1080i)	50/60	1920x1080

Composite video

Signal	Refresh Rate (Hz)	Resolution (dots)
TV (NTSC)	60	720x480
TV (SECAM)	50	720x576
TV (PAL)	50/60	720x576

Input signal from the HDMI port and DisplayPort

Signal	Refresh Rate (Hz)	Resolution (dots)
VGA	60	640x480
SVGA	60	800x600
XGA	60	1024x768
WXGA	60	1280x800
	60	1280x768*1
	60	1366x768
WXGA+	60	1440x900
WXGA++	60	1600x900



Signal	Refresh Rate (Hz)	Resolution (dots)
WSXGA+	60	1680x1050
SXGA	60	1280x960
	60	1280x1024
SXGA+	60	1400x1050
UXGA	60	1600x1200
SDTV(480i*2/480p)	60	720x480
SDTV(576i*2/576p)	50	720x576
HDTV (720p)	50/60	1280x720
HDTV(1080i)*2	50/60	1920x1080
HDTV (1080p)	24*2/30*2/50/60	1920x1080

*1 DisplayPort input only

*2 HDMI input only

Projector General Specifications

Product name		EB-1410Wi	EB-1400Wi
Dimensions		367 (W) x 155 (H) x 375 (D) mm (not including raised section)	
LCD panel size		0.59" Wide	
Display method		Polysilicon TFT active matrix	
Resolution		1,024,000 WXGA (1280 (W) x 800 (H) dots)x 3	
Focus adjustment		Manual	
Zoom adjustment		Digital (1-1.35)	
Lamp		UHE lamp, 215 W Model No.: ELPLP71	
Max. audio output		10 W	
Speaker		1	
Power supply		100-240V AC±10% 50/60Hz 3.2-1.5A	100-240V AC±10% 50/60Hz 3.0-1.4A
Power consumption	100 to 120 V area	Operating: 322 W Standby power consumption (Networked Standby): 4.6 W Standby power consumption (Energy Saving): 0.20 W	Operating: 294 W Standby power consumption (Networked Standby): 4.6 W Standby power consumption (Energy Saving): 0.20 W
	220 to 240 V area	Operating: 307 W Standby power consumption (Networked Standby): 5.0 W Standby power consumption (Energy Saving): 0.27 W	Operating: 281 W Standby power consumption (Networked Standby): 5.0 W Standby power consumption (Energy Saving): 0.27 W
Operating altitude		Altitude 0 to 2,286 m	
Operating temperature		5 to +35°C (No condensation)	
Storage temperature		-10 to +60°C (No condensation)	
Mass		Approx. 5.6 kg	

Connectors	Computer port	1	Mini D-Sub15-pin (female)
	DisplayPort	1	DisplayPort
	Video port	1	RCA pin jack
	Audio1 port	1	Stereo mini pin jack
	Audio2 port	1	Stereo mini pin jack
	Audio3 port	1	Stereo mini pin jack
	Audio Out port	1	Stereo mini pin jack
	Remote port	1	Stereo mini pin jack
	Monitor Out port	1	Mini D-Sub15-pin (female)
	HDMI port	1	HDMI (Audio is only supported by PCM)
	USB-A port*	2	USB connector (Type A)
	USB-B port*	1	USB connector (Type B)
	USB port (for Wireless LAN unit)	1	USB connector (Type A)
	LAN port	1	RJ-45
	RS-232C port	1	Mini D-Sub 9-pin (male)

* Supports USB 2.0. However, the operation of all USB compatible devices is not guaranteed.

This product is also designed for IT power distribution system with phase-to-phase voltage 230V.

Angle of tilt

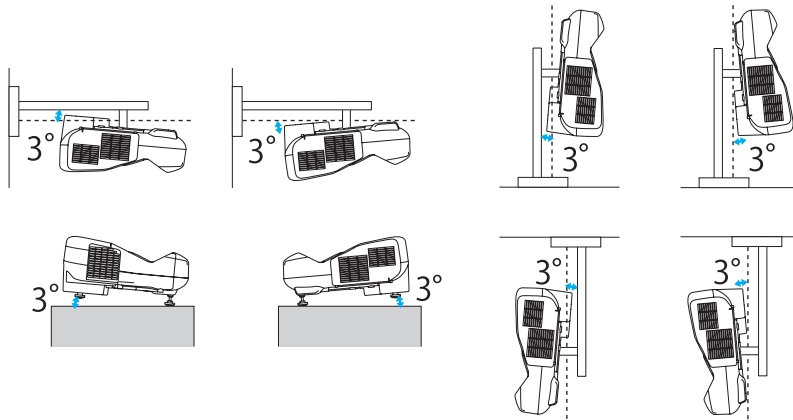

If you use the projector tilted at an angle of more than 3° it could be damaged and cause an accident.

DECLARATION of CONFORMITY

According to 47CFR, Part 2 and 15

Class B Personal Computers and Peripherals; and/or
CPU Boards and Power Supplies used with Class B Personal Computers

We: Epson America, Inc.
Located at: 3840 Kilroy Airport Way
MS: 3-13
Long Beach, CA 90806
Tel: 562-290-5254

Declare under sole responsibility that the product identified herein, complies with 47CFR Part 2 and 15 of the FCC rules as a Class B digital device. Each product marketed, is identical to the representative unit tested and found to be compliant with the standards. Records maintained continue to reflect the equipment being produced can be expected to be within the variation accepted, due to quantity production and testing on a statistical basis as required by 47CFR 2.909. Operation is subject to the following two conditions : (1) this device may not cause harmful interference, and (2) this device must accept any interference received, including interference that may cause undesired operation.

Trade Name: EPSON
Type of Product: LCD Projector
Model: H480C/H481C

**FCC Compliance Statement
For United States Users**

This equipment has been tested and found to comply with the limits for a Class B digital device, pursuant to Part 15 of the FCC Rules. These limits are designed to provide reasonable protection against harmful interference in a residential installation. This equipment generates, uses, and can radiate radio frequency energy and, if not installed and used in accordance with the instructions, may cause harmful interference to radio communications. However, there is no guarantee that interference will not occur in a particular installation. If this equipment does cause interference to radio or television reception, which can be determined by turning the equipment off and on, the user is encouraged to try to correct the interference by one or more of the following measures.

- Reorient or relocate the receiving antenna.
- Increase the separation between the equipment and receiver.
- Connect the equipment into an outlet on a circuit different from that to which the receiver is connected.
- Consult the dealer or an experienced radio/TV technician for help.

WARNING

The connection of a non-shielded equipment interface cable to this equipment will invalidate the FCC Certification or Declaration of this device and may cause interference levels which exceed the limits established by the FCC for this equipment. It is the responsibility of the user to obtain and use a shielded equipment interface cable with this device. If this equipment has more than one interface connector, do not leave cables connected to unused interfaces. Changes or modifications not expressly approved by the manufacturer could void the user's authority to operate the equipment.

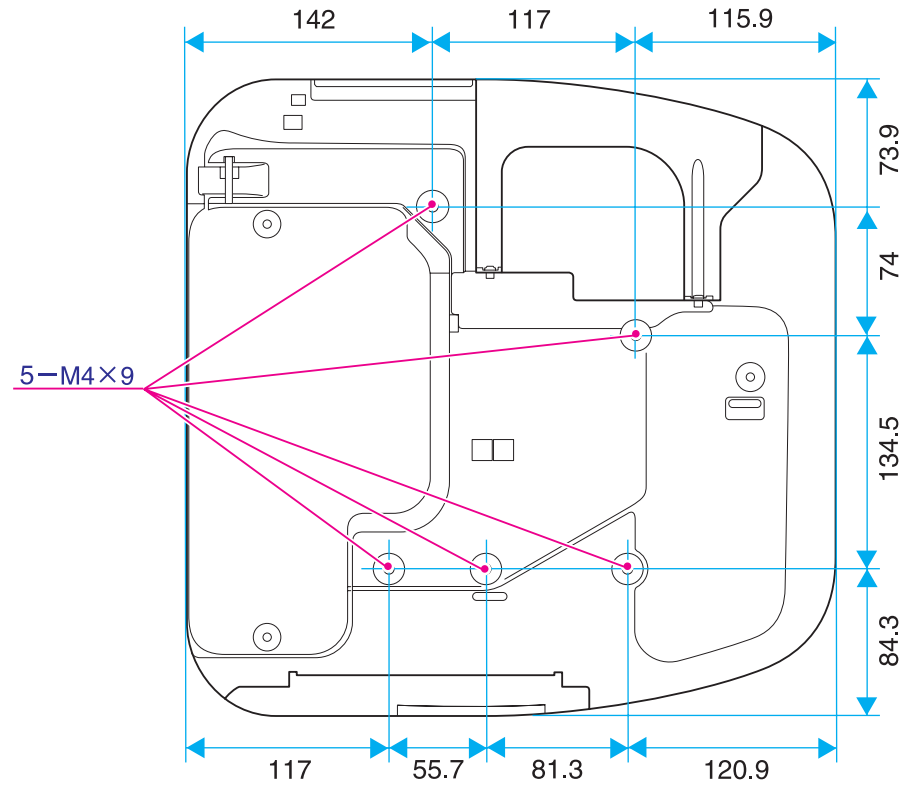
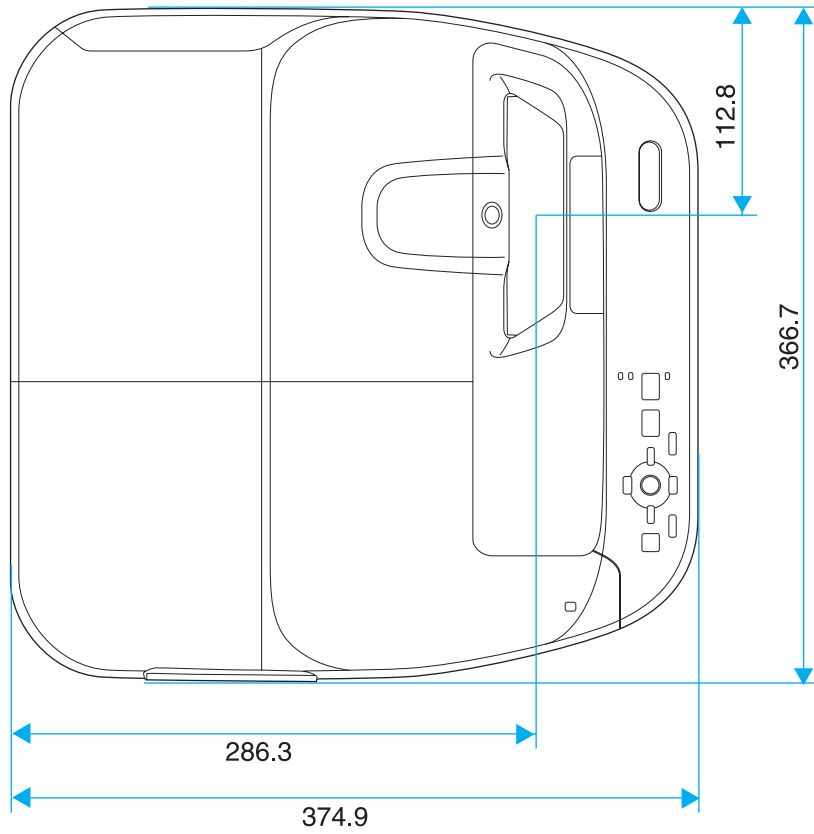

Units: mm

Without feet

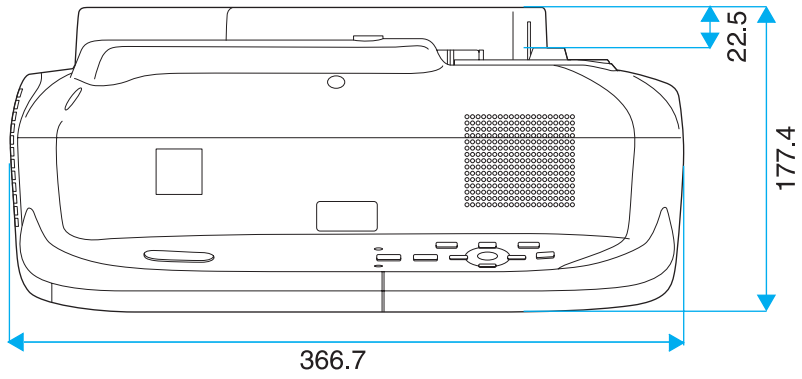

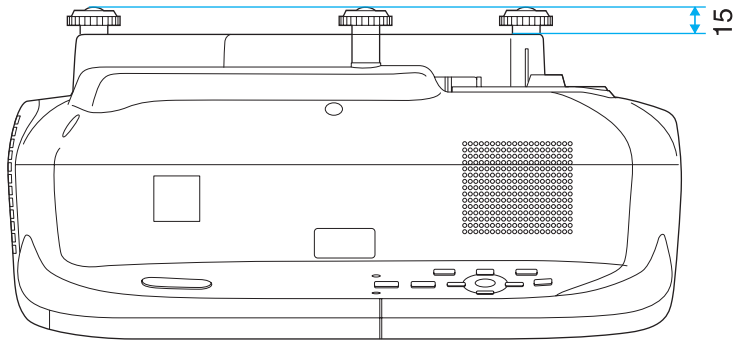

With feet



Units: mm

This section briefly explains the difficult terms that are not explained in the text of this guide. For details, refer to other commercially available publications.

Ad hoc mode	A method of wireless LAN connection that communicates with wireless LAN clients without using an access point.
AMX Device Discovery	AMX Device Discovery is a technology developed by AMX to facilitate AMX control systems for easy operation of the target equipment. Epson have implemented this protocol technology, and have provided a setting to enable the protocol function (ON). See the AMX Web site for more details. URL http://www.amx.com/
Aspect Ratio	The ratio between an image's length and its height. Screens with a horizontal:vertical ratio of 16:9, such as HDTV screens, are known as wide screens. SDTV and general computer displays have an aspect ratio of 4:3.
Component Video	A method that separates the video signal into a luminance component (Y), and a blue minus luminance (Cb or Pb) and a red minus luminance (Cr or Pr).
Composite video	A method that combines the video signal into a luminance component and a color component for transmission down a single cable.
Contrast	The relative brightness of the light and dark areas of an image can be increased or decreased to make text and graphics stand out more clearly, or to make them appear softer. Adjusting this particular property of an image is called "contrast adjustment".
DHCP	An abbreviation of Dynamic Host Configuration Protocol, this protocol automatically assigns an IP address to equipment connected to a network.
DICOM	An acronym for Digital Imaging and Communications in Medicine. An international standard that defines image standards and a communications protocol for medical images.
Gateway Address	This is a server (router) for communicating across a network (subnet) divided according to subnet mask .
HDCP	HDCP is an abbreviation for High-bandwidth Digital Content Protection. It is used to prevent illegal copying and protect copyrights by encrypting digital signals sent over DVI and HDMI ports. Because the HDMI port on this projector supports HDCP, it can project digital images protected by HDCP technology. However, the projector may not be able to project images protected with updated or revised versions of HDCP encryption.
HDTV	An abbreviation for High-Definition Television that refers to high-definition systems which satisfy the following conditions. <ul style="list-style-type: none"> • Vertical resolution of 720p or 1080i or greater (p = Progressive, i = Interlace) • Screen aspect ratio of 16:9
Infrastructure mode	A method for wireless LAN connection in which devices communicate through access points.
Interlace	Transmits information needed to create one screen by sending every other line, starting from the top of the image and working down to the bottom. Images are more likely to flicker because one frame is displayed every other line.
IP Address	A number to identify a computer connected to a network.
Progressive	Projects information to create one screen at a time, displaying the image for one frame. Even though the number of scan lines is the same, the amount of flicker in images decreases because the volume of information has doubled compared with an interlace system.

Refresh Rate	The light-emitting element of a display maintains the same luminosity and color for an extremely short time. Because of this, the image must be scanned many times per second to refresh the light-emitting element. The number of refresh operations per second is called the Refresh rate and is expressed in hertz (Hz).
SDTV	An abbreviation for Standard Definition Television that refers to standard television systems which do not satisfy the conditions for HDTV  High-Definition Television.
SNMP	An abbreviation for Simple Network Management Protocol, which is the protocol for monitoring and controlling devices such as routers and computers connected to a TCP/IP network.
sRGB	An international standard for color intervals that was formulated so that colors that are reproduced by video equipment can be handled easily by computer operating systems (OS) and the Internet. If the connected source has an sRGB mode, set both the projector and the connected signal source to sRGB.
SSID	SSID is identification data for connecting to another device on a wireless LAN. Wireless communication is possible between devices with the same SSID.
Subnet Mask	This is a numerical value that defines the number of bits used for the network address on a divided network (subnet) from the IP address.
SVGA	A screen size standard with a resolution of 800 (horizontal) x 600 (vertical) dots.
SXGA	A screen size standard with a resolution of 1,280 (horizontal) x 1,024 (vertical) dots.
Sync.	The signals output from computers have a specific frequency. If the projector frequency does not match this frequency, the resulting images are not of a good quality. The process of matching the phases of these signals (the relative position of the crests and the troughs in the signal) is called Synchronization. If the signals are not synchronized, flickering, blurriness, and horizontal interference occur.
Tracking	The signals output from computers have a specific frequency. If the projector frequency does not match this frequency, the resulting images are not of a good quality. The process of matching the frequency of these signals (the number of crests in the signal) is called Tracking. If tracking is not carried out correctly, wide vertical stripes appear in the signal.
Trap IP Address	This is the IP address  for the destination computer used for error notification in SNMP.
VGA	A screen size standard with a resolution of 640 (horizontal) x 480 (vertical) dots.
WPS (Wi-Fi Protected Setup)	Wi-Fi Protected Setup has been devised by the Wi-Fi Alliance as a means of easily setting up and securing a wireless LAN.
XGA	A screen size standard with a resolution of 1,024 (horizontal) x 768 (vertical) dots.

All rights reserved. No part of this publication may be reproduced, stored in a retrieval system, or transmitted in any form or by any means, electronic, mechanical, photocopying, recording, or otherwise, without the prior written permission of Seiko Epson Corporation. No patent liability is assumed with respect to the use of the information contained herein. Neither is any liability assumed for damages resulting from the use of the information contained herein.

Neither Seiko Epson Corporation nor its affiliates shall be liable to the purchaser of this product or third parties for damages, losses, costs, or expenses incurred by the purchaser or third parties as a result of: accident, misuse, or abuse of this product or unauthorized modifications, repairs, or alterations to this product, or (excluding the U.S.) failure to strictly comply with Seiko Epson Corporation's operating and maintenance instructions.

Seiko Epson Corporation shall not be liable against any damages or problems arising from the use of any options or any consumable products other than those designated as Original Epson Products or Epson Approved Products by Seiko Epson Corporation.

The contents of this guide may be changed or updated without further notice.

Illustrations in this guide and the actual projector may differ.

Restriction of Use

When this product is used for applications requiring high reliability/safety such as transportation devices related to aviation, rail, marine, automotive etc.; disaster prevention devices; various safety devices etc; or functional/precision devices etc, you should use this product only after giving consideration to including fail-safes and redundancies into your design to maintain safety and total system reliability. Because this product was not intended for use in applications requiring extremely high reliability/safety such as aerospace equipment, main communication equipment, nuclear power control equipment, or medical equipment related to direct medical care etc, please make your own judgment on this product's suitability after a full evaluation.

Wireless Telegraphy Act Regulations

The following acts are prohibited by the Wireless Telegraphy Act.

- Modifying and disassembling (including the antenna)
- Removing the label of conformance

About Notations

Microsoft® Windows® 98 operating system
Microsoft® Windows® Me operating system
Microsoft® Windows® 2000 operating system
Microsoft® Windows® XP operating system
Microsoft® Windows Vista® operating system
Microsoft® Windows® 7 operating system

In this guide, the operating systems above are referred to as "Windows 98", "Windows Me", "Windows 2000", "Windows XP", "Windows Vista", and "Windows 7". Furthermore, the collective term Windows may be used to refer to Windows 98, Windows Me, Windows 2000, Windows XP, Windows Vista, and Windows 7, and multiple versions of Windows may be referred to as, for example, Windows 98/Me/2000/XP/Vista/7, with the Windows notation omitted.

Mac OS X 10.3.x
Mac OS X 10.4.x
Mac OS X 10.5.x
Mac OS X 10.6.x
Mac OS X 10.7.x

In this guide, the operating systems above are referred to as "Mac OS X 10.3.x", "Mac OS X 10.4.x", "Mac OS X 10.5.x", "Mac OS X 10.6.x", and "Mac OS X 10.7.x". Furthermore, the collective term "Mac OS X" is used to refer to them all.

General Notice:

IBM, DOS/V, and XGA are trademarks or registered trademarks of International Business Machines Corp.

Mac, Mac OS, and App Store are trademarks of Apple Inc.

Microsoft, Windows, Windows NT, Windows Vista, PowerPoint, and Windows logo are trademarks or registered trademarks of Microsoft Corporation in the United States and/or other countries.

The DisplayPort Certified Logo and DisplayPort Icons are Registered Trademarks of the Video Electronics Standards Association (VESA).

The word DisplayPort is a Registered Trademark of VESA in various countries around the world.

eneloop® is a registered trademark of Sanyo Electronic Co., Ltd.

WPA™ and WPA2™ are registered trademarks of Wi-Fi Alliance.

HDMI and High-Definition Multimedia Interface are the trademarks or registered trademarks of HDMI Licensing LLC. 

PJLink trademark is a trademark applied for registration or is already registered in Japan, the United States of America and other countries and areas.

Foxit PDF SDK Copyright ©2011, Foxit Software Company www.foxitsoftware.com, All rights reserved.

Crestron and Crestron RoomView are registered trademarks of Crestron Electronics, Inc.

Other product names used herein are also for identification purposes only and may be trademarks of their respective owners. Epson disclaims any and all rights in those marks.

©SEIKO EPSON CORPORATION 2012. All rights reserved.

- A**
- A/V Mute 105
 - Abs. Color Temp. 140
 - Administrator Password 158
 - Administrator Settings menu 158
 - Advanced 140
 - Air exhaust vent 10
 - Air filter replacement period 194
 - AMX Device Discovery 159
 - Aspect 59, 141
 - Audio Input Setup 145
 - Auto Iris 59, 140
 - Auto Setup 140
 - avi 96
- B**
- Basic menu 152
 - bmp 96
 - Bonjour 159
 - Bottom cover 24
 - Brightness 139
- C**
- CA certificate 160
 - Cable cover 24
 - Ceiling 27, 144
 - Certificates 125
 - Cleaning 189
 - Cleaning the air filter and air intake vent
..... 190
 - Cleaning the projector's surface 189
 - Client Certificate 160
 - Color Mode 58, 139
 - Color Saturation 139
 - Computer port 12
 - Configuration menu 136
 - Connect to a Network Projector 118
 - Consumables 198
 - Continuous 104
 - Contrast 139
 - Control Pad 9, 23, 41
 - Control panel 15
 - Control Panel Lock 115, 142
 - Crestron RoomView 129, 130, 159
 - Cross 107
 - Customized 58
- D**
- DHCP 157
 - DICOM SIM 58
 - Direct Power On 145
 - Display 144
 - Display Background 144
 - Display Order 104
 - Display settings 104
 - DisplayPort 12
 - DisplayPort Video Range 141
 - Distance 199
 - Document Camera 198
 - Dynamic 58
- E**
- Easy Interactive Function 144, 145
 - Easy Interactive Pen 20
 - EasyMP Monitor 122
 - ESC/VP21 127
 - Extended menu 144
 - E-Zoom 107
- F**
- Freeze 105
 - Front 28, 144
 - fse 95
 - Full Lock 115
- G**
- Gateway Address 154, 158
 - General settings 146
 - gif 96
- H**
- H/V-Keystone 51
 - HDMI port 12
 - HDMI Video Range 141
 - Help function 165
 - High Altitude Mode 145
 - How to replace the air filter 194
 - How to replace the lamp 192
- I**
- Image menu 139
 - Image Shift 54, 142
 - Indicators 166, 167
 - Info menu 162
 - Input Signal 141, 162
 - Interactive function 9, 63, 93, 118
 - IP Address 158

J

jpg 74, 96

K

Keystone 142

L

Lamp cover 10
 Lamp Hours 162
 Lamp indicator 166
 Lamp replacement period 191
 Language 146

M

Mail Notification 126, 159
 Mail Notification menu 159
 Manage Certificates menu 160
 Message Broadcasting 122, 159
 Messages 144
 Monitor displays 201
 Monitor Password 159
 Mouse pointer 108
 mp4 96
 mpg 96

N

Network Configuration 151
 Network Host Name 158
 Network information 151
 Network menu 150
 Noise Reduction 141
 Notification email address 1/2/3 160

O

Operating temperature 203
 Operation 145
 Optional accessories 198
 Overheating 167

P

Part names and functions 10
 Password protect 113
 Password protect sticker 114
 Pattern 143
 PC Free 97
 PC Free Annotation 64, 75
 PC Interactive 64, 84, 146
 pdf 74, 96
 Photo 58
 PjLink 129
 PjLink Password 158
 png 74, 96
 Pointer 105
 Pointer Shape 142
 Port Number 160
 Position 141
 Power Consumption 142
 Power indicator 166
 Power inlet 12
 Power On Protect 113
 Presentation 58, 95
 Priority Gateway 159
 Problem solving 166
 Progressive 141
 Projection 144
 Projection window 11

Projector Keyword 152
 Projector Name 152
 Projector setup 122

Q

Quick Corner 142

R

Reading mail 126
 Rear 28, 144
 Rear screen 28
 Refresh Rate 162
 Remote control 16
 Remote control light-emitting area 24
 Remote port 24
 Remote receiver 10, 11
 Replacing batteries (Control Pad) 24
 Replacing batteries (remote control) 19
 Replacing the battery (Pen) 21
 Reset All 163
 Reset Lamp Hours 163
 Reset menu 163
 Resetting the lamp operating time 194
 Resolution 162
 Rotating images 99

S

Schedule 133
 Screen Size 92
 Screen size 199
 Screen switching time 104
 Search Access Point 154
 Secure HTTP 159

- Security menu 155
 - Select Drive 98
 - Self-signed Certificate 161
 - Setting a Notification Event 160
 - Settings menu 142
 - Sharpness 139
 - Signal menu 140
 - sit 95
 - Sleep Mode 145
 - Slideshow 102
 - SMTP Server 160
 - SNMP 127
 - SNMP menu 161
 - Soft keyboard 152
 - Source 91, 162
 - Source Search 15, 47
 - Specifications 203
 - Split Screen 142
 - Split Screen Setup 91
 - Sports 58
 - sRGB 58
 - Standby Mode 145
 - Startup Screen 144
 - Storage temperature 203
 - Subnet Mask 158
 - Supported monitor displays 201
 - Swap Screens 92
 - Sync Info 162
 - Sync. 141
- T**
- Temp indicator 166
 - Theatre 58
 - Tint 139
 - Top cover 24
 - Tracking 141
 - Trap IP Address 1/2 161
- U**
- USB Display/Easy Interactive Function 145
 - USB Type B 145
 - USB-A port 13, 23
 - USB-B port 12, 23
 - User Button 143
 - User Pattern 111
 - User's Logo 109
 - User's Logo Protect 113
- V**
- Video port 13
 - Video Signal 141, 162
 - Volume 142
- W**
- Wall 27
 - Web browser 122
 - Web Control 123
 - Web Control Password 159
 - Web Remote 123
 - Web Server Certificate 161
 - Whiteboard 58
 - Whiteboard mode 64, 69
 - Whiteboard Settings 147
 - Wired LAN menu 157
 - Wireless LAN menu 153
 - Wireless LAN Power 153
 - Wireless mouse function 108
 - Wireless Mouse/USB Display 145
 - wmv 96
 - WPA/WPA2-EAP 156
 - WPA/WPA2-PSK 156
- Z**
- Zoom 142