

JVC

D-ILA PROJECTORS

DLA-X95R

DLA-X75R

DLA-X55R

DLA-X35



4K

e-shift2

ProSelecta

View :: Compare :: Select - www.ProSelecta.com



X

Series

DLA-X Series



DLA-X95R

4K-resolution D-ILA Projector



Premium JVC D-ILA projector model that adopts high-grade hand selected parts, realizes 4K^{*1} resolution and industry leading* native contrast ratio of 130,000:1.

*As of November 2012



DLA-X75R

4K-resolution D-ILA Projector



Powerful combination of 4K-resolution^{*1} images, natural looking 3D, and native contrast ratio of 90,000:1. High-end model that lets you enjoy the visual dynamics of movies.

Redefining Excellence

4K e-shift2



DLA-X55R

4K-resolution D-ILA Projector



Super-high 4K-resolution*1 enjoyment offers native contrast ratio of 50,000:1 for bright images, plus a variety of image quality optimization functions.



DLA-X35

D-ILA Projector with 3D Viewing



D-ILA



High quality viewing for 2D & 3D, even in bright living rooms with 1300 lumens brightness and 50,000:1 native contrast ratio.





Beyond JVC, there's JVC.

4K
e-shift2

Experience the reality of images that seem to float in mid-air,
as you forget the existence of the screen.

Be totally immersed in the world that is portrayed, as images envelop you.
Beyond 2K is a new world of moving experiences that only 4K can deliver.

JVC's image processing technologies are able to reproduce the finest
nuances and unique tone of every visual work, enabling you to enjoy
a 4K-resolution* image with extreme realism and presence
in your home theater environment.

JVC Extreme 4K Resolution Realized by e-shift 2 Technology (DLA-X95R/X75R/X55R)

The original e-Shift device used liquid crystals to shift the subframes by 0.5 pixel both vertically and horizontally to achieve 4 times the pixel density of the original content. e-shift2 features significant enhancements, including an all-new optical device. Our new e-shift2 device shifts the image without the use of liquid crystals, resulting in better overall resolution linearity and ANSI contrast with dynamic 4K resolution and detail.

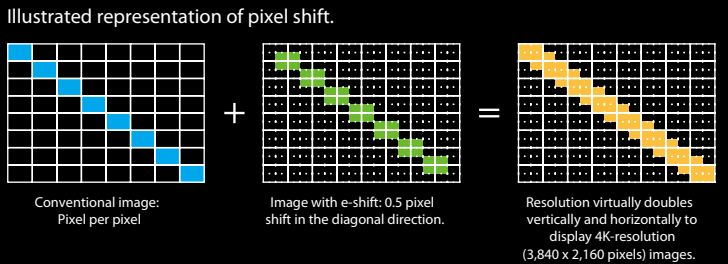
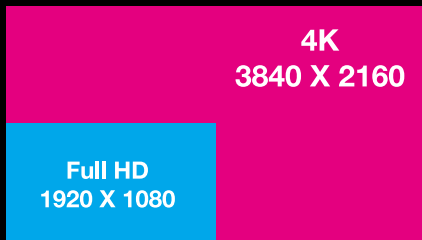
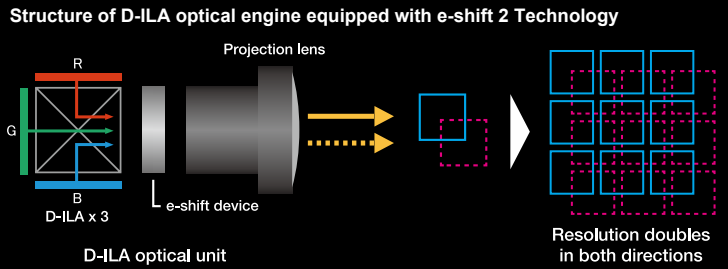

Scaler for the e-shift 2 Technology — Multiple Pixel Control (DLA-X95R/X75R/X55R)

Superior image processing technology is essential in order to reproduce full HD resolution images on a 4K projector. By advancing our image processing technology to new levels based on JVC's original algorithm, we were able to develop a new high-performance 4K scaling engine as a part of the e-shift 2 Technology. This makes it possible to reproduce full HD images with maximum definition and also convert them to even higher quality 4K-resolution images. With Multiple Pixel Control, the detection range has been vastly expanded to over ten times that of conventional models*, making it possible to detect a wide range

of signal bands within the frame. What's more, based on high-precision detection results — which uses an improved detector with refined bandwidth division from a conventional 2 bands to 8 bands — JVC's original image quality processing that performs optimum filtering, dynamically controls the background blur and focus is applied, resulting in natural, expressive 4K images. Five types of 4K Profiles are available to apply optimal processing to each specific type of visual material. It is therefore possible to play back high-quality images while enjoying the best any source has to offer.

*Compared to DLA-X90R/X70R

- e-shift 2 Technology's Image Processor: Multiple Pixel Control

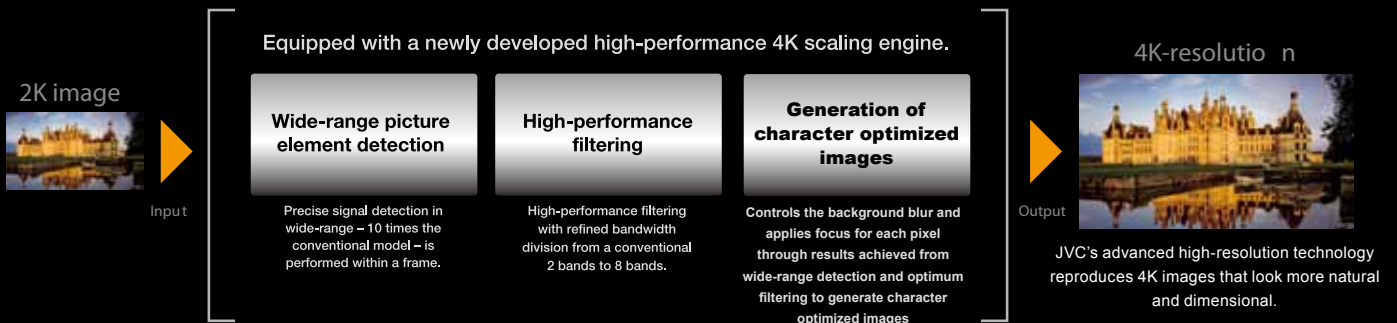

- Effects Achieved with the Multiple Pixel Control

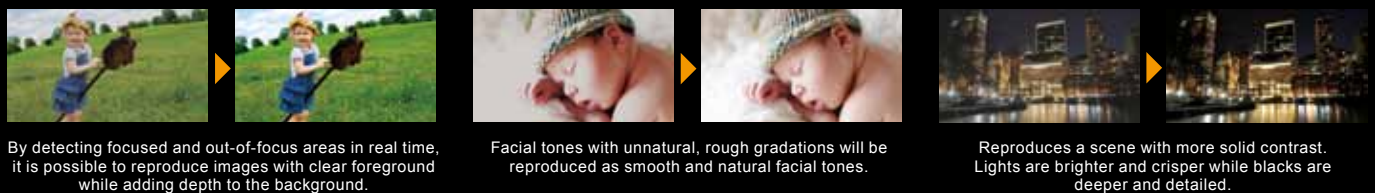

D-ILA 3D Projection Leaps Further in Quality



High Quality 3D Images with D-ILA

In addition to JVC's original Frame Addressing method to reproduce 3D images with vivid colors, we also improved the conversion accuracy of the optical engine and 3D glasses to achieve a 20% increase in brightness.* Furthermore, the crosstalk that can occur with 3D images is dramatically reduced. Enjoy the kind of realistic and exciting 3D images that only D-ILA can provide.

*Compared to DLA-X90R/X70R/X30

3D Picture Adjustment Functions

- **Crosstalk Cancelling** for pictures easier on the eyes
- **Disparity Adjustment** for more natural stereoscopic reproduction
- **Depth Adjustment*** for matching depth characteristics to source
- **Subtitle Adjustment*** fixes distorted subtitles

*Feature available only during 2D-3D conversion.

Frame Addressing

Image overlapping (crosstalk) is reduced because the shutter on 3D glasses can be left open longer as the method draws each frame of the picture individually.

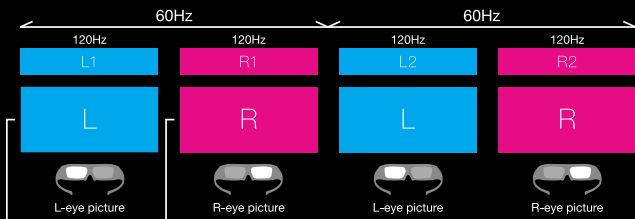

As the shutter can be left open for a longer period, crosstalk is not generated as each frame of the picture is drawn individually without overlap.

Line Addressing

Crosstalk can be generated when shutters are switched between the left and right eyes, and opened only for a short amount time. This can cause the picture to darken and lose brightness.

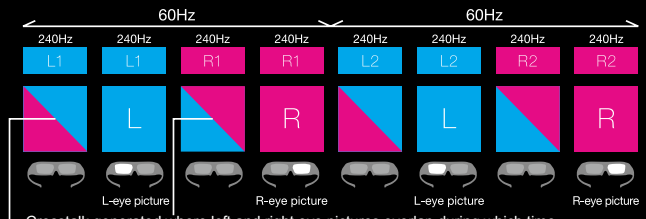

Crosstalk generated where left and right eye pictures overlap during which time, the shutter is closed.

Full Selection of Optional Accessories to Maximize Your 3D Enjoyment

Two types of 3D glasses are available — IR (infrared) and RF (radio frequency) wireless, which provides more flexible use.

RF (Radio Frequency) Method



PK-AG3
RF 3D Glasses

- Rechargeable
- Lightweight - 1.34 oz
- Continuous operation approx. 100H

PK-EM2
RF 3D Synchro Emitter

- Wireless (direct connection with the projector)
- Weight .7 oz
- Dimensions (WxDxH): 1.93" x .57" x 2.56"

IR (Infrared) Method



PK-AG2
IR 3D Glasses

- Rechargeable
- Lightweight - 1.41 oz
- Continuous operation approx. 40H

PK-EM1
IR 3D Synchro Emitter

- Supplied with 3m connection cable
- Weight - 5.64 oz
- Dimensions (WxDxH): 3.15" x 1.97" x 3.54" (including the stand)

Notes about viewing 3D video content

- The optional 3D Synchro Emitter and 3D glasses are required to view 3D images from the D-ILA projectors. 3D video software (3D media or output of 3D broadcasts) and a 3D-compatible video player are also required.
- Perception of 3D images will vary with individual viewers.
- Stop viewing 3D images immediately if any discomfort such as headaches, dizziness, eye fatigue, etc. occurs.
- Viewing of 3D images by children under the age of five is not recommended.
- Read the Safety Precautions in the User Manual carefully before viewing any 3D source.

Cinema-like Quality Realized by D-ILA

Native Contrast Ratio

Further performance improvements for our optical engine utilizing JVC's original D-ILA device and a wire grid have resulted in a high native contrast ratio. Over a broad dynamic range from peak whites to deep blacks, the image conveys powerful presence as a result of high native contrast. The DLA-X95R is capable of achieving industry's highest native contrast ratio of 130,000:1* with the adoption of high-grade parts and optimized optical engine.



Conventional projector



DLA-X95R

*As of November 2012.

JVC's Unique Real Color Imaging Technology (DLA-X95R/X75R/X55R)

JVC's original Real Color Imaging Technology precisely interprets the fine color reproduction information in the image to dramatically improve color rendition in a way that is true to the original image source.

• Dedicated Color Profile

JVC was able to create a dedicated color profile by focusing on the color space information that characterizes an image, and accurately understanding the fine color expression information that an image has. This time, we have added a new color profile for Film, as well as three* profiles exclusively for 3D. Combined use of picture quality modes and dedicated color profiles results in 19* different ways to enjoy high quality images.

*X55R offers two 3D color profiles, resulting in 12 different ways.

• Color Space Wider than Adobe RGB (DLA-X95R/X75R)

Real Color Imaging Technology features a color space wider than that of Adobe RGB to vividly reproduce a fuller spectrum of colors such as the green of trees, the blue of oceans, etc., which was difficult to recreate accurately up until now.

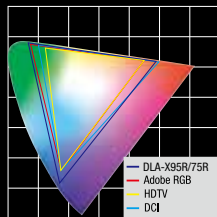

• Xenon-lamp Color Temperature Setting (DLA-X95R/X75R)

Real Color Imaging Technology also incorporates a Xenon-mode color temperature setting equivalent to that of a Xenon lamp, a popular light source used in cinemas. This setting allows for the authentic reproduction of colors similar to those of film in cinemas, while using highly efficient and economical ultra-high pressure mercury lamps.



Conventional color temperature setting



Xenon-mode color temperature setting

Color Management System with 7-Axis Matrix (DLA-X95R/X75R/X55R)

A 7-axis matrix of red, green, blue, cyan, magenta, yellow, and orange ensures the precise adjustment of hue, saturation, and intensity. The last axis of orange helps in enhancing the selection of the color spectrum for skin tones. And for improved operability, only the color being adjusted will be shown on the screen while the others are displayed in black and white.



The color being adjusted is shown in color.

Screen Adjustment Modes*

Reflective characteristics that differ from screen to screen are precisely analyzed and the projector selects the best mode to match the screen being used. With the appropriate mode* selected, the picture displayed will always be precisely adjusted to ensure excellent image reproduction with natural color balance.

*Three modes for the DLA-X55R/X35. The DLA-X95R/X75R offers 105 modes but with a firmware update, it provides a maximum of 255 modes. Please refer to our corporate website for a comparison table of primary screens and adjustment modes.



Screen adjustment mode Off



Screen adjustment mode On

Original Picture Tone Function (DLA-X95R/X75R/X55R)

The Picture Tone function works to balance gamma, contrast, and brightness settings without affecting the grey scaling of the original source to enable brightness adjustment that better matches the surrounding environment.



Clear Motion Drive*

Utilizing enhanced detection-interpolation technology through high-precision interpolation algorithms, Clear Motion Drive helps to smooth movement in the picture by reducing blur that can be generated in high-speed scenes such as sports events, etc. Additionally, as the amount of picture delay is very limited, D-ILA projectors are also well suited for playing video games.



Clear Motion Drive: OFF



Clear Motion Drive: ON

*Feature not available in 3D mode.

Environmental Setting

An environmental setting function has been incorporated to minimize the effect of the projection environment on image quality, such as wall color. Simply input screen size, viewing distance and wall color, and the projector will automatically apply image compensation so that high quality images can be enjoyed in just about any viewing environment.



Industry Certified Projectors (DLA-X95R/X75R)

THX 3D Display Certification*1



The DLA-X95R and X75R are accredited with THX 3D Certification, which was established to ensure the precise reproduction of picture quality in home environments for both 2D and 3D content just as the original filmmaker envisioned. Encompassing more than 400 laboratory tests to evaluate a projector's color accuracy, cross-talk, viewing angles and video processing, this certification helps to guarantee high-definition quality.

*1 Ideal 3D screen-size performance is 90 inches diagonal (16:9).

Certified by ISF
(Imaging Science Foundation)



The DLA-X95R and X75R are licensed with the ISF C3 (Certified Calibration Controls) mode, enabling trained dealers to professionally calibrate them to desired screen surfaces, lighting environments and video sources, and then securely store these precise settings into the projector. This not only helps to ensure the reproduction of film or video content accurate to the source but also excellent picture quality optimized for specific environments.

A Variety of Convenient Functions

Lens Memory Function

This function stores ten or five* separate lens adjustments for zoom, shift and focus that can be easily recalled when needed. Focus, zoom (size) and shift (display position) characteristics can be recorded for video content in different aspect ratios such as when using a CinemaScope screen size (2.35:1) or standard 16:9 screen and easily switched between each setup via the remote controller.

Lens memory examples (when using CinemaScope screen)



Memory 1: Standard 16:9



Memory 2: CinemaScope size



Memory 3: CinemaScope size with subtitles outside of the screen

*Ten memories for the DLA-X95R/X75R. Five memories for the DLA-X55R/X35.

Automatic Lens Cover (DLA-X95R/X75R)

A unique automatic lens cover opens and closes upon power On/Off to protect against dust or damage to ensure users of easy, trouble-free operation via the remote controller, even if the projector is installed on the ceiling.



Lens cover closed (power off)



Lens cover open (power on)

Anamorphic Mode for Wide Cinematic Films

A 2.35:1 aspect ratio for wide cinematic films can be enjoyed by combining the projector with a third-party anamorphic lens to create dynamic picture reproduction as can be seen in a movie theatre.

Mode off: 16:9 screen

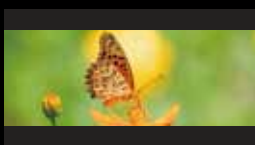

Mode on: 2.35:1 screen



When using an anamorphic lens.

16-step Aperture

A 16-step aperture function enables brightness adjustment to not only suit user preferences but also operating ambiances, helping to ensure deeper and truer black levels.

Pixel Adjust Function

The Pixel Adjust function allows users to precisely correct color deviation in 1/16-pixel increments*, and it is also capable of segmenting the entire screen into 121 points and adjust them individually to realize clearer video without color deviation.



*DLA-X35 enables adjustment in 1-pixel increments.

Flexible Installation Guaranteed with Powered Lens-shift Function

Flexible installation is made possible thanks to the $\pm 80\%$ vertical and $\pm 34\%$ horizontal powered lens-shift function. The projector also features a high-performance 2X zoom lens with motorized focus that can project images upon a large 100-inch screen at throw distances of between 9.8 and 20 feet. With the high-performance motor, the once tedious tasks of setting zoom ratios and focus adjustments are now made simple and effortless. In addition, the lens-center function makes it easy to return the lens to the default center position.

$\pm 80\%$ vertical and $\pm 34\%$ horizontal motorized lens shift function

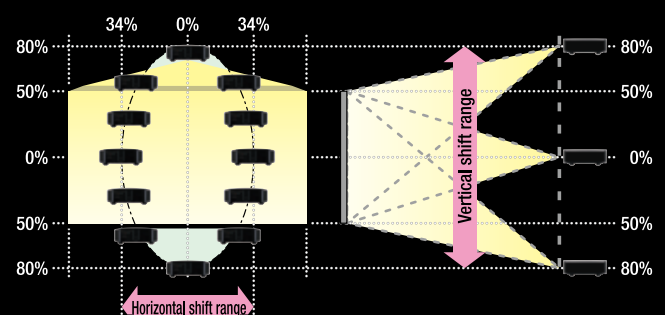

The vertical and horizontal lens shift function cannot be set to the maximum values simultaneously.

Digital Keystone Function*

Keystone distortion that occurs when the projector is placed on a tilt position can be adjusted using this function. Digital Keystone can also adjust to curved screens with its Pincushion Function.

*Digital keystone cannot be used in 3D mode.

A Wide Range of Inputs and Outputs

In addition to 3D compatible HDMI inputs, the projector features an array of other connections, such as an RJ45 connection for projector control, firmware and configuration updates, and a trigger connection for an anamorphic lens or motorized screen.

DLA-X95R

4K-Resolution D-ILA Projector

JVC D-ILA projector premium model adopts high-grade parts, realizes 4K resolution and industry leading* native contrast of 130,000:1.

*As of November 2012



- High-definition 4K projection (3840 x 2160) achieved with e-shift 2 Technology including Multiple Pixel Control original picture processor
- Improved optical engine employing high-grade parts, realizes industry's highest native contrast ratio of 130,000:1
- Bright 3D viewing with reduced crosstalk only possible with D-ILA
- Equipped with JVC's original Real Color Imaging Technology for accurate color reproduction
- Automatic Lens Cover



Super-high 4K-resolution enjoyment offers native contrast of 50,000:1 for bright images, plus a variety of image quality optimization functions.

DLA-X55R

4K-Resolution D-ILA Projector



- High-definition 4K projection (3840 x 2160) achieved with e-shift 2 Technology including Multiple Pixel Control original picture processor
- 50,000:1 high native contrast ratio
- Bright 3D viewing with reduced crosstalk only possible with D-ILA
- Environmental Setting
- 5-mode Lens Memory
- 3 Screen Adjustment Modes
- Pixel Adjust by 1/16-pixel increment



Model	Native Contrast	4K with e-shift 2 Technology	3D Viewing	2D-3D Conversion	16-step Aperture	Clear Motion Drive*2	Real Color Imaging Technology	7-Axis Color Management	Xenon Lamp Mode	Picture Tone
DLA-X95R	130,000:1	✓	✓	✓	✓	✓	✓	✓	✓	✓
DLA-X75R	90,000:1	✓	✓	✓	✓	✓	✓	✓	✓	✓
DLA-X55R	50,000:1	✓	✓	✓	✓	✓	✓	✓		✓
DLA-X35	50,000:1		✓	✓	✓	✓				



DLA-X75R

4K-Resolution D-ILA Projector



- High-definition 4K projection (3840 x 2160) achieved with e-shift 2 Technology including Multiple Pixel Control original picture processor
- 90,000:1 exceptionally high native contrast ratio
- Bright 3D viewing with reduced crosstalk only possible with D-ILA
- Equipped with JVC's original Real Color Imaging Technology for accurate color reproduction
- Various picture correction and adjustment functions
- Automatic Lens Cover

Powerful combination of 4K-resolution images, natural looking 3D, and native contrast of 90,000:1. High-end model that lets you enjoy the visual dynamics of movies.

High quality viewing for both 2D & 3D even in bright living rooms with 1300 lumens brightness and 50,000:1 native contrast.

DLA-X35

D-ILA Projector with 3D Viewing



- Bright picture realized with brightness of 1300 lumens and native contrast ratio of 50,000:1
- Bright 3D viewing with reduced crosstalk only possible with D-ILA
- 6 Picture Modes and 3 Color Spaces
- Environmental Setting
- 5-mode Lens Memory
- 3 Screen Adjustment Modes
- Pixel Adjust by 1 pixel increment



Darkness/Lightness Correction	Pixel Adjust	Screen Adjustment Mode	Environmental Setting	Anamorphic Mode	Pic. Data IN/OUT*3	Lens Memory	Digital Keystone*2	Lens Cover	THX Certified	ISF
✓	1/16-pixel	Max. 255	✓	✓	✓	10	✓	Automatic	✓	✓
✓	1/16-pixel	Max. 255	✓	✓	✓	10	✓	Automatic	✓	✓
✓	1/16-pixel	3 modes	✓	✓		5	✓			
	1 pixel	3 modes	✓	✓		5	✓			

*2 Feature not available in 3D mode. *3 Requires a PC and LAN cable.

Projection Distance Chart

Screen diagonal (inch)	Display size (16:9)		Projection distance	
	W (mm)	H (mm)	Wide (m)	Tele (m)
60	1,328	747	1.78	3.66
70	1,549	872	2.09	4.28
80	1,771	996	2.40	4.89
90	1,992	1,121	2.70	5.51
100	2,214	1,245	3.01	6.13
110	2,435	1,370	3.31	6.75
120	2,656	1,494	3.62	7.36
130	2,878	1,619	3.92	7.98
140	3,099	1,743	4.23	8.60
150	3,320	1,868	4.53	9.22
160	3,542	1,992	4.84	9.84
170	3,763	2,117	5.14	10.45
180	3,984	2,241	5.45	11.07
190	4,206	2,366	5.75	11.68
200	4,427	2,490	6.06	12.30

*Projection distances are design specifications, so there is ±5% variation.

Main Features

	DLA-X95R	DLA-X75R	DLA-X55R	DLA-X35
4K Capability		●		-
3D Capability			●	
2D-3D Converter			●	
Aperture			● (16 steps)	
Clear Motion Drive*1			●	
Color Management		● (7-axis)		-
Color Temperature (Xenon-lamp Mode)	●			-
Picture Tone		●		-
Darkness and Lightness Correction		●		-
Pixel Adjust		(by 1/16-pixel increment)		(by 1 pixel increment)
Screen Adjustment Mode	● (Max 255 modes)			● (3 modes)
Environmental Setting			●	
THX Certification		●		-
ISF C3		●		-
Anamorphic Mode			-	
Picture Data In/Out*2		●		-
Lens Memory	● (10 memories)			● (5 memories)
Digital Keystone*1			-	
Automatic Lens Cover	●			-

*1 Feature not available in 3D mode. *2 Requires a PC and LAN cable.

Specifications

	DLA-X95R	DLA-X75R	DLA-X55R	DLA-X35
Device	0.7 inch Full HD D-ILA (1920 x 1080) x3			
4K e-shift 2 Technology	Yes			-
Resolution	3840 x 2160 ¹			1920 x 1080
Lens	x2 Zoom & Focus: Motorized f=21.4-42.8mm / F3.2-4			
Lens Shift	±80% Vertical and ±34% Horizontal (Motorized)			
Light Source Lamp	NSH 230W (lamp life: up to 4000 hours when the lamp is in Low mode)			
Brightness*2	1,200lm			1,300lm
Contrast Ratio (Native)	130,000:1	90,000:1	50,000:1	
Connectors	Component	1 (RCA; Y, Pb/Ca, Pr/Cr)		
	HDMI	2 (3D/Deep Color/CEC compatible)		
	Analog RGB (PC)	1 (D-sub15pin)		-
	RS-232C	1 (D-sub 9pin)		
	LAN (RJ-45)	1		
	Trigger	1 (Mini jack, DC12V/100mA)		
	Remote	1 (Mini jack)		
3D Sync	1 (Mini Din 3pin)			
Video Input Signal Format	Digital	480i/p, 576i/p, 720p 60/50, 1080i 60/50, 1080p 60/50/24		
	Analog	480i/p, 576i/p, 720p 60/50, 1080i 60/50		
PC Input Signal Format	HDMI	VGA/SVGA/XGA/WXGA/WXGA+/SXGA/WXGA+WUXGA		
	Analog RGB (D-sub 15 pin)	VGA/SVGA/XGA/WXGA/WXGA+/SXGA/SXGA+/WSXGA+/1920x1080/Mac 13", 16", 19"		-
3D Format	Frame Packing	720p 60/50, 1080p 24, 1080i 60/50		
	Side-by-Side (half)	720p 60/50, 1080p 60/50/24, 1080i 60/50		
	Top & Bottom	720p 60/50, 1080p/24		
Power Requirement	AC 110-240V, 50/60Hz			
Power Consumption	360W (Standby: 0.4W)			330W (Standby: 0.4W)
Fan Noise	23dB (When the lamp is in Low mode)			
Dimensions (WxHxD)	17 7/8" x 7" x 18 1/2" inches			
Weight	33.95 lbs		33.29 lbs	32.63 lbs

*1 Resolution is 1920x1080 at 3D mode.

*2 Measurement, measuring conditions, and method of notation all comply with ISO 21118.

Optional Equipment

RF (Radio Frequency) Method



RF 3D Glasses PK-AG3 Rechargeable Type
RF 3D Synchro Emitter PK-EM2

IR (Infrared) Method



IR 3D Glasses PK-AG2 Rechargeable Type
IR 3D Synchro Emitter PK-EM1



User-replaceable Lamp PK-L2312U

Connectors



DLA-X95R/X75R



DLA-X55R/X35

External Dimensions (unit: mm)

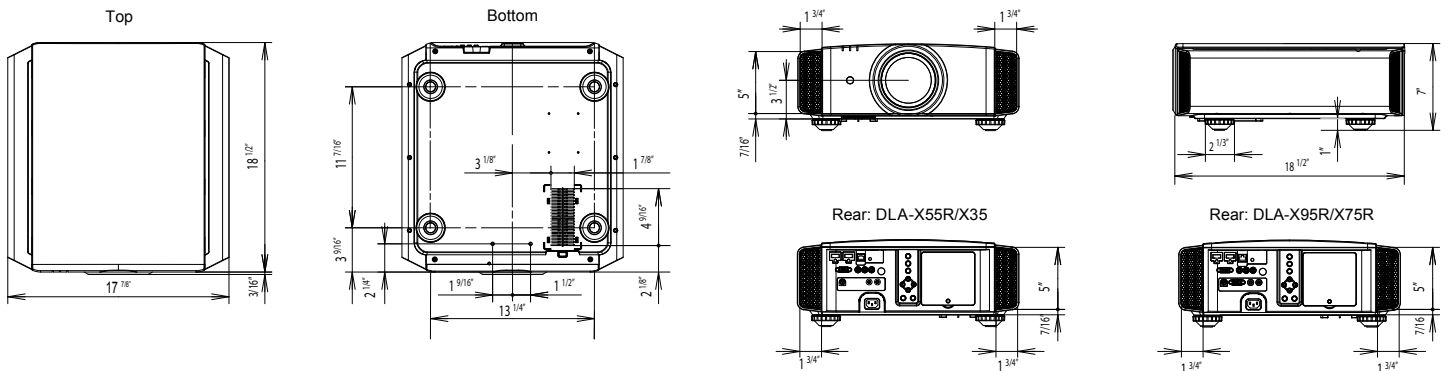

• The projector is equipped with a New Super High Pressure mercury lamp, which may break, emitting a loud noise, when it is subjected to shock or after it has been used for some length of time. • Please note that, depending on how the projector is used, there can be considerable difference between individual lamps regarding how many hours they will operate before requiring replacement. • An additional payment is required for installation of a new lamp, if necessary. • The projector lamp requires periodic replacement and is not covered by warranty. • Please be aware that, because the D-ILA device is manufactured using highly advanced technologies, 0.01% or fewer of the pixels may be non-performing (always on or off).

Design and specifications are subject to change without notice. All pictures on this brochure are simulated. Adobe is a trademark or registered trademark of Adobe Systems Incorporated in the U.S. and/or other countries. ISF is a registered trademark of Imaging Science Foundation, Inc. THX and THX logo are trademarks of THX Ltd., which may be registered in some jurisdictions. HDMI, the HDMI logo and High-Definition Multimedia Interface are registered trademarks of HDMI Licensing LLC. Microsoft, Windows, Windows Vista are trademarks or registered trademarks of Microsoft Corporation in the U.S. and other countries. All other brand or product names may be trademarks and/or registered trademarks of their respective owners. Any rights not expressly granted herein are reserved.

Copyright © 2012, JVC KENWOOD Corporation. All Rights Reserved.



DISTRIBUTED BY

JVC Consumer AV Group | A Division of JVC Americas Corp.
1700 Valley Road, Wayne NJ 07470

"JVC" is the trademark or registered trademark of JVC KENWOOD Corporation.