

User's Guide

EH-TW6100W

Home Projector



Using Each Guide

The guides for this projector are organized as shown below.

Safety Instructions/Support and Service Guide

Contains information on using the projector safely, as well as a support and service guide, troubleshooting check lists, and so on. Make sure you read this guide before using the projector.



User's Guide (this guide)

Contains information on setting up and basic operations before using the projector, using the Configuration menu, and handling problems and performing routine maintenance.



Quick Start Guide

Contains information on the procedures for setting up the projector. Read this first.

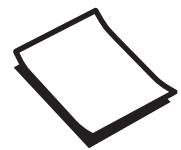

3D Glasses User's Guide

Contains information on handling the 3D Glasses and warnings and so on.



WirelessHD Transmitter User's Guide

Contains information on handling the WirelessHD Transmitter and warnings and so on.





Notations Used in This Guide

Safety Indications

The documentation and the projector use graphical symbols to show how to use the projector safely. The following shows the symbols and their meanings. Please understand and respect these caution symbols in order to avoid injury to persons or property.

Warning

This symbol indicates information that, if ignored, could possibly result in personal injury or even death due to incorrect handling.



Caution

This symbol indicates information that, if ignored, could possibly result in personal injury or physical damage due to incorrect handling.

General Information Indications

Attention

Indicates procedures which may result in damage or malfunctions to occur.

	Indicates additional information and points which may be useful to know regarding a topic.
	Indicates a page where detailed information regarding a topic can be found.
Menu Name	Indicates Configuration menu items. Example: Image - Color Mode
Button Name	Indicates the buttons on the remote control or the control panel. Example:  button

About the Use of "This Product" or "This Projector"

As well as the main projector unit, supplied items or optional extras may be referred to using the phrase "this product" or "this projector".

Organization of the Guide and Notations in the Guide

Using Each Guide	1
Notations Used in This Guide	2
Safety Indications	2
General Information Indications	2
About the Use of "This Product" or "This Projector"	2

Introduction

Projector Features	6
Dynamic 3D Display	6
Selecting Modes to Match what you are Watching (Color Mode)	6
Absolute Color Adjustment	6
Conforms to Wireless Transmissions for the WirelessHD Standards (EH-TW6100W Only)	7
Other Useful Functions	7
Part Names and Functions	8
Front/Top	8
Control Panel	9
Remote Control	10
Rear	13
Base	14
Appearance	15

Preparing

Installing	16
Various Projection Methods	16
Adjusting the Projection Size	17
Connecting to a Device	18
Connecting to Video Equipment	18
Connecting to a Computer	19
Connecting to External Devices	19
Connecting USB devices	19
Connecting WirelessHD devices (EH- TW6100W only)	20
Removing the Interface Cover	20
Connecting an HDMI Cable Clamp	20
Preparing the Remote Control	21

Installing the Remote Control Batteries	21
Remote Control Operating Range	21
Operating range (left to right)	21
Operating range (top to bottom)	21

Basic Operations

Starting and Ending Projection	22
Turning on the Projector and Projecting	22
If the Target Image is not Projected	23
Turning Off	23
Adjusting the Projected Screen	25
Displaying the Test Pattern	25
Adjusting the Focus	25
Adjusting the Projection Size (Zoom Adjustment)	25
Adjusting the Projector's Tilt	26
Correcting Keystone Distortion	26
Correct automatically (Auto V-Keystone)	26
Correct manually (H-Keystone adjuster)	26
Correct manually (H/V-Keystone)	27
Adjusting the Volume	28
Hiding the Image and Muting the Audio Temporarily	28

Adjusting the Image

Adjusting the Image	29
Selecting the Projection Quality (Color Mode)	29
Switching the Screen Between Wide and Zoom (Aspect)	30
Absolute Color Adjustments	32
Adjusting Hue, Saturation, and Brightness	32
Adjusting the Gamma	33
Select and adjust the correction value	33
Adjust while viewing the image	33
Adjust using the gamma adjustment graph	34
Adjusting the RGB (Offset/Gain)	34
Abs. Color Temp.	35
Skin Tone	35
Detailed Image Adjustments	36

Adjusting the Sharpness	36
Setting Auto Iris	37
Super-resolution	37
Image Processing	38
Viewing the Image at the Saved Image Quality (Memory Function)	39
Saving Function	39
Saving a Memory	39
Loading a Memory	40
Deleting a Saved Memory	40
Renaming a Memory	40
Useful Functions	
Enjoying 3D Images	42
Setting 3D Images	42
If the 3D image cannot be viewed	42
Using 3D Glasses	43
Charging the 3D Glasses	43
Pairing 3D Glasses	43
Wearing the 3D Glasses	44
Range for Viewing 3D Images	44
Warnings Regarding Viewing 3D Images	45
Converting 2D Images to 3D and Viewing	48
Connecting with WirelessHD (EH-TW6100W Only)	49
Installing the WirelessHD Transmitter	49
WirelessHD Transmitter part names	50
Setting the WirelessHD Transmitter	51
Projecting Images	52
WirelessHD Settings Menu	53
WirelessHD Transmission Range	54
Useful Functions of the WirelessHD Transmitter	55
Switching the target image	55
Switching the image source	57
Remote control operating range	58
Using the HDMI Link Function	59
HDMI Link Function	59
HDMI Link Settings	59
Device Connections	60

Changing Between Two Types of Images	61
Types of Screen that can be Displayed Simultaneously	61
Projecting on a Split Screen	61
Starting split screen display	61
Changing the split screen settings	62
Playing Back Image Data (Slideshow)	63
Compatible Data	63
Playing a Slideshow	63
Display Settings for Image Files and Slideshow Operation Settings	64

Configuration Menu

Configuration Menu Functions	65
Configuration Menu Operations	65
Configuration Menu Table	66
Image menu	66
Signal menu	68
Settings menu	71
Extended menu	73
Memory menu	74
Info menu	75
Reset menu	75
Split Screen menu	76

Troubleshooting

Problem Solving	77
Reading the Indicators	77
Indicator status during an error/warning	77
Indicator status during normal operation	78
When the Indicators Provide No Help	79
Check the problem	79
Problems relating to images	80
Problems when projection starts	84
Problems with the remote control	84
Problems with 3D	85
Problems with HDMI	85
Problems with WirelessHD (EH-TW6100W only)	86

Problems with USB storage devices 87
Other problems 87

Maintenance

Maintenance 88
Cleaning the Parts 88
 Cleaning the air filter 88
 Cleaning the main unit 89
 Cleaning the lens 90
 Cleaning the 3D Glasses 90
Replacement Periods for Consumables 90
 Air filter replacement period 90
 Lamp replacement period 90
Replacing Consumables 91
 Replacing the air filter 91
 Replacing the lamp 92
 Resetting lamp hours 93

Appendix

Optional Accessories and Consumables 95
 Optional Items 95
 Consumables 95
Supported Resolutions 96
 Component Video 96
 Composite Video 96
 Computer Signals (Analog RGB) 96
 HDMI1/HDMI2 Input Signal 97
 3D Input Signal 97
 WirelessHD Input Signal 97
Specifications 98
Glossary 101
General Notes 102
 Notes when Wearing 3D Glasses 102
 General Notice 103

Projector Features

Dynamic 3D Display

Enjoy 3D contents on Blu-ray and images filmed with a 3D camera through a stunning projection display. [p.42](#)

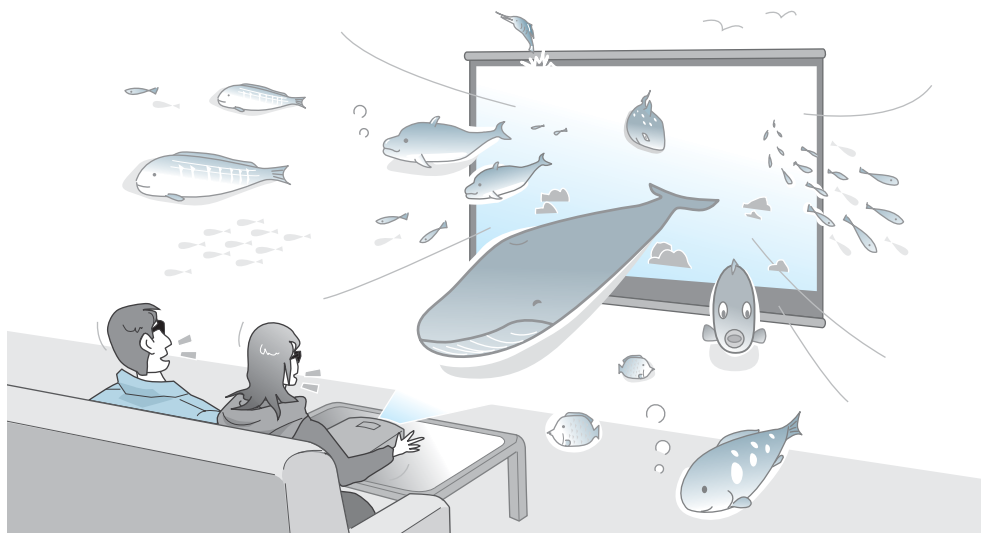

You need dedicated 3D Glasses based on 3D Active Shutter Eyewear Technology to view 3D images. [p.43](#)

Selecting Modes to Match what you are Watching (Color Mode)

By simply selecting the **Color Mode**, you can project the optimum image to suit your surroundings. [p.29](#)

Setting Example

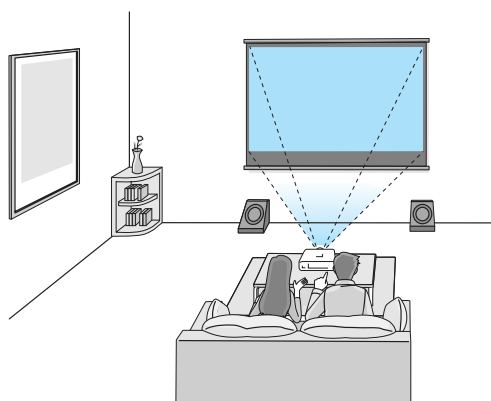

Living Room
For use in a bright room

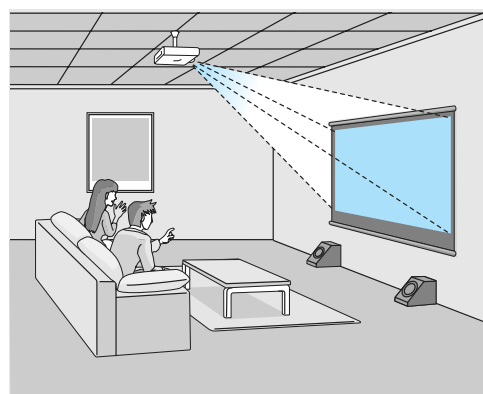

Cinema
For movies and concerts in a dark room

Absolute Color Adjustment

As well as using Color Mode, you can also adjust the absolute color temperature of the image and skin tones to suit your taste. [p.35](#)

What's more, you can obtain colors that match the image and achieve the colors you want through a combination of gamma adjustment, RGB offset or gain adjustment for each color, and hue, saturation, and brightness adjustment for each RGB/CMY color. [p.32](#)

Conforms to Wireless Transmissions for the WirelessHD Standards (EH-TW6100W Only)

The projector can wirelessly receive data for images and audio from WirelessHD compatible AV devices. You do not need to connect a cable directly to the main projector unit.



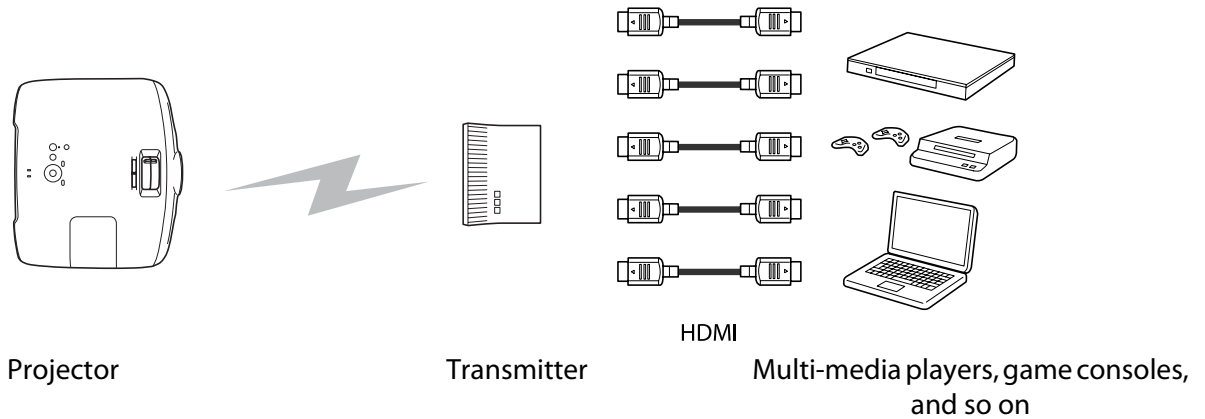

You can connect up to five AV devices to the WirelessHD Transmitter at the same time, and switch images using the remote control.

You can also connect other output devices such as televisions, and switch the device. This allows other output devices to project images from the connected AV device, even if the projector is off.  [p.49](#)



Other Useful Functions

In addition, the following useful functions are provided.

- The remote control contains a backlight function allowing for easy use even in dark rooms. Operations are also simplified by only pressing the  button.  [p.10](#)
- Audio is played back via the built-in speaker eliminating the need for external speakers. The **Inverse Audio** function also allows you to switch the left and right audio streams when the projector is suspended from a ceiling.  [p.71](#)
- You can view slideshows by simply connecting a USB memory to the projector. When a digital camera is connected, you can view the photos on the camera using **Slideshow**.  [p.63](#)
- The H-Keystone slider allows you to quickly correct keystone distortion when the projector cannot be setup directly in front of the screen. Because it is a slider, you can make corrections intuitively.  [p.26](#)

Part Names and Functions



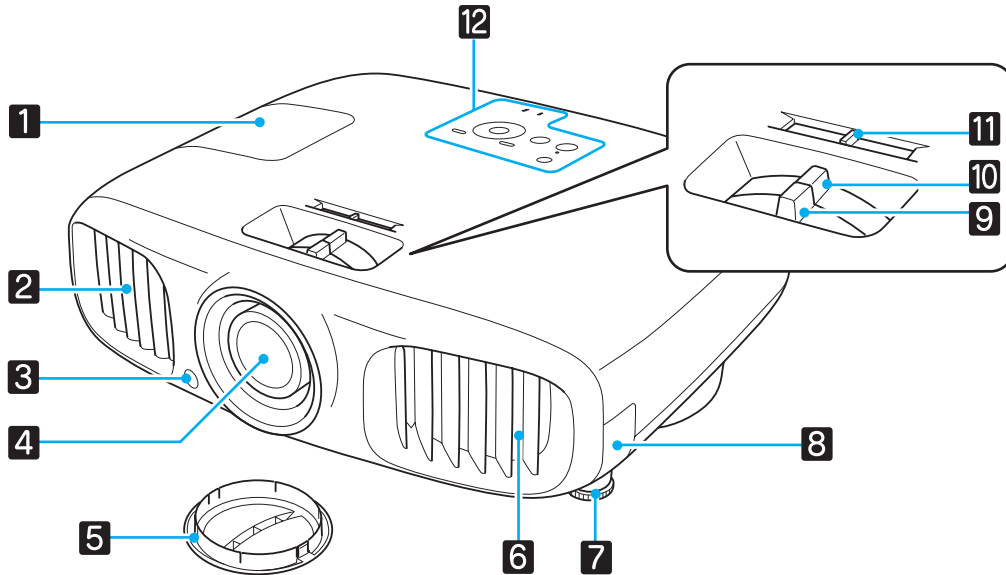





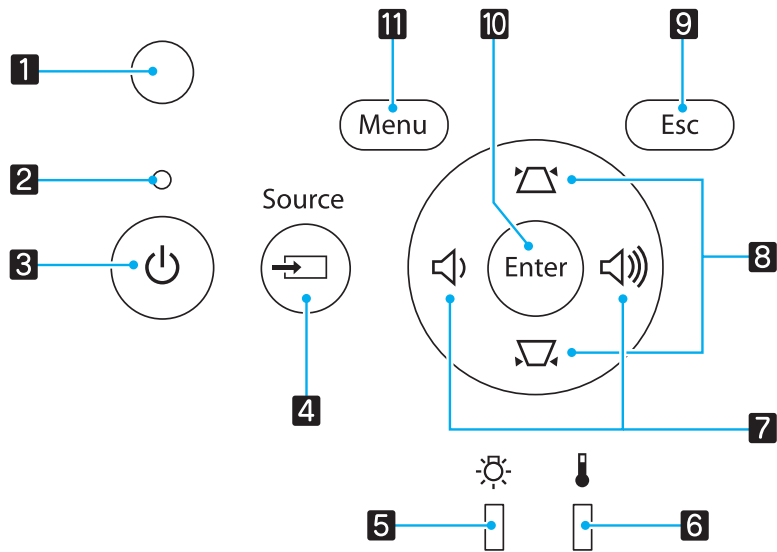



Front/Top



	Name	Function
1	Lamp cover	Open when replacing the projector's lamp. p.92
2	Air exhaust vent	Exhaust vent for air used to cool the projector internally. <div style="border: 1px solid black; padding: 5px;"> <p>⚠ Caution</p> <p>While projecting, do not put your face or hands near the air exhaust vent, and do not place objects that may become warped or damaged by heat near the vent. Hot air from the air exhaust vent could cause burns, warping, or accidents to occur.</p> </div>
3	Remote receiver	Receives signals from the remote control. p.21
4	Projector's lens	Images are projected from here.
5	Lens cover	Install when not using the projector to protect the lens from being scratched or soiled. p.22
6	Air intake vent	Intake vent for air used to cool the projector internally.
7	Front adjustable foot	When setup on a surface such as a table, extend the foot to adjust the horizontal tilt. p.26
8	Air filter cover	When cleaning or replacing the air filter, open this cover and remove the air filter. p.88 , p.91
9	Focus ring	Adjusts the image focus. p.25
10	Zoom ring	Adjusts the image size. p.25
11	H-Keystone slider	Performs horizontal keystone correction. p.26
12	Control panel	Control panel on the projector. p.9

Control Panel







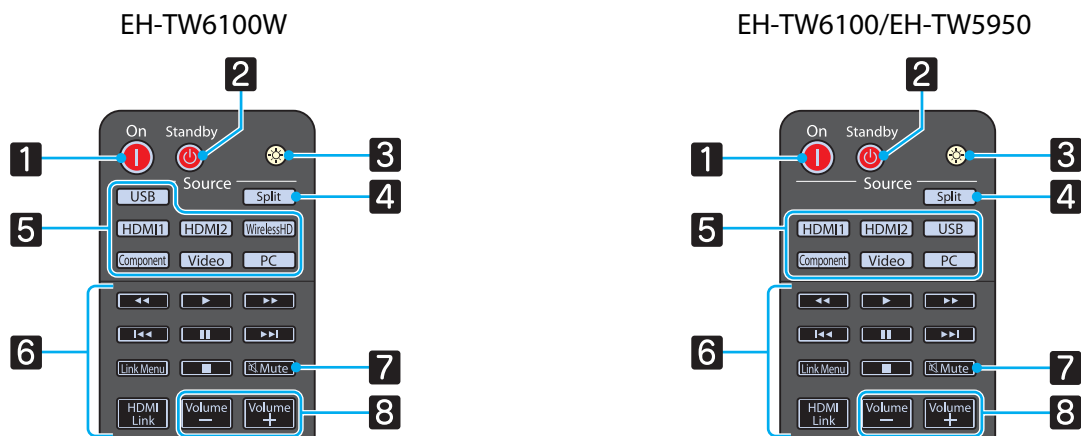

Buttons/Indicators	Function
1  Brightness sensor	Detects the brightness of the room. When Color Mode is set to "Auto", the optimum image quality is set according to the brightness detected by the sensor. p.29
2  Operation indicator	Flashes to indicate warm-up in progress or cool-down in progress. Shows the projector's status through a combination of other indicators lit and flashing. p.77
3  Power button	Turns the projector power on or off. p.22 Lit when the projector is on. p.78
4 Source 	Changes to the image from each input port. p.23
5  	Flashes orange when it is time to replace the lamp. Shows the projector's errors through a combination of other indicators lit and flashing. p.77
6  	Flashes orange if the internal temperature is too high. Shows the projector's errors through a combination of other indicators lit and flashing. p.77
7 	Selects the adjustment value for the volume and for menu items. p.28 Performs horizontal keystone correction when the Keystone screen is displayed. p.27
8 	Selects the adjustment value for the keystone correction and for menu items. p.27
9 	Returns to the previous menu level when a menu is displayed. p.65
10 	Selects functions and settings when a menu is displayed. p.65
11 	Displays and closes the configuration menu. On the configuration menu, you can make adjustments and settings for Signal, Image, Input Signal, and so on. p.65

Remote Control





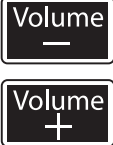

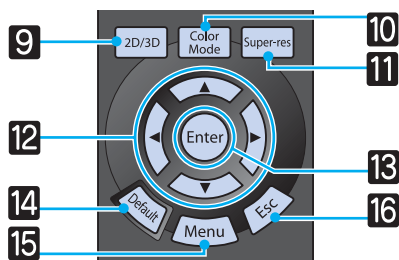

Top section buttons

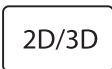

Button	Function
1	 Turns the projector on. p.22
2	 Turns the projector off. p.23
3	 The remote control buttons light up for approximately 10 seconds. This is useful when operating the remote control in the dark.
4	 Splits the screen in two and projects two image sources simultaneously. p.61
5	 Changes to the image from each input port. p.23
6	 This button displays the settings menu for HDMI Link. With the other buttons, you can then start or stop playback, adjust the volume, and so on for connected equipment that meets the HDMI CEC standards. p.59
7	 Temporarily mutes or plays the audio. p.28
8	 Adjusts the volume. p.28

Middle section buttons



	Button	Function
9		Changes between 2D and 3D. 🖱️ p.42
10		Changes the Color Mode . 🖱️ p.29
11		Set Super-resolution to reduce blurring in areas such as the edges of the image. 🖱️ p.37
12		Selects menu items and adjustment values. 🖱️ p.65
13		When a menu is displayed, it accepts and enters the current selection and moves to the next level. 🖱️ p.65
14		The adjustment value returns to its default value when pressed while the menu's adjustment screen is displayed. 🖱️ p.65
15		Displays and closes the configuration menu. On the configuration menu, you can make adjustments and settings for Signal, Image, Input Signal, and so on. 🖱️ p.65
16		Return to the previous menu level when a menu is displayed. 🖱️ p.65

Bottom section buttons

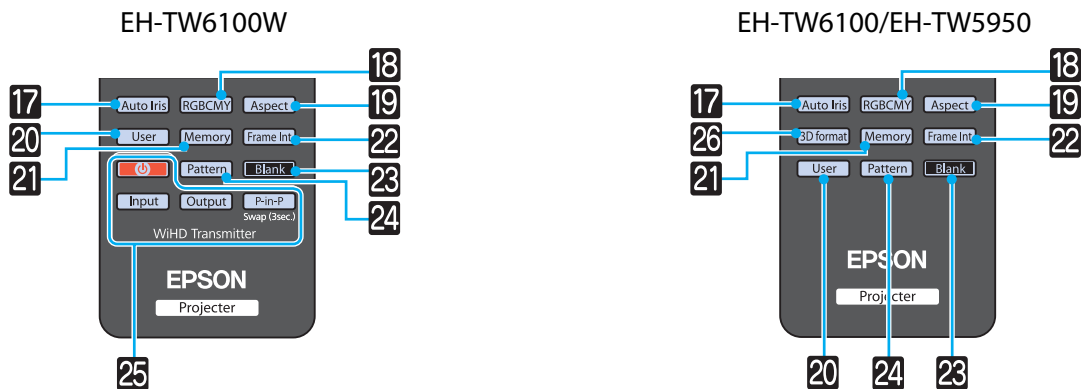

Button		Function
17	Auto Iris	Sets Auto Iris. p.37
18	RGBCMY	Adjusts the hue, saturation, and brightness for each RGBCMY color. p.32
19	Aspect	Selects the aspect mode according to the input signal. p.30
20	User	Performs the function assigned to the user button. p.71
21	Memory	Saves, loads, or erases a memory. p.39
22	Frame Int	This button is disabled.
23	Blank	Temporarily hides or shows the image and audio. p.28
24	Pattern	Displays and closes the test pattern. p.25
25	 Input Output P-in-P	WiHD Transmitter control Turns on the WirelessHD Transmitter, or switches the input and output. Make sure you point the remote control at the WirelessHD Transmitter when performing operations. p.49
26	3D format	Changes the 3D format. p.68

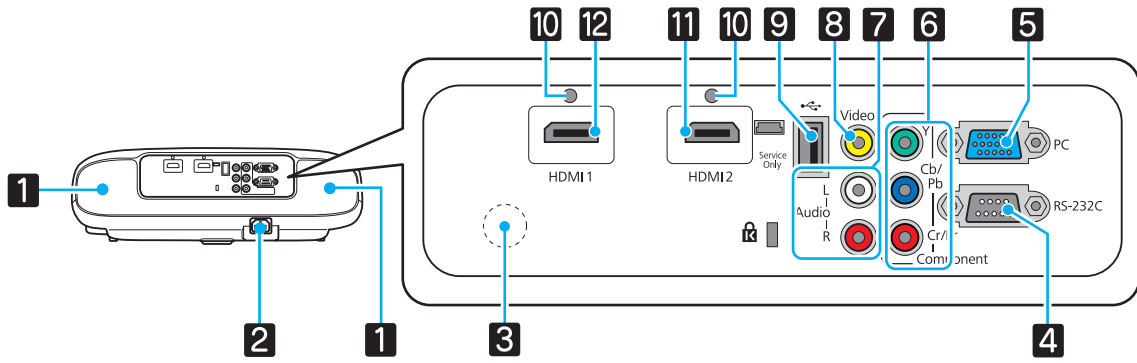

Rear

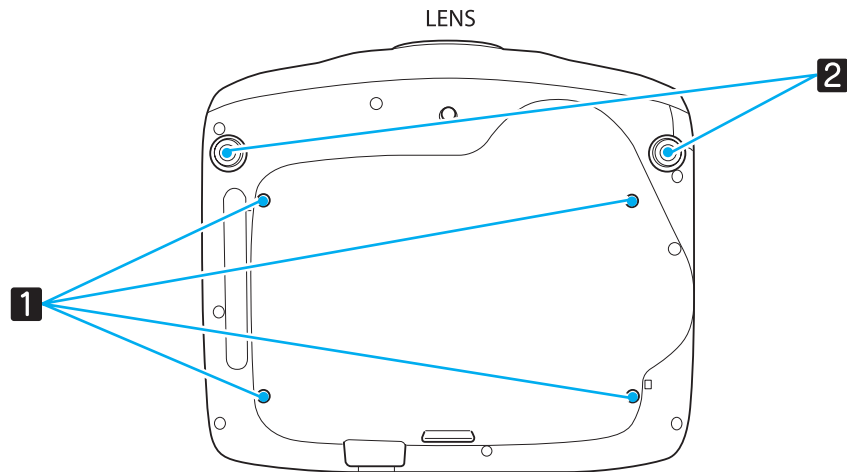

Name		Function
1	Speaker	The projector's built-in speaker. Outputs audio. Set Inverse Audio to On to use the built-in speaker when the projector is suspended from a ceiling. Settings - Audio - Inverse Audio p.71
2	Power inlet	Connects the power cable. p.22
3	Remote receiver	Receives signals from the remote control. p.21
4	RS-232C port	When controlling the projector, connect the projector to a computer with an RS-232C cable. This port is for control use and should not normally be used. p.98
5	PC port	Connects to the RGB output port on a computer. p.19
6	Component port	Connects to the component (YCbCr or YPbPr) output port on video equipment. p.18
7	Audio (L-R) port	Inputs audio from equipment connected to the Video port, Component port, or the PC port. p.18
8	Video port	Connects to the composite video output port on video equipment. p.18
9	USB port	Connects USB devices such as a USB memory device or a digital camera, and projects images as a slideshow. p.19
10	Cable holder	Thick HDMI cables with a large outer diameter and so on, may disconnect easily due to the weight of the cable. To prevent the cable from disconnecting, fix it in place using the HDMI cable clamp supplied. p.20
11	HDMI2 port	Connects HDMI compatible video equipment and computers. p.18
12	HDMI1 port	

Base



	Name	Function
1	Ceiling mount fixing points (four points)	Attaches the optional ceiling mount here when suspending the projector from a ceiling.  p.95
2	Front adjustable foot	When setup on a surface such as a table, extend the foot to adjust the height.  p.26



Appearance

Units: mm

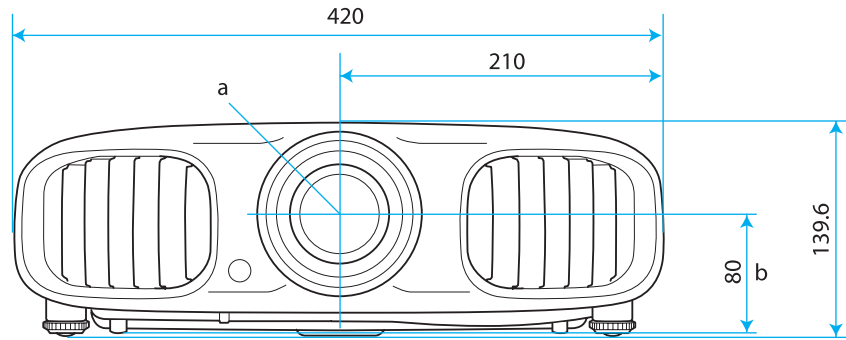

- a Center of lens
- b Distance from center of lens to suspension bracket fixing point

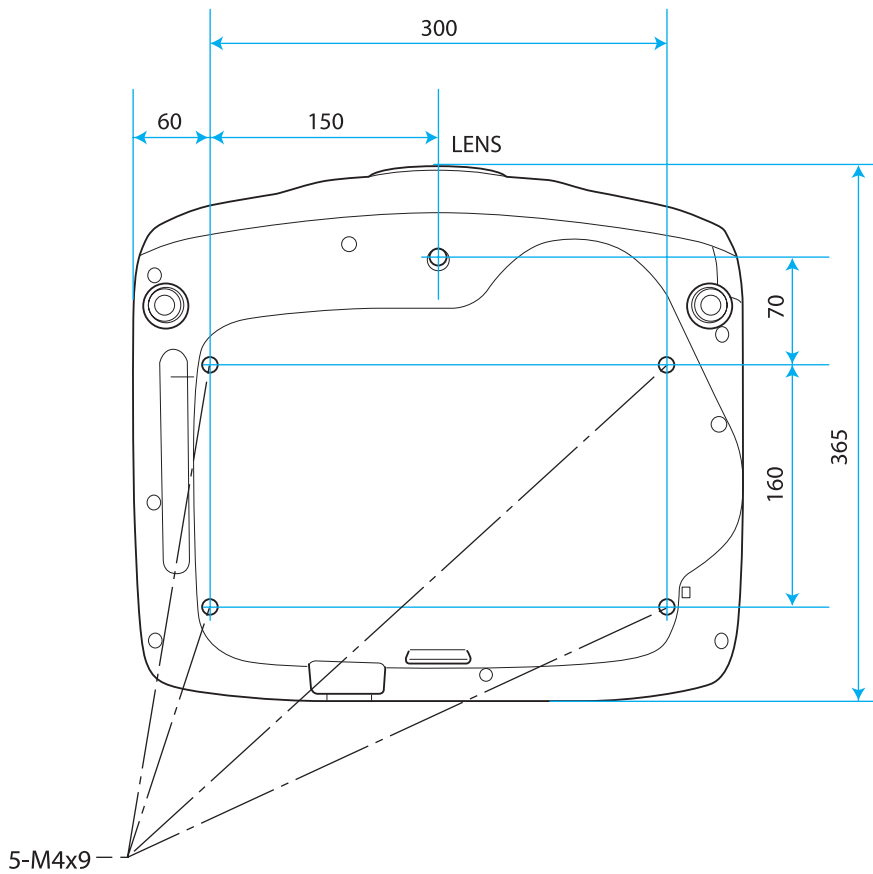



Installing

Various Projection Methods

Warning

- A special method of installation is required when suspending the projector from a ceiling (ceiling mount). If it is not installed correctly, it could fall causing an accident and injury.
- If you use adhesives, lubricants, or oil on the ceiling mount fixing points to prevent screws from loosening, or if you use things such as lubricants or oils on the projector, the projector case may crack causing it to fall from its ceiling mount. This could cause serious injury to anyone under the projector and also damage the projector.
- Do not setup the projector on its side. This may cause malfunctions to occur.
- Try not to setup the projector in locations subject to high humidity and dust, or in locations subject to smoke from fires or tobacco smoke.



Attention

Clean the air filter once every three months. Clean it more often if the environment is particularly dusty.

 [p.91](#)

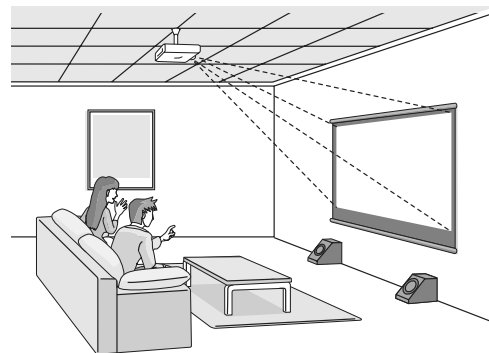
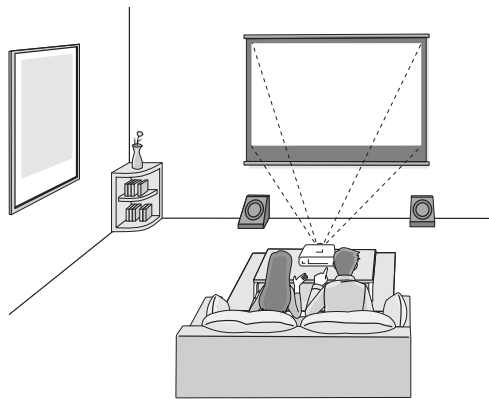
Placing on a table and so on and projecting Suspending from the ceiling and projecting



- When projecting from a ceiling, change **Projection** to a ceiling setting.  **Settings - Projection** [p.71](#)
- Set **Inverse Audio** to **On** to use the built-in speaker when the projector is suspended from a ceiling.  **Settings - Audio - Inverse Audio** [p.71](#)
- When the projector cannot be setup directly in front of the screen, you can correct keystone distortion with the H-Keystone slider.  [p.26](#)

Adjusting the Projection Size

The size of the projection increases as the projector is moved away from the screen.

Use the table below to setup the projector at the optimum position from the screen. The values given here are for your reference only.

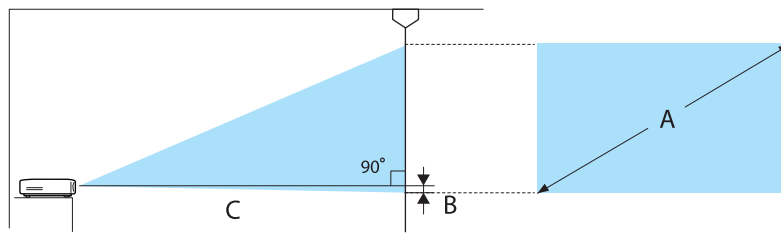

B Distance from the center of the lens to the base of the projection screen

Unit: cm

16:9 Screen Size		Projection Distance (C)		Distance (B)
A	W x H	Minimum (Wide)	Maximum (Tele)	
40"	89 x 50	116	190	0
60"	130 x 75	176	287	0
80"	180 x 100	235	383	0
100"	220 x 120	295	480	0
120"	270 x 150	354	576	0
150"	330 x 190	444	721	1
180"	440 x 250	533	866	1

Unit: cm

4:3 Screen Size		Projection Distance (C)		Distance (B)
A	W x H	Minimum (Wide)	Maximum (Tele)	
40"	81 x 61	143	233	0
60"	120 x 90	216	352	0
80"	160 x 120	289	470	0
100"	200 x 150	361	588	0
120"	240 x 180	434	706	1
150"	300 x 230	544	883	1
200"	410 x 300	726	1179	1

Connecting to a Device

Attention

- Turn off the equipment you want to connect before connecting. If the equipment is on when you connect, it could cause a malfunction.
- Check the shape of the cable's connector and the shape of the port, and then connect. If you force a connector of a different shape into the port, it could cause damage and a malfunction to occur.

EH-TW6100W comes with an interface cover allowing you to clearly see the connector section on the rear. Remove the interface cover before connecting any cables.  [p.20](#)

Connecting to Video Equipment

To project images from DVD players or VHS video and so on, connect to the projector using one of the following methods.

When using an HDMI cable

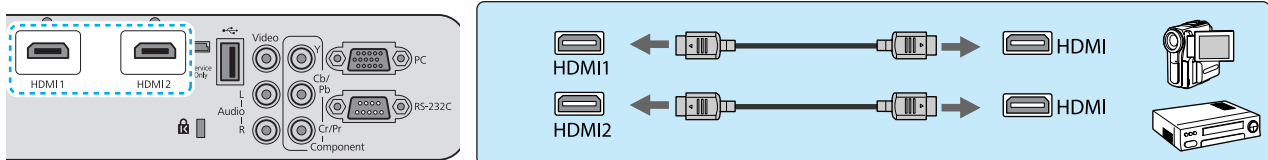

Fix the HDMI cable in place using the HDMI cable clamp.  [p.20](#)

When using a video cable

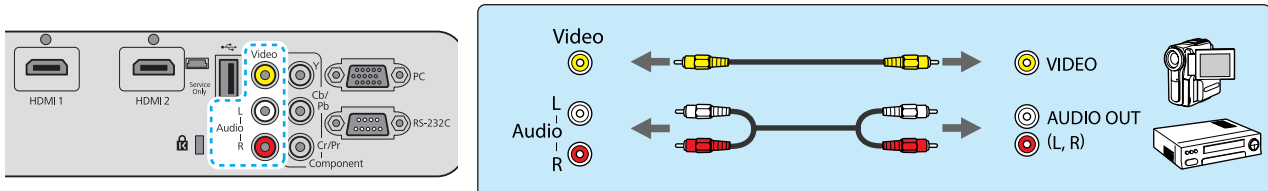

When using a component video cable

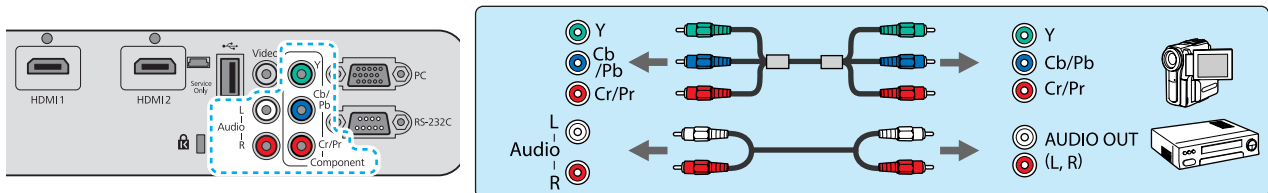

- The cable differs depending on the output signal from the connected video equipment.
- Some types of video equipment are capable of outputting different types of signals. Check the user's guide supplied with the video equipment to confirm which signals can be output.

Connecting to a Computer

To project images from a computer, connect the computer using one of the following methods.

When using a computer cable

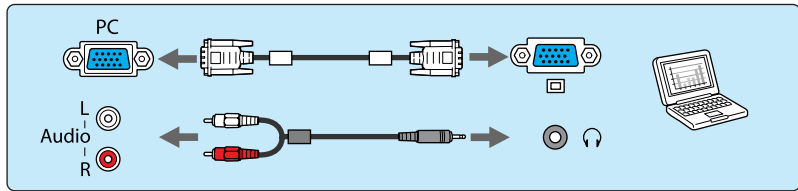
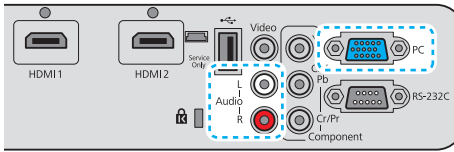

When using an HDMI cable

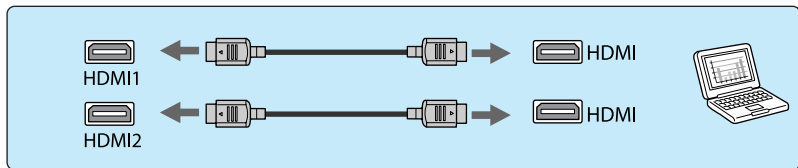
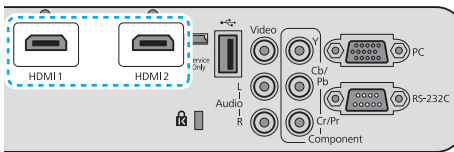

Fix the HDMI cable in place using the HDMI cable clamp. [p.20](#)

Connecting to External Devices

Connecting USB devices

You can connect USB devices such as USB memories, and USB compatible digital cameras.

Using the USB cable supplied with the USB device, connect the USB device to the USB (TypeA) port on the projector.

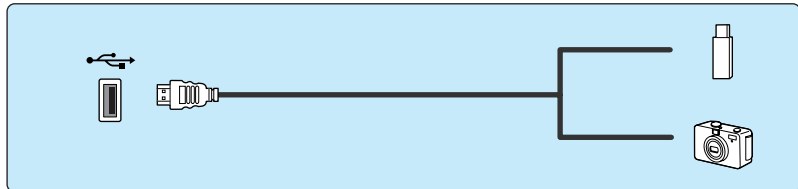
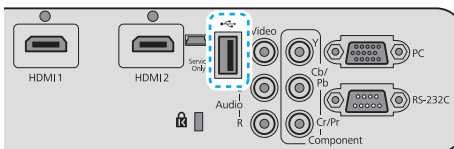

When the USB device is connected, you can project image files on the USB memory or digital camera as a slideshow. [p.63](#)



When you have finished projecting, remove USB devices from the projector. For devices with a power switch, make sure you turn them off before disconnecting the USB device.

Attention

- If you use a USB hub, the connection may not operate correctly. Devices such as digital cameras and USB devices should be connected to the projector directly.
- Connect a digital camera using a USB cable specified for use with the device.
- Use a USB cable less than 3 m in length. If the cable exceeds 3 m, slideshow may not function correctly.

■ Connecting WirelessHD devices (EH-TW6100W only)

The projector receives transmissions from the WirelessHD Transmitter, and projects the images. 🖱️ [p.49](#)

Change the projected image by pressing the  button on the remote control or the  button on the control panel.



- When receiving WirelessHD images, make sure **WirelessHD** is set to **On**. 🖱️ **Settings - WirelessHD** [p.71](#)
- You can change which device is displayed by selecting a device from **Device Connections** in **HDMI Link**. 🖱️ **HDMI Link-Device Connections** [p.60](#)

Removing the Interface Cover

The interface cover is attached to the connector section on the rear of EH-TW6100W. Remove this cover when using a cable to connect a device.

There are gaps at the bottom of the interface cover that allows you to pull the cover forward and lift it from the grooves at the top.

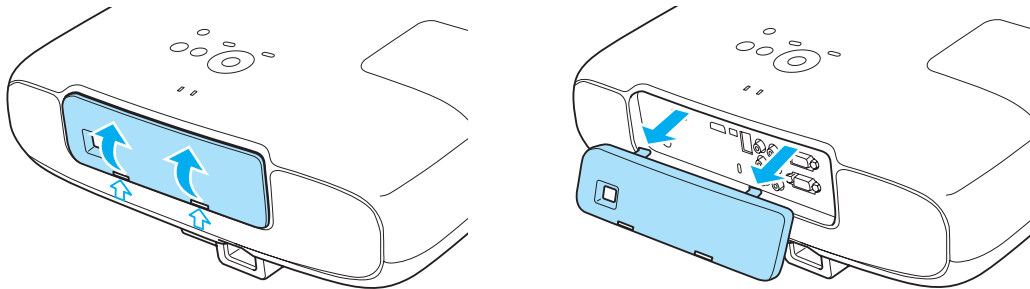

- When reattaching, first insert the protruding sections into the grooves at the top.
- Make sure you store the interface cover safely, as you need this when transporting the projector.

Connecting an HDMI Cable Clamp

If the HDMI cable is thick and hangs down, make sure you secure it to the cable holder with an HDMI clamp so that the cable's weight does not disconnect it from the port.

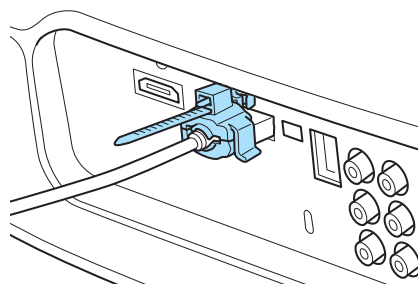

Preparing the Remote Control

Installing the Remote Control Batteries

Attention

- Check the positions of the (+) and (-) marks inside the battery holder to ensure the batteries are inserted the correct way.
- You cannot use other batteries except for the AA size manganese or alkaline.

- 1** Remove the battery cover.
While pushing the battery compartment cover catch, lift the cover up.

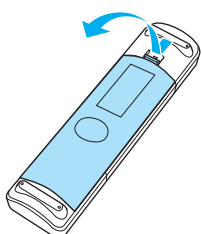

- 2** Replace the old batteries with new batteries.
Check the polarity of the batteries (+ and -) before installing.

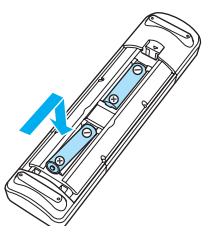

- 3** Reattach the battery cover.
Press the cover until it clicks into place.

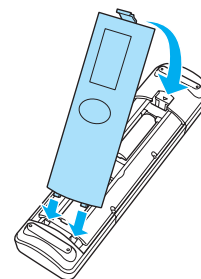

 If delays in the responsiveness of the remote control occur or if it does not operate, it probably means that the batteries are becoming flat. When this happens, replace them with new batteries. Have two AA size manganese or alkaline batteries ready.

Remote Control Operating Range

The operation range for the WirelessHD Transmitter differs.  [p.58](#)

Operating range (left to right)

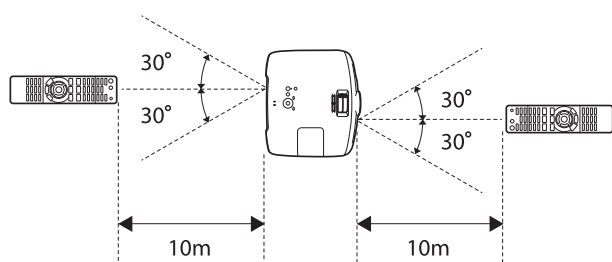

Operating range (top to bottom)

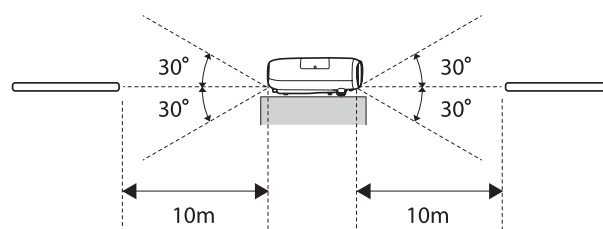

Starting and Ending Projection

Turning on the Projector and Projecting

- 1 Connect the power cable.
Connect using the power cable supplied.

- 2 Remove the lens cover.

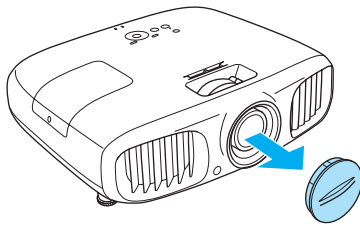

- 3 Turn on the connected equipment.

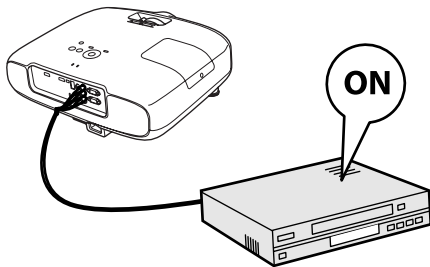

- 4 Turn the power on.

Remote control

Control panel

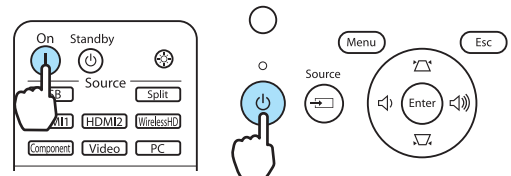

When **Direct Power On** is set to **On**, you can start projecting by simply connecting the power cable to the projector without having to press any buttons. **Extended - Operation - Direct Power On** [p.73](#)

Warning

Do not look into the lens during projection.

- This projector provides a Child Lock function to prevent children from accidentally turning the power on and a Control Panel Lock function to prevent accidental operations and so on. **Settings - Child Lock/Control Panel Lock** [p.71](#)
- When using at an altitude of 1500 m or more, set **High Altitude Mode** to **On**. **Extended - Operation - High Altitude Mode** [p.73](#)
- This projector provides an Auto Setup function to automatically select the optimum settings when the input signal for the connected computer image changes. **Signal - Auto Setup** [p.68](#)
- Do not attach the lens cover during projection.
- If the projector is suspended from a ceiling, after removing the lens cap, make sure you keep it in a safe place as you will need to attach it when transporting the projector.

If the Target Image is not Projected

If the image is not projected, you can change the source using one of the following methods.

Remote control

Press the button for the target port.

EH-TW6100W

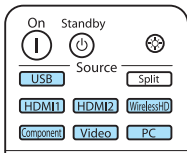

EH-TW6100/EH-TW5950

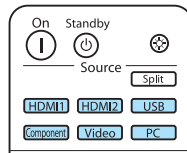

Control panel

Press the button and select the target port.

Press the button to confirm the selection.

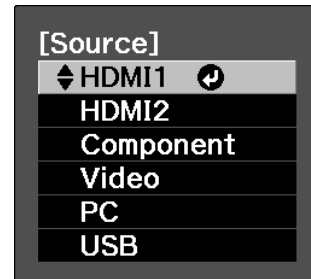

- For video equipment, start playback first and then change the source.
- If the color looks unnatural when changing to a **Video** or **Component** source, check that the port you have connected to is the same as the **Input Signal**. **Extended - Input Signal - Video Signal/Component** [p.73](#)

Turning Off

1 Turn off the connected equipment.

2 Press the button on the remote control or the projector's control panel.

Remote control

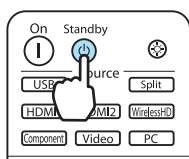

Control panel

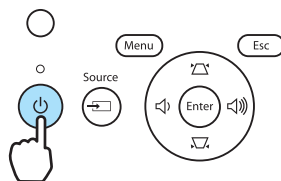

A confirmation message is displayed.

3 Press the button again.

Power Off?

Yes : Press button
No : Press any other button



When **Standby Confirmation** is set to **Off**, you can turn off the projector by pressing the button on the remote control once. **Extended - Display - Standby Confirmation** [p.73](#)

4 Wait until cool-down is complete.
The operation indicator on the projector's control panel stops flashing.

5 Disconnect the power cable.



If the power cable is connected, some electricity is consumed even if no operations are made.

6

Reattach the lens cover.

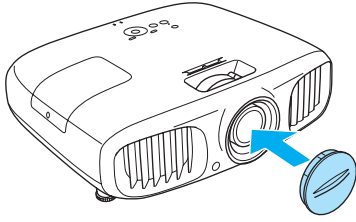



Adjusting the Projected Screen

Displaying the Test Pattern

When adjusting the zoom/focus or the projection position just after setting up the projector, you can display a test pattern instead of connecting video equipment.

Press the **Pattern** button on the remote control to display the test pattern.

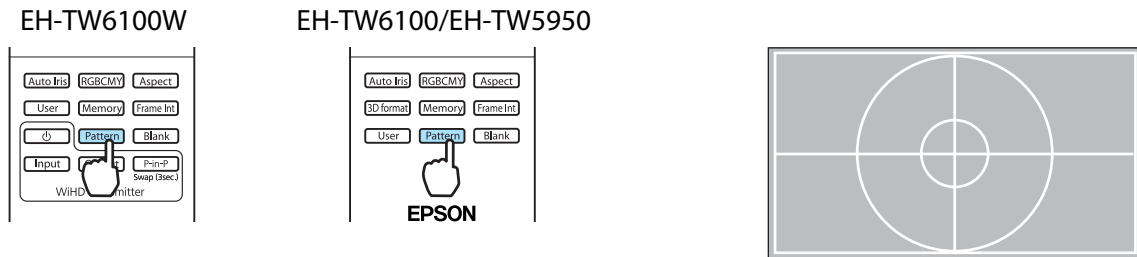

Press the **Esc** button to close the test pattern, or select **Exit**.

Adjusting the Focus

Turn the focus ring to adjust the focus.

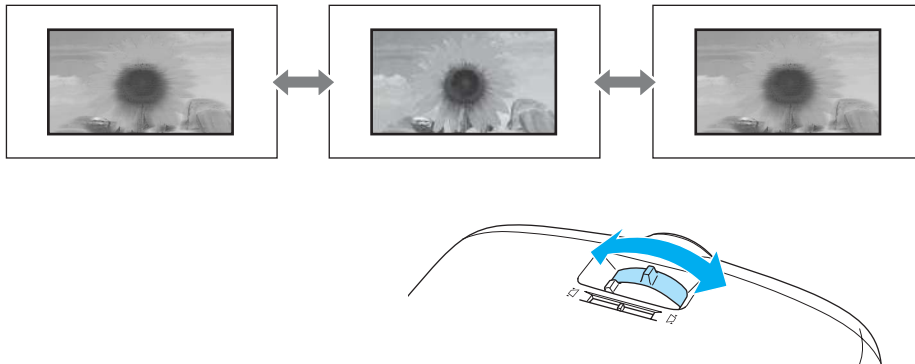

Adjusting the Projection Size (Zoom Adjustment)

Turn the zoom ring to adjust the size of the projected screen.

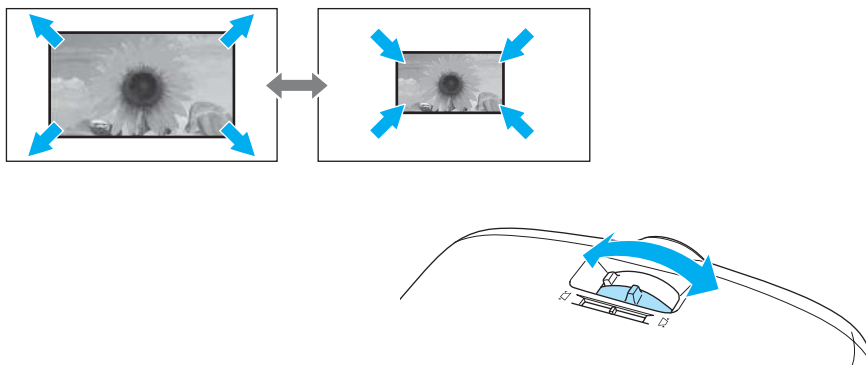

Adjusting the Projector's Tilt

If the projection screen is tilted (the left and right sides of the projector are at different heights) when the projector is setup on a table, adjust the front foot so that both sides are level with each other.

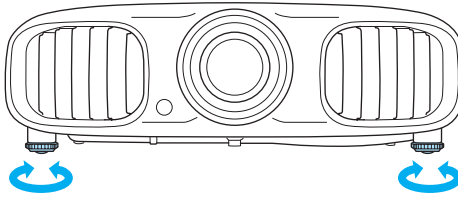

Correcting Keystone Distortion

You can correct keystone distortion using one of the following methods.

Correct automatically	Auto V-Keystone	Automatically correct vertical keystone distortion.
Correct manually	H-Keystone Adjuster	Correct horizontal keystone distortion with the H-Keystone slider.
	H/V-Keystone	Manually correct distortion in the horizontal and vertical directions independently.



The projected screen becomes smaller when correcting keystone distortion. Increase the projection distance to fit the projected screen to the screen size.

■ Correct automatically (Auto V-Keystone)

If the the projector detects movement during installation, vertical keystone distortion is corrected automatically. If the projector detects movement after it has been left in the same position for two seconds or more, the adjustment screen is displayed allowing you to make corrections.

Auto V-Keystone can make effective corrections within a projection angle of 30° top to bottom.



- Auto V-Keystone only functions when **Front** is selected as the **Projection** mode.  **Settings - Projection** [p.71](#)
- If you do not want to use the Auto V-Keystone function, set **Auto V-Keystone** to **Off**.  **Settings - Keystone - Auto V-Keystone** [p.71](#)

■ Correct manually (H-Keystone adjuster)

Move the H-Keystone Slider to the right or left to perform horizontal keystone correction.

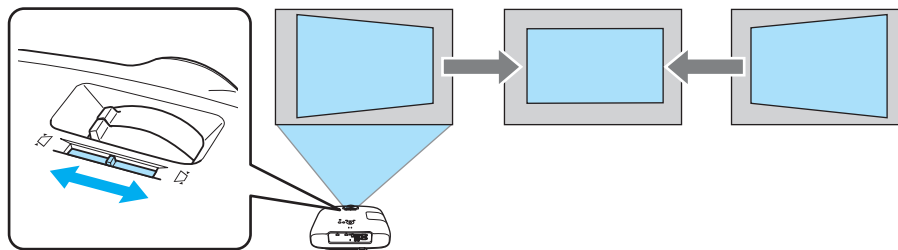

You can make effective corrections within a projection angle of 30° left to right.

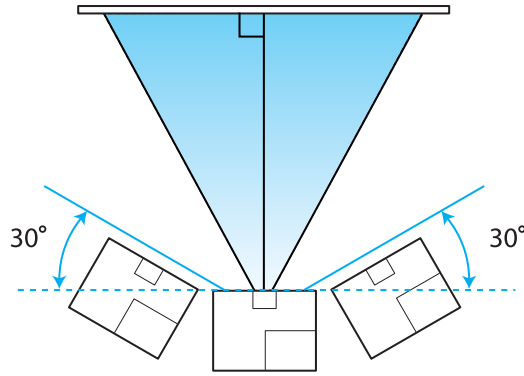

When using the H-Keystone Adjuster, set **H-Keystone Adjuster** to **On**. **Settings - Keystone - H-Keystone Adjuster p.71**

Correct manually (H/V-Keystone)

You can use the buttons on the control panel to correct keystone distortion.

Press the buttons to display the V-Keystone/H-Keystone gauges.

When the gauges are displayed, press the buttons to perform vertical correction, and press the buttons to perform horizontal correction.

When the top or bottom is too wide

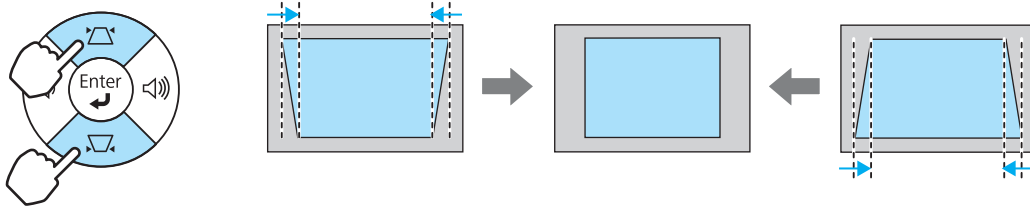



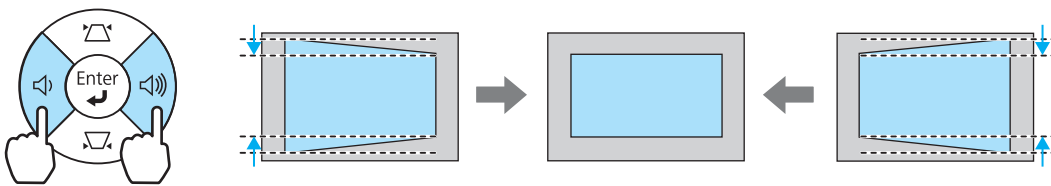

When the left or right is too wide



- You can adjust the volume by pressing the buttons when the gauges are not displayed. **p.28**
- You can set H/V-Keystone from the configuration menu. **Settings - Keystone - H/V-Keystone - V-Keystone/H-Keystone p.71**
- You can make effective corrections within a projection angle of 30° top to bottom and left to right.

Adjusting the Volume

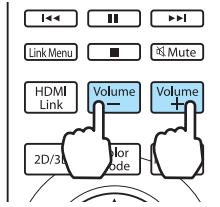

You can adjust the volume by using the   buttons on the remote control or the   buttons on the projector's control panel.

Remote control

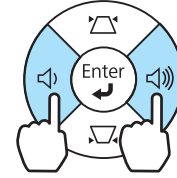

Control panel



- You can also adjust the volume from the configuration menu.  **Settings - Audio** [p.71](#)
- Under normal conditions, you can adjust the volume of the projector's built-in speaker. However, by connecting an AV system to the projector and setting **HDMI Link** to **On** and **Audio Out Device** to **AV System**, you can adjust the AV system's volume when projecting from **HDMI1**, **HDMI2**, and **WirelessHD** sources.  [p.59](#)



Caution

Do not start at high volume.

A sudden excessive volume may cause loss of hearing. Always lower the volume before powering off, so that you can gradually increase the volume when you next turn on the power.

Hiding the Image and Muting the Audio Temporarily

You can use this to temporarily hide the image on the screen and mute the audio.

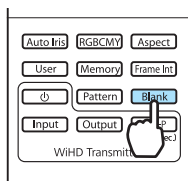

Press the  button to show or hide the image. The audio is also muted or played.

EH-TW6100W

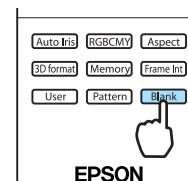

EH-TW6100/EH-TW5950



- For movies, because the movie continues to play even when it is hidden, you cannot return to the point at which you hid the image and muted the audio using the  button.
- The  button also switches between muting and playing the audio.
- Under normal conditions, you can adjust the audio of the projector's built-in speaker. However, by connecting an AV system to the projector and setting **HDMI Link** to **On** and **Audio Out Device** to **AV System**, you can adjust the AV system's audio when projecting from **HDMI1**, **HDMI2**, and **WirelessHD** sources.  [p.59](#)





Adjusting the Image

Selecting the Projection Quality (Color Mode)

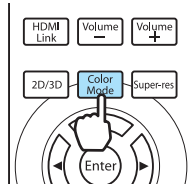

You can obtain the optimum image quality to suit your surroundings when projecting. The brightness of the image varies depending on the mode selected.

1 Press the  button.



You can make settings from the configuration menu.  **Image - Color Mode** [p.66](#)

2 Select **Color Mode**.

Press the   buttons from the displayed menu to select **Color Mode**, and then press the  button to confirm the selection.

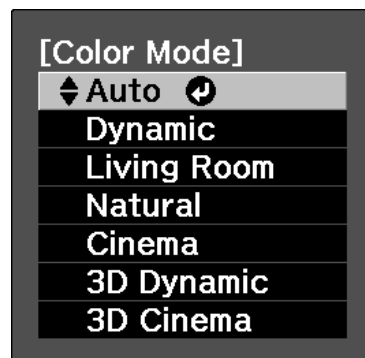

When projecting 2D images

You can select **Auto**, **Dynamic**, **Living Room**, **Natural**, and **Cinema**. **3D Cinema** and **3D Dynamic** are grayed out and cannot be selected.

When projecting 3D images

You can select **3D Cinema** and **3D Dynamic**.

Auto, **Dynamic**, **Living Room**, **Natural**, and **Cinema** are grayed out and cannot be selected.

Choices when projecting 2D images

Mode	Application
Auto	Sets the color mode automatically according to the surroundings. The optimum image quality is set according to the brightness of the room detected by the sensor (auto color adjustment function).
Dynamic	Ideal for use in a bright room. This is the brightest mode, and reproduces shadow tones well.
Living Room	Ideal for use in a bright room. Images are clear and sharp.
Natural	Ideal for use in a dark room. We recommend performing color adjustment in this mode. 👉 p.6
Cinema	Ideal for watching movies and concerts in a dark room.



Auto cannot be set when the projector is suspended from the ceiling.

Choices when projecting 3D images

Mode	Application
3D Dynamic	For use when projecting 3D images. Images are bright and sharper than 3D Cinema.
3D Cinema	For use when projecting 3D images.

Switching the Screen Between Wide and Zoom (Aspect)

You can change the input signal's type, aspect ratio, and resolution to match the **Aspect** of the projection screen.

The available **Aspect** varies depending on the image signal currently being projected.

1 Press the **Aspect** button.

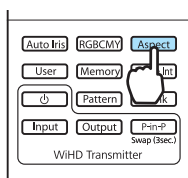

EH-TW6100W

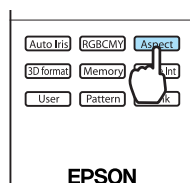

EH-TW6100/EH-TW5950



You can make settings from the configuration menu. 👉 **Signal - Aspect** p.68

2 Use the   buttons to select the setting name, and then press the  button to confirm the selection.

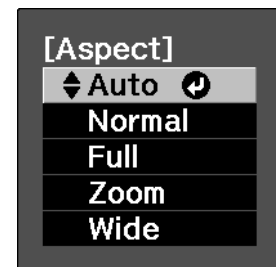

Aspect may not be available depending on the type of signal.

By normally selecting Auto, the optimum aspect is used to display the input signal. Change the setting if you want to use a different aspect.

Images for the HDMI connection are displayed using the same resolution as the original image source.

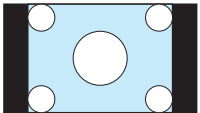
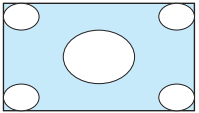
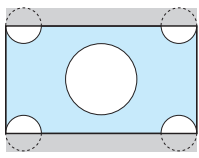
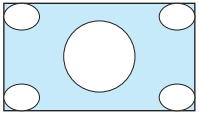
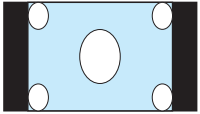
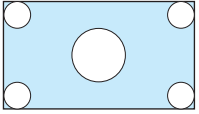
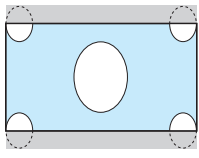
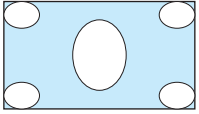
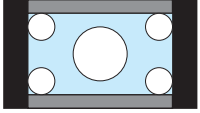
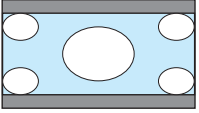
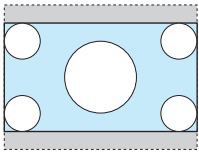
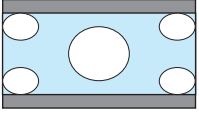
Input Image	Setting Name (Aspect)			
	Normal	Full	Zoom	Wide
4:3 Images				
16:9 Images and Images Recorded Using Squeeze				
Letterbox Images ^{*1*2}				
Notes	Matches the vertical size of the projection panel. The aspect ratio differs depending on the input image.	Uses the entire projection panel.	Retains the aspect ratio of the input signal, and matches the horizontal size of the projection panel. The top and bottom of the image may be truncated.	Displays the vertical and horizontal at the maximum. Both of the horizontal ends are enlarged.

*1 When **Zoom** is set, subtitles and so on may not be displayed. If this happens, try adjusting **Zoom Caption Pos.**

 **Signal - Zoom Caption Pos.** [p.68](#)

*2 The letterbox image used in this explanation is a 4:3 aspect ratio image displayed in 16:9 with black margins at the top and bottom for subtitle placement. The margins at the top and bottom of the screen image are used for subtitles.



Note that using the aspect ratio function of the projector to reduce, enlarge, or split the projected image for commercial purposes or for public viewing may infringe upon the rights of the copyright holder of that image based on copyright law.

Absolute Color Adjustments

Adjusting Hue, Saturation, and Brightness

You can adjust the hue, saturation, and brightness for each of the R (red), G (green), B (blue), C (cyan), M (magenta), and Y (yellow) colors.

Hue	Adjusts the overall color of the image to be blue, green, or red.
Saturation	Adjusts the overall vividness of the image.
Brightness	Adjusts the overall color brightness of the image.

1 Press the **RGBCMY** button.

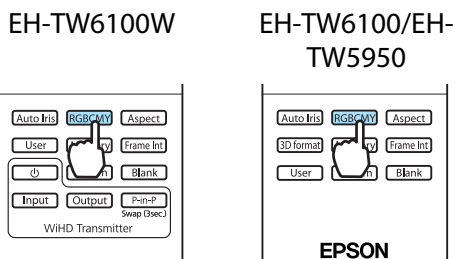

You can make settings from the configuration menu. **Image - Advanced - RGBCMY p.66**

2 Use the buttons to select the color you want to adjust, and then press the button to confirm the selection.

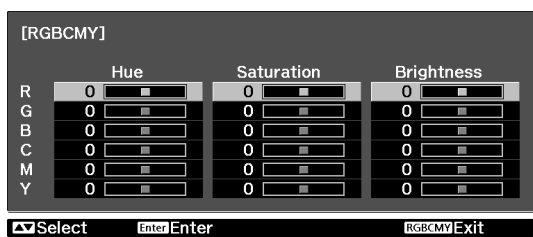

3 Use the buttons to select **Hue, Saturation, or Brightness**.

4 Use the buttons to make adjustments.

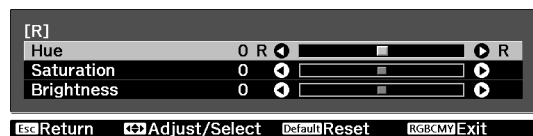

Press the button to adjust another color.

Press the button to return the adjustments to their default values.

5 Press the **RGBCMY** button to exit the menu.

Adjusting the Gamma

You can adjust slight coloration differences that may occur due to the device being used when the image is displayed.

You can use one of the following three methods selected from the configuration menu.

Setting Method	Menu Settings
Select and adjust the correction value	Image - Advanced - Gamma
Adjust while viewing the image	Image - Advanced - Gamma - Customized - Adjust it from the image
Adjust using the gamma adjustment graph	Image - Advanced - Gamma - Customized - Adjust it from the graph

■ Select and adjust the correction value

Select the adjustment value, and then press the  button to confirm the selection.

The smaller the value, the lighter the dark portions of the image become, but bright areas may appear discolored. The upper part of the gamma adjustment graph becomes rounded.

When a large value is entered, bright parts of the image become dark. The lower part of the gamma adjustment graph becomes rounded.

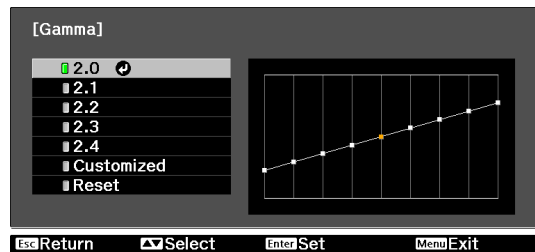

- The horizontal axis of the gamma adjustment graph shows the input signal level, and the vertical axis shows the output signal level.
- Press the  button to return the adjustments to their default values.



■ Adjust while viewing the image

Make adjustments while viewing the image being projected.

1 Move the gamma icon displayed on the image being projected to the area for which you want to adjust the brightness, and then press the  button.



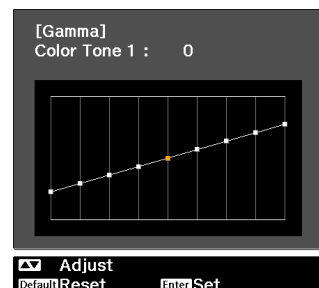

The gamma adjustment graph is displayed.

2 Use the   buttons to adjust the brightness, and then press the  button to confirm the selection.





Adjust using the gamma adjustment graph

Make adjustments while viewing the gamma adjustment graph for the image being projected.

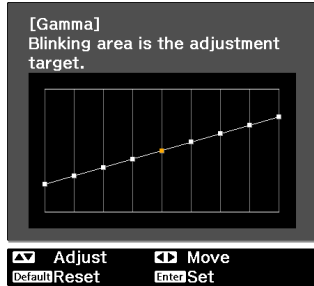
- 1 Use the   buttons to select the part you want to adjust from the graph.



- 2 Use the   buttons to adjust the brightness, and then press the  button to confirm the selection.

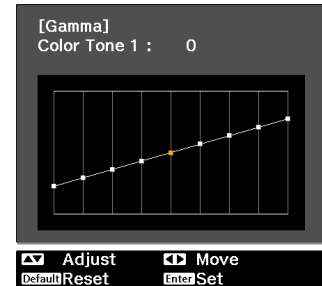





Adjusting the RGB (Offset/Gain)

For the image's brightness, you can adjust the dark areas (Offset) and the bright areas (Gain) for R (red), G (green), and B (blue). The image becomes brighter when moved to the right (positive) and darker when moved to the left (negative).

Offset	When the image is made brighter, shading for the darker sections is more vividly expressed. When the image is made darker, the image appears more full-bodied but shading for the darker sections is harder to distinguish.
Gain	When the image is made brighter, the bright sections become whiter and shading is lost. When the image is made darker, shading for the bright sections is more vividly expressed.

The menu is displayed in the following order.

Image - Advanced - RGB

Use the   buttons to select the item, and then use the   buttons to make the adjustments.

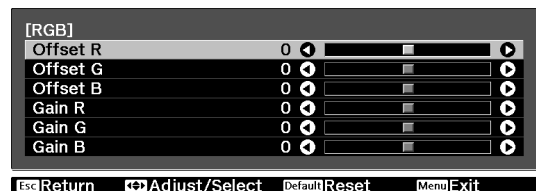



Press the  button to return the adjustments to their default values.

Abs. Color Temp.

You can adjust the overall tint of the image. Make adjustments if the image is a little too blue or too red and so on.

The menu is displayed in the following order.

Image - Abs. Color Temp.

Use the   buttons to make adjustments.

Blue tints grow stronger as the value is increased, and red tints grow stronger as the value is reduced.

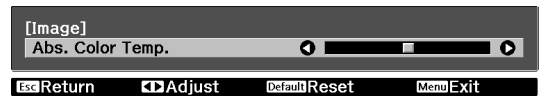



Press the  button to return the adjustments to their default values.

Skin Tone

You can adjust the skin tone. Make adjustments if the skin tone is too red or too green and so on.

The menu is displayed in the following order.

Image - Skin Tone

Use the   buttons to make adjustments.

The image becomes greener when set to the right (positive) and redder when set to the left (negative).

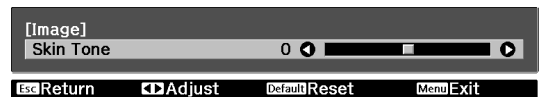

Press the  button to return the adjustments to their default values.

Detailed Image Adjustments

Adjusting the Sharpness

You can make the image clearer.

It cannot be adjusted when a computer image signal is being input.

Thin Line Enhancement	Details such as hair and patterns on clothing are enhanced.
Thick Line Enhancement	Rough parts such as outlines for entire subjects or the background are enhanced, making the overall image clearer.
Vert. Line Enhancement Horiz. Line Enhancement	Enhances the image horizontally or vertically.

1 Press the **Menu** button.

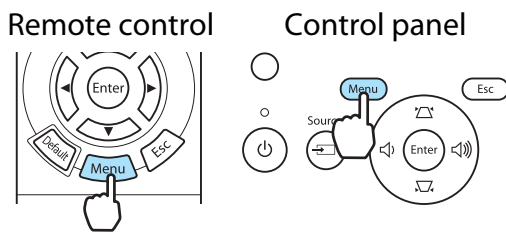

The configuration menu is displayed.

2 Select **Image - Sharpness**.

The **Sharpness** adjustment screen is displayed.

3 Select **Advanced** at the top right of the screen, and then press the **Enter** button to confirm the selection.

The **Advanced** adjustment screen is displayed.

4 Use the **Up** and **Down** buttons to select the item, and then use the **Left** and **Right** buttons to make the adjustments.

The image is enhanced when moved to the right (positive) and softer when moved to the left (negative).

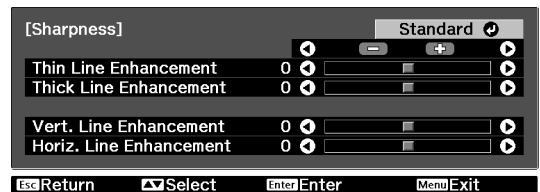

The upper bar adjusts high and low areas simultaneously.

Press the **Default** button to return the adjustments to their default values.

5 Press the **Menu** button to exit the menu.

Setting Auto Iris

By automatically setting the luminance according to the brightness of the displayed image, it lets you enjoy deep and rich images.

You can select the luminance adjustment tracking for changes in brightness in the displayed image from **Normal** to **High Speed**.

(Depending on the image, you may hear the auto iris operating, but this is not a malfunction.)

1 Press the **Auto Iris** button.

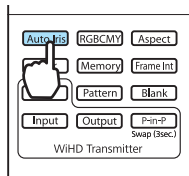

You can make settings from the configuration menu. **Image - Auto Iris** p.66

2 Use the buttons to select the item, and then press the **Enter** button to confirm the selection.

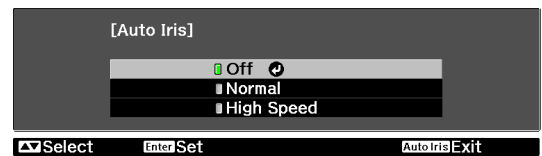

Super-resolution

This setting sharpens blurred images, enhancing the apparent detail of the image by increasing the resolution of the image signal.

Depending on the image, distortion at the edge of the image may be enhanced. If you notice any distortion, set it to "0".

1 Press the **Super-res** button.

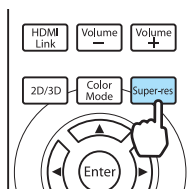

- You can make settings from the configuration menu. **Signal - Super-resolution** p.68
- This cannot be set when a computer image signal is being input.

2 Use the buttons to make adjustments.

The higher the number, the stronger the effect.



3 Press the **Super-res** button to exit the menu.

Image Processing

Improves the response speed for images projected at high-speed, such as games.

This is only available when receiving a progressive signal input from the Component, HDMI1, or HDMI2 ports, or from WirelessHD.

1 Press the  button.

Remote control

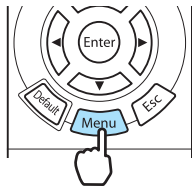

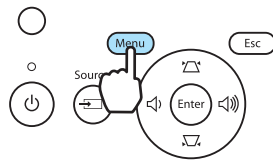

Control panel



The configuration menu is displayed.

2 Select **Signal - Advanced - Image Processing**.

3 Use the   buttons to select the item, and then press the  button to confirm the selection.



4 Press the  button to exit the menu.



- This does not support 3D images.
- If **Image Processing** is set to **Fast**, **Noise Reduction** is fixed at Off.

Viewing the Image at the Saved Image Quality (Memory Function)

Saving Function

You can save the adjustment values for some images and image quality settings in the configuration menu for later use (Save Memory).

Because these saved adjustment values can be loaded from the remote control, you can easily switch to your preferred image quality (Load Memory).

The following configuration menu functions can be saved.

Image 🖱️ p.66	Color Mode, Power Consumption, Brightness, Contrast, Color Saturation, Tint, Sharpness, Abs. Color Temp., Skin Tone, Advanced-Sharpness, Offset, Gain, Gamma, Hue, Saturation, Brightness, Auto Iris	
Signal 🖱️ p.68	Progressive, Motion Detection	
	Advanced	Noise Reduction, Setup Level, EPSON Super White, Overscan, HDMI Video Range

Saving a Memory

You can register a memory when **Color Mode** is set to anything except **Auto**.

1 Make settings that you want to save to the configuration menu.

2 Press the **Memory** button.

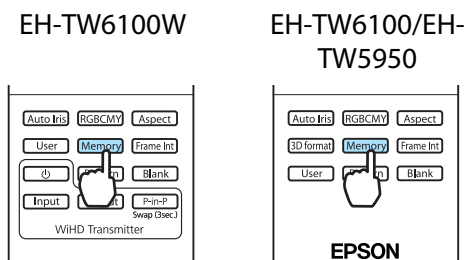

3 Use the **▲** **▼** buttons to select **Save Memory**, and then press the **Enter** button to confirm the selection.

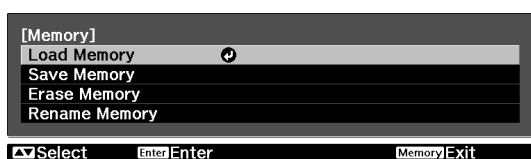

The **Save Memory** screen is displayed.

4 Use the **▲** **▼** buttons to select the memory name to be saved, and then press the **Enter** button to confirm the selection.

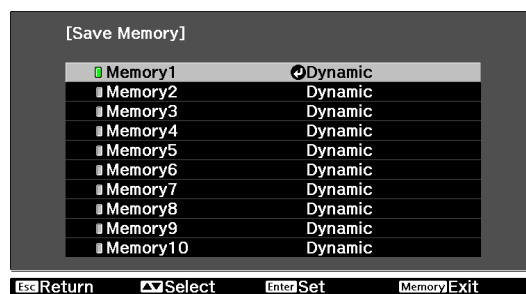

The current projector settings are saved to the memory.

When the mark to the left of the memory name turns green, saving is complete. If you select a memory name that has already been used, a message is displayed asking if you want to overwrite the data. If you select **Yes**, the previous content is erased and the current settings are saved.

Loading a Memory

1 Press the  button, and then select **Load Memory**.

The **Load Memory** screen is displayed.

2 Select the target memory name.



- The color mode saved to the memory is displayed on the right.
- Depending on the input signal, part of the loaded memory item may not be applied to the projected image.
- Memories saved for 2D images can only be loaded when projecting 2D images. Memories saved for 3D images can only be loaded when projecting 3D images.

Deleting a Saved Memory

1 Press the  button, and then select **Erase Memory**.

The **Erase Memory** screen is displayed.

2 Select the target memory name.

A confirmation message is displayed. If you select **Yes**, the content of the saved memory is erased.



If you want to erase all of the saved memories, go to **Reset - Reset Memory** on the configuration menu.  [p.75](#)

Renaming a Memory

You can rename each memory name using up to 12 characters. Giving the memory a name that is easy to remember is useful when loading the memory.

1 Press the  button, and then select **Rename Memory**.

The **Rename Memory** screen is displayed.

2 Select the target memory name.

The name list screen is displayed.





3 Select a displayed name or **Customized**.

To enter a name of your own, select **Customized**, and then go to step 4. If you select **Customized**, a keyboard is displayed.

If you select from the name list, check that the memory name has been changed.

4

Enter a name.

Use the     buttons to select a character, and then press the  button to confirm the selection. Enter up to 12 characters.

When you have finished entering the name, select **Finish**.

The memory name is changed.

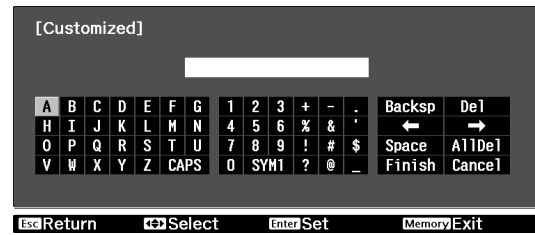



Enjoying 3D Images

Setting 3D Images

When 3D data is received from the HDMI1, HDMI2, or WirelessHD (EH-TW6100W only) source, the image is automatically projected in 3D.

The following 3D formats are supported.

- Frame Packing
- Side by Side
- Top and Bottom

1 Connect an AV device capable of playing 3D images to the projector.

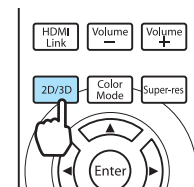

2 Turn on the AV device and the projector, and then press the  button.

If the 3D image is projected automatically, you do not need to press any buttons.









If the 3D image cannot be viewed

Check the following if the 3D effect is not displayed correctly, even after switching to 3D mode.

- Check that the 3D format for the AV device and the **3D Format** for the projector match.  **Signal - 3D Setup - 3D Format** [p.68](#)
See the manual provided with the AV device for more information on making settings for the AV device.
- The synchronization timing for the 3D Glasses may have been inversed. Inverse the synchronization using **Inverse 3D Glasses**, and then try again.  **Signal - 3D Setup - Inverse 3D Glasses** [p.68](#)
- If a 3D image is not displayed, try switching by pressing the  button.



- How a 3D image is perceived varies depending on the individual.
- The image is not displayed in 3D if **3D Display** is set to **Off**. Press the  button on the remote control.  **Signal - 3D Setup - 3D Display** [p.68](#)
- The projector automatically selects the appropriate 3D format, but if the 3D image is not displayed correctly, use **3D Format** to select another format.  **Signal - 3D Setup - 3D Format** [p.68](#)
- If the 3D effect is not displayed correctly, try reversing using **Inverse 3D Glasses**.  **Signal - 3D Setup - Inverse 3D Glasses** [p.68](#)
- When a 3D image is displayed, a warning about viewing 3D images is displayed. You can turn off this warning by setting **3D Viewing Notice** to **Off**.  **Signal - 3D Setup - 3D Viewing Notice** [p.68](#)
- You can also convert 2D images to 3D images.  [p.48](#)
- During 3D projection, the following configuration menu functions cannot be changed. Aspect (set to Normal), Noise Reduction (set to Off), Sharpness, Split Screen, Overscan (set to Off), Super-resolution
- How the 3D image is viewed may change depending on the temperature of the surroundings and how long the lamp has been used. Refrain from using the projector if the image is not projected normally.

Using 3D Glasses

Use the supplied or optional 3D Glasses (ELPGS03) to view 3D images.
Depending on the model, 3D Glasses may not be supplied.

 The 3D Glasses come with protective stickers. Remove the protective stickers before use.

■ Charging the 3D Glasses

The following charging methods are available, depending on the model of 3D Glasses being used.
If you have a WirelessHD Transmitter, you can use it to charge the glasses.
If you do not have a WirelessHD Transmitter, you can charge by using the USB Charging Adapter supplied.

Charging using the WirelessHD Transmitter

Use the USB cable to connect the 3D Glasses to the WirelessHD Transmitter.

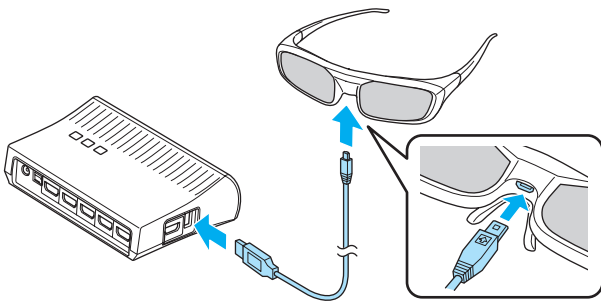

Charging using the USB Charging Adapter

Use the USB cable to connect the 3D Glasses to the USB Charging Adapter, and then connect the USB Charging Adapter to an electrical outlet.

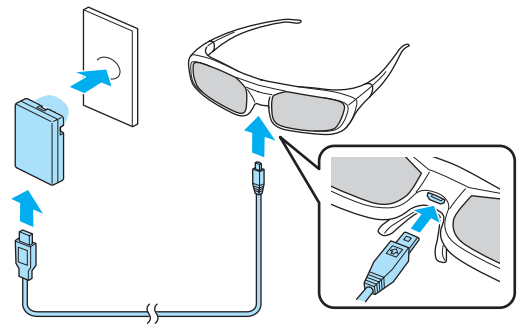

Attention

- Only connect to an electrical outlet that uses the voltage displayed on the adapter.
- Note the following points when handling the supplied microUSB cable.
 - You should not bend, twist, or pull the cable with too much force.
 - You should not modify the cable.
 - You should not perform wiring near an electric heater.
 - You should not use the cable if it is damaged.

■ Pairing 3D Glasses

To create 3D images, the 3D Glasses need to be paired with the projector.
Press the [Pairing] button on the 3D Glasses to start pairing. See the User's Guide for the 3D Glasses for more information.



- For 3D Glasses that have not been used, pairing is performed when the 3D Glasses are turned on. You do not need to perform pairing if 3D images can already be viewed correctly.
- Once pairing has been performed, you can view 3D images the next time the devices are turned on.
- You can perform pairing within a range of three meters from the projector. While pairing is being performed, make sure you stay within a range of three meters from the projector. Otherwise, pairing may not be performed correctly.
- If synchronization cannot be performed within 30 seconds, pairing is automatically canceled. When pairing is cancelled, 3D images cannot be viewed because pairing fails.

■ Wearing the 3D Glasses

1 Turn on the 3D Glasses by sliding the [Power] switch to On.

The indicator turns on for several seconds, and then turns off.

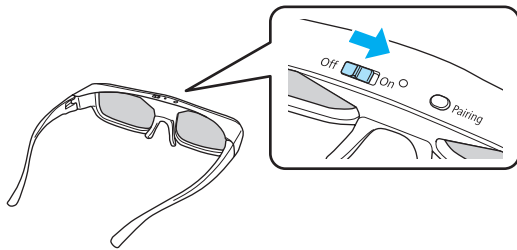

2 Put on the 3D Glasses and enjoy the show.



- When you have finished using the 3D Glasses, turn them off by sliding the [Power] switch to Off.
- If the 3D Glasses are not used for at least 30 seconds, they turn off automatically. To turn the 3D Glasses back on, slide the [Power] switch to Off, and then slide it back to On.
- You need more pairs of optional 3D Glasses if more than one person will be viewing the 3D image. [p.95](#)

Range for Viewing 3D Images

This projector allows you to view 3D images within the range shown in the figure below.

You can view 3D images within a range of 10 meters from the projector.

The distance for pairing is three meters.

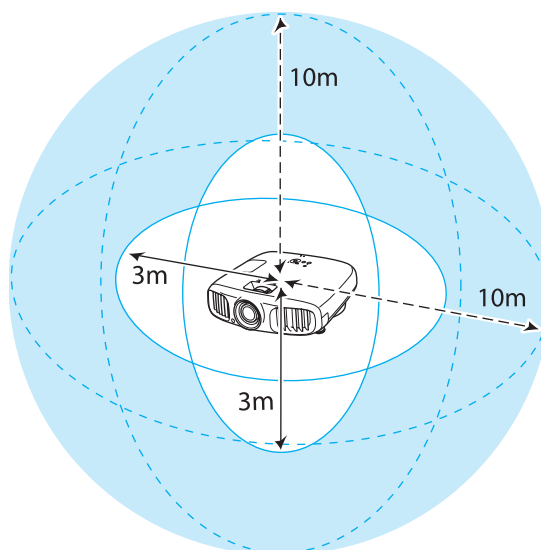



- 3D images may not be displayed correctly if there is any interference from other Bluetooth communication devices. Do not use these devices at the same time.
- The communication method for 3D Glasses uses the same frequency (2.4 GHz) as wireless LAN (IEEE802.11b/g) or microwave ovens. Therefore, if these devices are used at the same time, radio wave interference may occur, the image may be interrupted, or communication may not be possible. If you do need to use these devices at the same time, make sure there is enough distance between them and the projector.
- The 3D Glasses for this projector use the active shutter system based on the standards provided by the Full HD 3D Glasses Initiative™.

Warnings Regarding Viewing 3D Images

Note the following important points when viewing 3D images.



Warning

Disassembling or remodeling

- Do not disassemble or remodel the 3D Glasses.
This could cause a fire to occur or the images to appear abnormal when viewing, causing you to feel unwell.

Storage locations

- Do not leave the 3D Glasses or the supplied parts within reach of children.
They could be accidentally swallowed. If anything is accidentally swallowed, contact a doctor immediately.

Wireless (Bluetooth) communication

- Electromagnetic interference may cause medical equipment to malfunction. Before using the device, make sure there is no medical equipment in the vicinity.
- Electromagnetic interference may cause automatically controlled equipment to malfunction which could cause an accident. Do not use the device near automatically controlled equipment such as automatic doors or fire alarms.

Heating

- Do not place the 3D Glasses in a fire, on a heat source, or leave them unattended in a location subject to high temperatures. Because this device has a built-in rechargeable lithium battery, it could cause burns or a fire if it ignites or explodes.

Charging

- When charging, connect the supplied cable to the USB port designated by Epson. Do not charge using other devices as it may cause the battery to leak, overheat, or explode.
- Only use the supplied charging cable to charge the 3D Glasses. Otherwise, it could overheat, ignite, or explode.

 **Caution**

3D Glasses

- Do not drop or press too forcefully on the 3D Glasses.
If the glass sections and so on are broken, an injury could occur. Store the glasses in the soft glasses case supplied.
- Be careful of the edges of the frame when wearing the 3D Glasses.
If it pokes your eye and so on, an injury could occur.
- Do not place your finger in any of the moving sections (such as the hinges) of the 3D Glasses.
Otherwise an injury could occur.
- When disposing of the 3D Glasses, see the User's Guide for the 3D Glasses.

 **Caution**

Wearing 3D Glasses

- Make sure you wear the 3D Glasses correctly.
Do not wear the 3D Glasses upside down.
If the image is not displayed correctly into the right and left eyes, it could cause you to feel unwell.
- Do not wear the glasses unless you are viewing a 3D image.
- How a 3D image is perceived varies depending on the individual. Stop using the 3D function if you feel strange or cannot see in 3D.
Continuing to view the 3D images could cause you to feel unwell.
- Stop wearing the 3D Glasses immediately if they seem abnormal or a malfunction occurs.
Continuing to wear the 3D Glasses could cause an injury or cause you to feel unwell.
- Stop wearing the 3D Glasses if your ears, nose, or temples become red, painful, or itchy.
Continuing to wear the 3D Glasses could cause you to feel unwell.
- Stop wearing the 3D Glasses if your skin feels unusual when wearing the glasses.
In some very rare cases the paint or materials used in the 3D Glasses could cause an allergic reaction.

 **Caution**

Viewing Time

- When viewing 3D images, always take periodic breaks during extended viewing.
Long periods of viewing 3D images may cause eye fatigue.
The amount of time and frequency of such breaks varies from person to person. If your eyes still feel tired or uncomfortable even after taking a break from viewing, stop viewing immediately.

 **Caution**

Watching 3D Images

- If your eyes feel fatigued or uncomfortable when viewing 3D images, stop viewing immediately. Continuing to view the 3D images could cause you to feel unwell.
- When viewing 3D images be sure to always wear 3D Glasses. Do not attempt to view 3D images without 3D Glasses. Doing so could cause you to feel unwell.
- Do not place any breakable or fragile objects around you when using 3D Glasses. 3D images may cause you to move your body involuntarily, resulting in damage to nearby items or personal injury.
- Only wear 3D Glasses when viewing 3D images. Do not move around while wearing 3D Glasses. Your vision may appear darker than normal, causing you to fall or injure yourself.
- Try to stay as level with the viewing screen as possible when viewing 3D images. Viewing 3D images at an angle reduces the 3D effect and may cause you to feel unwell due to unintended color changes.
- If using 3D Glasses in a room with fluorescent or LED lighting, you may see flashing or flickering throughout the room. If this should occur, reduce the lighting until the flickering goes away or turn off the lights completely when viewing 3D images. In some very rare cases, this flickering could trigger seizures or fainting for some individuals. If you begin to feel uncomfortable or unwell at any time when viewing 3D images, stop immediately.
- Stay at least three times the height of the screen away from the screen when viewing 3D images. The recommended viewing distance for an 80-inch screen is at least 3 meters, and at least 3.6 meters for a 100-inch screen. Sitting or standing any closer than the recommended viewing distance may result in eye fatigue.

 **Caution**

Health Risks

- You should not use 3D Glasses if you are sensitive to light, have a heart condition, or are unwell. Doing so could aggravate your pre-existing conditions.

 **Caution**

Recommended Age of Use

- The minimum recommended age to view 3D images is six years old.
- Children under the age of six are still developing and viewing 3D images may cause complications. Consult your doctor if you have any concerns.
- Children viewing 3D images through 3D Glasses should always be accompanied by an adult. It is often difficult to tell when a child is feeling tired or uncomfortable, which could result in them feeling suddenly unwell. Always check with your child to ensure that they are not experiencing any eye fatigue during viewing.

Converting 2D Images to 3D and Viewing

You can convert 2D images from HDMI1, HDMI2, or WirelessHD (EH-TW6100W only).

1 Press the  button.

Remote control

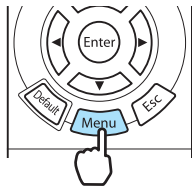

Control panel

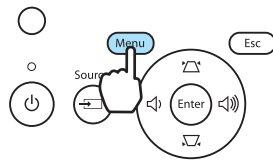



The configuration menu is displayed.

2 Select **Signal - 3D Setup**, and then press the  button to confirm the selection.

The **3D Setup** screen is displayed.

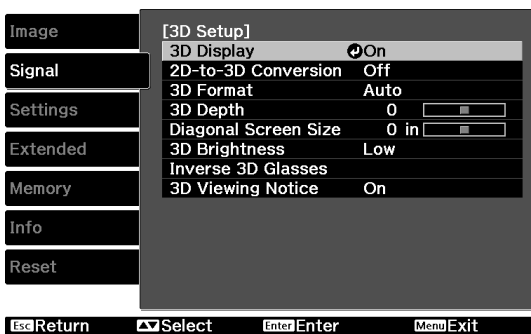
3 Select **2D-to-3D Conversion**, and then press the  button to confirm the selection.



4 Select the strength of the 3D effect, and then press the  button to confirm the selection.

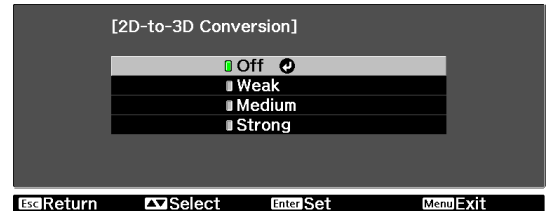

5 Press the  button.

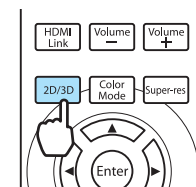

When using **2D-to-3D Conversion**, set **3D Format** to **Auto** or **2D**.  **Signal - 3D Setup - 3D Format** [p.68](#)



Connecting with WirelessHD (EH-TW6100W Only)

Installing the WirelessHD Transmitter

You can use the supplied WirelessHD Transmitter to wirelessly receive image and sound data.

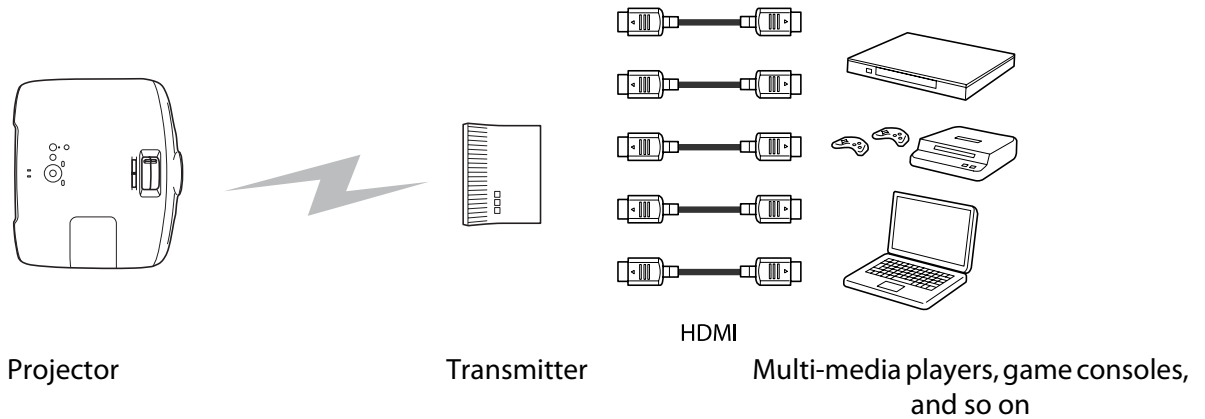

You can use the WirelessHD Transmitter in the following ways.

- You do not need to connect a cable to the projector. This is useful if you cannot set it up near the AV device.
- You can connect up to five AV devices at the same time, and switch images using the remote control.
- As well as the projector, you can connect another output device, such as a television, to the Output port, and then switch the output using the remote control.
- This allows other output devices connected to the Output port to project images from the connected AV device, even if the projector is off.

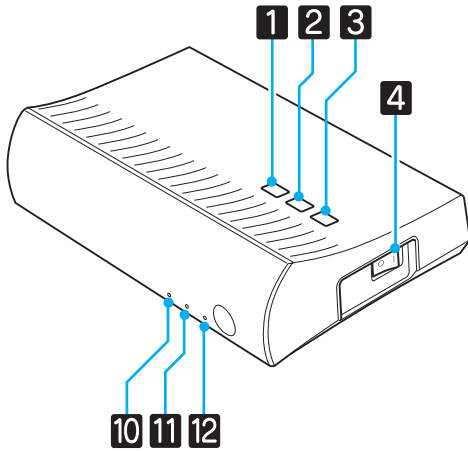

WirelessHD Transmitter part names

Front

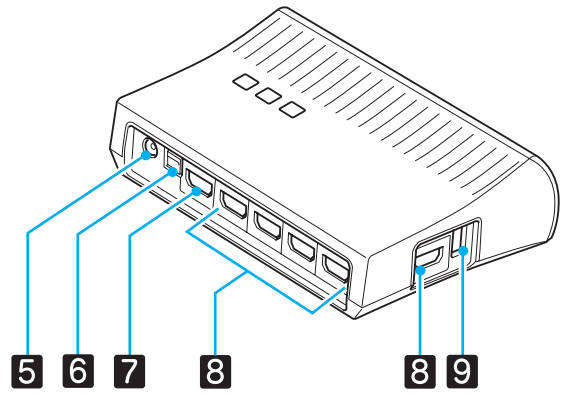

Rear



Name		Function
1	⏻ button	Turns the transmitter on or off. This performs the same function as the  button for WiHD Transmitter control on the lower section of the remote control.
2	Input button	Changes to the image from each input port. This performs the same function as the  button for WiHD Transmitter control on the lower section of the remote control.
3	Output button	Switches the output image to the Wireless or Output port. This performs the same function as the  button for WiHD Transmitter control on the lower section of the remote control.
4	Main power switch	Turns the main power for the transmitter on or off.
5	AC adapter port	Connects the AC adapter.
6	Optical Audio-Out port	Connects to audio devices equipped with an optical digital audio input port.
7	HDMI Output port	Connects to other output devices, such as televisions. You can switch the output using the Output button.
8	HDMI Input port	Connects to the AV device you want to playback. You can switch the input image using the Input button.
9	3D Glasses charging port	Connects a USB cable to charge the 3D Glasses.
10	⏻ indicator (orange/green)	Lit when the WirelessHD Transmitter is on. Lit orange when standing by, and green when operating (receiving or transmitting images).
11	WiHD indicator (orange)	Indicates the communication status for the WirelessHD. <ul style="list-style-type: none"> • Lit when wirelessly transmitting images to the projector. • Off when outputting to the Output port.
12	Link indicator (orange)	Indicates the connection status with the projector. <ul style="list-style-type: none"> • On when projecting images from the projector. • Flashes when searching for a projector. • Flashes slowly when standing by in power saving status.



- The receiver is located within the intake vent of the projector and therefore cannot receive any signals directly from the rear. Set up so that the front of the projector is facing the WirelessHD Transmitter. Also, make sure that the air intake vent on the left-hand side of the projector is not covered.
- Place the WirelessHD Transmitter on a level surface facing towards the projector.
- You can view the signal strength from the **WirelessHD** settings menu. **Settings - WirelessHD - Reception** [p.71](#)

■ Setting the WirelessHD Transmitter

1

Set up the WirelessHD Transmitter connected to the projector so that they are facing each other. [p.54](#)

2

Connect the WirelessHD Transmitter to an electrical outlet using the supplied AC adapter.

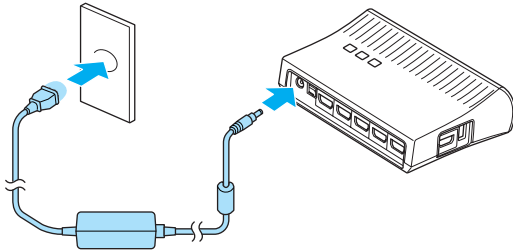

3

Using an HDMI cable, connect the AV device you want to use to the Input port on the WirelessHD Transmitter. You can connect up to five multi-media players.

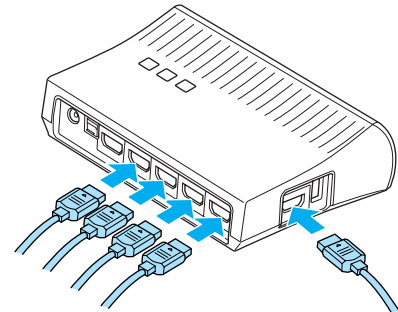

You can connect another output device, such as a television, to the Output port on the WirelessHD Transmitter. You can switch between output images using the remote control. [p.55](#)

Projecting Images

1 Start playback on the AV device, and then turn on the projector and the WirelessHD Transmitter.

The  indicator on the WirelessHD Transmitter turns on.

2 Check the status of the WiHD indicator on the WirelessHD Transmitter.

If the WiHD indicator is on, go to the next step.

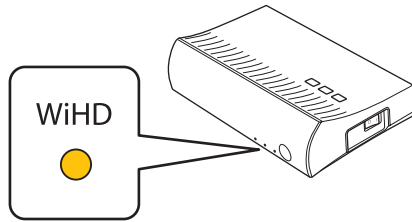

If the indicator is off, press the  button on the remote control or the WirelessHD Transmitter.

Make sure you point the remote control at the WirelessHD Transmitter when using the  button on the remote control.

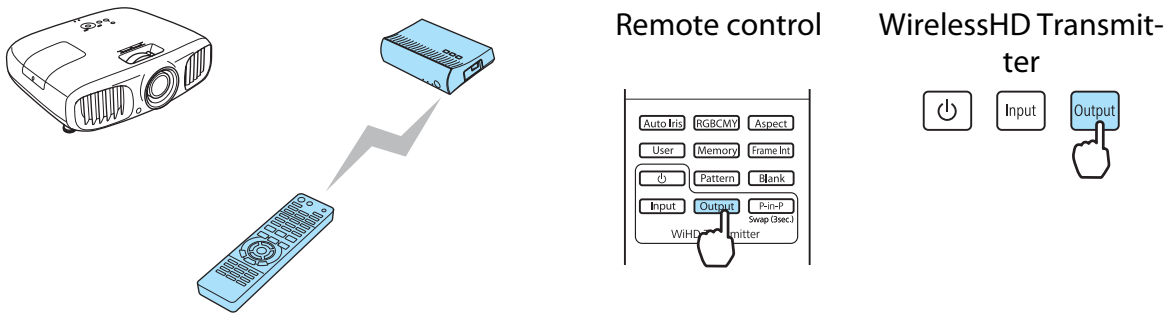

3 Check the status of the Link indicator on the WirelessHD Transmitter.

If the WirelessHD Transmitter is connected to the projector, the Link indicator flashes and then remains on.

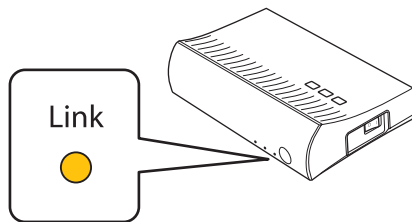

 If the indicator continues to flash slowly, the WirelessHD Transmitter cannot connect to the projector and has entered standby status. Make sure the projector has been setup correctly, such as turning on the power and so on.

4 If projection does not start, press the **WirelessHD** button on the remote control to change the source.

Make sure you point the remote control at the projector when using the **WirelessHD** button on the remote control.

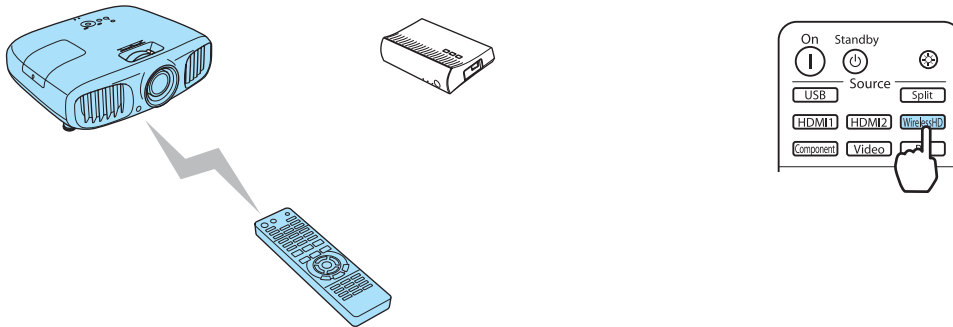

Projection starts.

5 When connecting two or more AV devices to the WirelessHD Transmitter, press the **Input** button to switch images. [p.57](#)



- When receiving WirelessHD images, make sure **WirelessHD** is set to **On** from the configuration menu.
- **Settings - WirelessHD** [p.71](#)
- Make sure you turn off the WirelessHD Transmitter if it is not going to be used for an extended period.

WirelessHD Settings Menu

1 Press the **Menu** button.
The configuration menu is displayed.

2 Select **Settings - WirelessHD**.
The **WirelessHD** settings screen is displayed.

3 Make settings for each of the displayed functions.

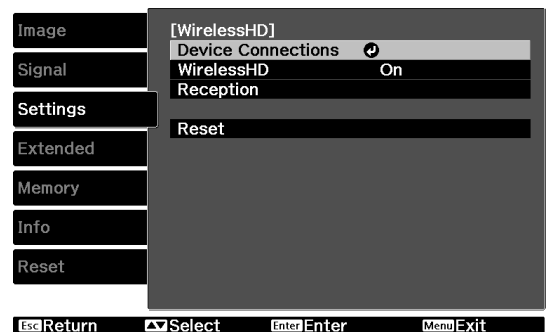

Available functions on the **WirelessHD** settings menu

Function	Explanation
Device Connections	Displays a list of available WirelessHD devices that can be connected. The device names and MAC addresses (device numbers) are displayed in the list. The MAC address is displayed on the label on the base.
WirelessHD	Enables or disables the WirelessHD function.
Reception	Displays the reception.
Reset	You can reset all adjustment values for the WirelessHD settings menu to their default settings.

WirelessHD Transmission Range

The following shows the communication transmission range for the WirelessHD. Make sure you set up the WirelessHD Transmitter so that it faces the projector.

Horizontal direction

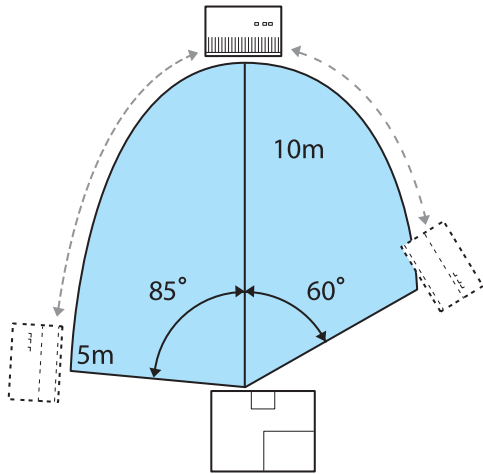

Vertical direction (placed on a table and so on)

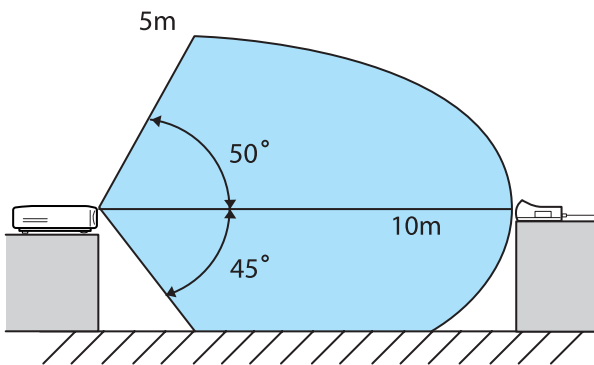

Vertical direction (suspended from a ceiling)

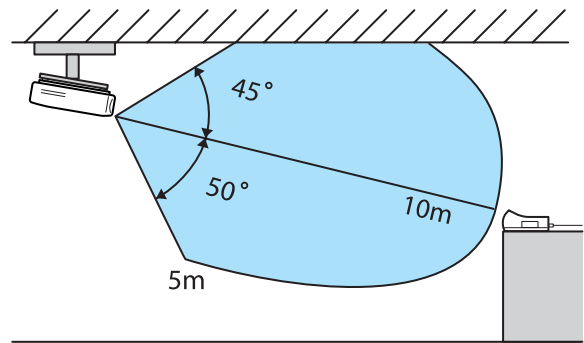

- The wireless transmission range varies depending on the placement and material of the surrounding furniture and walls. The values given here are for your reference only.
- The projector cannot communicate through walls.
- Place the WirelessHD Transmitter on a wooden shelf or other location that does not block the signal from being transmitted from the front of the device. Note that placing the transmitter on a metal shelf may cause signal instability.
- The antennas are built-into the front of the projector and the WirelessHD Transmitter. Make sure the antennas face each other (face the front) when setting up the devices.
- Place the projector and the WirelessHD Transmitter close to each other, and make sure there are no other projectors operating in the vicinity.
- Depending on the reception strength, the image's color information may be automatically discarded to avoid any interruptions and maintain a constant connection. To avoid any deterioration in image quality, adjust the position of the WirelessHD Transmitter so that the **Reception** is as strong as possible.

Useful Functions of the WirelessHD Transmitter

With the WirelessHD Transmitter, you can connect and switch between five multi-media players (input devices to be played back) and one output device (an output device displaying an image, such as a television).

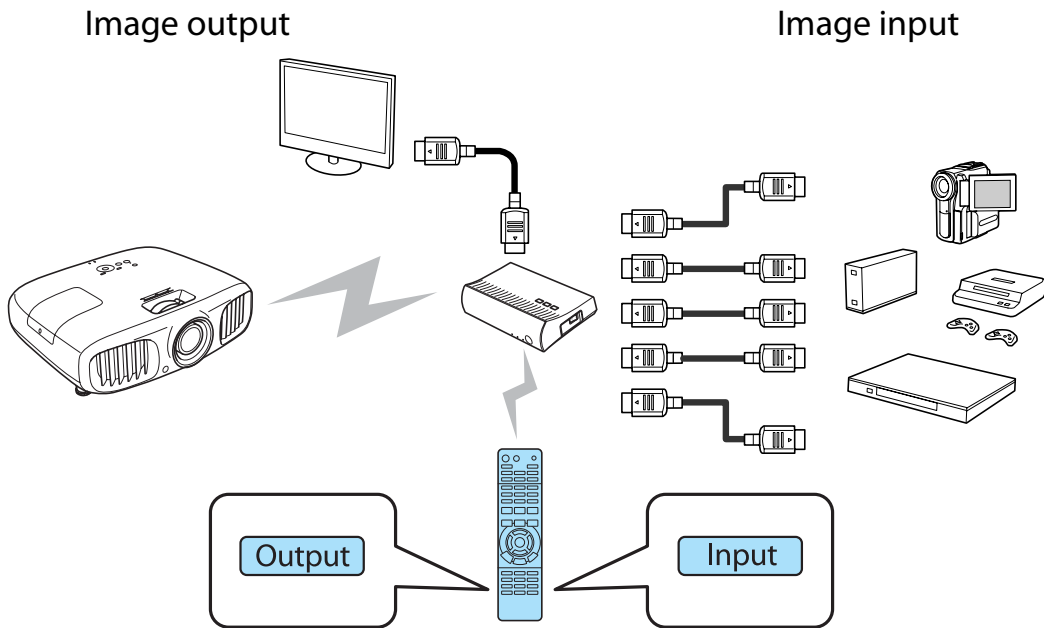

 Make sure you point the remote control at the WirelessHD Transmitter when performing operations using the **Input** button (switch input) and the **Output** button (switch output) on the remote control.

■ Switching the target image

You can switch the output image between devices, such as televisions, connected to the Output port on the WirelessHD Transmitter and the projector.

- 1** Turn on the projector or the television.
- 2** Turn on the WirelessHD Transmitter.
The ϕ indicator on the WirelessHD Transmitter turns on.

3 Point the remote control at the WirelessHD Transmitter, and then press the **Output** button.

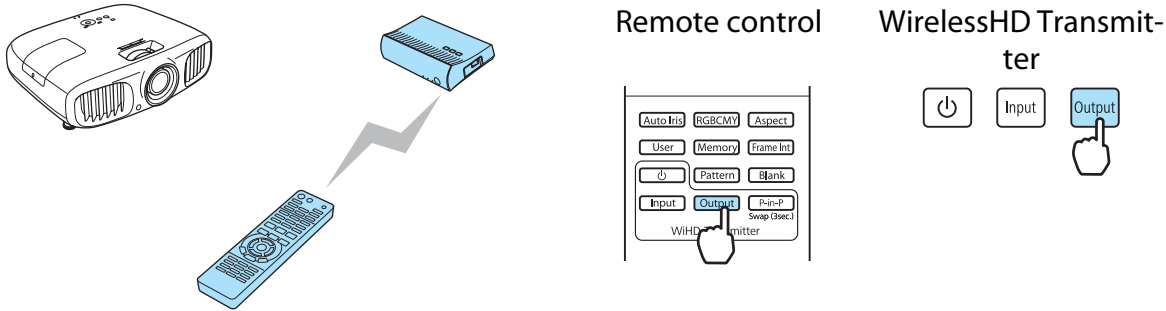

Depending on the output target, the WiHD indicator on the WirelessHD Transmitter indicates the following status.

On: The image is being output to the projector.

Off: The image is being output to another output device.

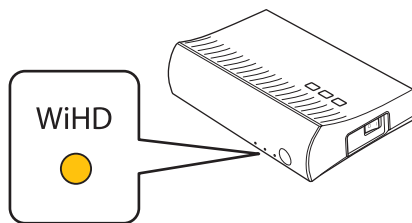

The output target projected last time is projected the next time the projector is turned on.



You can switch to the other output device even when the projector is off.

Switching the image source

You can switch the image source for the AV device connected to the WirelessHD Transmitter. When switching, each input source is displayed on one screen as a preview. This allows you to switch easily between image sources even when two or more devices are connected using HDMI.

The projector uses Insta Prevue Technology from Silicon Image, Inc.

Switching the source

- 1 Point the remote control at the WirelessHD Transmitter, and then press the **Input** button.

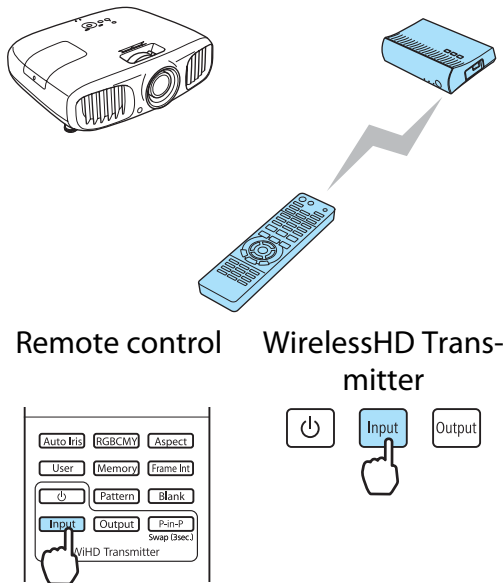

Displays the sub-screen for the connected device.

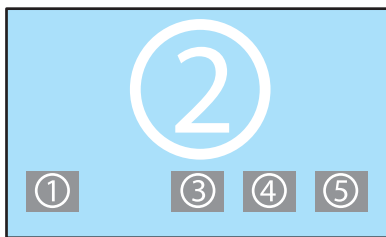

- 2 The target screen changes each time you press the **Input** button.

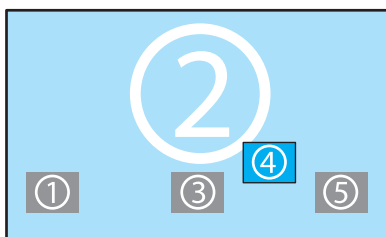

- 3 After selecting the target screen, please wait for a moment. The projected image is switched.

Displaying as a sub-screen

- 1 Point the remote control at the WirelessHD Transmitter, and then press the **P-in-P** button.

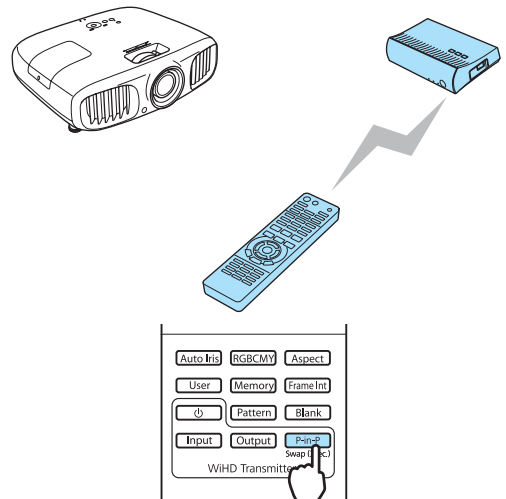

Displays the sub-screen for the connected device.

- 2 When switching between the sub-screen and the main screen, hold down the **P-in-P** button (for approximately 3 seconds) until the screen changes.

- 3 To close the sub-screen, press the **P-in-P** button again. The projected image is switched.



- When the sub-screen is displayed, press the **Input** button to switch the image for the sub-screen.
- When the sub-screen is displayed, press the **Output** button to change the position and size (large/small) of the sub-screen. Each time the **Output** button is pressed, the display position moves from bottom right, top right, top left, and bottom left allowing you to change the size.

■ Remote control operating range

The following shows the operating range between the remote control and the WirelessHD Transmitter.

Operating range (left to right)

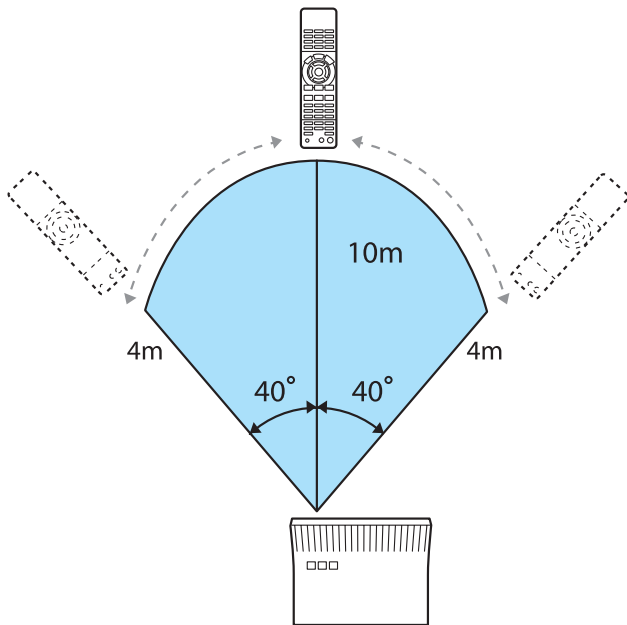

Operating range (top to bottom)

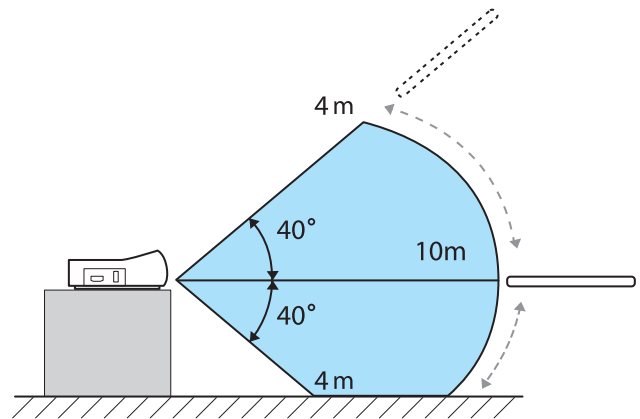

Using the HDMI Link Function

HDMI Link Function

When an AV device that meets the HDMI CEC standards is connected to the projector's HDMI port, you can perform linked operations such as linked power on and volume adjustment for the AV system from one remote control. Also, when projecting images in WirelessHD, you can use the HDMI link function (EH-TW6100W only).

- As long as the AV device meets the HDMI CEC standards, you can use the HDMI link function even if the AV system in-between does not meet the HDMI CEC standards.
- Up to 3 multi-media players that meet the HDMI CEC standards can be connected at the same time.

Connection Example

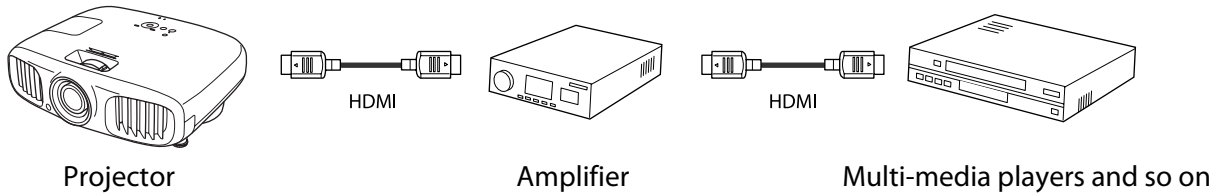

HDMI Link Settings

By pressing the  button on the remote control, and setting **HDMI Link** to **On**, you can operate the following functions.

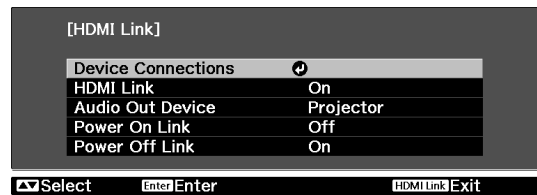

Function	Explanation
Power On Link	Powers on the projector when content is played back on the connected device. Or, powers on the connected device when the projector is turned on.
Power Off Link	Powers off the connected device when the projector is turned off. <ul style="list-style-type: none"> This only works when the connected device's CEC power link function is enabled. Note that depending on the status of the connected device (for example, if it is recording), the device may not power off.
Audio Out Device	When an AV system is connected, you can set whether to output audio from the projector's speaker, or from the AV system's speaker.
Input Change Link	Changes the input source of the projector to HDMI when content is played back on the connected device.
Connected Devices Operations	You can perform operations such as Play, Stop, Fast Forward, Rewind, Next Chapter, Previous Chapter, and Pause from the remote control for the projector.

- To use the HDMI Link function, you must configure the connected device. See the documentation supplied with the connected device for more information.
- Even when using the WirelessHD Transmitter with **Power On Link** set to **Device -> PJ** or **Bidirectional**, if **WirelessHD** is set to **On**, this projector also turns on when the AV device connected to the WirelessHD Transmitter is turned on (EH-TW6100W only). **Settings-HDMI Link-Power On Link p.71**

Device Connections

You can check the connected devices that are available for HDMI Link, and select on the device you want to project the image from. Devices that can be controlled by HDMI link automatically become the selected device.

- 1** Press the  button, and then select **Device Connections**.

The **Device Connections** list is displayed.

Devices that have a green icon to their left are linked.

If the device name cannot be determined this field is left blank.

- 2** Select the device you want to operate using the HDMI Link function.

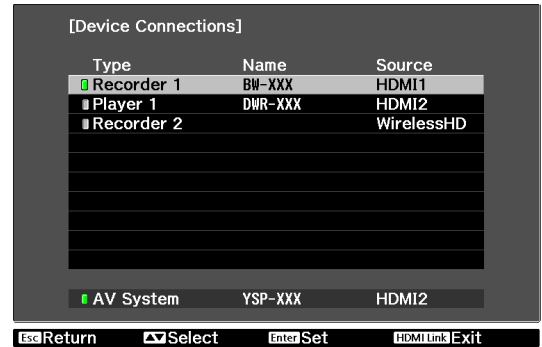

- If the cable does not meet the HDMI standards, operations are not possible.
- Some connected devices or functions of those devices may not operate properly even if they meet the HDMI CEC standards. See the documentation and so on supplied with the connected device for more information.

Changing Between Two Types of Images

Types of Screen that can be Displayed Simultaneously

You can project two different images at once, one on the left and one on the right. You can project these images at the same size, or make one larger or smaller than the other to view a sub image while you are watching the larger main image.

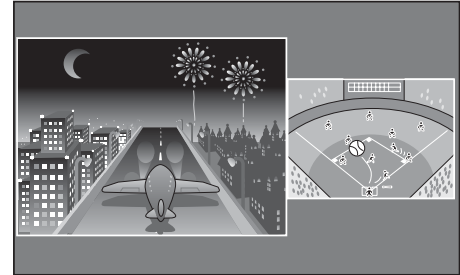

Combinations of input sources for Split Screen projection

	HDMI1	HDMI2	WirelessHD*	Component	Video	PC
HDMI1	-	-	-	✓	✓	✓
HDMI2	-	-	-	✓	✓	✓
WirelessHD*	-	-	-	✓	✓	✓
Component	✓	✓	✓	-	✓	-
Video	✓	✓	✓	✓	-	✓
PC	✓	✓	✓	-	✓	-

* EH-TW6100W only

Projecting on a Split Screen

Starting split screen display

Press the **Split** button on the remote control while the projector is projecting.

The input image is displayed as a split screen.

The image which was being displayed is projected on the left, and the image specified in **Source** from the **Split Screen Setup** menu is projected on the right. If the source being input is not supported, nothing is displayed.

Press the **Split** button again to exit split screen.

EH-TW6100W

EH-TW6100/EH-TW5950

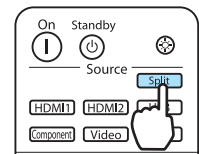
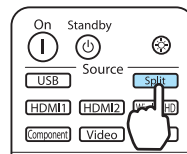



- You cannot use split screen display when the source is USB.
- You cannot use split screen display to project 3D images.

■ Changing the split screen settings

You can change the source and the display size used for split screen display from the **Split Screen Setup** menu.

- 1** Press the  button during split screen projection.
The **Split Screen Setup** menu is displayed.

 Press the  button during split screen projection to immediately display the **Split Screen Setup** menu.

- 2** Make settings for each of the displayed functions.

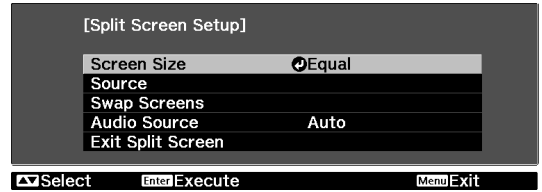

Available functions on the **Split Screen Setup** menu

Function	Explanation
Screen Size	Changes the left and right screen size using Equal , Larger Left , and Larger Right .
Source	Selects which source is displayed on the left and right.
Swap Screens	Changes the left and right screens.
Audio Source	Selects which screen's audio to output from the projector's built-in speaker. When set to Auto , the audio from the image with the largest screen size is output. If the screen sizes are the same, audio is output from the screen on the left.
Exit Split Screen	Exits split screen display.

Playing Back Image Data (Slideshow)

Compatible Data

The following types of files stored on USB storage devices such as USB memories, digital cameras, and so on that are connected to the projector's USB port can be displayed as a slideshow.

Slideshow compatible file types

File Type (Extension)	Notes
.jpg	<ul style="list-style-type: none"> • Images using CMYK color mode are not compatible. • Progressive format images are not compatible. • Images with a resolution greater than 8192 x 8192 are not compatible. • Due to the characteristics of JPEG files, images may not be projected clearly if the compression ratio is too high.

Playing a Slideshow

1

Connect a USB storage device.

Files are displayed as thumbnails.



To open a folder, select the folder, and then press the  button.

If multiple drives are displayed, select the drive you want, and then press the  button.



If thumbnails of the files are not displayed, press the  button on the remote control to change the source.





2

Select **Slideshow**.

Use the     buttons to select **Slideshow** at the bottom right of the screen, and then press the  button.







Slideshow starts.



- To close the Slideshow, disconnect the USB storage device.
- Select an image from the thumbnails and press the  button to enlarge the selected image. Press the   buttons on the remote control when viewing an enlarged image to change between images. You can also rotate the image using the   buttons.

Display Settings for Image Files and Slideshow Operation Settings





You can set the file display order and slideshow operations on the option screen.

1 Use the     buttons to position the cursor over the folder where you want to set display conditions, and then press the  button. Select **Option** from the submenu displayed, and then press the  button.

2 When the option screen is displayed, set each of the items.

Enable settings by positioning the cursor on the target item and pressing the  button. The following table shows the details for each item.

Display Order	You can select to display the files in Name Order or Date Order .
Sort Order	You can select to sort the files In Ascending or In Descending order.
Continuous Play	You can set whether to repeat the slideshow.
Screen Switching Time	When playing a slideshow, you can set the time for a single file to be displayed. You can set a time between Off (0) to 60 seconds. When you set Off , auto play is disabled.
Effect	You can set the screen effects when changing slides.

3 When you have finished making settings, use the     buttons to position the cursor over **OK**, and then press the  button.

The settings are applied.

If you do not want to apply the settings, position the cursor on **Cancel**, and then press the  button.

Configuration Menu Functions

Configuration Menu Operations

On the configuration menu, you can make adjustments and settings for Signal, Image, Input Signal, and so on.

1 Press the **Menu** button.

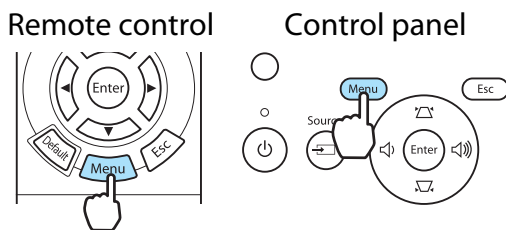

The configuration menu is displayed.

2 Use the **Up** and **Down** buttons to select the top menu on the left, and then press the **Enter** button to confirm the selection.

When you select the top menu on the left, the sub menu on the right changes.

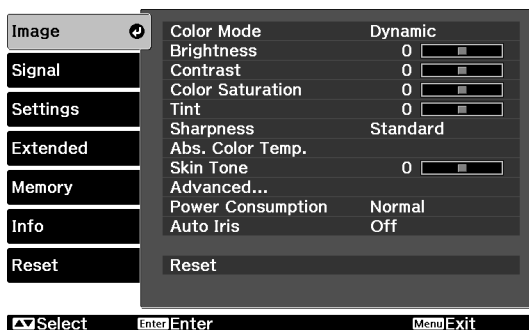

The line at the bottom is a guide for operations.

3 Use the **Up** and **Down** buttons to select the sub menu on the right, and then press the **Enter** button to confirm the selection.

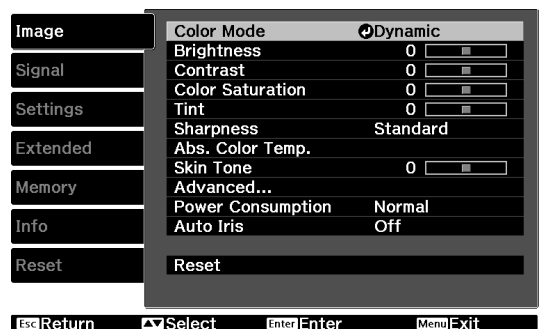

The adjustment screen for the selected function is displayed.

4 Use the **Left**, **Right**, **Up**, and **Down** buttons to adjust the settings.

Ex.) Adjustment bar

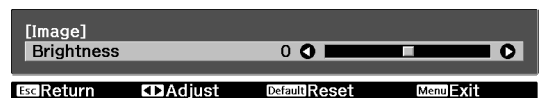

Ex.) Choices

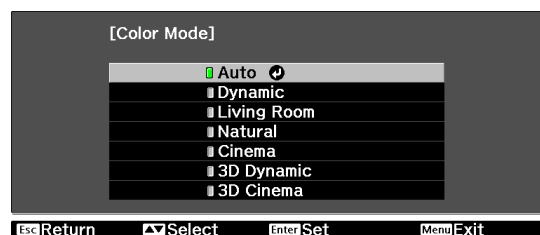

Press the **Enter** button on an item displaying this **Checkmark** icon to change to the selection screen for that item.

Press the **Esc** button to return to the previous level.

5 Press the **Menu** button to exit the menu.



















For items adjusted using an adjustment bar, such as the brightness level, you can press the  button while the adjustment screen is displayed to return the adjustment value to its default value.

Configuration Menu Table

If there is no image signal being input, you cannot adjust items related to the image or signal in the configuration menu. Note that the items displayed for the image, the signal, and other information vary depending on the image signal being projected.

Image menu

Function	Menu/Settings		Explanation
Color Mode	Auto, Dynamic, Living Room, Natural, Cinema, 3D Cinema, 3D Dynamic		Select a color mode based on your surroundings and the image you are projecting.  p.29
Brightness			Adjusts the brightness when the image appears too dark.
Contrast			Adjusts the contrast between light and shade in the images. By increasing the contrast, the images become vivid.
Color Saturation* ¹			Adjusts the color saturation for the images.
Tint* ¹			Adjusts the tint for the images.
Sharpness	Standard		Adjusts the image sharpness. Adjusts the overall image.
	Advanced* ¹	Thin Line Enhancement, Thick Line Enhancement, Vert. Line Enhancement, Horiz. Line Enhancement	 Adjusts the image sharpness. Use this to adjust specific areas.  p.36
Abs. Color Temp.	5000K to 10000K (12 increments)		Adjusts the tint for the images. The image is tinted blue for high values, and tinted red for low values.
Skin Tone			Adjusts the skin tone. The image becomes greener when set to a positive value and redder when set to a negative value.

Function	Menu/Settings		Explanation	
Advanced	Gamma	2.0, 2.1, 2.2, 2.3, 2.4	Performs gamma adjustments. You can select a raw value or adjust the gamma while looking at the image or graph.  p.33	
		Customized		Adjust it from the image, Adjust it from the graph
		Reset		
	RGB	Offset R/G/B		Adjusts the offset and gain for each R, G, and B color.  p.34
		Gain R/G/B		
RGBCMY	R/G/B/C/M/Y	Hue, Saturation, Brightness 	Adjusts the hue, saturation, and brightness for each R, G, B, C, M, and Y color.  p.32	
EPSON Super White*2 *3		On, Off	(This can only be set when the Color Mode is set to Auto, Natural, Cinema, or 3D Cinema and when receiving signal input from the HDMI1 or HDMI2 ports, or from WirelessHD.) Set this to On if you are experiencing bright over exposure of whites in your image. When set to On, HDMI Video Range settings are disabled.	
Power Consumption	Normal, ECO		You can set the lamp brightness to one of two settings. Select ECO if the images being projected are too bright. When ECO is selected, power consumption during projection decreases, and fan rotation noise is reduced.	
Auto Iris	Off, Normal, High Speed		You can change the luminance adjustment tracking for changes in brightness in the displayed image. Set to Off for no luminance adjustment.  p.37	
Reset	Yes, No		You can reset all adjustment values for Image to their default settings.	







*1 This is not displayed when a computer image signal is being input.

*2 Settings are saved for each type of input source or signal.

*3 This is only displayed when a Component, HDMI1, HDMI2, or WirelessHD image signal is being input. (WirelessHD is for EH-TW6100W only.)

■ Signal menu

No sub menu items are displayed for the signal menu for **USB** signal input.

Function	Menu/Settings		Explanation
3D Setup* ⁶	3D Display	On, Off	Enables or disables the 3D Display function.  p.42
	2D-to-3D Conversion	Off, Weak, Medium, Strong	Sets the strength of the 3D effect when converting 2D to 3D images.  p.48
	3D Format	Auto, Side by Side, Top and Bottom, 2D	Sets the 3D format for the input signal. If set to Auto , the format is recognized automatically.
	3D Depth	-10 - 10	Sets the depth for the 3D image.
	Diagonal Screen Size	60 - 300	Sets the projection size for the 3D image. By matching this to the actual size, you can achieve the optimum 3D effect.
	3D Brightness	Low, Medium, High	Sets the brightness for the 3D image.
	Inverse 3D Glasses	Yes, No	Reverses the synchronization timing for the left/right shutters on the 3D Glasses and the left/right images. Enable this function if the 3D effect is not displayed correctly.
	3D Viewing Notice	On, Off	Turns the notice that appears when viewing 3D content on or off.
Aspect* ²	Auto, Normal, Full, Zoom, Wide		Selects the aspect mode.  p.30
Zoom Size* ²			(Available when Aspect or Zoom are set.) Any parts at the top or bottom that cannot be seen when Zoom is set are squeezed vertically to fit on the screen. The higher you set this value the more the image is squeezed vertically.
Zoom Caption Pos.* ²			(Available when Aspect or Zoom are set.) If subtitles are not completely visible when viewing images with subtitles at the bottom, you can adjust the position of the image up or down until the subtitles become visible.
Tracking* ² * ³	Varies depending on the input signal.		Adjusts computer images when vertical stripes appear in the images.
Sync.* ² * ³	0 - 31		Adjusts computer images when flickering, fuzziness, or interference appear in the images. <ul style="list-style-type: none"> • Adjusting the Brightness, Contrast, or Sharpness may cause flickering or blurriness. • Adjusting the synchronization after adjusting tracking allows for more accurate adjustments.
Position* ² * ⁴			Adjusts the display position up, down, left, and right when a part of the image is missing so that the whole image is projected.

Function	Menu/Settings	Explanation
Progressive* ²	Off, Video, Film/Auto* ¹ * ⁵	<p>(This can only be set when receiving signal input from the Video port or when receiving 480i, 576i, or 1080i signal input from the Component, HDMI1, or HDMI2 ports or from WirelessHD.) Converts the signal from interlaced (i) to progressive (p) using a method appropriate for the image signal.</p> <ul style="list-style-type: none"> • Off: No signal conversion is performed. • Video: This is ideal for viewing general video images. • Film/Auto: Performs the optimal conversion for film, CG, or animation input signals.
Motion Detection* ² * ⁵	1 - 5	Sets the image motion speed from 1 (slow, for still images) to 5 (fast, for movies). Change this setting if you are experiencing poor still image quality or flickering movies.
Auto Setup* ³	On, Off	Sets whether or not to automatically adjust the image whenever the input signal is changed. When enabled, the tracking, display position, and synchronization are automatically configured.
Super-resolution	0 - 5	Reduces blurring that occurs at the edge of images when the resolution is increased. 🗨️ p.37

Function	Menu/Settings		Explanation
Advanced	Noise Reduction ^{*2 *5}	Off, 1, 2, 3	Smooths out rough images. There are three modes available. Select your favorite setting. It is recommended that this is set to Off when viewing image sources in which noise is very low, such as for DVDs.
	Setup Level ^{*2 *5}	0%, 7.5%	(This can be set when receiving an NTSC or component video signal from the Video port.) Change this setting when using devices with a different black level (Setup Level) such as products designed for the Korean market. Check the specifications for your connected device before changing this setting.
	Overscan ^{*2 *6}	Auto, Off, 2%, 4%, 6%, 8%	Changes the output image ratio (the range of the projected image). <ul style="list-style-type: none"> • Off, 2 to 8%: Sets the range of the image. Off projects all ranges. Depending on the image signal you may notice noise at the top and bottom of the image. • Auto: This can only be set when receiving signal input from the HDMI1 or HDMI2 ports, or from WirelessHD. This may be automatically set to Off or 8% depending on the input signal.
	HDMI Video Range ^{*1 *2}	Auto, Normal, Expanded	(This can only be set when EPSON Super White is set to Off .) When set to Auto , the video level for the DVD input signal to the HDMI1 or HDMI2 ports, or to the WirelessHD is automatically detected and set. If you experience under or overexposure when set to Auto , set the video level of the projector to match that of the DVD player's video level. Your DVD player may be set to Normal or Expand. The Auto option is not displayed when connected to a connected device's DVI port.
	Image Processing	Fine, Fast	Performs processing to improve the image.  p.38
Reset	Yes, No		Resets all Signal settings except for Aspect to their default settings.

*1 This is not displayed when a Video image signal is being input.

*2 Settings are saved for each type of input source or signal.





*3 This is only displayed when a PC image signal is being input.







*4 This cannot be set when an HDMI1, HDMI2, or WirelessHD image signal is being input.



*5 This is not displayed when a PC image signal is being input.

*6 This is only displayed when a Component, HDMI1, HDMI2, or WirelessHD image signal is being input. (WirelessHD is for EH-TW6100W only.)

Settings menu



Function	Menu/Settings			Explanation
Keystone	H/V-Keystone	V-Keystone	-60 - 60	Performs vertical keystone correction.  p.27
		H-Keystone	-60 - 60	Performs horizontal keystone correction.  p.27
	Auto V-Keystone	On, Off		Enables or disables Auto V-Keystone .  p.26
	H-Keystone Adjuster	On, Off		Enables or disables H-Keystone Adjuster .  p.26
Audio	Volume	Volume	0 - 40	Adjusts the volume.
	Inverse Audio	On, Off		Sets whether or not to invert the left and right audio output channels. Set to On when the projector is suspended from a ceiling and is using the internal speakers.
HDMI Link	Device Connections	-		Displays a list of devices connected from the HDMI1 or HDMI2 ports, or from WirelessHD*.
	HDMI Link	On, Off		Enables or disables the HDMI Link function.
	Audio Out Device	Projector, AV System		When an AV system is connected, you can set whether to output audio from the projector's speaker, or from the AV system's speaker.
	Power On Link	Off, Bidirectional, Device -> PJ, PJ -> Device		Sets the link function when the power is turned on. Set to power on the projector when content is played on a connected device (Bidirectional or Device -> PJ) or to power on a connected device when the projector is turned on (Bidirectional or PJ -> Device).
	Power Off Link	On, Off		Sets whether or not to power off connected devices when the projector is turned off.

Function	Menu/Settings		Explanation
WirelessHD*	Device Connections	-	Displays a list of available WirelessHD devices that can be connected.
	WirelessHD	On, Off	Enables or disables the WirelessHD function.
	Reception	55% 	Displays the reception.
	Reset	Yes, No	Resets WirelessHD settings to their default settings. Note that even if you reset the projector, the WirelessHD Transmitter settings are not reset. See the documentation supplied with your WirelessHD Transmitter for details on how to reset the WirelessHD Transmitter.
Lock Setting	Child Lock	On, Off	This locks the  button on the projector's control panel to prevent children from turning on the projector by accident. You can turn on the power when locked by holding down the  button for approximately three seconds. You can still turn off the device using the  button, or perform operations with the remote control as usual. If changed, this setting is enabled after you power off the projector and the cool-down process is complete. Note that even if Child Lock is set to On , the projector still turns on when the power cable is connected if Direct Power On is set to On .
	Control Panel Lock	On, Off	When set to On , all buttons on the control panel except for the  button are disabled.  is displayed on the screen if any buttons are pressed. To unlock, press and hold the  button on the control panel for at least 7 seconds. If changed, this setting is enabled once you close the configuration menu.

Function	Menu/Settings	Explanation
Projection	Front, Front/Ceiling, Rear, Rear/Ceiling	Change this setting depending on how the projector is installed. <ul style="list-style-type: none"> • Front: Select if you are projecting in front of the screen. • Front/Ceiling: Select if you are projecting in front of the screen suspended from the ceiling. • Rear: Select if you are projecting to a rear screen from the back. • Rear/Ceiling: Select if you are projecting to a rear screen from the back when the projector is suspended from the ceiling.
User Button	2D-to-3D Conversion, 3D Format, 3D Depth, 3D Brightness, Inverse 3D Glasses, Brightness Control, About	Select a configuration menu item to assign to the  button on the remote control. By pressing the  button, the assigned menu item selection/adjustment screen is displayed, allowing you to make one-touch settings/adjustments.
Split Screen	-	Starts split screen display.  p.61
Reset	Yes, No	Resets all Settings to their default settings.





* Only EH-TW6100W is displayed.

 Extended menu

Function	Menu/Settings		Explanation
Operation	Direct Power On	On, Off	You can set up the projector so that projection starts as soon as the power cable is plugged in without any button operations. Note that when this is set to On , projection starts if power is restored after a blackout or other power outage and the power cable is still plugged into the projector.
	Sleep Mode	Off, 5min., 10min., 30min.	If the set time is exceeded and no signal is input, the projector is automatically turned off and enters standby mode. When set to Off , the projector never enters sleep mode. When in standby mode, press the  button on the remote control or the  button on the control panel to start projection.
	Illumination	On, Off	Set this to Off if the light from the indicators on the control panel bother you when watching a movie in a dark room.
	High Altitude Mode	On, Off	Set this to On if you are using the projector above an altitude of 1500 meters.

Function	Menu/Settings		Explanation
Display	Menu Position	-	Sets the position where the menu should be displayed.
	Menu Color	Color 1, Color 2	Selects the color for the top menu. <ul style="list-style-type: none"> • Color 1: Black • Color 2: Blue
	Messages	On, Off	Sets whether or not to display the following messages (On or Off). <ul style="list-style-type: none"> • Item names for image signals, color modes, aspect ratios, and loading memory. • If the internal temperature is rising when no image signal is being input or an unsupported signal is detected.
	Display Background	Black, Blue, Logo	Selects the screen status when no image signal is being input.
	Startup Screen	On, Off	Sets whether or not to show a startup screen when projection begins (On or Off). If changed, this setting is enabled after you power off the projector and the cool-down process is complete.
	Standby Confirmation	On, Off	Sets whether or not to display a standby confirmation message (On or Off).  p.23
Input Signal	Video Signal	Auto, NTSC, NTSC4.43, PAL, M-PAL, N-PAL, PAL60, SECAM	Sets the signal type depending on the video device connected to the Video port. When set to Auto , the video signal is set automatically. If you notice noise in the image even when set to Auto , or if you are not seeing any image at all, select the correct signal type from the available options.
	Component	Auto, YCbCr, YPbPr	Sets the output signal for the video device connected to the Component port. When set to Auto , the output signal is set automatically. If you notice unnatural colors when set to Auto , set the appropriate output signal from the available options.
Language	-		Selects the display language.
Reset	Yes, No		Resets all adjustment values for Extended to their default settings.

 Memory menu

Function	Explanation
Load Memory	Loads settings saved using the Save Memory function.  p.40 This cannot be selected if you have not saved any settings with the Save Memory function.
Save Memory	Saves certain Image and Signal settings to memory.  p.39
Erase Memory	Erases settings saved to memory that you no longer need.  p.40
Rename Memory	Renames a saved memory.  p.40

☐ Info menu





Function	Explanation
Lamp Hours	Displays the cumulative lamp operating time.
Source	Displays the source name for the connected equipment currently being projected.
Input Signal	Displays the content of Input Signal set in the Signal menu according to the source.
Resolution	Displays the resolution.
Scan Mode	Displays the scan mode.
Refresh Rate	Displays the refresh rate.
3D Format	Displays the 3D format of the signal input during 3D projection (Frame Packing, Side by Side, or Top and Bottom).
Sync Info	Displays the image signal information. This information may be needed if service is required.
Deep Color	Displays deep color.
Video Signal	Displays the settings for Video Signal in the Signal menu.
Status	This is information about errors that have occurred on the projector. This information may be needed if service is required.
Serial Number	Displays the projector's serial number.

☐ Reset menu

Function	Explanation
Reset All	Resets all items in the configuration menu to their default settings. The following items are not reset to their defaults: Input Signal, Save Memory, Lamp Hours, Language, User Button.
Reset Memory	Erases all settings saved using the Save Memory function.
Reset Lamp Hours	Resets the cumulative lamp hours use time to 0 H . Reset when you replace the lamp.

■ Split Screen menu





Displayed by pressing the  button during split screen projection.

Function	Menu/Settings		Explanation	
Split Screen	Screen Size	Equal, Larger Left, Larger Right		Changes the left and right screen sizes.  p.62
	Source	Left, Right	PC Video Component HDMI1/HDMI2 WirelessHD*	Selects which source is displayed on the left and right.  p.62
	Swap Screens			Changes the left and right screens.  p.62
	Audio Source	Auto, Screen Left, Screen Right		Selects which screen's audio to output from the projector's built-in speaker.  p.62
	Exit Split Screen			Exits split screen display.  p.62

* Only EH-TW6100W is displayed.

Problem Solving

Reading the Indicators



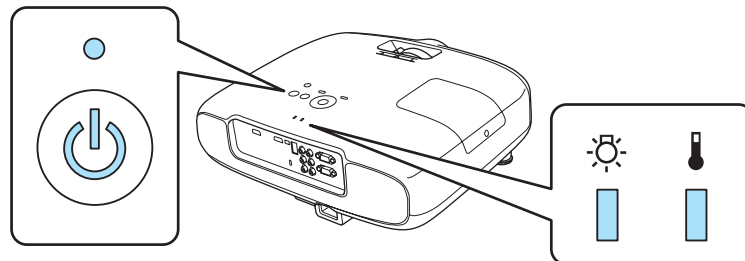





You can check the status of the projector from the flashing and lit ,  (operation indicators),  and  on the control panel.

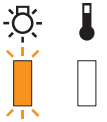

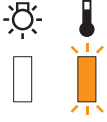

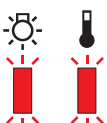

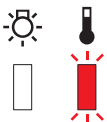

Refer to the following table to check the projector's status and how to remedy problems shown by the indicators.

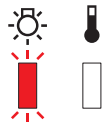

Indicator status during an error/warning

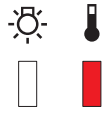





 : Lit  : Flashing  : Off

Indicators	Status	Remedy
  (orange)	Replace Lamp	It is time to replace your lamp. Replace the lamp with a new lamp as soon as possible. p.92 The lamp may explode if you continue to use it in this status.
  (orange)	High Temp Warning	You can continue projecting. If the temperature rises too high again, projection stops automatically. <ul style="list-style-type: none"> • If the projector is installed next to a wall, make sure there is at least 20 cm between the wall and the projector's exhaust vent. • If the air filter is clogged, clean it. p.88
  (red)	Internal Error	The projector has malfunctioned. Remove the power plug from the electrical outlet, and contact your local dealer or the nearest Epson repair center. Epson Projector Contact List
  (red)	Fan Error Sensor Error	

Indicators	Status	Remedy
 (red)	Lamp Error Lamp Failure	There is a problem with the lamp, or it failed to turn on. <ul style="list-style-type: none"> • Disconnect the power cable, and then check if the lamp is cracked.  p.92 If it is not cracked, reinstall the lamp and turn on the power. If reinstalling the lamp does not fix the problem, or if the lamp is cracked, remove the power plug from the electrical outlet, and contact your local dealer or the nearest Epson repair center.  Epson Projector Contact List • If the air filter is clogged, clean it.  p.88 • When using at an altitude of 1500 m or more, set High Altitude Mode to On.  Extended - Operation - High Altitude Mode p.73
 (red)	High Temp Error (Overheating)	The internal temperature is too high. <ul style="list-style-type: none"> • The lamp turns off automatically and projection stops. Wait for about five minutes. When the fan has stopped, disconnect the power cable. • If the projector is installed next to a wall, make sure there is at least 20 cm between the wall and the projector's exhaust vent. • If the air filter is clogged, clean it.  p.88 • If turning the power back on does not clear the problem, stop using the projector and remove the power plug from the electrical outlet. Contact your local dealer or the nearest Epson repair center.  Epson Projector Contact List



■ Indicator status during normal operation

 ● : Lit  : Flashing ○ : Off

Indicators	Status	Remedy
 (blue)	Standby condition	When you press the  button on the remote control, or the  button on the control panel, projection starts after a short wait.
 (blue)	Warm-up in progress	Warm-up time is about 30 seconds. The power-off operation is disabled while the projector is warming-up.
 (blue)	Cool-down in progress	All operations are disabled while the projector is cooling-down. The projector enters standby condition when cool-down is complete. If for any reason the power cable is disconnected during cool-down, wait until the lamp has cooled down sufficiently (about 10 minutes), reconnect the power cable, and then press the  button on the remote control, or the  button on the control panel.

Indicators	Status	Remedy
 (blue)	Projection in progress	The projector is operating normally.



- Under normal operating conditions, the  and  indicators are off.
 - When the **Illumination** function is set to **Off**, all indicators are off under normal projection conditions.
-  **Extended - Operation - Illumination** [p.73](#)

When the Indicators Provide No Help

■ Check the problem

Check the following table to see if your problem is mentioned, and go to the appropriate page for information on handling the problem.







	Problem	Page
Problems relating to images	No images appear.	p.80
	Projection does not start, the projection area is completely black, or the projection area is completely blue.	
	Moving images being projected from a computer are not projected.	p.80
	" Not supported " is displayed.	p.81
	" No Signal " is displayed.	p.81
	Images are fuzzy or out of focus.	p.81
	Interference or distortion appears in the images.	p.82
	The image is truncated (large) or small, or only a part of the image is projected.	p.82
	Image colors are not right.	p.83
	The whole image appears purplish or greenish, images are black & white, or colors appear dull.*	
Images appear dark.	p.83	
Projection stops automatically.	p.83	
Problems when projection starts	The projector does not turn on.	p.84
Problems with the remote control	The remote control does not respond.	p.84
Problems with 3D	Cannot project correctly in 3D.	p.85
Problems with HDMI	HDMI Link does not function.	p.85
	The device name is not displayed under device connections.	p.86
Problems with WirelessHD	Cannot project WirelessHD images.	p.86
	WirelessHD audio is not output correctly.	p.86
	Interference or distortion appear in WirelessHD images.	p.87

Problem		Page
Problems with USB storage devices	Slideshow does not start	p.87
Other problems	No audio, or the audio is too low.	p.87

* Because color reproduction differs between monitors and computer LCD screens, the image projected by the projector and the color tones displayed on the monitor may not match, however this is not a fault.

■ Problems relating to images

No images appear

Check	Remedy
Is the projector turned on?	Press the  button on the remote control or the  button on the control panel.
Is the power cable connected?	Connect the power cable.
Are the indicators switched off?	Disconnect and then reconnect the projector's power cable. Check that power is being supplied.
Is an image signal being input?	Check that the connected device is turned on. When Messages is set to On from the configuration menu, image signal messages are displayed.  Extended - Display - Messages p.73
Is the image signal format setting correct?	When Video is input If nothing is projected even when Video Signal is set to Auto from the configuration menu, set the signal that matches the connected device.  Extended - Input Signal - Video Signal p.73
	When Component is input If nothing is projected even when Component is set to Auto from the configuration menu, set the signal that matches the connected device.  Extended - Input Signal - Component p.73
Are the configuration menu settings correct?	Reset all of the settings.  Reset - Reset All p.75
(Only when projecting computer image signals) Was the connection made while the power of the projector or the computer was already turned on?	If the connection is made while the power is already turned on, the key (Function key and so on) that changes the computer's image signal to external output may not work. Turn off the power for the computer and the projector and then turn it back on again.

Moving images are not displayed

Check	Remedy
(Only when projecting computer image signals) Is the computer's image signal set to external output and to output to the LCD monitor at the same time?	Depending on the computer's specifications, moving images may not be displayed when the computer is set to external output and to the LCD monitor output at the same time. Change it so that the image signal is set to external output only. For the computer's specifications, see the documentation supplied with the computer.

"Not supported" is displayed

Check	Remedy
Is the image signal format setting correct?	<p>When Video is input If nothing is projected even when Video Signal is set to Auto from the configuration menu, set the signal that matches the connected device. 🖱️ Extended - Input Signal - Video Signal p.73</p> <p>When Component is input If nothing is projected even when Component is set to Auto from the configuration menu, set the signal that matches the connected device. 🖱️ Extended - Input Signal - Component p.73</p>
<p>(Only when projecting computer image signals)</p> <p>Do the image signal's frequency and resolution correspond to the mode?</p>	<p>Check the image signal being input in Resolution from the configuration menu, and check that it corresponds to the projector's resolution. 🖱️ p.96</p>

"No Signal" is displayed

Check	Remedy
Are the cables connected correctly?	Check that all the cables required for projection are securely connected. 🖱️ p.18
Is the correct image input port selected?	Change the image with the source buttons on the remote control, or the  button on the control panel. 🖱️ p.23
Is the connected device turned on?	Turn on the device.
<p>(Only when projecting computer image signals)</p> <p>Are the image signals being output to the projector?</p>	<p>Change it so that the image signal is set to external output, and not just the computer's LCD monitor. For some models, when the image signals are output externally, they no longer appear on the LCD monitor. For the computer's specifications, see the documentation supplied with the computer.</p> <p>If the connection is made while the power of the projector or the computer is already turned on, the Fn key (Function key) that changes the computer's image signal to external output may not work. Turn the power for the computer and the projector off and then back on again.</p>

Images are fuzzy or out of focus

Check	Remedy
Has the focus been adjusted?	Adjust the focus. 🖱️ p.25
Is the lens cover attached?	Remove the lens cover.
Is the projector at the correct distance?	Check the recommended projection range. 🖱️ p.17

Check	Remedy
Has condensation formed on the lens?	If the projector is suddenly taken from a cold environment to a warm environment, or if sudden ambient temperature changes occur, condensation may form on the surface of the lens, and this may cause the images to appear fuzzy. Set the projector up in the room about one hour before it is used. If the projector is wet from condensation, turn off the projector, disconnect the power cable, and leave it for a while.

Interference or distortion appear in images

Check	Remedy
Is the image signal format setting correct?	When Video is input If nothing is projected even when Video Signal is set to Auto from the configuration menu, set the signal that matches the connected device. 🖱️ Extended - Input Signal - Video Signal p.73
	When Component is input If nothing is projected even when Component is set to Auto from the configuration menu, set the signal that matches the connected device. 🖱️ Extended - Input Signal - Component p.73
Are the cables connected correctly?	Check that all the cables required for projection are securely connected. 🖱️ p.18
Is an extension cable being used?	If an extension cable is used, electrical interference may affect the signals.
(Only when projecting computer image signals) Are the Sync. and Tracking settings adjusted correctly?	The projector uses automatic adjustment functions to project at the optimum status. However, depending on the signal, some may not be adjusted correctly even after performing self corrections. If this happens, adjust the Tracking and Sync. settings from the configuration menu. 🖱️ Signal - Tracking/Sync. p.68
(Only when projecting computer image signals) Is the correct resolution selected?	Set the computer so that the signals being output are compatible with the projector. 🖱️ p.96

Part of the image is truncated (large) or small

Check	Remedy
Is the correct Aspect selected?	Press the <input type="button" value="Aspect"/> button, and then select the Aspect that matches the input signal. 🖱️ Signal - Aspect p.68 When subtitled images are being projected during Zoom , adjust the Zoom Caption Pos. setting from the configuration menu. 🖱️ Signal - Zoom Caption Pos. p.68
Is the image Position adjusted correctly?	Adjust the Position setting from the configuration menu. 🖱️ Signal - Position p.68
(Only when projecting computer image signals) Is the correct resolution selected?	Set the computer so that the signals being output are compatible with the projector. 🖱️ p.96

Image colors are not right

Check	Remedy
Is the image signal format setting correct?	<p>When Video is input If nothing is projected even when Video Signal is set to Auto from the configuration menu, set the signal that matches the connected device. 🖱 Extended - Input Signal - Video Signal p.73</p> <p>When Component is input If nothing is projected even when Component is set to Auto from the configuration menu, set the signal that matches the connected device. 🖱 Extended - Input Signal - Component p.73</p>
Are the cables connected correctly?	<p>Check that all the cables required for projection are securely connected. 🖱 p.18</p> <p>For the Video and Component ports, make sure the connector is the same color as the cable port. 🖱 p.18</p>
Is the contrast adjusted correctly?	Adjust the Contrast setting from the configuration menu. 🖱 Image - Contrast p.66
Is the color adjusted correctly?	Adjust the Advanced setting from the configuration menu. 🖱 Image - Advanced p.66
(Only when projecting images from a video device) Are the color saturation and tint adjusted correctly?	Adjust the Color Saturation and Tint settings from the configuration menu. 🖱 p.66

Images appear dark







Check	Remedy
Is the image brightness set correctly?	Adjust the Brightness setting from the configuration menu. 🖱 Image - Brightness p.66
Is the contrast adjusted correctly?	Adjust the Contrast setting from the configuration menu. 🖱 Image - Contrast p.66
Is it time to replace the lamp?	When the lamp is nearly ready for replacement, the images become darker and the color quality becomes poorer. When this happens, replace the lamp with a new lamp. 🖱 p.92

Projection stops automatically

Check	Remedy
Is Sleep Mode enabled?	If no image signal is being input and no operations are made for approximately 30 minutes, the lamp turns off automatically, and the projector enters standby status. The projector returns from standby status when you press the ⏻ button on the remote control or the ⏻ button on the control panel. If you do not want to use Sleep Mode , change the setting to Off . 🖱 Extended - Operation - Sleep Mode p.73





■ Problems when projection starts

The projector does not turn on

Check	Remedy
Is the power turned on?	Press the  button on the remote control or the  button on the control panel.
Is Child Lock set to On ?	When Child Lock is set to On from the configuration menu, hold down the  button on the control panel for approximately three seconds, or perform operations from the remote control.  Settings - Lock Setting - Child Lock p.71
Is Control Panel Lock set to On ?	If Control Panel Lock is set to On from the configuration menu, all of the control panel buttons except for  button are disabled. Perform operations from the remote control.  Settings - Lock Setting - Control Panel Lock p.71
Are the indicators switched off?	Disconnect and then reconnect the projector's power cable. Check that power is being supplied.
Do the indicators turn on and off when the power cable is touched?	Turn off the projector, and then disconnect and reconnect the projector's power cable. If the problem continues, stop using the projector, remove the power plug from the electrical outlet, and contact your local dealer or the nearest projector information center.  Epson Projector Contact List





■ Problems with the remote control

The remote control does not respond

Check	Remedy
Is the remote control light-emitting area pointing towards the remote receiver on the projector during operation?	Point the remote control towards the remote receiver. Also, check the operating range.  p.21
Is the remote control too far from the projector?	Check the operating range.  p.21
Is direct sunlight or strong light from fluorescent lamps shining onto the remote receiver?	Set the projector up in a location where strong light does not shine onto the remote receiver.
Are the batteries dead or have the batteries been inserted correctly?	Make sure the batteries are inserted correctly or replace the batteries with new ones if necessary.  p.21
Is the remote control pointed at the WirelessHD Transmitter when operating the WiHD Transmitter control button? (EH-TW6100W only)	Make sure you point the remote control at the WirelessHD Transmitter when using the WiHD Transmitter control button on the remote control.  p.55



■ Problems with 3D

Cannot project correctly in 3D

Check	Remedy
Are the 3D Glasses turned on?	Turn on the 3D Glasses.
Is a 3D image being projected?	If the projector is projecting a 2D image, or if an error occurs on the projector that prevents the 3D image from being projected, you cannot view 3D images even if you are wearing the 3D Glasses.
Is the input image in 3D?	Check that the input image is 3D compatible.
Is 3D Display set to Off ?	If 3D Display is set to Off from the configuration menu, the projector does not automatically change to 3D even when a 3D image is input. Press the  button.  Signal - 3D Setup - 3D Display p.68
Is the correct 3D format set?	The projector automatically selects the appropriate 3D format, but if the 3D image is not displayed correctly, use 3D Format from the configuration menu to select another format.  Signal - 3D Setup - 3D Format p.68
Are you viewing within the reception range?	Check the range within which the 3D Glasses can communicate with the projector, and view within that range.  p.44
Has pairing been performed correctly?	See the User's Guide for the 3D Glasses to perform pairing.
Are there any devices that cause radio wave interference in the vicinity?	When using other devices at the same time with the frequency band (2.4 GHz) such as Bluetooth communication devices, wireless LAN (IEEE802.11b/g), or microwave ovens, radio wave interference may occur, the image may be interrupted, or communication may not be possible. Do not use the projector near these devices.

■ Problems with HDMI

HDMI link does not function

Check	Remedy
Are you using a cable that meets the HDMI standards?	Operations are not possible with cables that do not meet the HDMI standards.
Does the connected device meet the HDMI CEC standards?	If the connected device does not meet the HDMI CEC standards, it cannot be operated even if it is connected to the HDMI port. See the documentation and so on supplied with the connected device for more information. Also, press the  button, and then check if the device is available under Device Connections .  p.59
Are the cables connected correctly?	Check that all the cables required to use HDMI Link are securely connected.  p.59
Is the power for the amplifier or DVD recorder and so on turned on?	Put each device in standby status. See the documentation and so on supplied with the connected device for more information. If you have connected a speaker and so on, set the connected equipment to PCM output.



Check	Remedy
Was a new device connected, or was the connection changed?	If the CEC function for a connected device needs to be set again, for example when a new device is connected or the connection is changed, you may need to restart the device.
Are many multi-media players connected?	Up to 3 multi-media players that meet the HDMI CEC standards can be connected at the same time.

The device name is not displayed under Device Connections

Check	Remedy
Does the connected device meet the HDMI CEC standards?	If the connected device does not meet the HDMI CEC standards, it is not displayed. See the documentation and so on supplied with the connected device for more information.

▣ Problems with WirelessHD (EH-TW6100W only)

Cannot project WirelessHD images





Check	Remedy
Does the cable connecting the supplied WirelessHD Transmitter meet the HDMI standards?	If the cable does not meet the HDMI standards, operations are not possible.
Is WirelessHD set to Off ?	When WirelessHD is set to Off from the configuration menu, projection is not possible for WirelessHD input signals. Set WirelessHD to On , and then press the  button. Settings - WirelessHD p.71
Are signals being received within the WirelessHD transmission range?	Check the range within which the WirelessHD's transceiver can communicate, and view within that range.  p.54
Is the supplied WirelessHD Transmitter turned on?	Check the power lamp on the WirelessHD Transmitter. If there is no power being supplied, make sure the connector for the AC adapter is securely connected, and then turn on the power switch.
Is the Link indicator for the supplied WirelessHD Transmitter off?	No AV device is connected. Check that the HDMI cable is securely connected.
Are the indicators of the supplied WirelessHD Transmitter flashing alternately?	A temperature warning has occurred. Operations are stopped if there is not enough ventilation, such as when the device is placed on an audio rack, or if it is being used in a room with a high ambient temperature. Wait until it has cooled down, and then try again.
Are the projector and the WirelessHD Transmitter facing the correct way?	Setup the projector and the WirelessHD Transmitter so that they are facing each other.

WirelessHD audio is not output correctly

Check	Remedy
Is audio output when the WirelessHD is connected?	Set the connected equipment to PCM output.

Check	Remedy
Is surround sound being output?	When audio is output from the projector's speakers, it is also output from the projector's Optical Audio-Out port in 2ch stereo. When you want to use surround sound, we recommend connecting directly to the source device using an HDMI cable.

Interference or distortion appear in WirelessHD images

Check	Remedy
Are signals being received within the WirelessHD transmission range?	Check the range within which the WirelessHD's transceiver can communicate, and view within that range.  p.54
Are there any obstructions between the WirelessHD Transmitter and the projector?	Because WirelessHD communicates using a tight beamed electromagnetic wave, if there are any people or objects and so on obstructing the communication path, this could have an adverse affect on the image. Make sure that there are no obstacles between the WirelessHD Transmitter and the projector within the WirelessHD transmission range.  p.54
Is the reception too low?	<p>If the transmissions are not strong enough, communication may be unstable.</p> <p>Check Reception as you set up the transmitter as it is sometimes possible to improve the strength of the transmission by moving the WirelessHD Transmitter or changing its direction.  Settings - WirelessHD - Reception p.71</p> <p>Transmission strength may differ depending on the surroundings, or they may be unstable. While checking Reception, setup the transmitter in a location where the number displayed remains steady.  Settings - WirelessHD - Reception p.71</p>

 Problems with USB storage devices

Slideshow does not start

Check	Remedy
Is the USB storage device using a security function?	You may not be able to use USB storage devices that incorporate security functions.

 Other problems

No audio, or the audio is too low

Check	Remedy
Is the audio cable connected correctly?	Try disconnecting the cable from the Audio (L-R) port, and then reconnecting.
Is the volume too low?	Adjust the volume so that you can hear the audio.  p.28
Is it connected with an HDMI cable?	If no audio is output when connecting via an HDMI cable, set the connected equipment to PCM output.



Maintenance

Cleaning the Parts

You should clean the projector if it becomes dirty or if the quality of projected images starts to deteriorate.

Warning

Do not use sprays that contain flammable gas to remove dirt and dust from the projector's lens, air filter, and so on. The projector may catch fire due to the high internal temperature of the lamp.

Cleaning the air filter

Clean the air filter if dust has accumulated on the air filter or when the following message is displayed. **"The projector is overheating. Make sure nothing is blocking the air vent, and clean or replace the air filter."**

Attention

- If dust collects on the air filter, it can cause the internal temperature of the projector to rise, and this can lead to problems with operation and shorten the optical engine's service life. It is recommended that you clean the air filter at least once every three months. Clean them more often than this if using the projector in a particularly dusty environment.
- Do not rinse the air filter in water. Do not use detergents or solvents.
- Lightly brush the air filter to clean it. If it is brushed too strongly, dust will be ground into the air filter and cannot be removed.

1 Press the  button on the remote control or the control panel to turn off the power, and then disconnect the power cable.

2 Remove the air filter cover. Hook your finger into the tab on the air filter cover, and pull it straight out.

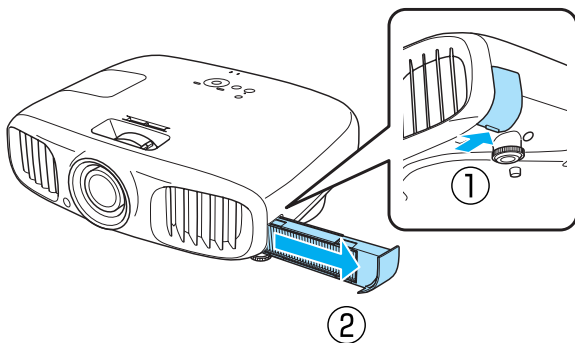

3 Remove the air filter. Place your finger in the groove and remove the air filter.

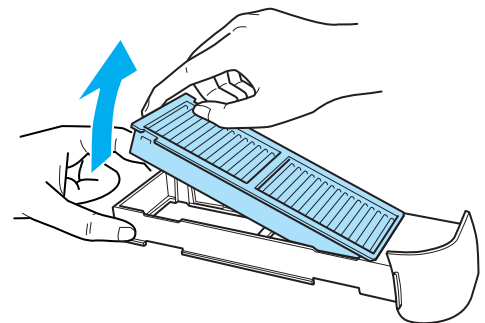

- 4** Hold the air filter with the surface facing down and tap it 4 or 5 times to remove the dust.

Turn it over and tap the other side in the same way.

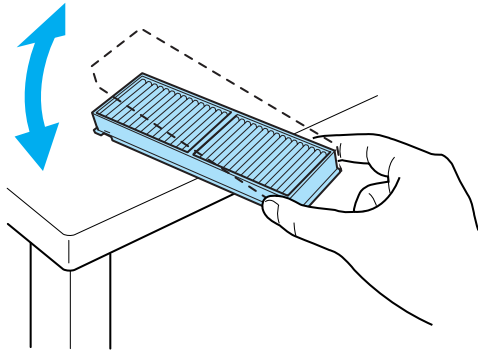

Attention

If the air filter is hit too hard, it may become unusable due to deformities and cracks.

- 5** Remove any dust remaining on the air filter by using a vacuum cleaner from the front side.

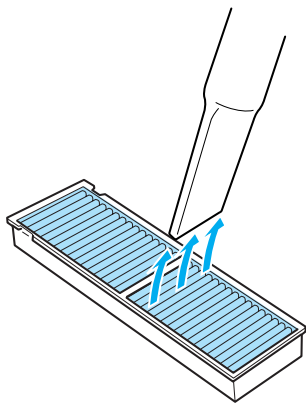

- 6** Install the air filter into the air filter cover.

Insert the protruding section of the air filter into the hole in the cover, and then press it in firmly.

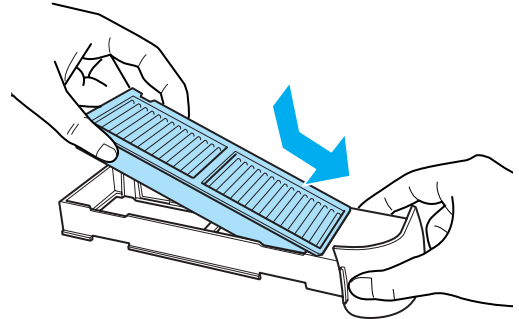

- 7** Install the air filter cover.
Press the cover until it clicks into place.

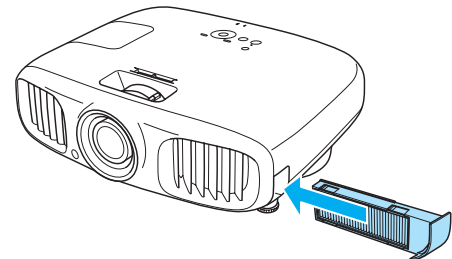

Cleaning the main unit

Clean the projector's surface by wiping it gently with a soft cloth.

If it is particularly dirty, moisten the cloth with water containing a small amount of neutral detergent, and then firmly wring the cloth dry before using it to wipe the surface.

Attention

Do not use volatile substances such as wax, alcohol, or thinner to clean the projector's surface. The quality of the case may change or the paint may peel off.

■ Cleaning the lens

Use a commercially available cloth for cleaning glasses to gently wipe off dirt from the lens.

Attention

Do not rub the lens with harsh materials or handle the lens too roughly as it can easily become damaged.

■ Cleaning the 3D Glasses

Use the cloth supplied to gently wipe off dirt from the lenses of the 3D Glasses.

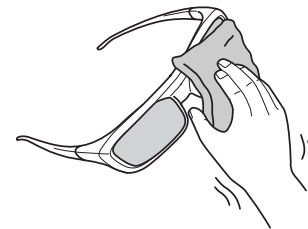

Attention

- Do not rub the lenses of the glasses with harsh materials or handle the lenses too roughly as they can easily become damaged.
- When maintenance is necessary, disconnect the USB Charging Adapter from the electrical outlet, and check that all cables have been disconnected.

Replacement Periods for Consumables

■ Air filter replacement period

- If the message is displayed even though the air filter has been cleaned  [p.88](#)

■ Lamp replacement period

- The following message is displayed when projection starts
"It is time to replace your lamp. Please contact your Epson projector reseller or visit www.epson.com to purchase."
- The projected image gets darker or starts to deteriorate.



- The lamp replacement message is set to appear after 3900 H in order to maintain the initial brightness and quality of the projected images. The message display time changes depending on the usage situation, such as the color mode setting and so on.
If you continue to use the lamp after the replacement period has passed, the possibility that the lamp may explode increases. When the lamp replacement message appears, replace the lamp with a new one as soon as possible, even if it is still working.
- Depending on the characteristics of the lamp and the way it has been used, the lamp may become darker or stop working before the lamp warning message appears. You should always have a spare lamp unit ready in case it is needed.

Replacing Consumables

Replacing the air filter



Dispose of used air filters in accordance with your local laws and regulations.
Material: Polypropylene

- 1 Press the  button on the remote control or the control panel to turn off the power, and then disconnect the power cable.

- 2 Remove the air filter cover.
Hook your finger into the tab on the air filter cover, and pull it straight out.

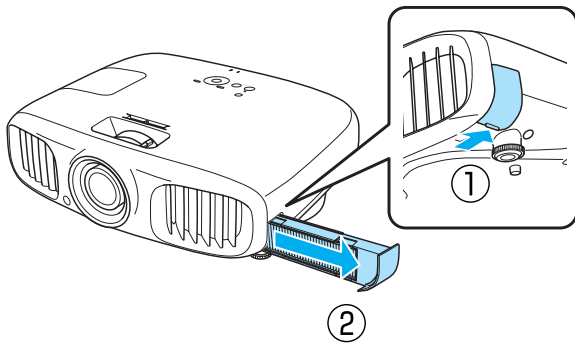

- 3 Remove the old air filter.
Place your finger in the groove and remove the air filter.

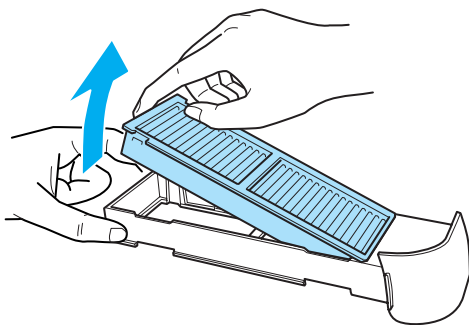

- 4 Install the new air filter into the air filter cover.

Insert the protruding section of the air filter into the hole in the cover, and then press it in firmly.

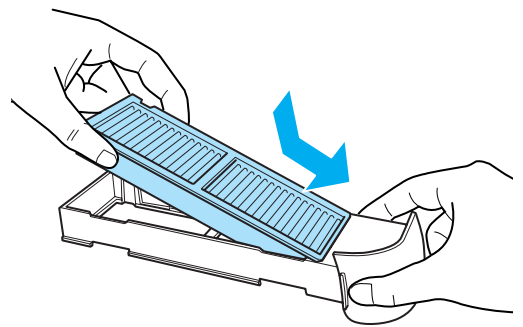

- 5 Install the air filter cover.
Press the cover until it clicks into place.

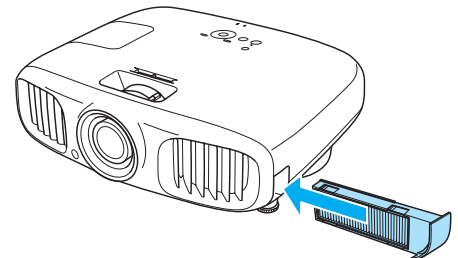

■ Replacing the lamp

 **Warning**

When replacing the lamp because it has stopped illuminating, there is a possibility that the lamp may be broken. If replacing the lamp of a projector that has been suspended from the ceiling, you should always assume that the lamp is cracked, and remove the lamp cover with care. When you open the lamp cover, small shards of glass could fall out. If any shards of glass get into your eyes or mouth, contact a doctor immediately.

 **Caution**

Do not touch the lamp cover immediately after turning off the projector as it is still hot. Wait until the lamp has cooled down sufficiently before removing the lamp cover. Otherwise, you could get burnt.

1 Press the  button on the remote control or the control panel to turn off the power, and then disconnect the power cable.

2 Loosen the lamp cover fixing screw.

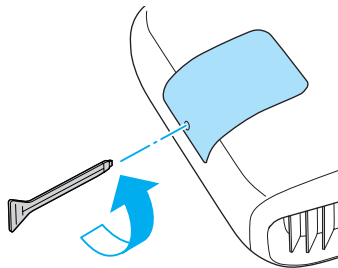

3 Remove the lamp cover.
Slide the lamp cover straight forward and remove it.

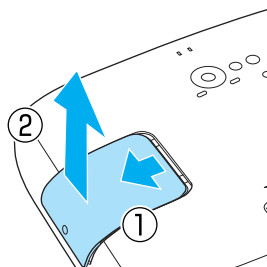

4 Loosen the lamp fixing screw.

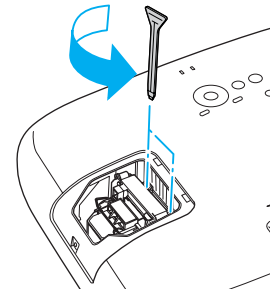

5 Remove the old lamp.
Grip the knob firmly and pull it straight out.

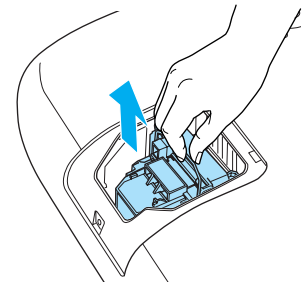

6 Install the new lamp.
Make sure the lamp is facing the correct direction and press it in.

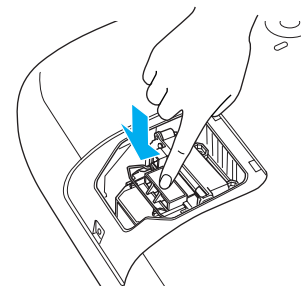

7 Tighten the lamp fixing screw.

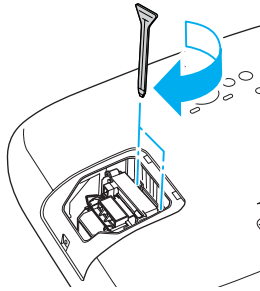

8 Install the lamp cover.
Slide the cover back into place.

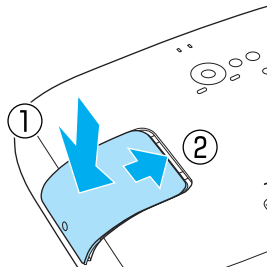

9 Tighten the lamp cover fixing screw.

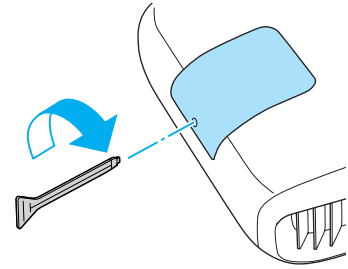

Warning

Do not disassemble or remodel the lamp.

Caution

- Make sure you install the lamp and lamp cover securely. If they are not installed correctly, the power does not turn on.
- The lamp contains mercury. Dispose of used lamps in accordance with your local laws and regulations on disposing of fluorescent tubing.

Resetting lamp hours

After replacing the lamp, make sure you reset the lamp hours.

The projector records how long the lamp is turned on and a message and indicator notify you when it is time to replace the lamp.

1 Turn on the power.

2 Press the  button.
The configuration menu is displayed.



3

Select **Reset - Reset Lamp Hours.**

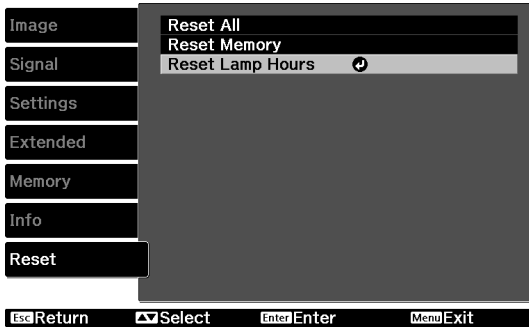
A reset confirmation message is displayed.



4

Use the   buttons to select **Yes**, and then press the  button to execute.

The lamp hours are reset.

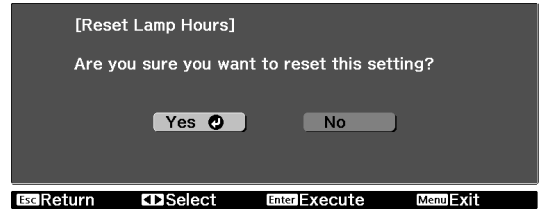

Optional Accessories and Consumables

The following optional accessories/consumables are available for purchase if required. This list of optional accessories/consumables is current as of: 2012.7. Details of accessories are subject to change without notice.

Varies depending on country of purchase.

Optional Items

Name	Model No.	Explanation
Ceiling mount*	ELPMB30 ELPMB22	Use when installing the projector on a ceiling.
Ceiling pipe 600 (600 mm white)*	ELPFP07	Use when installing the projector on a high ceiling.
Ceiling pipe 450 (450 mm white)*	ELPFP13	
Ceiling pipe 700 (700 mm white)*	ELPFP14	
RF system 3D Glasses	ELPGS03	You will need additional pairs to watch 3D images in a group.
USB Charging Adapter	ELPAC01	Use when charging the 3D Glasses.

* Special expertise is required to suspend the projector from a ceiling. Contact your local dealer.

Consumables

Name	Model No.	Explanation
Lamp unit	ELPLP68	Use as a replacement for used lamps. (1 lamp)
Air filter	ELPAF38	Use as a replacement for used air filters. (1 air filter)



Supported Resolutions

Component Video

Signal	Refresh Rate (Hz)	Resolution (dots)
SDTV (480i)	60	720 x 480
SDTV (576i)	50	720 x 576
SDTV (480p)	60	720 x 480
SDTV (576p)	50	720 x 576
HDTV (720p)	50/60	1280 x 720
HDTV (1080i)	50/60	1920 x 1080
HDTV (1080p)	50/60	1920 x 1080

Composite Video

Signal	Refresh Rate (Hz)	Resolution (dots)
TV (NTSC)	60	720 x 480
TV (SECAM)	50	720 x 576
TV (PAL)	50/60	720 x 576

Computer Signals (Analog RGB)

Signal	Refresh Rate (Hz)	Resolution (dots)
VGA	60/72/75/85	640 x 480
SVGA	56/60/72/75/85	800 x 600
XGA	60/70/75/85	1024 x 768
SXGA	70/75/85	1152 x 864
	60/75/85	1280 x 960
	60/75/85	1280 x 1024
WXGA	60	1280 x 768
	60	1360 x 768
	60/75/85	1280 x 800

HDMI1/HDMI2 Input Signal

Signal	Refresh Rate (Hz)	Resolution (dots)
VGA	60	640 x 480
SDTV (480i)	60	720 x 480
SDTV (576i)	50	720 x 576
SDTV (480p)	60	720 x 480
SDTV (576p)	50	720 x 576
HDTV (720p)	50/60	1280 x 720
HDTV (1080i)	50/60	1920 x 1080
HDTV (1080p)	24/50/60	1920 x 1080

3D Input Signal

Signal	Refresh Rate (Hz)	Resolution (dots)	3D Format		
			Frame Packing	Side by Side	Top and Bottom
HDTV750p (720p)	50/60	1280 x 720	✓	✓	✓
HDTV1125i (1080i)	50/60	1920 x 1080	-	✓	-
HDTV1125p (1080p)	50/60	1920 x 1080	-	✓	-
HDTV1125p (1080p)	24	1920 x 1080	✓	-	✓

WirelessHD Input Signal

Signal	Refresh Rate (Hz)	Resolution (dots)
VGA	60	640 x 480
SDTV (480i)	60	720 x 480
SDTV (576i)	50	720 x 576
SDTV (480p)	60	720 x 480
SDTV (576p)	50	720 x 576
HDTV (720p)*	50/60	1280 x 720
HDTV (1080i)	50/60	1920 x 1080
HDTV (1080p)*	24/50/60	1920 x 1080

* When projecting in WirelessHD, 1080p 60/50 Hz, 1080P 24 Hz frame packing, and 720P 50/60 Hz frame packing do not support Deep Color.



Specifications

Product name		EH-TW6100W/EH-TW6100/EH-TW5950
Appearance (not including adjustable foot)		420 (W) x 137.3 (H) x 365 (D) mm
Panel Size		0.61" wide
Display method		Polysilicon TFT active matrix
Resolution		1920 (W) x 1080 (H) x 3
Scanning Frequency	Digital	Pixel Clock: 13.5 - 148.5 MHz
		Horizontal: 15.63 - 67.5 kHz
		Vertical: 24 - 60 Hz
	Analog	Pixel Clock: 13.5 - 157.5 MHz
		Horizontal: 15.63 - 91.15 kHz
		Vertical: 50 - 85 Hz
Focus adjustment		Manual
Zoom adjustment		Manual (approx. 1 to 1.6)
Lamp (light source)		UHE lamp 230 W, Model No.: ELPLP68
Power supply		100 to 240 V AC \pm 10%, 50/60 Hz, 3.7 - 1.7 A
Power consumption	100 to 120 V area	Operating: 372 W
		Standby power consumption: 0.26 W Standby power consumption: 7.4 W*
	220 to 240 V area	Operating: 358 W
		Standby power consumption: 0.35 W Standby power consumption: 8.4 W*
Operating altitude		Altitude 0 to 2286 m
Operating temperature		+5 to 35°C (No condensation)
Storage temperature		-10 to +60°C (No condensation)
Mass		Approx. 6.2 kg (EH-TW6100W), Approx. 6.0 kg (EH-TW6100/ EH-TW5950)
Connectors		Component port x 1, 3RCA pin jack
		PC port x 1, Mini D-Sub15-pin (female) blue
		HDMI port x 2, HDMI For HDCP, For CEC signals, For linear PCM, Deep Color
		Video port x 1, RCA pin jack
		RS-232C port x 1, D-sub 9-pin (male)
		Audio-L/R port x 1, RCA pin jack
		USB 2.0 TypeA port x 1, (for USB connected equipment)
Speaker		Maximum input 10 W x 2

* When using the WirelessHD Transmitter with EH-TW6100W, and the following conditions are satisfied

Settings - WirelessHD - WirelessHD - On

Settings - HDMI Link - Power On Link is set to **Bidirectional** or **Device -> PJ**  [p.71](#)

This product is also designed for IT power distribution system with phase-to-phase voltage 230V.

Обладнання відповідає вимогам Технічного регламенту обмеження використання деяких небезпечних речовин в електричному та електронному обладнанні.



Angle of tilt

If you use the projector tilted at an angle of more than 10° it could be damaged or cause an accident.

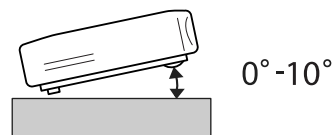

RS-232C Cable layouts

- Connector shape: D-sub 9-pin (male)
- Projector input port name: RS-232C
- Signal name:

Signal Name	Function
GND	Signal wire ground
TD	Transmit data
RD	Receive data

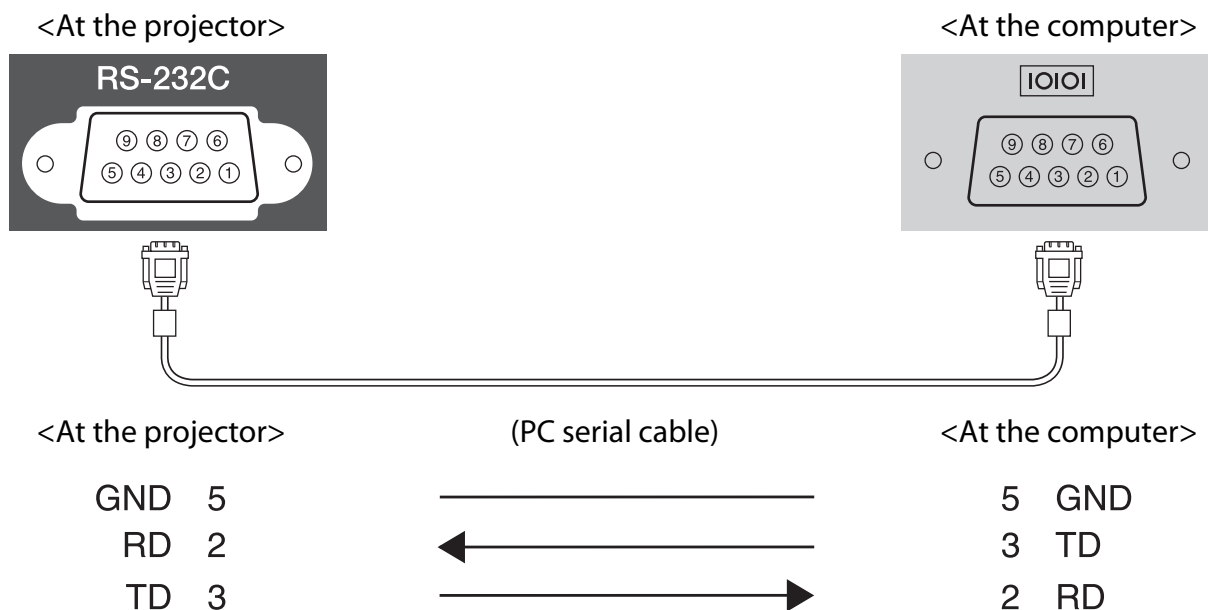

- Communications protocol
 - Default baud rate setting: 9600 bps
 - Data length: 8 bit
 - Parity: None
 - Stop-bit: 1 bit
 - Flow control: None

DECLARATION of CONFORMITY

According to 47CFR, Part 2 and 15

Class B Personal Computers and Peripherals; and/or

CPU Boards and Power Supplies used with Class B Personal Computers

We: Epson America, Inc.
Located at: 3840 Kilroy Airport Way
MS: 3-13
Long Beach, CA 90806
Tel: 562-981-3840

Declare under sole responsibility that the product identified herein, complies with 47CFR Part 2 and 15 of the FCC rules as a Class B digital device. Each product marketed, is identical to the representative unit tested and found to be compliant with the standards. Records maintained continue to reflect the equipment being produced can be expected to be within the variation accepted, due to quantity production and testing on a statistical basis as required by 47CFR 2.909. Operation is subject to the following two conditions : (1) this device may not cause harmful interference, and (2) this device must accept any interference received, including interference that may cause undesired operation.

Trade Name: EPSON
Type of Product: LCD Projector
Model: H501C/H502C/H503C

FCC Compliance Statement**For United States Users**

This equipment has been tested and found to comply with the limits for a Class B digital device, pursuant to Part 15 of the FCC Rules. These limits are designed to provide reasonable protection against harmful interference in a residential installation. This equipment generates, uses, and can radiate radio frequency energy and, if not installed and used in accordance with the instructions, may cause harmful interference to radio communications. However, there is no guarantee that interference will not occur in a particular installation. If this equipment does cause harmful interference to radio or television reception, which can be determined by turning the equipment off and on, the user is encouraged to try to correct the interference by one or more of the following measures.

- Reorient or relocate the receiving antenna.
- Increase the separation between the equipment and receiver.
- Connect the equipment into an outlet on a circuit different from that to which the receiver is connected.
- Consult the dealer or an experienced radio/TV technician for help.

WARNING

The connection of a non-shielded equipment interface cable to this equipment will invalidate the FCC Certification or Declaration of this device and may cause interference levels which exceed the limits established by the FCC for this equipment. It is the responsibility of the user to obtain and use a shielded equipment interface cable with this device. If this equipment has more than one interface connector, do not leave cables connected to unused interfaces. Changes or modifications not expressly approved by the manufacturer could void the user's authority to operate the equipment.



Glossary

This section briefly explains the difficult terms that are not explained in context in the text of this guide. For details, refer to other commercially available publications.

Aspect Ratio	The ratio between an image's length and its height. Screens with a horizontal:vertical ratio of 16:9, such as HDTV screens, are known as wide screens. SDTV and general computer displays have an aspect ratio of 4:3.
HDCP	HDCP is an abbreviation for High-bandwidth Digital Content Protection. It is used to prevent illegal copying and protect copyrights by encrypting digital signals sent over DVI and HDMI ports. Because the HDMI port on this projector supports HDCP, it can project digital images protected by HDCP technology. However, the projector may not be able to project images protected with updated or revised versions of HDCP encryption.
HDMI™	An abbreviation for High Definition Multimedia Interface. This is the standard by which HD images and multichannel audio signals are digitally transmitted. HDMI™ is a standard aimed at digital consumer electronics and computers. By not compressing the digital signal, the image can be transferred at the highest quality possible. It also provides an encryption function for the digital signal.
HDTV	An abbreviation for High-Definition Television. This refers to high-definition systems which satisfy the following conditions. <ul style="list-style-type: none"> • Vertical resolution of 720p or 1080i or greater (p = Progressive, i = Interlace) • Screen aspect of 16:9 Dolby Digital audio reception and playback (or output)
Interlace	Transmits information needed to create one screen by sending every other line, starting from the top of the image and working down to the bottom. Images are more likely to flicker because one frame is displayed every other line.
NTSC	An abbreviation for the National Television Standards Committee. A terrestrial analog color broadcasting method. This method is used in Japan, North America, and Latin America.
Pairing	Register devices in advance when connecting with Bluetooth devices to ensure mutual communication.
PAL	An abbreviation for Phase Alternation by Line. A terrestrial analog color broadcasting method. This method is used in various Western European countries (with the exception of France), Asian countries such as China, and Africa.
SDTV	An abbreviation for Standard Definition Television. This refers to standard television systems which do not satisfy the conditions for HDTV High-Definition Television.
SECAM	An abbreviation for SEquential Couleur A Memoire. A terrestrial analog color broadcasting method. This method is used in France, Eastern Europe, the former Soviet Union, the Middle East, Africa, and so on.
SVGA	A screen size standard with a resolution of 800 (horizontal) x 600 (vertical) dots.
SXGA	A screen size standard with a resolution of 1,280 (horizontal) x 1,024 (vertical) dots.
VGA	A screen size standard with a resolution of 640 (horizontal) x 480 (vertical) dots.
XGA	A screen size standard with a resolution of 1,024 (horizontal) x 768 (vertical) dots.
YCbCr	In component image signals for SDTV, Y is the brightness, while Cb and Cr indicate the color difference.
YPbPr	In component image signals for HDTV, Y is the brightness, while Pb and Pr indicate the color difference.



General Notes

All rights reserved. No part of this publication may be reproduced, stored in a retrieval system, or transmitted in any form or by any means, electronic, mechanical, photocopying, recording, or otherwise, without the prior written permission of Seiko Epson Corporation. No patent liability is assumed with respect to the use of the information contained herein. Neither is any liability assumed for damages resulting from the use of the information contained herein.

Neither Seiko Epson Corporation nor its affiliates shall be liable to the purchaser of this product or third parties for damages, losses, costs, or expenses incurred by the purchaser or third parties as a result of: accident, misuse, or abuse of this product or unauthorized modifications, repairs, or alterations to this product, or (excluding the U.S.) failure to strictly comply with Seiko Epson Corporation's operating and maintenance instructions.

Seiko Epson Corporation shall not be liable against any damages or problems arising from the use of any options or any consumable products other than those designated as Original Epson Products or Epson Approved Products by Seiko Epson Corporation.

The contents of this guide may be changed or updated without further notice.

Illustrations in this guide and the actual projector may differ.

Restriction of Use

When this product is used for applications requiring high reliability/safety such as transportation devices related to aviation, rail, marine, automotive etc.; disaster prevention devices; various safety devices etc; or functional/precision devices etc, you should use this product only after giving consideration to including fail-safes and redundancies into your design to maintain safety and total system reliability. Because this product was not intended for use in applications requiring extremely high reliability/safety such as aerospace equipment, main communication equipment, nuclear power control equipment, or medical equipment related to direct medical care etc, please make your own judgment on this product's suitability after a full evaluation.

Notes when Wearing 3D Glasses

This product can be used within the 2.4 GHz frequency band. The frequency band used by this device is shared with industrial, scientific, or medical equipment, including household microwave ovens, and so on; similar radio stations, factory radio stations for detecting moving objects that require a license, low-power radio stations that do not require a license, as well as amateur radio stations (hereafter "other radio stations"), and so on.

Before using this device, check that there are no "other radio stations" in the vicinity.

Should interference occur between this device and "other radio stations", move the device to another location, or stop using the device immediately. If any other problems occur, contact the information center.

These wireless devices use the 2.4 GHz frequency band. By adopting the FH-SS modulation method, the expected interference range is 10 m.

General Notice

HDMI and High-Definition Multimedia Interface are the trademarks or registered trademarks of HDMI Licensing LLC.  HIGH DEFINITION MULTIMEDIA INTERFACE

WirelessHD, WiHD, and the WiHD logo are trademarks or registered trademarks of WirelessHD LLC.

The Full HD 3D Glasses™ logo and Full HD 3D Glasses™ are trademarks of the Full HD 3D Glasses Initiative™.

Bluetooth® and the Bluetooth logo are the trademarks of Bluetooth SIG, Inc.

InstaPrevue and the InstaPrevue logo are the trademarks or registered trademarks of Silicon Image, Inc.

Bluetopia® is provided for your use by Stonestreet One, LLC® under a software license agreement. Stonestreet One, LLC® is and shall remain the sole owner of all right, title and interest whatsoever in and to Bluetopia® and your use is subject to such ownership and to the license agreement. Stonestreet One, LLC® reserves all rights related to Bluetopia® not expressly granted under the license agreement and no other rights or licenses are granted either directly or by implication, estoppel or otherwise, or under any patents, copyrights, mask works, trade secrets or other intellectual property rights of Stonestreet One, LLC®.

© 2000-2012 Stonestreet One, LLC® All Rights Reserved.

Other product names used herein are also for identification purposes only and may be trademarks of their respective owners. Epson disclaims any and all rights in those marks.

©SEIKO EPSON CORPORATION 2012. All rights reserved.

3

3D brightness	68
3D display	68
3D format	68
3D Glasses	42
3D Glasses charging port	50
3D images	42
3D settings	68
3D viewing notice	68

A

Abs. Color Temp.	66
Adjusting focus	25
Adjusting RGB	34
Adjusting the tilt	26
Advanced	67, 70
Air filter	88
Air filter cover	88, 91
Air filter replacement period	90
Appearance	15
Aspect	30, 68
Audio	71
Audio source	76
Auto iris	37, 67
Auto setup	69
Auto V-Keystone	26, 71

B

Brightness	32, 66, 67
------------------	------------

C

CEC standards	59
Child lock	72
Cleaning the 3D Glasses	90
Cleaning the air filter	88
Cleaning the lens	90
Cleaning the main unit	89
Color mode	29, 66
Color saturation	66
Component	74
Component port	18
Configuration menu	65
Connecting	18
Connecting to a computer	19
Connecting to video equipment	18
Connecting USB devices	19
Connecting WirelessHD devices	20
Contrast	66
Control panel	8, 9
Control panel lock	72
Cool-down	23

D

Deep color	75
Device connections	53, 72
Direct power on	73
Display background	74
Display settings	74
Displaying the test pattern	25

E

EPSON Super White	70
Erase device name	72
Erase memory	40, 74
Error/Warning indicators	77
Exit split screen	76
Extended menu	73

F

Focus	81
Focus adjustment	25
Focus ring	8, 25

G

Gain	34, 67
Gamma	33, 67

H

H/V-Keystone	27, 71
HDMI link	59
HDMI port	59
HDMI video range	70
HDMI1 port	18, 19
HDMI2 port	18, 19
High altitude mode	73
H-Keystone	71
H-Keystone adjuster	26, 71
H-Keystone slider	8
Hue	32, 67

I

Illumination	73
Image	29
Image menu	66
Images	63
Indicators	77
Info menu	75
Input signal	74, 75
Inverse 3D Glasses	68
Inverse audio	71

- K**
- Keystone 26, 71
 - Keystone distortion 26
- L**
- Lamp cover 8, 92
 - Lamp cover fixing screw 92
 - Lamp hours 75
 - Lamp replacement period 90
 - Language 74
 - Left screen 76
 - Link indicator 50
 - Load memory 40, 74
 - Lock setting 72
- M**
- Memory function 39
 - Memory menu 74
 - Menu 65
 - Menu color 74
 - Menu position 74
 - Messages 74
 - Model no. display mode 74
 - Motion detection 69
- N**
- Noise 82
 - Noise reduction 70
- O**
- Offset 34, 67
 - Operating range 21
 - Operating time 93
 - Operation 73
 - Overscan 70
- P**
- Pairing 43
 - PC port 19
 - Position 68
 - Power 23
 - Power consumption 67
 - Power supply 22
 - Progressive 69
 - Projection 73
 - Projection size 17, 25
- R**
- Reception 53, 72
 - Refresh rate 75
 - Remote control 10, 21
 - Rename device name 72
 - Rename memory 40, 74
 - Replacement periods for consumables 90
 - Replacement time 90
 - Replacing consumables 91
 - Replacing the air filter 91
 - Replacing the lamp 92
 - Reset 67, 70, 72, 73, 74
 - Reset all 75
 - Reset lamp hours 75, 93
 - Reset memory 40, 75
 - Reset menu 75
 - Resolution 75
 - RGB 67
 - RGBCMY 32, 67
 - Right screen 76
- S**
- Saturation 32, 67
 - Save memory 39, 74
 - Scan mode 75
 - Screen size 76
 - Serial number 75
 - Settings menu 71
 - Setup level 70
 - Sharpness 36, 66
 - Signal menu 68
 - Skin tone 66
 - Sleep mode 73
 - Slideshow 63
 - Source 23, 75, 76
 - Specifications 98
 - Split screen 61, 76
 - Standby confirmation 74
 - Startup screen 74
 - Status 75
 - Sub menu 65
 - Sub-screen 57
 - Supported resolutions 96
 - Swap screens 76
 - Sync info 75
 - Sync. 68
- T**
- Tint 66
 - Top menu 65
 - Tracking 68
 - Transmission range 54

U

USB	63
USB port	19
User button	73

V

Video port	18
Video signal	74, 75
Viewing area	44
V-Keystone	71
Volume	28, 71

W

Wide	30
WiHD indicator	50
WirelessHD	49, 72

Z

Zoom	30
Zoom adjustment	25
Zoom Caption Pos.	68
Zoom ring	8
Zoom size	68