



DLP™ PROJECTOR



MODEL

# EX200U/ES200U

User Manual

# *EX200U/ES200U*

This User Manual is important to you.  
Please read it before using your projector.

	<b>CAUTION</b> RISK OF ELECTRIC SHOCK DO NOT OPEN	
<p><b>CAUTION: TO REDUCE THE RISK OF ELECTRIC SHOCK,</b> DO NOT REMOVE COVER (OR BACK) NO USER-SERVICEABLE PARTS INSIDE REFER SERVICING TO QUALIFIED SERVICE PERSONNEL.</p>		



The lightning flash with arrowhead symbol within an equilateral triangle is intended to alert the user to the presence of un-insulated "dangerous voltage" within the product's enclosure that may be of sufficient magnitude to constitute a risk of electric shock.



The exclamation point within an equilateral triangle is intended to alert the user to the presence of important operating and maintenance (servicing) instructions in the literature accompanying the appliance.

**WARNING:**

TO PREVENT FIRE OR SHOCK HAZARD, DO NOT EXPOSE THIS APPLIANCE TO RAIN OR MOISTURE.

**CAUTION:**

TO PREVENT ELECTRIC SHOCK, DO NOT USE THIS (POLARIZED) PLUG WITH AN EXTENSION CORD, RECEPTACLE OR OTHER OUTLET UNLESS THE BLADES CAN BE FULLY INSERTED TO PREVENT BLADE EXPOSURE.

**NOTE:**

SINCE THIS PROJECTOR IS PLUGGABLE EQUIPMENT, THE SOCKET-OUTLET SHALL BE INSTALLED NEAR THE EQUIPMENT AND SHALL BE EASILY ACCESSIBLE.

**WARNING**

Use the attached specified power supply cord. If you use another power supply cord, it may cause interference with radio and television reception.

Use the attached RGB cable with this equipment so as to keep interference within the limits of an FCC Class B device.

This apparatus must be grounded.

**DO NOT LOOK DIRECTLY INTO THE LENS WHEN THE PROJECTOR IS IN THE POWER ON MODE.**

**CAUTION**

Not for use in a computer room as defined in the Standard for the Protection of Electronic Computer/Data Processing Equipment, ANSI/NFPA 75.

The attached power cord is to be used exclusively for this product. Never use it for other products.

**When using the projector in Europe:**

**COMPLIANCE NOTICE**

This Projector complies with the requirements of the EC Directive 2004/108/EC "EMC Directive" and 2006/95/EC "Low Voltage Directive".

The electro-magnetic susceptibility has been chosen at a level that gains proper operation in residential areas, on business and light industrial premises and on small-scale enterprises, inside as well as outside of the buildings. All places of operation are characterized by their connection to the public low voltage power supply system.

**WARNING**

Use the attached RGB cable with this equipment so as to keep interference within the limits of an EN55022 Class B device.

**When using the projector in Korea:**

**WARNING**

Use the attached RGB cable with this equipment so as to keep interference within the limits of a K00022 Class B device.

Please follow WARNING instructions.



**Note:** This symbol mark is for EU countries only.

This symbol mark is according to the directive 2002/96/EC Article 10 Information for users and Annex IV, and/or to the directive 2006/66/EC Article 20 Information for end-users and Annex II.

Your MITSUBISHI ELECTRIC product is designed and manufactured with high quality materials and components which can be recycled and/or reused.

This symbol means that electrical and electronic equipment, batteries and accumulators, at their end-of-life, should be disposed of separately from your household waste. If a chemical symbol is printed beneath the symbol shown above, this chemical symbol means that the battery or accumulator contains a heavy metal at a certain concentration. This will be indicated as follows:

Hg: mercury (0,0005%), Cd: cadmium (0,002%), Pb: lead (0,004%)

In the European Union there are separate collection systems for used electrical and electronic products, batteries and accumulators.

Please, dispose of this equipment, batteries and accumulators correctly at your local community waste collection/recycling centre.

Please, help us to conserve the environment we live in!

## WARNING

- The lens cap is for protecting the lens. If you leave the lens cap on the lens with the projector turned on, it may be deformed because of heat build-up. Remove the lens cap when you turn on the projector.
- One of power cords for the U.S., Europe, U.K./Singapore, Australia, Korea and China is provided appropriately.
- This projector uses the power plug of three-pin grounding type. Do not remove the grounding pin from the power plug. If the power plug doesn't fit your wall outlet, ask an electrician to change the wall outlet.
- In case that the power cord for the U.S. is provided with this projector, never connect this cord to any outlet or power supply using other voltages or frequencies than rated. If you want to use a power supply using other voltage than rated, prepare an appropriate power cord separately.
- Use 100-240 V AC 50/60 Hz to prevent fire or electric shock.
- Do not place any objects on the power cord or do not place the projector near heat sources to prevent damage to the power cord. If the power cord should be damaged, contact your dealer for replacement because it may cause fire or electric shock.
- Do not modify or alter the power cord. If the power cord is modified or altered, it may cause fire or electric shock.

# Contents

---

Important safeguards .....	5
Projector exterior view .....	7
Controls and functions.....	8
Positioning your projector .....	11
Connection.....	14
Operation .....	19
Adjusting the projected image.....	23
Optimizing the image .....	26
Menu operation.....	32
Maintenance.....	38
Lamp information .....	39
Indicators .....	44
Troubleshooting.....	45
Specifications.....	46

## Declaration of Conformity

Model Number: EX200U/ES200U  
Trade Name: MITSUBISHI ELECTRIC  
Responsible party: Mitsubishi Digital Electronics America, Inc.  
9351 Jeronimo Road, Irvine, CA 92618 U.S.A  
Telephone number: +1-(949) 465-6000

This device complies with Part 15 of the FCC Rules. Operation is subject to the following two conditions:

- (1) this device may not cause harmful interference, and
- (2) this device must accept any interference received, including interference that may cause undesired operation.

## Trademark, Registered trademark

Macintosh is registered trademark of Apple Computer Inc.

DLP™, Digital Micromirror Device, DMD, and BrilliantColor™ are all trademarks of Texas Instruments.

Microsoft, Windows, Windows XP, Windows Vista, and Internet Explorer are registered trademarks, trademarks, or trade names of Microsoft Corporation in the U.S. and/or other countries.

Other brand or product names are trademarks or registered trademarks of their respective holders.

# Important safeguards

Please read all these instructions regarding your projector and retain them for future reference. Follow all warnings and instructions marked on the projector.

1. Read instructions  
All the safety and operating instructions should be read before the appliance is operated.
2. Retain instructions  
The safety and operating instructions should be retained for future reference.
3. Warnings  
All warnings on the appliance and in the operating instructions should be adhered to.
4. Instructions  
All operating instructions must be followed.
5. Cleaning  
Unplug this projector from the wall outlet before cleaning it. Do not use liquid aerosol cleaners. Use a damp soft cloth for cleaning.
6. Attachments and equipment  
Never add any attachments and/or equipment without the approval of the manufacturer as such additions may result in the risk of fire, electric shock or other personal injury.
7. Water and moisture  
Do not use this projector near water or in contact with water.
8. Accessories  
Do not place this projector on an unstable cart, stand, tripod, bracket or table. Use only with a cart, stand, tripod bracket, or table recommended by the manufacturer or sold with the projector. Any mounting of the appliance should follow the manufacturer's instructions and should use a mounting accessory recommended by the manufacturer.



An appliance and cart combination should be moved with care. Quick stops, excessive force and uneven surfaces may cause the appliance and cart combination to overturn.

9. Ventilation  
Slots and openings in the cabinet are provided for ventilation, ensuring reliable operation of the projector and to protect it from overheating. Do not block these openings or allow them to be blocked by placing the projector on a bed, sofa, rug, or bookcase. Ensure that there is adequate ventilation and that the manufacturer's instructions have been adhered to.
10. Power sources  
This projector should be operated only from the type of power source indicated on the marking label. If you are not sure of the type of power, please consult your appliance dealer or local power company.
11. Power-cord protection  
Power-supply cords should be routed so that they are not likely to be walked on or pinched by items placed upon or against them. Pay particular attention to cords at plugs, convenience receptacles, and points where they exit from the appliance. Do not put the power cord under a carpet.

12. Overloading  
Do not overload wall outlets and extension cords as this can result in a fire or electric shock.
13. Objects and liquids  
Never push objects of any kind through openings of this projector as they may touch dangerous voltage points or short-out parts that could result in a fire or electric shock. Never spill liquid of any kind on the projector.
14. Servicing  
Do not attempt to service this projector yourself. Refer all servicing to qualified service personnel.
15. Damage requiring service  
Unplug this projector from the wall outlet and refer servicing to qualified service personnel under the following conditions:
  - (a) If the power-supply cord or plug is damaged.
  - (b) If liquid has been spilled, or objects have fallen into the projector.
  - (c) If the projector does not operate normally after you follow the operating instructions. Adjust only those controls that are covered by the operating instructions. An improper adjustment of other controls may result in damage and may often require extensive work by a qualified technician to restore the projector to its normal operation.
  - (d) If the projector has been exposed to rain or water.
  - (e) If the projector has been dropped or the cabinet has been damaged.
  - (f) If the projector exhibits a distinct change in performance - this indicates a need for service.
16. Replacement parts  
When replacement parts are required, be sure that the service technician has used replacement parts specified by the manufacturer or parts having the same characteristics as the original part. Unauthorized substitutions may result in fire, electric shock or other hazards.
17. Safety check  
Upon completion of any service or repair to this projector, ask the service technician to perform safety checks determining that the projector is in a safe operating condition.

## **WARNING:**

### **Unplug immediately if there is something wrong with your projector.**

Do not operate if smoke, strange noise or odor comes out of your projector. It may cause fire or electric shock. In this case, unplug immediately and contact your dealer.

### **Never remove the cabinet.**

This projector contains high voltage circuitry. An inadvertent contact may result in an electric shock. Except as specifically explained in User Manual, do not attempt to service this product by yourself. Please contact your dealer when you want to fix, adjust, or inspect the projector.

### **Do not modify the projector.**

It can lead to fire or electric shock.

### **Do not keep using the damaged projector.**

If the projector is dropped and the cabinet is damaged, unplug the projector and contact your dealer for inspection. It may lead to fire if you keep using the damaged projector.

### **Do not face the projection lens to the sun.**

It can lead to fire.

### **Use correct voltage.**

If you use incorrect voltage, it can lead to fire.

### **Do not place the projector on uneven surface.**

Place the projector on a level and stable surface only.

### **Do not look into the lens when the projector is operating.**

It may hurt your eyes. Never let children look into the lens when the projector is on.

### **Do not unplug the power cord during operation.**

It can lead to lamp breakage, fire, electric shock or other trouble. Wait for the fan to stop before unplugging the power cord.

### **Do not touch the air outlet grilles and bottom plate.**

Do not touch them or put other equipment close to the air outlet grilles because they become hot during operation. The heated air outlet grilles and bottom plate may cause injury or damage to other equipment. Also, do not put the projector on a desk that is easily affected by heat.

### **Do not look into the air outlet grilles when projector is operating.**

Heat, dust, etc. may blow out of them and hurt your eyes.

### **Do not block the air inlet and outlet grilles.**

If they are blocked, heat may be generated inside the projector, causing deterioration in the projector quality and fire.

### **Do not use flammable solvents (benzene, thinner, etc.) and flammable aerosols near the projector.**

Flammable substances may ignite causing fire or breakdown because the temperature inside the projector rises very high while the lamp is illuminating.

### **Do not use the projector with condensation on it.**

It can lead to breakdown or other failure.

### **Place of installation**

For safety's sake, do not use the projector at any place subjected to high temperature and high humidity. Please maintain an operating temperature, humidity, and altitude as specified below.

- Operating temperature: between +41°F (+5°C) and +95°F (+35°C)
- Operating humidity: between 30% and 90%
- Never put any heat-producing device under the projector to prevent the projector from being overheated.
- Do not install the projector at a place that is unstable or subject to vibration.
- Do not install the projector near any equipment that produces a strong magnetic field. Also refrain from installing the projector near any cable carrying a large amount of current.
- Place the projector on a solid, vibration-free surface. Otherwise it may fall, causing serious injury or damage.
- Do not stand the projector on its end. It may fall, causing serious injury or damage.
- Slanting the projector more than  $\pm 10^\circ$  (right and left) or  $\pm 15^\circ$  (front and rear) may cause trouble or explosion of the lamp.
- Do not place the projector near air-conditioning unit, heater, or humidifier to avoid hot or moist air to the exhaust and ventilation hole of the projector.
- Be sure to use this projector at an altitude of less than 1500 meters.

## **COMPLIANCE NOTICE OF FCC**

This equipment has been tested and found to comply with the limits for a Class B digital device, pursuant to Part 15 of the FCC Rules. These limits are designed to provide reasonable protection against harmful interference in a residential installation. This equipment generates, uses and can radiate radio frequency energy and, if not installed and used in accordance with the instructions, may cause harmful interference to radio communications. However, there is no guarantee that interference will not occur in a particular installation. If this equipment does cause harmful interference to radio or television reception, which can be determined by turning the equipment off and on, the user is encouraged to try to correct the interference by one or more of the following measures:

- Reorient or relocate the receiving antenna.
- Increase the separation between the equipment and receiver.
- Connect the equipment into an outlet on a circuit different from that to which the receiver is connected.
- Consult the dealer or an experienced Radio / TV technician for help.

Changes or modifications not expressly approved by Mitsubishi could void the user's authority to operate this equipment.

## **COMPLIANCE NOTICE OF INDUSTRY CANADA**

This Class B digital apparatus complies with Canadian ICES-003.

# Projector exterior view

## Front/upper side

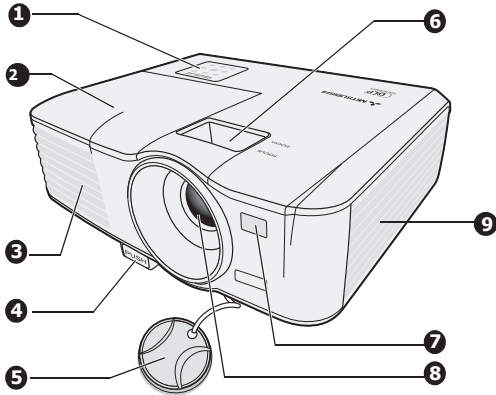

1. External control panel  
(See "Projector" on page 8 for details.)
2. Lamp cover
3. Vent (heated air exhaust)
4. Quick-release button
5. Lens cover
6. Focus ring and Zoom ring
7. Front IR remote sensor
8. Projection lens
9. Vent (air intake)

**!** Do not replace the lamp immediately after using the projector because the lamp would be extremely hot and it may cause burns.

## Rear/lower side

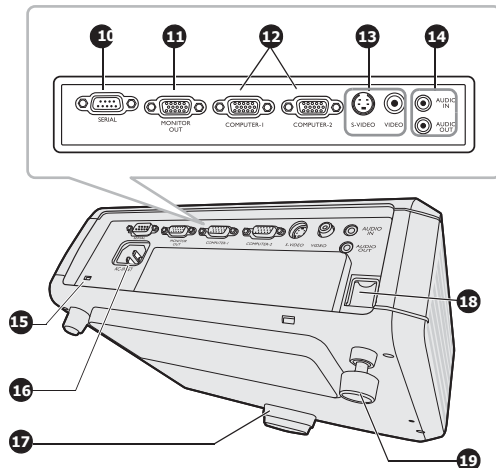

10. Serial control port
11. RGB signal output socket
12. RGB (PC)/Component Video (YPbPr/ YCbCr) signal input socket x 2
13. S-Video input socket
14. Video input socket
15. Kensington lock
16. AC power cord inlet
17. Quick-release foot
18. Security bar
19. Rear adjuster foot

### Kensington Lock

This projector has a Kensington Security Standard connector for use with Kensington MicroSaver Security System. Refer to the information that came with the Kensington System for instructions on how to use it to secure the projector. Please contact Kensington Technology Group below.  
 Kensington Technology Group  
 2855 Campus Drive  
 San Mateo, CA 94403, U.S.A.  
 Phone: +1- (650)572-2700 Fax: +1- (650)572-9675

# Controls and functions

## Projector

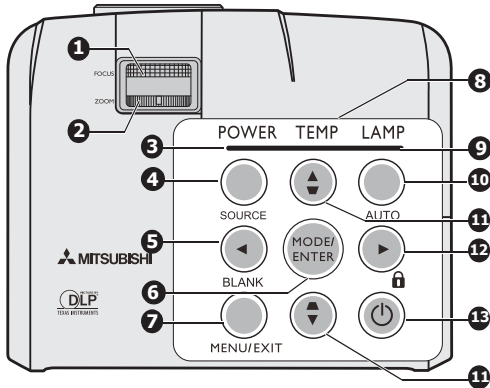

- 1. Focus ring**  
Adjusts the focus of the projected image. See ["Fine-tuning the image size and clarity"](#) on page 23 for details.
- 2. Zoom ring**  
Adjusts the size of the image. See ["Fine-tuning the image size and clarity"](#) on page 23 for details.
- 3. POWER indicator light**  
Lights up or flashes when the projector is under operation. See ["Indicators"](#) on page 44 for details.
- 4. SOURCE**  
Displays the source selection bar. See ["Switching input signal"](#) on page 22 for details.
- 5. ◀ Left/BLANK**  
Used to hide the screen picture. See ["Hiding the image"](#) on page 30 for details.
- 6. MODE/ENTER**  
Selects an available picture setup mode. See ["Selecting a picture mode"](#) on page 26 for details.  
Enacts the selected On-Screen Display (OSD) menu item.
- 7. MENU/EXIT**  
Turns on the On-Screen Display (OSD) menu. Goes back to previous OSD menu, exits and saves menu settings. See ["Using the menus"](#) on page 20 for details.
- 8. TEMPerature indicator light**  
Lights up red if the projector's temperature becomes too high. See ["Indicators"](#) on page 44 for details.
- 9. LAMP indicator light**  
Indicates the status of the lamp. Lights up or flashes when the lamp has developed a problem. See ["Indicators"](#) on page 44 for details.
- 10. AUTO**  
Automatically determines the best picture timings for the displayed image. See ["Auto-adjusting the image"](#) on page 23 for details.
- 11. Keystone/Arrow keys ( ◀ /▲ Up, ▶ /▼ Down)**  
Manually corrects distorted images resulting from an angled projection. See ["Correcting keystone"](#) on page 24 for details.
- 12. ▶ Right/ 🔒**  
Activates panel key lock. See ["Locking control keys"](#) on page 30 for details.  
When the On-Screen Display (OSD) menu is activated, the #5, #11, and #12 keys are used as directional arrows to select the desired menu items and to make adjustments. See ["Using the menus"](#) on page 20 for details.
- 13. ⏻ POWER**  
Toggles the projector between standby mode and on. See ["Starting up the projector"](#) on page 19 and ["Shutting down the projector"](#) on page 31 for details.



## Remote control

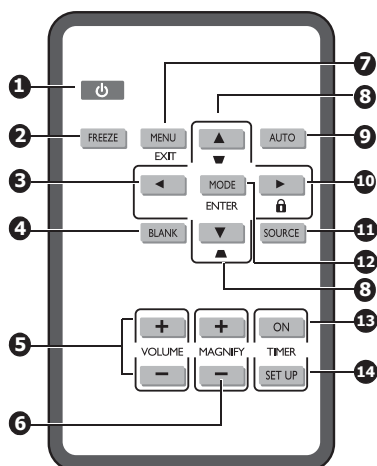

1. **POWER**  
Toggles the projector between standby mode and on. See "Starting up the projector" on page 19 and "Shutting down the projector" on page 31 for details.
2. **FREEZE**  
Freezes the projected image. See "Freezing the image" on page 30 for details.
3. **◀ Left**  
Selects the desired menu items and makes adjustments. See "Using the menus" on page 20 for details.
4. **BLANK**  
Used to hide the screen picture. See "Hiding the image" on page 30 for details.
5. **VOLUME keys (+, -)**  
Adjusts the sound level. See "Adjusting the sound" on page 30 for details.
6. **MAGNIFY keys (+, -)**  
Magnifies or reduces the projected picture size. See "Magnifying and searching for details" on page 24 for details.
7. **MENU/EXIT**  
Turns on the On-Screen Display (OSD) menu. Goes back to previous OSD menu, exits and saves menu settings. See "Using the menus" on page 20 for details.
8. **Keystone/Arrow keys (◀ / ▶ Up, ▲ / ▼ Down)**  
Manually corrects distorted images resulting from an angled projection. See "Correcting keystone" on page 24 for details.
9. **AUTO**  
Automatically determines the best picture timings for the displayed image. See "Auto-adjusting the image" on page 23 for details.
10. **▶ Right / 🔒**  
Activates panel key lock. See "Locking control keys" on page 30 for details.  
When the On-Screen Display (OSD) menu is activated, the #3, #8 and #10 menu keys are used as directional arrows to select the desired menu items and to make adjustments. See "Using the menus" on page 20 for details.
11. **SOURCE**  
Displays the source selection bar. See "Switching input signal" on page 22 for details.
12. **MODE/ENTER**  
Depending upon which input signal is selected, selects an available picture setup mode. See "Selecting a picture mode" on page 26 for details.  
Enacts the selected On-Screen Display (OSD) menu item.
13. **TIMER ON**  
Activates or displays an on-screen timer based on your own timer setting. See "Setting the presentation timer" on page 29 for details.
14. **TIMER SET UP**  
Enters presentation timer setting directly. See "Setting the presentation timer" on page 29 for details.

## Remote control effective range

Infra-Red (IR) remote control sensor is located on the front of the projector. The remote control must be held at an angle within 30 degrees perpendicular to the projector's IR remote control sensor to function correctly. The distance between the remote control and the sensor should not exceed 8 meters (~ 26 feet).

Make sure that there are no obstacles between the remote control and the IR sensor on the projector that might obstruct the infra-red beam.

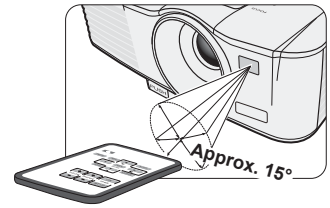

- ⚠ • **Do not let the IR transmitter of the remote control be shined by sunlight or fluorescent lamps directly.**
- **Please keep the remote controller away from fluorescent lamps for over 2 m or the remote controller might become malfunction.**
- **If the remote control is close to Inverter-Type fluorescent lamps, it might become ineffective from time to time.**
- **If the remote control and the projector are within a very short distance, the remote control might become ineffective.**
- **When you aim at the screen, the effective distance is less than 5 m from the remote control to the screen and reflecting the IR beams back to the projector. However, the effective range might change according to screens.**

## Replacing the remote control battery

1. Pull out the battery holder.

☞ Please follow the illustrated instructions. Push and hold the locking arm while pulling out the battery holder.

2. Insert the new battery in the holder. Note the positive polarity should face outward.
3. Push the holder into the remote control.

- ⚠ • **Risk of explosion if battery is replaced by an incorrect type.**
- **Dispose of used batteries according to the instructions.**
- **Use of a battery of wrong type may cause explosion. Use Sony battery, type CR2025 only.**
- **Dispose of used batteries according to your local regulations. Discard used battery promptly. Batteries may explode if mistreated. Do not recharge, disassemble, or dispose of in fire.**
- **Be careful in handling the battery according to the instructions.**
- **Load the battery with its positive (+) and negative (-) sides correctly oriented as indicated on the remote control.**
- **Keep batteries out of reach of children and pets.**
- **Remove the battery if the remote control is not used for a long time.**
- **Keep battery in original package until ready to use.**
- **Never put battery in mouth for any reason as it can easily be accidentally swallowed. If battery is accidentally swallowed, contact your physician or your poison control center.**
- **Dispose of the used battery with cellophane tape wrapping both ends of it.**

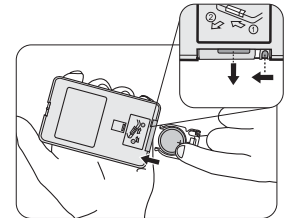

# Positioning your projector

## Choosing a location

Your room layout or personal preference will dictate which installation location you select. Take into consideration the size and position of your screen, the location of a suitable power outlet, as well as the location and distance between the projector and the rest of your equipment.

Your projector is designed to be installed in one of the possible installation locations:

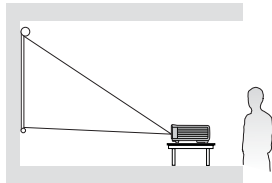
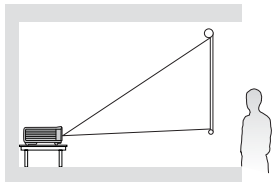
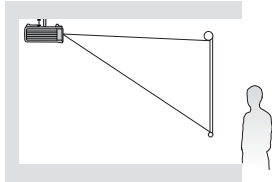
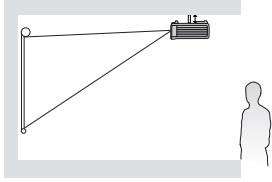
<p><b>1. Front Table</b> Select this location with the projector placed near the floor in front of the screen. This is the most common way to position the projector for quick setup and portability.</p>  <p><b>2. Rear Table</b> Select this location with the projector placed near the floor behind the screen. Note that a special rear projection screen is required. Set <b>Rear Table</b> in the <b>SYSTEM SETUP: Basic &gt; Projector Position</b> menu after you turn the projector on.</p> 	<p><b>3. Rear Ceiling</b> Select this location with the projector suspended upside-down from the ceiling behind the screen. Note that a special rear projection screen and qualified projector ceiling mount kit are required for this installation location.</p>  <p>Set <b>Rear Ceiling</b> in the <b>SYSTEM SETUP: Basic &gt; Projector Position</b> menu after you turn the projector on.</p> <p><b>4. Front Ceiling</b> Select this location with the projector suspended upside-down from the ceiling in front of the screen. Purchase a qualified projector ceiling mount kit from your dealer to mount your projector on the ceiling. Set <b>Front Ceiling</b> in the <b>SYSTEM SETUP: Basic &gt; Projector Position</b> menu after you turn the projector on.</p> 
---	---

For ceiling mounting, you need the ceiling mount kit designed for this projector. Ask a specialist for installation. For details, consult your dealer.

- The warranty on this projector does not cover any damage caused by use of any non-recommended ceiling mount kit or installation of the ceiling mount kit in an improper location.
- When the projector is mounted on the ceiling, images may appear darker than those projected in the case of tabletop mounting. This isn't a product malfunction.

 **Be sure to use this projector at an altitude of less than 1500 meters.**

## Obtaining a preferred projected image size

The distance from the projector lens to the screen, the zoom setting (if available), and the video format each factors in the projected image size.

4:3 is the native aspect ratio of this projector. To be able to project a complete 16:9 (widescreen) aspect ratio image, the projector can resize and scale a widescreen image to the projector's native aspect width. This will result in a proportionally smaller height equivalent to 75% of the projector's native aspect height.

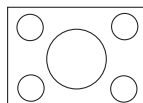

4:3 aspect image in a 4:3 aspect display area

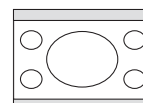

16:9 aspect image scaled to a 4:3 aspect display area

---

Thus, a 16:9 aspect image will not utilize 25% of the height of a 4:3 aspect image displayed by this projector. This will be seen as darkened (unlit) bars along the top and bottom (vertical 12.5% height respectively) of the 4:3 projection display area whenever displaying a scaled 16:9 aspect image in the vertical center of the 4:3 projection display area.

The projector should always be placed horizontally level (like flat on a table), and positioned directly perpendicular (90° right-angle square) to the horizontal center of the screen. This prevents image distortion caused by angled projections (or projecting onto angled surfaces).

The modern digital projector does not project directly forward (like older style reel-to-reel film projectors did). Instead, digital projectors are designed to project at a slightly upward angle above the horizontal plane of the projector. This is so that they can be readily placed on a table and will project forward and upwards onto a screen positioned so that the bottom edge of the screen is above the level of the table (and everyone in the room can see the screen).

You can see from the diagram on page 13, that this type of projection causes the bottom edge of the projected image to be vertically offset from the horizontal plane of the projector.

If the projector is positioned further away from the screen, the projected image size increases, and the vertical offset also increases proportionately.

When determining the position of the screen and projector, you will need to account for both the projected image size and the vertical offset dimension, which are directly proportional to the projection distance.

#### **When fine streaks are seen on projected images**

This is due to interference with the screen surface and is not a mal-function. Replace the screen or displace the focus a little.

### **How to determine the position of the projector for a given screen size**

1. Determine the aspect ratio of your screen, 16:9 or 4:3. If you have a 4:3 screen, refer to the table labeled "**Standard**". If you have a 16:9 screen, refer to the table labeled "**(16:9)**".
2. Select your screen size.
3. Refer to the table and find the closest match to your screen size in the left columns labeled "**Screen**". Using this value, look across this row to the right to find the corresponding average distance from screen value in the column labeled "**Distance from the screen: L**". This is the projection distance.
4. On that same row, look across to the right column and make note of the "**Hd**" value. This will determine the final vertical offset placement of the projector in relation to the edge of the screen.
5. The recommended position for the projector is aligned perpendicular to the horizontal center of the screen, at the distance from the screen determined in step 3 above, and offset by the value determined in step 4 above.

For example, if you are using a 4:3 aspect ratio, 100-inch screen, distance from the screen is 3.8 m and with a vertical offset of 15 cm at Zoom position wide.

If you place the projector in a different position (to that recommended), you will have to tilt it down or up to center the image on the screen. In these situations, some image distortion will occur. Use the Keystone function to correct the distortion. See "**Correcting keystone**" on page 24 for details.

### **How to determine the recommended screen size for a given distance**

This method can be used for situations where you have purchased this projector and would like to know what screen size will fit in your room.

The maximum screen size is limited by the physical space available in your room.

1. Measure the distance between the projector and where you want to position the screen. This is the projection distance.
2. Refer to the table "**Standard**" or "**(16:9)**", and find the closest match to your measurement in the distance from the screen column. If the min and max values are available on the table, check that your measured distance is between the min and max distances listed on either side of the average distance value.
3. Using this value, look across that row to the left to find the corresponding "**Screen**". That is the projected image size of the projector at that projection distance.
4. On that same row, look across to the right column and make note of the "**Hd**" value. This will determine the final placement of the screen in relation to the horizontal plane of the projector.

For example, if your measured projection distance was 4.0 m and your screen aspect ratio is 4:3, the closest match in the "**Distance from the screen: L**" column is from 3.8 m to 4.2 m. Looking across this row shows that a 100-inch screen is required.

# Layout of the projector

Image size varies depending on the distance between the screen and the projector.

## Front projection

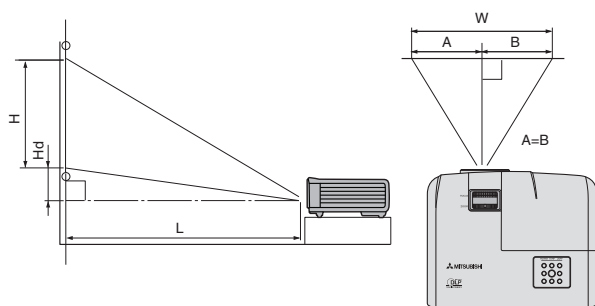

L: Between the screen and the front edge of the projector  
H: Height of the projected image

(Standard)

Screen				Distance from the screen: L						Hd	
Diagonal Size		Width: W		Height: H		Shortest (Wide)		Longest (Tele)			
inch	cm	inch	cm	inch	cm	inch	m	inch	m	inch	cm
40	102	32	81	24	61	60	1.5	66	1.7	2	6
60	152	48	122	36	91	90	2.3	99	2.5	4	9
80	203	64	163	48	122	120	3.0	132	3.4	5	12
100	254	80	203	60	152	150	3.8	165	4.2	6	15
150	381	120	305	90	229	225	5.7	247	6.3	9	23
200	508	160	406	120	305	300	7.6	330	8.4	12	30
250	635	200	508	150	381	375	9.5	412	10.5	15	38
300	762	240	610	180	457	450	11.4	-	-	18	46

(16:9)

Screen				Distance from the screen: L						Hd	
Diagonal Size		Width: W		Height: H		Shortest (Wide)		Longest (Tele)			
inch	cm	inch	cm	inch	cm	inch	m	inch	m	inch	cm
40	102	35	89	20	50	66	1.7	73	1.9	6	15
60	152	52	133	29	75	99	2.5	109	2.8	9	22
80	203	70	177	39	100	132	3.4	146	3.7	12	30
100	254	87	221	49	125	166	4.2	182	4.6	15	37
150	381	131	332	74	187	248	6.3	273	6.9	22	56
200	508	174	443	98	249	331	8.4	364	9.3	29	75
250	635	218	553	123	311	414	10.5	455	11.6	37	93
275	699	240	609	135	342	455	11.6	-	-	40	103

 The above figures are approximate and may be slightly different from the actual measurements. Mitsubishi recommends that if you intend to permanently install the projector, you should physically test the projection size and distance using the actual projector in suit before you permanently install it, so as to make allowance for this projector's optical characteristics. This will help you determine the exact mounting position so that it best suits your installation location.

# Connection

When connecting a signal source to the projector, be sure to:

1. Turn all equipment off before making any connections.
2. Use the correct signal cables for each source.
3. Ensure the cables are firmly inserted.



- See the owner's guide of each device for details about its connections.
- Contact your dealer for details about its connections.
- In the connections shown below, some cables may not be included with the projector. They are commercially available from electronics stores.

## Connecting a computer or monitor

### Connecting a computer

The projector provides a RGB input socket that allows you to connect it to both IBM® compatibles and Macintosh® computers. A Mac adapter is needed if you are connecting legacy version Macintosh computers.

#### To connect the projector to a notebook or desktop computer:

1. Take the supplied RGB cable and connect one end to the D-Sub output socket of the computer.
2. Connect the other end of the RGB cable to the **COMPUTER-1** or **COMPUTER-2** signal input socket of the projector.
3. If you wish to make use of the projector speaker in your presentations, take a suitable audio cable and connect one end of the cable to the audio output jack of the computer, and the other end to the **AUDIO IN** jack of the projector.
4. If you wish, you can use another suitable audio cable and connect one end of the cable to the **AUDIO OUT** jack of the projector, and the other end to your external speakers (not supplied).

Once connected, the audio can be controlled by the projector On-Screen Display (OSD) menus. See "[Adjusting the sound](#)" on page 30 for details.

The final connection path should be like that shown in the following diagram:

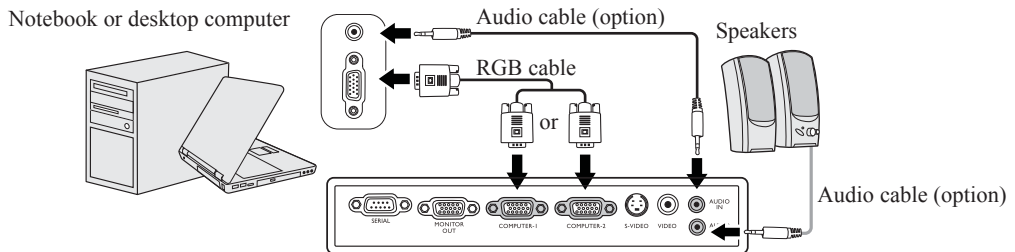

Many notebooks do not turn on their external video ports when connected to a projector. Usually a key combo like FN + F3 or CRT/LCD key turns the external display on/off. Locate a function key labeled CRT/LCD or a function key with a monitor symbol on the notebook. Press FN and the labeled function key simultaneously. Refer to your notebook's documentation to find your notebook's key combination.



- When you use a longer RGB cable instead of the provided cable, the image may not be projected correctly.
- Some computers require additional connectors or analog RGB output adapters to be connected with this projector.

## Connecting a monitor

If you want to view your presentation close-up on a monitor as well as on the screen, you can connect the **MONITOR OUT** signal output jack on the projector to an external monitor following the instructions below:

### To connect the projector to a monitor:

1. Connect the projector to a computer as described in "[Connecting a computer](#)" on page 14.
2. Connect the RGB cable from the monitor to the **MONITOR OUT** jack of the projector.

Notebook or desktop computer

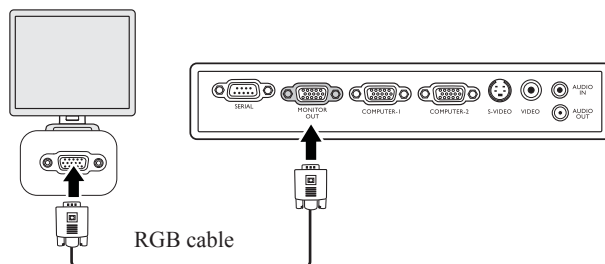

- The D-Sub output only works when an appropriate D-Sub input is made to the **COMPUTER-1** jack.
- Images may not be displayed correctly depending on the type of the input signal. See the instruction manual of the monitor.
- Images may not be displayed correctly depending on the type of the cable.

## Connecting Video source devices

You can connect your projector to various Video source devices that provide any one of the following output sockets:

- Component Video
- S-Video
- Video (composite)

You need only connect the projector to a Video source device using just one of the above connecting methods, however each provides a different level of video quality. The method you choose will most likely depend upon the availability of matching terminals on both the projector and the Video source device as described below:

Digital TV tuner and DVD players output Component Video natively, so if available on your devices, this should be your connection method of choice in preference to (composite) Video. See "[Connecting a Component Video source device](#)" on page 16 for how to connect the projector to a component video device.

If you have both composite Video and S-Video output terminals on your Video source device, you should elect to use the S-Video option. See "[Connecting an S-Video source device](#)" on page 17 for how to connect the projector to an S-Video device.

If you have only composite Video output terminals on your Video source device, connect to Composite Video input. See "[Connecting a composite Video source device](#)" on page 18 for how to connect the projector to a composite Video device.

## Connecting a Component Video source device

Examine your Video source device to determine if it has a set of unused Component Video output sockets available:

- If so, you can continue with this procedure.
- If not, you will need to reassess which method you can use to connect to the device.

### To connect the projector to a Component Video source device:

1. Take a Component Video to RGB (D-Sub) adaptor cable and connect the end with 3 RCA type connectors to the Component Video output sockets of the Video source device. Match the color of the plugs to the color of the sockets; green to green, blue to blue, and red to red.
2. Connect the other end of the Component Video to RGB (D-Sub) adaptor cable (with a D-Sub type connector) to the **COMPUTER-1** or **COMPUTER-2** socket on the projector.
3. If you wish to make use of the projector speaker in your presentations, take a suitable audio cable and connect one end of the cable to the audio output jack of the computer, and the other end to the **AUDIO IN** jack of the projector.
4. If you wish, you can use another suitable audio cable and connect one end of the cable to the **AUDIO OUT** jack of the projector, and the other end to your external speakers (not supplied).

Once connected, the audio can be controlled by the projector On-Screen Display (OSD) menus. See "[Adjusting the sound](#)" on page 30 for details.

The final connection path should be like that shown in the following diagram:

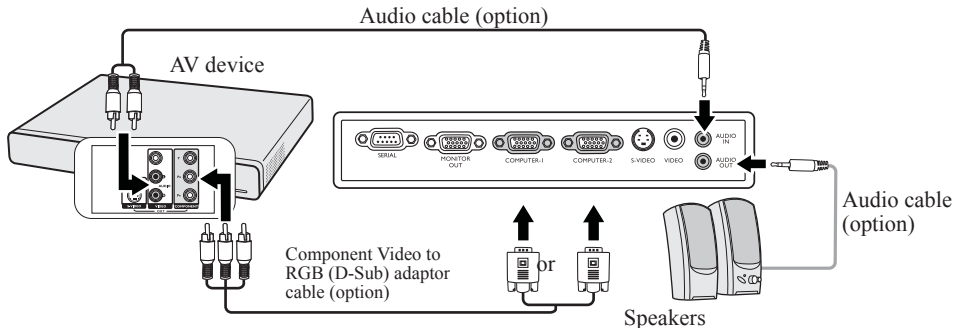

**If the selected video image is not displayed after the projector is turned on and the correct video source has been selected, check that the Video source device is turned on and operating correctly. Also check that the signal cables have been connected correctly.**



## Connecting an S-Video source device

Examine your Video source device to determine if it has an unused S-Video output socket available:

- If so, you can continue with this procedure.
- If not, you will need to reassess which method you can use to connect to the device.

### To connect the projector to an S-Video source device:

1. Take an S-Video cable and connect one end to the S-Video output socket of the Video source device.
2. Connect the other end of the S-Video cable to the **S-VIDEO** socket on the projector.
3. If you wish to make use of the projector speaker in your presentations, take a suitable audio cable and connect one end of the cable to the audio output jack of the computer, and the other end to the **AUDIO IN** jack of the projector.
4. If you wish, you can use another suitable audio cable and connect one end of the cable to the **AUDIO OUT** jack of the projector, and the other end to your external speakers (not supplied).

Once connected, the audio can be controlled by the projector On-Screen Display (OSD) menus. See "[Adjusting the sound](#)" on page 30 for details.

The final connection path should be like that shown in the following diagram:

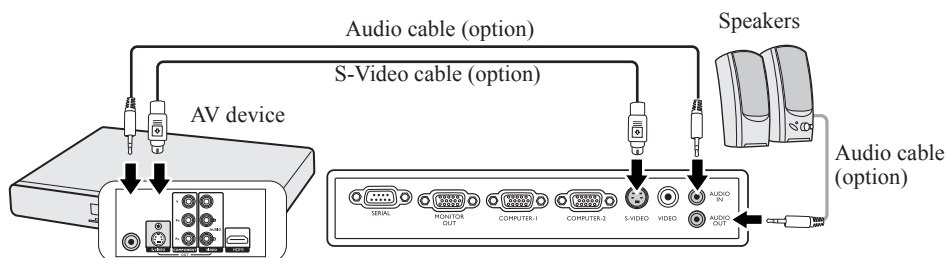

- If the selected video image is not displayed after the projector is turned on and the correct video source has been selected, check that the Video source device is turned on and operating correctly. Also check that the signal cables have been connected correctly.
- If you have already made a Component Video connection between the projector and this S-Video source device, you need not connect to this device using an S-Video connection as this makes an unnecessary second connection of poorer picture quality. See "[Connecting Video source devices](#)" on page 15 for details.

## Connecting a composite Video source device

Examine your Video source device to determine if it has a set of unused composite Video output sockets available:

- If so, you can continue with this procedure.
- If not, you will need to reassess which method you can use to connect to the device.

### To connect the projector to a composite Video source device:

1. Take a Video cable and connect one end to the composite Video output socket of the Video source device.
2. Connect the other end of the Video cable to the **VIDEO** socket on the projector.
3. If you wish to make use of the projector speaker in your presentations, take a suitable audio cable and connect one end of the cable to the audio output jack of the computer, and the other end to the **AUDIO IN** jack of the projector.
4. If you wish, you can use another suitable audio cable and connect one end of the cable to the **AUDIO OUT** jack of the projector, and the other end to your external speakers (not supplied).

Once connected, the audio can be controlled by the projector On-Screen Display (OSD) menus. See "[Adjusting the sound](#)" on page 30 for details.

The final connection path should be like that shown in the following diagram:

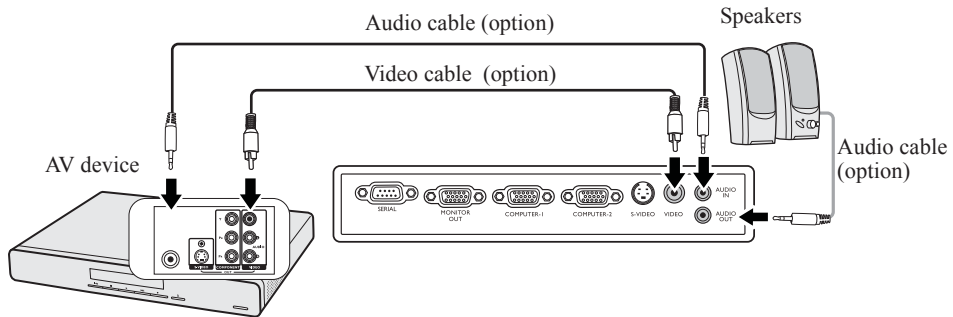

- If the selected video image is not displayed after the projector is turned on and the correct video source has been selected, check that the Video source device is turned on and operating correctly. Also check that the signal cables have been connected correctly.
- You need only connect to this device using a composite Video connection if Component Video and S-Video inputs are unavailable for use. See "[Connecting Video source devices](#)" on page 15 for details.

## Starting up the projector

1. Plug the power cord into the projector and into a wall socket. Turn on the wall socket switch (where fitted). Check that the **POWER indicator light** on the projector lights orange after power has been applied.



- **Ask your installation specialist to provide an Earth leakage breaker. When you do not use the projector, be sure to shut down the main power by the breaker.**
  - **Please use the original accessories (e.g. power cord) only with the device to avoid possible dangers such as electric shock and fire.**
  - **In order to ensure the safety in case of trouble with the projector, use an electrical outlet having an earth leakage breaker to supply the power to the projector. If you do not have such outlet, ask your dealer to install it.**
2. Remove the lens cap. If it is closed, it could become deformed due to the heat produced by the projection lamp.

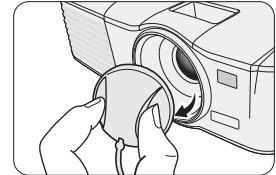
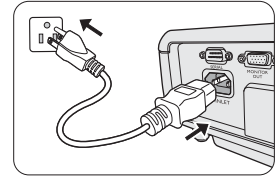

3. Press **POWER** on the projector or remote control to start the projector. The **POWER indicator light** flashes green and stays green when the projector is on.  
The start up procedure takes about 30 seconds. In the later stage of start up, a startup logo is projected.  
(If necessary) Rotate the focus ring to adjust the image clearness.

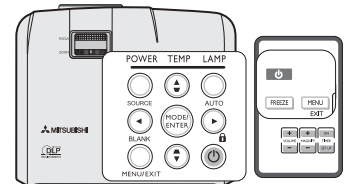

- **If the projector is still hot from previous activity, it will run the cooling fans for approximately 90 seconds before energizing the lamp.**
  - **To maintain the lamp life, once you turn the projector on, wait at least 5 minutes before turning it off.**
  - **After **POWER** is pressed, the image may flicker before the lamp becomes stable. This is not a product malfunction.**
4. If the projector is activated for the first time, select your OSD language following the on-screen instructions.
  5. If you are prompted for a password, press the arrow keys to enter a six-digit password. See "[Utilizing the password function](#)" on page 21 for details.
  6. Switch all of the connected equipment on.
  7. The projector will start to search for input signals. The current input signal being scanned appears in the upper left corner of the screen. If the projector doesn't detect a valid signal, the message '**No Signal**' will be displayed until an input signal is found.  
You can also press **SOURCE** on the projector or remote control to select your desired input signal. See "[Switching input signal](#)" on page 22 for details.



- **If the frequency/resolution of the input signal exceeds the projector's operating range, you will see the message 'Out of Range' displayed on a blank screen. Please change to an input signal which is compatible with the projector's resolution or set the input signal to a lower setting. See "[Timing chart](#)" on page 47 for details.**

## Using the menus

The projector is equipped with On-Screen Display (OSD) menus for making various adjustments and settings.

Below is the overview of the OSD menu.

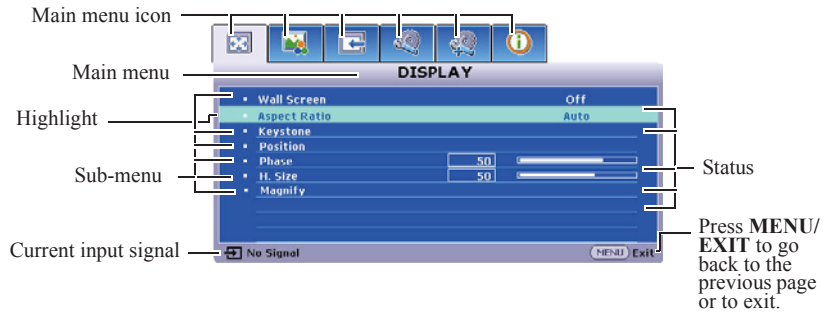

Below is an example about how to set the OSD language.

1. Press **MENU/EXIT** on the projector or remote control to turn the OSD menu on.
3. Press **▼** to highlight **Language** and press **◀/▶** to select a preferred language.

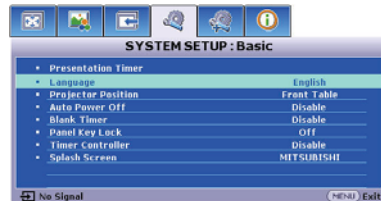

2. Use **◀/▶** to highlight the **SYSTEM SETUP: Basic** menu.
4. Press **MENU/EXIT** twice\* on the projector or remote control to leave and save the settings.  
\*The first press leads you back to the main menu and the second press closes the OSD menu.

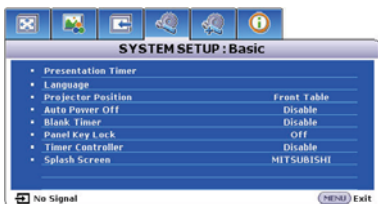

## Utilizing the password function

For security purposes and to help prevent unauthorized use, the projector includes an option for setting up password security. The password can be set through the On-Screen Display (OSD) menu. For details of the OSD menu operation, please refer to "Using the menus" on page 20.

 You will be inconvenienced if you activate the power-on lock functionality and subsequently forget the password. Print out this manual (if necessary) and write the password you used in this manual, and keep the manual in a safe place for later recall.

### Setting a password

 Once a password has been set, the projector cannot be used unless the correct password is entered every time the projector is started.

1. Open the OSD menu and go to the **SYSTEM SETUP: Advanced > Security Settings** menu. Press **MODE/ENTER**. The **Security Settings** page is displayed.
2. Highlight **Power on lock** and select **On** by pressing **◀/▶**.
3. As pictured to the right, the four arrow keys (**▲**, **▶**, **▼**, **◀**) respectively represent 4 digits (1, 2, 3, 4). According to the password you desire to set, press the arrow keys to enter six digits for the password.
4. Confirm the new password by re-entering the new password. Once the password is set, the OSD menu returns to the **Security Settings** page.

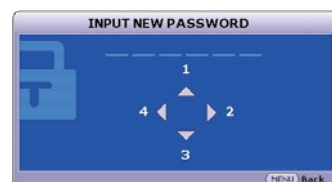

 The digits being input will be displayed as asterisks on-screen. Write your selected password down here in this manual in advance or right after the password is entered so that it is available to you should you ever forget it.

Password: \_\_\_\_\_

Keep this number in a safe place.

5. To leave the OSD menu, press **MENU/EXIT**.

### If you forget the password

If the password function is activated, you will be asked to enter the six-digit password every time you turn on the projector. If you enter the wrong password, the password error message as pictured to the right is displayed lasting for three seconds, and the message 'INPUT PASSWORD' follows. You can retry by entering another six-digit password, or if you did not record the password in this manual, and you absolutely do not remember it, you can use the password recall procedure. See "Entering the password recall procedure" on page 21 for details.

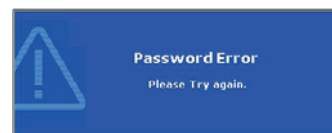

If you enter an incorrect password 5 times in succession, the projector will automatically shut down in a short time.

### Entering the password recall procedure

1. Press and hold **AUTO** on the projector or remote control for 3 seconds when the message 'INPUT PASSWORD' is displayed. The projector will display a coded number on the screen.
2. Write down the number and turn off your projector.
3. Please obtain a password using the Mitsubishi Password Decoder Software Operation Manual included in this CD.



### Changing the password

1. Open the OSD menu and go to the **SYSTEM SETUP: Advanced > Security Settings > Change password** menu.
2. Press **MODE/ENTER**. The message 'INPUT CURRENT PASSWORD' is displayed.
3. Enter the old password.
  - If the password is correct, another message 'INPUT NEW PASSWORD' is displayed.
  - If the password is incorrect, the password error message is displayed lasting for three seconds, and the message 'INPUT CURRENT PASSWORD' is displayed for your retry. You can press **MENU/EXIT** to cancel the change or try another password.
4. Enter a new password.

 The digits being input will be displayed as asterisks on-screen. Write your selected password down here in this manual in advance or right after the password is entered so that it is available to you should you ever forget it.

Password: \_\_\_\_\_

Keep this number in a safe place.

5. Confirm the new password by re-entering the new password.
6. You have successfully assigned a new password to the projector. Remember to enter the new password next time the projector is started.
7. To leave the OSD menu, press **MENU/EXIT**.

## Disabling the password function

To disable password protection, go back to the **SYSTEM SETUP: Advanced > Security Settings > Power on lock** menu after opening the OSD menu system. Select **Off** by pressing **◀ / ▶**. The message 'INPUT PASSWORD' is displayed. Enter the current password.

- If the password is correct, the OSD menu returns to the **Security Settings** page with 'Off' shown in the row of **Power on lock**. You will not have to enter the password next time you turn on the projector.
- If the password is incorrect, the password error message is displayed lasting for three seconds, and the message 'INPUT PASSWORD' is displayed for your retry. You can press **MENU/EXIT** to cancel the change or try another password.

 Though the password function is disabled, you need to keep the old password in hand should you ever need to re-activate the password function by entering the old password.

## Switching input signal

The projector can be connected to multiple devices at the same time. However, it can only display one full screen at a time.

Be sure the **Quick Auto Search** function in the **SOURCE** menu is **On** (which is the default of this projector) if you want the projector to automatically search for the signals.



You can also manually cycle through the available input signals.

1. Press **SOURCE** on the projector or remote control. A source selection bar is displayed.
2. Press **▲ / ▼** until your desired signal is selected and press **MODE/ENTER**.

Once detected, the selected source information will be displayed on the screen for seconds. If there is multiple equipment connected to the projector, repeat steps 1-2 to search for another signal.

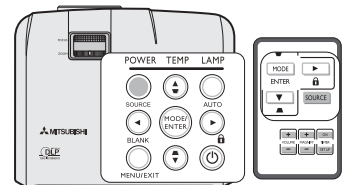
-  • The brightness level of the projected image will change accordingly when you switch between different input signals. Data (graphic) "PC" presentations using mostly static images are generally brighter than "Video" using mostly moving images (movies).
- The input signal type effects the options available for the Setting. See "[Selecting a picture mode](#)" on page 26 for details.
- The native display resolution of this projector is in a 4:3 aspect ratio. For best display picture results, you should select and use an input signal which outputs at this resolution. Any other resolutions will be scaled by the projector depending upon the 'aspect ratio' setting, which may cause some image distortion or loss of picture clarity. See "[Selecting the aspect ratio](#)" on page 25 for details.



	Computer1/YPbPr1
	Computer2/YPbPr2
	Video
	S-Video

# Adjusting the projected image

## Adjusting the projection angle

The projector is equipped with 1 quick-release adjuster foot and 1 rear adjuster foot. These adjusters change the image height and projection angle. To adjust the projector:

1. Press the quick-release button and lift the front of the projector. Once the image is positioned where you want it, release the quick-release button to lock the foot in position.
2. Screw the rear adjuster foot to fine tune the horizontal angle.

To retract the foot, hold up the projector while pressing the quick-release button, then slowly lower the projector. Screw the rear adjuster foot in a reverse direction.

If the projector is not placed on a flat surface or the screen and the projector are not perpendicular to each other, the projected image becomes trapezoidal. To correct this situation, see "[Correcting keystone](#)" on page 24 for details.

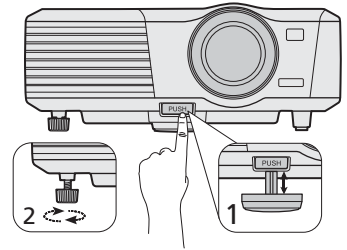

- ⚠ • Do not look into the lens while the lamp is on. The strong light from the lamp may cause damage to your eyes.
- Be careful when you press the adjuster button as it is close to the exhaust vent where hot air comes from.

## Auto-adjusting the image

In some cases, you may need to optimize the picture quality. To do this, press **AUTO** on the projector or remote control. Within 3 seconds, the built-in Intelligent Auto Adjustment function will re-adjust the values of Frequency and Clock to provide the best picture quality.

The current source information will be displayed in the upper left corner of the screen for 3 seconds.

- ☞ • The screen will be blank while **AUTO** is functioning.
- This function is only available when a PC signal (analog RGB) is selected.

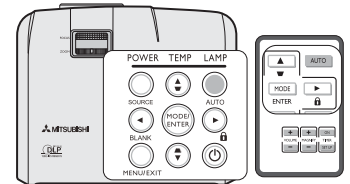

## Fine-tuning the image size and clarity

In the right figure, (A) Focus Ring, (B) Zoom Ring

1. Adjust Zoom. (using (B) Zoom Ring)
2. For the short distance/large screen, dial the ring fully to Wide end.  
For the long distance/small screen, dial the ring fully to Tele end.
3. Adjust Focus. (using (A) Focus Ring)
4. Move the product back and forth to adjust the screen size.
5. Adjust Focus again if necessary.

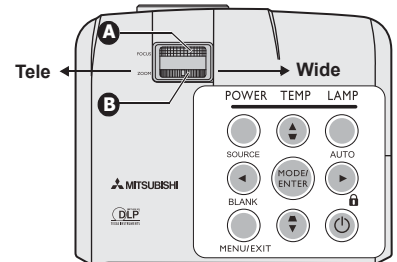

## Correcting keystone

Keystoning refers to the situation where the projected image is noticeably wider at either the top or bottom. It occurs when the projector is not perpendicular to the screen.

To correct this, besides adjusting the height of the projector, you will need to manually correct it following one of these steps.

- Using the remote control

Press **▼/▲** on the projector or remote control to display the Keystone correction page. Press **▼** to correct keystoning at the top of the image. Press **▲** to correct keystoning at the bottom of the image.

- Using the OSD menu

- Press **MENU/EXIT** and then press **◀/▶** until the **DISPLAY** menu is highlighted.
- Press **▼** to highlight **Keystone** and press **MODE/ENTER**. The **Keystone** correction page is displayed.
- Press **▼** to correct keystoning at the top of the image or press **▲** to correct keystoning at the bottom of the image.

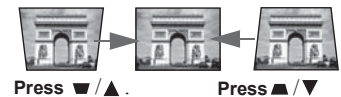
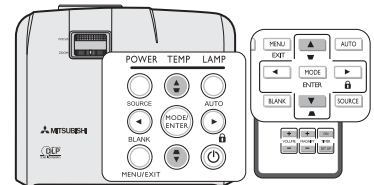

- !** You can correct the vertical keystones. However, their adjustment ranges are limited in such correction.
- When the keystone adjustment is carried out, the adjustment value is indicated. Note that this value doesn't mean a projection angle.
- The allowable range of the adjustment value in the keystone adjustment varies depending on the installation conditions.
- Images may not be projected in a shape of a regular rectangle or with its aspect ratio 4:3, depending on the installation conditions of the projector and the screen.
- When the keystone adjustment takes effect, the resolution decreases. In addition, stripes may appear or straight lines may bend in images with complicated patterns. They are not due to product malfunctions.
- Noise may appear on the screen during the keystone adjustment because of the type of the video signal being projected and the setting values of the keystone adjustment. In such cases, set the keystone adjustment values in the range where the image is displayed without noise.
- When the keystone adjustment is carried out, the image may not be displayed correctly because of the type of input signal.

## Magnifying and searching for details

If you need to find the details on the projected picture, magnify the picture. Use the direction arrow keys for navigating the picture.

- Using the remote control
- Press **MAGNIFY +/-** to display the Zoom bar.
  - Press **MAGNIFY +** to magnify the center of the picture. Press the key repeatedly until the picture size is suitable for your need.
  - Use the directional arrows (**▲**, **▼**, **◀**, **▶**) on the projector or remote control to navigate the picture.
  - To restore the picture to its original size, press **AUTO**. You can also press **MAGNIFY -**. When the key is pressed again, the picture is further reduced until it is restored to the original size.

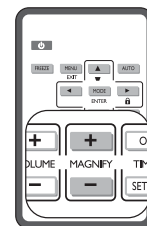

- Using the OSD menu

- Press **MENU/EXIT** and then press **◀/▶** until the **DISPLAY** menu is highlighted.
- Press **▼** to highlight **Magnify** and press **MODE/ENTER**. The Zoom bar is displayed.
- Repeat steps 2-4 in the section of "Using the remote control" above. Or if you are using the projector control panel, continue to the following steps.
- Press **▲** on the projector repeatedly to magnify the picture to a desired size.
- To navigate the picture, press **MODE/ENTER** to switch to the panning mode and press the directional arrows (**▲**, **▼**, **◀**, **▶**) to navigate the picture.
- Use the directional arrows (**▲**, **▼**, **◀**, **▶**) on the projector or remote control to navigate the picture.
- To reduce size of the picture, press **MODE/ENTER** to switch back to the zoom in/out functionality, and press **AUTO** to restore the picture to its original size. You can also press **▼** repeatedly until it is restored to the original size.

**⌂** The picture can only be navigated after the picture is magnified. You can further magnify the picture while searching for details.



## Selecting the aspect ratio

The 'aspect ratio' is the ratio of the image width to the image height. Most analog TV and computers are in 4:3 ratio, which is the default for this projector, and digital TV and DVDs are usually in 16:9 ratio.

With the advent of digital signal processing, digital display devices like this projector can dynamically stretch and scale the image output to a different aspect than that of the image input signal.

To change the projected image ratio (no matter what aspect the source is):

1. Press **MENU/EXIT** and then press **◀/▶** until the **DISPLAY** menu is highlighted.
2. Press **▼** to highlight **Aspect Ratio**.
3. Press **◀/▶** to select an aspect ratio to suit the format of the video signal and your display requirements.

### About the aspect ratio

 In the pictures below, the black portions are inactive areas and the white portions are active areas. OSD menus can be displayed on those unused black areas.

1. **Auto**: Scales an image proportionally to fit the projector's native resolution in its horizontal width or its vertical height. This is suitable for the incoming image which is neither in 4:3 nor 16:9 and you want to make most use of the screen without altering the image's aspect ratio.

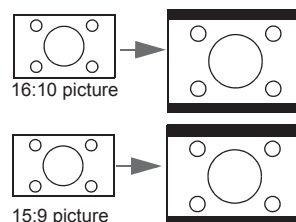

2. **Real**: The image is projected as its original resolution, and resized to fit within the display area. For input signals with lower resolutions, the projected image will display smaller than if resized to full screen. You could adjust the zoom setting or move the projector towards the screen to increase the image size if necessary. You may also need to refocus the projector after making these adjustments.

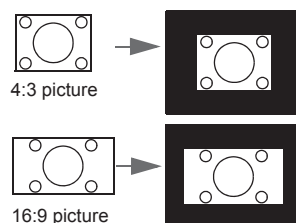

3. **4:3**: Scales an image so that it is displayed in the center of the screen with a 4:3 aspect ratio. This is most suitable for 4:3 images like computer monitors, standard definition TV and 4:3 aspect DVD movies, as it displays them without aspect alteration.

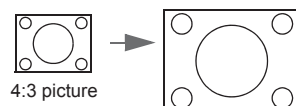

4. **16:9**: Scales an image so that it is displayed in the center of the screen with a 16:9 aspect ratio. This is most suitable for images which are already in a 16:9 aspect, like high definition TV and 16:9 aspect DVD movies, as it displays them without aspect alteration.

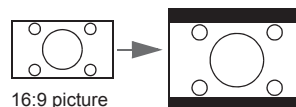

# Optimizing the image

## Selecting a picture mode

The projector is preset with several predefined picture modes so that you can choose one to suit your operating environment and input signal picture type.

To select a operation mode that suits your need, you can follow one of the following steps.

- Press **MODE/ENTER** on the remote control or projector repeatedly until your desired mode is selected.
- Go to the **PICTURE > Setting** menu and press ◀/▶ to select a desired mode.

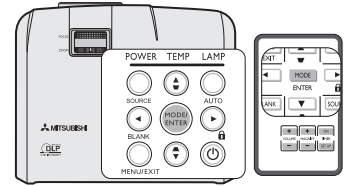

## Picture modes for different types of signals

The picture modes available for different types of signals are listed below.

1. **Brightest mode:** Maximizes the brightness of the projected image. This mode is suitable for environments where extra-high brightness is required, such as using the projector in well lit rooms.
2. **Presentation mode:** Is designed for presentations. The brightness is emphasized in this mode to match PC and notebook coloring. For Video input signals, this mode is suitable for playing gamebox-based video games in a normal living room lighting level environment.
3. **Normal mode:** Maximizes the purity of RGB colors to provide true-to-life images regardless of brightness setting. It is most suitable for viewing photos and for viewing PC graphic and drawing applications such as AutoCAD. For Video input signals, this mode is appropriate for viewing colorful movies, video clips from digital cameras or DVs.
4. **Theater mode:** Is appropriate for playing colorful movies, video clips from digital cameras or DVs through the PC input for best viewing in a blackened (little light) environment. For Video input signals, this mode is suitable for enjoying dark movies or DVD movies best viewed in a blackened (little light) home cinema or lounge room environment.
5. **User 1/User 2 mode:** Recalls the settings customized based on the current available picture modes. See "[Setting the User 1/User 2 mode](#)" on page 26 for details.

## Setting the User 1/User 2 mode

There are two user-definable modes if the current available picture modes are not suitable for your need. You can use one of the picture modes (except the **User 1/User 2**) as a starting point and customize the settings.

**User 1** is for PC sources, and **User 2** is for VIDEO sources.

1. Press **MENU/EXIT** to open the On-Screen Display (OSD) menu.
2. Go to the **PICTURE > Setting** menu.
3. Press ◀/▶ to select **User 1** to **User 2**.
4. Press ▼ to select a sub-menu item to be changed and adjust the value with ◀/▶. See "[Fine-tuning the image quality in user modes](#)" below for details.
5. When all settings have been done, highlight **Save Settings** and press **MODE/ENTER** to store the settings.
6. The confirmation message '**Setting Saved**' is displayed.

## Fine-tuning the image quality in user modes

According to the detected signal type, there are some user-definable functions available when **User 1** or **User 2** mode is selected. You can make adjustments to these functions based on your needs.

### Adjusting Brightness

Highlight **Brightness** in the **PICTURE** menu and adjust the values by pressing ◀/▶ on the projector or remote control.

The higher the value, the brighter the image. And lower the setting, darker the image. Adjust this control so the black areas of the image appear just as black and that detail in the dark areas is visible.



### Adjusting Contrast

Highlight **Contrast** in the **PICTURE** menu and adjust the values by pressing ◀/▶ on the projector or remote control.

The higher the value, the greater the contrast. Use this to set the peak white level after you have previously adjusted the **Brightness** setting to suit your selected input and viewing environment.



### Adjusting Color

Highlight **Color** in the **PICTURE** menu and adjust the values by pressing ◀/▶ on the projector or remote control.

Lower setting produces less saturated colors. If the setting is too high, colors on the image will be overpowering, which makes the image unrealistic.

### Adjusting Tint

Highlight **Tint** in the **PICTURE** menu and adjust the values by pressing ◀/▶ on the projector or remote control.

The higher the value, the more reddish the picture becomes. The lower the value, the more greenish the picture becomes.

### Adjusting Sharpness

Highlight **Sharpness** in the **PICTURE** menu and adjust the values by pressing ◀/▶ on the projector or remote control.

The higher the value, the sharper the picture becomes. The lower the value, the softer the picture becomes.

### Adjusting BrilliantColor™

Highlight **BrilliantColor™** in the **PICTURE** menu and select by pressing ◀/▶ on the projector or remote control.

This feature utilizes a new color-processing algorithm and system level enhancements to enable higher brightness while providing truer, more vibrant colors in picture. It enables a greater than 50% brightness increase in mid-tone images, which are common in video and natural scenes, so the projector reproduces images in realistic and true colors. If you prefer images with that quality, select **On**. If you don't need it, select **Off**.

**On** is the default and recommended selection for this projector. When **Off** is selected, the **Color Temperature** function is not available.

### Selecting a Color Temperature

Highlight **Color Temperature** in the **PICTURE** menu and adjust the values by pressing ◀/▶ on the projector or remote control.

The options available for color temperature\* settings vary according to the signal type selected.

1. **T1:** With the highest color temperature, T1 makes the image appear the most bluish white than other settings.
2. **T2:** Makes images appear bluish white.
3. **T3:** Maintains normal colorings for white.
4. **T4:** Makes images appear reddish white.

#### \*About color temperatures:

There are many different shades that are considered to be "white" for various purposes. One of the common methods of representing white color is known as the "color temperature". A white color with a low color temperature appears to be reddish white. A white color with a high color temperature appears to have more blue in it.

## 3D Color Management

In most installation situations, color management will not be necessary, such as in classroom, meeting room, or lounge room situations where lights remain on, or where building external windows allow daylight into the room.

Only in permanent installations with controlled lighting levels such as boardrooms, lecture theaters, or home theaters, should color management be considered. Color management provides fine color control adjustment to allow for more accurate color reproduction, should you require it.

Proper color management can only be achieved under controlled and reproducible viewing conditions. You will need to use a colorimeter (color light meter), and provide a set of suitable source images to measure color reproduction. These tools are not provided with the projector, however, your projector supplier should be able to provide you with suitable guidance, or even an experienced professional installer.

The Color Management provides six sets (RGBCMY) of colors to be adjusted. When you select each color, you can independently adjust its range and saturation according to your preference.

If you have purchased a test disc which contains various color test patterns and can be used to test the color presentation on monitors, TVs, projectors, etc. You can project any image from the disc on the screen and enter the **3D Color Management** menu to make adjustments.

To adjust the settings:

1. Go to the **PICTURE** menu and highlight **3D Color Management**.
2. Press **MODE/ENTER** and the **3D Color Management** page is displayed.
3. Highlight **Primary Color** and press **◀/▶** to select a color from among Red, Green, Blue, Cyan, Magenta, or Yellow.
4. Press **▼** to highlight **Hue** and press **◀/▶** to select its range. Increase in the range will include colors consisted of more proportions of its two adjacent colors.  
Please refer to the illustration to the right for how the colors relate to each other.  
For example, if you select Red and set its range at 0, only pure red in the projected picture will be selected. Increasing its range will include red close to yellow and red close to magenta.
5. Press **▼** to highlight **Saturation** and adjust its values to your preference by pressing **◀/▶**. Every adjustment made will reflect to the image immediately.  
For example, if you select Red and set its value at 0, only the saturation of pure red will be affected.
6. Press **▼** to highlight **Gain** and adjust its values to your preference by pressing **◀/▶**. The contrast level of the primary color you select will be affected. Every adjustment made will reflect to the image immediately.
7. Repeat steps 3 to 6 for other color adjustments.
8. Make sure you have made all of the desired adjustments.
9. Press **MENU/EXIT** to exit and save the settings.

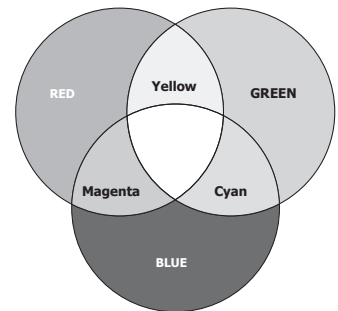

 **Saturation is the amount of that color in a video picture. Lower settings produce less saturated colors; a setting of “0” removes that color from the image entirely. If the saturation is too high, that color will be overpowering and unrealistic.**

## Using Wall Screen

In the situation where you are projecting onto a colored surface such as a painted wall which may not be white, the **Wall Screen** feature can help correct the projected picture's color to prevent possible color difference between the source and projected pictures.

To use this function, go to the **DISPLAY > Wall Screen** menu and press **◀/▶** to select a color which is the closest to the color of the projection surface. There are several recalibrated colors to choose from: **Light Yellow, Pink, Light Green, Blue, and Blackboard**.

## Setting the presentation timer

The presentation timer can indicate the presentation time on the screen to help you achieve better time management when giving presentations. Follow these steps to utilize this function:

1. Press **TIMER SET UP** on the remote control or go to the **SYSTEM SETUP: Basic > Presentation Timer** menu and press **MODE/ENTER** to display the **Presentation Timer** page.
2. Press **▼** to highlight **Timer period** and decide the timer period by pressing **◀/▶**. The length of time can be set from 1 to 5 minutes in 1-minute increments and 5 to 240 minutes in 5-minute increments.

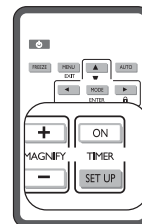

**☞** If the timer is already on, the timer will restart whenever the Timer period is reset.

3. Press **▼** to highlight **Timer display** and choose if you want the timer to show up on the screen by pressing **◀/▶**.

Selection	Description
Always	Displays the timer on screen throughout the presentation time.
1 min/2 min/3 min	Displays the timer on screen in the last 1/2/3 minute(s).
Never	Hides the timer throughout the presentation time.

4. Press **▼** to highlight **Timer position** and set the timer position by pressing **◀/▶**.

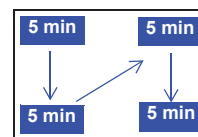

5. Press **▼** to highlight **Timer counting direction** and select your desired counting direction by pressing **◀/▶**.

Selection	Description
<b>Count Up</b>	Increases from 0 to the preset time.
<b>Count Down</b>	Decrease from the preset time to 0.

6. Press **▼** to highlight **Sound reminder** and decide if you want to activate sound reminder by pressing **◀/▶**. If you select **On**, a double beep sound will be heard at the last 30 seconds of counting down/up, and a triple beep sound will be produced when the timer is up.
7. To activate the presentation timer, press **▼** and press **◀/▶** to select **On** and press **MODE/ENTER**.
8. A confirmation message is displayed. Highlight **Yes** and press **MODE/ENTER** to confirm. You will see the message "**Timer is On**" appearing on the screen. The timer starts counting once the timer is turned on.

**☞** If you switch input signal or press **AUTO** when the timer is on, the timer will be stopped.

### To cancel the timer, perform the following steps.

1. Go back to the **Presentation Timer** page.
2. Press **▼** and press **◀/▶** to highlight **Off** and press **MODE/ENTER**. A confirmation message is displayed.
3. Highlight **Yes** and press **MODE/ENTER** to confirm. You will see the message "**Timer is Off**" appearing on the screen.

### How to use the **TIMER On** key?

**TIMER ON** is a multi-functional key.

- If the presentation timer is off, pressing this key displays a confirmation message. You can decide whether to activate the timer or not by following the on-screen instruction.
- If the timer is already on, pressing this key displays a confirmation message. You can decide whether to restart, continue or turn off the timer by following the on-screen instruction.

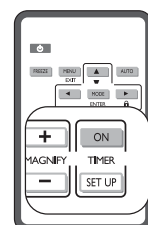

## Hiding the image

In order to draw the audience's full attention to the presenter, you can use **BLANK** on the projector or remote control to hide the screen image. Press any key on the projector or remote control to restore the image. The word '**BLANK**' appears at the lower right corner of the screen while the image is hidden.

You can set the blank time in the **SYSTEM SETUP: Basic > Blank Timer** menu to let the projector return the image automatically after a period of time when there is no action taken on the blank screen.

Once **BLANK** is pressed, the projector enters **Low mode** automatically.

Do not block the projection lens from projecting as this could cause the blocking object to become heated and deformed or even cause a fire.

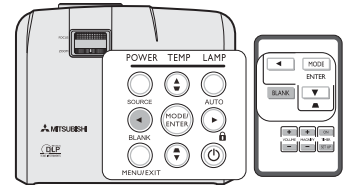

## Locking control keys

With the control keys on the projector locked, you can prevent your projector settings from being changed accidentally (by children, for example). When the **Panel Key Lock** is on, no control keys on the projector will operate except **POWER**.

- Press **▶**  on the projector or remote control or go to the **SYSTEM SETUP: Basic > Panel Key Lock** menu, and select **On** by pressing **◀/▶** on the projector or remote control.
- A confirmation message is displayed. Select **Yes** to confirm.

To release panel key lock, press any key of the projector once to display the panel key lock warning. With the warning being displayed, press **▶**  on the projector or remote control again. (Press and hold the key on the projector for 3 seconds.)

You can also use the remote control to enter the **SYSTEM SETUP: Basic > Panel Key Lock** and press **◀/▶** to select **Off**.

- Keys on the remote control are still in use when panel key lock is enabled.
- If you press **POWER** to turn off the projector without disabling panel key lock, the projector will still be in locked status the next time it is turned on.

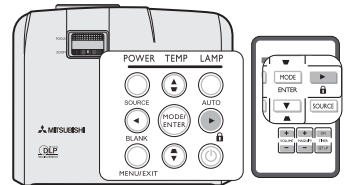

## Freezing the image

Press **FREEZE** on the remote control to freeze the image. The word '**FREEZE**' will be displayed in the upper left corner of the screen. To release the function, press any key on the projector or remote control.

Even if an image is frozen on the screen, the pictures are running on the video or other device. If the connected devices have active audio output, you will still hear the audio even though the image is frozen on screen.

Do not keep displaying a still picture for an extended period of time, as the afterimages may linger on the screen.

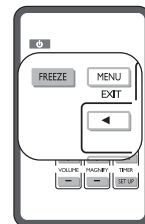

## Adjusting the sound

The sound adjustments made as below will have an effect on the projector speaker. Be sure you have made a correct connection to the projector audio input. See "[Connection](#)" on page 14 for how the audio input is connected.

### Muting the sound

To temporarily turn off the sound:

- Press **MENU/EXIT** and then press **◀/▶** until the **SYSTEM SETUP: Advanced** menu is highlighted.
- Press **▼** to highlight **Audio Settings** and press **MODE/ENTER**. The **Audio Settings** page is displayed.
- Highlight **Mute** and press **◀/▶** to select **On**.

### Adjusting the sound level

To adjust the sound level, press **VOLUME +/-** on the remote control, or:

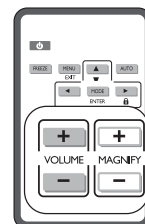

1. Repeat steps 1-2 above.
2. Press ▼ to highlight **Volume** and press ◀/▶ to select a desired sound level.

## Personalizing the projector menu display

The On-Screen Display (OSD) menus can be set according to your preferences. The following settings do not affect the projection settings, operation, or performance.

- **Menu display time** in the **SYSTEM SETUP: Advanced > Menu Settings** menu sets the length of time the OSD will remain active after your last key press. The time length ranges from 5 to 30 seconds in 5-second increments. Use ◀/▶ to select a suitable time frame.
- **Menu position** in the **SYSTEM SETUP: Advanced > Menu Settings** menu sets the OSD position in five locations. Use ◀/▶ to select a preferred position.
- **Language** in the **SYSTEM SETUP: Basic** menu sets your familiar language for the OSD menus. Use ◀/▶ to select your language.
- **Splash Screen** in the **SYSTEM SETUP: Basic** menu sets a preferred logo screen to be displayed during projector start-up. Use ◀/▶ to select a screen.

## Shutting down the projector

1. Press ⏻ **POWER** and a confirmation message displays prompting you. If you don't respond in a few seconds, the message will disappear.
2. Press ⏻ **POWER** a second time. The **POWER indicator light** flashes orange, the projection lamp shuts down, and the fans will continue to run for approximately 90 seconds to cool down the projector.
3. Once the cooling process finishes, the **POWER indicator light** is a steady orange and fans stop.
4. Disconnect the power cord from the wall socket if the projector will not be used in an extended period of time.

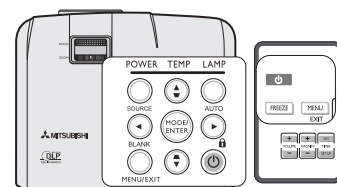

- ☞ • **To protect the lamp, the projector will not respond to any commands during the cooling process.**
- **To shorten the cooling time, you can also activate the Quick Cooling function. See "Quick Cooling" on page 36 for details.**
- **Do not unplug the power cord before the projector shutdown sequence is complete or during the 90-second cooling down process.**
- **If the projector is not properly shut down, to protect the lamp, when you attempt to re-start the projector, the fans will run for a few minutes to cool down. Press ⏻ **POWER** again to start the projector after the fans stop and the **POWER indicator light** turns orange.**

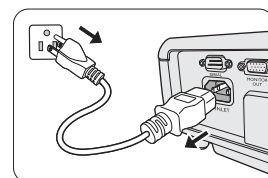

## Direct power off

1. The AC power cord can be pulled out during the projector is on. To protect the lamp, wait about 10 minutes before re-starting the projector. (When you attempt to re-start the projector, the fans may run for a few minutes to cool down. In such cases, press ⏻ **POWER** again to start the projector after the fans stop and the **POWER indicator light** turns orange.
2. To protect the lamp, do not shut down the projector while the **POWER indicator light** is blinking green after the lamp lights up.
3. Before shutting down the projector, be sure to close the menu screen. If you shut down the projector without closing the menu, the setting data of the menu may not be saved.

# Menu operation

## Menu system

Please note that the on-screen display (OSD) menus vary according to the signal type selected.

Main menu	Sub-menu	Options	
1. DISPLAY	Wall Screen	Off/Light Yellow/Pink/Light Green/Blue/Blackboard	
	Aspect Ratio	Auto/Real/4:3/16:9	
	Keystone		
	Position		
	Phase		
	H. Size		
	Magnify		
2. PICTURE	Setting	Brightest/Presentation/Normal/Theater/User 1/User 2	
	Brightness		
	Contrast		
	Color		
	Tint		
	Sharpness		
	BrilliantColor™	On/Off	
	Color Temperature	T1/T2/T3/T4	
	3D Color Management	Primary Color	R/G/B/C/M/Y
		Hue	
		Saturation	
	Gain		
Save Settings			
3. SOURCE	Quick Auto Search	On/Off	
4. SYSTEM SETUP: Basic	Presentation Timer	Timer period	1~240 minutes
		Timer display	Always/1 min/2 min/3 min/Never
		Timer position	Top-Left/Bottom-Left/Bottom-Right/Top-Right
		Timer counting direction	Count Down/Count Up
		Sound reminder	On/Off
		On/Off	
	Language	English / Français / Deutsch / Italiano / Español / Русский / 繁體中文 / 简体中文 / 日本語 / 한국어 / Svenska / Türkçe / Čeština / Português / العربية / Polski / Magyar / العربية	





<b>4. SYSTEM SETUP: Basic</b>	<b>Projector Position</b>	Front Table/Rear Table/Rear Ceiling/ Front Ceiling	
	<b>Auto Power Off</b>	Disable/5 min/10 min/15 min/20 min/25 min/30 min	
	<b>Blank Timer</b>	Disable/5 min/10 min/15 min/20 min/25 min/30 min	
	<b>Panel Key Lock</b>	On/Off	
	<b>Timer Controller</b>	Disable/30 min/1 hr/2 hr/3 hr/4 hr/8 hr/12 hr	
	<b>Splash Screen</b>	Black/Blue/MITSUBISHI	
	<b>Quick Cooling</b>	On/Off	
<b>5. SYSTEM SETUP: Advanced</b>	<b>Audio Settings</b>	<b>Mute</b>	On/Off
		<b>Volume</b>	
	<b>Menu Settings</b>	<b>Menu display time</b>	5 sec/10 sec/15 sec/20 sec/25 sec/30 sec
		<b>Menu position</b>	Center/Top-Left/Top-Right/Bottom-Right/ Bottom-Left
	<b>Lamp Settings</b>	<b>Lamp mode</b>	Standard/Low
		<b>Reset lamp timer</b>	
		<b>Equivalent lamp hour</b>	
	<b>Security Settings</b>	<b>Change password</b>	
		<b>Power on lock</b>	On/Off
	<b>Closed Caption</b>	<b>Closed Caption Enable</b>	On/Off
<b>Caption Version</b>		CC1/CC2/CC3/CC4	
<b>Reset All Settings</b>			
<b>6. INFORMATION</b>	<b>Current System Status</b>	Source Setting Resolution Color System Equivalent Lamp Hour	



Note that the menu items are available when the projector detects at least one valid signal. If there is no equipment connected to the projector or no signal detected, limited menu items are accessible.

## Description of each menu

		FUNCTION	DESCRIPTION
1. DISPLAY menu		<b>Wall Screen</b>	Corrects the projected picture's color when the projection surface is not white. See <a href="#">"Using Wall Screen" on page 28</a> for details.
		<b>Aspect Ratio</b>	There are four options to set the image's aspect ratio depending on your input signal source. See <a href="#">"Selecting the aspect ratio" on page 25</a> for details.
		<b>Keystone</b>	Corrects any keystone of the image. See <a href="#">"Correcting keystone" on page 24</a> for details.
		<b>Position</b>	Displays the position adjustment page. To move the projected image, use the directional arrow keys. The values shown on the lower position of the page change with every key press you made until they reach their maximum or minimum.
		<b>Phase</b>	Adjusts the clock phase to reduce image distortion. 
		<b>H. Size</b>	Adjusts the horizontal width of the image.
		<b>Magnify</b>	Magnifies or reduces the projected image. See <a href="#">"Magnifying and searching for details" on page 24</a> for details.

	FUNCTION	DESCRIPTION
2. PICTURE menu	<b>Setting</b>	Pre-defined picture modes are provided so you can optimize your projector image set-up to suit your program type. See "Selecting a picture mode" on page 26 for details.
	<b>Brightness</b>	Adjusts the brightness of the image. See "Adjusting Brightness" on page 27 for details.
	<b>Contrast</b>	Adjusts the degree of difference between dark and light in the image. See "Adjusting Contrast" on page 27 for details.
	<b>Color</b>	Adjusts the color saturation level -- the amount of each color in a video image. See "Adjusting Color" on page 27 for details.
	<b>Tint</b>	Adjusts the red and green color tones of the image. See "Adjusting Tint" on page 27 for details.  <b>The function is only available when Video or S-Video with NTSC system is selected.</b>
	<b>Sharpness</b>	Adjusts the image to make it look sharper or softer. See "Adjusting Sharpness" on page 27 for details.
	<b>BrilliantColor™</b>	Adjusts white peaking while maintaining correct color presentation. See "Adjusting BrilliantColor™" on page 27 for details.
	<b>Color Temperature</b>	See "Selecting a Color Temperature" on page 27 for details.
	<b>3D Color Management</b>	See "3D Color Management" on page 28 for details.
	<b>Save Settings</b>	Saves the settings made for <b>User 1</b> or <b>User 2</b> mode.
3. SOURCE menu	<b>Quick Auto Search</b>	See "Switching input signal" on page 22 for details.

	FUNCTION	DESCRIPTION
4. SYSTEM SETUP: Basic menu	<b>Presentation Timer</b>	Reminds the presenter to finish the presentation within a certain time frame. See "Setting the presentation timer" on page 29 for details.
	<b>Language</b>	Sets the language for the On-Screen Display (OSD) menus. See "Using the menus" on page 20 for details.
	<b>Projector Position</b>	See "Choosing a location" on page 11 for details.
	<b>Auto Power Off</b>	Allows the projector to turn off automatically if no input signal is detected after a set period of time. See "Setting Auto Power Off" on page 39 for details.
	<b>Blank Timer</b>	Sets the image blank time when the Blank feature is activated, once elapsed the image will return to the screen. See "Hiding the image" on page 30 for details.
	<b>Panel Key Lock</b>	Disables or enables all panel key functions except  <b>POWER</b> on the projector and keys on the remote control. See "Locking control keys" on page 30 for details.
	<b>Timer Controller</b>	Sets the auto-shutdown timer. The timer can be set to a value between 30 minutes and 12 hours.
	<b>Splash Screen</b>	Allows you to select which logo screen will be displayed during projector start-up. Three options are available: MITSUBISHI logo, Black screen, or Blue screen.
5. SYSTEM SETUP: Advanced menu	<b>Quick Cooling</b>	Selecting <b>On</b> enables the function and the projector cooling time will be shortened to a few seconds.  <b>If you attempt to restart the projector right after the quick cooling process, it may not be turned on successfully and will rerun its cooling fans.</b>
	<b>Audio Settings</b>	See "Adjusting the sound" on page 30 for details.
	<b>Menu Settings</b>	<b>Menu display time</b> Sets the length of time the OSD will remain active after your last key press. The range is from 5 to 30 seconds in 5-second increments. <b>Menu position</b> Sets the On-Screen Display (OSD) menu position.
	<b>Lamp Settings</b>	<b>Lamp mode</b> See "Setting Lamp mode as Low" on page 39 for details. <b>Reset lamp timer</b> See "Resetting the lamp timer" on page 42 for details. <b>Equivalent lamp hour</b> See "Getting to know the lamp hour" on page 39 for details on how the total lamp hour is calculated.

FUNCTION	DESCRIPTION
<b>Security Settings</b>	<p><b>Change password</b> You will be asked to enter the current password before changing to a new one.</p> <p><b>Power on lock</b> See "<a href="#">Utilizing the password function</a>" on page 21 for details.</p>
<b>Closed Caption</b>	<p><b>Closed Caption Enable</b> Activates the function by selecting <b>On</b> when the selected input signal carries closed captions.</p> <ul style="list-style-type: none"> <li>• Captions: An on-screen display of the dialogue, narration, and sound effects of TV programs and videos that are closed captioned (usually marked as "CC" in TV listings).</li> </ul> <p> <b>When the projector displays OSD or any dialog, captions are not displayed at the same time.</b></p> <p><b>Caption Version</b> Selects a preferred closed captioning mode. To view captions, select CC1, CC2, CC3, or CC4 (CC1 displays captions in the primary language in your area).</p>
<b>Reset All Settings</b>	<p>Returns all settings to the factory preset values.</p> <p> <b>The following settings will still remain: Phase, H. Size, User 1, User 2, Language, Projector Position, Security Settings.</b></p>
<b>Current System Status</b>	<p><b>Source</b> Shows the current signal source.</p> <p><b>Setting</b> Shows the selected mode in the <b>PICTURE</b> menu.</p> <p><b>Resolution</b> Shows the native resolution of the input signal.</p> <p><b>Color System</b> Shows input system format, NTSC, PAL, SECAM, or RGB.</p> <p><b>Equivalent Lamp Hour</b> Displays the number of hours the lamp has been used.</p>

5. SYSTEM SETUP:  
Advanced menu

6. INFORMATION  
menu

# Maintenance

---

## Care of the projector

Your projector needs little maintenance. The only thing you need to do on a regular basis is to keep the lens clean.

Never remove any parts of the projector except the lamp. Contact your dealer if other parts need replacing.

### Cleaning the lens

Clean the lens whenever you notice dirt or dust on the surface.

- Use a canister of compressed air to remove dust.
- If there is dirt or smears, use lens-cleaning paper or moisten a soft cloth with lens cleaner and gently wipe the lens surface.

 **Never rub the lens with abrasive materials.**

### Cleaning the projector case

Before you clean the case, turn the projector off using the proper shutdown procedure as described in "[Shutting down the projector](#)" on page 31 and unplug the power cord.

- To remove dirt or dust, wipe the case with a soft, lint-free cloth.
- To remove stubborn dirt or stains, moisten a soft cloth with water and a neutral pH detergent. Then wipe the case.

 **Never use wax, alcohol, benzene, thinner or other chemical detergents. These can damage the case.**  
**Flammable substances may ignite causing fire or breakdown while the lamp is illuminating.**

### Storing the projector

If you need to store the projector for an extended time, please follow the instructions below:

- Make sure the temperature and humidity of the storage area are within the recommended range for the projector. Please refer to "[Specifications](#)" on page 46 or consult your dealer about the range.
- Retract the adjuster feet.
- Remove the battery from the remote control.
- Pack the projector in its original packing or equivalent.

### Transporting the projector

It is recommended that you ship the projector with its original packing or equivalent.

## Getting to know the lamp hour

When the projector is in operation, the duration (in hours) of lamp usage is automatically calculated by the built-in timer. The method of calculating the equivalent lamp hour is as follows:

Total (equivalent) lamp hour  
= 1 (hours used in **Low** mode) + 4/3 (hours used in **Standard** mode)

 See "**Setting Lamp mode as Low**" below for more information on **Low** mode.

The lamp hour in **Low** mode is calculated as 3/4 of that in **Standard** mode. That is, using the projector in **Low** mode helps to extend the lamp hour by 1/3.

To obtain the lamp hour information:

1. Press **MENU/EXIT** and then press **◀/▶** until the **SYSTEM SETUP: Advanced** menu is highlighted.
2. Press **▼** to highlight **Lamp Settings** and press **MODE/ENTER**. The **Lamp Settings** page is displayed.
3. You will see the **Equivalent lamp hour** information appearing on the menu.
4. To leave the menu, press **MENU/EXIT**.

You can also get the lamp hour information on the **INFORMATION** menu.

## Extending lamp life

The projection lamp is a consumable item that normally can last up to 3000-4000 hours with proper usage. To keep the lamp life as long as possible, you can do the following settings via the OSD menu.

### Setting Lamp mode as Low

Using **Low** mode reduces system noise and power consumption by 20%. If the **Low** mode is selected, the light output will be reduced and result in darker projected pictures.

Setting the projector in **Low** mode also extends the lamp operation life. To set **Low** mode, go into the **SYSTEM SETUP: Advanced > Lamp Settings > Lamp mode** menu and press **◀/▶**.

-  • **When this mode is switched, the projected images may flicker.**
- **If this mode is frequently switched, the lamp may be deteriorated.**

### Setting Auto Power Off

This function allows the projector to turn off automatically if no input source is detected after a set period of time to prevent unnecessary waste of lamp life.





To set **Auto Power Off**, go into the **SYSTEM SETUP: Basic > Auto Power Off** menu and press **◀/▶**. The time period can be set from 5 to 30 minutes in 5-minute increments. If the preset time lengths are not suitable for your presentation, select **Disable**. The projector will not automatically shut down in a certain time period.

## Timing of replacing the lamp

When the lamp indicator lights up red or a message appears suggesting it is time to replace the lamp, please install a new lamp or consult your dealer. An old lamp may cause a malfunction in the projector and in some instances the lamp may explode.

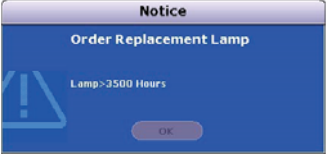
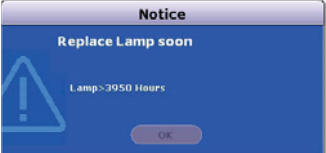
 **The LAMP indicator light and TEMPerature indicator light will light up if the lamp becomes too hot. Turn the power off and let the projector cool for 45 minutes. If the Lamp or LAMP indicator light still lights up after turning the power back on, please contact your dealer. See "Indicators" on page 44 for details.**

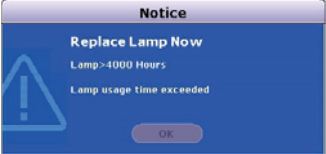
The following lamp warning displays will remind you to change the lamp.

Status	Message
The lamp has been in operation for 3500 hours. Install a new lamp for optimal performance. If the projector is normally run with <b>Low</b> selected (See "Setting Lamp mode as Low" on page 39), you may continue to operate the projector until the 3950 hour lamp warning appears.	
The lamp has been in operation for 3950 hours. A new lamp should be fitted to avoid the inconvenience when the projector runs out of lamp time.	
The lamp has been in operation for 4000 hours. It is strongly recommended that you replace the lamp at this age.  <b>The lamp is a consumable item. The lamp brightness diminishes with use. This is normal lamp behavior. You can replace the lamp whenever you notice that the brightness level has significantly diminished. If the lamp is not replaced beforehand, it must be replaced after 4000 hours usage.</b>	
The lamp <b>MUST</b> be replaced before the projector will operate normally.	



## Replacing the lamp

Spare lamp for EX200U/ES200U: VLT-EX240LP

- ⚠ • Be sure to replace the lamp with a new lamp separately sold that is exclusive to this projector. Contact your dealer for purchase of the lamp.
- To reduce the risk of electrical shock, always turn the projector off and disconnect the power cord before changing the lamp.
- To reduce the risk of severe burns, allow the projector to cool for at least 45 minutes before replacing the lamp.
- To reduce the risk of injuries to fingers and damage to internal components, use caution when removing lamp glass that has shattered into sharp pieces. To reduce the risk of injuries to fingers and/or compromising image quality by touching the lens, do not touch the empty lamp compartment when the lamp is removed.
- Be sure to install the lamp securely. When the lamp isn't installed properly, it won't illuminate. Improper installation may also result in fire.
- If the lamp should break, never shake the lamp box or hold it in front of your face after removing it. The glass fragments may fall out and cause injury to your eyes.
- In the event that the high-pressure mercury lamp exploded, glass fragments may have been scattered inside the projector. Ask your dealer to replace the lamp and to inspect the inside of the projector. When you clean or replace the lamp by yourself, be sure to hold the handle of the lamp. You may get injured by glass fragments.
- Contact your dealer when replacing the lamp unit with the projector mounted to the ceiling.
- Don't remove the lamp for any purpose other than replacement. Unnecessary removal of the lamp may result in a breakdown.
- This projector uses a high-pressure mercury lamp as the light source. The high-pressure mercury lamp may explode or fail to illuminate permanently because of an impact, scratch, or deterioration through use. The period of time until explosion or permanent failure to illuminate varies considerably from lamp to lamp, depending on operation conditions. Therefore, the lamp may explode soon after the start of use.
- The possibility of explosion of the lamp increases if you use it beyond its replacement period. When the instruction of lamp replacement appears, replace it with a new one immediately even if the lamp is still lighting normally.
- When the high-pressure mercury lamp explodes, glass fragments will scatter inside or outside the lamp box and the gas charged inside the lamp will diffuse inside or outside the projector. The gas inside the lamp contains mercury. Be careful not to breathe it or avoid it from entering your eye or mouth. If you should breathe it or if it should enter your eye or mouth, see a doctor immediately.
- This lamp contains mercury. Consult your local hazardous waste regulations to dispose of this lamp in a proper manner.
- Be sure to use the lamp dedicated to this projector, VLT-EX240LP for EX200U and ES200U. Use of other lamps may cause a failure of the projector.

1. Turn the power off and disconnect the projector from the wall socket. If the lamp is hot, avoid burns by waiting for approximately 45 minutes until the lamp has cooled.
2. Unscrew the screws on the lamp cover.

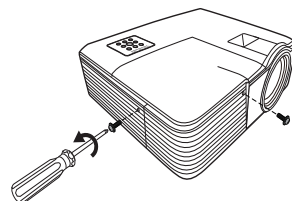

3. Remove the lamp cover from the projector.

①, ②

Pull up the lamp cover, pushing up the allow parts of the front panel.

- ⚠ • Do not turn the power on with the lamp cover removed.
- Do not insert your fingers between the lamp and the projector. The sharp edges inside the projector may cause injuries.

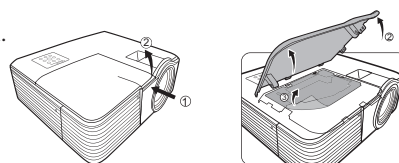

4. Remove and dispose of the lamp protection film. ③

5. Loosen the screw that secures the lamp.

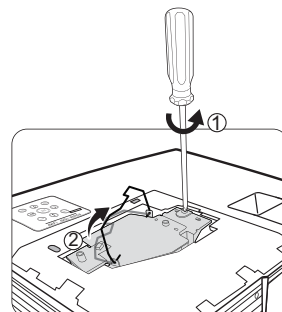

- Lift the handle so that it stands up. Use the handle to slowly pull the lamp out of the projector.



- Pulling it too quickly may cause the lamp to break and scatter broken glass in the projector.
- Do not place the lamp in locations where water might splash on it, children can reach it, or near flammable materials.
- Do not insert your hands into the projector after the lamp is removed. If you touch the optical components inside, it could cause color unevenness and distortion of the projected images.

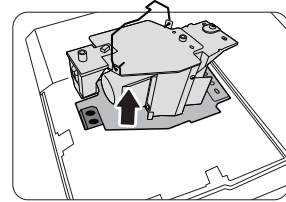

- As shown in the figure, lower the new lamp into the lamp compartment while aligning the lamp with the holes in the lamp compartment. Make sure it fits in the projector.

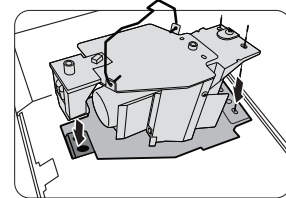

- Tighten the screw that secures the lamp.



- Loose screw may cause a bad connection, which could result in malfunction.
  - Do not over tighten the screw.
- Ensure the handle is fully laid flat and locked in place.

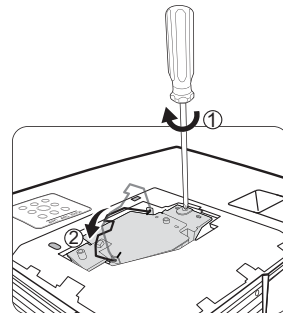

- Place the lamp protection film supplied with the new lamp on the lamp compartment.
- As shown in the figure, replace the lamp cover on the projector.

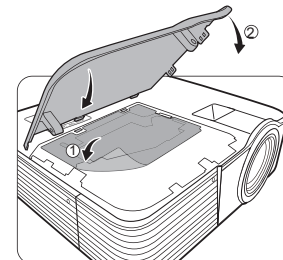

- Tighten the screws that secure the lamp cover.



- Loose screw may cause a bad connection, which could result in malfunction.
- Do not over tighten the screws.

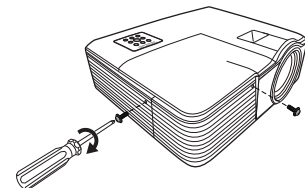

- Restart the projector.



- Do not turn the power on with the lamp cover removed.

### Resetting the lamp timer

- After the startup logo, open the On-Screen Display (OSD) menu. Go to the **SYSTEM SETUP: Advanced > Lamp Settings** menu. Press **MODE/ENTER**. The **Lamp Settings** page is displayed. Press **▼** to highlight **Reset lamp timer** and press **MODE/ENTER**. A warning message is displayed asking if you want to reset the lamp timer. Highlight **Reset** and press **MODE/ENTER**. The lamp time will be reset to '0'.





- Do not reset if the lamp is not new or replaced as this could cause damage.
- **This projector uses a lamp that contains mercury. Disposal of the lamp or the projector with the lamp may be regulated due to environmental considerations. For disposal or recycling information, please contact your local authorities or the Electronic Industries Alliance: [www.eiae.org](http://www.eiae.org). (For US only).**

# Indicators

Light			Status & Description
Power	Temp	Lamp	
<b>Power events</b>			
<b>Orange</b>	<b>Off</b>	<b>Off</b>	Stand-by mode
<b>Green Flashing</b>	<b>Off</b>	<b>Off</b>	Powering up
<b>Green</b>	<b>Off</b>	<b>Off</b>	Normal operation
<b>Orange Flashing</b>	<b>Off</b>	<b>Red</b>	<ul style="list-style-type: none"> <li>The projector needs 90 seconds to cool down as it was abnormally shut down without the normal cooling down process.</li> <li>The projector needs to cool for 90 seconds after the power is turned off.</li> </ul>
<b>Orange Flashing</b>	<b>Off</b>	<b>Off</b>	Cooling down.
<b>Lamp events</b>			
<b>Orange Flashing</b>	<b>Off</b>	<b>Red</b>	The projector has shutdown automatically. If you try to re-start the projector, it will shutdown again. Please contact your dealer for assistance.
<b>Off</b>	<b>Off</b>	<b>Red</b>	<ul style="list-style-type: none"> <li>The projector needs 90 seconds to cool down.</li> <li>Please contact your dealer for assistance.</li> </ul>
<b>Thermal events</b>			
<b>Off</b>	<b>Red</b>	<b>Off</b>	The projector has shutdown automatically. If you try to re-start the projector, it will shut down again. Please contact your dealer for assistance.
<b>Off</b>	<b>Red</b>	<b>Red</b>	
<b>Off</b>	<b>Red</b>	<b>Green</b>	
<b>Red</b>	<b>Red</b>	<b>Red</b>	
<b>Red</b>	<b>Red</b>	<b>Green</b>	
<b>Green</b>	<b>Red</b>	<b>Red</b>	
<b>Green</b>	<b>Red</b>	<b>Green</b>	
<b>Orange</b>	<b>Red</b>	<b>Red</b>	
<b>Orange</b>	<b>Red</b>	<b>Green</b>	
<b>Off</b>	<b>Green</b>	<b>Red</b>	
<b>Off</b>	<b>Green</b>	<b>Green</b>	

# Troubleshooting

## ① The projector does not turn on.

Cause	Remedy
There is no power from the power cable.	Plug the power cord into the AC inlet on the projector, and plug the power cord into the power outlet. If the power outlet has a switch, make sure that it is switched on.
Attempting to turn the projector on again during the cooling process.	Wait until the cooling down process has completed.

## ① No picture

Cause	Remedy
The video source is not turned on or connected correctly.	Turn the video source on and check that the signal cable is connected correctly.
The projector is not correctly connected to the input signal device.	Check the connection.
The input signal has not been correctly selected.	Select the correct input signal with the <b>SOURCE</b> key on the projector or remote control.
The lens cover is still closed.	Open the lens cover.

## ① Blurred image

Cause	Remedy
The projection lens is not correctly focused.	Adjust the focus of the lens using the focus ring.
The projector and the screen are not aligned properly.	Adjust the projection angle and direction as well as the height of the unit if necessary.
The lens cover is still closed.	Open the lens cover.

## ① Remote control does not work

Cause	Remedy
The battery is out of power.	Replace the battery with a new one.
There is an obstacle between the remote control and the projector.	Remove the obstacle.
You are too far away from the projector.	Stand within 8 meters (26 feet) of the projector.

## ① The password is incorrect

Cause	Remedy
You do not remember the password.	Please see " <a href="#">Entering the password recall procedure</a> " on page 21 for details.

# Specifications

## Projector specifications

 All specifications are subject to change without notice.

<b>General</b>		
Product name	DLP™ Projector	
Model name	EX200U	ES200U
<b>Optical</b>		
Resolution	1024 x 768 XGA	800 x 600 SVGA
Display system	1-CHIP DMD	
Lens F/Number	F = 2.6 to 2.8, f = 21.1 to 23.0 mm	
Lamp	185 W lamp	
<b>Electrical</b>		
Power supply	AC100–240V, 50/60 Hz (Automatic)	
Power consumption	3.1 A, 315 W (Max), < 1 W (Standby)	
<b>Mechanical</b>		
Dimensions	282 mm (W) x 94 mm (H) x 229 mm (D) (Not including protrusion)	
Weight	2.4 Kg (5.3 lbs)	
<b>Input terminal</b>		
Computer input		
RGB input	D-Sub 15-pin (female) x 2	
Video signal input		
S-VIDEO	Mini DIN 4-pin port x 1	
VIDEO	RCA jack x 1	
SD/HDTV signal input	Analog – D-Sub <-> Component RCA jack x 3 (through RGB input)	
Audio signal input	PC audio jack x 1 (Share the terminal with computer and video inputs)	
<b>Output terminal</b>		
RGB output	D-Sub 15-pin (female) x 1	
Audio signal output	PC audio jack x 1 (Share the terminal with computer and video inputs)	
Speaker	2W x 1	
<b>Control terminal</b>		
Serial control	D-Sub 9-pin (Male) x 1	
<b>Environmental requirements</b>		
Operating temperature	5°C–35°C	
Operating relative humidity	10%–90% (without condensation)	

# Dimensions

282 mm (W) x 94 mm (H) x 229 mm (D) (Not including protrusion)

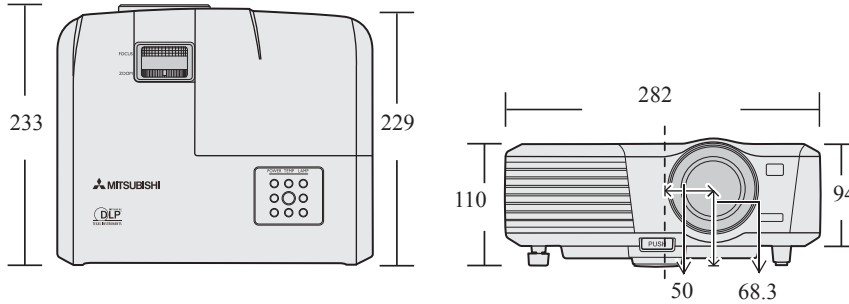

Tolerance:±2mm

# Timing chart

## Supported timing for PC input

Resolution	Mode	Vertical Frequency (Hz)	Horizontal Frequency (kHz)	Clock (MHz)
*720 x 400	720 x 400_70	70.087	31.469	28.3221
640 x 480	VGA_60	59.940	31.469	25.175
	VGA_72	72.809	37.861	31.500
	VGA_75	75.000	37.500	31.500
	VGA_85	85.008	43.269	36.000
800 x 600	SVGA_60	60.317	37.879	40.000
	SVGA_72	72.188	48.077	50.000
	SVGA_75	75.000	46.875	49.500
	SVGA_85	85.061	53.674	56.250
1024 x 768	XGA_60	60.004	48.363	65.000
	XGA_70	70.069	56.476	75.000
	XGA_75	75.029	60.023	78.750
	XGA_85	84.997	68.667	94.500
1280 x 800	WXGA_60	59.81	49.702	83.500
1280 x 1024	SXGA_60	60.020	63.981	108.000
	SXGA_75	75.025	79.976	135.000
	SXGA_85	85.024	91.146	157.500
1280 x 960	1280 x 960_60	60.000	60.000	108
	1280 x 960_85	85.002	85.938	148.500
1440 x 900	WXGA+_60	59.887	55.935	106.500
1400 x 1050	SXGA+_60	59.978	65.317	121.750
1600 x 1200	UXGA	60.000	75.000	162.000
640 x 480@67Hz	MAC13	66.667	35.000	30.240
832 x 624@75Hz	MAC16	74.546	49.722	57.280
1024 x 768@75Hz	MAC19	75.020	60.241	80.000
1152 x 870@75Hz	MAC21	75.06	68.68	100.00

\* The projector only supports the timing (720 x 400) with 5 lines (R, G, B, H, V).

### Supported timing for Component-YPbPr input

Signal Format	Horizontal Frequency (kHz)	Vertical Frequency (Hz)
480i(525i)@60Hz	15.73	59.94
480p(525p)@60Hz	31.47	59.94
576i(625i)@50Hz	15.63	50.00
576p(625p)@50Hz	31.25	50.00
720p(750p)@60Hz	45.00	60.00
720p(750p)@50Hz	37.50	50.00
1080i(1125i)@60Hz	33.75	60.00
1080i(1125i)@50Hz	28.13	50.00
1080P@60Hz	67.5	60.00
1080P@50Hz	56.26	50.00

 Displaying a 1080i(1125i)@60Hz or 1080i(1125i)@50Hz signal may result in slight image vibration.

### Supported timing for Video and S-Video inputs

Video mode	Horizontal Frequency (kHz)	Vertical Frequency (Hz)	Color sub-carrier Frequency (MHz)
NTSC	15.73	60	3.58
PAL	15.63	50	4.43
SECAM	15.63	50	4.25 or 4.41
PAL-M	15.73	60	3.58
PAL-N	15.63	50	3.58
PAL-60	15.73	60	4.43
NTSC4.43	15.73	60	4.43

### What's included in the box

AC power cord	for US	2G.01111.001	1 Remote control with battery 1 Safety manual/Quick start up 1 CD-ROM
	for EU	2G.00921.001	
	for UK/SG	2G.03132.001	
	for AU	2G.01343.001	
	for KR	2G.04321.001	
	for CN	2G.04245.001	
1 RGB cable		5K.08006.501	

### Replacement part

(Option / Not included in the box)

Spare lamp: VLT-EX240LP

Power cord is provided appropriately to the place of destination.



# Mitsubishi Projector Warranty, Sales Support and Service Information

## North America

**MDEA** (Mitsubishi Digital Electronics America, Inc.)  
 Presentation Products Division  
 9351 Jeronimo Road Irvine CA 92618, USA  
 For Warranty Registration, visit:  
<http://www.mitsubishi-presentations.com> under Customer Care  
**Sales & Inquiries**  
 Phone :Toll Free (888)307-0349  
 E-mail :ppdinfo@mdea.com  
**Technical Inquiries**  
 Phone :Toll Free (888)307-0309  
 E-mail :TSUPPORT@mdea.com

## MESCA (Mitsubishi Electric Sales Canada Inc.)

<http://www.mitsubishielec.com>  
 Information Technologies Group, 4299 14th Avenue,  
 Markham, Ontario L3R 0J2, Canada  
**Sales & Technical Inquiries**  
 Phone :+1-(800) 450-6487  
 Fax :+1-(905) 475-7958  
 E-mail :projectors@mitsubishielec.ca  
**Customer Care**  
 E-mail :support@mitsubishielec.ca

## Europe

### MEU-FRA (Mitsubishi Electric Europe B.V. French Branch)

25, Boulevard des Bouvets 92 741, Nanterre CEDEX,  
 France  
**Sales Inquiries**  
 Phone :+33 (0)1 55-68-55-53  
 Fax :+33 (0)1 55-68-57-31  
**Technical Inquiries**  
 Phone :+33 (0)1 55-68-56-42  
 Fax :+33 (0)1 55-68-57-31

### MEU-GER (Mitsubishi Electric Europe B.V. German Branch)

<http://www.mitsubishi-evs.de/>  
 Gothaer Strasse 8, 40880 Ratingen, Germany  
**Sales Inquiries**  
 Phone :0049 - 2102 - 486 9250  
 Fax :0049 - 2102 - 486 7320  
**Technical Inquiries**  
 Phone :0049 - 2102 - 486 1330  
 Fax :0049 - 2102 - 486 1340

### MEU-IR (Mitsubishi Electric Europe B.V. Irish Branch)

<http://www.mitsubishi.ie/>  
 Westgate Business Park, Ballymount, Dublin 24, Ireland  
**Sales Inquiries**  
 Phone :+353-1-4198807  
 Fax :+353-1-4198890  
**Technical Inquiries**  
 Phone :+353-1-4198808  
 Fax :+353-1-4198895

### MEU-IT (Mitsubishi Electric Europe B.V. Italian Branch)

Centro Direzionale Colleoni, Palazzo Sirio, Viale Colleoni 7,  
 20041 Agrate Brianza, Italy  
**Sales & Technical Inquiries**  
 Phone :+39-(0)39-60531  
 Fax :+39-(0)39-6053214  
 E-mail :info.projector@it.mee.com

### MEU-NL (Mitsubishi Electric Europe B.V. Benelux Branch)

<http://www.mitsubishi.nl/LCD/ProdFrame.html>  
 Nijverheidsweg 23A, 3641 RP Mijdrecht, The Netherlands  
**Sales Inquiries**  
 Phone :+31-297-282461  
 Fax :+31-297-283936  
 E-mail :info@mitsubishi.nl  
**Technical Inquiries**  
 Phone :+31-297-282461  
 Fax :+31-297-283936  
 E-mail :info@mitsubishi.nl

### Russia (Mitsubishi Electric Europe B.V. Moscow

Representative Office)  
<http://www.mitsubishi-projector.ru/>  
 Moscow Representative Office, 52/5 Kosmodamianskaya  
 Nab., 115054, Moscow, Russia  
**Sales & Technical Inquiries**  
 Phone : (7095) 721-2068  
 Fax : (7095) 721-2071

### MEU-SP (Mitsubishi Electric Europe B.V. Spanish Branch)

<http://www.mitsubishielec.com>  
 Ctra. de Rubi, 76-80, 08173 Sant Cugat del Valles,  
 Barcelona, Spain  
**Sales Inquiries**  
 Phone :+34-93.565.31.54  
 Fax :+34-93.589.43.88  
 E-mail :mitsubishi.profesional@sp.mee.com  
**Technical Inquiries**  
 Phone :+34-93.586.27.51  
 Fax :+34-93.588.53.87  
 E-mail :mitsubishi.profesional@sp.mee.com

### MEU-SWE (Mitsubishi Electric Europe B.V. Scandinavian

Branch)  
 Hammarbacken 14, Box 750, S-19127, Sollentuna, Sweden  
**Sales Inquiries**  
 Phone :+46-(0)8-6251070  
 Fax :+46-(0)8-6251036  
**Technical Inquiries**  
 Phone :+46-(0)8-6251052  
 Fax :+46-(0)8-6251036

### MEU-UK (Mitsubishi Electric Europe)

<http://www.mitsubishi.co.uk/evs/>  
 Visual Information Systems Division, Travellers Lane,  
 Hatfield, Hertfordshire, AL10 8XB U.K.  
**Sales Inquiries**  
 Phone :+44 (1707) 278684  
 Fax :+44 (1707) 278541  
 E-mail :projector.info@meuk.mee.com  
**Technical Inquiries**  
 Phone :+44 (870) 606 5008  
 Fax :+44 (1506) 431927  
 E-mail :projector.info@meuk.mee.com

## Asia

### CHINA (Mitsubishi Electric Air-Conditioning & Visual

Information Systems (Shanghai) Ltd.)  
 12/F., Hong Kong New World Tower, 300 Huaihai Middle  
 Road, Shanghai, 200021, China  
**Sales Inquiries**  
 Phone :+86(21) 6335-3030 (Ext.3007)  
 Fax :+86(21) 6335-3600  
**Technical Inquiries**  
 Phone :+86(21) 6335-3030 (Ext.3021)  
 Fax :+86(21) 6335-3600

### HONG KONG (Mitsubishi Electric Ryoden Air-Conditioning

& Visual Information Systems (HongKong) Ltd.)  
 7th Floor, Manulife Tower, 169 Electric Road, North Point,  
 Hong Kong  
**Sales Inquiries**  
 Phone :+852-2510-1505  
 Fax :+852-2510-0463  
**Technical Inquiries**  
 Phone :+852-2422-0161  
 Fax :+852-2487-0181

### SINGAPORE (Mitsubishi Electric Asia Pte. Ltd.)

<http://www.mitsubishielec.com.sg>  
 307, Alexandra Road, #05-01/02 Mitsubishi Electric  
 Building, Singapore 159943  
**Sales Inquiries**  
 Phone :+65-6473-2308  
 Fax :+65-6475-9503  
 E-mail :Peripherals@asia.meap.com  
**Technical Inquiries**  
 Phone :+65-6470-2666  
 Fax :+65-6475-9503

### INDIA (Mitsubishi Electric Asia Pte. Ltd.)

307, Alexandra Road, #05-01/02 Mitsubishi Electric  
 Building, Singapore 159943  
**Sales Inquiries**  
 Phone :+65-6473-2308  
 Fax :+65-6475-9503  
 E-mail :Peripherals@asia.meap.com  
**Technical Inquiries**  
 Phone :+65-6470-2666  
 Fax :+65-6475-9503

### INDONESIA (Mitsubishi Electric Asia Pte. Ltd.)

307, Alexandra Road, #05-01/02 Mitsubishi Electric  
 Building, Singapore 159943  
**Sales Inquiries**  
 Phone :+65-6473-2308  
 Fax :+65-6475-9503  
 E-mail :Peripherals@asia.meap.com  
**Technical Inquiries**  
 Phone :+65-6470-2666  
 Fax :+65-6475-9503

### PHILIPPINES (Mitsubishi Electric Asia Pte. Ltd.)

<http://www.mitsubishielec.com.sg>  
 307, Alexandra Road, #05-01/02 Mitsubishi Electric  
 Building, Singapore 159943  
**Sales Inquiries**  
 Phone :+65-6473-2308  
 Fax :+65-6475-9503  
 E-mail :Peripherals@asia.meap.com  
**Technical Inquiries**  
 Phone :+65-6470-2666  
 Fax :+65-6475-9503

### VIETNAM (Mitsubishi Electric Asia Pte. Ltd.)

307, Alexandra Road, #05-01/02 Mitsubishi Electric  
 Building, Singapore 159943  
**Sales Inquiries**  
 Phone :+65-6473-2308  
 Fax :+65-6475-9503  
 E-mail :Peripherals@asia.meap.com  
**Technical Inquiries**  
 Phone :+65-6470-2666  
 Fax :+65-6475-9503

### STC (Setsuyo Astec Corporation Seoul Branch)

16F KT Bldg., 28-2 Yeouido-dong, Yeongdeungpo-gu,  
 Seoul 150-931, Korea  
**Sales & Technical Inquiries**  
 Phone :+82-1588-5576  
 Fax :+82-2-704-8666

### MALAYSIA (Melco Sales Malaysia Sdn Bhd)

Lot 11, Jalan 219, 46100 Petaling Jaya, Selangor Darul Ehsan,  
 Malaysia.  
**Sales & Technical Inquiries**  
 Phone :+60-(0)3-79573428  
 Fax :+60-(0)3-79563950/+60-(0)3-79582576  
**Technical & Service Inquiries**  
 Phone :+60-(0)3-79553997  
 Fax :+60-(0)3-79584836

### ME-TWN (Mitsubishi Electric Taiwan Co., Ltd.)

<http://www.MitsubishiElectric.com.tw>  
 11TH FL., 90 SEC. 6, CHUNG SHAN N. RD., TAIPEI, 111  
 R.O.C.  
**Sales & Technical Inquiries**  
 Phone :+886-2-2832-8255  
 Fax :+886-2-2833-9813

### MKY (Mitsubishi Electric Kang Yong Watana Co., Ltd.)

<http://www.mitsubishi-kyw.co.th/>  
 Road, Huamark Bangkokpi, Bangkok 10240, Thailand  
**Sales & Technical Inquiries**  
 Phone :+66-2-731-6841  
 Fax :+66-2-379-4763

## Oceania

### ME-AUST (Mitsubishi Electric Australia)

<http://www.mitsubishi-electric.com.au/prod.asp?prod=proj>  
 348 Victoria Road, Rydalmere, N.S.W. 2116, Australia  
**Sales & Technical Inquiries**  
 Phone :+(612)9684-7777  
 Fax :+(612)9684-7208  
**E-mail :diamonddigital@meaust.meap.com**  
**Technical Inquiries**  
 Phone :+(612)9684-7694  
 Fax :+(612)9684-7684  
 E-mail :service@meaust.meap.com

### BDT (Black Diamond Technologies Ltd.)

(Warranty Registration) <http://www.bdt.co.nz/projectors/warranty.asp>  
 1 Parliament St, Lower Hutt, Wellington, New Zealand  
**Sales Inquiries**  
 Phone :+64-(0)4-560-9100  
 Fax :+64-(0)4-560-9133  
 E-mail :projectorsales@bdt.co.nz  
**Technical Inquiries**  
 Phone :+64-(0)4-560-9100  
 Fax :+64-(0)4-560-9133  
 E-mail :service@bdt.co.nz