

User's Guide

Multimedia Projector

EB-Z8455WU

EB-Z8450WU

EB-Z8355W

EB-Z8350W

EB-Z10005



EB-Z10000

EB-Z8150





Notations Used in This Guide

- **Safety indications**

The documentation and the projector use graphical symbols to show how to use the projector safely. Please understand and respect these caution symbols in order to avoid injury to persons or property.

 Warning	This symbol indicates information that, if ignored, could possibly result in personal injury or even death due to incorrect handling.
 Caution	This symbol indicates information that, if ignored, could possibly result in personal injury or physical damage due to incorrect handling.

- **General information indications**

Attention	Indicates procedures which may result in damage or injury if sufficient care is not taken.
	Indicates additional information and points which may be useful to know regarding a topic.
	Indicates a page where detailed information regarding a topic can be found.
	Indicates that an explanation of the underlined word or words in front of this symbol appears in the glossary of terms. See the "Glossary" section of the "Appendix".  p.183
<div style="border: 1px solid black; padding: 2px; display: inline-block;">Procedure</div>	Indicates operating methods and the order of operations. The procedure indicated should be carried out in the order of the numbered steps.
[(Name)]	Indicates the name of the buttons on the Remote Control or the Control panel. Example: [ESC] button
"(Menu Name)" Brightness (Boldface)	Indicates the configuration menu items. Example: Select "Brightness" from the Image menu. Image menu - Brightness

- **Screen shots of the configuration menu**

The screen shots may be different from those shown in this manual depending on your projector model.



Notations Used in This Guide 2

Introduction

Projector Features 8

- Ease of Use when Installed on a Ceiling Mount 8
- Reliability You can Depend on 8
- Meets a Wide Range of Needs 8
- Enhanced Security Functions 9
- Easy to Handle 9
- Monitoring and Control Functions 10
- Taking Full Advantage of a Network Connection 10

Part Names and Functions 11

- Front/Top 11
- Rear 12
- Interface 13
- Control Panel 14
- Remote Control 15
 - Installing the batteries 16
 - Operating range of remote control 18

Useful Functions

Changing the Projected Image 20

- Automatically Detect Input Signal and Change the Projected Image (Source Search) 20
- Switch to the Target Image by Remote Control 21

Changing the Aspect Ratio of the Projected Image 22

- Changing the Aspect Mode (EB-Z8455WU/Z8450WU) 23
 - Projecting images from video equipment or from the HDMI1/2 or SDI input port 23
 - Projecting images from a computer 23
- Changing the Aspect Mode (EB-Z8355W/Z8350W) 24
 - Projecting images from video equipment or from the HDMI1/2 input port 24

- Projecting images from a computer 24
- Changing the Aspect Mode (EB-Z10005/Z10000/Z8150) 25
 - Projecting images from video equipment 25
 - Projecting images from the HDMI1/2 input port 26
 - Projecting images from a computer 26

Selecting the Projection Quality (Selecting Color Mode) 28

Projecting Two Images Simultaneously (Split Screen) 29

- Input Sources for Split Screen Projection 29
- Operating Procedures 29
 - Projecting on a split screen 29
 - Switching the left and right screens 30
 - Switching the left and right image sizes 31
 - Ending the split screen 31
- Restrictions during Split Screen Projection 32
 - Operating restrictions 32
 - Restriction relating to images 32

Functions for Enhancing Projection 33

- Hiding the Image Temporarily (Shutter) 33
- Freezing the Image (Freeze) 33
- Pointer Function (Pointer) 34
- Enlarging Part of the Image (E-Zoom) 34

Saving a User's Logo 36

Security Functions 38

- Managing Users (Password Protect) 38
 - Type of Password Protect 38
 - Setting Password Protect 38
 - Entering the Password 39
- Restricting Button Operation 40
 - Control Panel Lock 40
 - Lens Operation Lock 41
 - Remote control button lock 42
- Anti-Theft Lock 43
 - Installing the wire lock 43

Memory Function 44

Available Settings	44
Saving/Loading/Erasing the Memory	44
Saving the memory	44
Loading the memory	45
Erasing the memory	45
Renaming the memory	45

Configuration Menu

Using the Configuration Menu	47
Configuration Menu	48
Network Menu	49
Image Menu	51
Signal Menu	53
Settings Menu	55
Extended Menu	57
Network Menu	60
Notes on Operating the Network Menu	61
Soft Keyboard Operations	61
Basic Menu	62
Wireless LAN Menu	63
Search Access Point screen	65
Security Menu (Only Available when the Optional Wireless LAN Unit Is Installed)	66
When WPA/WPA2-PSK is selected	67
When WPA/WPA2-EAP is selected	68
Wired LAN Menu	70
Administrator Settings Menu	71
Mail Notification menu	73
Manage Certificates menu	74
SNMP menu	75
Reset Menu	76

Info Menu (Display Only)	77
Reset Menu	79

Troubleshooting

Using the Help	81
Problem Solving	83
Reading the Indicators	83
Indicator is lit or flashing red	84
Indicator is flashing or lit	85
When the Indicators Provide No Help	88
Problems relating to images	89
Problems when projection starts	93
Other problems	94
Interpreting Event IDs	96

Maintenance

Cleaning	98
Cleaning the Projector's Surface	98
Cleaning the Lens	98
Cleaning the Air Filter	98
Replacing Consumables	101
Replacing the Lamps	101
Lamp replacement period	101
How to replace the lamp	101
Resetting the Lamp Hours	103
Replacing the Air Filter	104
Air filter replacement period	104
How to replace the air filter	104
Notes on Transportation	106
Moving Nearby	106

When Transporting	106
Preparing packaging	106
Notes when packing and transporting	106

Monitoring and Controls

EasyMP Monitor	108
Changing Settings Using a Web Browser (Web Control)	109
Displaying Web Control	109
Displaying Web Remote	109
Displaying Lens Control	110
Setting Certificates	111
Secure HTTP Notes	112
Using the Mail Notification Function to Report Problems	113
Reading Problem Mail Notification Function	113
Management Using SNMP	114
ESC/VP21 Commands	115
Serial Connection	115
Communications Protocol	115
Command List	115
About PJLink	117
About Crestron RoomView®	118
Operating a Projector from a Computer Window	118
Displaying the operation window	118
Using the operation window	119
Using the tools window	120
About Message Broadcasting	122

Network Functions

Projecting with "Connect to a Network Projector"	124
Making a WPS (Wi-Fi Protected Setup) Connection with a Wireless LAN Access Point	125
Connection Setup Method	125
Making a connection using the push button method	126
Making a connection using the PIN Code Method	127

Installation and Connections

Installation Methods	130
Connecting to Video Equipment	132
Connecting to a Computer	132
Changing the video output from a laptop computer.	133
Connecting to Video Equipment	134
Adjusting the Projected Image	137
Displaying a Test Pattern	137
Adjusting the Position of the Projected Image (Lens Shift)	138
Adjusting the Tilt of the Projected Image	139
Correcting Distortion in the Projected Image	139
Quick Corner	140
H/V-Keystone	142
Arc Correction	143
Adjusting the Image Quality	146
Hue, Saturation, and Brightness Adjustment	146
Gamma Adjustment	146
Select and adjust the correction value	146
Adjust while viewing the image	147
Adjust using the gamma adjustment graph	147
Frame Interpolation (EB-Z8455WU/Z8450WU only)	147
Super-resolution	148
Noise Reduction	148

Noise Reduction	148
Mosquito NR	149
Settings for Multiple Projectors	150
Preparation Flow	150
Projector ID/Remote Control ID	150
Setting the projector ID	151
Checking the Projector ID	151
Setting the remote control ID	152
Adjusting the Position of the Projected Image	152
Point Correction	153
Checking the Color Mode	154
Using the Edge Blending Function	155
Adjusting to Match Colors on Multi-Projection	157
Displays the Image Partly Enlarged (Scale)	157
Setting Schedule	159
Setting Methods	159
Clock	159
Daylight Saving Time screen	160
Schedule	160
Clock / Schedule Setting screen	160
Connecting to External Equipment	161
Connecting a LAN Cable	161
Connecting to an External Monitor	161
Installing Optional and Supplied Accessories	162
Removing and Attaching the Projector Lens Unit	162
Removing	162
Attaching	163
Installing the Wireless LAN Unit (ELPAP07)	165
Attaching	165
Reading the wireless LAN indicators	166
Attaching and Removing the Interface Cover	166
Removing	166
Attaching	167
Removing the Feet	168

Appendix

Optional Accessories and Consumables	170
Optional Accessories	170
Consumables	170
Screen Size and Projection Distance	171
Projection Distance of EB-Z8455WU/Z8450WU	171
Projection Distance of EB-Z8355W/Z8350W	172
Projection Distance of EB-Z10005/Z10000/Z8150	173
Supported Monitor Displays	175
Supported Monitor Displays	175
Computer signals (analog RGB)	175
Component Video	175
Composite Video/S-Video	175
Input signals from HDMI1/2 input port	175
Input signals from SDI input port (EB-Z8455WU/Z8450WU only)	176
Supported Certificates	177
Specifications	178
Projector General Specifications	178
Appearance	182
Glossary	183
General Notes	185
About Notations	185
General Notice	185
Index	187



Introduction

This chapter explains the projector's features and the part names.

Ease of Use when Installed on a Ceiling Mount

Centered lens

The lens is positioned in the center of the projector so it is well balanced and is easy to mount on a ceiling. This also makes it easy to line up the screen and the projector.

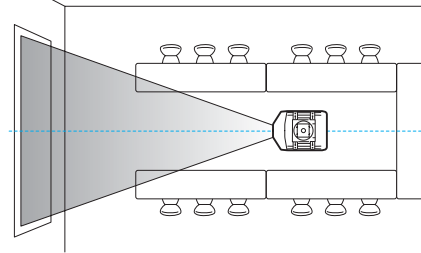

Equipped with electric lens shift, zoom and focus functions

Using the lens shift function that allows you to adjust the position of the projected image along the horizontal and vertical axis opens up a wide variety of installation locations.

👉 [p.138](#)

The lens shift, zoom, and focus functions can be operated with a remote control so operation is easy even if the projector is mounted on the ceiling.

Variety of optional lenses available

You can select the best lens according to the projection distance and purpose. The bayonet type allows you to simply and easily exchange and install the optional lenses.

👉 [p.162](#)

Various angles of projection

The projector can be pointed up, down, or angled to project images on the ceiling or floor, in addition to normal horizontal projection. This makes it an effective communication tool that lets you express your ideas with great impact. 👉 [p.130](#)

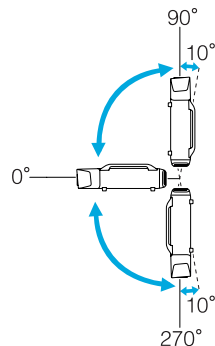

A design that harmonizes with the surrounding environment, and makes the installation easy

The projector's sophisticated design has a cable cover in which cables are hidden for a clean exterior appearance.

The bar type handles are designed to make moving and installing the projector easy so it can be handled safely. The ceiling mount is attached to these handles to mount the projector on the ceiling. The projector does not need to be turned upside down so installation is easy. The initial settings can be easily set as you look at the screen because the control panel is arranged on the back of the projector.

Easy maintenance

You can replace the lamp by opening a cover and pulling it straight out of the back of the projector without using a screwdriver.

There is only one air filter so cleaning and replacement are easy. The lamp and air filter can be safely replaced even when mounted on the ceiling because their covers do not fall off even if you release them.

Reliability You can Depend on

Dual lamps, to reduce risk of shutdown

The projector is equipped with two lamps. Even if one of the lamps breaks, you can continue projecting with the other lamp and avoid disrupting important presentations.

Achieves operating temperature of 0–50°C

Special coolant and fan in cooling system work against a high temperature environment during operation and improve reliability in normal use.

It depends on settings and usage environment, but you can use this projector in a place up to 50°C.

Meets a Wide Range of Needs

Equipped with a high-resolution WUXGA panel (EB-Z8455WU/Z8450WU only)

You can project a dramatic amount of information on the screen. Viewers can see the information at a glance without having to scroll or switch screens.

The frame interpolation function smoothly plays fast moving video, such as sports and action movies, reducing afterimage.

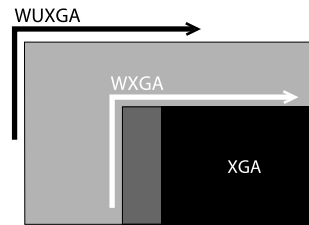

Project two images simultaneously (Split Screen)

You can simultaneously project the images from two video sources lined up on the screen. This increases the range of applications, such as when holding a video conference while projecting presentation materials. [p.29](#)



Clearly reproduce medical images

A color mode called "DICOM SIM" is provided to project medical images, such as X-ray photographs. This mode produces image quality that approaches the DICOM [▶](#) standard.

(The projector is not a medical device and cannot be used for medical diagnosis.)
[p.28](#)

Epson Cinema Filter supports the color gamut for digital cinema.

Select Theatre or sRGB in Color Mode to use Epson Cinema Filter. When Color Mode is set to Theatre, 100% reproduction of the color gamut used for digital cinema is possible. As a result, this reproduces colors that are full and deep.

Precise color adjustments

As well as Color Mode, you can also adjust the image's absolute color temperature and the strength of each RGB color. Also, because you can adjust the hue, saturation, and brightness of each RGB/CMY, the image can be projected with depth and a color matching in superior detail.

The setting values of adjusted image can be saved in memory and used when needed. If you use one projector in several places, you can easily use the previous settings again.

Seamlessly project multiple images together

When projecting on one screen from multiple projectors, color tone differences between each projected image can be adjusted to create a seamless screen, using Multi-screen and Edge Blending. [p.150](#)

Enhanced Security Functions

Password Protect to restrict and manage users

By setting a password you can restrict who can use the projector. [p.38](#)

Control Panel Lock restricts button operation on the control panel

You can use this to prevent people changing projector settings without permission at events, in schools, and so on. [p.40](#)

Equipped with various anti-theft devices

The projector is equipped with the following types of anti-theft security devices.
[p.43](#)

- Security slot
- Security cable installation point

Easy to Handle

Direct power On/Off

In places where power is managed centrally, such as in a conference room, the projector can be set to power on and off automatically when the power source to which the projector is connected is switched on or off.

No cool down delay

After turning the projector's power off, you can disconnect the projector's power cable without having to wait for the projector to cool down.

Monitoring and Control Functions

Schedule

You can schedule turning the projector power on/off and switching the input source, as events in the schedule. Registered events are executed automatically at the specified time on the specified dates weekly.  "Setting Schedule" [p.159](#)

Supporting various protocols

A selection of monitoring and control protocols is supported, such as the Epson EasyMP Monitor application software. This allows you to use the projector according to your system environment.  "Monitoring and Controls" [p.107](#)

Taking Full Advantage of a Network Connection

Simultaneously project four images for dynamic conferences

By using the EasyMP Multi PC Projection application software included, you can select up to 4 images from up to 32 computers that are connected to the network, and divide the projector's screen to show them together. Anyone can freely and easily project images from connected computers to make conferences and meetings more lively.

 [EasyMP Multi PC Projection Operation Guide](#)

Transferring images using the network

The supplied EasyMP Network Projection applications software can be used to connect to network computers and transfer video and movies. Using a variety of transfer functions increases presentation possibilities.  [EasyMP Network Projection Operation Guide](#)

* This unit cannot transfer audio.

Project using "Connect to a Network Projector"



By connecting the projector to a network and using the Network Projector function in Windows Vista or Windows 7, multiple users on the network can share the projector.





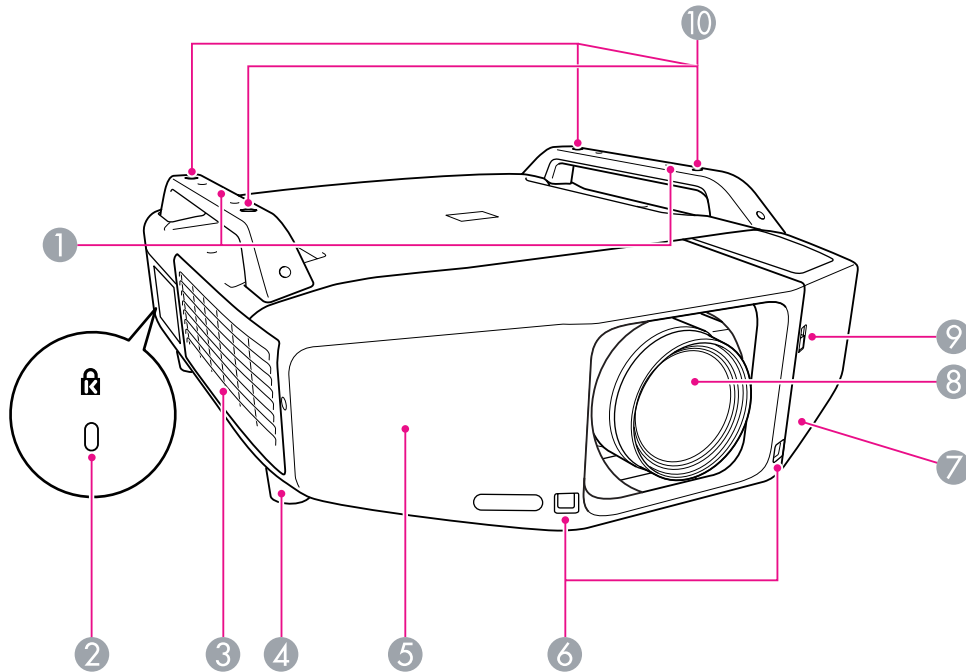



 [p.124](#)

Front/Top

The illustration shows the projector with a standard zoom lens installed.







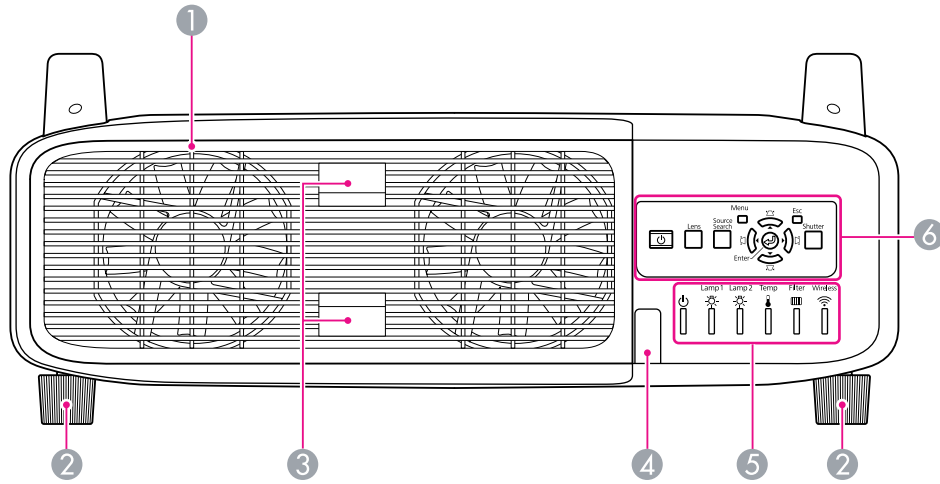

Name	Function
1 Handle	Use these handles when carrying the projector. Also, you can pass an anti-theft wire lock through the handles to secure the projector.  p.43
 Caution Do not carry the projector by one person. Two people are needed to unpack or carry the projector.	

Name	Function
2 Security slot 	The Security slot is compatible with the Microsaver Security System manufactured by Kensington.  p.43
3 Air intake vent (Air filter)	Takes in air to cool the projector internally. If dust collects here it can cause the internal temperature to rise, and this can lead to problems with operation and shorten the optical engine's service life. Be sure to clean the air filter regularly.  p.98 , p.104
4 Front adjustable foot	When set up on a desk, turn to extend and retract to adjust the horizontal tilt. The front adjustable feet can be removed when the projector is installed on a ceiling.  p.168
5 Front cover	Remove this cover to remove or install the lens unit when replacing the lens.  p.162 This cover must be installed when using the projector.
6 Remote Receiver	Receives signals from the remote control.  p.18
7 Interface cover	Remove this cover to connect cables to the ports inside when connecting the projector to video equipment.  p.13 , p.166
8 Projection lens	Images are projected through here.
9 Interface cover open/close switch	Opens and closes the interface cover.  p.166
10 Ceiling mount fixing points (Four points)	Attach the optional Ceiling mount here when suspending the projector from a ceiling.  p.130 , p.170

Rear



Name	Function
6 Control Panel	 "Control Panel" p.14

Name	Function
1 Air exhaust vent (Lamp cover)	<p>Exhaust vent for air used to cool the projector internally. Also, open this cover to replace the projector's lamps.</p> <div style="border: 1px solid black; padding: 5px; background-color: #e0f2f1;"> <p> Caution</p> <p><i>Do not place objects that may become warped or otherwise affected by heat near the Air exhaust vent and do not put your face or hands near the vent while projection is in progress.</i></p> </div>
2 Rear foot	<p>When set up on a desk, turn to extend and retract to adjust the horizontal tilt.</p> <p>The rear adjustable feet can be removed when the projector is installed on a ceiling.  p.168</p>
3 Lamp cover open tab	Use these tabs to open the lamp cover.  p.101
4 Remote Receiver	Receives signals from the remote control.  p.18
5 Status indicators	The color of the indicators and whether they are flashing or lit indicate the status of the projector.  p.83

Interface

The following ports can be accessed by removing the interface cover. For information on how to remove the interface cover and connect video equipment, see "Attaching and Removing the Interface Cover" p.166, "Connecting to Video Equipment" p.132

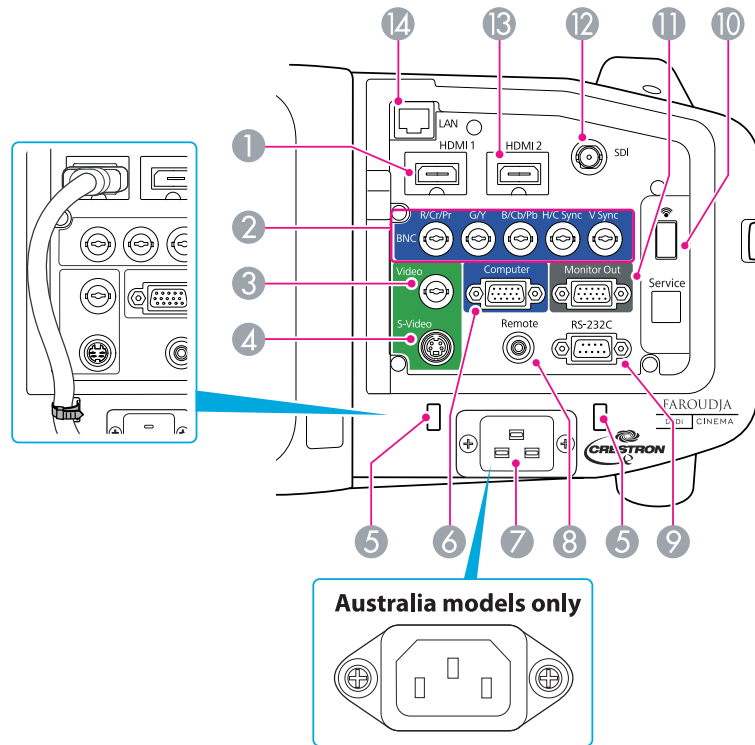







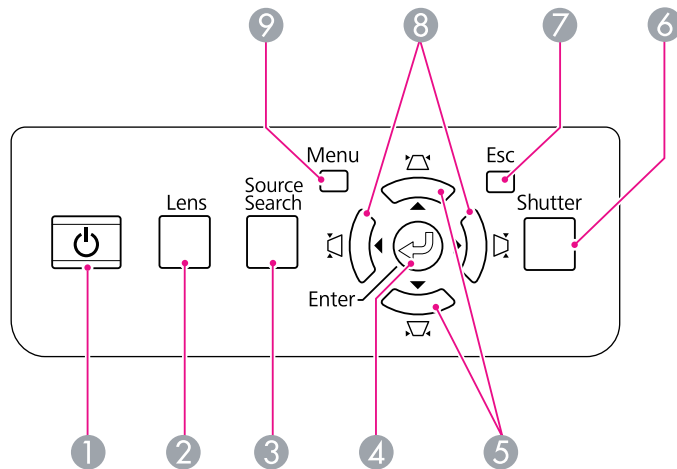



Name	Function
① HDMI1 input port	Inputs video signals from HDMI compatible video equipment and computers. This projector is compatible with HDCP signals.
② BNC input port	For analog RGB signals from a computer and component video signals from other video sources.

Name	Function
③ Video input port	For composite video signals from video sources.
④ S-Video input port	For S-video signals from video sources.
⑤ Cable holder	Connection may become defective when a thick heavy HDMI cable is connected to the HDMI input port. Run a commercially available cable tie through this holder to prevent the cable from disconnecting.
⑥ Computer input port	For analog RGB signals from a computer and component video signals from other video sources.
⑦ Power inlet	Connects to the power cable. The shape may differ depending on your projector model.
⑧ Remote port	Connects the optional remote control cable set and inputs signals from the remote control. When the remote control cable is plugged into this port, the remote receiver on the projector is disabled.
⑨ RS-232C port	When controlling the projector from a computer, connect it to the computer with an RS-232C cable. This port is for control use and should not normally be used. p.115
⑩ Wireless LAN Unit port	Connects to the optional wireless LAN unit. p.165
⑪ Monitor Out port	Outputs to an external monitor the analog signal from the computer connected to the Computer input port or the BNC input port. This is not available for component video signals or other signals being input to any port other than the Computer input port or the BNC input port. p.161
⑫ SDI port (EB-Z8455WU/ Z8450WU only)	Inputs SDI signals from a video equipment.
⑬ HDMI2 input port	Inputs video signals from HDMI compatible video equipment and computers. This projector is compatible with HDCP signals.
⑭ LAN port	Connects a LAN cable to connect to a network. p.161

Control Panel









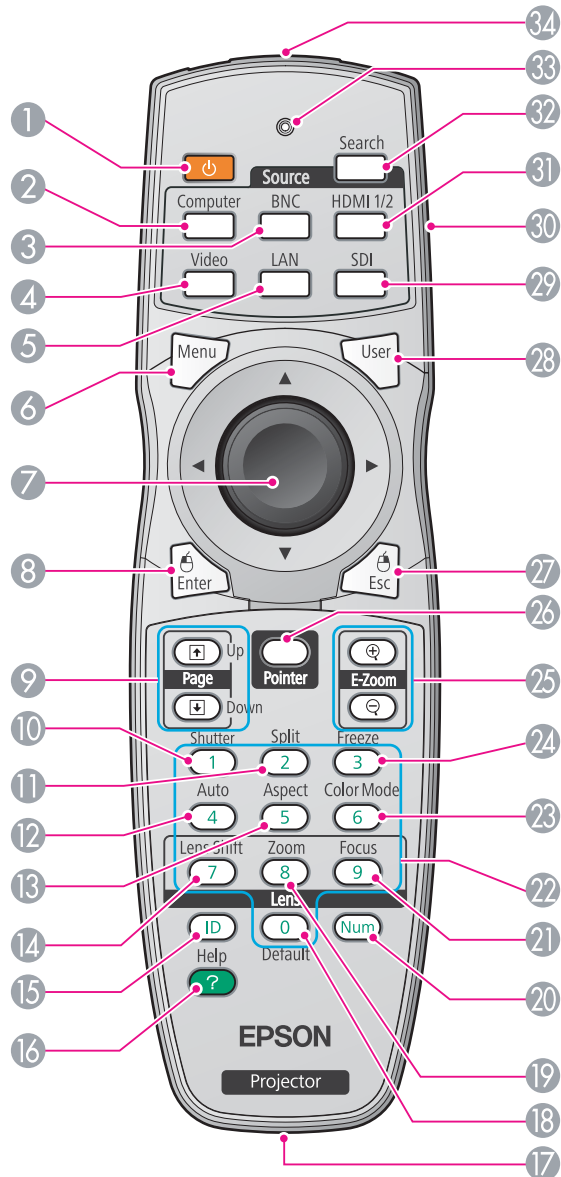













Name	Function
① [Power] button	Turns the projector power On or Off.  Quick Start Guide
② [Lens] button	Press this button to cycle through the focus, zoom, and lens shift settings to adjust the lens.  p.138, Quick Start Guide
③ [Source Search] button	Changes to the next input source that is connected to the projector and is sending an image.  p.20
④ [Enter] button	If pressed during projection of computer analog RGB signals, it automatically adjusts the Tracking, Sync., and Position to project the optimum image. When the configuration menu or a Help screen is displayed, it accepts and enters the current selection and moves to the next level.  p.47







Name	Function
⑤ [Up/Down] button	Corrects vertical keystone distortion.  p.142 If pressed while the configuration menu or a Help screen is displayed, these buttons only have the [▲] and [▼] functions which select menu items and setting values.  p.47 When projecting using "Connect to a Network Projector", these buttons function only as [▲] and [▼] buttons.
⑥ [Shutter] button	Closes or opens the electric shutter, or mutes the image temporarily to dim the screen. Any operation that is selected in Shutter Button is executed.  p.33
⑦ [Esc] button	Stops the current function. If pressed when the configuration menu is displayed, it moves to the previous menu level.  p.47
⑧ [Left/Right] button	Corrects horizontal keystone distortion.  p.142 If pressed while the configuration menu or a Help screen is displayed, these buttons only have the [◀] and [▶] functions which select menu items and setting values.  p.47 When projecting using "Connect to a Network Projector", these buttons function only as [◀] and [▶] buttons.
⑨ [Menu] button	Displays and closes the configuration menu.  p.47

Remote Control



Name	Function
① [Power] button	Turns the projector power On or Off.  Quick Start Guide
② [Computer] button	Changes to images from the Computer input port.  p.21
③ [BNC] button	Changes to images from the BNC input port.  p.21
④ [Video] button	Each time the button is pressed, the image displayed changes between the Video input port and S-Video input port.  p.21
⑤ [LAN] button	Changes to images of EasyMP Network Projection.  p.21
⑥ [Menu] button	Displays and closes the configuration menu.  p.47
⑦ [Directional] button	When the configuration menu or Help screen is displayed, it selects menu items and setting values.  p.47 , p.81 When using the optional wireless mouse receiver, tilting this button moves the pointer in the direction (eight possible directions) tilted.
⑧ [Enter] button	When the configuration menu or a Help screen is displayed, it accepts and enters the current selection and moves to the next level.  p.47 , p.81 Acts as a mouse's left button when using the optional wireless mouse receiver.
⑨ [Page] buttons [Up][Down]	When using the optional wireless mouse receiver, you can change the PowerPoint file page during projection by pressing the page up/page down buttons.
⑩ [Shutter] button	Closes or opens the electric shutter, or mutes the image temporarily to dim the screen. Any operation that is selected in Shutter Button is executed.  p.33
⑪ [Split] button	Press this button to split the screen in two and project two images simultaneously.  p.29

Name	Function
12 [Auto] button	If pressed during projection of computer analog RGB signals, it automatically adjusts the Tracking, Sync., and Position to project the optimum image.
13 [Aspect] button	The <u>Aspect Ratio</u> changes each time the button is pressed.  p.22
14 [Lens Shift] button	Press to adjust the lens shift.  p.138
15 [ID] button	Press to set the remote control ID.  p.150
16 [Help] button	Displays and closes the Help screen which shows you how to deal with problems if they occur.  p.81
17 Remote port	Connects the optional remote control cable set and outputs signals from the remote control. When the remote control cable is plugged into this remote port, the remote receiver is disabled.
18 [Default] button	Reset to default the setting values being adjusted in some configuration menus.
19 [Zoom] button	Press to adjust the zoom.  <i>Quick Start Guide</i>
20 [Num] button	Use this button to enter passwords, IP Address from the Network, and so on.  p.38
21 [Focus] button	Press to adjust the focus. We recommend setting the focus, zoom, and lens shift at least 30 minutes after you start the projection, because images are not stable right after turning on the projector.  <i>Quick Start Guide</i>
22 Numeric buttons	Use this button to enter passwords, remote control ID settings, IP Address from the Network, and so on.  p.152, p.38
23 [Color Mode] button	Each time the button is pressed, the Color Mode changes.  p.28
24 [Freeze] button	Images are paused or unpaused.  p.33
25 [E-Zoom] buttons [+][−]	The [+] button enlarges the image without changing the projection size. The [−] button reduces the parts of images that have been enlarged using the [+] button.  p.34

Name	Function
26 [Pointer] button	Press to activate the on screen pointer.  p.34
27 [Esc] button	Stops the current function. If pressed when the configuration menu is displayed, it moves to the previous menu level.  p.47 Acts as a mouse's right button when using the optional wireless mouse receiver.
28 [User] button	Press to assign a frequently used item from the available configuration menu items. By pressing the button the assigned menu item selection/adjustment screen is displayed, allowing you to make one-touch settings/adjustments.  p.55 Test Pattern is assigned as the default setting.
29 [SDI] button	Changes to images from the SDI input port.  p.21 This button does not function when using EB-Z8355W/Z8350W/Z10005/Z10000/Z8150.
30 ID switch	Use this switch to enable (On)/disable (Off) ID settings for the remote control.  p.150
31 [HDMI 1/2] button	Each time the button is pressed, the image displayed changes between the HDMI1 input port and HDMI2 input port.  p.21
32 [Search] button	Changes to the next input source that is connected to the projector and is sending an image.  p.20
33 Indicators	A light is emitted when outputting remote control signals.
34 Remote control light-emitting area	Outputs remote control signals.

Installing the batteries

The batteries are not set in the remote control when it is sold. Set the supplied batteries (two, AA alkaline batteries) to use the remote control.

Attention

Make sure you read the Safety Instructions before handling the batteries.

 [Safety Instructions](#)

Procedure

1 Remove the battery cover.

While pushing the battery compartment cover catch, lift the cover up.

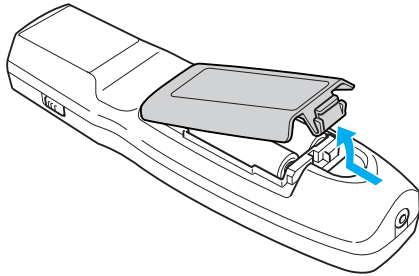

2 Insert the batteries in the correct direction.

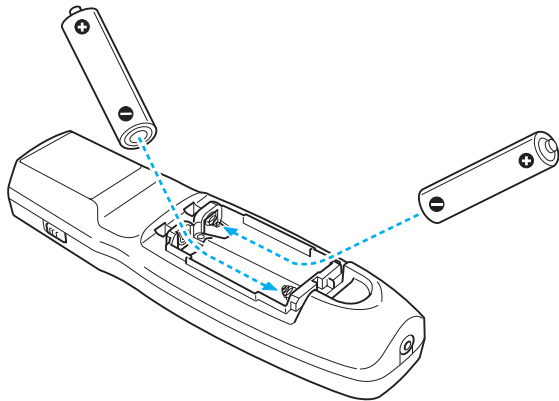

Caution

Check the positions of the (+) and (-) marks inside the battery holder to ensure the batteries are inserted the correct way.

3 Replace the battery cover.

Press until it clicks into place.

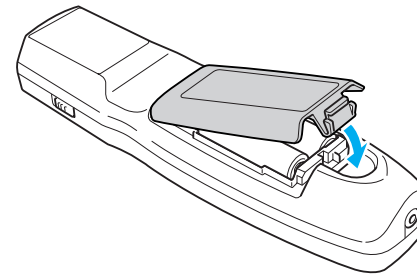

If delays in the responsiveness of the remote control occur or if it does not operate after it has been used for some time, it probably means that the batteries are becoming flat. When this happens, replace them with new batteries. Have two AA size alkaline batteries ready. You cannot use other batteries except for the AA size alkaline.

Operating range of remote control

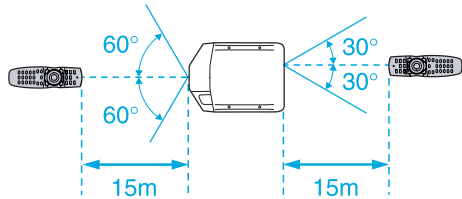

When using the remote control, point the remote control light-emitting area at the remote receiver on the projector. The operating range of the remote control that is provided with the projector is shown below.

Horizontal operating range

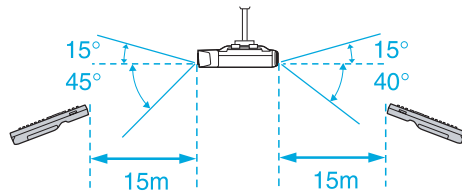

Vertical operating range



- To restrict reception of the operation signals from the remote control, set the **Remote Receiver** on the **Settings** menu.  [p.55](#)
- When using a remote control provided with other Epson projectors, set the **Remote Control Type** on the **Extended** menu.  [p.57](#)
The operating range will depend on the remote control that you use.



Useful Functions

This chapter explains useful tips for giving presentations, and the security functions.

You can change the projected image in the following two ways.

- Changing by Source Search
The projector automatically detects signals being input from connected equipment, and the image being input from the input port is projected.
- Changing directly to the target image
You can use the remote control buttons to change to the target input port.

Automatically Detect Input Signal and Change the Projected Image (Source Search)

You can project the target images quickly by pressing the [Source Search] button because it will switch only to images from input ports to which image signals are being input.

Procedure

When your video equipment is connected, start playback before beginning this operation. When two or more pieces of equipment are connected, press the [Source Search] button until the target image is projected.

Using the Remote Control

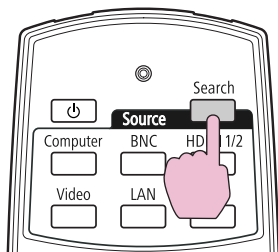

Using the Control Panel

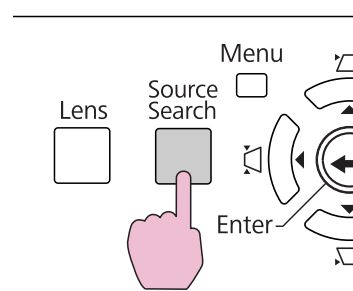

When the [Source Search] button is pressed, a search is made for input ports to which video signals are being input in the following order. (The input port where no image signal is being input is skipped.)

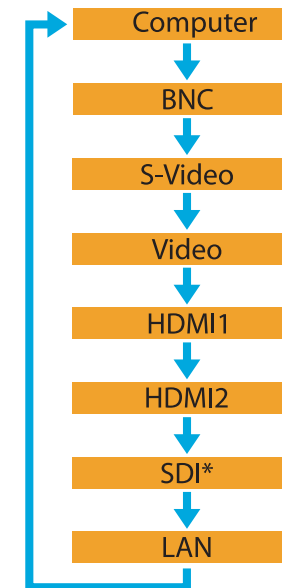

* EB-Z8455WU/Z8450WU only

When switching to LAN, images from computers connected through the network are projected.



The following screen showing the status of image signals remains displayed when only the image that the projector is currently displaying is available, or when no image signal can be found. You can select the input port where the equipment you want to use is connected. If no operation is performed after about 10 seconds, the screen closes.

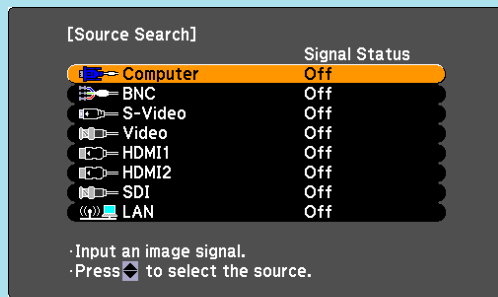

* EB-Z8455WU/Z8450WU only

Switch to the Target Image by Remote Control

You can change directly to the image from the target input port by pressing the following buttons on the remote control. 🖱️ "Remote Control" [p.15](#)

When switching to LAN, images from computers connected through the network are projected.

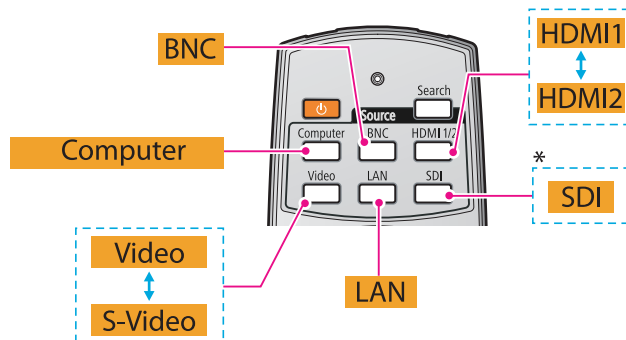

You can select the aspect mode according to the type of input signal, ratio of height and width, and resolution to switch the Aspect Ratio of the projected image. The aspect modes are listed below. The aspect modes that can be set depend on the type of image that is being projected.

EB-Z8455WU/Z8450WU/Z8355W/Z8350W

Aspect mode	Explanation
Normal	Projects to the full projection size retaining the aspect ratio of the input image.
Auto	Projects in an appropriate aspect ratio based on information from the signal being input.
16:9	Projects to the full projection size at an aspect ratio of 16:9.
16:9 (Up)	Projects to the full projection size at an aspect ratio of 16:9 on the top of the screen.
16:9 (Down)	Projects to the full projection size at an aspect ratio of 16:9 on the bottom of the screen.
Full	Projects at full size.
Zoom	Projects the input image enlarged to the full lateral direction size as the aspect ratio remains. Parts that extend beyond the projection size are not projected.
Native	Projects at the resolution of the input image size to the center of the screen. This is ideal for projecting clear images. If the image resolution exceeds the panel resolution of this projector (EB-Z8355W/Z8350W: 1280x800, EB-Z8455WU/Z8450WU: 1920x1200), the edges of the image are not projected.

EB-Z10005/Z10000/Z8150

Aspect mode	Explanation
Normal	Projects to the full projection size retaining the aspect ratio of the input image.

Aspect mode	Explanation
Auto	Projects in an appropriate aspect ratio based on information from the signal being input.
4:3	Projects to the full projection size at an aspect ratio of 4:3. This is suitable for images at an aspect ratio of 5:4 (1280x1024, etc) at full projection size.
16:9	Projects at an aspect ratio of 16:9. This is suitable for projecting to the full screen size of 16:9.
16:9 (Up)	Projects to the full projection size at an aspect ratio of 16:9 on the top of the screen.
16:9 (Down)	Projects to the full projection size at an aspect ratio of 16:9 on the bottom of the screen.
Native	Projects at the resolution of the input image size to the center of the screen. This is ideal for projecting clear images. If the image resolution exceeds the panel resolution of this projector (1024x768), the edges of the image are not projected.

Procedure

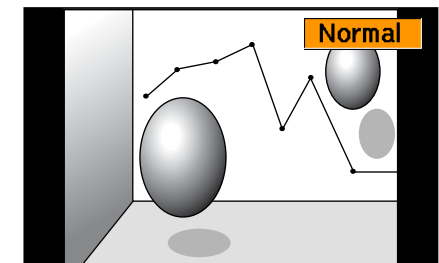
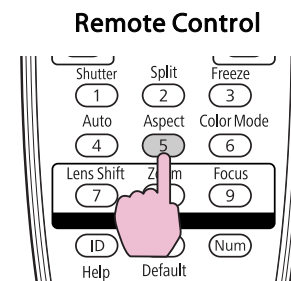

The aspect mode name is displayed on the screen by pressing the button. If you press the button while the aspect mode name is displayed on the screen, it changes to the next aspect mode.



- The aspect mode can also be set using **Aspect** in the **Signal** menu from the configuration menu. [p.53](#)
- When **Scale** on the **Signal** menu is set to **On** and **Scale Mode** is set to **Full Display**, you cannot change the aspect mode.

- 5 Full
- 6 Zoom
- 7 Native

Changing the Aspect Mode (EB-Z8455WU/ Z8450WU)

Projecting images from video equipment or from the HDMI1/2 or SDI input port

Each time the [Aspect] button on the remote control is pressed, the aspect mode changes in the order **Auto (Normal when projecting from the SDI input port)**, **16:9**, **16:9 (Up)**, **16:9 (Down)**, **Full**, **Zoom**, and **Native**.

[p.22](#)

Example: 720p signal input (resolution: 1280x720, aspect ratio: 16:9)

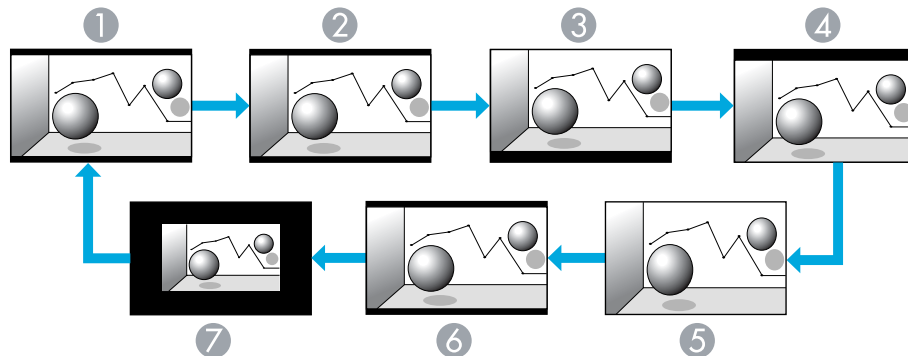

- 1 Auto/Normal
- 2 16:9
- 3 16:9 (Up)
- 4 16:9 (Down)

Projecting images from a computer

Each time the [Aspect] button on the remote control is pressed, the aspect mode changes in the order **Normal**, **16:9**, **16:9 (Up)**, **16:9 (Down)**, **Full**, **Zoom**, and **Native**. [p.22](#)

Projection examples for each aspect mode are shown below.

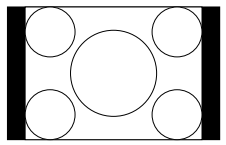
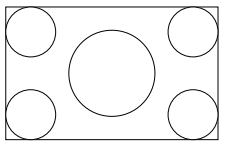
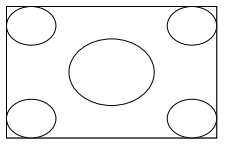
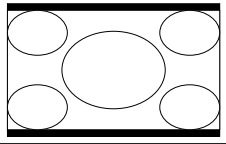
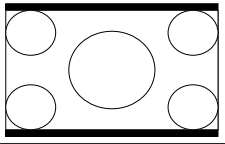
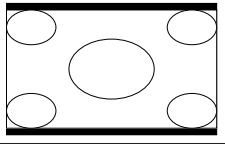
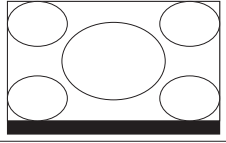
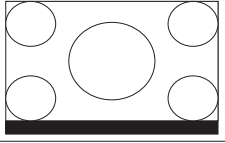
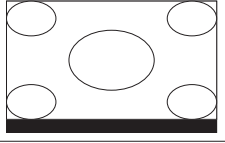
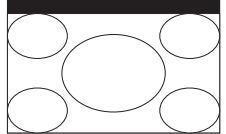
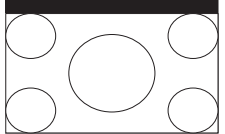
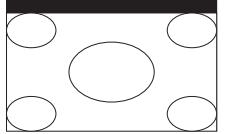
Aspect mode	Input Signal		
	XGA 1024X768(4:3)	WXGA 1280X800(16:10)	WUXGA 1920X1200(16:10)
Normal			
16:9			
16:9 (Up)			
16:9 (Down)			

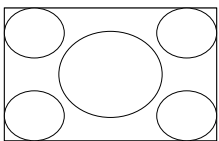
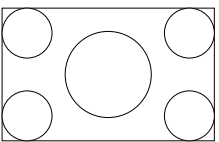
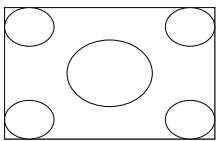
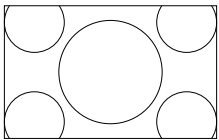
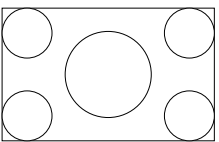
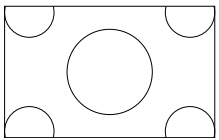
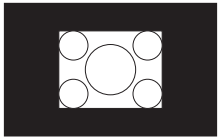
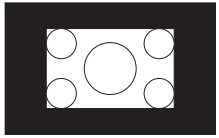
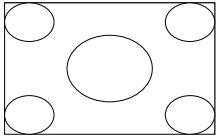
Aspect mode	Input Signal		
	XGA 1024X768(4:3)	WXGA 1280X800(16:10)	WUXGA 1920X1200(16:10)
Full			
Zoom			
Native			



If parts of the image are missing or it cannot project everything, set **Wide** or **Normal** in **Resolution** from the configuration menu depending on the size of the computer panel. [p.53](#)

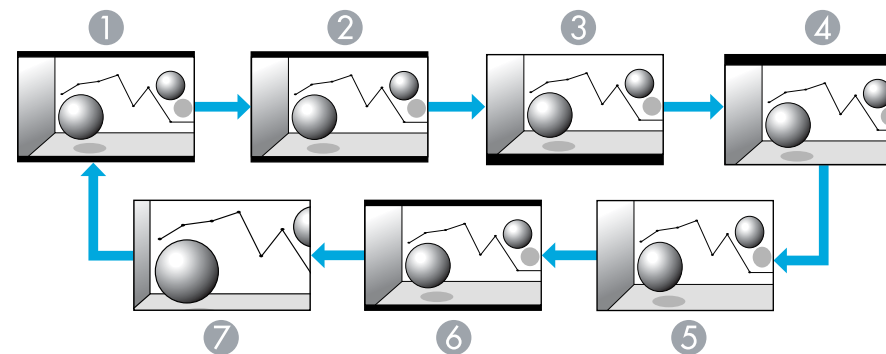

- ① Auto
- ② 16:9
- ③ 16:9 (Up)
- ④ 16:9 (Down)
- ⑤ Full
- ⑥ Zoom
- ⑦ Native

Changing the Aspect Mode (EB-Z8355W/Z8350W)

Projecting images from video equipment or from the HDMI1/2 input port

Each time the [Aspect] button on the remote control is pressed, the aspect mode changes in the order **Auto**, **16:9**, **16:9 (Up)**, **16:9 (Down)**, **Full**, **Zoom**, and **Native**. [p.22](#)

Example: 1080p signal input (resolution: 1920x1080, aspect ratio: 16:9)

Projecting images from a computer

Each time the [Aspect] button on the remote control is pressed, the aspect mode changes in the order **Normal**, **16:9**, **16:9 (Up)**, **16:9 (Down)**, **Full**, **Zoom**, and **Native**. [p.22](#)

Projection examples for each aspect mode are shown below.

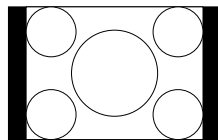
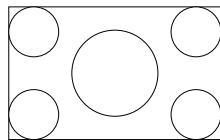
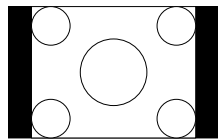
Aspect mode	Input Signal		
	XGA 1024X768(4:3)	WXGA 1280X800(16:10)	SXGA 1280X1024(5:4)
Normal			

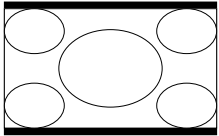
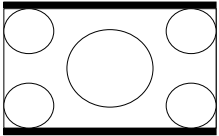
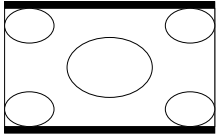
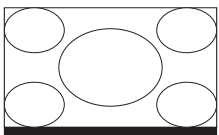
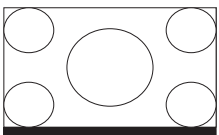
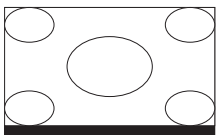
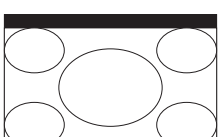
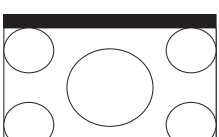
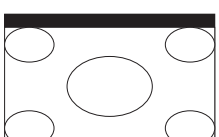
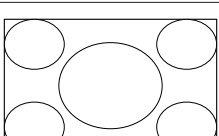
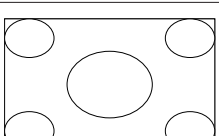
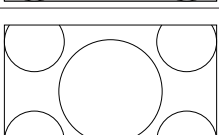
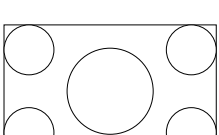
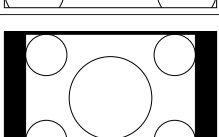
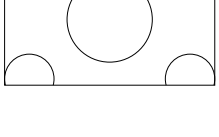
Aspect mode	Input Signal		
	XGA 1024X768(4:3)	WXGA 1280X800(16:10)	SXGA 1280X1024(5:4)
16:9			
16:9 (Up)			
16:9 (Down)			
Full			
Zoom			
Native			



If parts of the image are missing or it cannot project everything, set **Wide** or **Normal** in **Resolution** from the configuration menu depending on the size of the computer panel.  p.53

Changing the Aspect Mode (EB-Z10005/Z10000/Z8150)

Projecting images from video equipment

Each time the [Aspect] button on the remote control is pressed, the aspect mode changes in the order **Auto**, **4:3**, **16:9**, **16:9 (Up)**, and **16:9 (Down)**.  p.22

When inputting a 720p/1080i/1080p signal and the aspect mode is set to **4:3**, a 4:3 zoom will be applied (the right and left sides of the image will be cut off).

Example: 720p signal input (resolution: 1280x720, aspect ratio: 16:9)

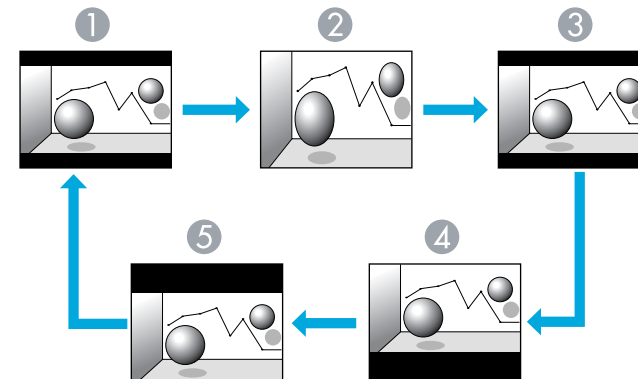

- ① Auto
- ② 4:3
- ③ 16:9
- ④ 16:9 (Up)
- ⑤ 16:9 (Down)

Projecting images from the HDMI1/2 input port

Each time the [Aspect] button on the remote control is pressed, the aspect mode changes in the order **Auto**, **4:3**, **16:9**, **16:9 (Up)**, **16:9 (Down)**, and **Native**.  [p.22](#)

Example: 1080p signal input (resolution: 1920x1080, aspect ratio: 16:9)

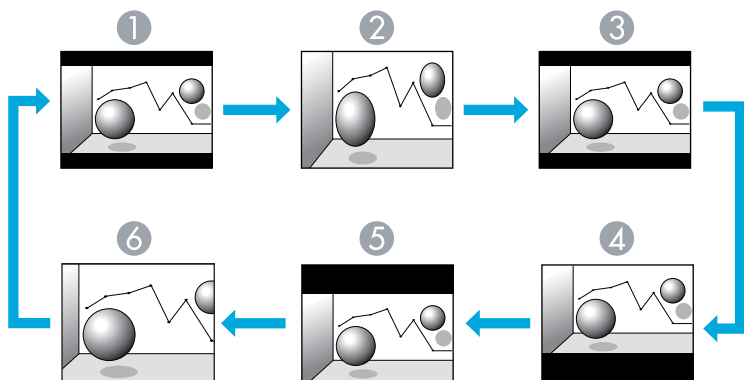

- ① Auto
- ② 4:3
- ③ 16:9
- ④ 16:9 (Up)
- ⑤ 16:9 (Down)
- ⑥ Native

Projecting images from a computer

Each time the [Aspect] button on the remote control is pressed, the aspect mode changes in the order **Normal**, **4:3**, **16:9**, **16:9 (Up)**, **16:9 (Down)**, and **Native**.  [p.22](#)

Projection examples for each aspect mode are shown below.

Aspect mode	Input Signal		
	XGA 1024X768(4:3)	WXGA 1280X800(16:10)	SXGA 1280X1024(5:4)
Normal			
4:3			
16:9			
16:9 (Up)			
16:9 (Down)			
Native			



If parts of the image are missing or it cannot project everything, set **Wide** or **Normal** in **Resolution** from the configuration menu depending on the size of the computer panel.  [p.53](#)

You can easily obtain the optimum image quality simply by selecting the setting that best corresponds to your surroundings when projecting. The brightness of the image varies depending on the mode selected.

Mode	Application
Dynamic	Ideal for use in a bright room. This is the brightest mode.
Presentation	Ideal for making presentations using color materials in a bright room.
Theatre	Ideal for watching films in a dark room. Gives images a natural tone almost like an original source.
Photo*1	Ideal for projecting still pictures, such as photos, in a bright room. The images are vivid and brought into contrast.
Sports*2	Ideal for watching TV programmes in a bright room. The images are vivid and brought to life.
sRGB	Ideal for images that conform to the <u>sRGB</u> color standard.
DICOM SIM*1	Ideal for projecting X-ray photographs and other medical images. This produces images with clear shadows. The projector is not a medical device and cannot be used for medical diagnosis.
Multi-Projection	Ideal for projecting from multiple projectors. Minimize the color tone difference between each projected image.



*1 This can be selected when inputting RGB signals, or when LAN is selected as the input source.

*2 This can be selected when inputting component video signals, S-video signals, or composite video signals.

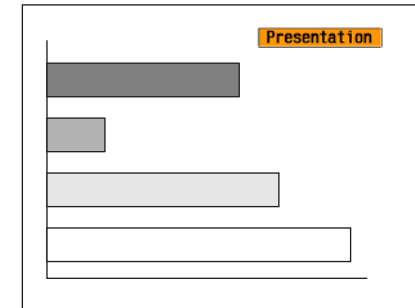
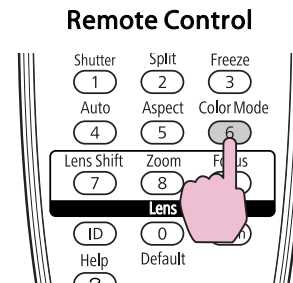
Procedure



The Color Mode name is displayed on the screen by pressing the button. If you press the button while the Color Mode name is displayed on the screen, it changes to the next Color Mode.

 The color mode can also be set using **Color Mode** in the **Image** menu from the configuration menu.  [p.51](#)

A split screen can be used to divide the screen into a left screen (A) and a right screen (B) and simultaneously project two images.

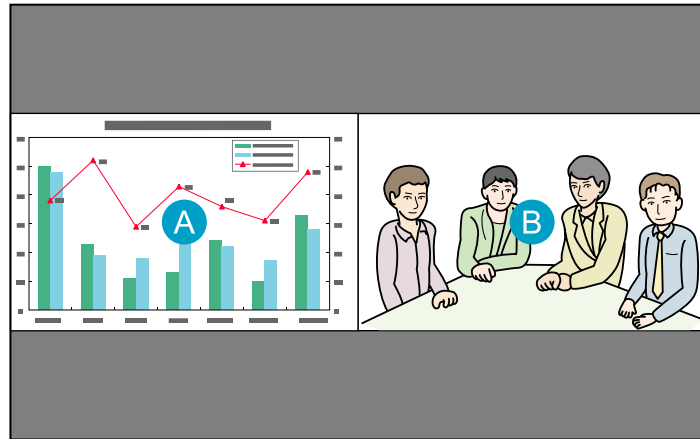

Left Screen	Right Screen							
	Com-puter	BNC	S-Vid-eo	Video	HDMI 1	HDMI 2	LAN	SDI*
HDMI 2	✓	✓	✓	✓	-	-	✓	✓
LAN	✓	✓	✓	✓	✓	✓	-	-
SDI*	✓	✓	✓	✓	✓	✓	-	-

* EB-Z8455WU/Z8450WU only

Operating Procedures

Projecting on a split screen

Procedure

1

Press the [Split] button on the remote control while the projector is projecting.

The currently selected input source will be displayed on the left screen.

Remote Control

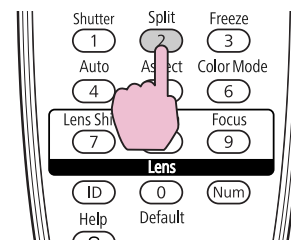

Input Sources for Split Screen Projection

The combinations of input sources that can be projected on a split screen are listed below.

Left Screen	Right Screen							
	Com-puter	BNC	S-Vid-eo	Video	HDMI 1	HDMI 2	LAN	SDI*
Com-puter	-	-	✓	✓	✓	✓	✓	✓
BNC	-	-	✓	✓	✓	✓	✓	✓
S-Vid-eo	✓	✓	-	-	✓	✓	✓	✓
Video	✓	✓	-	-	✓	✓	✓	✓
HDMI 1	✓	✓	✓	✓	-	-	✓	✓



The split screen can also be started from **Split Screen** on the configuration menu. p.55

- 2 Press the [Menu] button on the remote control or the control panel.

The Split Screen Setup will be displayed.

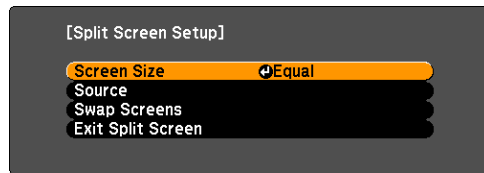

The Split Screen Setup will also be displayed when the [Source Search] button is pressed on the remote control or control panel or when a Source button is pressed on the remote control.

- 3 Select "Source" and press the [Enter] button.
- 4 Select each input source for "Left" and "Right".

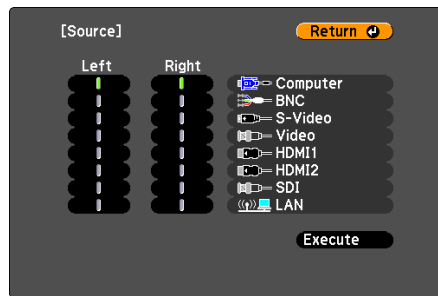

Only the input sources that can be combined can be selected.
☞ "Input Sources for Split Screen Projection" p.29

- 5 Select "Execute" and press the [Enter] button.

To switch the projected image during split screen projection, start the procedure from step 2.



Analog RGB signals that are output from the left screen can be displayed on an external monitor. ☞ p.161

Switching the left and right screens

Use the following procedure to switch the images displayed on the left and right screens.

Procedure

- 1 Press the [Menu] button on the remote control or the control panel during split screen projection.
- 2 Select "Swap Screens" and press the [Enter] button.

The images on the left and right screens will be swapped.

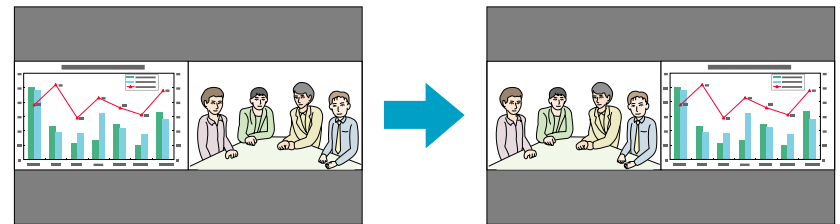

Switching the left and right image sizes

Procedure

- 1 Press the [Menu] button on the remote control or the control panel during split screen projection.
- 2 Select "Screen Size" and press the [Enter] button.
- 3 Select the image size to display and then press the [Enter] button.

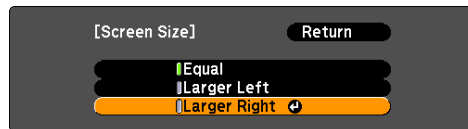

- 4 Press the [Menu] button to end the setting procedure.

The projected images will appear as shown below after setting the screen size.

Equal



Larger Left

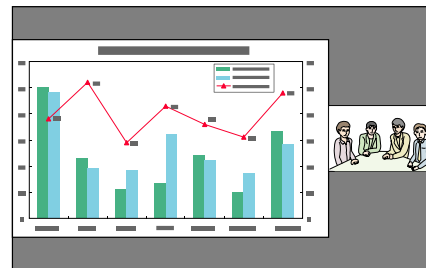

Larger Right

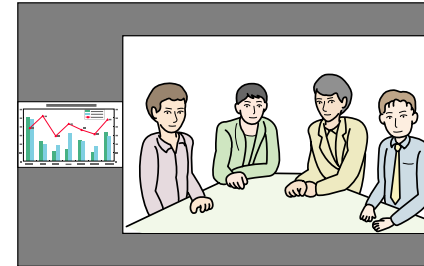

- You cannot enlarge both the left screen and right screen images at the same time.
- When one image is enlarged, the other image is reduced.
- Depending on the video signals that are input, the images on the left and right may not appear to be the same size even if **Equal** is set.

Ending the split screen

Procedure

To end the split screen, press the [Esc] button on the remote control or control panel.

The following steps can also be used to end the split screen.

- Press the [Split] button on the remote control.
- Select **Exit Split Screen** in the **Split Screen Setup** and then press the [Enter] button.

Restrictions during Split Screen Projection

Operating restrictions

The following operations cannot be performed during split screen projection.

- Setting the configuration menu
- E-zoom
- Switching the aspect mode (The aspect mode will be set to **Normal**.)
☛ [p.22](#)
- Operations using the [User] button on the remote control
- Auto Iris

Help can be displayed only when image signals are not input or when an error or warning notification is displayed.

Restriction relating to images

- The default values for the **Image** menu are applied to the image on the right screen. However, the settings for the image projected on the left screen are applied to the image on the right screen for the **Color Mode**, **Abs. Color Temp.**, **Advanced**, **Super-resolution**, and **Frame Interpolation**.
- The setting value **Off** for **Progressive** and **Noise Reduction** is applied to the image on the right screen. ☛ [Signal menu p.53](#)
- When there is no image signal input, the display screen will be the color that is set on Display Background. The display will be **Blue** when the **Logo** is selected.
- When the shutter operation is performed, the display screen will be **Black**.

Hiding the Image Temporarily (Shutter)

You can use this when you want to focus the audience's attention on what you are saying, or if you do not want to show details such as when you are changing between files during presentations from a computer.

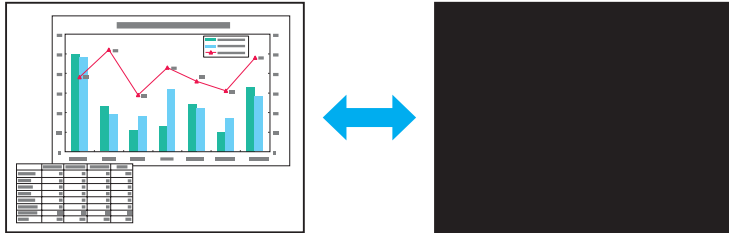

Make sure that the **Shutter Button** is set to **Electric Shutter** from **Operation** in the **Extended** menu.

Procedure

Using the Remote Control

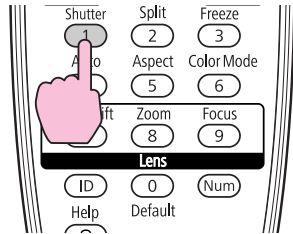

Using the Control Panel

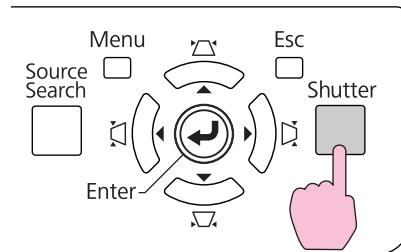

Each time you press the buttons, the electric shutter closes or opens.



- When the shutter is closed and no operations are performed for about 30 minutes, the projector enters Sleep Mode and turns off automatically. If you do not want Sleep Mode to activate, change the **Shutter Timer** setting to **Off** from **Operation** in the **Extended** menu. [p.57](#)
- If you press [⏻] button while the shutter is closed, the shutter automatically opens and a message requesting confirmation to turn off the power is displayed on the screen.
- The Lamp1 and Lamp2 indicators flash green while the shutter is activated.
- When an event that is set in Schedule is executed, the shutter is canceled.

Freezing the Image (Freeze)

When the freeze function is activated on moving images, the frozen image continues to be projected on the screen, so you can project a moving image one frame at a time like a still photo. Also, you can perform operations such as changing between files during presentations from a computer without projecting any images if the freeze function is activated beforehand.

Procedure

Remote Control

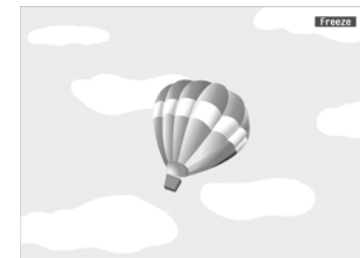
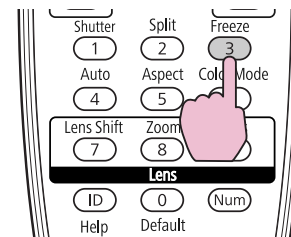

Each time you press the button, Freeze turns on or off.



- The image source continues to play back the moving images even while Freeze is on, and so it is not possible to resume projection from the point where it was paused.
- If the [Freeze] button is pressed while the configuration menu or a Help screen is displayed, the menu or Help screen being displayed is cleared.
- Freeze still works while E-Zoom is being used.

Pointer Function (Pointer)

This allows you to move a Pointer icon on the projected image, and helps you draw attention to the area you are talking about.

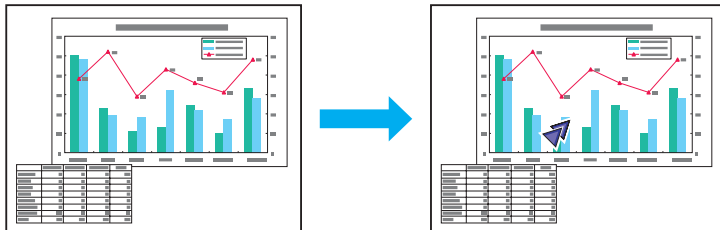

Procedure

- 1 Display the Pointer.

Remote Control

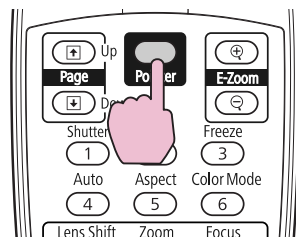

Each time you press the button, the pointer appears or disappears.

- 2 Move the Pointer icon (↖).

Remote Control

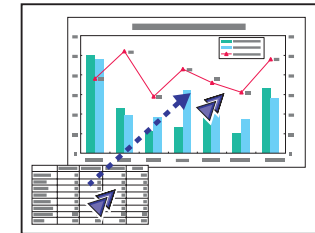
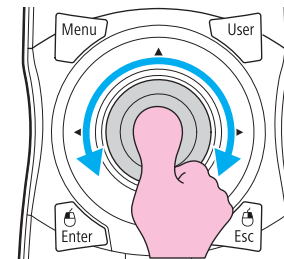

You can choose from three different kinds of Pointer icon (↖, ✖, ↘) in **Settings - Pointer Shape** from the configuration menu.
p.55

Enlarging Part of the Image (E-Zoom)

This is useful when you want to expand images to see them in greater detail, such as graphs and tables.

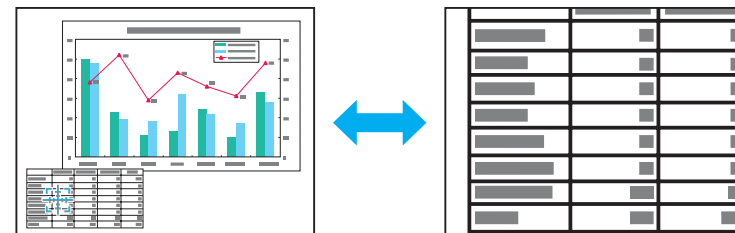

Procedure

1 Start E-Zoom.

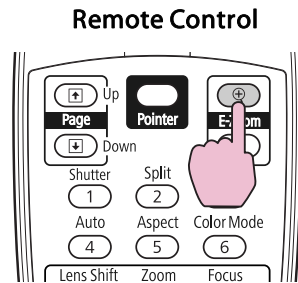

2 Move the (⊞) to the area of the image that you want to enlarge.

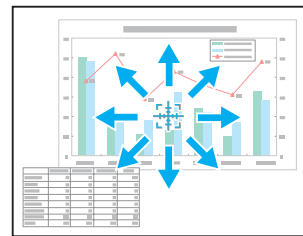
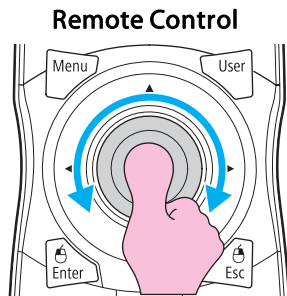

3 Enlarge.

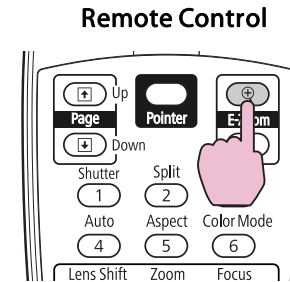

Each time the button is pressed, the area is expanded. You can expand quickly by holding the button down.

You can reduce the enlarged image by pressing the [⊖] button. Press the [Esc] button to cancel.



- The enlargement ratio appears on the screen. The selected area can be enlarged to between 1 to 4 times in 25 incremental steps.
- After the image is enlarged, it can be scrolled with the [⊞] button.
- E-Zoom is canceled when performing some functions such as keystone or Auto Setup.
- When the Scale is set to On, the E-Zoom cannot be used.

You can save the image that is currently being projected as a User's Logo. The saved user's logo can be used as the display image when there is no video signal input or during starting up.



Once a User's Logo has been saved, the logo cannot be returned to the factory default.

Procedure

1

Project the image you want to use as the User's Logo, and then press the [Menu] button.

Using the Remote Control

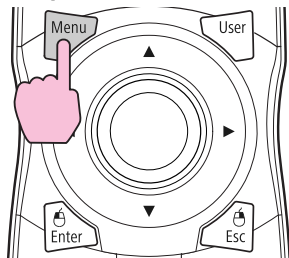

Using the Control Panel

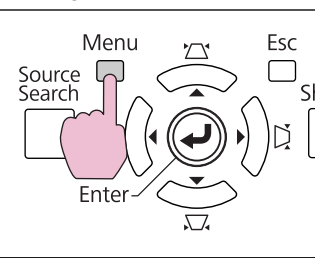

2

Select Extended - "User's Logo" from the configuration menu.
☛ "Using the Configuration Menu" p.47

Check the buttons you can use and the operations they perform in the guide under the menu.

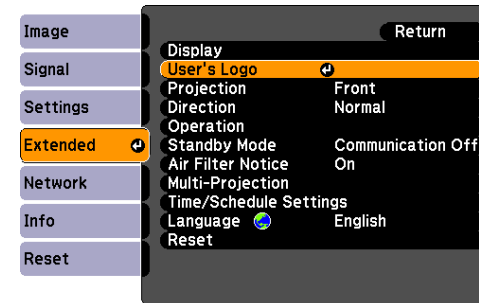

- If **User's Logo Protect** from **Password Protect** is set to **On**, a message is displayed and the user's logo cannot be changed. You can make changes after setting **User's Logo Protect** to **Off**.
☛ p.38
- If **User's Logo** is selected when keystone, E-Zoom, or Aspect are being performed, the function currently being performed is cancelled.

3

When "Choose this image as the User's Logo?" is displayed, select "Yes".



When you press the [Enter] button on the Remote Control or the Control panel, the screen size may change according to the signal as it changes to the resolution of the image signal.

- 4 Move the box to select the part of the image to use as the User's Logo.



Using the Remote Control

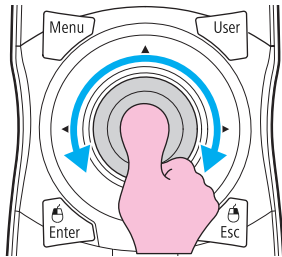

Using the Control Panel

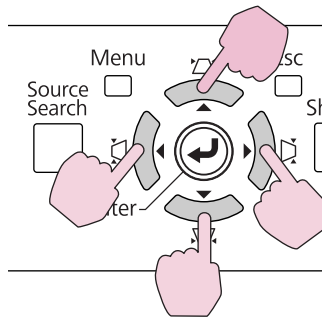

You can save at up to 400 × 300 dots in size.

- 6 Select the zoom factor from the zoom setting screen.

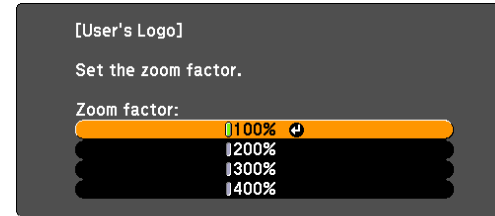

400% is displayed only when using EB-Z8455WU/Z8450WU.

- 7 When the message "Save this image as the User's Logo?" is displayed, select "Yes".



The image is saved. After the image has been saved, the message "Completed." is displayed.



- To use the saved user's logo as the screen image, set it in the **Display** settings under the **Extended** menu. [p.57](#)
- When a User's Logo is saved, the previous User's Logo is erased.
- Saving the user's logo may take approximately 15 seconds. Do not use the projector or any connected equipment while it is saving, otherwise malfunctions may occur.

- 5 When "Select this image?" is displayed, select "Yes".

The projector has the following enhanced security functions.

- **Password Protect**
You can limit who can use the projector.
- **Control Panel Lock/Lens Operation Lock/Remote control button lock**
You can prevent people changing the settings on the projector without permission.  [p.40](#)
- **Anti-Theft Lock**
The projector is equipped with various types of anti-theft security devices.  [p.43](#)

2. User's Logo Protect

Even if someone tries to change the User's Logo set by the owner of the projector, it cannot be changed. When **User's Logo Protect** is set to **On**, the following setting changes for the User's Logo are prohibited.

- Capturing a User's Logo
- Settings for **Display Background**, and **Startup Screen** from **Display** in the configuration menu

3. Network Protect

When **Network Protect** is set to **On**, setting changes for **Network** menu in the configuration menu are prohibited.

Managing Users (Password Protect)

When Password Protect is activated, people who do not know the Password cannot use the projector to project images even if the projector power is on. Furthermore, the user's logo that is displayed when you turn on the projector cannot be changed. This acts as an anti-theft device as the projector cannot be used even if it is stolen. At the time of purchase, Password Protect is not activated.

Type of Password Protect

The following three kinds of Password Protect settings can be made according to how the projector is being used.

1. Power On Protect

When **Power On Protect** is **On**, you need to enter a preset Password after the projector is plugged in and turned on (this also applies to Direct Power On). If the correct Password is not entered, projection does not start.

Setting Password Protect

Use the following procedure to set Password Protect.

Procedure



During projection, hold down the [Freeze] button for about five seconds.

The Password Protect setting menu is displayed.

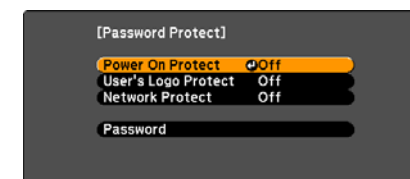
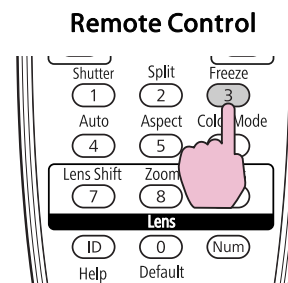



- If Password Protect is already activated, you must enter the Password.
If the Password is entered correctly, the Password Protect setting menu is displayed. ➡ "Entering the Password" p.39
- When the Password is set, stick the Password protect sticker in a visible position on the projector as a further theft deterrent.

2 Turn on "Power On Protect".

- (1) Select **Power On Protect**, and then press the [Enter] button.
- (2) Select **On**, and then press the [Enter] button.
- (3) Press the [Esc] button.

3 Turn on "User's Logo Protect".

- (1) Select **User's Logo Protect**, and then press the [Enter] button.
- (2) Select **On**, and then press the [Enter] button.
- (3) Press the [Esc] button.

4 Turn on "Network Protect".

- (1) Select **Network Protect**, and then press the [Enter] button.
- (2) Select **On**, and then press the [Enter] button.
- (3) Press the [Esc] button.

5 Set the Password.

- (1) Select **Password**, and then press the [Enter] button.
- (2) The message "Change the password?" is displayed, select **Yes** and then press the [Enter] button. The default setting for the Password is "0000". Change this to your own desired password. If you select **No**, the screen shown in step 1 is displayed again.
- (3) While holding down the [Num] button, enter a four digit number using the numeric buttons. The number entered is displayed as "* * * *". When you enter the fourth digit, the confirmation screen is displayed.

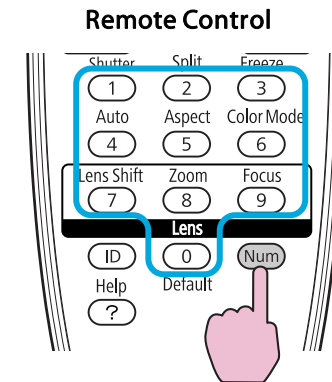

- (4) Re-enter the Password.
The message "Password accepted." is displayed.
If you enter the Password incorrectly, a message is displayed prompting you to re-enter the password.

Entering the Password



When the Password entry screen is displayed, enter the Password using the numeric buttons on the remote control.

Procedure

While holding down the [Num] button, enter the Password by pressing the numeric buttons.

When you enter the correct Password, projection begins.

Attention

- If an incorrect password is entered three times in succession, the message "**The projector's operation will be locked.**" is displayed for about five minutes, and then the projector switches to standby mode. If this happens, disconnect the power plug from the electrical outlet and then reinsert it and turn the projector's power back on. The projector displays the Password entry screen again so that you can enter the correct Password.
- If you have forgotten the password, make a note of the "Request Code: xxxxx" number that appears on the screen and contact the nearest address provided in the Support and Service Guide.  [Epson Projector Contact List](#)
- If you continue to repeat the above operation and input the wrong Password thirty times in succession, the following message is displayed and the projector does not accept any more Password entries. "**The projector's operation will be locked. Contact Epson as described in your documentation.**"  [Epson Projector Contact List](#)

Restricting Button Operation

The following three kinds of operation restriction functions are available with the projector.

- Control Panel Lock
This is useful at events or shows when you want to deactivate all buttons during projection or at schools when you want to limit button operation.
- Lens Operation Lock
This function deactivates all buttons on the remote control related to the lens operation to prevent improper lens adjustment after it is properly adjusted.
- Remote control button lock
This function deactivates buttons except for main buttons needed for basic remote control operation, to prevent mistakes in operations.

Control Panel Lock

Perform one of the following to lock the operation buttons on the control panel. Even if the control panel is locked, you can still use the remote control as usual.

- Full Lock
All of the buttons on the control panel are locked. You cannot perform any operations from the control panel, including turning the power on or off.
- Partial Lock
All of the buttons on the Control panel, except for the [⏻] button, are locked.

Procedure

- 1 During projection, press the [Menu] button and select Settings - "Control Panel Lock" from the configuration menu.  "Using the Configuration Menu" p.47

Using the Remote Control

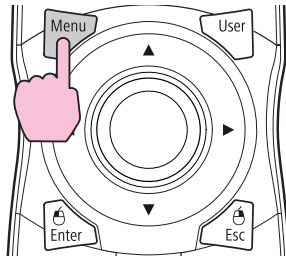

Using the Control Panel

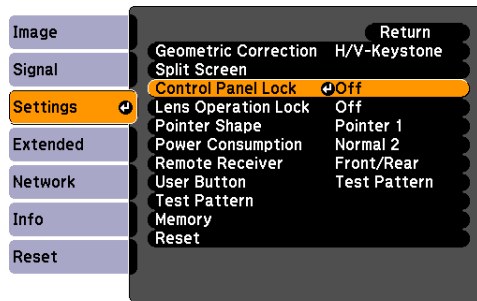
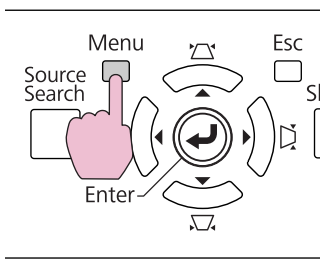

- 2 Select either "Full Lock" or "Partial Lock" according to your purpose.

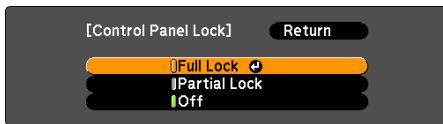

- 3 Select "Yes" when the confirmation message is displayed.

The control panel buttons are locked according to the setting you chose.



You can release the control panel lock by one of the following two methods.

- From the remote control, select Off in Settings - Control Panel Lock from the configuration menu.  p.55
- Press and hold down the [Enter] button on the Control panel for about seven seconds, a message is displayed and the lock is released.

Lens Operation Lock

This function locks the following buttons on the remote control related to the lens operation.

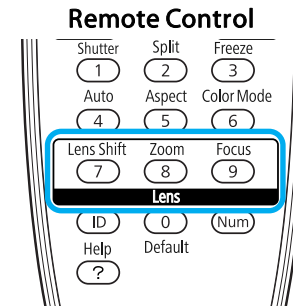

Procedure

- 1 Press the [Menu] button, and select Settings - "Lens Operation Lock" from the configuration menu. "Using the Configuration Menu" p.47

Using the Remote Control

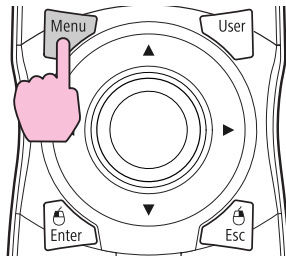

Using the Control Panel

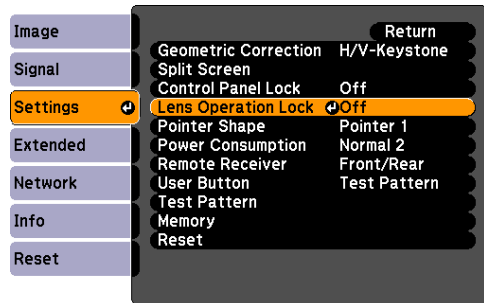
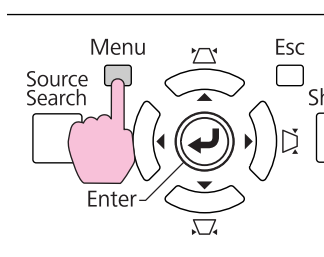

- 2 Select "On".

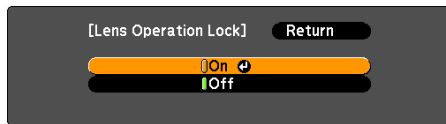

The buttons related to the lens operation are locked according to the setting you chose.

Remote control button lock

This function locks the following buttons on the remote control.

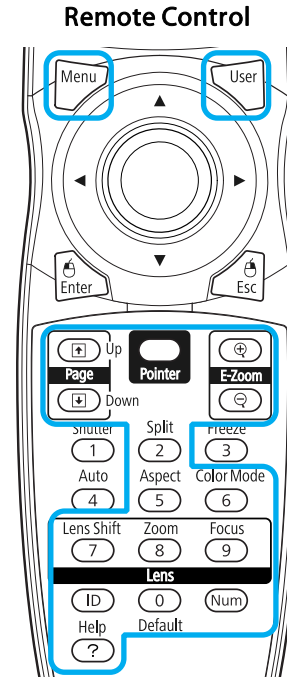

Procedure

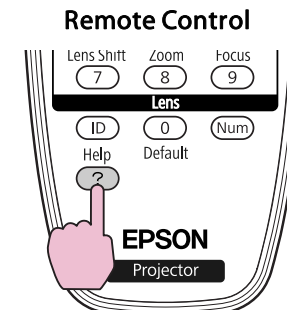

Each time **[Help]** button is pressed for at least 5 seconds, the remote control button lock turns on or off.



Even if the remote control button lock is on, the following operations are possible.

- Resetting default for the Remote Receiver setting
- Entering numbers using the [Num] button and the numeric buttons

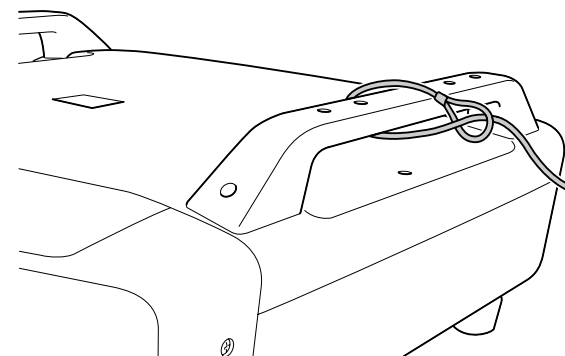

Anti-Theft Lock

As the projector is often setup on ceiling mounts and left in rooms unattended, the projector includes the following security devices to prevent someone from taking the projector.

- Security slot
The Security slot is compatible with the Microsaver Security System manufactured by Kensington. You can find details about the Microsaver Security System on the Kensington homepage <http://www.kensington.com/>.
- Handle
A commercially available anti-theft wire lock can be passed through the security cable installation point to secure the projector to a desk or pillar.

Installing the wire lock

Pass an anti-theft wire lock through the handle.

See the documentation supplied with the wire lock for locking instructions.

Settings for the image in the configuration menu can be registered in memory, and can be used when needed. You can register up to ten types of memory.

Available Settings

Setting items in the configuration menu that can be registered in memory are listed below.

Top Menu	Sub Menu
Image	All setting items
Signal	Progressive Frame Interpolation*1 Super-resolution Noise Reduction Mosquito NR HDMI Video Range SDI Video Range*1 Scale Overscan
Settings	Power Consumption*2
Extended	Brightness Level*2 Edge Blending Multi-screen

*1 EB-Z8455WU/Z8450WU only

*2 EB-Z8455WU/Z8450WU/Z8355W/Z8350W/Z10005/Z10000 only

Saving/Loading/Erasing the Memory

Saving the memory

Use the following procedure to register the memory.

Procedure

- 1 During projection, press the [Menu] button on the remote control or control panel, and select Settings - "Memory" from the configuration menu. ➡ "Using the Configuration Menu" p.47

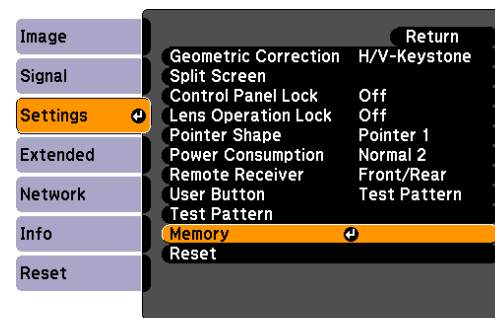

- 2 Select "Save Memory", and then press the [Enter] button.

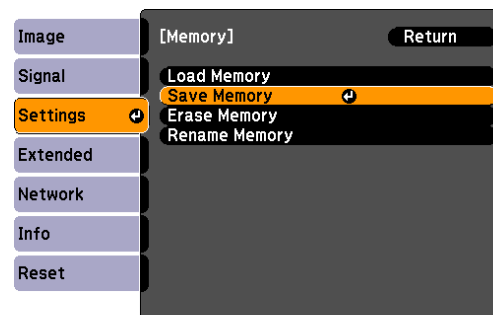

- 3 Select the memory name that you want to register the setting, and then press the [Enter] button.

Current settings are registered in the memory.



If the mark on the left of the memory name is turned green, it means the memory has already been registered. When you select the registered memory, a message will ask if you want to overwrite the memory. If you select **Yes**, the previous settings are deleted and the current settings are registered.

Loading the memory

Procedure

- 1 During projection, press the [Menu] button on the remote control or control panel, and select Settings - "Memory" from the configuration menu.
- 2 Select "Load Memory", and then press the [Enter] button.
- 3 Select the desired memory, and then press the [Enter] button.
The settings registered to the memory are applied.

Erasing the memory

Procedure

- 1 Press the [Menu] button on the remote control or control panel, and select Settings - "Memory" from the configuration menu.
- 2 Select "Erase Memory", and then press the [Enter] button.
- 3 Select the desired memory, and then press the [Enter] button.



- 4 Select "Yes" when the confirmation message is displayed.
The registered memory will be erased.

Renaming the memory

Procedure

- 1 Press the [Menu] button on the remote control or control panel, and select Settings - "Memory" from the configuration menu.
- 2 Select "Rename Memory", and then press the [Enter] button.
- 3 Select the desired memory, and then press the [Enter] button.
- 4 Enter the memory name using the soft keyboard.  "Soft Keyboard Operations" [p.61](#)
Press [Finish] to complete renaming.



Configuration Menu

This chapter explains how to use the configuration menu and its functions.

The screen shots may be different from those shown in this chapter depending on your projector model.

1 Selecting from the top menu

2 Selecting from the sub menu

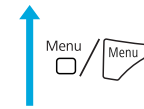
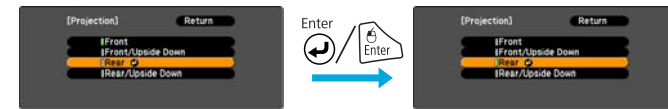
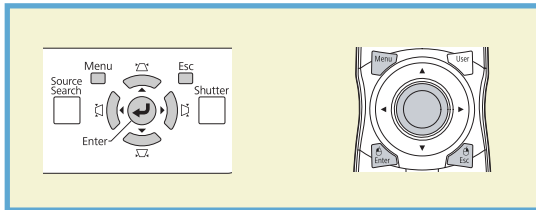
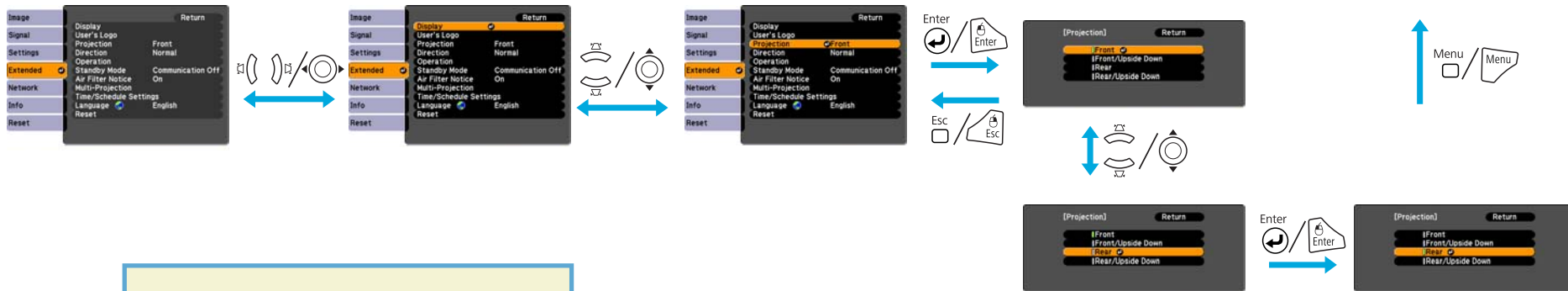

3 Setting each item

4 Exit



Configuration Menu

Items that can be set vary depending on the image signal or input source currently being projected, or the model you are using.

Top Menu	Sub Menu	Items/Values
Image Menu  p.51	Color Mode	Dynamic, Presentation, Theatre, Photo, Sports, sRGB, DICOM SIM, Multi-Projection
	Brightness	-24 to 24
	Contrast	-24 to 24
	Color Saturation	-32 to 32
	Tint	-32 to 32
	Sharpness	-5 to 5
	Abs. Color Temp.	5000K to 10000K
	Advanced	Gamma, RGB, RGBCMY
	Auto Iris	On, Off
Signal Menu  p.53	Auto Setup	On, Off
	Resolution	Auto, Wide, Normal, Manual
	Tracking	-
	Sync.	-
	Position	-
	Progressive	Off, Video, Film/Auto
	Frame Interpolation*1	Off, Low, Normal, High
	Super-resolution	0 to 3
	Noise Reduction	Off, NR1, NR2
	Mosquito NR	On, Off

Top Menu	Sub Menu	Items/Values	
	HDMI Video Range	Auto, Normal, Expanded	
	SDI Video Range*1	Normal, Expanded	
	Input Signal	Auto, RGB, Component	
	Video Signal	Auto, NTSC, NTSC4.43, PAL, M-PAL, N-PAL, PAL60, SECAM	
	Aspect	Normal, Auto, 4:3, 16:9, 16:9 (Up), 16:9 (Down), Full, Zoom, Native	
	Scale	-	
	Overscan	Auto, Off, 4%, 8%	
	Settings Menu  p.55	Geometric Correction	H/V-Keystone, Quick Corner, Arc Correction, Point Correction
		Split Screen	-
		Control Panel Lock	Full Lock, Partial Lock, Off
Lens Operation Lock		On, Off	
Pointer Shape		Pointer 1, 2, 3	
Power Consumption*2		Normal 1, ECO, Normal 2	
Remote Receiver		Front/Rear, Front, Rear, Off	
User Button		Power Consumption*2, Info, Progressive, Test Pattern, Multi-screen, Resolution, Memory	
Test Pattern		-	
Memory		Load Memory, Save Memory, Erase Memory, Rename Memory	

Top Menu	Sub Menu	Items/Values
Extended Menu ☛ p.57	Display	Menu Position, Messages, Display Background, Startup Screen
	User's Logo	-
	Projection	Front, Front/Upside Down, Rear, Rear/Upside Down
	Direction	Normal, Pointing Up, Pointing Down, Angled Up, Angled Down
	Operation	Direct Power On, Sleep Mode, Sleep Mode Timer, Shutter Button, Shutter Timer, High Altitude Mode, BNC Sync Termination, Remote Control Type, Beep
	Standby Mode	Communication On, Communication Off
	Air Filter Notice	On, Off
	Multi-Projection	Brightness Level*2, Edge Blending, Multi-screen, Projector ID
	Time/Schedule Settings	-
	Language	27 languages
Info Menu ☛ p.77	Lamp Hours	-
	Lamp Status	-
	Source	-
	Input Signal	-
	Resolution	-

Top Menu	Sub Menu	Items/Values
	Video Signal	-
	Refresh Rate	-
	Sync Info	-
	Status	-
	Serial Number	-
	Event ID	-
Reset Menu ☛ p.79	Reset All	-
	Reset Memory	-

*1 EB-Z8455WU/Z8450WU only

*2 EB-Z8455WU/Z8450WU/Z8355W/Z8350W/Z10005/Z10000 only

Network Menu

Top Menu	Sub Menu	Items/Values
Basic Menu ☛ p.62	Projector Name	-
	Web Remote Password	-
	Projector Keyword	On, Off
Wireless LAN Menu ☛ p.63	Wireless LAN Power	On, Off
	Wi-Fi Protected Setup	-
	Wireless LAN system	802.11b/g/n, 802.11b/g
	Connection Mode	Quick, Advanced
	SSID Auto Setting	On, Off
	SSID	-
	Search Access Point	-
	Channel	1ch, 6ch, 11ch
	SSID Display	On, Off
	DHCP	On, Off

Top Menu	Sub Menu	Items/Values
	IP Address	-
	Subnet Mask	-
	Gateway Address	-
	IP Address Display	On, Off
	Region Code	-
Security Menu ☛ p.66	Security	Open, WPA/WPA2-PSK, WPA/WPA2-EAP
Wired LAN Menu ☛ p.70	DHCP	On, Off
	IP Address	-
	Subnet Mask	-
	Gateway Address	-
	IP Address Display	On, Off
Administrator Settings Menu ☛ p.71	Administrator Password	-
	Network Host Name	-
	PJLink Password	-
	Web Control Password	-
	Monitor Password	-
	Secure HTTP	On, Off
	Mail Notification	-
	Manage Certificates	-
	SNMP	-
	Priority gateway	Wired, Wireless
	AMX Device Discovery	On, Off
	Crestron RoomView	On, Off
	Bonjour	On, Off
EPSON Message Broadcasting	On, Off	

Items that can be set vary depending on the image signal or input source currently being projected as shown in the following screen shots. Setting details are saved for each image signal.

RGB Signal/LAN

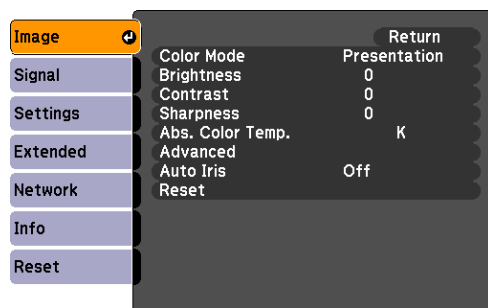

Component Video Signal▶▶/ Composite video Signal▶▶/S-Video Signal▶▶

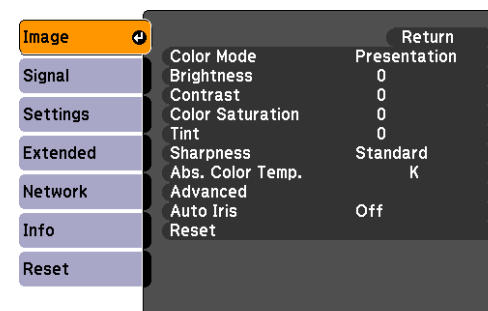

Sub Menu	Function
Color Mode	You can select the quality of the image to suit your surroundings.  p.28
Brightness	You can adjust the image Brightness.
Contrast▶▶	You can adjust the difference between light and shade in the images.
Color Saturation	You can adjust the Color Saturation for the images.
Tint	You can adjust the image Tint.
Sharpness	<p>Standard: You can adjust the image sharpness. To make more-detailed settings, select Advanced.</p> <p>Advanced: The following four items can be set.</p> <p>Thin Line Enhancement: If this parameter is set to a positive value, details such as hair or fabric patterns will be enhanced.</p> <p>Thick Line Enhancement: If this parameter is set to a positive value, the outline, background, and the other main parts of the objects in the image will be enhanced to show them clearly.</p> <p>Vert. Line Enhancement: If this parameter is set to a positive value, vertical lines in the image are enhanced.</p> <p>Horiz. Line Enhancement: If this parameter is set to a positive value, horizontal lines in the image are enhanced.</p>
Abs. Color Temp.	You can adjust the overall tint of the image. You can adjust tints in 10 stages from 5000 K to 10000 K. When a high value is selected, the image becomes tinged with blue, when a low value is selected, the image becomes tinged with red.

Sub Menu	Function
Advanced	<p>You can make adjustments by choosing the following items.</p> <p>Gamma: You can adjust the coloring by selecting one of the gamma correction values, or referring to the projected image or a gamma graph.</p> <p>RGB: You can adjust the individual R (red), G (green), and B (blue) components of the offset and gain.</p> <p>RGBCMY: You can adjust the hue, saturation, and brightness of each color R (red), G (green), B (blue), C (cyan), M (magenta), Y (yellow) individually.</p>
Auto Iris*	<p>(This item can be selected when Dynamic or Theatre is selected as the Color Mode setting from the Image menu.)</p> <p>Set whether or not (On/Off) to adjust to the optimum light status for images being projected.</p> <p>The setting is stored for each Color Mode.</p>
Reset	<p>You can reset all adjustment values for the Image menu functions to their default settings. To return all menu items to their default settings, see  p.79</p>

* This item cannot be set if **Edge Blending** is set to **On**.

Items that can be set vary depending on the image signal or input source currently being projected as shown in the following screen shots. Setting details are saved for each image signal.

You cannot make settings in the Signal menu other than Scale when the input source is LAN.

RGB Signal

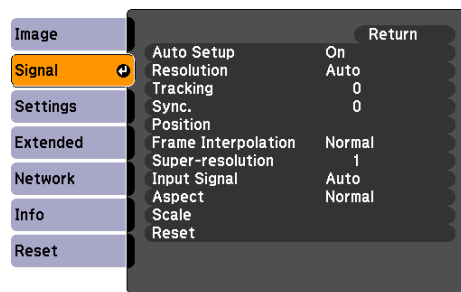

Component Video Signal▶▶

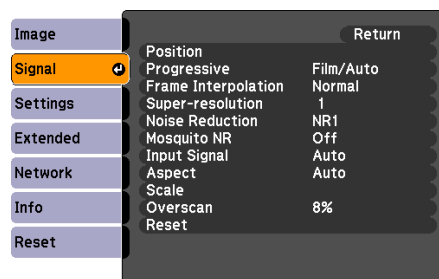

Composite video Signal▶▶/S-Video Signal▶▶

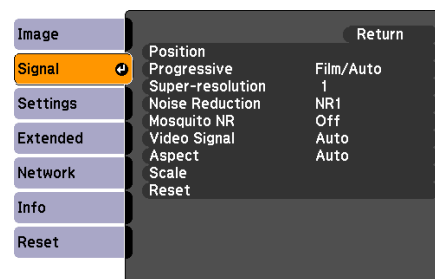

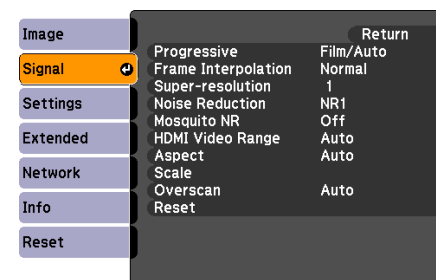

HDMI/SDI*











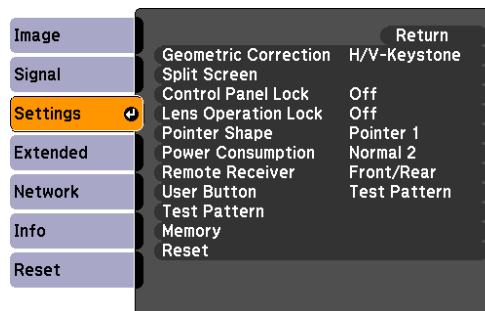



* EB-Z8455WU/Z8450WU only







Sub Menu	Function
Auto Setup	You can select whether or not (On/Off) Auto Setup automatically adjusts the image to the optimum state when the input signal changes.
Resolution	Auto: The resolution of the input signal is automatically identified. Wide, Normal: If the images cannot be projected correctly when Auto is set, set this menu. Set to Wide depending on the connected computer for wide screens, or set to Normal for 4:3 or 5:4 screens. Manual: You can specify the resolution. This is ideal when connected computer is fixed.
Tracking▶▶	You can adjust computer images when vertical stripes appear in the images.
Sync.▶▶	You can adjust computer images when flickering, fuzziness, or interference appear in the images.
Position	You can adjust the display Position up, down, left, and right when a part of the image is missing so that the whole image is projected.
Progressive	Off: IP conversion is carried out for each field in the screen. This is ideal for viewing images with a large amount of movement. Video: This is ideal for viewing general video images. Film/Auto: By automatically converting movie films, CG, animated images, and so on recorded in 24/30 frames to the optimum progressive signal via 2-3 pull-down, it is possible to recreate the natural feel of the original image.
Frame Interpolation*	You can play fast moving images smoothly by producing intermediate frames between the original frames.
Super-resolution	To display a crisp image, you can reduce the blurring that is created on the edge when the image data is scaled up to fit the panel resolution of the image signal.

Sub Menu	Function
Noise Reduction	Smoothes out rough images. There are two modes. Select your favorite setting. It is recommended that this is set to Off when viewing image sources in which noise is very low, such as for DVDs.
Mosquito NR	You can reduce the wavy noise that occurs in lines between areas with dramatic changes in colors.
HDMI Video Range	When the HDMI1/2 input port is connected to a DVD player, set the video level according to the video level setting of the DVD player. If Auto is selected, the video level of the input signal is identified and set automatically. If the range is set to Auto and the image shows whiteout or blackout, set the video level according to the video level setting of the DVD player. The video level of the DVD player may be set to Normal or Expanded.
SDI Video Range*	When the SDI input port is connected to a video equipment, set the video level according to the video level setting of the video equipment.
Input Signal	You can select an input signal from Computer input port or BNC input port. If Auto is set, the input signal is identified automatically according to the connected equipment. If colors do not appear correctly when this is set to Auto , select the appropriate signal according to the connected equipment.
Video Signal	You can select an input signal from Video input port or S-Video input port. If set to Auto , video signals are recognized automatically. If interference appears in the image or a problem occurs such as no image is being projected when set to Auto , select the appropriate signal according to the connected equipment.
Aspect	You can set the <u>Aspect Ratio</u>  for projected images.  p.22
Scale	When you set Edge Blending from Extended menu, you can adjust an overlapping area, scaling up each image and selecting the range to display. Full Display: You can adjust while renewing the display area aspect and position. Zoom Display: You can adjust while locking the display area aspect and position.
Overscan	You can change the Output Scaling (the range of projected image). The range of trimming screen can be set to Off , 4% , or 8% . You can select Auto only when the input source is HDMI1/2 . When Auto is selected, the range is automatically switched to Off or 8% according to the input signal.
Reset	You can reset all adjustment values on the Signal menu to their default settings, except for Input Signal . To return all menu items to their default settings, see  p.79

* EB-Z8455WU/Z8450WU only









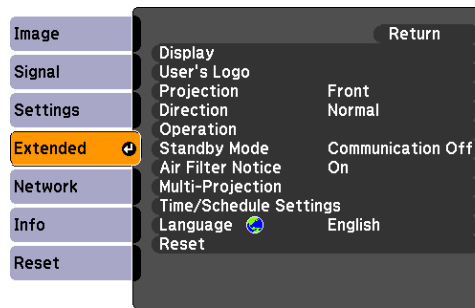

Sub Menu	Function
Geometric Correction	<p>You can correct distortion.</p> <p>H/V-Keystone: Corrects horizontal and vertical keystone distortion. Select one of V-Keystone or H-Keystone.  p.142</p> <p>Use the [∇/\blacktriangle], [$\nabla/\blacktriangledown$], [$\blacktriangleleft/\blacktriangleright$], and [$\blacktriangleright/\blacktriangleleft$] buttons on the control panel to perform similar corrections to V-Keystone and H-Keystone.</p> <p>Quick Corner: Selects and corrects the four corners of the projected image.  p.140</p> <p>Arc Correction: Fine adjustment of the curved distortion caused by slack or shrinkage of the screen.  p.143</p> <p>Point Correction: The projected image is divided by the grid, and you can correct the distortion by moving the point of intersection from side to side and up and down.  p.153</p>
Split Screen	You can split the screen into two screens.  p.29
Control Panel Lock	You can use this to restrict operation of the projector's control panel.  p.40
Lens Operation Lock	You can use this to restrict the lens operation of the remote control.  p.41
Pointer Shape	<p>You can select the shape of the pointer.  p.34</p> <p>Pointer 1:  Pointer 2:  Pointer 3: </p>
Power Consumption*	<p>You can set the lamp brightness to Normal 1, ECO, or Normal 2.</p> <p>Normal 1: Projects at normal brightness.</p> <p>You can change the lamp brightness in Multi-Projection - Brightness Level from the Extended menu.  p.57</p> <p>ECO: Select this if the images being projected are too bright such as when projecting images in a dark room or onto a small screen. When ECO is selected, the amount of electricity consumed and the fan rotation noise during projection are reduced, and the lamp's operating life is extended.</p> <p>Normal 2: Adjusts the brightness automatically according to the surrounding environment.</p>



Sub Menu	Function
Remote Receiver	<p>You can limit the reception of the operation signal from the remote control.</p> <p>When you want to prohibit operation by remote control, or if the remote receiver has a fluorescent light too close to it, you can make settings to deactivate the remote receiver you do not want to use or that is experiencing interference.</p> <p>If the [Menu] button on the remote control is pressed for 15 seconds, this parameter will return to the default setting.</p>
User Button	<p>You can select the item assigned from the configuration menu with the remote control's [User] button. By pressing the [User] button the assigned menu item selection/adjustment screen is displayed, allowing you to make one-touch settings/adjustments. You can assign one of the following items to the [User] button.</p> <p>Power Consumption*, Info, Progressive, Test Pattern, Multi-screen, Resolution, Memory</p>
Test Pattern	<p>When the projector is setup, a Test Pattern is displayed so that you can adjust the projection without connecting other equipment.</p> <p> p.137</p>
Memory	<p>Load Memory: Recalls the setting value registered in Save Memory.  p.45</p> <p>You cannot select if nothing is registered by Save Memory.</p> <p>Save Memory: Registers settings related to the image in the configuration menu as memory.  p.44</p> <p>Erase Memory: Deletes unnecessary memories.  p.45</p> <p>Rename Memory: Changes the name of the registered memory.  p.45</p>
Reset	<p>You can reset all adjustment values on the Settings menu to their default settings, except for User Button and Memory.</p> <p>To return all menu items to their default settings, see  p.79</p>

* EB-Z8455WU/Z8450WU/Z8355W/Z8350W/Z10005/Z10000 only



Sub Menu	Function
Display	You can make settings related to the projector's display. Menu Position: Select the position to display the menu on the projected screen. Messages: The following messages are not displayed on the screen when this item is set to Off . Overheating and other warnings, messages such as when there is no video input, and when Freeze is On or when changing Source, Color Mode or Aspect. Display Background*1: You can set the screen status for when there is no video input to Black , Blue , or Logo . Startup Screen*1: Set this parameter to On to display the user's logo when projection is started.
User's Logo*1	You can change the User's Logo that is displayed as a background during Display Background or Startup Screen.  p.36
Projection	Set this parameter according to the installation status of the projector.  p.130
Direction	Set this parameter according to the installation status of the projector.  p.130

Sub Menu	Function
Operation	<p>Direct Power On: You can set whether or not (On/Off) to enable Direct Power On. Be careful when this item is set to On because this unit turns on at the time of power recovery with this unit plugged-in to an outlet.</p> <p>Sleep Mode: When set to On, this automatically stops projection when no image signal is being input and no operations are carried out.</p> <p>Sleep Mode Timer: When Sleep Mode is set to On, you can set the time before the projector automatically turns off within a range of 1 to 30 minutes.</p> <p>Shutter Button: Select an operation to be done when the [Shutter] button is pressed. When Electric Shutter is selected, the electric shutter opens/closes.  p.33 When Blank is selected, this turns off the video temporarily.</p> <p>Shutter Timer: When set to On, this turns off the power automatically 30 minutes after the electric shutter is closed.</p> <p>Shutter Timer is set to On at the time of purchase. (When Shutter Timer and Sleep Mode are set to On at the same time, Sleep Mode has priority.)</p> <p>High Altitude Mode: Set to On when using the projector above an altitude of 1500 m.</p> <p>BNC Sync Termination: Set the termination for the signal from the BNC input port. This should usually be set to Off. Set to On when analog (75Ω) termination such as for switchers is necessary.</p> <p>Remote Control Type: You can select Normal or Simple depending on the type of remote control. Set this item to Normal to use the remote control provided with the projector. When Simple is selected, you can use the remote control provided with other Epson projectors to operate this projector. This is useful if you want to use a remote control that you are already familiar with to operate the projector. (When using the remote control that is supplied with an EB-G5xxx-series or EB-Z80xx-series projector, select Normal.)</p> <p>However, you cannot use the remote control provided with this projector if this is set to Simple. Make sure that the setting is correct because, if the projector is mounted on the ceiling or somewhere hard to reach, changing it back to Normal may be difficult. Additionally, you cannot use the functions that are not equipped with this projector or the remote control which you use.</p> <p>Beep: When this is set to On, the confirmation buzzer beeps to notify you that the power turns on or off, the electric shutter opens or closes, or the cooling down is finished.</p>
Standby Mode	<p>You can use the functions that monitor and control the status of the projector over the network even when the projector is in standby mode if this is set to Communication On.</p>
Air Filter Notice	<p>You can set whether or not (On/Off) to enable Air Filter Notice. When this is set to On and a clog in the air filter is detected, the message is displayed on the screen.</p>
Multi-Projection	<p>You can make settings for the useful functions to project images using multiple projectors.  p.150</p> <p>Brightness Level (EB-Z8455WU/Z8450WU/Z8355W/Z8350W/Z10005/Z10000 only): Set the lamp brightness level between 1 and 5. This item can be adjusted when Normal 1 is selected in the Power Consumption setting from the Settings menu.</p> <p>Edge Blending: Corrects a border between multiple images to create a seamless screen.  p.155</p> <p>Multi-screen: You can adjust the hue and brightness of each projected image.  p.157</p> <p>Projector ID: Set the ID within a range of 1 to 9. Off indicates that no ID is set.  p.150</p>

Sub Menu	Function
Time/Schedule Settings	Displays the screen to set the current time and schedules.  p.159
Language	You can set the Language for message displays.
Reset	You can reset Display ^{*2} , Operation ^{*3} , Air Filter Notice , and Multi-Projection ^{*4} from the Extended menu to their default settings. To return all menu items to their default settings, see  p.79

*1 When **User's Logo Protect** is set to **On** in **Password Protect**, settings relating to User's Logo cannot be changed. You can make changes after setting **User's Logo Protect** to **Off**.  [p.38](#)

*2 Except for parameters related to the user's logo

*3 Except for **High Altitude Mode** and **Remote Control Type**

*4 Except for **Multi-screen** and **Projector ID**

When **Network Protect** is set to **On** in **Password Protect**, a message is displayed and the settings cannot be changed. You can make changes after setting **Network Protect** to **Off**.  [p.38](#)

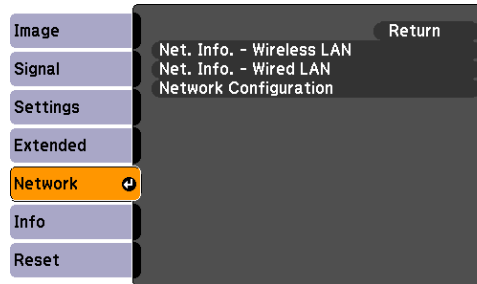

Sub Menu	Function
Net. Info. - Wireless LAN Net. Info. - Wired LAN	Displays the network settings.
Network Configuration	Displays the screen to set the network.  p.61



By using the Web browser of a computer connected to the projector on a network, you can set the projector's functions and control the projector. This function is called "Web Control". You can easily enter text using a keyboard to make settings for "Web Control" such as security settings.  [p.109](#)

Notes on Operating the Network Menu

Selecting from the top menu and sub menus, and changing of selected items are the same as operations in the configuration menu.

When done, make sure you go to the **Setup complete**, and select one of **Yes**, **No**, or **Cancel**. When you select **Yes** or **No**, you return to the configuration menu.



- Yes:** Saves the settings and exits the **Network** menu.
- No:** Exits to the **Network** menu without saving the settings.
- Cancel:** Continues displaying the **Network** menu.



If the settings contain an invalid value, the settings may not take effect, even after you select **Yes**.

Soft Keyboard Operations

The **Network** menu contains items that require input of alphanumerics during setup. In this case, the following software keyboard is displayed. Use the [⊙] button on the remote control or [↖/▲], [↘/▼], [↙/◀], and [↗/▶] on the projector to move the cursor to the desired key, and then press the [Enter] button to enter the alphanumeric. Enter figures by holding

down the [Num] button on the remote control, and pressing the numeric buttons. After inputting, press [Finish] on the keyboard to confirm your input. Press [Cancel] on the keyboard to cancel your input.



- Each time the [CAPS] key is selected and the [Enter] button is pressed, it switches between uppercase and lowercase letters.
- Each time the [SYM1/2] key is selected and the [Enter] button is pressed, it switches the symbol keys in the section enclosed in the box.

Basic Menu







Sub Menu	Function
Projector Name	Displays the projector name used to identify the projector when connected to a network. When editing, you can enter up to 16 single-byte alphanumeric characters.
Web Remote Password	Set a password to use Web Remote. You can enter up to 8 single-byte alphanumeric characters. Web Remote is a computer function that allows you to operate the projector by using the Web browser on a computer connected on a network.  p.109
Projector Keyword	When set to On , you have to enter the keyword when you try to connect the projector to a computer using EasyMP Multi PC Projection and EasyMP Network Projection. As a result, you can prevent presentations from being interrupted by unscheduled connections from the computer. Normally this should be set to On .

Wireless LAN Menu

To connect the projector to a computer using a wireless LAN, install the Wireless LAN unit (ELPAP07).  [p.165](#)



Sub Menu	Function
Wireless LAN Power	Set this parameter to On when connecting the projector and a computer via a wireless LAN. If you do not want to connect via a wireless LAN, set this parameter to Off to prevent unauthorized access by others.
Wi-Fi Protected Setup	When using a <u>WPS (Wi-Fi Protected Setup)</u>  compatible access point via a wireless LAN, you can easily connect the projector to the access point and make security settings.  p.125
Wireless LAN system	Sets the wireless LAN system. Normally this should be set to 802.11b/g/n . The connection method is selected automatically according to the access point settings. In an area that does not support 802.11n, only 802.11b/g is displayed.
Connection Mode	Set the connection mode to use when connecting the projector and a computer via a wireless LAN. If you select Quick , a small network is created automatically by the projector and computer. It is used with EasyMP Network Projection. If SSID Auto Setting is On , the projector becomes an easy access point; if it is set to Off , the network is created in <u>Ad hoc mode</u>  . If you select Advanced , the connection is established by the installed access point and <u>Infrastructure mode</u>  .
SSID Auto Setting	If Connection Mode is set to Quick , when you set this to On , you can search for the projector more quickly from among multiple projectors. SSID is set automatically. When connecting to multiple projectors from 1 computer in Quick mode, set this to Off , and set the same SSID in all the projectors that will connect.
SSID	Enter an SSID. When an SSID is provided for the wireless LAN system in which the projector participates, enter the SSID. You can enter up to 32 single-byte alphanumeric characters. Set SSID to blank or ANY to establish an ANY connection.
Search Access Point	When Connection Mode is set to Advanced , you can search for surrounding access points, and set the SSID to be connected from those access points. Depending on the access point settings, they may not be displayed in the list. You must set security separately.  p.65



Sub Menu	Function
Channel	You can select the channels used to connect in Quick mode. If interference from other signals occurs, use a different channel.
SSID Display	To prevent the SSID from being displayed on the LAN Standby screen, set this to Off .
DHCP	You can set whether or not (On/Off) to use <u>DHCP</u> ▶▶. If this is set to On you cannot set any more addresses.
IP Address	You can input the <u>IP address</u> ▶▶ assigned to the projector. You can input a number from 0 to 255 in each field of the address. However, the following IP addresses cannot be used. 0.0.0.0, 127.x.x.x, 224.0.0.0 to 255.255.255.255 (where x is a number from 0 to 255)
Subnet Mask	You can input the <u>Subnet Mask</u> ▶▶ for the projector. You can input a number from 0 to 255 in each field of the address. However, the following subnet masks cannot be used. 0.0.0.0, 255.255.255.255
Gateway Address	You can input the IP address for the gateway for the projector. You can input a number from 0 to 255 in each field of the address. However, the following <u>Gateway addresses</u> ▶▶ cannot be used. 0.0.0.0, 127.x.x.x, 224.0.0.0 to 255.255.255.255 (where x is a number from 0 to 255)
IP Address Display	To prevent the IP address from being displayed on the LAN Standby screen, set this to Off .
Region Code	This is a specific string of the wireless LAN module.

Search Access Point screen

Detected access points are displayed in a list.

Access points set by WEP are also detected, but connection is not possible because this projector does not support the WEP encryption method.



Sub Menu/Icon	Function
Refresh	Starts detecting access points again.
	Indicates an already set access point.
	Indicates the access points where security is set. If you select an access point not set to security, Wireless LAN menu appears. If you select an access point which has security, Security menu appears. Set security according to the access point settings.

Security Menu (Only Available when the Optional Wireless LAN Unit Is Installed)

When the Wireless LAN unit is installed, it is strongly recommended that you set security.



Sub Menu	Function
Security	<p>You can select a type of security.</p> <p>When Quick is selected Open: Security is not set. WPA/WPA2-PSK (only when SSID Auto Setting is On): Communication takes place using security by WPA2. Uses AES method for encryption. When establishing connection from computer to projector, enter the value set in the passphrase.</p> <p>When Advanced is selected Open: Connects to access points not set to security. WPA/WPA2-PSK: Connects in WPA personal mode. Encryption method is selected automatically according to the access point settings. Set a passphrase which is the same for the access point. WPA/WPA2-EAP: Connects in WPA enterprise mode. Encryption method is selected automatically according to the access point settings. Also select this item when using LEAP.</p>



You cannot set WEP as an encryption method for this projector.

When WPA/WPA2-PSK is selected



Sub Menu	Function
<p>Passphrase</p>	<p>You can enter at least 8 and up to 63 single-byte alphanumeric characters for the passphrase. When the passphrase is entered and the [Enter] button is pressed, the value is set and displayed as an asterisk (*).</p> <p>When using it with EasyMP Network Projection, you do not need to input the passphrase in the computer if it is the initial (default) passphrase. It is recommended to change the passphrase periodically for the purpose of security. If the network settings are initialized, it returns to the initial passphrase. p.76</p> <p>You cannot enter more than 32 characters on the configuration menu. When setting from Web Control, you can enter more than 32 characters. p.109</p> <p>In Quick mode, the initial passphrase is set.</p>

When WPA/WPA2-EAP is selected

PEAP/EAP-Fast



PEAP-TLS/EAP-TLS



LEAP



Sub Menu	Function
<p>EAP Method</p>	<p>Set the protocol for authentication. PEAP: Authentication protocol widely used in Windows Server. PEAP-TLS: Authentication protocol used in Windows Server. Set when using client certificate. EAP-TLS: Authentication protocol widely used to use a client certificate. EAP-Fast, LEAP: Select this when these authentication protocols are used.</p>
<p>User name</p>	<p>You can enter a user name to be used for authentication in single-byte alphanumeric characters (no spaces). You can enter up to 64 characters. If you select PEAP-TLS or EAP-TLS, the user name obtained automatically from the client certificate is displayed. You can change the user name, if the authentication server requires another user name. You cannot enter more than 32 characters on the configuration menu. When setting from Web Control, you can enter more than 32 characters. 🖱️ p.109 If you must also enter the domain name, add the domain name before user name separated by a backslash.</p>
<p>Password</p>	<p>You can enter an authentication password in single-byte alphanumeric characters. You can enter up to 64 characters. When the password is entered and the [Enter] button is pressed, the value is set and displayed as an asterisk (*). You cannot enter more than 32 characters on the configuration menu. When setting from Web Control, you can enter more than 32 characters. 🖱️ p.109</p>
<p>Client Certificate</p>	<p>Issued to/Issued by/Validity period Displays the information set in the stored client certificate. It is blank if the certificate is not set.</p>

Sub Menu	Function
Verify Server Certificate	Set whether or not to do verify with the authentication server certificate to prevent illegal authentication. To select On , you must set a CA certificate that can verify the authentication server certificate.  p.111
CA certificate	Issued to/Issued by/Validity period Displays the information set in the stored CA certificate. It is blank if the certificate is not set.
Setting RADIUS Server Name	Set whether or not to do verify the authentication server name during the server certificate verification. If you set this to On and specify the server name, you reduce the risk of connecting to an invalid authentication server.
RADIUS Server Name	Specify the authentication server name. You can enter up to 32 single-byte alphanumeric characters.
Verify Exp. date of Server Cert.	Set whether or not to verify the expiration date of the certificate during the server certificate verification. If On is selected, the validity of the authentication server certificate is verified from the internal time of the projector.







Wired LAN Menu



Sub Menu	Function
DHCP	You can set whether or not (On/Off) to use <u>DHCP</u> . If this is set to On you cannot set any more addresses.
IP Address	You can input the <u>IP address</u> assigned to the projector. You can input a number from 0 to 255 in each field of the address. However, the following IP addresses cannot be used. 0.0.0.0, 127.x.x.x, 224.0.0.0 to 255.255.255.255 (where x is a number from 0 to 255)
Subnet Mask	You can input the <u>Subnet Mask</u> for the projector. You can input a number from 0 to 255 in each field of the address. However, the following subnet masks cannot be used. 0.0.0.0, 255.255.255.255
Gateway Address	You can input the IP address for the gateway for the projector. You can input a number from 0 to 255 in each field of the address. However, the following <u>Gateway addresses</u> cannot be used. 0.0.0.0, 127.x.x.x, 224.0.0.0 to 255.255.255.255 (where x is a number from 0 to 255)
IP Address Display	To prevent the IP address from being displayed on the LAN Standby screen, set this to Off .

Administrator Settings Menu



Sub Menu	Function
Administrator Password	This is the password for the Administrator settings menu of network settings. You can enter up to 16 single-byte alphanumeric characters. If the administrator password is not set, click OK with an empty password box.
Network Host Name	You can enter up to 15 single-byte alphanumeric characters.
PJLink Password	Set a password to use when you access the projector using compatible PJLink software.  p.117 You can enter up to 32 single-byte alphanumeric characters.
Web Control Password	Set a password to use when making settings and controlling the projector using Web Control. You can enter up to 8 single-byte alphanumeric characters. Web Control is a computer function that allows you to set up and control the projector by using the Web browser on a computer connected on a network.  p.109
Monitor Password	You can enter up to 16 single-byte alphanumeric characters.
Secure HTTP	Apply security (HTTPS) to Web Control. To set security by Web control, it is recommended to set it On .
Mail Notification	Goes to the Mail Notification setting menu.  p.73
Manage Certificates	Goes to the Manage Certificates settings menu.  p.74
SNMP	Goes to the SNMP settings menu.  p.75
Priority Gateway	For the priority gateway, select either Wired or Wireless .
AMX Device Discovery	When the projector is connected to a network, set this to On to allow the projector to be detected by AMX Device Discovery  . Set this to Off if you are not connected to an environment controlled with a controller from AMX or AMX Device Discovery.

Sub Menu	Function
Crestron RoomView	Set this parameter to On only when using Crestron RoomView® to monitor and control the projector over a network. Normally, leave this parameter set to Off .  "About Crestron RoomView™" p.118 Changes in projector settings take effect upon restarting. The following functions cannot be used when it is set to On . <ul style="list-style-type: none">• Web Control• Message Broadcasting (EasyMP Monitor plugin)
Bonjour	To connect to the network by Bonjour, set it to On . For an explanation of the Bonjour service, see the Apple Web site. http://www.apple.com/
EPSON Message Broadcasting	You can switch the EPSON Message Broadcasting function to enable or disable. You can download Mssege Broadcasting and its Operation Guide from the following Web site. http://www.epson.com

Mail Notification menu

When this is set, you receive an e-mail notification if a problem or warning occurs in the projector. 🖱️ "Reading Problem Mail Notification Function" p.113

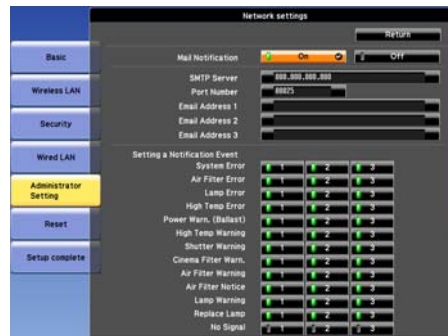

Sub Menu	Function
Mail Notification	You can set whether or not (On/Off) to be notified by e-mail.
SMTP Server	You can input the <u>IP address</u> 🖱️ for the SMTP server for the projector. You can input a number from 0 to 255 in each field of the address. However, the following IP addresses cannot be used. 127.x.x.x, 224.0.0.0 to 255.255.255.255 (where x is a number from 0 to 255)
Port Number	You can input the port number for the SMTP server. The default value is 25. You can input numbers between 1 to 65535.
Email Address 1/Email Address 2/Email Address 3	You can input the e-mail address of the destination to send the notification e-mail to. You can register up to three destinations. You can enter up to 64 single-byte alphanumeric characters for the e-mail addresses. You cannot enter more than 32 characters on the configuration menu. When setting from Web Control, you can enter more than 32 characters. 🖱️ p.109
Setting a Notification Event	You can select the problems or warnings to be notified about by e-mail. When the selected problem or warning occurs in the projector, an e-mail is sent to the specified Email Address notifying that a problem or warning has occurred. You can select multiple items from the displayed items. Sender is Email Address 1.

Manage Certificates menu



Sub Menu	Function
<p>Client Certificate</p>	<p>Issued to/Issued by/Validity period Displays the information set in the stored client certificate. It is blank if the certificate is not set. You must set the certificate if you use PEAP-TLS and EAP-TLS. Select Clear to delete the stored certificate.</p>
<p>CA certificate</p>	<p>Issued to/Issued by/Validity period Displays the information set in the stored CA certificate. It is blank if the certificate is not set. You must set the certificate if you use EAP to authenticate the authentication server certificate. Select Clear to delete the stored certificate.</p>
<p>Self-signed Certificate</p>	<p>Issued to/Issued by/Validity period When Secure HTTP is set to On, information on the certificate maintained by the server function in the projector is displayed. It is not displayed if Web Server Certificate is set. Select Refresh to update the self-signed certificate.</p>
<p>Web Server Certificate</p>	<p>Issued to/Issued by/Validity period Displays information on the certificates set in the projector, which are needed when Secure HTTP is set to On. It is not displayed if Self-signed Certificate is set. Select Clear to delete the stored certificate.</p>



Web Control is used to set certificates. 🖱️ "Setting Certificates" p.111

SNMP menu

To use SNMP to monitor the projector, you need to install the SNMP manager program on your computer. SNMP should be managed by a network administrator.



Sub Menu	Function
SNMP	Set this parameter to On when using SNMP to monitor the projector.
Trap IP Address 1/Trap IP Address 2	When SNMP is set to On , you can set up to two IP addresses as SNMP trap notification destinations. You can input a number from 0 to 255 in each field of the address. However, the following IP addresses cannot be used. 127.x.x.x, 224.0.0.0 to 255.255.255.255 (where x is a number from 0 to 255)
Community Name	Set the community name of SNMP. You can enter up to 32 single-byte alphanumeric characters.

Reset Menu

Resets all of the network settings.



Sub Menu	Function
<p>Reset network settings.</p>	<p>To reset all of the network settings, select Yes. When you reset the network settings , the Passphrase, Administrator Password and Manage Certificates menu settings change back to their default values, and the certificates are deleted. After you reset all the settings, the Basic menu appears.</p>

Lets you check the status of the image signals being projected and the status of the projector. Items that can be displayed vary depending on the image signal or input source being projected as shown in the following screen shots.

RGB Signal/Component Video▶▶ Signal

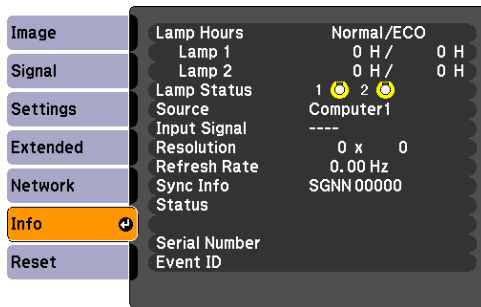

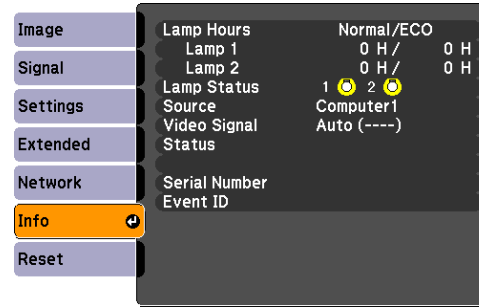

Composite video▶▶ Signal/S-Video▶▶ Signal

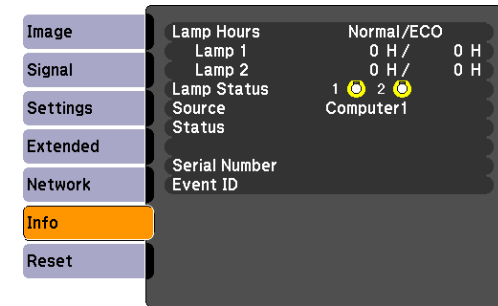

LAN



Sub Menu	Function
Lamp Hours	You can display the cumulative lamp operating time*1*2. When it reaches the lamp warning time, the characters are displayed in yellow.
Lamp Status	The following icons show the status of the lamps.  : Lighted  : Disable When  is displayed, the lamp is not operating normally. See "Reading the Indicators". p.83
Source	You can display the Source name for the connected equipment currently being projected.
Input Signal	You can display the content of Input Signal set in the Signal menu according to the Source.
Resolution	You can display the Resolution.
Video Signal	You can display the content of Video Signal set in the Signal menu.
Refresh Rate	You can display the <u>Refresh Rate</u> ▶▶.
Sync Info	You can display the image signal information. This information may be needed if service is required.
Status	This is information about errors that have occurred on the projector. This information may be needed if service is required.
Serial Number	Displays the projector's serial number.



Sub Menu	Function
Event ID	When problems occur when the projector and computer are connected through the network, information on the problem is displayed using an Event ID. Refer to the following page for information on interpreting the Event ID.  p.96

*1 The cumulative use time is displayed as "0H" for the first 10 hours. 10 hours and above is displayed as "10H", "11H", and so on.

*2 If you are using EB-Z8455WU/Z8450WU/Z8355W/Z8350W/Z10005/Z10000, it displays the lamp operating times of both power consumption mode and normal mode.

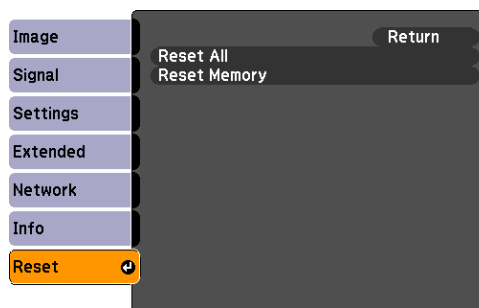

Sub Menu	Function
Reset All	You can reset all items in the configuration menu to their default settings. The following items are not reset to their defaults: Items for Password, Input Signal , Memory , User's Logo , Multi-screen , all items for Network menus, Lamp Hours , and Language .
Reset Memory	Resets items for Memory in the Settings menu.



Troubleshooting

This chapter explains how to identify problems and what to do if a problem is found.

If a problem occurs with the projector, the Help screen is displayed to assist you by pressing the [Help] button. You can solve problems by answering the questions.

Procedure

- 1 Press the [Help] button.

The Help screen is displayed.

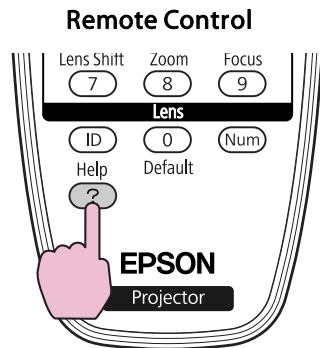

- 2 Select a menu item.

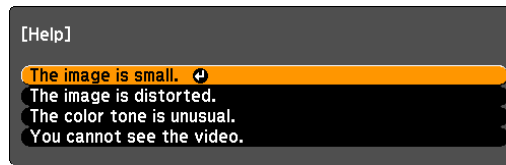

Remote Control

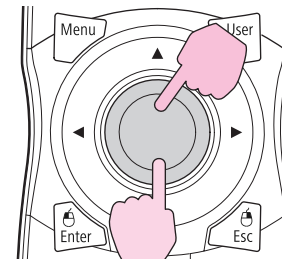

- 3 Confirm the selection.

Remote Control

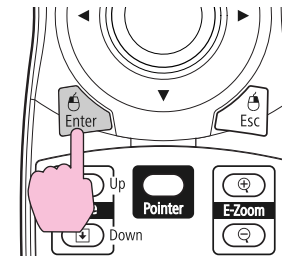

Questions and solutions are displayed as shown on the screen below. Press the [Help] button to exit Help.

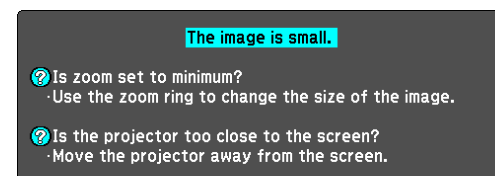



If the Help screen does not provide a solution to the problem, refer to "Problem Solving" [p.83](#).

If you are having a problem with the projector, first check the projector's indicators and refer to "Reading the Indicators" below.



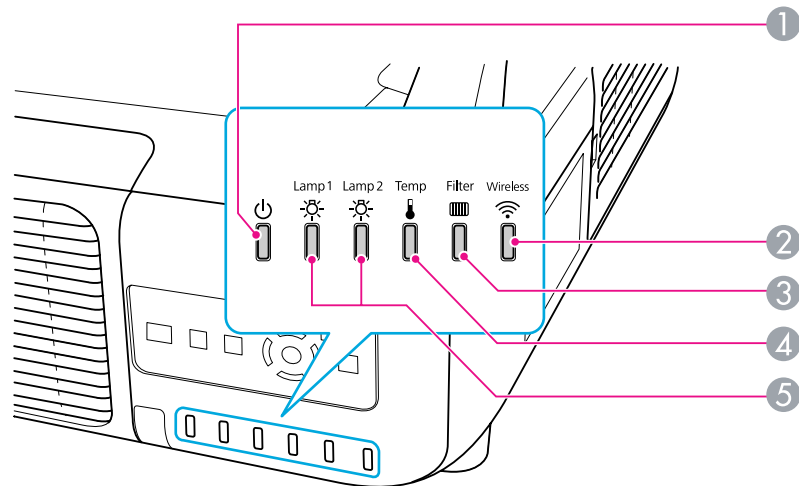

If the indicators do not show clearly what the problem might be, refer to "When the Indicators Provide No Help". [p.88](#)

Reading the Indicators

These indicators indicate the operating status of the projector.



① Indicates the operating status.

-  Standby condition
 When the [⏻] button is pressed in this condition, projection starts.
-  Preparing network monitoring (maximum approx. 20 seconds) or cool down in progress
 Buttons are disabled while the indicator is flashing.
-  Warming up
 Warm-up time is about 30 seconds. After warm-up is complete, the indicator stops flashing. [⏻] button does not function during warm-up.
-  Projecting

② Indicates the operating status of wireless LAN when the optional wireless LAN unit is connected.

③ Indicates the air filter status.

















































④ Indicates the internal temperature status.



























- 5 Indicates the projection lamps status.
Flashes green while Shutter or Blank is activated.

Refer to the following table to see what the indicators mean and how to remedy problems that they indicate.
If all indicators are off, check that the power cable is connected correctly and that the power is being supplied normally.
Sometimes, when the power cable is unplugged, the ⏻ indicator remains lit for a short period, but this is not a fault.

⏻ Indicator is lit or flashing red











: Lit : Flashing : Off













































Status	Cause	Remedy or Status
         	Internal Error	Stop using the projector, disconnect the power cable from the electrical outlet, and contact your local dealer or the nearest address provided in the Support and Service Guide.  Epson Projector Contact List
         	Fan Error Sensor Error Cool System Error	Stop using the projector, disconnect the power cable from the electrical outlet, and contact your local dealer or the nearest address provided in the Support and Service Guide.  Epson Projector Contact List
         	High Temp Error (overheating)	The lamps turn off automatically and projection stops. Wait for about five minutes. After about five minutes the projector switches to standby mode, so check the following two points. <ul style="list-style-type: none"> • Check that the air filter and air exhaust vent are clear, and that the projector is not positioned against a wall. • If the air filter is clogged, clean or replace it.  p.98, p.104 If the error continues after checking the points above, stop using the projector, disconnect the power cable from the electrical outlet, and contact your local dealer or the nearest address provided in the Support and Service Guide.  Epson Projector Contact List
		When using at an altitude of 1500 m or more, set High Altitude Mode to On .  p.57
		Set Direction to Pointing Down, Pointing Up, Angled Up, or Angled Down when the projector is installed in a direction which is not horizontal.  p.57
         	Lamp Error Lamp Failure	Check the following two points. <ul style="list-style-type: none"> • Take out the both lamps and check if they are cracked.  p.101 • Clean the air filter.  p.98











Status	Cause	Remedy or Status
		<p>If it is not cracked: Re-fit the lamp and turn on the power.</p> <p>If the error continues: Replace the lamp with a new lamp and turn on the power.</p> <p>If the error continues: Stop using the projector, disconnect the power cable from the electrical outlet, and contact your local dealer or the nearest address provided in the Support and Service Guide.  Epson Projector Contact List</p> <p>If it is cracked: Replace it with a new lamp, or contact your local dealer for further advice. If replacing the lamp yourself, be careful to avoid pieces of broken glass (you cannot continue projecting until the lamp is replaced).  Epson Projector Contact List</p> <p>When using at an altitude of 1500 m or more, set High Altitude Mode to On.  p.57</p> <p>Set Direction to Pointing Down, Pointing Up, Angled Up, or Angled Down when the projector is installed in a direction which is not horizontal.  p.57</p>
         	Filter Airflow Error	<p>Check the following two points.</p> <ul style="list-style-type: none"> • Check that the air filter and air exhaust vent are clear, and that the projector is not positioned against a wall. • If the air filter is clogged, clean or replace it.  p.98, p.104 <p>If the error continues after checking the points above, stop using the projector, disconnect the power cable from the electrical outlet, and contact your local dealer or the nearest address provided in the Support and Service Guide.  Epson Projector Contact List</p>
         	Auto Iris Error Cinema filter error Shutter Error Power Err. (Ballast)	<p>Stop using the projector, disconnect the power cable from the electrical outlet, and contact your local dealer or the nearest address provided in the Support and Service Guide.  Epson Projector Contact List</p>

   **Indicator is flashing or lit**

 : Lit
  : Flashing
  : Off
  : Varies according to the projector status

Status	Cause	Remedy or Status
         	High Temp Warning	<p>(This is not an abnormality. However, if the temperature rises too high again, projection stops automatically.)</p> <ul style="list-style-type: none"> • Check that the air filter and air exhaust vent are clear, and that the projector is not positioned against a wall. • If the air filter is clogged, clean or replace it.  p.98, p.104

Status	Cause	Remedy or Status
         	Replace Lamp	The lamp indicated by flashing indicator, lamp 1 or 2, is due for replacement. Replace it with a new lamp.  p.101 If you continue to use the lamp after the replacement period has passed, the possibility that the lamp may explode increases. Replace it with a new lamp as soon as possible. We recommend replacing both lamps together to maintain consistent hue and brightness of projected images.
         	Lamp Warning Supply System Warning (Ballast)	Check the following two points. <ul style="list-style-type: none"> • Remove the lamp indicated by the flashing indicator, lamp 1 or 2, and check if it is cracked.  p.101 • Clean the air filter.  p.98 <p>If it is not cracked: Re-fit the lamp and turn on the power.</p> <p>If the error continues: Replace the lamp with a new lamp and turn on the power.</p> <p>If the error continues: Stop using the projector, disconnect the power cable from the electrical outlet, and contact your local dealer or the nearest address provided in the Support and Service Guide.  Epson Projector Contact List</p> <p>If it is cracked: Replace it with a new lamp, or contact your local dealer for further advice. (Only one lamp is working. Replace the burned-out lamp as soon as possible.).  Epson Projector Contact List</p> <p>If replacing the lamp yourself, be careful to avoid pieces of broken glass.</p> <p>When using at an altitude of 1500 m or more, set High Altitude Mode to On.  p.57</p> <p>Set Direction to Pointing Down, Pointing Up, Angled Up, or Angled Down when the projector is installed in a direction which is not horizontal.  p.57</p>
         	No Air Filter Air Flow Sensor Err.	Check that the air filter is securely installed.  p.104 The projector automatically turns off about one minute after it detects that there is no air filter. If the error continues even though an air filter is installed, the air filter sensor may be defective. Stop using the projector, disconnect the power cable from the electrical outlet, and contact your local dealer or the nearest address provided in the Support and Service Guide.  Epson Projector Contact List
         	Low Air Flow	(This is not an abnormality. However, projection stops automatically if the airflow falls any further.) The message "The air filter is clogged. Clean or replace the air filter." is displayed. Check the following two points. <ul style="list-style-type: none"> • Check that the air filter and air exhaust vent are clear, and that the projector is not positioned against a wall. • If the air filter is clogged, clean or replace it.  p.98, p.104 <p>If the Low Air Flow status continues after cleaning the air filter, replace the air filter with a new one.  p.104</p> <p>If the error continues after checking the points above, stop using the projector, disconnect the power cable from the electrical outlet, and contact your local dealer or the nearest address provided in the Support and Service Guide.  Epson Projector Contact List</p>

Status	Cause	Remedy or Status
         	<p>Air Filter Notice</p>	<p>"Time to clean the air filter. Clean or replace the air filter." is displayed. Clean the air filter. p.98</p> <p>If the air filter is stained yellow with tobacco smoke and cannot be cleaned, replace it with a new one.</p> <p>The indicators or messages regarding "Air Filter Notice" are displayed only when Air Filter Notice is set to On, on the configuration menu's Extended menu. p.57</p>













- If the projector is not operating properly, even though the indicators are all showing normal, refer to “When the Indicators Provide No Help”. [p.88](#)
- If the error is not indicated in this table, stop using the projector, disconnect the power cable from the electrical outlet, and contact your local dealer or the nearest address provided in the Support and Service Guide. [Epson Projector Contact List](#)

When the Indicators Provide No Help

If any of the following problems occur and the indicators do not offer a solution, refer to the pages given for each problem.





Problems relating to images

- "No images appear"  p.89
Projection does not start, the projection area is completely black, the projection area is completely blue, and so on.
- "Moving images are not displayed (only the moving image portion turns black)."  p.89
Moving images being projected from a computer appear black and nothing is projected.
- "Projection stops automatically"  p.89
- "The message "Not supported" is displayed."  p.90
- ""No Signal" is displayed."  p.90
- "Images are fuzzy or out of focus"  p.90
- "Interference or distortion appears in images"  p.91
- "The image is truncated (large) or small, or the aspect is not suitable"  p.91
Only part of the image is displayed, or the height and width ratios of the image are not correct, and so on.
- "Image colors are not right"  p.92
The whole image appears purplish or greenish, images are black & white, colors appear dull, and so on... (Computer monitors and LCD screens have different color reproduction performance, so that the colors projected by the projector and the colors appearing on the monitor may not necessarily match, but this is not a sign of a problem.)
- "Images appear dark"  p.92

Problems when projection starts

- "No power supplied"  p.93

Other problems

- "The Remote Control does not work"  p.94
- "Nothing appears on the external monitor"  p.94
- "I want to change the language for messages and menus"  p.95
- "Mail is not received even if a problem occurs in the projector"  p.95
- ""The battery that saves your clock settings is running low." is displayed."  p.95

Interpreting Event IDs

-  p.96

Problems relating to images

No images appear

Check	Remedy
Did you press the [⏻] button?	Press the [⏻] button to turn the power on.
Are the indicators switched off?	The power cable is not connected correctly or power is not being supplied normally. Connect the projector's power cable correctly. 🖱 Quick Start Guide Check that your electrical outlet or power source is functioning correctly.
Is Shutter active?	Press the [Shutter] button on the Remote Control to cancel Shutter. 🖱 p.33
Are the configuration menu settings correct?	Reset All of the settings. 🖱 Reset Menu - Reset All p.79
Is the projected image completely black? Only when projecting computer images	Some input images, such as screen savers, may be completely black.
Is the image signal format setting correct? Only when projecting images from a video source	Change the setting according to the signal for the connected equipment. 🖱 Signal Menu - Video Signal p.53

Moving images are not displayed (only the moving image portion turns black).

Check	Remedy
Is the computer's image signal being output to the LCD and the monitor? Only when projecting images from a laptop computer or a computer with a built-in LCD screen	Change the image signal to external output only. 🖱 Check your computer's documentation.

Projection stops automatically

Check	Remedy
Is Sleep Mode set to On ?	Press the [⏻] button to turn the power on. If you do not want to use Sleep Mode, change the setting to Off . 🖱 Extended Menu - Operation - Sleep Mode p.57
Is the air filter installed?	Check that the air filter is securely installed. 🖱 p.104 The projector automatically turns off about one minute after it detects that there is no air filter.

The message "Not supported" is displayed.

Check	Remedy
Is the image signal format setting correct? Only when projecting images from a video source	Change the setting according to the signal for the connected equipment. 🖱️ Signal Menu - Video Signal p.53
Do the image signal Resolution and the Refresh Rate correspond to the mode? Only when projecting computer images	Refer to the computer's documentation for how to change the image signal Resolution and the Refresh Rate output from the computer. 🖱️ "Supported Monitor Displays" p.175

"No Signal" is displayed.







Check	Remedy
Are the cables connected correctly?	Check that all the cables required for projection are securely connected. 🖱️ p.132, p.134
Is the correct input port selected?	Change the image by pressing the [Source Search] button on the Remote Control or the Control panel. 🖱️ p.20
Is the power for the computer or video source turned on?	Turn the power on for the equipment.
Are the image signals being output to the projector? Only when projecting images from a laptop computer or a computer with a built-in LCD screen	If the image signals are only being output to the computer's LCD monitor or to the accessory monitor, you need to change the output to an external destination as well as the computer's own monitor. For some computer models, when the image signals are output externally, they no longer appear on the LCD monitor or accessory monitor. 🖱️ p.133 If the connection is made while the power of the projector or computer is already turned on, the function [Fn] key that changes the computer's image signal to external output may not work. Turn the power for the computer and the projector off and then back on again.

Images are fuzzy or out of focus





Check	Remedy
Is the focus adjusted correctly?	Make sure that at least 30 minutes has passed after the projection starts, and press the [Focus] button on the remote control to adjust the focus. 🖱️ Quick Start Guide , p.15
Is the projector at the correct distance?	Is it projecting outside of the recommended projection distance range? Setup within the recommended range. 🖱️ p.171
Is the Keystone adjustment value too large?	Lower the projection angle to reduce the amount of keystone correction. 🖱️ p.142

Check	Remedy
Has condensation formed on the lens?	If the projector is suddenly taken from a cold environment to a warm environment, or if sudden ambient temperature changes occur, condensation may form on the surface of the lens, and this may cause the images to appear fuzzy. Set the projector up in the room about one hour before it is used. If condensation forms on the lens, turn the projector off and wait for the condensation to disappear.

Interference or distortion appears in images

Check	Remedy
Is the image signal format setting correct? Only when projecting images from a video source	Change the setting according to the signal for the connected equipment.  Signal Menu - Video Signal p.53
Are the cables connected correctly?	Check that all the cables required for projection are securely connected.  p.132, p.134
Is an extension cable being used?	If an extension cable is used, electrical interference may affect the signals. Use the cables supplied with the projector to check if the cables you are using may be causing the problem.
Is the correct resolution selected? Only when projecting computer images	Set the computer so that the signals being output are compatible with the projector.  "Supported Monitor Displays" p.175  Computer documentation
Are the "Sync.▶▶" and "Tracking▶▶" settings adjusted correctly? Only when projecting computer analog RGB signals	Press the [Auto] button on the Remote Control or the [Enter] button on the Control panel to perform automatic adjustment. If the images are not adjusted correctly after using automatic adjustment, you can make the adjustments using Sync. and Tracking from the configuration menu.  Signal Menu - Tracking, Sync. p.53
Is the Resolution set to Manual ? Only when projecting on a split screen	The image may be collapsed if the Resolution on the configuration menu and the resolution of the projected image are not the same. If the image is collapsed, set the Resolution to Auto .  Signal Menu - Resolution p.53

The image is truncated (large) or small, or the aspect is not suitable

Check	Remedy
Is the aspect adjusted correctly?	Press the [Aspect] button on the remote control to select an aspect suitable for the input source.  p.22
Is a wide panel computer image being projected? Only when projecting computer images	Change the setting according to the signal for the connected equipment.  Signal Menu - Resolution p.53
Is the image still being enlarged by E-Zoom?	Press the [Esc] button on the remote control to cancel E-Zoom.  p.34
Is Scale set to On ?	Set Scale to Off on the configuration menu.  Signal Menu - Scale p.53

















Check	Remedy
Is Position adjusted correctly?	Press the [Auto] button on the remote control or the [Enter] button on the control panel to perform automatic adjustment when projecting the computer analog RGB signals. If the images are not adjusted correctly after using automatic adjustment, you can make the adjustments using Position from the configuration menu. Apart from computer analog RGB signals, you can adjust other signals while projecting by adjusting Position from the configuration menu.  Signal Menu - Position p.53
Is the computer set for dual display? Only when projecting computer images	If dual display is activated in the "Display Properties" of the computer's Control panel, only about half of the image on the computer screen is projected. To display the entire image on the computer screen, turn off the dual display setting.  Computer video driver documentation
Is the correct resolution selected? Only when projecting computer images	Set the computer so that the signals being output are compatible with the projector.  "Supported Monitor Displays" p.175  Computer documentation

Image colors are not right

Check	Remedy
Do the input signal settings match the signals from the connected device?	Change the setting according to the signal for the connected equipment.  Signal Menu - Input Signal, Video Signal p.53
Is the image Brightness set correctly?	Adjust the Brightness setting from the configuration menu.  Image Menu - Brightness p.51
Are the cables connected correctly?	Check that all the cables required for projection are securely connected.  p.132, p.134
Is Contrast  adjusted correctly?	Adjust the Contrast setting from the configuration menu.  Image Menu - Contrast p.51
Is the Color Adjustment correctly?	Adjust the Advanced setting from the configuration menu.  Image Menu - Advanced p.51
Are the Color Saturation and Tint adjusted correctly? Only when projecting images from a video source	Adjust the Color Saturation and Tint settings from the configuration menu.  Image Menu - Color Saturation, Tint p.51







Images appear dark

Check	Remedy
Is the image Brightness set correctly?	Adjust the Brightness and Power Consumption settings from the configuration menu.  Image Menu - Brightness p.51  Settings Menu - Power Consumption p.55
Is Contrast  adjusted correctly?	Adjust the Contrast setting from the configuration menu.  Image Menu - Contrast p.51

Check	Remedy
Is the lamp due for replacement?	When the lamp is nearly ready for replacement, the images become darker and the color quality becomes poorer. When this happens, replace the lamp with a new lamp.  p.101
Is Multi-Projection set to On ?	Brightness Level or Brightness Correct. on Multi-Projection could be set. If not projecting from multiple projectors, set Multi-Projection to Off .  Extended Menu - Multi-Projection p.57









Problems when projection starts

No power supplied

Check	Remedy
Did you press the [⏻] button?	Press the [⏻] button to turn the power on.
Are the indicators switched off?	The power cable is not connected correctly or power is not being supplied normally. Disconnect and then reconnect the power cable.  Quick Start Guide Check that your electrical outlet or power source is functioning correctly.
Do the indicators turn on and off when the power cable is touched?	There is probably a poor contact in the power cable, or the power cable may be defective. Reinsert the power cable. If this does not solve the problem, stop using the projector, disconnect the power cable from the electrical outlet, and contact your local dealer or the nearest address provided in the Support and Service Guide.  Epson Projector Contact List
Is Control Panel Lock set to Full Lock ?	Press the [⏻] button on the Remote Control. If you do not want to use Control Panel Lock, change the setting to Off .  Settings Menu - Control Panel Lock p.55
Is the correct setting for the remote receiver selected?	Check the Remote Receiver from the configuration menu.  Settings Menu - Remote Receiver p.55
Was the power cable plugged back in or was the breaker turned on immediately after Direct Power Off?	When the operation to the left is performed when Direct Power On is set to On , the power may not turn back on. Press the [⏻] button to turn the power back on.
Is the ID switch on the side of the remote control set to On?	When the switch is set to On, you can use the remote control to operate only a projector with a matching ID. Set ID switch to Off.  p.152
Are the lamp cover and lamps installed correctly?	If the lamp or lamp cover is installed incorrectly, the projector cannot be turned on. Check how it is installed.  p.101

Other problems

The Remote Control does not work

Check	Remedy
Is the remote control light-emitting area pointing towards the remote receiver on the projector when it is operated?	Point the remote control towards the Remote Receiver.  p.18
Is the remote control too far from the projector?	The operating range for the remote control is about 15 m.  p.18
Is direct sunlight or strong light from fluorescent lamps shining onto the Remote Receiver?	Set the projector up in a location where strong light does not shine onto the remote receiver. Or set the remote receiver to Off from Remote Receiver in the configuration menu.  Settings Menu - Remote Receiver p.55
Is the correct setting for the remote receiver selected?	Check the Remote Receiver from the configuration menu.  Settings Menu - Remote Receiver p.55
Are the batteries dead or have the batteries been inserted correctly?	Make sure the batteries are inserted correctly or replace the batteries with new ones if necessary.  p.16
Are the remote control ID and the projector ID matched?	Make sure the ID for the projector you want to operate and the ID for the remote control match. To operate all projectors by remote control regardless of the ID setting, set the ID switch on the side of the remote control to Off.  p.150
Does Remote Control Type match the remote control that you are using?	Check the Remote Control Type on the configuration menu.  Extended Menu - Operation - Remote Control Type p.57
Is the optional remote control cable connected to the remote control or to the projector's Remote port?	When the remote control cable is connected, the remote control light-emitting area or the projector's remote receiver are disabled. When not using the remote control cable set, disconnect it from the remote control and the Remote port.
Is the remote control button lock set?	When the remote control button lock is set, buttons except for those needed for basic remote control operations are deactivated. Hold down the [Help] button to cancel the remote control button lock.  p.42

Nothing appears on the external monitor

Check	Remedy
Are images input from a port other than the Computer or BNC input port?	Only RGB signals from the Computer input port or the BNC input port can be displayed on an external monitor.
Are you projecting a split screen?	Only RGB signals projected on the left screen from the Computer input port or the BNC input port can be displayed on an external monitor.  p.29



I want to change the language for messages and menus

Check	Remedy
Change the Language setting.	Adjust the Language setting from the configuration menu.  Extended Menu - Language p.57

The authentication setting of wireless LAN fails

Check	Remedy
Is the time set correctly?	If the wireless LAN is set correctly but the authentication setting fails, the time may not be set correctly. Check if it is set correctly.  Extended Menu - Time/Schedule Settings p.57

Mail is not received even if a problem occurs in the projector





Check	Remedy
Is Standby Mode set to Communication On ?	To use the Mail Notification function when the projector is in standby, set Communication On in Standby Mode from the configuration menu.  Extended Menu - Standby Mode p.57
Did a fatal abnormality occur and the projector come to a sudden stop?	When the projector comes to a sudden stop, e-mail cannot be sent. If the abnormal state continues, contact your local dealer or the nearest address provided in the Support and Service Guide.  Epson Projector Contact List
Is power being supplied to the projector?	Check that your electrical outlet or power source is functioning correctly.
Is Mail Notification function set correctly in the configuration menu?	Mail notification of problems is sent according to the settings on the Mail Notification menu in the configuration menu. Check if it is set correctly.  Network Menu - Mail Notification Menu p.73

"The battery that saves your clock settings is running low." is displayed.

Cause	Remedy
The internal power supply that saves your clock settings is running low.	Contact your local dealer or the nearest address provided in the Support and Service Guide.  Epson Projector Contact List

Interpreting Event IDs

Check the event ID and perform the remedy given below. If the problem cannot be solved, contact the network administrator or one of the following contact addresses.  [Epson Projector Contact List](#)

Event ID	Cause	Remedy
0432 0435	Failed to startup EasyMP Network Projection.	Restart the projector.
0434 0481 0482 0485	Network communication is unstable.	Check the status of network communications. Wait for a while and then try connecting again.
0433	An image that was transferred cannot be reproduced.	Restart EasyMP Network Projection.
0484	Communications was cut off from the computer.	
04FE	EasyMP Network Projection ended unexpectedly.	Check the status of network communications. Restart the projector.
04FF	A system error occurred in the projector.	Restart the projector.
0891	The same SSID access point cannot be found.	Set the computer, the access point, and the projector to the same SSID.
0892	The WPA and WPA2 authentication methods are not the same.	Check the setting of wireless LAN security to see if it is correct.  Network Menu - Security Menu p.66
0893	The WEP, TKIP, and AES encoding methods are not the same.	
0894	Communications was cut off because a connection was made to the wrong access point.	Check with the network administrator and follow their instructions.
0898	Failed to obtain the DHCP.	Check the DHCP server to see if it is operating correctly and check the LAN cable to see if it is connected correctly. Turn off DHCP if it is not being used.  Network Menu - Wireless LAN Menu p.63 , Wired LAN Menu p.70
0899	Other connection errors	If the problem cannot be solved by restarting the projector or EasyMP Network Projection, contact one of the following contact addresses.  Epson Projector Contact List
089A	The EAP authentication type is not the same.	Check the setting of wireless LAN security to see if it is correct. Also, check if the certificate is imported correctly.  Network Menu - Security Menu p.66
089B	EAP server authentication failed.	
089C	EAP client authentication failed.	
089D	Key exchange failed.	



Maintenance

This chapter explains the maintenance methods that are required to ensure a long projector service life.

You should clean the projector if it becomes dirty or if the quality of projected images starts to deteriorate.

Warning

Do not use sprays containing a flammable gas to remove dirt or dust which is adhering to parts such as the lens or filter of the projector. This could be a cause of the fire for the high temperature of the lamps inside the unit.

Cleaning the Projector's Surface

Clean the projector's surface by wiping it gently with a soft cloth.

If the projector is particularly dirty, moisten the cloth with water containing a small amount of neutral detergent, and then firmly wring the cloth dry before using it to wipe the projector's surface.

Attention

Do not use volatile substances such as wax, alcohol, or thinner to clean the projector's surface. The quality of the case may change or become discolored.

Cleaning the Lens

Use a commercially available cloth for cleaning glasses to gently wipe the lens.

Attention

Do not rub the lens with harsh materials or subject the lens to shocks, as it can easily become damaged.

Cleaning the Air Filter

Clean the air filter and the air intake vent when the following message is displayed or the Filter indicator is flashing green.

Time to clean the air filter.

Clean or replace the air filter.

Attention

- If dust collects on the air filter it can cause the internal temperature of the projector to rise, and this can lead to problems with operation and shorten the optical engine's service life. Clean the air filter immediately when the message is displayed.
- If the air filter is stained yellow with tobacco smoke, it cannot be cleaned. In this case, replace it with a new air filter.  p.104
- Do not rinse the air filter in water. Do not use detergents or solvents.
- When using a brush for cleaning, use one with long soft bristles, and brush it lightly. If it is brushed too strongly, dust will be ground into the air filter and cannot be removed.

Procedure

- 1 **After you turn off the projector's power and the confirmation buzzer beeps twice, disconnect the power cable.**
- 2 **Remove the air filter cover.**
Grip the air filter cover tab between your fingers, and pull up and remove the cover while pressing the tab.

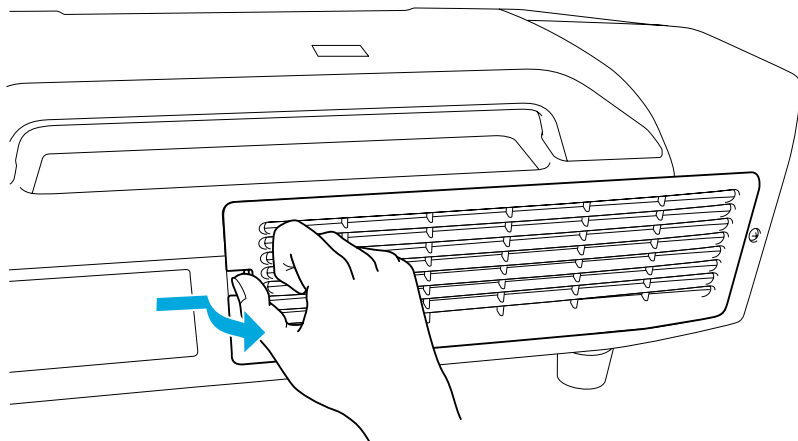

3 Remove the air filter.

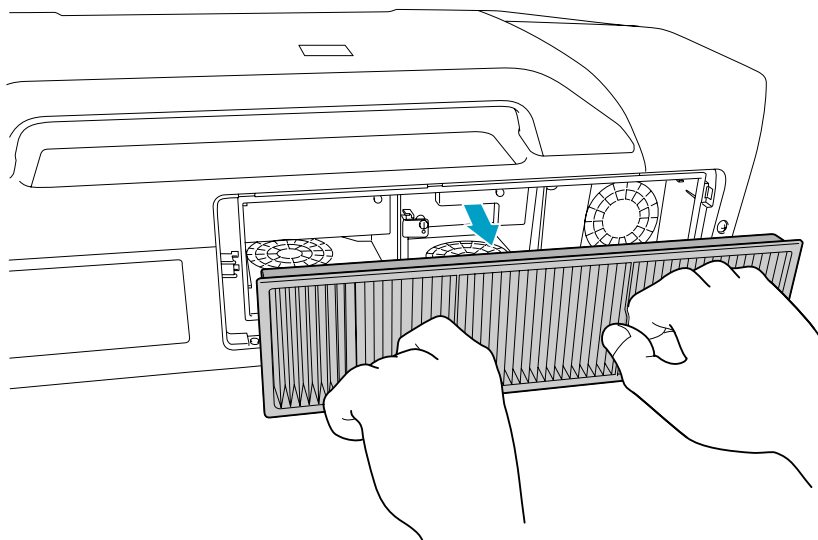

4 With the front (the side with tabs) of the air filter facing down, tap the air filter four or five times to shake off the dust. Turn it over and tap the other side in the same way.

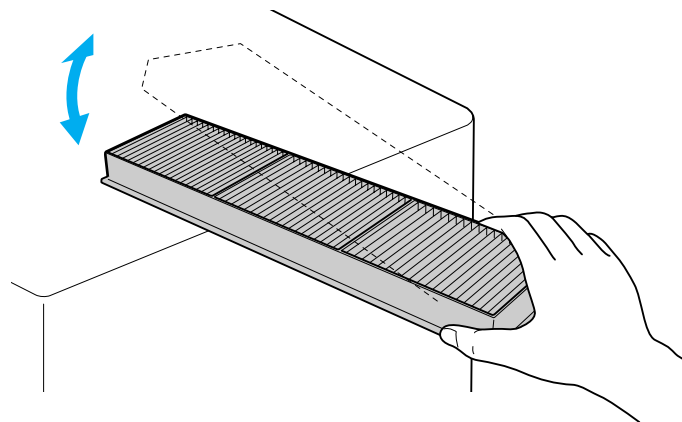

Attention

If the air filter is hit too hard, it may become unusable due to deformities and cracks.

5 Remove any dust remaining on the air filter by using a vacuum cleaner from the front side.

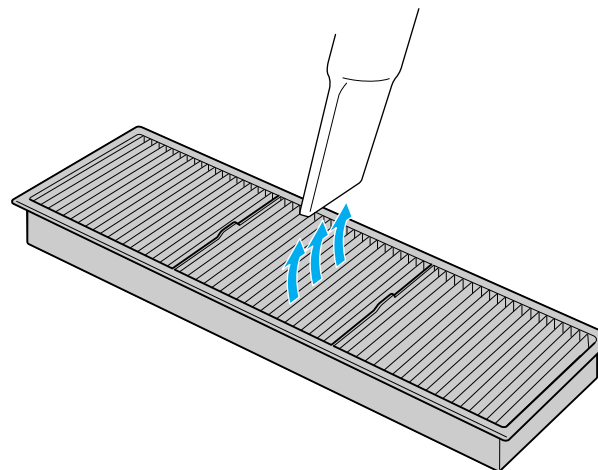

6 Replace the air filter.

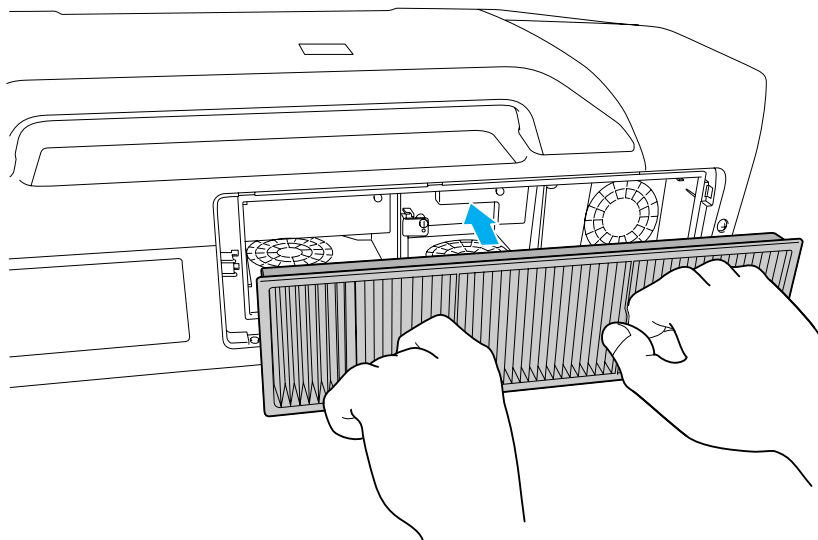

7

Replace the air filter cover.

Press until it clicks into place.

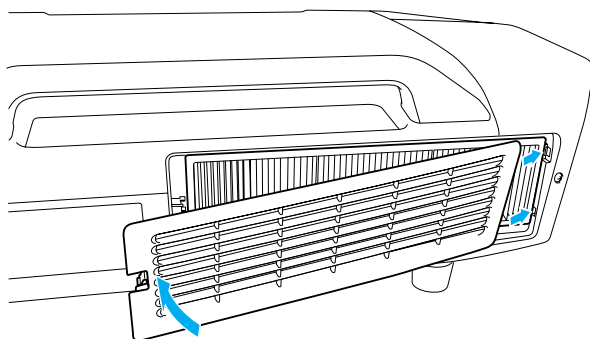

If a message is frequently displayed, even after cleaning, it is time to replace the air filter. Replace it with a new air filter. [p.104](#)

Replacing the Lamps

Lamp replacement period

It is time to replace the lamp when:

- The message "Replace the lamp." is displayed at the lower left of the projection screen when you start projecting.

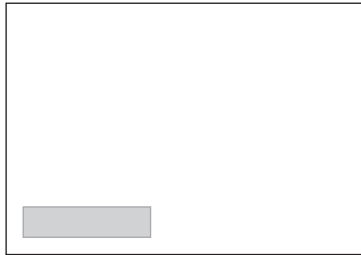

- The lamp indicator flashes orange.
Replace the lamp indicated by the flashing indicator, either lamp 1 or 2.

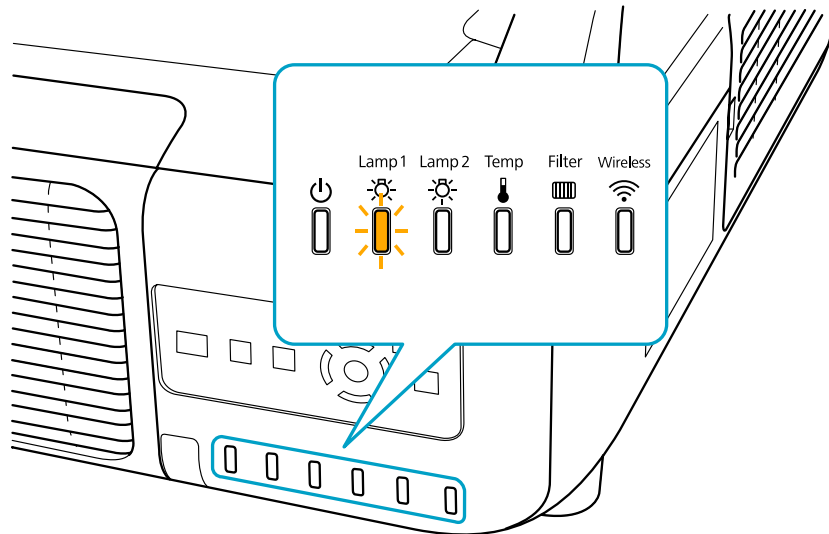



- The projected image gets darker or starts to deteriorate.

Attention

- The lamp replacement message is set to appear after the following time periods in order to maintain the initial brightness and quality of the projected images.
EB-Z8455WU/Z8450WU/Z8355W/Z8350W/Z10005/Z10000
When using **Power Consumption** continually at Normal 1: About TBD hours
When using **Power Consumption** continually at ECO: About TBD hours
EB-Z8150: About TBD hours
- Do not turn the projector on immediately after turning it off. Turning the projector on and off frequently may shorten the life of the lamps.
- If you continue to use the lamp after the replacement period has passed, the possibility that the lamp may explode increases. When the lamp replacement message appears, replace the lamp with a new one as soon as possible, even if it is still working.
- Depending on the characteristics of the lamp and the way it has been used, the lamp may become darker or stop working before the lamp warning message appears. We recommend that you keep a replacement lamp on hand at all times.



We recommend that you clean the air filter whenever you replace the lamp.  p.98

Replace the air filter if it is discolored or if a message appears even after cleaning the air filter.  p.104

How to replace the lamp

The lamps can be replaced even when the projector is suspended from a ceiling.

Warning

- When replacing the lamps because they have stopped illuminating, there is a possibility that the lamp may be broken. If replacing the lamp of a projector which has been installed on the ceiling, you should always assume that the lamp is broken, and you should stand to the side of the lamp cover, not underneath it. Remove the lamp cover gently.
- Never disassemble or remodel the lamp. If a remodeled or reassembled lamp is installed into the projector and used, it could cause a fire, electric shock, or an accident.

Caution

Wait until the lamps have cooled down sufficiently before removing the lamp cover. If the lamp is still hot, burns or other injuries may result. It takes about one hour after the power has been turned off for the lamp to be cool enough.

Procedure

- 1 After you turn off the projector's power and the confirmation buzzer beeps twice, disconnect the power cable.
- 2 Wait until the lamps have cooled down sufficiently before removing the lamp cover on the back of the projector.
Pinch the tabs on the front of the lamp cover together to release the lock. When the lock releases, pull the cover straight out.

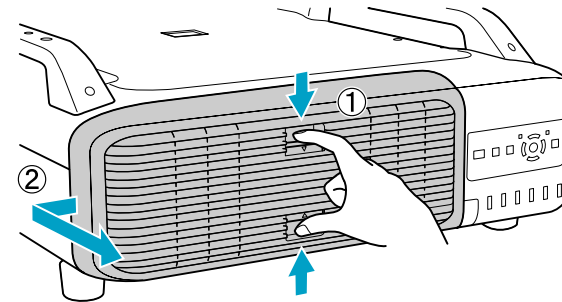

- 3 Pull up the lock lever for the lamp you want to replace and pull the lamp straight out.

If the lamp is cracked, replace it with a new lamp, or contact your local dealer for further advice. [Epson Projector Contact List](#)

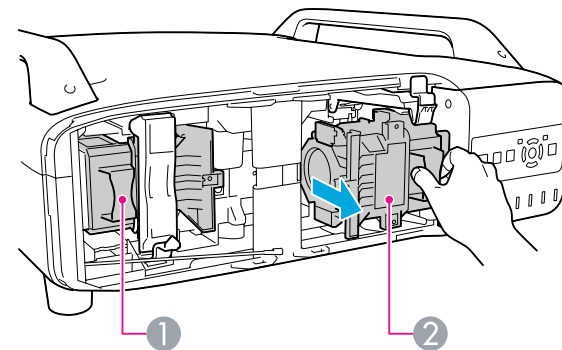
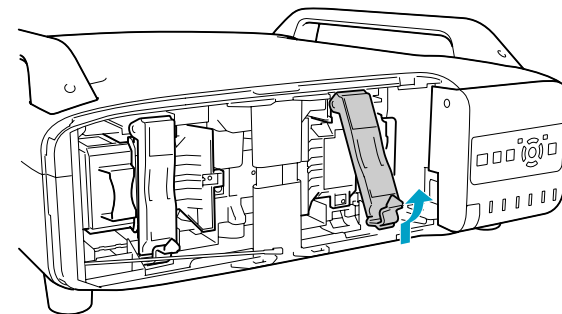

1 Lamp 1

2 Lamp 2

4

Install the new lamp.

Insert the lamp along the guide rail in the correct direction so that it fits in place and press it firmly to the back. Pull down the lock lever until it clicks into place.

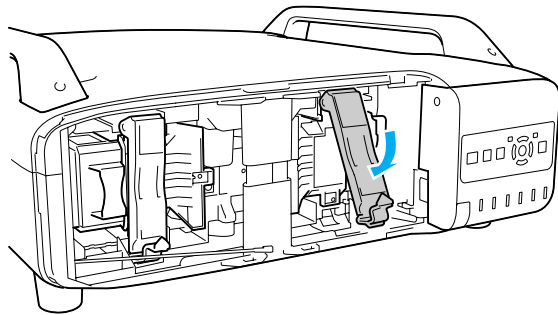
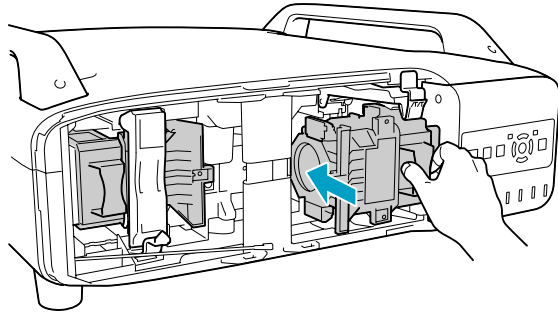
**5**

Replace the lamp cover.

Press the cover against the unit and slide it to the right until it clicks.

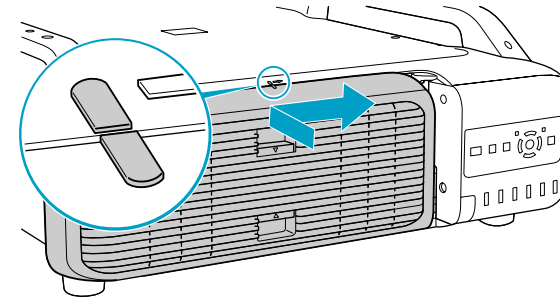

Attention

- Make sure you install the lamp securely. If the lamp cover is removed, the lamps turn off automatically as a safety precaution. If the lamp or the lamp cover is not installed correctly, the lamp will not turn on.
- This product includes a lamp component that contains mercury (Hg). Please consult your local regulations regarding disposal or recycling. Do not dispose of it with normal waste.

Resetting the Lamp Hours

The projector records how long the lamps are turned on and a message and indicator notify you when it is time to replace the lamp. After replacing the lamps and turning on the power, the following message is displayed on the screen and you can reset the lamp-hour counter.

Select **Yes**, and then press the [Enter] button.

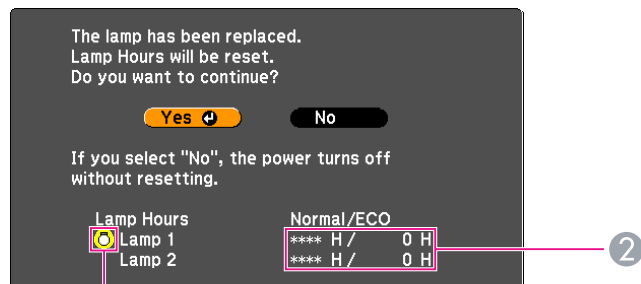

①

- ① Displays the replacement for the lamp 1.
- ② Displays the cumulative lamp operating time. If you select **Yes** and reset the Lamp Hours, the count for lamp 1 is set to 0H.

Replacing the Air Filter

Air filter replacement period

It is time to replace the air filter when:

- The air filter is discolored.
- The message is displayed even though the air filter has been cleaned.

How to replace the air filter

The air filter can be replaced even when the projector is suspended from a ceiling.

Procedure

- ① After you turn off the projector's power and the confirmation buzzer beeps twice, disconnect the power cable.

- ② Remove the air filter cover.
Grip the air filter cover tab between your fingers, and pull up and remove the cover while pressing the tab.

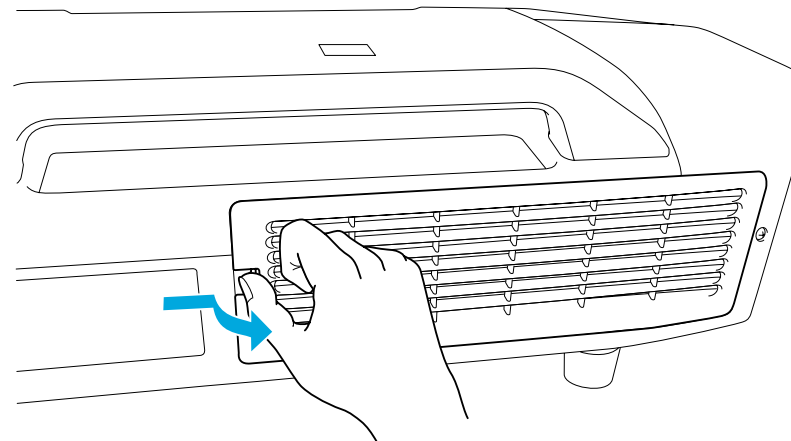

- ③ Remove the air filter.

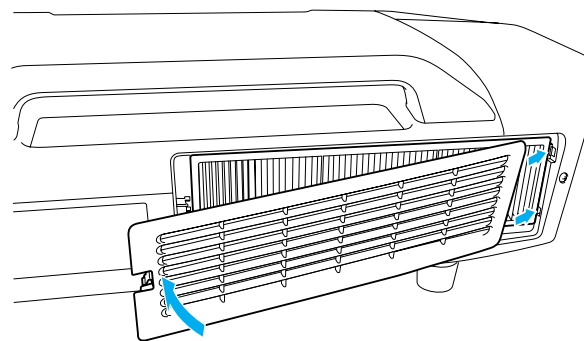
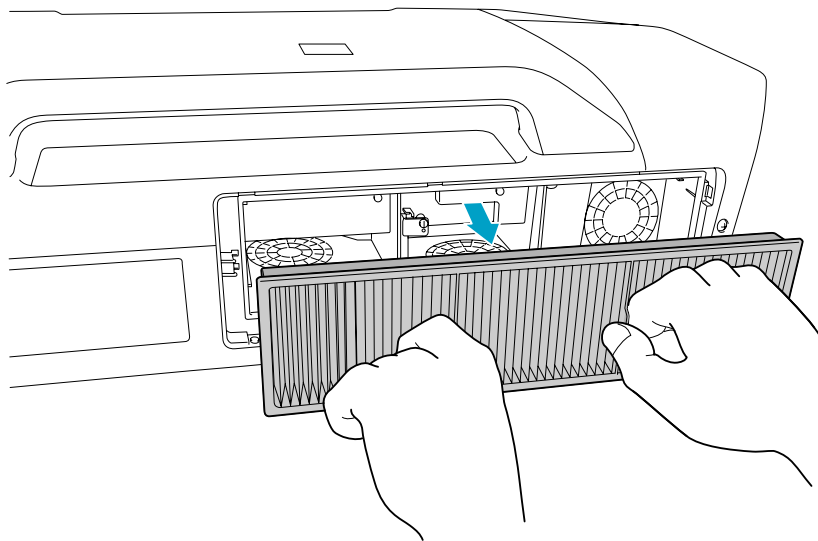

 Dispose of used air filters properly in accordance with your local regulations.
Material of the frame part: Polypropylene
Material of the filter part: Polypropylene

4 Install the new air filter.

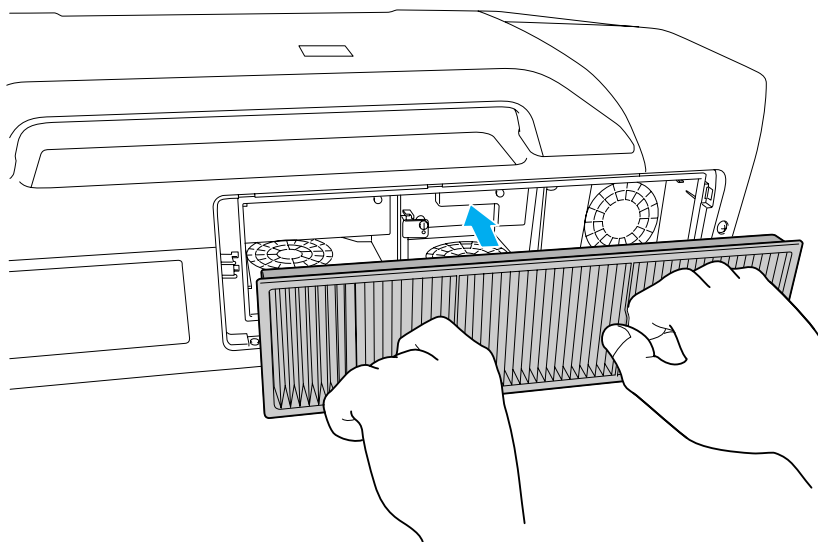

5 Replace the air filter cover.
Press until it clicks into place.

There are many glass parts and precision components inside the projector. To prevent damage due to impacts when transporting, handle the projector as follows.

Moving Nearby

Checking the following points, and then carry carefully by the handles.

- Turn off the power to the projector and disconnect all cables.
- Attach the cover to the lens.



Caution

*Do not carry the projector by one person.
Two people are needed to unpack or carry the projector.*

When Transporting

Preparing packaging

After checking the points in "Moving Nearby", prepare the following and then pack up the projector.

- Remove the lens unit if an option lens, other than the standard zoom lens, is installed. Attach the standard zoom lens if the projector has a built-in lens. If the projector does not have a lens, attach the cover that was on the lens mount when you purchased the projector.
- The vertical and horizontal lens shifts are positioned in the center.
- Fit the protective lens pad that was used at the time of purchase.

Notes when packing and transporting

Enclose the projector securely in buffer material to protect it from shock, and place it into a strong cardboard container. Be sure to notify the carrier company that the contents are fragile.



Monitoring and Controls

This chapter explains the functions that can be used to monitor and control the projector.

EasyMP Monitor lets you carry out operations such as checking the statuses of multiple Epson projectors that are connected to a network at a computer monitor, and controlling the projectors from the computer.

Download the EasyMP Monitor software from the following website.

<http://www.epson.com>

Following are brief descriptions of the monitoring and control functions that can be carried out using EasyMP Monitor.

- **Registering projectors for monitoring and control**

Projectors on the network can be searched for automatically, and you can then select projectors to be registered from the projectors that are detected.

You can enter the IP addresses for target projectors to register them.

- **Registered projectors can also be assigned to groups so that they can be monitored and controlled in groups.**

- **Monitoring the statuses of registered projectors**

The power status (ON/OFF) for projectors and problems or warnings requiring attention can be checked visually by means of icons.

You can select groups of projectors or a single projector that you are interested in, and then check the cumulative lamp operating time or the details of information such as input sources, problems, and warnings for these projectors.

- **Controlling registered projectors**

Projectors can be selected in groups or as single projectors, and you can then carry out operations for the selected projectors such as turning the power on and off and switching their input sources.

Web Control functions can be used to change the settings in the projector's configuration menu.

If there are certain control actions which are carried out regularly at particular times or on particular days, you can use Timer Settings to register timer settings.

- **Mail Notification settings**

You can set e-mail addresses to which notifications are sent if a status requiring attention, such as a problem, occurs with a projector that has been registered.



- **Sending messages to registered projectors**

The Message Broadcasting plugin for EasyMP Monitor can be used to send JPEG files to registered projectors.  [p.122](#)

You can make Configuration menu settings and control the projector by using the Web browser of a computer that is connected to the projector via a network. Setup and control operations can be performed remotely if this function is used. In addition, you can use the computer's keyboard, so it is easier to enter characters needed for setup, such certificate settings.

Use Microsoft Internet Explorer 6.0 or later as the Web browser. If using a Mac OS, use Safari or Firefox.



- When communicating with a wireless LAN, connect in Advanced mode.  p.63
- Setup and control with a Web browser are possible if **Standby Mode** is set to **Communication On** from the **Extended** menu of the projector's Configuration menu, even if the projector is in standby state (when the power is off).  p.57

Displaying Web Control

Use the following procedure to display Web Control.



- If your Web browser is set up to connect via a proxy server, Web Control cannot be displayed. To use Web Control, you need to make network connection settings with a device other than a proxy server.
- When setting the security using Web Control, we recommend setting Secure HTTP to On.  p.71, "Secure HTTP Notes"

Procedure

- 1 Start the Web browser on the computer.



- 2 Enter the IP address of the projector in the address input box of the Web browser, and press the [Enter] key on the computer's keyboard.

Web Control is displayed.

When Web Control Password is set in the Network menu from the projector's Configuration Menu, enter the Password. Enter **EPSONWEB** as the user name. Enter the characters set for the web control password as the password. The default password is **admin**.

Displaying Web Remote

The Web Remote function allows you to perform projector remote control operations from a Web browser.

Procedure



- 1 Display Web Control.  "Displaying Web Control" p.109



- 2 Click Web Remote.

Example: Web browser of a computer



- 3 The Web Remote screen appears.

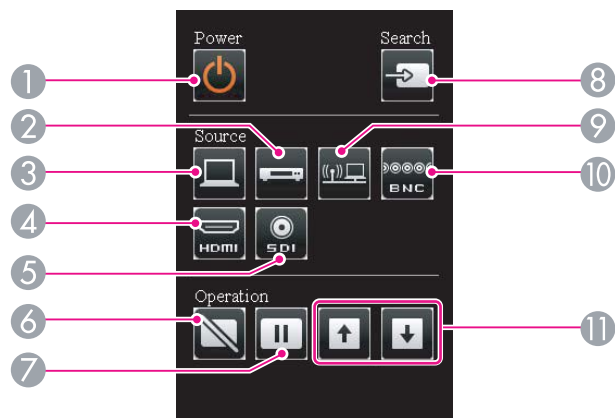

Name	Function
① [Power] button	Turns the projector power On or Off.
② [Video] button	Each time the button is pressed, the image displayed changes between the Video input port and S-Video input port.
③ [Computer] button	The input source will change to Computer .
④ [HDMI] button	Each time the button is pressed, the image displayed changes between the HDMI1 input port and HDMI2 input port.
⑤ [SDI] button	The input source will change to SDI . (EB-Z8455WU/ Z8450WU only)
⑥ [Shutter] button	Turns the video on or off. 🖱️ p.33
⑦ [Freeze] button	Images are paused or unpaused. 🖱️ p.33
⑧ [Search] button	Changes to the next input source that is connected to the projector and is sending an image. 🖱️ p.20
⑨ [LAN] button	The input source will change to LAN .
⑩ [BNC] button	The input source will change to BNC .
⑪ [Page] buttons [↑][↓]	These buttons can be used to page up and down when projecting an image from a computer that is connected to the projector through the network.

Displaying Lens Control

The Lens Control function allows you to operate the projector's lens from a web browser.

Procedure

- ① Display Web Control. 🖱️ "Displaying Web Control" p.109
- ② Click Lens Control.

Example: Web browser of a computer



- ③ The Lens Control screen appears.

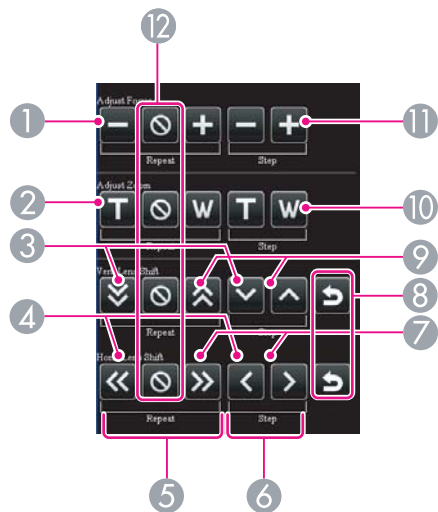

Name	Function
① [Scale down] button	Adjusts the focus.
② [Tele] button	Reduces the image without changing the projection size.
③ [Down] button	Shifts the lens downward.
④ [Left] button	Shifts the lens leftward.
⑤ [Repeat] button	Continues adjusting until the [Stop] button is pressed.
⑥ [Step] button	Adjusts by one step each time the button is pressed.
⑦ [Right] button	Shifts the lens rightward.
⑧ [Default Shift] button	Reset the default for the lens shift adjustment.
⑨ [Up] button	Shifts the lens upward.
⑩ [Wide] button	Enlarges the image without changing the projection size.
⑪ [Scale Up] button	Adjusts the focus.
⑫ [Stop] button	Stops the adjustment.

Setting Certificates

You can use a web browser to set the certificate settings used for wireless LAN authentication.

Install the following certificates in the projector: Client Certificate and CA certificate for wireless LAN security settings, and Web Server Certificate for the Secure HTTP function.

Procedure

- ① **Display Web Control.** ➔ "Displaying Web Control" p.109
- ② **Click Network menu - Administrator Settings - Manage Certificates.**
- ③ **The Manage Certificates screen appears.**

Sub Menu	Items/Values
Client Certificate	Refresh/Clear
	Issued to
	Issued by
	Validity period
CA certificate	Refresh/Clear
	Issued to
	Issued by
	Validity period
Self-signed Certificate	Refresh/Clear
	Issued to
	Issued by
	Validity period

Sub Menu	Items/Values
Web Server Certificate	Refresh/Clear
	Issued to
	Issued by
	Validity period



When installing a certificate, make sure the projector supports its format. 🖱️ "Supported Certificates" [p.177](#)

Secure HTTP Notes

When Secure HTTP is set to On, security using HTTPS protocol is automatically applied between the projector and web browser of the computer connected to the network. You can use this function for secure communication between the projector and Web browser.

A certificate is used in communication using HTTPS protocol, to certify reliability of the server. The projector automatically makes internally and communicates its self-signed certificate. This self-signed certificate cannot verify reliability from a computer's web browser, so it shows a warning on reliability of the server when you access from a web browser. Ignore this warning.

You can separately create a server certificate which can be verified from a computer's web browser, and install it in the projector to prevent this warning. 🖱️ "Supported Certificates" [p.177](#)

By setting the **Mail Notification** function from the projector's Configuration Menu, notification messages will be sent to the preset email addresses when a problem or warning occurs with a projector. This will enable the operator to be notified of problems with projectors even at locations away from the projectors. 🖱️ [Network Menu - Administrator Settings - Mail Notification p.73](#)



- Up to three notification destinations (Addresses) can be recorded, and notification messages can be sent to all three destinations at once.
- If a projector develops a critical problem and suddenly stops working, it may not be able to send a message notifying an operator of the problem.
- Monitoring is possible if **Standby Mode** is set to **Communication On** from the **Extended** menu of the projector's Configuration Menu, even if the projector is in standby state (when the power is off). 🖱️ [p.57](#)

Reading Problem Mail Notification Function

When the **Mail Notification** function is set to **On** and a problem/warning occurs in the projector, the following e-mail is sent.

Sender: Email Address 1

Subject: EPSON Projector

Line 1: The name of the projector where the problem has occurred

Line 2: The IP address set for the projector where the problem has occurred.

Line 3 and on: Details of the problem

The details of the problem are listed line by line. The following table shows the details that are given in the message for each item. To deal with problems/warnings, see "Reading the Indicators" 🖱️ [p.83](#)

Message	Cause (Problems/Warnings)
Clean Air Filter	Air Filter Notice

Message	Cause (Problems/Warnings)
Fan related error	Fan Error
High-speed cooling in progress	High Temp Warning
Internal error	Internal Error
Internal temperature error	High Temp Error (Overheating)
Lamp cover is open.	Lamp Cover Open
Lamp out	Lamp Error
Lamp replacement notification	Replace Lamp
Lamp timer failure	Lamp Failure
Low Air Flow	Low Air Flow
Low Air Flow Error	Filter Airflow Error
No-signal	No Signal No Signal is input to the projector. Check the connection status or check that the power for the signal source is turned on.
Power Err. (Ballast)	Power Err. (Ballast)
Sensor error	Sensor Error

A (+) or (-) appears at the start of the message.

(+): A projector problem has occurred

(-): A projector problem has been dealt with

By setting **SNMP** from the projector's configuration menu, notification messages are sent to preset e-mail addresses when a problem or warning occurs with a projector. This is useful when controlling projectors centrally at a point distant from them.  [p.71](#)



- SNMP should be managed by a network administrator or someone who is familiar with the network.
- To use the SNMP function to monitor the projector, you need to install the SNMP manager program on your computer.
- The managing function using SNMP cannot be used via wireless LAN in Quick mode.
- Up to two destination IP addresses can be saved.

Serial Connection

- Connector shape: D-Sub 9-pin (male)
- Projector input port name: RS-232C

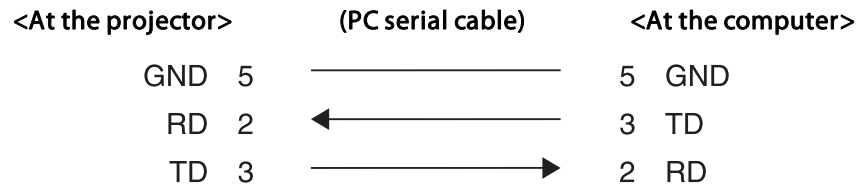
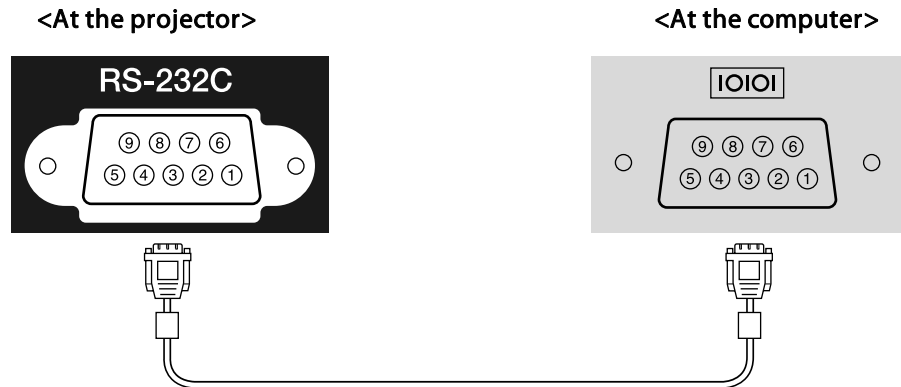

Signal Name	Function
GND	Signal wire ground
TD	Transmit data
RD	Receive data

Communications Protocol

- Default baud rate setting: 9600 bps
- Data length: 8 bit

- Parity: None
- Stop-bit: 1 bit
- Flow control: None

Command List

When the power ON command is transmitted to the projector, the power turns on and it enters warm-up mode. When the projector's power has turned on, a colon ":" (3Ah) is returned.

When a command is input, the projector executes the command and returns a ":", and then accepts the next command.

If the command being processed terminates abnormally, an error message is output and a ":" is returned.

Item		Command	
Power ON/OFF	On	PWR ON	
	Off	PWR OFF	
Signal selection	Computer	Auto	SOURCE 1F
		RGB	SOURCE 11
		Component	SOURCE 14
	BNC	Auto	SOURCE BF
		RGB	SOURCE B1
		Component	SOURCE B4
	HDMI1	SOURCE 30	
	HDMI2	SOURCE A0	
	SDI (EB-Z8455WU/Z8450WU only)	SOURCE 60	
	Video	SOURCE 45	
S-Video	SOURCE 42		
LAN	SOURCE 53		



Item			Command
Shutter Button	Electric Shutter/ Blank	On	MUTE ON
		Off	MUTE OFF

Add a Carriage Return (CR) code (0Dh) to the end of each command and transmit.

PJLink Class1 was established by the JBMIA (Japan Business Machine and Information System Industries Association) as a standard protocol for controlling network-compatible projector's as part of their efforts to standardize projector control protocols.

The projector complies with the PJLink Class1 standard established by the JBMIA.

It complies with all commands except for the following commands defined by PJLink Class1, and agreement was confirmed by the PJLink standard adaptability verification.

URL: <http://pjlink.jbmia.or.jp/english/>

- **Non-compatible commands**

Function	PJLink Command
Image muting set	AVMT 11

- **Input names defined by PJLink and corresponding projector sources**

Source	PJLink Command
Computer	INPT 11
BNC	INPT 13
Video	INPT 23
S-Video	INPT 22
HDMI1	INPT 32
HDMI2	INPT 33
SDI (EB-Z8455WU/Z8450WU only)	INPT 34
LAN	INPT 52

- Manufacturer name displayed for "Manufacture name information query"
EPSON

- Model name displayed for "Product name information query"
EB-Z8450WU/Z8455WU/Z9750WU/B1575WU/PL Pro Z8450WU/Z8455WU
EB-Z8350W/Z8355W/Z9850W/B1585W/PL Pro Z8350W/Z8355W
EB-Z10000/Z10005/Z9900/B1500/PL Pro Z8250/Z8255
EB-Z8150/Z9800/PL Pro Z8150

Crestron RoomView® is an integrated control system provided by Crestron®. It can be used to monitor and control multiple devices connected on a network.

The Projector supports the control protocol, and can therefore be used in a system built with Crestron RoomView®.

Refer to the Crestron® website for details on Crestron RoomView®. (Only English-language displays are supported.)

<http://www.crestron.com>

An overview of Crestron RoomView® is provided below.

- **Remote operation using a Web browser**

A Projector can be operated from a computer window just like using a remote control.



- **Monitoring and control with application software**

Crestron RoomView® Express or Crestron RoomView® Server Edition provided by Crestron® can be used to monitor devices in the system, to communicate with the help desk, and to send emergency messages. Refer to the following website for details.

<http://www.crestron.com/getroomview>

This manual describes operating procedures in the computer window using a Web browser.





- Only single-byte alphanumeric characters and symbols can be entered.
- The following functions cannot be used while using the Crestron RoomView®.
 - Web Control  p.109
 - Message Broadcasting (EasyMP Monitor plugin)
- Controlling is possible if **Standby Mode** is set to **Communication On** from the **Extended** menu of the projector's configuration menu, even if the projector is in standby state (when the power is off).
 -  p.57

Operating a Projector from a Computer Window

Displaying the operation window

Confirm the following before performing the procedure.

- Make sure the computer and projector are connected to the network. When communicating with a wireless LAN, connect in Advanced mode.  p.63
- Set **Crestron RoomView** to **On** on the **Administrator Settings** menu under the **Network** menu. Changes in projector settings take effect upon restarting.  p.71

Procedure

1

Start the Web browser on the computer.

2

Enter the IP address of the projector in the address field of the Web browser, and press the [Enter] key on the keyboard.

The operation window will be displayed.

Using the operation window

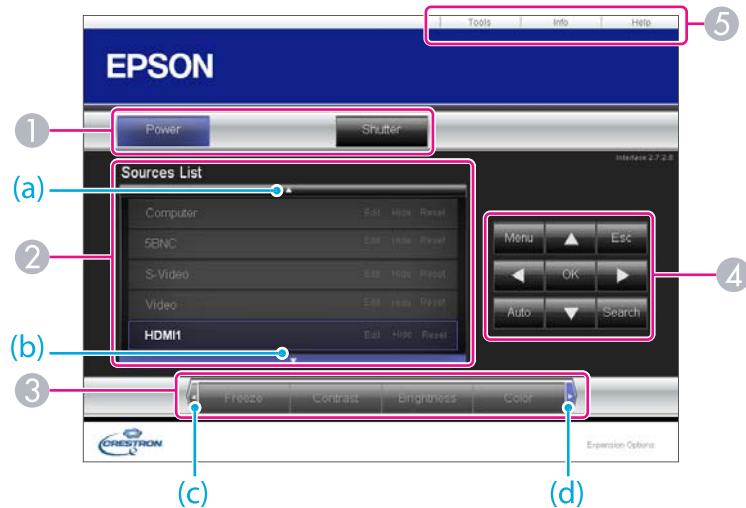



1 The following operations will be performed when the buttons are clicked.



Button	Function
Power	Turns the projector power on or off.
Shutter	You can use this when you want to focus the audience's attention on what you are saying, or if you do not want to show details such as when you are changing between files during presentations from a computer.  p.33

2 Switch to the image from the selected input source. To display input sources that are not shown in the window, click (a) or (b) to scroll up or down. The source name can be changed optionally.

3 The following operations will be performed when the buttons are clicked. To display buttons that are not shown in the window, click (c) or (d) to scroll left or right.

Button	Function
Freeze	Images are paused or unpaused.  p.33
Contrast	Adjusts the difference between light and shade in the images.
Brightness	Adjusts the image brightness.
Color	Adjusts the color saturation for the images.
Sharpness	Adjusts the image sharpness.
Zoom	Click the [⊕] button to enlarge the image without changing the projection size. Click the [⊖] button to reduce an image that was enlarged with the [⊕] button. Click the [▲], [▼], [◀], or [▶] button to change the position of an enlarged image.  p.34

4 Clicking the [▲], [▼], [◀], or [▶] button performs the same operation as the [⊕] button on the remote control. The following operations will be performed when the other buttons are clicked.

Button	Function
OK	Performs the same operation as the [Enter] button on the remote control.  p.15
Menu	Displays and closes the configuration menu.
Auto	If clicked when the computer analog RGB signals are being projected, automatically optimizes the image by adjusting the Tracking, Sync., and Zoom Position.
Search	Switches to the image from the input port where video signals are being input.  p.20
Esc	Performs the same operation as the [Esc] button on the remote control.  p.15

5 The following operations will be performed when the tabs are clicked.

Tab	Function
Contact IT Help	Displays the Help Desk window. Used to send and receive messages to the administrator using Crestron RoomView® Express.
Info	Displays information on the projector that is currently connected.
Tools	Changes the settings in the projector that is currently connected. Refer to the next section.

Using the tools window

The following window will be displayed if the **Tools** tab is clicked in the operation window. This window is used to change the settings in the projector that is currently connected.

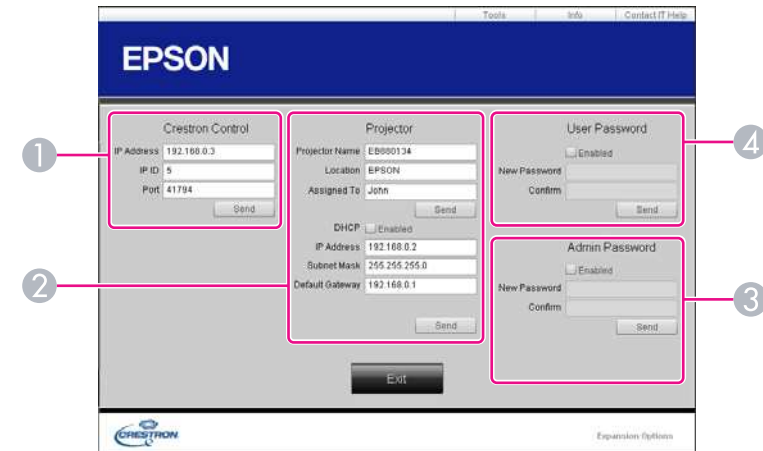

- 1 **Crestron Control**
Makes settings for Crestron® central controllers.
- 2 **Projector**
The following items can be set.

Item	Function
Projector Name	Enter a name to differentiate the projector that is currently connected from other projectors on the network. (The name can contain up to 15 single-byte alphanumeric characters.)
Location	Enter an installation location name for the projector that is currently connected on the network. (The name can contain up to 32 single-byte alphanumeric characters and symbols.)
Assigned To	Enter a user name for the projector. (The name can contain up to 32 single-byte alphanumeric characters and symbols.)

Item	Function
DHCP	Select the Enabled check box to use DHCP. The following address cannot be set if DHCP is enabled.
IP Address	Enter the IP address to assign to the currently connected projector.
Subnet Mask	Enter a subnet mask for the projector that is currently connected on the network.
Default Gateway	Enter the gateway address for the currently connected projector.
Send	Click this button to commit changes made to the Projector .

3 Admin Password

Select the **Enabled** check box to require a password to open the Tools window. The following items can be set.

Item	Function
New Password	Enter the new password when changing the password to open the Tools window. (The password can contain up to 26 single-byte alphanumeric characters.)
Confirm	Enter the same password as you entered in New Password . If the passwords are not the same, an error will be displayed.
Send	Click this button to commit changes made to the Admin Password .

4 User Password

Select the **Enabled** check box to require a password to open the operation window on the computer. The following items can be set.

Item	Function
New Password	Enter the new password when changing the password to open the operation window. (The password can contain up to 26 single-byte alphanumeric characters.)
Confirm	Enter the same password as you entered in New Password . If the passwords are not the same, an error will be displayed.
Send	Click this button to commit changes made to User Password .

Message Broadcasting is plugin software for EasyMP Monitor.

Message Broadcasting can be used to send a message (JPEG file) to project on all Epson projectors or specified projectors connected on the network.

The data can be sent manually, or sent automatically using Timer Settings of EasyMP Monitor.

Download the Message Broadcasting software from the following website.

<http://www.epson.com>



Network Functions

This chapter explains the additional functions for networks.

"Connect to a Network Projector" is a standard function in Windows Vista and Windows 7. You can project images from the computer by detecting the projector on the network only by using a function of the OS without having to install any special software.

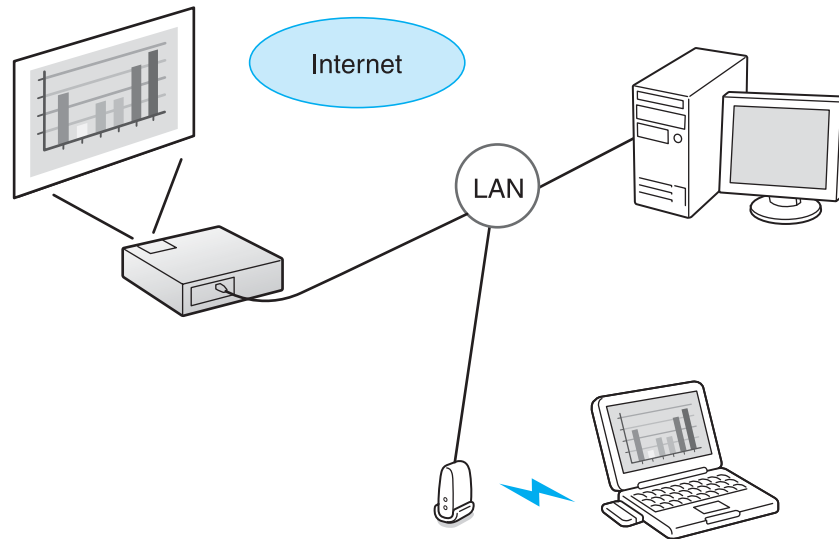

Compatible OS

Windows Vista: Home Premium/Business/Enterprise/Ultimate
Windows 7: Professional/Ultimate

This section provides an easy explanation of "Connect to a Network Projector".

Check that the projector and computer are connected to the network, and carry out the following operations.

Procedure

- 1 Turn the projector on and switch the input source to LAN.
☛ "Changing the Projected Image" p.20

- 2 On the computer, start Windows, and then click "Start" - "All programs" - "Accessories" - "Connect to a Network Projector".

The connection setting screen is displayed.

The projector is identified by inputting its IP address, or by allowing the OS to automatically identify all of the connected projectors.

- 3 Once the OS has identified all of the connected projectors, select the one that you want to use and click "Connect".

When the projector password screen is displayed, enter the keyword shown at the bottom of the LAN standby screen.



- You can connect only one projector to a computer.
- When using Network Projector from Options in Windows Meeting Space, set the colors for the computer screen you are using to the highest level (32bit). If it is not capable of a 32bit display, a message is displayed and you cannot connect.

There are two methods for setting WPS».

- Push Button Method
SSID and security are set automatically when the [Enter] button is pressed on the projector's control panel and the dedicated button on the access point equipment. This method is recommended when the projector and access point are close together.
- PIN Code Method
SSID and security are set automatically by inputting an 8-digit code that was assigned to the projector from the computer to the access point in advance. Make connection settings between the computer and the access point in advance. For details on how to make this connection, refer to the manual provided with the access point. This method is recommended when the projector is mounted on the ceiling.



Refer to the documentation for the access point device and to the following section when using any connection method other than WPS.
☞ "Wireless LAN Menu" p.63

Connection Setup Method

Procedure

- 1 During projection, press the [Menu] button and select "Network" - "Network Configuration" from the configuration menu.

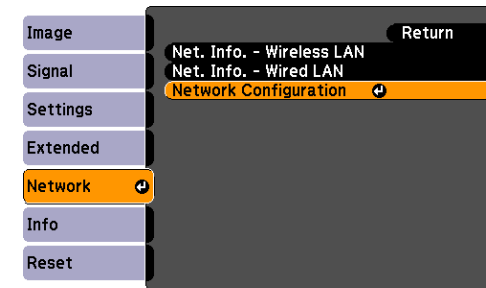

The Network Configuration screen is displayed.



From "Wireless LAN" select "To Setup Wizard".



The following screen is displayed.

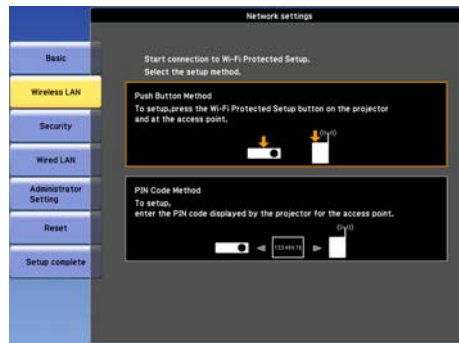

When connecting using the Push Button Method, follow the steps given below.

Go to "Making a connection using the PIN Code Method" when connecting using the PIN Code Method. [p.127](#)

Making a connection using the push button method

Procedure

- 1 Select "Push Button Method".

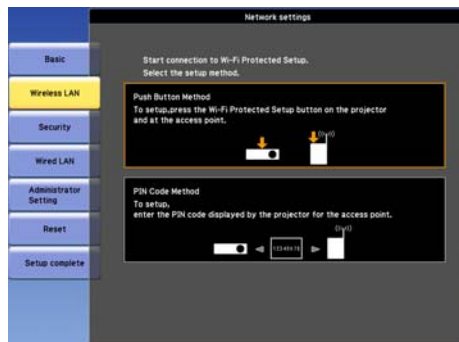

The "Push Button Method" screen is displayed.

- 2 Press the [Enter] button on the projector's control panel when prompted by the screen.



Then, the "Push Button Method" screen is displayed.

- 3 Press the button on the access point when prompted by the screen.

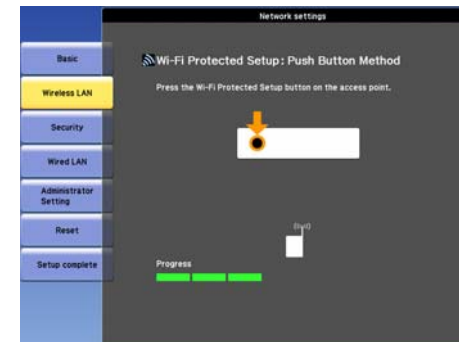

This completes the setup.

- 4 Press the [Enter] button or the [Esc] button. It returns to the Wireless LAN menu screen.
- 5 Select "Setup complete" - "Yes."

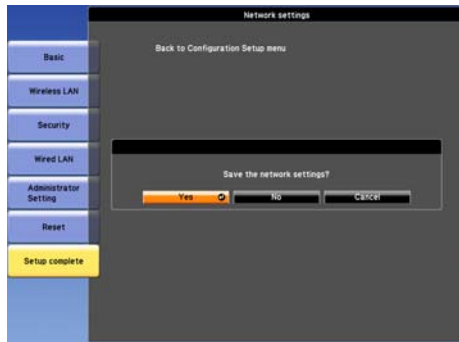

This completes the setup of the connection between the projector and the access point. Press the [Menu] button to close the configuration menu.

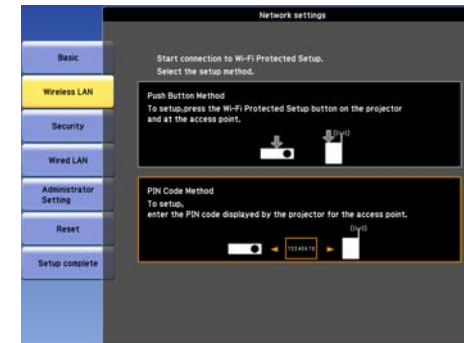

The "PIN Code Method" screen is displayed.

2

Enter the PIN code displayed on the "PIN Code Method" screen from the computer to the access point, and then select "Start Setup".

Making a connection using the PIN Code Method



Before you can make a connection using the PIN Code Method, a connection must have already been setup between the computer and the access point.

Procedure

1

Select "PIN Code Method".

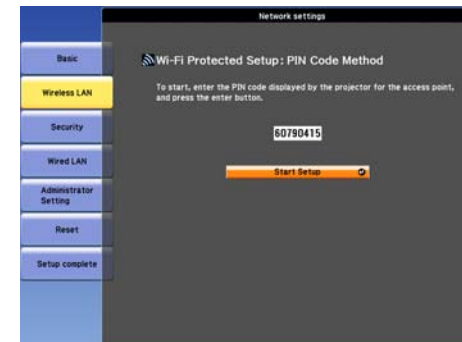

The progress is displayed.

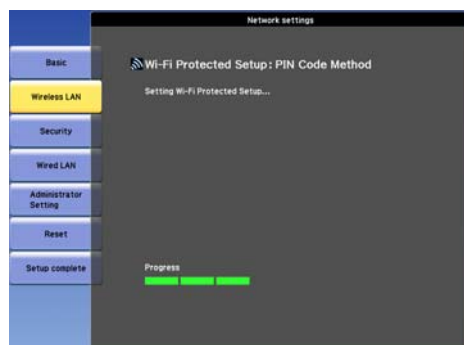

- 3** The message "Setup by Wi-Fi Protected Setup complete." is displayed. Press the [Enter] button or the [Esc] button.

It returns to the Wireless LAN menu screen.

- 4** Select "Setup complete" - "Yes."

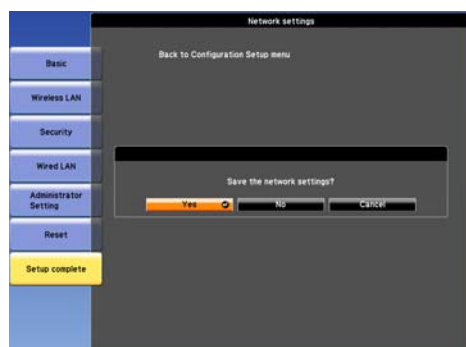

This completes the setup of the connection between the projector and the access point. Press the [Menu] button to close the configuration menu.



Installation and Connections

This chapter explains the projection installation methods and methods to connect to other equipment.

The projector can be mounted on a ceiling or placed on a desk as shown below. Also, it can be mounted at a tilted angle, so you can flexibly project images to various places.

Warning

- A special method of installation is required when suspending the projector from a ceiling (ceiling mount). If installation work is not carried out correctly, the projector could fall down. This may result in injury or accidents. Contact your dealer or the nearest address provided in the Support and Service Guide if you want to use this installation method.  [Epson Projector Contact List](#)
- If you use adhesives on the Ceiling mount fixing points to prevent the screws from loosening, or if you use things such as lubricants or oils on the projector, the projector case may crack causing it to fall from its ceiling mount. This could cause serious injury to anyone under the ceiling mount and could damage the projector. When installing or adjusting the Ceiling mount, do not use adhesives to prevent the screws from loosening and do not use oils or lubricants and so on.
- When mounting the projector on the ceiling, be sure to arrange measures to prevent it from falling such as passing a wire through the handles.

Attention

- Do not use the projector upside down.
- Set the Direction properly in the configuration menu according to the angle of installation.  [p.57](#)
- Using the projector at an improper angle or setting the configuration menu incorrectly causes malfunctions and shortens the operating life of optical parts.

- Suspend the projector from the ceiling and project images from in front of a screen.

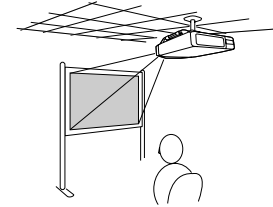

- Suspend the projector from the ceiling and project images from behind a translucent screen.

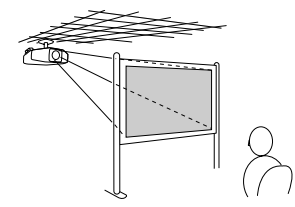

- Project images from in front of a screen.

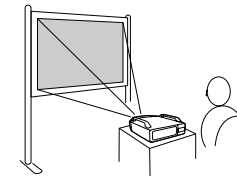

- Project images from behind a translucent screen.

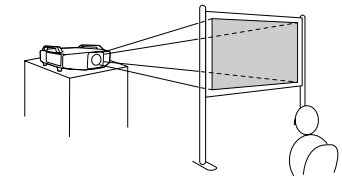

- Project images directly up

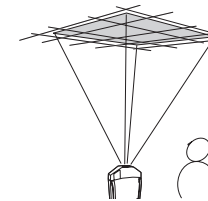

- Project images directly down

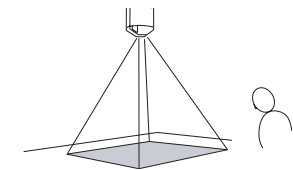

- Project images at angle

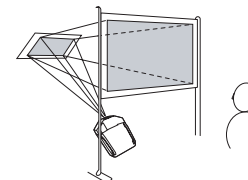



- An optional ceiling mount is required when suspending the projector from a ceiling.
☛ "Optional Accessories and Consumables" p.170
- The Projection setting can be changed from the configuration menu.
☛ p.57

When installing the projector, keep enough distance from the wall to the projector's air exhaust and intake vent.

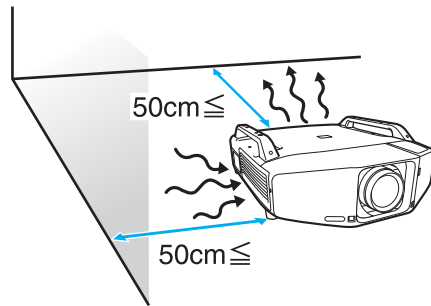

Observe the following precautions when connecting the projector to external equipment. Be sure to also read the documentation for the external equipment.

Attention

- Turn off the projector and the external equipment. The projector or external equipment may fail if they are connected while the power is on.
- Check the shapes of the cable connector and port before connecting them. If connecting them is attempted in the wrong direction or when they do not match, failure or equipment damage may occur.

Remove the interface cover before connecting external equipment. 🖱️ "Attaching and Removing the Interface Cover" p.166

Connecting to a Computer

This section provides examples of connecting the projector to a computer. The computer port and cable names may also be different from those given.





Refer to the following when projecting images from a computer that is connected through a network.

Projecting with the EasyMP Network Projection application software (provided with the projector) 🖱️ [EasyMP Network Projection Operation Guide](#)

Projecting with the EasyMP Multi PC Projection application software (provided with the projector) 🖱️ [EasyMP Multi PC Projection Operation Guide](#)

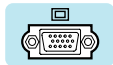
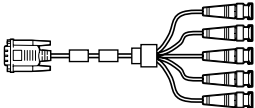
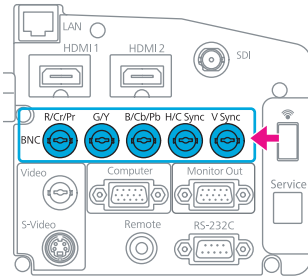
Projecting with the "Connect to a Network Projector" function provided with Windows Vista or Windows 7 🖱️ p.124

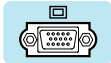
	Computer port	Connecting cable	Projector port
Connection 1	Monitor Out port 	5BNC display cable (commercially available) 	BNC input port 

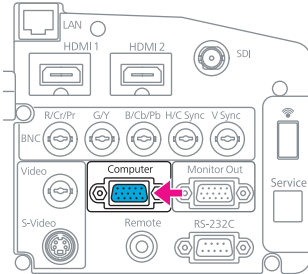
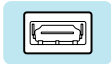
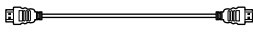
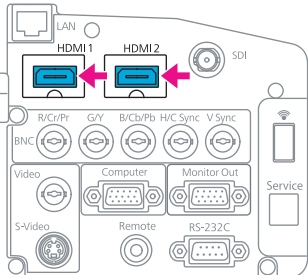
	Computer port	Connecting cable	Projector port
Connection 2	Monitor Out port 	Computer cable (supplied) 	Computer input port 
Connection 3	HDMI output 	HDMI cable (commercially available) 	HDMI1/2 input port 



Use a cable that complies with the HDMI standard for the HDMI cable.

Changing the video output from a laptop computer.

When projecting images from a laptop computer connected to the projector with a computer cable, the output for the video signal must be changed at the computer. Refer to the documentation for your computer for the method to change the video output.





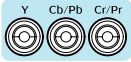
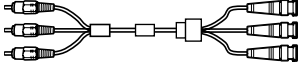
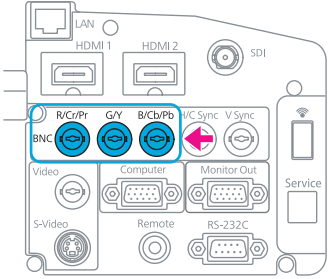
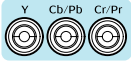
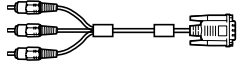
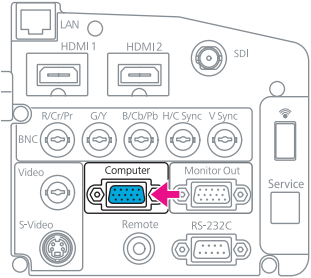

- **Example of changing the output (Windows computers)**

Hold down the [Fn] key on your computer and press the function key labeled CRT/LCD, , and so on. If the image is not displayed on your computer monitor, press the same keys again.

Connecting to Video Equipment

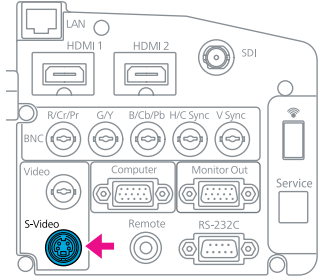
This section provides examples of connecting the projector to video equipment. The video equipment port and cable names may also be different from those given.

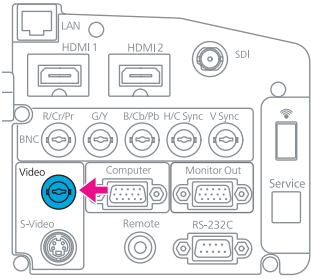
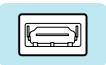
	Port on the video equipment	Connecting cable	Projector port
Connection 1	Component outputs 	RCA component video cable (commercially available) + BNC/RCA adapter (commercially available) 	BNC input port (R/Cr/Pr, G/Y, B/Cb/Pb) 
Connection 2	Component outputs 	Component cable (D-sub/component conversion) (optional accessory) 	Computer input port 

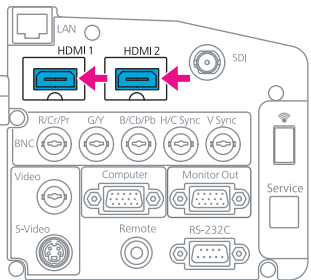
	Port on the video equipment	Connecting cable	Projector port
Connection 3	<p>S-Video output</p> 	<p>S-Video cable (commercially available)</p> 	<p>S-Video input port</p> 
Connection 4	<p>Video output</p> 	<p>BNC video cable (commercially available)</p> 	<p>Video input port</p> 
Connection 5	<p>HDMI output</p> 	<p>HDMI cable (commercially available)</p> 	<p>HDMI1/2 input port</p> 

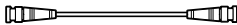
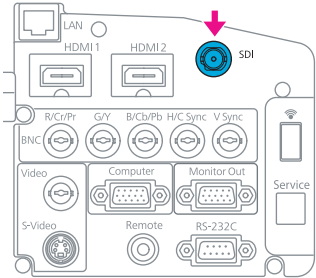
	Port on the video equipment	Connecting cable	Projector port
Connection 6 *	SDI output 	BNC video cable (commercially available) 	SDI input port 

* EB-Z8455WU/Z8450WU only



- Set the Input Signal and Video Signal on the Signal menu according to the signal from the connected equipment.  p.53
- Use a cable that complies with the HDMI standard for the HDMI cable.

Displaying a Test Pattern

A test pattern can be displayed to adjust the projection status without connecting video equipment. This is useful when installing a projector.



If the [User] button on the remote control is set to **Test Pattern**, the test pattern will be displayed when the [User] button is pressed. (The default setting is Test Pattern.)

Procedure

- 1 During projection, press the [Menu] button. Select Settings - "Test Pattern", then press the [Enter] button.

Using the Remote Control

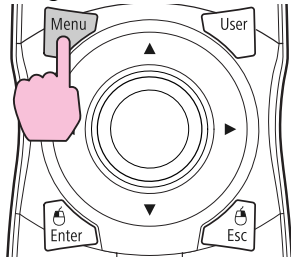

Using the Control Panel

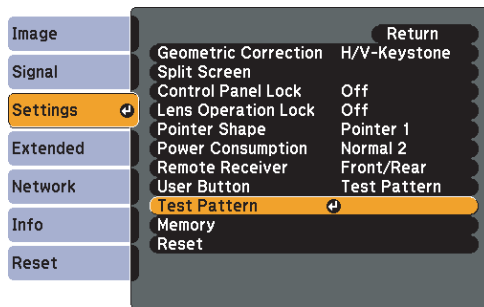
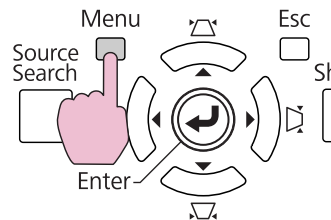

- 2 Press the [Enter] button on the remote control in the [→] direction or press the [Enter] button on the control panel to switch the test pattern.

To display the previous image, press the [Enter] button on the remote control in the [←] direction.

Using the Remote Control

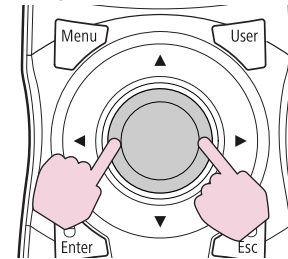

Using the Control Panel

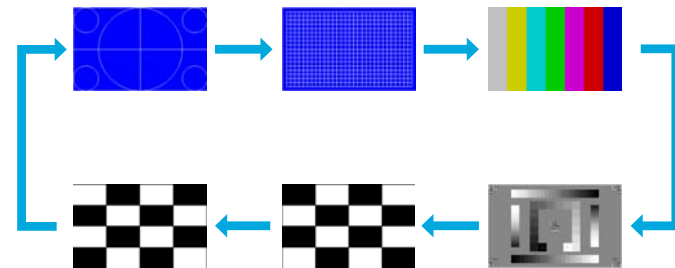
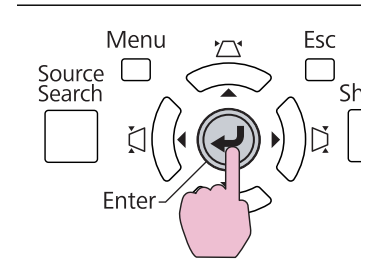

The following adjustments can be made while the test pattern is being displayed.

Top Menu	Sub Menu/Items
Image menu	Color Mode p.28
	Abs. Color Temp.
Advanced	- Gamma*1 p.146
	- RGB
	- RGBCMY p.146
	Auto Iris

Top Menu	Sub Menu/Items
	Reset
Signal menu	Auto Setup
Settings menu	Geometric Correction p.139
Extended menu	Multi-Projection - Brightness Level*2 - Edge Blending p.155 - Multi-screen p.157

*1 Except for custom settings of gamma

*2 EB-Z8455WU/Z8450WU/Z8355W/Z8350W/Z10005/Z10000 only



To set menu items that cannot be set while the test pattern is being displayed or to fine-tune the projected image, project an image from the connected device.

3

Press the [Esc] button to end the test pattern.

Adjusting the Position of the Projected Image (Lens Shift)

The lens can be shifted to adjust the position of the projected image, for example, when the projector cannot be installed directly in front of the screen.

Procedure

1

Press the [Lens Shift] button on the Remote Control. When using the control panel of the projector, press the [Lens] button three times.

Using the Remote Control

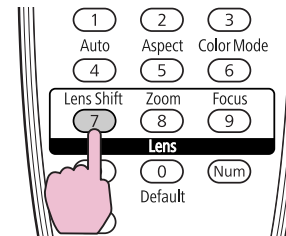

Using the Control Panel

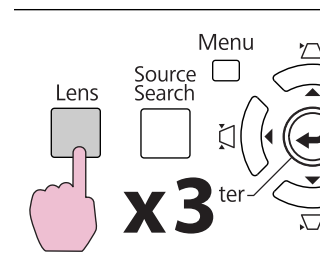

2

To adjust the position of the projected image, use the [◊] button on the remote control or the [△/▲], [▽/▼], [◀/◂], and [▶/▸] buttons on the control panel.

Using the Remote Control

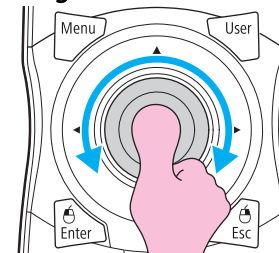

Using the Control Panel

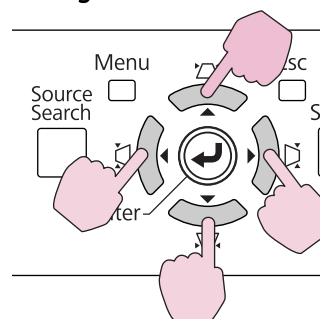

Keep pressing the button to move the image continuously.

When the position of the lens shift comes to the center of the vertical or horizontal direction, it stops moving. Release your finger and press the button again to adjust more.



The image will be clearest when both the vertical and horizontal lens shift are set in the center.

The ranges within which the image can be moved are shown below.

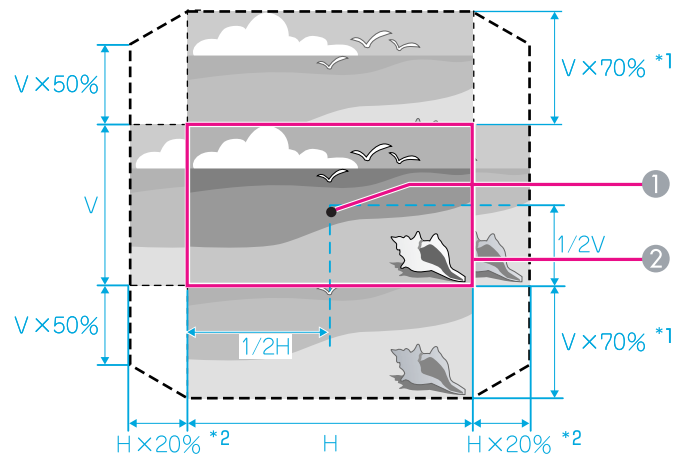

*1 EB-Z10005/Z10000/Z8150: $V \times 56\%$

*2 EB-Z10005/Z10000/Z8150: $H \times 6\%$

- ① Center of lens
- ② Projected image when lens shift is set in the center

The position of the projected image cannot be moved to the both horizontal and vertical maximum value.

Example: When the image is moved to the maximum value horizontally, that can be moved up to 50% vertically. When the image is moved to the maximum value vertically, the image cannot be moved horizontally.

Adjusting the Tilt of the Projected Image

When setting up on a desk, adjust the horizontal tilt of the projector with its front and rear feet.

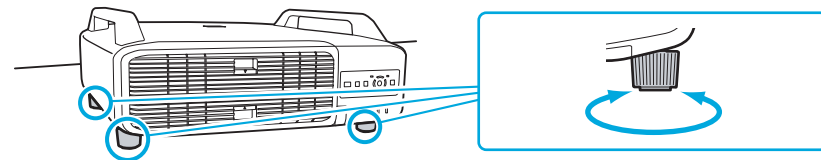

Correcting Distortion in the Projected Image

There are four methods of correcting distortion in projected images as below.

- Quick Corner
This allows you to manually correct each of the four corners of the projected image separately. 🖱️ "Quick Corner" [p.140](#)
We recommend using Quick Corner to accurately adjust keystone distortion.
- H/V-Keystone
This allows you to manually correct distortion in the horizontal and vertical directions independently. You can perform easy H/V-Keystone corrections by using the [↔/↕] [↔/↕] [↔/↕] and [↔/↕] buttons on the projector's control panel. 🖱️ "H/V-Keystone" [p.142](#)

- Arc Correction
Fine adjustment of the curved distortion caused by slack or shrinkage of the screen. 🖱️ "Arc Correction" p.143
- Point Correction
Corrects slight distortion which occurs partially, or adjusts the screen position in an overlapping area when projecting from multiple projectors. 🖱️ "Point Correction" p.153

Quick Corner, H/V-Keystone, Arc Correction, and Point Correction cannot be performed at the same time. Select the correction method from **Geometric Correction** in the configuration menu. The default setting for **Geometric Correction** is set to **H/V-Keystone**, so when [↔/▲], [↔/▼], [↵/◀], and [↵/▶] buttons are pressed, H/V-Keystone correction is carried out.

Because Quick Corner, H/V-Keystone, Arc Correction, and Point Correction can be carried out while projecting a test pattern, you do not need to make preparations by connecting a computer or other equipment.

Quick Corner

Procedure

- 1 During projection, press the [Menu] button. Select Settings menu - "Geometric Correction" and then press the [Enter] button. 🖱️ "Using the Configuration Menu" p.47

Using the Remote Control

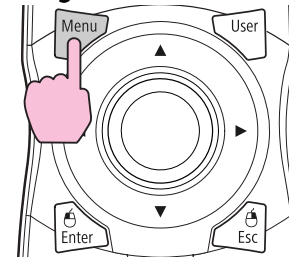

Using the Control Panel

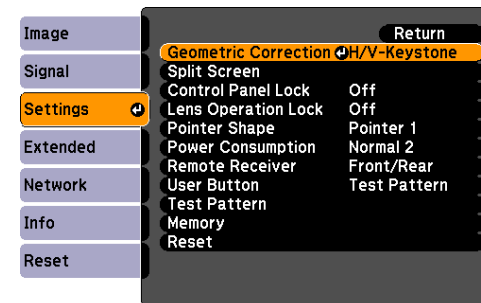
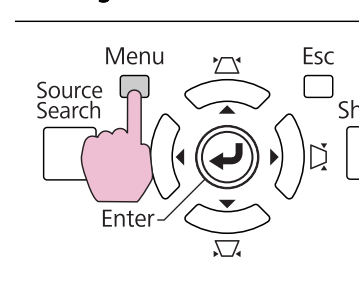

- 2 Select "Quick Corner", and then press the [Enter] button.
Press the [Enter] button again to display the selection screen from which you can select one of the four corners.

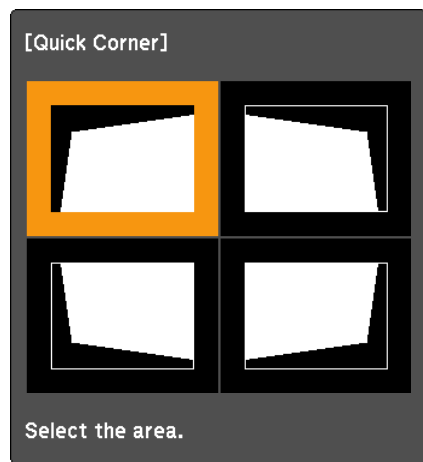

[◀/▶]: Select
[Enter]: Enter
[Esc]: Return (press for 2 seconds to reset)

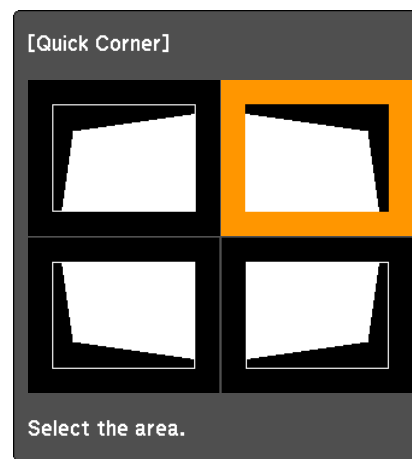

4

To adjust the shape, use the [⊙] button on the remote control or the [△/▲], [▽/▼], [◀/◂], and [▶/▸] buttons on the control panel.

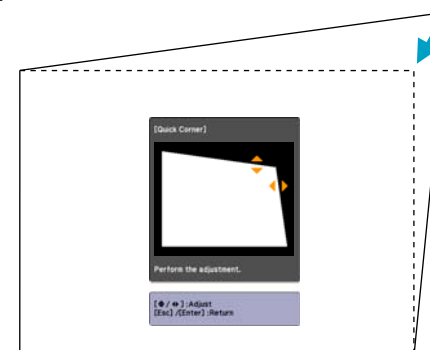

3

Use the [⊙] button on the remote control or the [△/▲], [▽/▼], [◀/◂], and [▶/▸] buttons on the control panel to select the corner you want to adjust, and then press the [Enter] button.

If the triangle in the direction you are adjusting the shape turns gray, as shown in the screenshot below, you cannot adjust the shape any further in that direction.

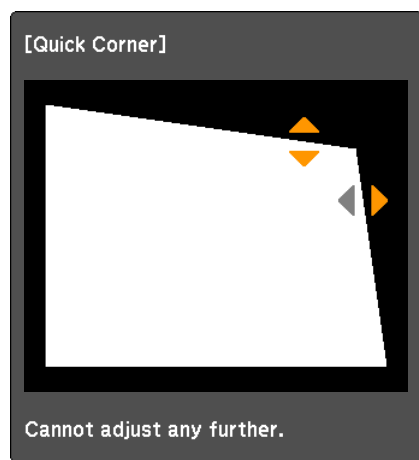

5 Repeat procedures 3 and 4 as needed to adjust any remaining corners.

6 When you are done, press the [Esc] button to exit the correction menu.

Because the correction method was changed to **Quick Corner** from **Geometric Correction** in the configuration menu, when [↖/▲], [↘/▼], [↙/◀], and [↗/▶] buttons are pressed later, the screen for selecting the corner in procedure 2 is displayed. Change **Geometric Correction** from the configuration menu to **H/V-Keystone** if you want to correct H/V-Keystone when pressing the [↖/▲], [↘/▼], [↙/◀], and [↗/▶] buttons on the control panel. [p.55](#)

 If the [Esc] button is held down for about two seconds while correcting with Quick Corner, the confirm default reset screen is displayed. Select "Yes" to reset the result of Quick Corner corrections.

H/V-Keystone

Procedure

Press the [↖/▲], [↘/▼], [↙/◀], and [↗/▶] buttons on the control panel to adjust keystone settings in the horizontal and vertical directions independently.

 This adjustment can also be made from **Geometric Correction - H/V-Keystone** on the **Settings** menu. [p.55](#)

- Correcting vertical keystone
Vertical keystone can be corrected to a vertical projector tilt of up to 30° against the screen.

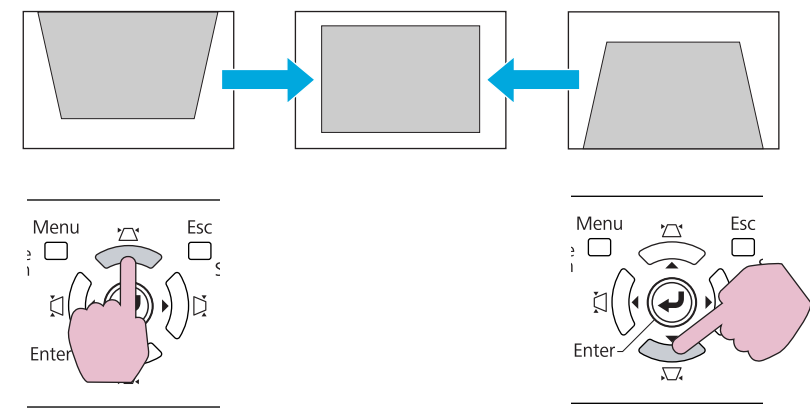

If the [↖/▲] and [↘/▼] buttons are pressed simultaneously for at least 1 second, the value of horizontal keystone will return to the original status.

- Correcting horizontal keystone
Horizontal keystone can be corrected to a horizontal projector tilt of up to 20° against the screen.

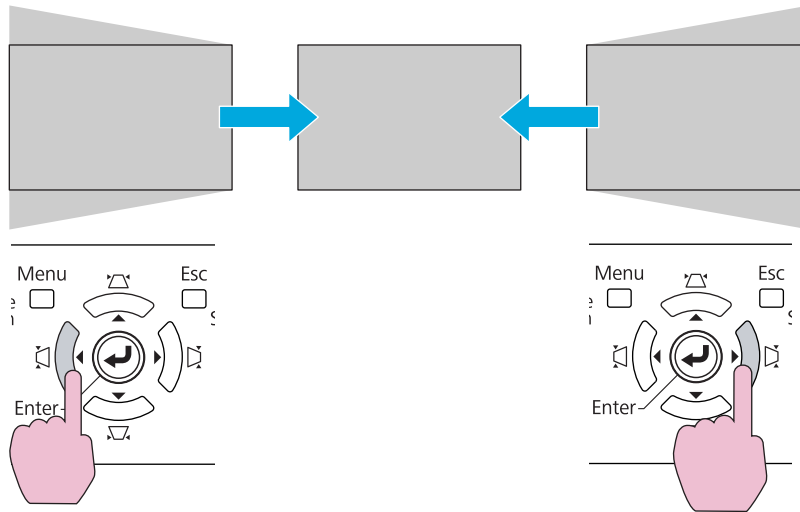

If the [←/→] and [↶/↷] buttons are pressed simultaneously for at least 1 second, the value of horizontal keystone will return to the original status.



Shift the lens to the position shown below when performing horizontal and vertical keystone. When the lens shift is not positioned as below, the distortion is not corrected accurately. 🖱️ "Adjusting the Position of the Projected Image (Lens Shift)" [p.138](#)

- The horizontal lens shift is set to the center.
- The vertical lens shift is set to the top or bottom.

The correction may not be properly performed according to the zoom adjustment value. And, the projected screen size may become smaller after performing the correction. Be careful about the projection distance when installing the projector.

Correct the image using Quick Corner to precisely align the projected image with the screen or to fine-tune the image. 🖱️ "Quick Corner" [p.140](#)

Arc Correction

Procedure



During projection, press the [Menu] button. Select Settings menu - "Geometric Correction" and then press the [Enter] button. 🖱️ "Using the Configuration Menu" [p.47](#)

Using the Remote Control

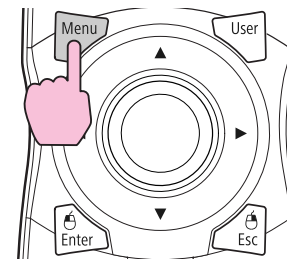

Using the Control Panel

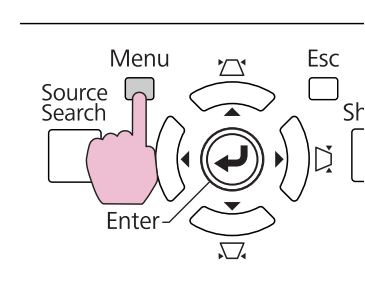

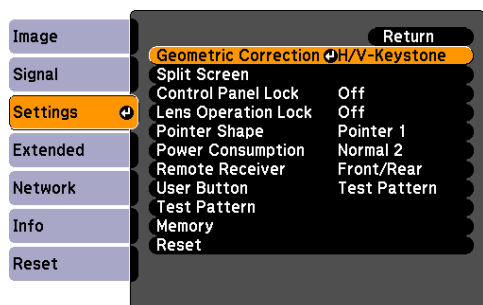

2 Select "Arc Correction" and press the [Enter] button.

Press the [Enter] button again, and the screen below appears, to select one of the 8 vertical/horizontal areas and corners.



[←/→]: Select
 [Enter] : Enter
 [Esc] : Return (press for 2 seconds to reset)

3 Use the [⊙] button on the remote control or the [△/▲], [▽/▼], [←/◀], and [→/▶] buttons on the control panel to select the area you want to adjust, and then press the [Enter] button.

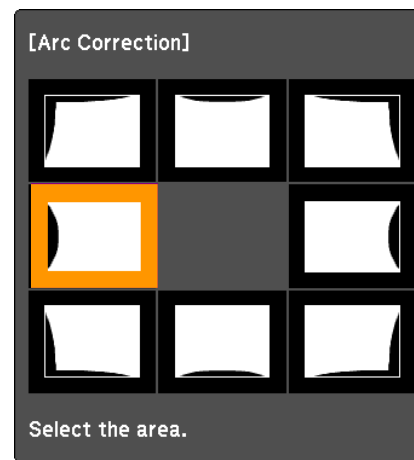

When selecting a corner, you can adjust the two sides next to the corner.

4 To adjust the shape, use the [⊙] button on the remote control or the [△/▲], [▽/▼], [←/◀], and [→/▶] buttons on the control panel.

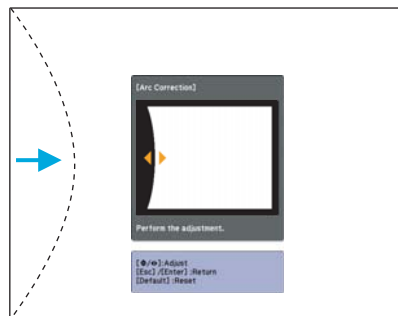

If the triangle in the direction you are adjusting the shape turns gray, as shown in the screenshot below, you cannot adjust the shape any further in that direction.



If you press the [Default] button while adjusting, the value that you are adjusting is reset to the default.

5

Press the [Esc] button to return to the previous screen.

6

Repeat procedures from 3 to 5 as needed to adjust any remaining parts.

7

When you are done, press the [Esc] button to exit the correction menu.



If the [Esc] button is held down for about two seconds while correcting with Arc Correction, the following screen is displayed.

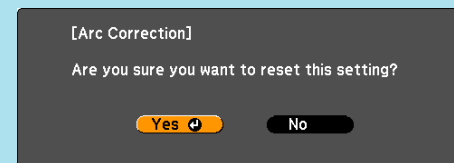

Select "Yes" to reset the result of Arc Correction.

Hue, Saturation, and Brightness Adjustment

The Hue, Saturation, and Brightness for each of the R (red), G (green), B (blue), C (cyan), M (magenta) and Y (yellow) color components can be adjusted.

The menu is displayed in the following order.
Image menu - Advanced - RGBCMY

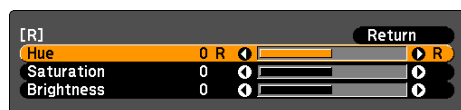

Hue	Adjusts the overall hue of the image, bluish – greenish – reddish.
Saturation	Adjusts the overall vividness of the image.
Brightness	Adjusts the overall color brightness of the image.



If you press the [Default] button while adjusting, the value that you are adjusting is reset to the default.

Gamma Adjustment

Adjust the coloring that is occurred depending on the equipment during displaying the image.

There are three methods of setting as below, which can be selected in the configuration menu.

Setting Method	Menu Settings
Select and adjust the correction value	Image - Advanced - Gamma

Setting Method	Menu Settings
Adjust while viewing the image	Image - Advanced - Gamma - Customized - Adjust it from the image
Adjust using the gamma adjustment graph	Image - Advanced - Gamma - Customized - Adjust it from the graph

Select and adjust the correction value

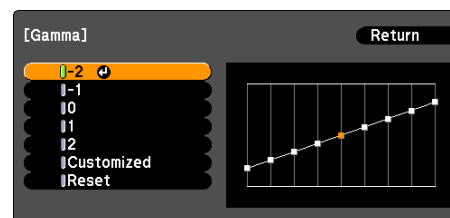

When a smaller value is selected, the dark areas of images become brighter, but the lighter areas may become oversaturated. When a larger value is selected, you can reduce the overall brightness of the image to make the image sharper.



The gamma graph's horizontal axis represents the input signal level and its vertical axis represents the output signal level.

When **Color Mode** is set to **DICOM SIM** from the Image menu, select the correction value according to your screen size, referring the size of a 150 inch screen.

If your screen is smaller than 150 inch, select a large value. If your screen is larger than 150 inch, select a small value.



Medical images may not be reproduced correctly according to your settings and screen specifications.

Adjust while viewing the image

Move the cursor on the projected image to the part where you want to change the brightness, and adjust the value.

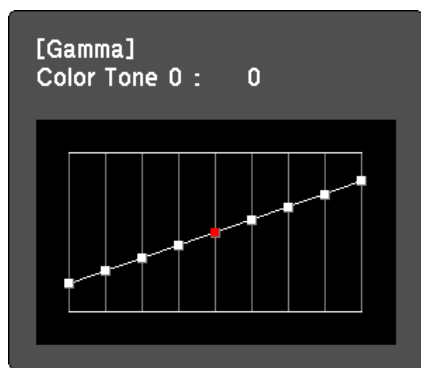
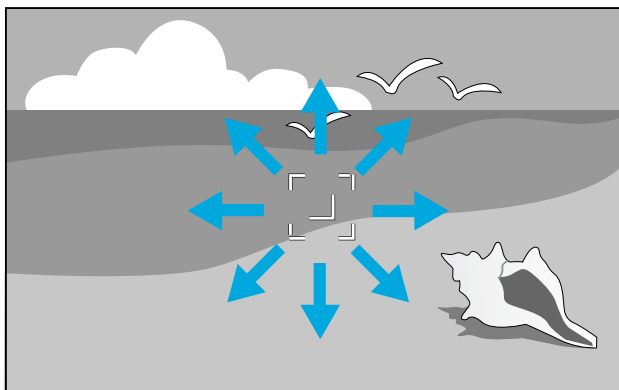

If you press the [Default] button while adjusting, the value that you are adjusting is reset to the default.

Adjust using the gamma adjustment graph

Adjust while looking at the gamma adjustment graph.

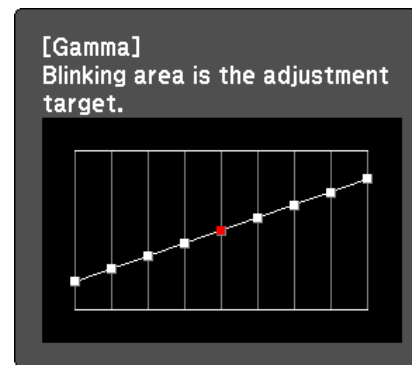

If you press the [Default] button while adjusting, the value that you are adjusting is reset to the default.

Frame Interpolation (EB-Z8455WU/Z8450WU only)

The current and previous frames are used to create intermediate frames, interpolating to produce smooth-moving images. You can resolve clumsy-moving images, such as frame skipping when projecting a fast moving image.

The menu is displayed in the following order.

Signal Menu - Frame Interpolation

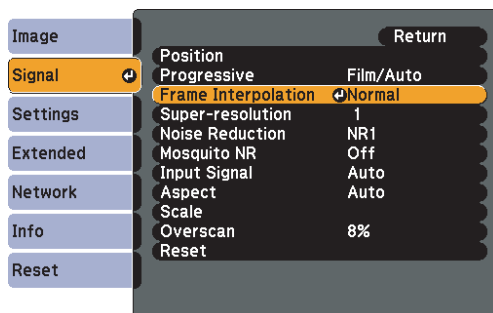

You can select the level of interpolation: **Low**, **Normal** or **High**. Set to **Off** if noise occurs after setting them.

Super-resolution

To display a crisp image, you can reduce the blurring that is created on the edge when the image data is scaled up to fit the panel resolution of the image signal.

The menu is displayed in the following order.
Signal Menu - Super-resolution

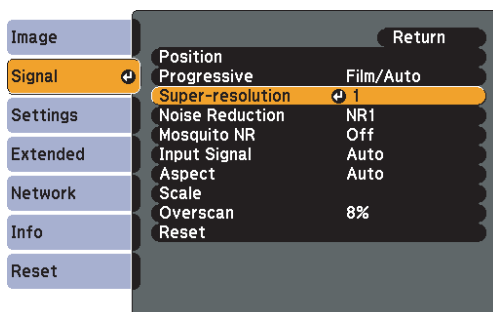

Depending on the image, distortion at the edge of the image may be enhanced. If you notice any distortion, set it to "0".



If you press the [Default] button while adjusting, the value that you are adjusting is reset to the default.

Noise Reduction

There are two kinds of noise reduction functions:

- Noise Reduction
- Mosquito NR

Noise Reduction

You can make settings related to Noise Reduction (reduce flickering of images).

The menu is displayed in the following order.
Signal Menu - Noise Reduction

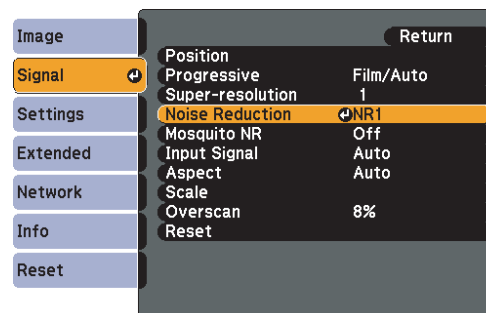

It is recommended that this is set to **Off** when viewing image sources in which noise is very low, such as for DVDs.

Mosquito NR

You can reduce the way noise that occurs in lines between areas with dramatic changes in colors.

The menu is displayed in the following order.
Signal Menu - Mosquito NR

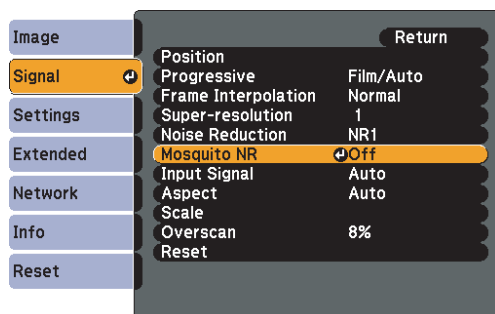

When projecting to a wide screen from multiple projectors, you can adjust the difference of brightness and color tone between each projected image to create a seamless screen.

There are two general methods of projecting from multiple projectors.

- Ⓐ Projecting different images from each projector, and creating a seamless screen

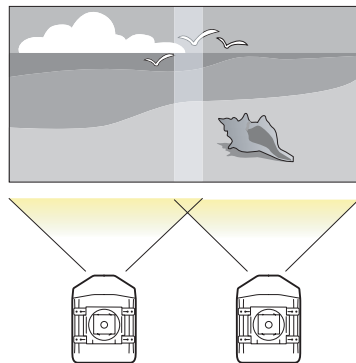

- Ⓑ Projecting the same image from each projector, using the Scale function to project a large image

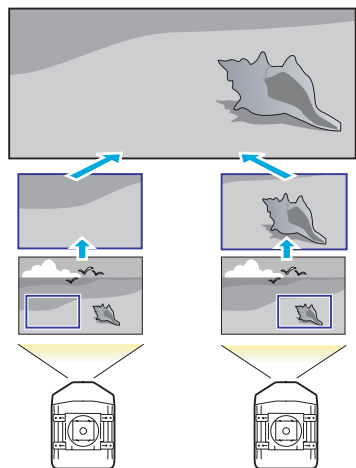

Preparation Flow

Here is an example of using Ⓐ. (The basic flow is the same with Ⓑ method, but use the scale function to adjust the position of the projected image  p.157)

1. Setting the projector ID and the remote control ID
2. Adjusting the position of the projected image
3. Checking the Color Mode
4. Using the edge blending function
5. Adjusting to match colors

Settings are explained here using the remote control, but they can also be set by the control panel.

Projector ID/Remote Control ID

When an ID is set for the projector and the remote control, you can use the remote control to operate only the projector with a matching ID. This is very useful when managing multiple projectors.

When operating all of the projectors from the remote control, set the ID switch on the side of the remote control to Off.



- Operation using the remote control is possible only for projectors that are within the operating range of the remote control.
 - "Operating range of remote control" p.18
- When **Remote Control Type** is set to **Simple** from **Operation** in the configuration menu, you cannot set the remote control ID.
 - p.57
- IDs are ignored when the projector ID is set to **Off** or the remote control ID is set to **0**.

Setting the projector ID

Procedure

- 1 During projection, press the [Menu] button and select Extended - "Multi-Projection" from the configuration menu.
 ➔ "Using the Configuration Menu" p.47

Remote Control

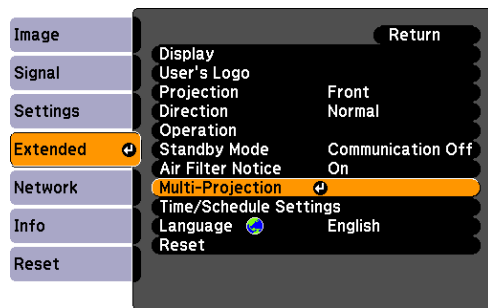
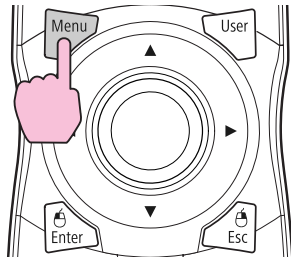

- 2 Select "Projector ID", and then press the [Enter] button.

- 3 Select one of the numbers from 1 to 9 to use as the ID and then press the [Enter] button.

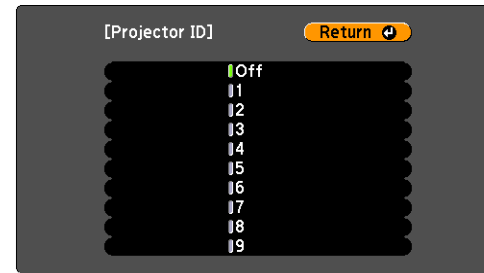

- 4 Press the [Menu] button to close the configuration menu.

Checking the Projector ID

Use the following procedure to check the projector ID.

Procedure

- 1 Set the remote control ID switch to On.

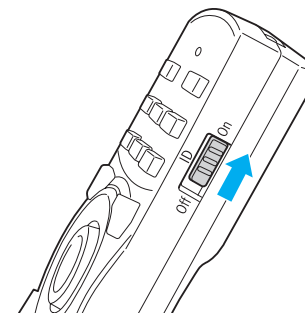

- 2 During projection, while holding the [ID] button, press the [Help] button.

Remote Control

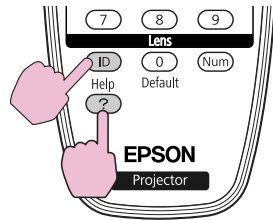

When you press the buttons, the current Projector ID is displayed on the projection screen. It disappears in about three seconds.

Setting the remote control ID

Procedure

- 1 Set the remote control ID switch to On.

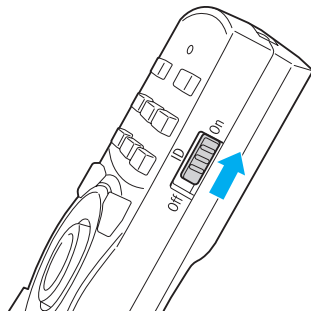

- 2 While holding the [ID] button, press a number button to select a number to match the ID of the projector you want to operate. ➔ "Checking the Projector ID" p.151

Remote Control

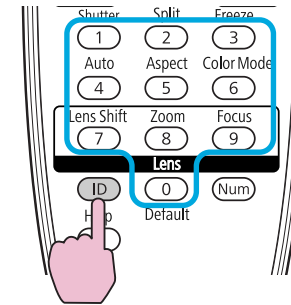

Once this setting has been made, the projector that can be operated by the remote control is limited.



The remote control ID setting is saved in the remote control. Even if the remote control batteries are removed to replace them and so on, the stored ID setting is retained. However, if the batteries are left out for a long time, it is reset to the default value (ID0).

Adjusting the Position of the Projected Image

Adjust the position of the projected image, starting from the adjustments that have larger corrections.

1. Projector's position (angle) ➔ p.130
2. Lens shift/Zoom ➔ p.138
3. Geometric Correction
 - Quick Corner ➔ p.140
 - Point Correction ➔ p.153



- We recommend setting the focus, zoom, and lens shift at least 30 minutes after you start the projection, because images are not stable right after turning on the projector.
- The Test Pattern can be displayed to adjust the projection status without connecting video equipment.  [p.137](#)
- When projecting from multiple projectors, the correction is easier if you use the image in dot by dot format, that can be displayed without being enlarged or reduced.

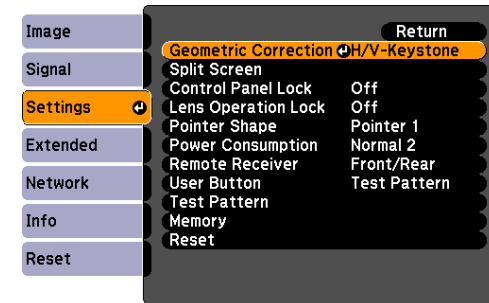

Point Correction

Corrects slight distortion which occurs partially, or adjusts the screen position in an overlapping area when projecting from multiple projectors.

Divides the projected image by the grid and corrects the distortion by moving the point of intersection from side to side and up and down.

Procedure

- 1 **During projection, press the [Menu] button. Select Settings menu - "Geometric Correction" and then press the [Enter] button.**  ["Using the Configuration Menu" p.47](#)

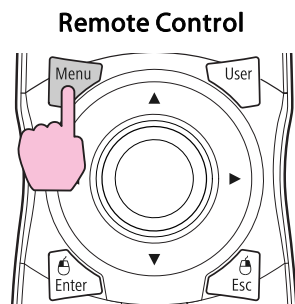

- 2 **Select "Point Correction", and then press the [Enter] button.**
- 3 **Select "Grid Size", and then press the [Enter] button.**
- 4 **Select one of "3x3", "5x5", or "9x9", and then press the [Enter] button.**
- 5 **Press the [Esc] button to return to the previous screen.**
- 6 **Select "Start Adjustments", and then press the [Enter] button.**
According to the value selected in Grid Size, the point selection screen is displayed on the projected image.



You can change the color of the guide on **Pattern Color**.

- 7** Move the [⊙] button to the point you want to correct, then press the [Enter] button.

Remote Control

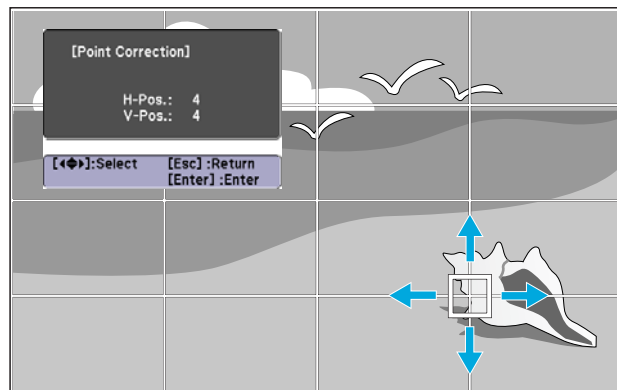
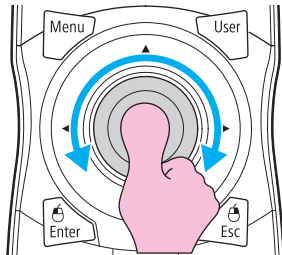

If the [Esc] button is held down for about two seconds while selecting the point, the confirm default reset screen is displayed. Select "Yes" to reset the result of Point Correction.

- 8** Press the [⊙] button to correct the distortion.

Remote Control

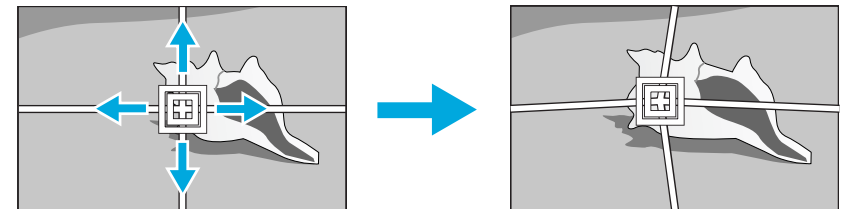
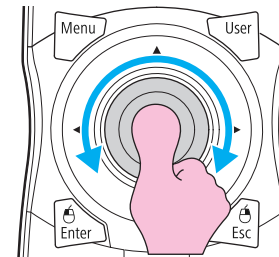

To continue to correct another point, press the [Esc] button to return to the previous screen, then repeat the step 7 and 8.



If you press the [Default] button while adjusting, the value that you are adjusting is reset to the default.

- 9** When you are done, press the [Esc] button to exit the correction menu.

Checking the Color Mode

Set the Color Mode to **Multi-Projection**.  p.28

Using the Edge Blending Function

When multiple projectors are lined up and projecting images, you can create a seamless screen.

Make the following settings on the Edge Blending menu, to correct the image.

Sub Menu	Function
Edge Blending	Set to On to activate the edge blending function. Set to Off when not projecting from multiple projectors.
Top Edge/Bottom Edge/ Right Edge/Left Edge	Blending: Set to On to activate the edge blending function towards where you are setting, and the blend range will be shaded. Blend Range: Adjusts the range to be shaded. Adjustment is possible at the level of one pixel. The maximum range is 45% of resolution.
Blend Curve	You can select from three ways of shading.
Black Level	When projecting a dark image, correct the part that is not overlapped to resolve the brightness of overlapped part. Brightness Correct.: Adjust the brightness of the range that is not shaded. Color Correct. (G/R): Adjust the color tone of the range that is not shaded to greenish and reddish. Color Correct. (B/Y): Adjust the color tone of the range that is not shaded to bluish and yellowish.
Guide Display	Set to On to display the guide on the edge blending setting range.
Guide Colors	You can select the combination of guide colors from the three.

Procedure

- 1 Press the [Menu] button and select Extended menu - "Multi-Projection" from the configuration menu. ☞ "Using the Configuration Menu" p.47

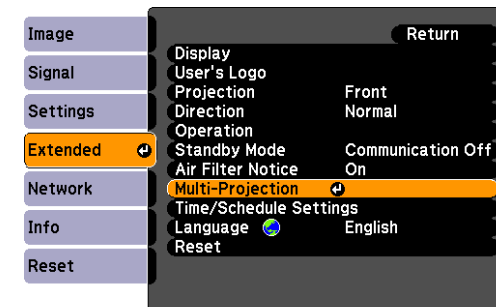
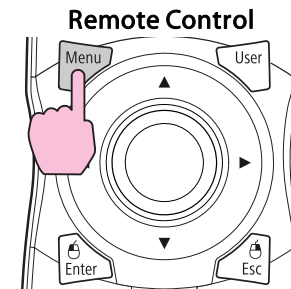

- 2 Select "Edge Blending", and then press the [Enter] button.
- 3 Turn on "Edge Blending".
 - (1) Select **Edge Blending**, and then press the [Enter] button.
 - (2) Select **On**, and then press the [Enter] button.
 - (3) Press the [Esc] button.

4 Displays the guide.

- (1) Select the **Guide Display**, and then press the [Enter] button.
- (2) Select **On**, and then press the [Enter] button.
- (3) Press the [Esc] button.



If the guide is not clear, you can change the color of the guide on **Guide Colors**.

5 Set "Top Edge/Bottom Edge/Right Edge/Left Edge".

- (1) Select **Top Edge/Bottom Edge/Right Edge/Left Edge** to set the edge blending, and then press the [Enter] button.
- (2) Select **Blending**, and then press the [Enter] button.
- (3) Select **On**, and then press the [Enter] button.
- (4) Press the [Esc] button.

- (5) In **Blend Range**, adjust the range to be shaded.
The value for when the overlapped range and the guide are in the same position is the best.

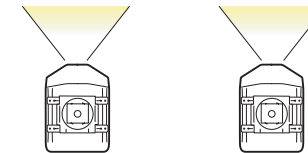
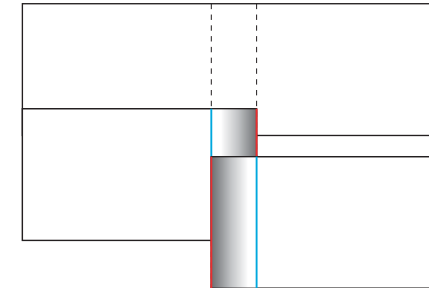

If you press the [Default] button while adjusting Blend Range, the value that you are adjusting is reset to the default.

- (6) Press the [Esc] button.

6 Set "Blend Curve".

- (1) Select **Blend Curve**, and then press the [Enter] button.
- (2) Select the way of shading from 1 to 3, and then press the [Enter] button.
- (3) Press the [Esc] button.

7 Adjust the black level.

- (1) Select **Black Level**, and then press the [Enter] button.
- (2) In **Brightness Correct.**, adjust the level to correct.
- (3) In **Color Correct. (G/R)**, adjust the level to correct.
- (4) In **Color Correct. (B/Y)**, adjust the level to correct.

(5) Press the [Esc] button.



If you press the [Default] button while adjusting Brightness Correct., Color Correct. (G/R), or Color Correct. (B/Y), the item that you are selecting is reset to the default.

Adjusting to Match Colors on Multi-Projection

When multiple projectors are lined up and projecting images, you can manually correct the brightness and color tone of each projector's image so that the colors projected from each projector match closely.

In some cases the brightness and color tone may not match completely even after correction.

Make the following settings on the Multi-Projection menu to correct the image.

Sub Menu	Function
Brightness Level	Adjust when the brightness of each projector is different.
Multi-screen	<p>Adjustment Level: Change the adjustment level of the projected image.</p> <p>Brightness Correct.: Adjust from black to white for each color tone.</p> <p>Color Correct. (G/R): Adjust the color tone to greenish and reddish.</p> <p>Color Correct. (B/Y): Adjust the color tone to bluish and yellowish.</p>



If the overlapping part of dark images is annoying, adjust the Black Level again.

Displays the Image Partly Enlarged (Scale)

Procedure

1

During projection, press the [Menu] button. Select Signal menu - "Scale" and then press the [Enter] button. ➔ "Using the Configuration Menu" p.47

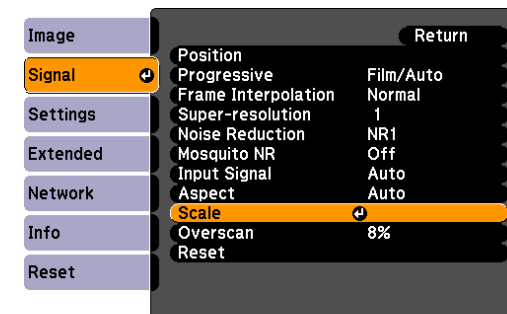
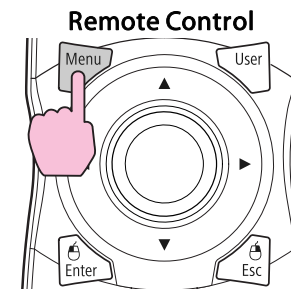

2

Select "Scale", and then select "On".

3

Select "Scale Mode", and then select the scale.

Full Display	When the image is not resized, it is projected the same as projected by Normal aspect mode.
--------------	---

Zoom Display	The image is displayed at the range that is selected on the aspect mode.  p.22
---------------------	---

4 Select **"Scale Vertically"**, **"Scale Horizontally"**, or **"scale vertically and horizontally at the same time"**, and then adjust the scale.

5 Set **"Image Display Range"**.

Adjust the scale while watching the screen, because clipping coordinates position and clipping size are different according to screens to be matched, such as matching top and bottom screens or left and right screens.

You can schedule turning the projector power on/off and switching the input source, as events in the schedule. Registered events are executed automatically at the specified time on the specified dates or weekly.

Setting Methods

You can make settings from the computer by using the Web Remote function. p.109

Procedure

- 1 Press the [Menu] button, and select **Extended - "Time/Schedule Settings"** from the configuration menu. "Using the Configuration Menu" p.47

Using the Remote Control

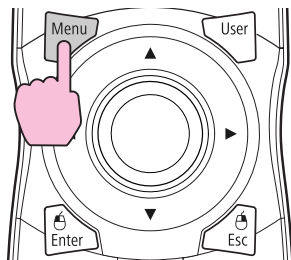

Using the Control Panel

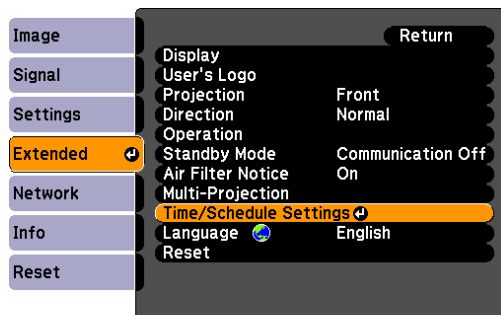
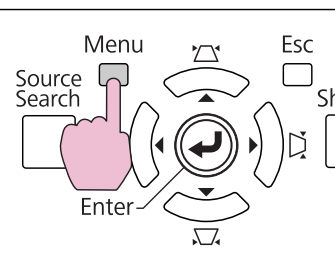

- 2 **Set the time and schedule.**

Selecting from the top menu and sub menus, and changing of selected items are the same as operations in the configuration menu.

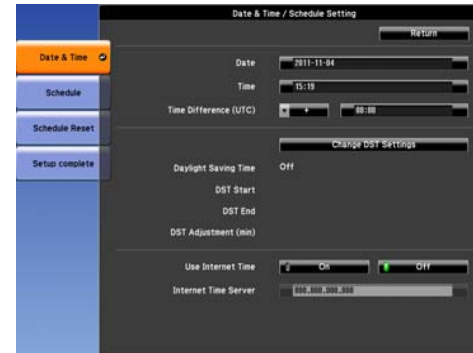

To delete all registered schedules, select **Schedule Reset**, then select **Yes**.

- 3 **Select the Setup complete menu, and then select "Yes".**

You can return to the configuration menu.

Clock

Sub Menu	Function
Date	Set today's date in the projector.
Time	Set the current time in the projector.
Time Difference (UTC)	Set the time difference from Coordinated Universal Time.
Change DST Settings	Displays the screen to set the daylight saving time.
Use Internet Time	Set to On to update the time automatically through an Internet time server.

Sub Menu	Function
Internet Time Server	Input the IP address for an Internet time server.

Daylight Saving Time screen

Sub Menu	Function
Daylight Saving Time	Set whether or not (On/Off) to activate the daylight saving time.
DST Start	Set the date and time to start the daylight saving time.
DST End	Set the date and time to end the daylight saving time.
DST Adjustment (min)	Adjusts the time difference between the standard time and the daylight saving time.

Schedule

You can display the list of registered schedules.

When you select **Edit** on a registered schedule or **New Event**, the Clock / Schedule Setting screen is displayed.

You can register up to 30 events.

Clock / Schedule Setting screen

Sub Menu	Function
Event Settings	Select an operation of the projector when the event is executed.
Date / Time Settings	Set the date and time to execute the event.

Connecting a LAN Cable

Connect with a commercially available 100BASE-TX or 10BASE-T LAN cable.

Connected equipment	Connecting cable	Projector port
LAN port on network hub	LAN cable (commercially available)	LAN port 

Attention

To prevent malfunctions, use a category 5 shielded LAN cable.



- Only analog RGB signals from a computer connected to the Computer input port or the BNC input port can be displayed on an external monitor. Images from equipment connected to other ports and component video signals cannot be displayed.
- The image cannot be displayed on the external monitor when the projector is on standby.
- Setting gauges such as Keystone, the configuration menu, or Help screens are not output to the external monitor.

Connecting to an External Monitor

You can display computer images input from a computer on an external monitor connected to the projector and the screen at the same time. This means that you can check projected images on an external monitor when giving presentations even if you cannot see the screen. Connect using the cable supplied with the external monitor.

Connected equipment	Connecting cable	Projector port
Monitor	Cable supplied with monitor	Monitor Out port 

Prepare #2 plus-driver in advance.

Removing and Attaching the Projector Lens Unit

Removing

Attention

- Only remove the lens unit when necessary. If dust or dirt enter the projector, projection quality deteriorates and it could cause a malfunction.
- Try not to touch the lens section with your hand or fingers. If fingerprints or oils are left on the surface of the lens, projection quality deteriorates.
- If the lens shift has been done, set the lens shift to the center before replacing the lens unit. [p.138](#)

Procedure

- 1 Remove the interface cover.

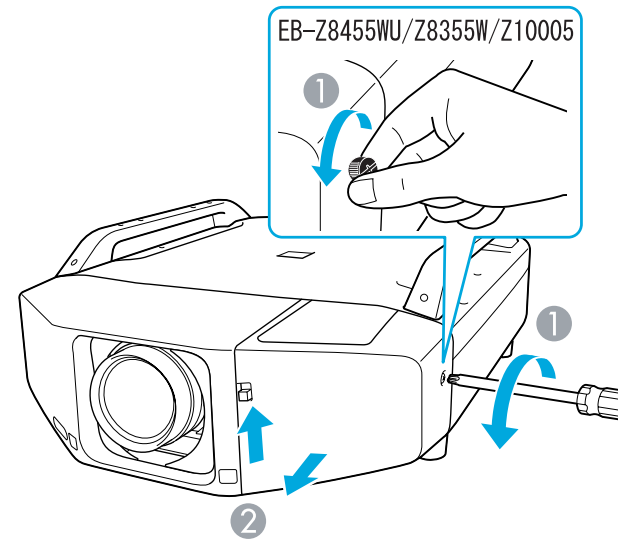

- 1 Loosen the fixing screw.
- 2 While pulling up the interface cover open switch, pull the interface cover straight out.

- 2 Remove the front cover.

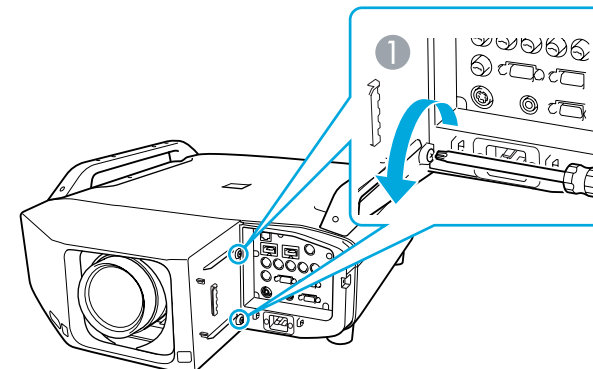

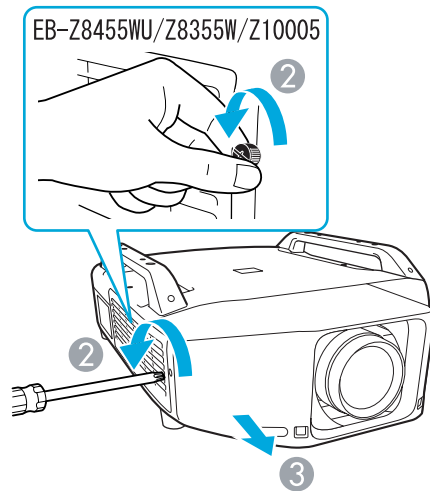

- ① Loosen the two fixing screws.
- ② Loosen the fixing screw.
- ③ Pull the cover straight out.

③ Pinch the lock lever of the lens unit and turn it counterclockwise.

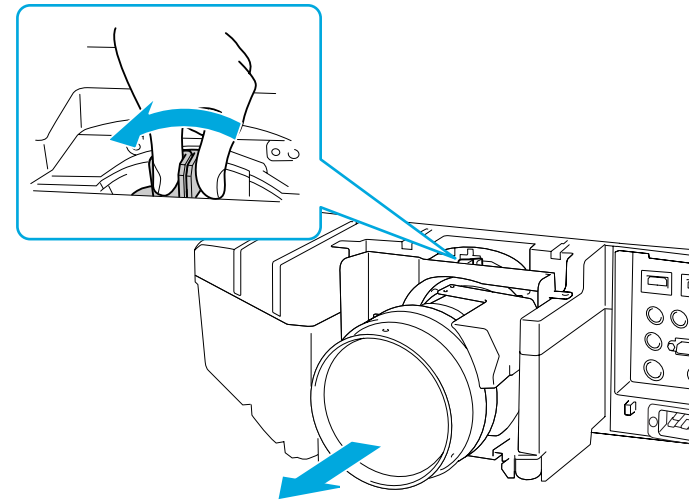

④ Pull the lens unit straight out as it is released.

Attaching

Attention

Do not attach the lens unit when the projector's lens insertion section is facing up. Dust or dirt could enter the projector.

Procedure

① Insert the lens unit straight into the lens insertion section with the white circle on the lens on top.

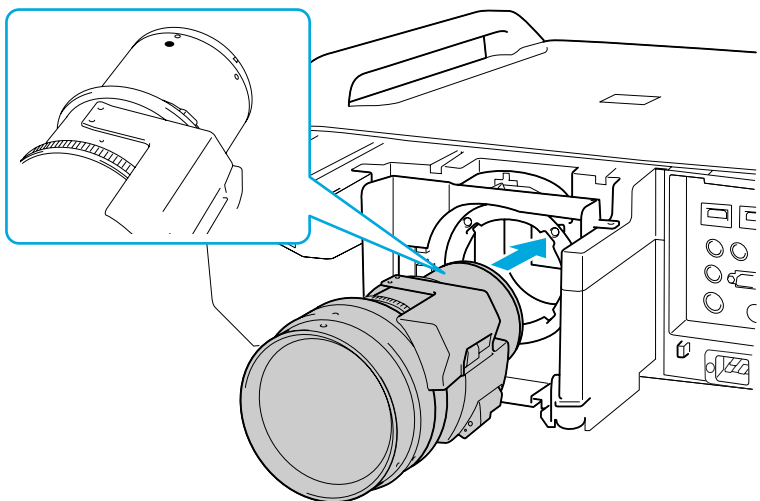

2 While holding the lens unit firmly, turn the lock lever clockwise until it is locked. Check that the lens cannot be detached.

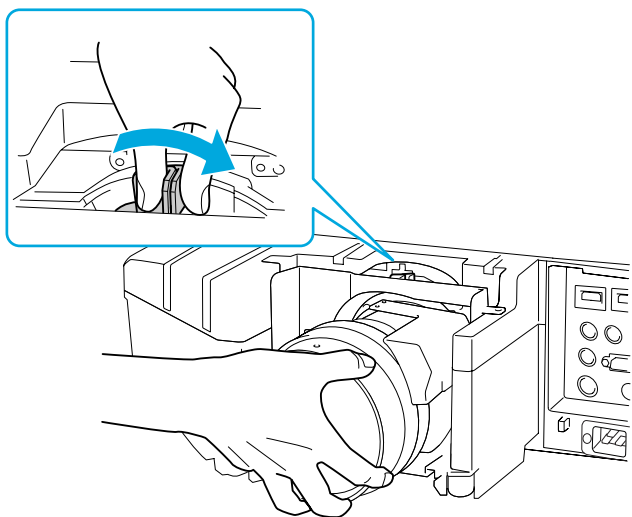

3 Replace the front cover.

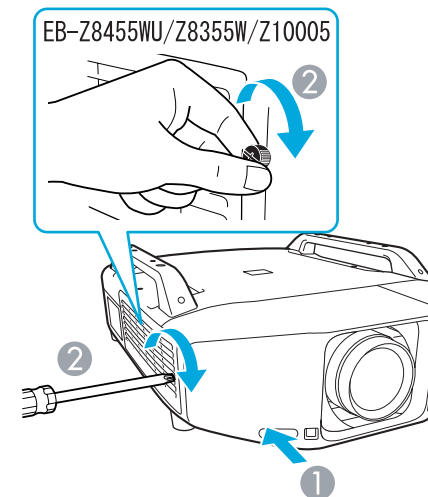

- ① Install the cover along the guide.
- ② Tighten the fixing screw.
- ③ Tighten the two fixing screws.

4 Replace the interface cover.

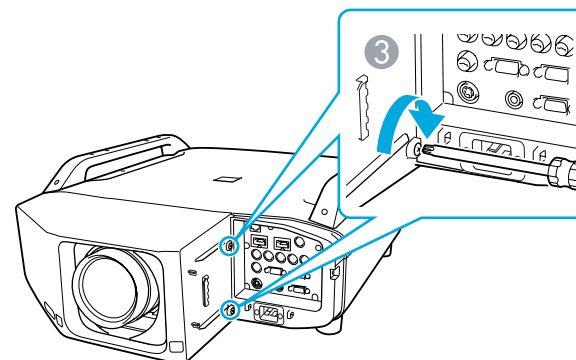

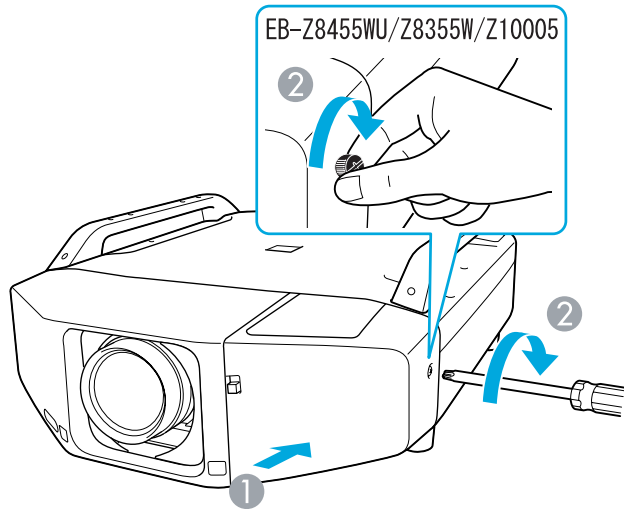

- ① Install the cover along the guide.
- ② Tighten the fixing screw.

Attention

- Install the front cover to use the projector.
- Store the projector with the lens unit installed.
If the projector is stored without the lens unit, dust and dirt may get inside the projector and cause malfunctions or lower the quality of projection.

Installing the Wireless LAN Unit (ELPAP07)

Attaching

Procedure

- ① Remove the interface cover.

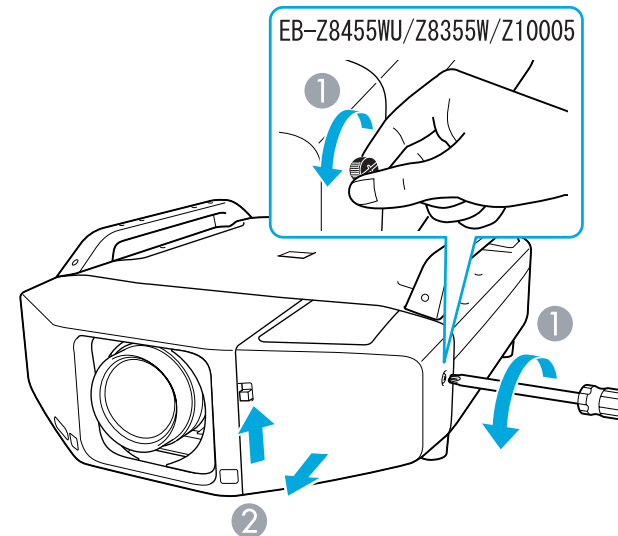

- ① Loosen the fixing screw.
- ② While pulling up the interface cover open switch, pull the interface cover straight out.

- ② Install the Wireless LAN unit.

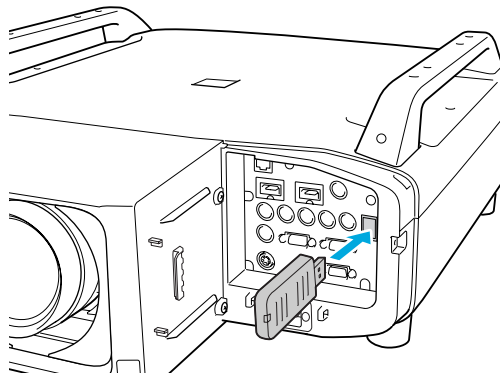

When connecting a projector to which the Wireless LAN unit is mounted to a computer using a wireless LAN, set the **Wireless LAN Power** setting on the **Wireless LAN** menu to **On**. (The default setting is **On**.)



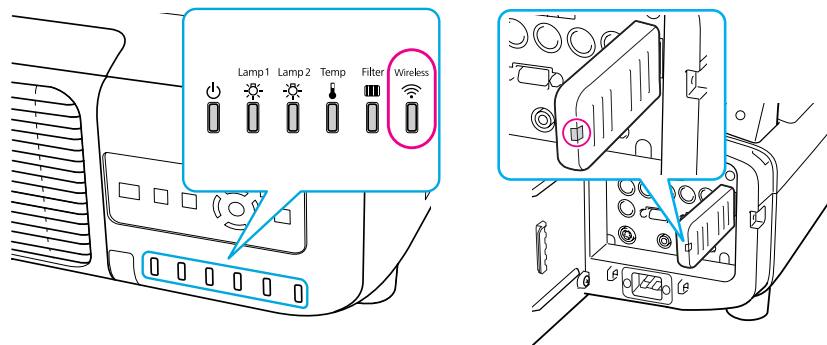

 [p.63](#)

Reading the wireless LAN indicators

There are two wireless LAN indicators, one on the projector and one on the Wireless LAN unit.



 : Flashing  : Lit  : Off

Status	Indicator on projector	Indicator on Wireless LAN unit
The Wireless LAN unit not mounted or the Wireless LAN Power setting on the Wireless LAN menu is Off	<input type="checkbox"/>	<input type="checkbox"/>
The Wireless LAN unit mounted to the projector but not connected to the network		
The Wireless LAN unit mounted to the projector and connected to the network		
The Wireless LAN unit mounted to the projector, connected to the network, and communicating		

Attaching and Removing the Interface Cover

Removing

Procedure

-  Loosen the fixing screw.

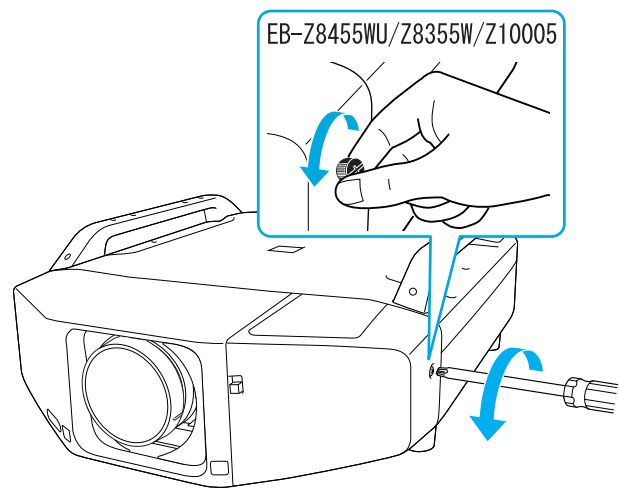

2 While pulling up the interface cover open switch, pull the interface cover straight out.

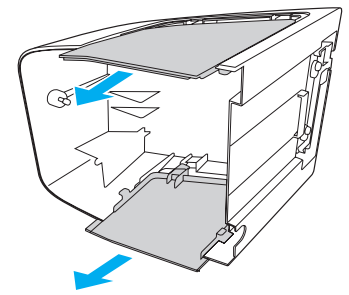
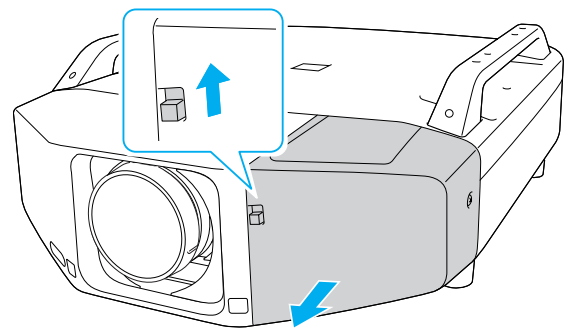

2 Install the cover along the guide.

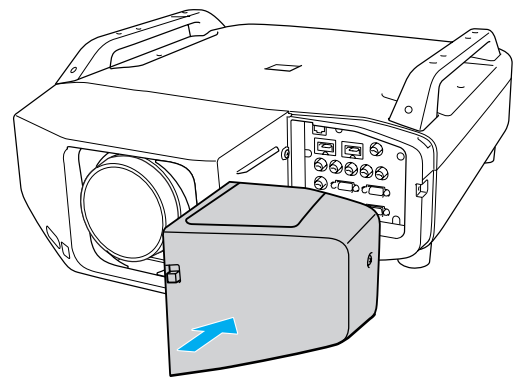

3 Tighten the fixing screw.

Attaching

Procedure

1 Remove the top cover when ejecting the connected cables upward. Remove the bottom cover when ejecting the connected cables downward.

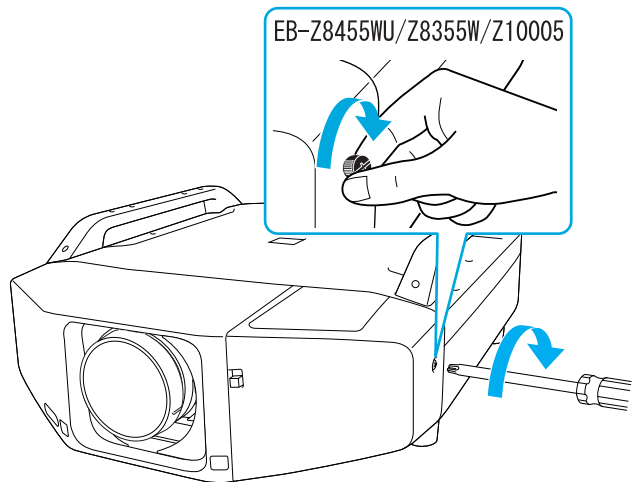

2 Attach the supplied foot covers.

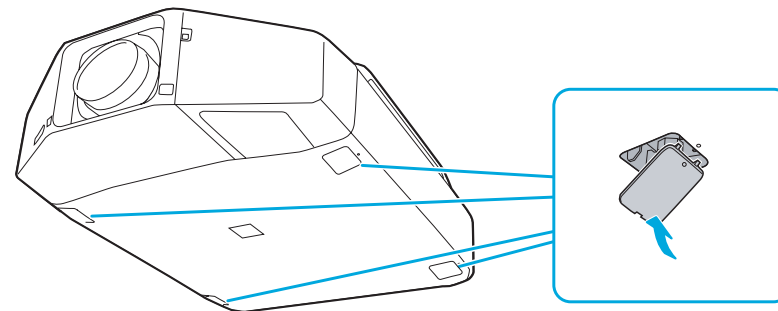

Removing the Feet

When mounting the projector on the ceiling, you can remove the feet and attach the supplied foot covers for clean appearance.

Procedure

1 Remove the feet.

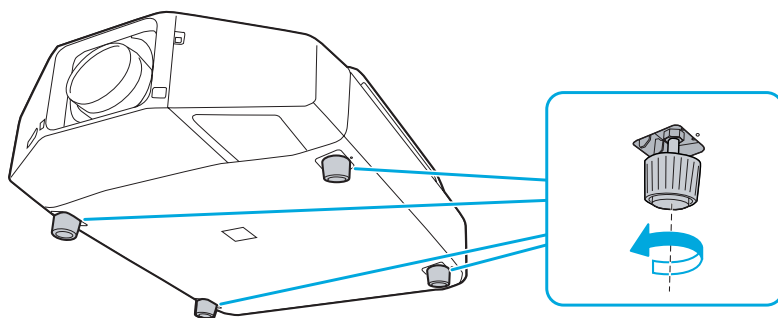



Appendix

The following optional accessories and consumables are available. Please purchase these products as and when needed. The following list of optional accessories and consumables is current as of: 2012.1. Details of accessories are subject to change without notice and availability may vary depending on the country of purchase.

Optional Accessories

Computer cable ELPKC02

(1.8 m - for mini D-Sub15-pin/mini D-Sub 15pin)

This is the same as the computer cable supplied with the projector.

Computer cable ELPKC09

(3 m - for mini D-Sub15-pin/mini D-Sub 15pin)

Computer cable ELPKC10

(20 m - for mini D-Sub15-pin/mini D-Sub 15pin)

Use one of these longer cables if the computer cable supplied with the projector is too short.

Component video cable ELPKC19

(3 m - for mini D-Sub 15-pin/RCA male×3)

Use to connect a [Component Video](#) source.

Remote control cable set ELPKC28

(10m 2 piece set)

Use this to guarantee operation from the remote control from a distance.

Wireless mouse receiver ELPST16

Use this to use the projector's remote control to control the mouse pointer on the computer or to page up and down.

Wireless LAN unit ELPAP07

Use this to project images from a computer via a wireless LAN.

Low ceiling mount* ELPMB25

High ceiling mount* ELPMB26

Use when installing the projector on a ceiling.

- * A special method of installation is required to suspend the projector from a ceiling. Contact your dealer or the nearest address provided in the Support and Service Guide if you want to use this installation method.  [Epson Projector Contact List](#)

Consumables

Replacement lamp unit (two-pack) ELPLP73

Replacement lamp unit (one-pack) ELPLP72

Use as a replacement for used lamps.

Air filter ELPAF23

Use as a replacement for used air filters.

The following table shows the projection distance when a standard lens is attached. When an optional lens is attached, check the projection distances using the ELPLL07/ELPLM07/ELPLM06/ELPLS04/ELPLW04/ELPLR04 User's Guide supplied with this projector. To find the appropriate screen size, see the following table to set up the projector. Values are just reference.

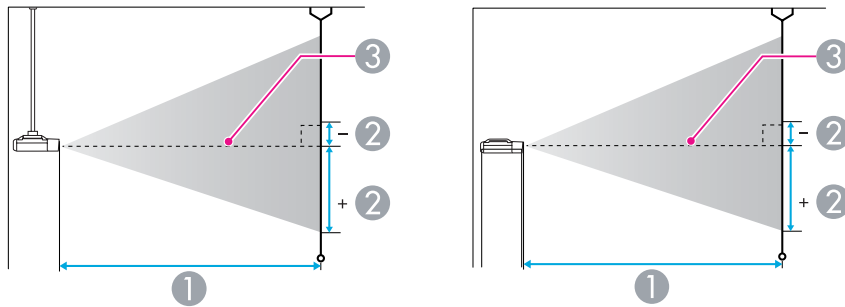

- ① Projection distance
- ② is the distance from the center of the lens to the base of the screen. This changes depending on the setting for vertical lens shift.
- ③ Center of lens

Projection Distance of EB-Z8455WU/Z8450WU

Units: cm

4:3 Screen Size		①	②
		Minimum (Wide) to Maximum (Tele)	Vertical lens shift Top to Bottom
53"	108x81	221 - 361	-17 - +98
70"	142x107	294 - 479	-23 - +129
80"	163x122	338 - 549	-26 - +148
90"	183x137	381 - 619	-29 - +166
100"	203x152	424 - 688	-32 - +185

4:3 Screen Size		①	②
		Minimum (Wide) to Maximum (Tele)	Vertical lens shift Top to Bottom
110"	224x168	467 - 758	-35 - +203
120"	244x183	510 - 828	-39 - +221
150"	305x229	640 - 1036	-48 - +277
200"	406x305	856 - 1384	-64 - +369
300"	610x457	1288 - 2081	-97 - +554
441"	896x672	1898 - 3062	-142 - +814

Units: cm

16:9 Screen Size		①	②
		Minimum (Wide) to Maximum (Tele)	Vertical lens shift Top to Bottom
59"	131x73	223 - 365	-21 - +95
70"	155x87	267 - 434	-25 - +112
80"	177x100	306 - 498	-29 - +129
90"	199x112	345 - 561	-33 - +145
100"	221x125	384 - 624	-36 - +161
110"	244x137	423 - 687	-40 - +177
120"	266x149	463 - 751	-43 - +193
150"	332x187	580 - 940	-54 - +241
200"	443x249	777 - 1256	-72 - +321
300"	664x374	1169 - 1888	-108 - +482
486"	1076x605	1899 - 3064	-176 - +781



Units: cm

16:10 Screen Size		①	②
		Minimum (Wide) to Maximum (Tele)	Vertical lens shift Top to Bottom
60"	130x81	221 - 361	-17 - +98
70"	151x94	259 - 423	-20 - +114
80"	172x108	297 - 484	-23 - +130
90"	194x121	335 - 546	-26 - +147
100"	215x135	374 - 607	-28 - +163
110"	237x148	412 - 669	-31 - +179
120"	258x162	450 - 730	-34 - +196
200"	431x269	755 - 1222	-57 - +326
300"	646x404	1137 - 1837	-85 - +489
500"	1077x673	1900 - 3067	-142 - +815

4:3 Screen Size		①	②
		Minimum (Wide) to Maximum (Tele)	Vertical lens shift Top to Bottom
120"	244x183	502 - 814	-37 - +219
150"	305x229	630 - 1020	-46 - +274
200"	406x305	843 - 1363	-61 - +366
300"	610x457	1268 - 2048	-91 - +549
441"	896x672	1868 - 3014	-134 - +807

Units: cm

16:9 Screen Size		①	②
		Minimum (Wide) to Maximum (Tele)	Vertical lens shift Top to Bottom
59"	131x73	220 - 359	-20 - +94
70"	155x87	262 - 428	-24 - +111
80"	177x100	301 - 490	-28 - +127
90"	199x112	339 - 552	-31 - +143
100"	221x125	378 - 614	-35 - +159
110"	244x137	417 - 676	-38 - +175
120"	266x149	455 - 739	-42 - +191
150"	332x187	571 - 925	-52 - +239
200"	443x249	764 - 1236	-69 - +318
300"	664x374	1150 - 1859	-104 - +477
486"	1076x605	1869 - 3016	-168 - +773

Projection Distance of EB-Z8355W/Z8350W

Units: cm

4:3 Screen Size		①	②
		Minimum (Wide) to Maximum (Tele)	Vertical lens shift Top to Bottom
53"	108x81	217 - 355	-16 - +97
70"	142x107	290 - 472	-21 - +128
80"	163x122	332 - 540	-24 - +146
90"	183x137	375 - 609	-27 - +165
100"	203x152	417 - 677	-30 - +183
110"	224x168	460 - 746	-34 - +201

Units: cm

16:10 Screen Size		①	②
		Minimum (Wide) to Maximum (Tele)	Vertical lens shift Top to Bottom
60"	130x81	217 - 355	-16 - +97
70"	151x94	255 - 416	-19 - +113
80"	172x108	292 - 476	-22 - +129
90"	194x121	330 - 537	-24 - +145
100"	215x135	368 - 597	-27 - +162
110"	237x148	405 - 658	-30 - +178
120"	258x162	443 - 719	-32 - +194
200"	431x269	743 - 1203	-54 - +323
300"	646x404	1119 - 1808	-81 - +485
500"	1077x673	1870 - 3019	-135 - +808

4:3 Screen Size		①	②
		Minimum (Wide) to Maximum (Tele)	Vertical lens shift Top to Bottom
120"	244x183	396 - 646	-10 - +193
200"	406x305	665 - 1082	-17 - +322
300"	610x457	1002 - 1626	-25 - +483
500"	1016x762	1676 - 2716	-42 - +804

Units: cm

16:9 Screen Size		①	②
		Minimum (Wide) to Maximum (Tele)	Vertical lens shift Top to Bottom
56"	124x70	197 - 324	-17 - +87
70"	155x87	249 - 407	-21 - +108
80"	177x100	285 - 467	-24 - +124
90"	199x112	322 - 526	-27 - +139
100"	221x125	359 - 586	-30 - +155
110"	244x137	395 - 645	-33 - +170
120"	266x149	432 - 704	-36 - +185
150"	332x187	542 - 882	-45 - +232
200"	443x249	726 - 1179	-60 - +309
300"	664x374	1093 - 1773	-90 - +464
458"	1014x570	1672 - 2711	-137 - +708

Projection Distance of EB-Z10005/Z10000/Z8150

Units: cm

4:3 Screen Size		①	②
		Minimum (Wide) to Maximum (Tele)	Vertical lens shift Top to Bottom
60"	122x91	194 - 319	-5 - +97
70"	142x107	228 - 373	-6 - +113
80"	163x122	261 - 428	-7 - +129
90"	183x137	295 - 482	-8 - +145
100"	203x152	329 - 537	-8 - +161
110"	224x168	362 - 591	-9 - +177

Units: cm

16:10 Screen Size		①	②
		Minimum (Wide) to Maximum (Tele)	Vertical lens shift Top to Bottom
57"	123x77	195 - 321	-13 - +90
70"	151x94	242 - 396	-16 - +110
80"	172x108	277 - 454	-18 - +126
90"	194x121	313 - 512	-20 - +141
100"	215x135	349 - 569	-22 - +157
110"	237x148	385 - 627	-25 - +173
120"	258x162	420 - 685	-27 - +188
150"	323x202	527 - 858	-34 - +236
200"	431x269	706 - 1147	-45 - +314
300"	646x404	1063 - 1725	-67 - +471
471"	1014x634	1673 - 2712	-106 - +740

Supported Monitor Displays

Computer signals (analog RGB)

Signal	Refresh Rate (Hz)	Resolution (dots)
VGA	60/72/75/85	640x480
SVGA	56/60/72/75/85	800x600
XGA	60/70/75/85	1024x768
WXGA	60	1280x768
	60	1366x768
	60/75/85	1280x800
WXGA+	60/75/85	1440x900
WSXGA+*1	60	1680x1050
WXGA++	60	1600x900 TBD
SXGA	70/75/85	1152x864
	60/75/85	1280x1024
	60/75/85	1280x960
SXGA+	60/75	1400x1050
UXGA	60	1600x1200
WUXGA*2	60	1920x1200

*1 EB-Z8455WU/Z8450WU/Z8355W/Z8350W only. Only compatible when Wide is selected as the Resolution from the configuration menu.

*2 EB-Z8455WU/Z8450WU only. Only compatible when VESA CVT-RB (Reduced Blanking) signal is input.

Even when signals other than those mentioned above are input, it is likely that the image can be projected. However, not all functions may be supported.

Component Video

Signal	Refresh Rate (Hz)	Resolution (dots)
SDTV(480i)	60	720x480
SDTV(576i)	50	720x576
SDTV(480p)	60	720x480
SDTV(576p)	50	720x576
HDTV(720p)	50/60	1280x720
HDTV(1080i)	50/60	1920x1080
HDTV(1080p)*	50/60	1920x1080

* EB-Z8455WU/Z8450WU only

Composite Video/S-Video

Signal	Refresh Rate (Hz)	Resolution (dots)
TV(NTSC)	60	720x480
TV(PAL,SECAM)	50/60	720x576

Input signals from HDMI1/2 input port

Signal	Refresh Rate (Hz)	Resolution (dots)
VGA	60	640x480
SVGA	60	800x600
XGA	60	1024x768
WXGA	60	1280x800
SXGA	60	1280x960
	60	1280x1024
SXGA+	60	1400x1050
WXGA++	60	1600x900 TBD

Signal	Refresh Rate (Hz)	Resolution (dots)
WXGA	60	1366x768 TBD
WXGA+	60	1440x900 TBD
UXGA	60	1600x1200
WSXGA+*1	60	1680x1050
WUXGA*2	60	1920x1200
SDTV(480i)	60	720x480
SDTV(480p)	60	720x480
SDTV(576i)	50	720x576
SDTV(576p)	50	720x576
HDTV(720p)	50/60	1280x720
HDTV(1080i)	50/60	1920x1080
HDTV(1080p)	24/30/50/60	1920x1080

*1 EB-Z8455WU/Z8450WU/Z8355W/Z8350W only. Only compatible when Wide is selected as the Resolution from the configuration menu.

*2 Only compatible when VESA CVT-RB (Reduced Blanking) signal is input.

Input signals from SDI input port (EB-Z8455WU/Z8450WU only)

Signal	Refresh Rate (Hz)	Resolution (dots)
SDTV(480i)	60	720x480
SDTV(576i)	50	720x576
HDTV(720p)	50/60	1280x720
HDTV(1080i)	50/60	1920x1080
HDTV(1080p)	24/30	1920x1080

Client Certificate (PEAP-TLS/EAP-TLS)

Item	Explanation
Supported format	PKCS#12
Extension	PKCS, P12
Encryption	RSA
Hashes	MD5/SHA-1/SHA-256/SHA-384/SHA-512
Key length	512/1024/2048/4096 bit
Password	Required (up to 32 alphanumeric characters)

Item	Explanation
Common Name	Network host name
Organization	Optional
Password	Required (up to 32 alphanumeric characters)

Server Certificate (PEAP/PEAP-TLS/EAP-TLS/EAP-Fast)

Item	Explanation
Supported format	X509v3
Extension	DER/CER/PEM
Encryption	RSA
Hashes	MD5/SHA-1/SHA-256/SHA-384/SHA-512
Key length	512/1024/2048/4096 bit
Encode	BASE64/Binary

Web Server Certificate (Secure HTTP)

Item	Explanation
Supported format	PKCS#12
Extension	PKCS, P12
Encryption	RSA
Hashes	MD5/SHA-1/SHA-256/SHA-384/SHA-512
Key length	512/1024/2048/4096 bit

Projector General Specifications

Product name		EB-Z8455WU/Z8450WU	EB-Z8355W/Z8350W	EB-Z10005/Z10000	EB-Z8150
Dimensions		534 (W) × 167 (H) × 734 (D) mm (not including raised section)			
Panel size		0.94" Wide	0.95" Wide	1.06"	
Display method		Polysilicon TFT active matrix			
Resolution		2,304,000 pixels WUXGA (1920 (W) × 1200 (H) dots) × 3	1,024,000 pixels WXGA (1280 (W) × 800 (H) dots) × 3	786,432 pixels XGA (1024 (W) × 768 (H) dots) × 3	
Focus adjustment		Automatic			
Zoom adjustment*1		Automatic (1-1.6)			
Lens shift*1		Automatic (Vertical direction: Maximum approx. 70%, Horizontal direction: Maximum approx. 20%)		Automatic (Vertical direction: Maximum approx. 56%, Horizontal direction: Maximum approx. 6%)	
Lamp		UHE lamp, 340 W Two-lamps Model No.: ELPLP73 (Two)/ELPLP72 (One)			
Power supply		100-240V AC ±10%, 50/60 Hz 9.8-4.3A			100-240V AC ±10%, 50/60 Hz 8.3-3.5A
Power consumption	100 to 120 V area	Operating: 968W Standby power consumption (Communication On): 4.3W Standby power consumption (Communication Off): 0.4W			Operating: 822W Standby power consumption (Communication On): 4.3W Standby power consumption (Communication Off): 0.4W
	220 to 240 V area	Operating: 911W Standby power consumption (Communication On): 5.1W Standby power consumption (Communication Off): 0.5W			Operating: 786W Standby power consumption (Communication On): 5.1W Standby power consumption (Communication Off): 0.5W
Operating altitude		Altitude 0 to 3048 m			
Operating temperature		0 to +50°C*2 (No condensation)			
Storage temperature		-10 to +60°C (No condensation)			

Mass*1	Approx. 22 kg
---------------	---------------

*1 The specifications are when a standard lens is attached. When an optional lens is attached, check the User's Guide supplied with the optional lenses.

*2 The operating temperature is 0 to +50°C when Power Consumption is set to Normal 2, and 0 to +45°C when it is set to Normal 1 at an altitude of 0 to 1500m.
The operating temperature is 0 to +45°C when Power Consumption is set to Normal 2, and 0 to +40°C when it is set to Normal 1 at an altitude of 1500 to 3048m.

Product name			EB-Z8455WU/Z8450WU	EB-Z8355W/Z8350W	EB-Z10005/Z10000	EB-Z8150
Connec- tors	Computer Input Port	1	Mini D-Sub15-pin (female) blue			
	BNC input port	1	5BNC (female)			
	Video input port	1	1BNC (female)			
	S-Video input port	1	Mini DIN 4-pin			
	HDMI1 input port	1	HDMI HDCP compatible			
	HDMI2 input port	1	HDMI HDCP compatible			
	SDI input port	1	1BNC (female)	-		
	Monitor Out port	1	Mini D-Sub15-pin (female) black			
	USB port (Only for Wireless LAN unit) *	1	USB connector (Type A)			
	LAN port	1	RJ-45			
	RS-232C port	1	Mini D-Sub 9-pin (male)			
	Remote port	1	Stereo mini jack			

* USB 2.0 is supported. However, the operation of all USB compatible devices is not guaranteed.

This product is also designed for IT power distribution system with phase-to-phase voltage 230V.

Angle of tilt

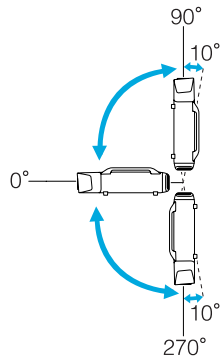

Using the projector at angles not shown in the illustrations above may damage it or cause an accident.

DECLARATION of CONFORMITY

According to 47CFR, Part 2 and 15
Class B Personal Computers and Peripherals; and/or
CPU Boards and Power Supplies used with Class B
Personal Computers

We: Epson America, Inc.
Located at: 3840 Kilroy Airport Way
MS: 3-13
Long Beach, CA 90806
Tel: 562-290-5254

Declare under sole responsibility that the product identified herein, complies with 47CFR Part 2 and 15 of the FCC rules as a Class B digital device. Each product marketed, is identical to the representative unit tested and found to be compliant with the standards. Records maintained continue to reflect the equipment being produced can be expected to be within the variation accepted, due to quantity production and testing on a statistical basis as required by 47CFR 2.909. Operation is subject to the following two conditions : (1) this device may not cause harmful interference, and (2) this device must accept any interference received, including interference that may cause undesired operation.

Trade Name: EPSON
Type of Product: LCD Projector
Model: H458C/H459C/H460C/H462C

**FCC Compliance Statement
For United States Users**

This equipment has been tested and found to comply with the limits for a Class B digital device, pursuant to Part 15 of the FCC Rules. These limits are designed to provide reasonable protection against harmful interference in a residential installation. This equipment generates, uses, and can radiate radio frequency energy and, if not installed and used in accordance with the instructions, may cause harmful interference to radio communications. However, there is no guarantee that interference will not occur in a particular installation. If this equipment does cause harmful interference to radio or television reception, which can be determined by turning the equipment off and on, the user is encouraged to try to correct the interference by one or more of the following measures.

- Reorient or relocate the receiving antenna.
- Increase the separation between the equipment and receiver.
- Connect the equipment into an outlet on a circuit different from that to which the receiver is connected.
- Consult the dealer or an experienced radio/TV technician for help.

WARNING

The connection of a non-shielded equipment interface cable to this equipment will invalidate the FCC Certification or Declaration of this device and may cause interference levels which exceed the limits established by the FCC for this equipment. It is the responsibility of the user to obtain and use a shielded equipment interface cable with this device. If this equipment has more than one interface connector, do not leave cables connected to unused interfaces. Changes or modifications not expressly approved by the manufacturer could void the user's authority to operate the equipment.

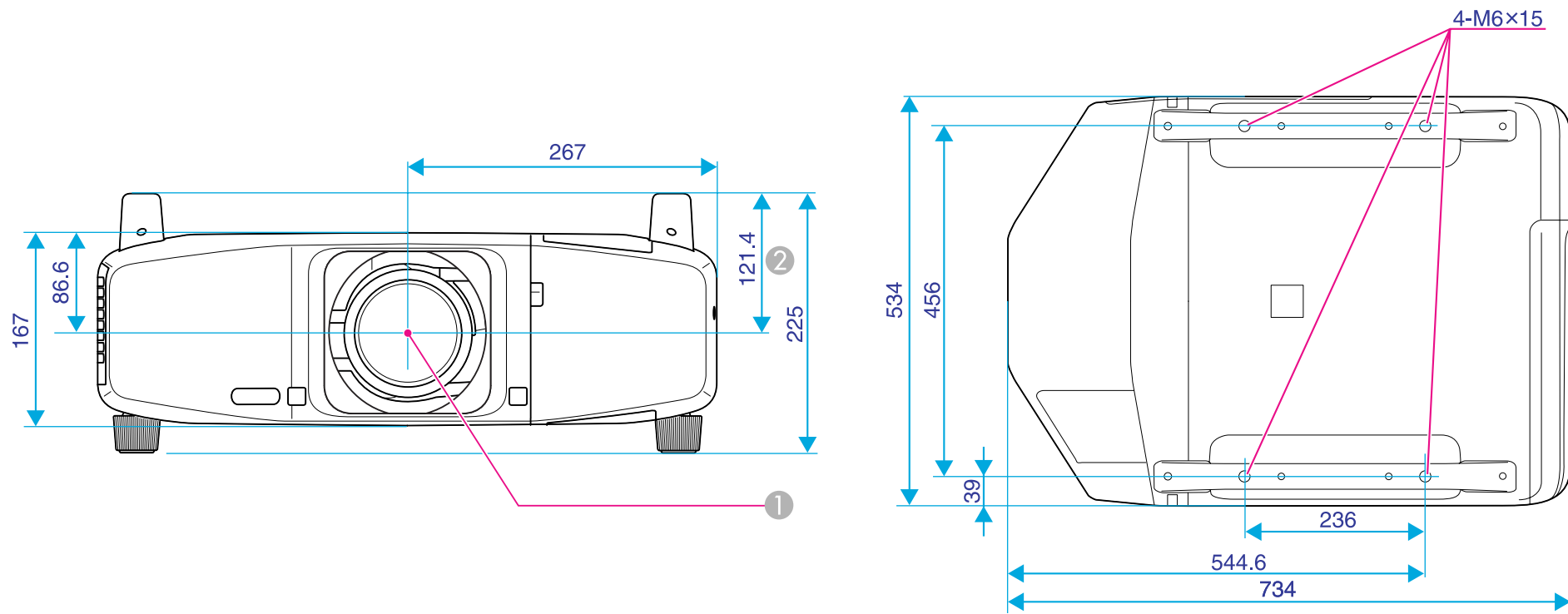

- ① Center of lens
- ② Distance from center of lens to suspension bracket fixing point

Units: mm