

**EPSON**<sup>®</sup>  
EXCEED YOUR VISION



## Epson EB-470, 475W, 480 and 485W ULTRA-SHORT-THROW PROJECTORS



### Ultra-short-throw projectors with comprehensive connectivity and premium audio.

The Epson EB-470/475W/480/485W ultra-short-throw projectors make it easy to project large, vibrant images from the shortest distance for maximum impact and flexibility. They can be mounted to the wall with the included wall mount, making them ideal for use with interactive or standard dry-erase whiteboards. Project a brilliant 80" image on a wall or screen from approximately 20cm away from the edge of the projector. The 475W and 485W boast a 16:10 widescreen (WXGA) aspect ratio for displaying high-definition content, and content from widescreen computers, while the 470 and 480 boast a 4:3 (XGA) aspect ratio. Featuring future-ready HDMI connectivity, all four projectors are ideal for classrooms equipped with the latest devices.

**Ultra-short throw distance** — ideal for wall-mount installations and use with interactive or standard dry-erase whiteboards; significantly reduces shadow interference and glare

**Larger-than-life standard and widescreen images** — XGA resolution (470, 480), WXGA resolution (475W, 485W)

**Future-ready connectivity** — HDMI digital connectivity for classrooms with the latest devices



# EB-470/475W/480/485W ULTRA-SHORT-THROW PROJECTORS

## The best-selling projectors in the world

Epson understands education and has a solution no matter what your teaching scenario. Built with image quality and reliability in mind, EPSON® projectors enhance communication and inspire collaboration, while offering a low cost of ownership. From long-throw projectors designed for traditional educational settings to ultra-short-throw and all-in-one solutions built for progressive classrooms, Epson has the model made for you.



## Leading-edge technology and performance

### Spectacular quality and colour with 3LCD technology

Innovative technology with proven reliability

- 3 chips for full-time, vibrant colour
- 25% less electricity required per lumen of brightness when compared to 1-chip DLP projectors<sup>1</sup>
- Over 20 years of road-tested reliability built into every projector

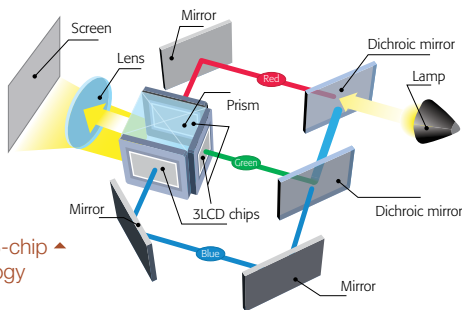

3LCD, 3-chip technology

### Amazing colour and white light output

Whether you're projecting images with deep, dark colours or a white screen with minimal text or graphics, you get rich, colourful images with:

LUMENS		LUMENS		LUMENS	
2600	2600	3000	3000	3100	3100
COLOR LIGHT	WHITE LIGHT	COLOR LIGHT	WHITE LIGHT	COLOR LIGHT	WHITE LIGHT
TRUE-TO-LIFE COLOR		TRUE-TO-LIFE COLOR		TRUE-TO-LIFE COLOR	
<b>EB-470 and 475W</b>		<b>EB-480</b>		<b>EB-485W</b>	
2600 lumens of colour/white light output <sup>3</sup>		3000 lumens of colour/white light output <sup>3</sup>		3100 lumens of colour/white light output <sup>3</sup> (bright enough for classrooms with lots of ambient light)	

### Long-life lamp

- High-efficiency lamp life provides a low total cost of ownership — up to 3000 hours in Normal Mode and up to 4000 hours in ECO Mode<sup>2</sup>
- Easy replacement — top-loading lamp means you don't have to uninstall the projector from the wall mount

### Brilliant widescreen performance (EB-475W/485W only)

- High-definition WXGA (1280 x 800) resolution and a 16:10 aspect ratio allow you to project HD widescreen content as well as content from widescreen notebooks
- Get amazing images and 30% more image area than with a standard 4:3 projector, plus the capability to display 4:3 and 16:9 content, without sacrificing image quality

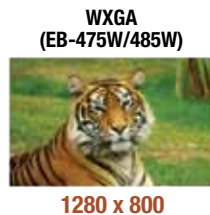

### Ultra-short-throw projection

A leader in ultra-short-throw projection, Epson designed these projectors to ensure the following benefits:

- Large images to engage any audience — project an 80" image from approximately 20cm away
- Minimal shadow interference — no need to worry about obscuring the screen with shadows cast by the presenter
- Minimal glare — unlike traditional front-projection technology, these projectors make it more comfortable for presenters since they do not have to deal with light shining in their eyes
- Wall mount installation makes these projectors ideal for use with interactive or standard dry-erase whiteboards



Significant reduction in shadow interference and glare

# Advanced connectivity including network features

## HDMI for high-definition video and audio

- Delivers both audio and brilliant HD video content with just one cable
- Future-ready connectivity ensures compatibility with the latest laptop, Blu-ray® and media playing devices

**HDMI™**



## Present remotely via RJ-45 network connectivity

Transmit both audio and video with a single connection

- Display material from any networked location, or in up to 4 different classrooms simultaneously
- Present remotely to support distance learning applications
- Connect wirelessly, via a network access point or optional wireless module, to give teachers the freedom to move around the classroom and interact with students for a more engaging learning environment



## Monitor/control projectors remotely

Easily monitor/control EPSON networked projectors remotely, using the RJ-45 connection and EasyMP® Monitor software

- Save time and maintenance costs — power classroom projectors on and off without having to go to each individual classroom; set schedules for automatic events
- Receive e-mail alerts when attention is required
- Crestron RoomView™ enabled — monitor/control your projector with RoomView software, without the need for an A/V control box
- Broadcast your message — advertise events or broadcast instructions to all networked EPSON projectors<sup>5</sup>



## Virtual remote control on your computer

- Convenient projector remote control via a web browser (when projector is connected to the network)
- Control power on/off, source, volume, page up/down functions and more from your computer
- No special applications or software necessary; simply use your web browser in Windows® or Mac



## Easy setup using 3-in-1 USB Plug 'n Play — for PC and Mac

Three features, all with one standard USB connection

- Display your presentation
- Transmit audio
- Control your presentation via remote control
- Eliminate the need for three separate cable connections

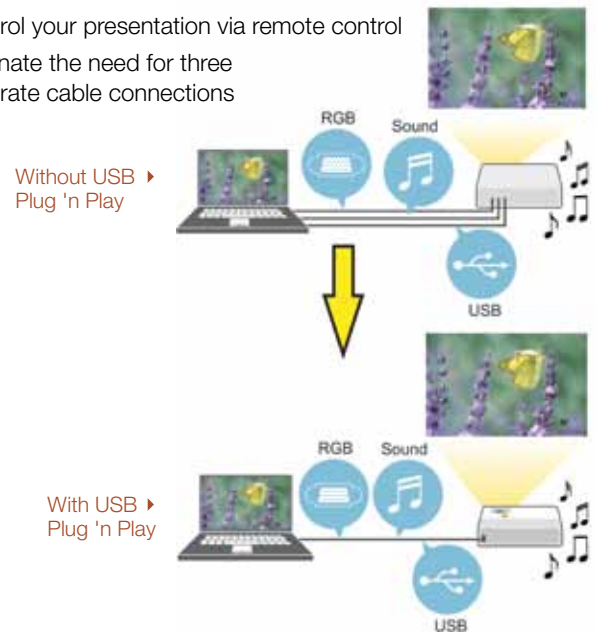

## Convenient control and energy-saving features

- Instant Off® — no cool-down time required; it's ready to shut down when you are
- A/V Mute — pause your presentation to direct focus elsewhere or take a quick break
- Sleep Mode — set from 1 to 30 minutes to save energy when no signal is detected
- Direct Power On/Off — power the projector on/off with the flip of a wall switch

# Easy setup with included wall mount

## Versatile image projection

- Improved mount and short throw distance allows 90" WXGA image projection, even in rooms with ceilings as low as 2.4m — like portable classrooms

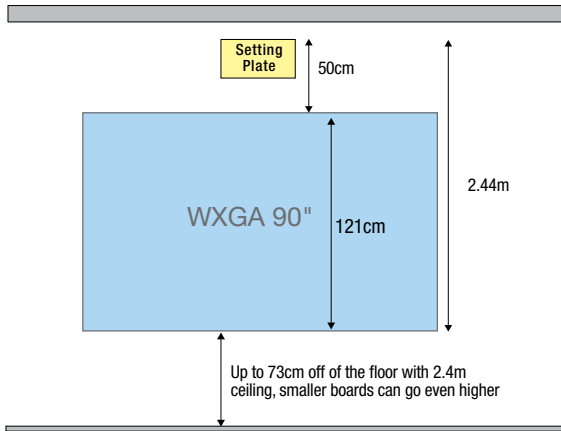

## Easy picture adjustments

- 1.35x digital zoom — for positioning flexibility
- +/- 5 degrees vertical keystone correction — allows for easy adjustments when the projector is placed above or below the center of the projection screen
- +/- 5 degrees horizontal keystone correction — allows for off-center positioning, so you can still present a rectangular image

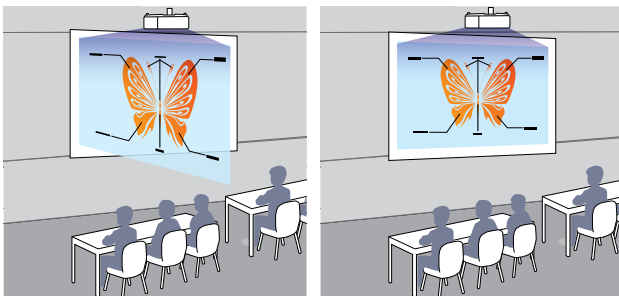

Without horizontal keystone

With horizontal keystone



## New, improved wall mount included

- Flexible wall mount makes installation in a wide variety of classroom environments easy
- Includes adjustments for horizontal roll, horizontal rotation, vertical tilt, horizontal shift, distance extensions and vertical height adjustments for precise installations

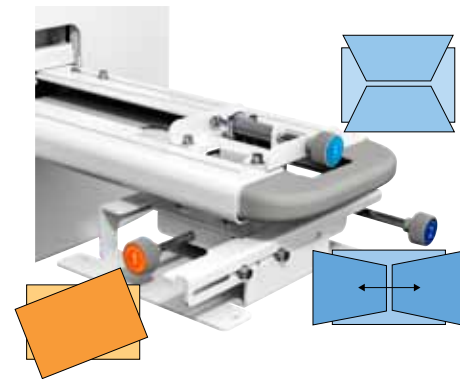

- Large, colour-coded dials provide intuitive guidance on adjustments

## Quick Corner®

- This innovative feature allows you to move any of the four corners of an image independently, for a perfectly rectangular picture

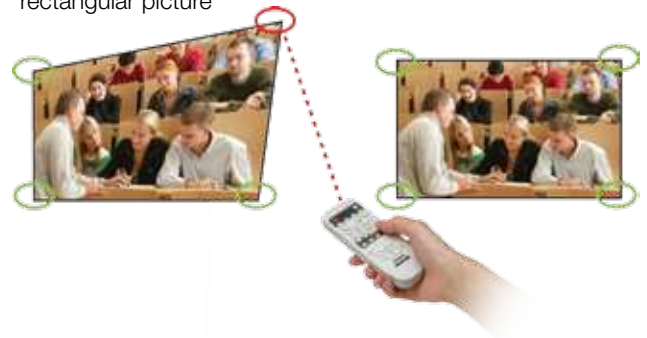

## Better Products for a Better Future™

For more information on Epson's environmental programs, go to [www.epson.com.au/company/environment](http://www.epson.com.au/company/environment)



### Eco Features

- Energy-efficient 3LCD light engine
- Recyclable product

## Unique sound and communication tools

### Built-in 16 W speaker and microphone input

- Captivate your entire classroom with 16 W of powerful sound using the internal speaker
- Convenient microphone input allows you to connect a microphone to the projector and amplify your voice through the projector's built-in speaker
- The microphone can even be used while the projector is in standby mode, which saves energy and costs
- Audio pass-through feature enables you to use the audio out port with external speakers, even when the projector is in standby mode, saving lamp life and energy

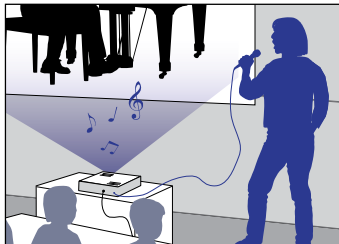

### Built-in teaching aids save time

- Choose from four pre-set templates to project lines or grids onto whiteboards or chalkboards, or create a custom template such as a map or other image used frequently
- Simply display the template by selecting the customizable User button on the projector remote control

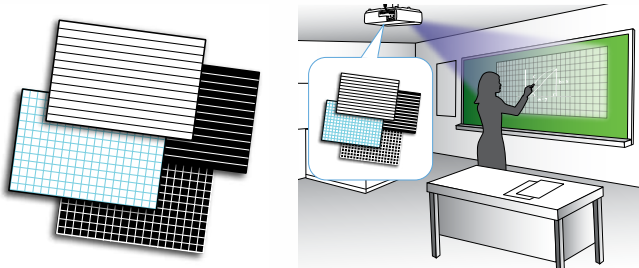

Easily project lines or grids with built-in templates



### EB-470, 475W, 480 and 485W Additional Features

- **Versatile connectivity for the classroom** — HDMI, VGA inputs (computer/component), audio inputs, USB, audio out, monitor out, microphone input, RS-232c and RJ-45
- **Fast wireless 802.11 b/g/n connectivity** — with the optional wireless module via either:
  - Included software (Mac® and PC) or
  - Optional Quick Wireless Connection USB key for fast, ad hoc, wireless connectivity (PC only)
- **High efficiency filter** — 2x the surface area of previous filters for better protection against dust; cleaning schedule up to 5000 hours<sup>4</sup>

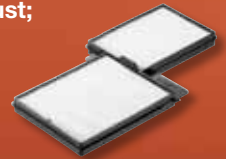

## The EPSON ultra-short-throw projector series Model Comparison

GOOD	<b>EB-470</b> Best value, brilliant images	2600 lumens XGA Resolution 1024 x 768	
	<b>EB-475W</b> Step up to widescreen resolution	2600 lumens WXGA Resolution 1280 x 800	
BETTER	<b>EB-480</b> Step up to ultra-bright images	3000 lumens XGA Resolution 1024 x 768	
	<b>EB-485W</b> Step up to ultra-bright widescreen resolution	3100 lumens WXGA Resolution 1280 x 800	

# EB-470, 475W, 480 and 485W Ultra-short-throw Projectors

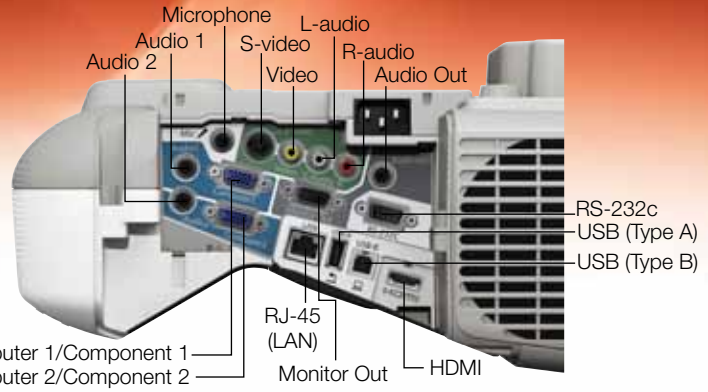

Computer 1/Component 1  
Computer 2/Component 2

Product Name	Product Code
EB-470 Projector	V11H456053
EB-475W Projector	V11H455053
EB-480 Projector	V11H485053
EB-485W Projector	V11H454053

## Specifications

### Projection System

3LCD, 3-chip technology

### Projection Method

Front/rear wall mount

### Driving Method

Poly-silicon TFT Active Matrix

### Pixel Number

470/475W: 786,432 dots (1024 x 768) x 3  
475W/485W: 1,024,000 dots (1280 x 800) x 3

### Colour Light Output<sup>3</sup>

470/475W: 2600 lumens  
480: 3000 lumens  
485W: 3100 lumens

### White Light Output<sup>3</sup>

470/475W: 2600 lumens (ISO 21118 standard)  
480: 3000 lumens (ISO 21118 standard)  
485W: 3100 lumens (ISO 21118 standard)

### Aspect Ratio

470/480: 4:3  
475W/485W: 16:10

### Native Resolution

470/480: 1024 x 768 (XGA)  
475W/485W: 1280 x 800 (WXGA)

### Resize

640 x 480 (VGA), 800 x 600 (SVGA),  
1024 x 768 (XGA/475W and 485W only),  
1152 x 864 (SXGA), 1280 x 800  
(WXGA/470 and 480 only),  
1280 x 960 (SXGA2), 1280 x 1024 (SXGA3),  
1280 x 768 (WXGA 60-1/470 and 480 only),  
1360 x 768 (WXGA 60-2), 1440 x 900 (WXGA+),  
1400 x 1050 (SXGA+), 1600 x 900 (WXGA++)

### Lamp Type

470/475W: 190 W UHE  
480/485W: 215 W UHE

### Lamp Life<sup>2</sup>

Up to 4000 hours (ECO Mode)  
Up to 3000 hours (Normal Mode)

### Throw Ratio Range

470/480: 0.31 – 0.42  
475W/485W: 0.27 – 0.37

### Size (projected distance)

470/480: (0.348 to 0.597 m)  
475W/485W: (0.348 to 0.597 m)

### Keystone Correction Manual

Vertical ± 5 degrees  
Horizontal ± 5 degrees

### Mac Connectivity

Projector is Mac compatible via USB,  
DVI to HDMI or VGA adapter (not included),  
DP to HDMI or VGA

### Contrast Ratio

Up to 3000:1

### Colour Reproduction

16.77 million colours

## Projection Lens

### Type

No optical zoom/Manual focus

### F-number

1.80

### Focal Length

3.71 mm

### Zoom Ratio

Digital zoom 1.0 – 1.35

## Other

### Display Performance

NTSC: 560 lines  
PAL: 560 lines  
(Depends on observation of the multi-burst pattern)

### Input Signal

NTSC/NTSC4.43/PAL/M-PAL/N-PAL/PAL60/  
SECAM

### Interfaces

HDMI x 1  
Computer/component video: D-sub 15 pin x 2  
S-video: Mini DIN x 1  
Composite video: RCA (Yellow) x 1  
Audio in: RCA x 1 (L and R), Mini stereo x 2  
USB connector: Type B x 1  
(USB display, audio and mouse control)  
USB connector: Type A x 1  
(USB memory/document camera)  
RJ-45 x 1  
Serial: RS-232c x 1  
Monitor out: D-sub 15 pin x 1  
Audio out: Mini stereo x 1

### Microphone: Mini stereo x 1

Wireless LAN port: 802.11 b/g/n  
(optional – module sold separately)

### Speaker

16 W (mono)

### Operating Temperature

5° to 35 °C

### Power Supply Voltage

100 – 240 V ± 10%, 50/60 Hz

### Power Consumption

470/475W: 275 W (Normal Mode)  
215 W (ECO Mode)  
8.3 W Standby (Communication On)  
0.27 W Standby (Communication Off)  
480/485W: 300 W (Normal Mode)  
215 W (ECO Mode)  
8.3 W Standby (Communication On)  
0.27 W Standby (Communication Off)

## Other (continued)

### Fan Noise

35 dB (Normal Mode)  
28 dB (ECO Mode)

### Security

Kensington®-style lock provision,  
padlock and security cable hole,  
password protect function

## Dimensions (W x D x H)

Including feet: 367w x 181.5h x 375d mm  
Excluding feet: 367w x 143h x 375d mm  
Weight: 5.2kg

## Remote Control

### Features

Source search, video, LAN, computer, USB,  
power, aspect, colour mode, volume, e-zoom,  
A/V mute, freeze, menu, page up and down,  
help, auto, mouse functions, user, esc

### Operating Distance

Front/rear: 6 m

## Support

### What's In The Box

EB-470, 475W, 480 or 485W projector,  
wall mount, 5m power cord, projector  
remote control, batteries, user manual CD,  
projector software CD, Quick Setup Sheet,  
installation guide, template sheet,  
password protection sticker

## Accessory Part Numbers

Genuine EPSON lamp	V13H010L71
Replacement air filter	V13H134A40
Control Box (ELPCB01)	V12H443053
Active speakers (ELPSP02)	V12H467053
Wireless 802.11b/g/n LAN unit (ELPAP07)	V12H418P13
Quick wireless connection USB key (ELPAP08)	V12H005M08
EPSON DC-06 document camera (ELPDC06)	V12H321003
EPSON DC-11 document camera (ELPDC11)	V12H377053

1 Data source: ProjectorCentral.com Jan. 2011. Average of 1038 shipping models for which manufacturers provided lumens and total power data, all resolutions and brightness levels.

2 Lamp life will vary depending upon mode selected, environmental conditions and usage. Lamp brightness decreases over time.

3 Colour and white light output will vary depending on mode selected. White light output measured using ISO 21118 standard.

4 Recommendation based on normal room conditions. Cleaning requirements may vary depending on use, environment and other conditions. Cleaning intervals may be adjusted to accommodate the environment in which the projector is used.

5 Works only with EPSON projectors that support presentation over the network capability.

## EPSON AUSTRALIA

3 Talavera Road  
North Ryde NSW 2113  
Tel: (02) 8899 3666  
[www.epson.com.au](http://www.epson.com.au)

## EPSON NEW ZEALAND

Level 2, 7-9 Fanshawe Street  
Auckland, 1010  
Tel: (09) 366 6855  
[www.epson.co.nz](http://www.epson.co.nz)

ABN 91 002 625 783

04/12