

**EPSON**  
EXCEED YOUR VISION

# **User's Guide**

## **Multimedia Projector**

**EB-435W**

**EB-430**

**EB-425W**

**EB-420**

**ProSelecta**



View :: Compare :: Select - [www.ProSelecta.com](http://www.ProSelecta.com)

## Notations Used in This Guide





- **Safety indications**

The documentation and the projector use graphical symbols to show how to use the projector safely.

The indications and their meaning are as follows. Make sure you understand them properly before reading the guide.

 <b>Warning</b>	This symbol indicates information that, if ignored, could possibly result in personal injury or even death due to incorrect handling.
 <b>Caution</b>	This symbol indicates information that, if ignored, could possibly result in personal injury or physical damage due to incorrect handling.

- **General information indications**

<b>Attention</b>	Indicates procedures which may result in damage or injury if sufficient care is not taken.
	Indicates additional information and points which may be useful to know regarding a topic.
	Indicates a page where detailed information regarding a topic can be found.
	Indicates that an explanation of the underlined word or words in front of this symbol appears in the glossary of terms. See the "Glossary" section of the "Appendices".  "Glossary" <a href="#">p.129</a>
[Name]	Indicates the name of the buttons on the remote control or the control panel. Example: [Esc] button
Menu Name	Indicates Configuration menu items. Example: Select <b>Brightness</b> from <b>Image</b> . <b>Image - Brightness</b>



## Notations Used in This Guide ..... 2

### Introduction

---

#### Projector Features ..... 7

- Projection Functions ..... 7
  - Enabling projection from a short distance ..... 7
  - Easy writing on a whiteboard or blackboard using the pattern function ..... 7
  - Connecting with a USB cable and projecting (USB Display) ..... 7
  - Connecting to a network and projecting images from the computer's screen ..... 7
  - Enhanced security functions ..... 7
- Optional Functions ..... 7
  - Enlarge and project your files with the Document Camera ..... 7
  - Easy connection to a computer with Quick Wireless ..... 7

#### Part Names and Functions ..... 8

- Front/Top ..... 8
- Rear ..... 9
- Base ..... 10
- Control Panel ..... 11
- Remote Control ..... 12
  - Replacing the remote control batteries ..... 15
  - Remote control operating range ..... 15

### Preparing the Projector

---

#### Installing the Projector ..... 17

- Installation Methods ..... 17

#### Connecting Equipment ..... 18

- Connecting a Computer ..... 18
- Connecting Image Sources ..... 19
- Connecting USB Devices ..... 22
- Connecting a microphone ..... 23

- Connecting External Equipment ..... 24
- Connecting a LAN Cable ..... 24
- Installing the Optional Wireless LAN Unit ..... 26

### Basic Usage

---

#### Projecting images ..... 28

- From Installation to Projection ..... 28
- Automatically Detect Input Signals and Change the Projected Image (Source Search) ..... 29
- Switching to the Target Image Using the Remote Control ..... 30
- Projecting with USB Display ..... 30
  - System requirements ..... 30
  - Connecting for the first time ..... 31
  - Uninstalling ..... 32

#### Adjusting Projected Images ..... 34

- Correcting Keystone Distortion ..... 34
  - H/V-Keystone ..... 34
  - Quick Corner ..... 35
- Adjusting the Image Size ..... 37
- Adjusting the Image Position ..... 37
- Adjusting the Horizontal Tilt ..... 37
- Correcting the Focus ..... 38
- Adjusting the Volume ..... 38
- Selecting the Projection Quality (Selecting Color Mode) ..... 38
- Setting Auto Iris ..... 39
- Changing the Aspect Ratio of the Projected Image ..... 40
  - Changing methods ..... 40
  - Changing the aspect mode (EB-435W/EB-425W only) ..... 40
  - Changing the aspect mode (EB-430/EB-420 only) ..... 41

### Useful Functions

---

#### Projection Functions ..... 44

- Hiding the Image and Sound Temporarily (A/V Mute) ..... 44

- Freezing the Image (Freeze) . . . . . 44
- Pointer Function (Pointer) . . . . . 45
- Enlarging Part of the Image (E-Zoom) . . . . . 46
- Using the Remote Control to Operate the Mouse Pointer (Wireless Mouse) . . . . . 47
- Saving a User's Logo . . . . . 48
- Saving User Pattern . . . . . 50

## Security Functions . . . . . 52

- Managing Users (Password Protect) . . . . . 52
  - Kinds of Password Protect . . . . . 52
  - Setting Password Protect . . . . . 52
  - Entering the Password . . . . . 53
- Restricting Operation (Control Panel Lock) . . . . . 54
- Anti-Theft Lock . . . . . 55
  - Installing the wire lock . . . . . 55

## Configuration Menu

### Using the Configuration Menu . . . . . 57

### List of Functions . . . . . 58

- Configuration Menu Table . . . . . 58
  - Network menu . . . . . 59
- Image Menu . . . . . 60
- Signal Menu . . . . . 61
- Settings Menu . . . . . 63
- Extended Menu . . . . . 64
- Network Menu . . . . . 66
  - Notes on operating the Network menu . . . . . 67
  - Soft keyboard operations . . . . . 67
  - Basic menu . . . . . 68
  - Wireless LAN menu . . . . . 68
  - Security menu . . . . . 70
  - Wired LAN menu . . . . . 71
  - Mail menu . . . . . 72
  - Others menu . . . . . 73
  - Reset menu . . . . . 74

- Info Menu (Display Only) . . . . . 74
- Reset Menu . . . . . 75

## Troubleshooting

### Using the Help . . . . . 78

### Problem Solving . . . . . 79

- Reading the Indicators . . . . . 79
- When the Indicators Provide No Help . . . . . 82
- Problems Relating to Images . . . . . 83
  - No images appear . . . . . 83
  - Moving images are not displayed (only the moving image portion turns black) . . . . . 84
  - Projection stops automatically . . . . . 84
  - The message "Not supported" is displayed. . . . . 84
  - The message "No Signal" is displayed. . . . . 84
  - Images are fuzzy, out of focus, or distorted . . . . . 85
  - Interference or distortion appear in images . . . . . 85
  - The image is truncated (large) or small, or the aspect is not suitable . . . . . 86
  - Image colors are not right . . . . . 87
  - Images appear dark . . . . . 87
- Problems when Projection Starts . . . . . 88
  - The projector does not turn on . . . . . 88
- Other Problems . . . . . 89
  - No sound can be heard or the sound is faint . . . . . 89
  - No sound can be heard from the microphone . . . . . 89
  - The remote control does not work . . . . . 90
  - I want to change the language for messages and menus . . . . . 90
  - Mail is not received even if an error occurs with the projector . . . . . 90

### About Event ID . . . . . 92

## Maintenance

<b>Cleaning</b> .....	<b>94</b>
Cleaning the Projector's Surface .....	94
Cleaning the Lens .....	94
Cleaning the Air Filter .....	94
<b>Replacing Consumables</b> .....	<b>96</b>
Replacing the Lamp .....	96
Lamp replacement period .....	96
How to replace the lamp .....	96
Resetting the lamp hours .....	99
Replacing the Air Filter .....	99
Air filter replacement period .....	99
How to replace the air filter .....	99

## Appendix

<b>Slideshow</b> .....	<b>103</b>
Projecting Without a Computer (Slideshow) .....	103
Specifications for files that can be projected using Slideshow .....	103
Slideshow examples .....	103
Slideshow operating methods .....	103
Projecting the selected image .....	105
Projecting image files in a folder in sequence (Slideshow) .....	106
Image file display settings and Slideshow operation settings .....	107
<b>Monitoring and Controlling</b> .....	<b>108</b>
About EasyMP Monitor .....	108
Changing Settings Using a Web Browser (Web Control) .....	108
Projector setup .....	108
Displaying the Web Control screen .....	109
Displaying the Web Remote screen .....	109
Using the Mail Notification Function to Report Problems .....	111
Reading Error Notification Mail .....	111
Management Using SNMP .....	111

ESC/VP21 Commands .....	112
Command list .....	112
Cable layouts .....	112
About PJLink .....	113
About Crestron RoomView® .....	114
Operating a projector from your computer .....	114

<b>Optional Accessories and Consumables</b> .....	<b>118</b>
Optional Accessories .....	118
Consumables .....	118

<b>Screen Size and Projection Distance</b> .....	<b>119</b>
Projection Distance (For EB-430/EB-420) .....	119
Projection Distance (For EB-435W/EB-425W) .....	120

<b>Supported Monitor Displays</b> .....	<b>122</b>
Supported Resolutions .....	122
Computer signals (analog RGB) .....	122
Component Video .....	122
Composite video .....	122
Input signal from the HDMI port .....	122

<b>Specifications</b> .....	<b>124</b>
Projector General Specifications .....	124

<b>Appearance</b> .....	<b>128</b>
-------------------------	------------

<b>Glossary</b> .....	<b>129</b>
-----------------------	------------

<b>General Notes</b> .....	<b>131</b>
About Notations .....	131
General Notice: .....	131

<b>Index</b> .....	<b>132</b>
--------------------	------------



# Introduction

This chapter explains the projector's features and the part names.

---

## Projection Functions

### Enabling projection from a short distance

You can project large images from a short distance without having to move the projector away from the screen.

☛ "Screen Size and Projection Distance" [p.119](#)

### Easy writing on a whiteboard or blackboard using the pattern function

You can project ruled lines and grid patterns. This is useful when drawing diagrams on a whiteboard or blackboard.

☛ Settings - Pattern [p.63](#)

### Connecting with a USB cable and projecting (USB Display)

By simply connecting a commercially available USB cable, you can project images from a computer's screen without a computer cable.

☛ "Projecting with USB Display" [p.30](#)

### Connecting to a network and projecting images from the computer's screen

You can connect the projector to a computer on a network and project the computer's screen using the supplied EasyMP Network Projection (application software).

☛ [EasyMP Network Projection Operation Guide](#)

## Enhanced security functions

### • Password Protect to restrict and manage users

By setting a password you can restrict who can use the projector.

☛ "Managing Users (Password Protect)" [p.52](#)

### • Control Panel Lock restricts button operation on the control panel

You can use this to prevent people changing projector settings without permission at events, in schools, and so on.

☛ "Restricting Operation (Control Panel Lock)" [p.54](#)

### • Equipped with various anti-theft devices

The projector is equipped with the following types of anti-theft security devices.

- Security slot
- Security cable installation point

☛ "Anti-Theft Lock" [p.55](#)

---

## Optional Functions

### Enlarge and project your files with the Document Camera

You can project paper documents and objects using the optional Document Camera. Image focus is automatically adjusted using the auto focus function. You can also enlarge images using digital zoom.

☛ "Optional Accessories" [p.118](#)

### Easy connection to a computer with Quick Wireless

By simply connecting the optional Quick Wireless Connection USB Key to a computer, you can project the computer's screen. (Windows computers only)

☛ "Optional Accessories" [p.118](#)

## Front/Top

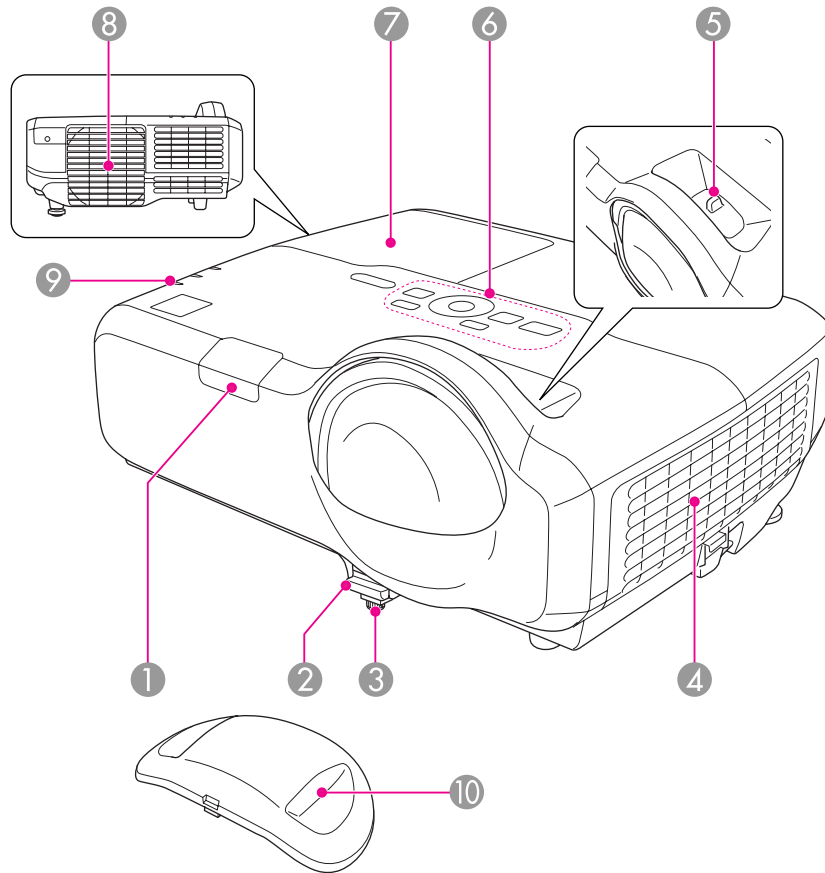

Name	Function
① Remote receiver	Receives signals from the remote control.
② Foot adjust lever	Press the foot lever to extend and retract the front foot. ☛ "Adjusting the Image Position" p.37
③ Front adjustable foot	When setup on a surface such as a desk, extend the foot to adjust the position of the image. ☛ "Adjusting the Image Position" p.37

Name	Function
④ Air intake vent (air filter)	Takes in air to cool the projector internally. ☛ "Cleaning the Air Filter" p.94 ☛ "Replacing the Air Filter" p.99
⑤ Focus ring	Adjusts the image focus. ☛ "Correcting the Focus" p.38
⑥ Control panel	Operates the projector. ☛ "Control Panel" p.11
⑦ Lamp cover	Open when replacing the projector's lamp. ☛ "Replacing the Lamp" p.96
⑧ Air exhaust vent	Exhaust vent for air used to cool the projector internally. <div style="border: 1px solid black; padding: 5px; margin-top: 10px;"> <p><b>⚠ Caution</b></p> <p>While projecting, do not put your face or hands near the air exhaust vent, and do not place objects that may become warped or damaged by heat near the vent.</p> </div>
⑨ Indicators	Indicates the projector's status. ☛ "Reading the Indicators" p.79
⑩ Lens cover	Attach the cover when not using the projector to prevent the lens from getting dirty or being damaged.



## Rear

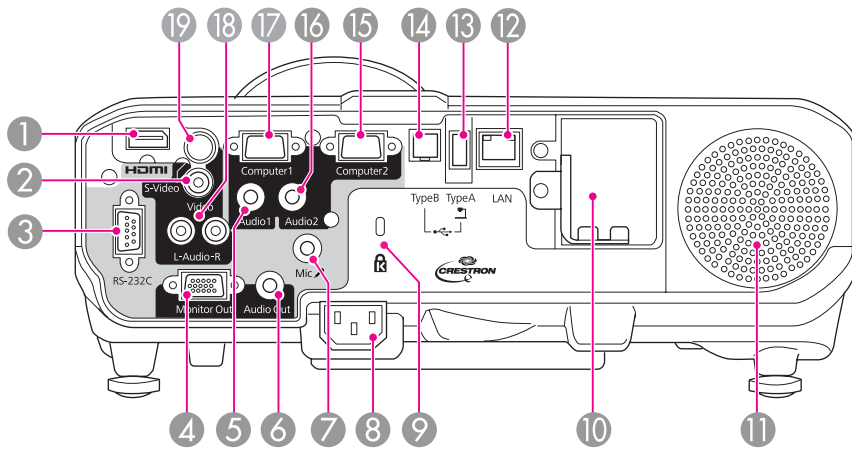

Name	Function
① <b>HDMI port</b>	Inputs video signals from HDMI compatible video equipment and computers. This projector is compatible with <b>HDCP</b> . ☛ "Connecting Equipment" p.18
② <b>Video port</b>	Inputs composite video signals from video sources.
③ <b>RS-232C port</b>	When controlling the projector from a computer, connect it to the computer with an RS-232C cable. This port is for control use and should not normally be used. ☛ "ESC/VP21 Commands" p.112
④ <b>Monitor Out port</b>	Outputs analog RGB signals input from the Computer1 port to an external monitor. You cannot output signals input from other ports or component video signals.
⑤ <b>Audio1 port</b>	Inputs audio from equipment connected to the Computer1 port.
⑥ <b>Audio Out port</b>	Outputs audio from the currently projected image or the Mic port to an external speaker.

Name	Function
⑦ <b>Mic port</b>	Inputs audio from the microphone. ☛ "Connecting a microphone" p.23
⑧ <b>Power inlet</b>	Connects the power cable to the projector. ☛ "From Installation to Projection" p.28
⑨ <b>Security slot</b>	The security slot is compatible with the Microsaver Security System manufactured by Kensington. ☛ "Anti-Theft Lock" p.55
⑩ <b>Wireless LAN unit installation section</b>	Install the optional Wireless LAN unit here. Remove the stopper when installing. ☛ "Installing the Optional Wireless LAN Unit" p.26
⑪ <b>Speaker</b>	Outputs audio.
⑫ <b>LAN port</b>	Connects a LAN cable to connect to a network.
⑬ <b>USB(TypeA) port</b>	<ul style="list-style-type: none"> <li>Connects a USB memory device or a digital camera, and projects images as a Slideshow. ☛ "Projecting Without a Computer (Slideshow)" p.103</li> <li>Connects the optional Document Camera.</li> </ul>
⑭ <b>USB(TypeB) port</b>	<ul style="list-style-type: none"> <li>Connects the projector to a computer via a commercially available USB cable, and projects the images on the computer. ☛ "Projecting with USB Display" p.30</li> <li>Connects the projector to a computer via the commercially available USB cable to use the Wireless Mouse function. ☛ "Using the Remote Control to Operate the Mouse Pointer (Wireless Mouse)" p.47</li> </ul>
⑮ <b>Computer2 port</b>	Inputs image signals from a computer and component video signals from other video sources.
⑯ <b>Audio2 port</b>	Inputs audio from equipment connected to the Computer2 port.
⑰ <b>Computer1 port</b>	Inputs image signals from a computer and component video signals from other video sources.

Name	Function
18 <b>Audio-L/R port</b>	Inputs audio from equipment connected to the S-Video port or the Video port.
19 <b>S-Video port</b>	For S-video signals from video sources.

## Base

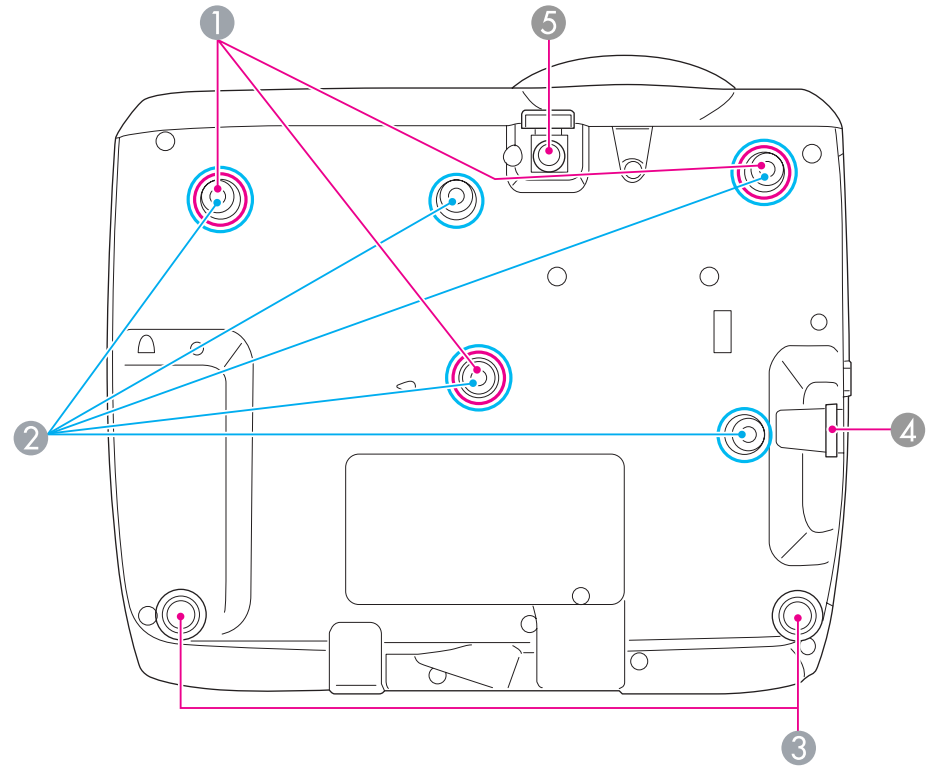

Name	Function
1 <b>Ceiling mount fixing points (three points)</b>	Attach the optional Ceiling Mount here when suspending the projector from a ceiling. 🖱️ "Installing the Projector" <a href="#">p.17</a> 🖱️ "Optional Accessories" <a href="#">p.118</a>
2 <b>Wall mount plate fixing points (five points)</b>	Attach the optional wall mount plate here when suspending the projector from a wall. 🖱️ "Optional Accessories" <a href="#">p.118</a>

Name	Function
③ <b>Rear feet</b>	When setup on a surface such as a desk, turn to extend and retract to adjust the horizontal tilt. ☛ "Adjusting the Horizontal Tilt" <a href="#">p.37</a>
④ <b>Security cable installation point</b>	Pass a commercially available wire lock through here and lock it in place. ☛ "Installing the wire lock" <a href="#">p.55</a>
⑤ <b>Front adjustable foot</b>	When setup on a surface such as a desk, extend the foot to adjust the position of the image. ☛ "Adjusting the Image Position" <a href="#">p.37</a>

## Control Panel

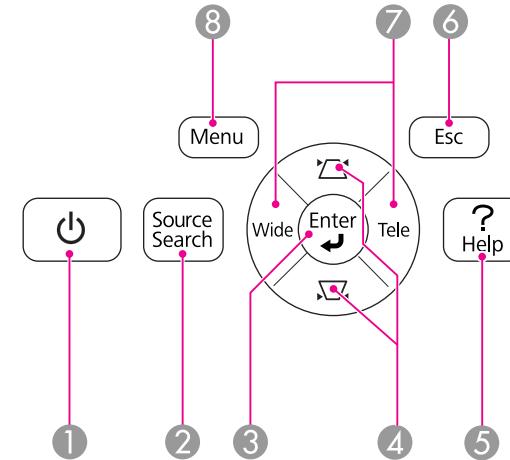



Name	Function
① <b>[⏻] button</b>	Turns the projector power on or off. ☛ "From Installation to Projection" <a href="#">p.28</a>
② <b>[Source Search] button</b>	Switches to the image from the input port where video signals are being input. ☛ "Automatically Detect Input Signals and Change the Projected Image (Source Search)" <a href="#">p.29</a>
③ <b>[↵] button</b>	<ul style="list-style-type: none"> <li>• When the Configuration menu or the Help screen is displayed, it accepts and enters the current selection and moves to the next level.</li> <li>• If pressed while projecting analog RGB signals from Computer1 port or Computer2 port, you can automatically optimize Tracking, Sync., and Position.</li> </ul>

Name	Function
4 [△][▽] button	<ul style="list-style-type: none"> <li>Displays the Keystone screen allowing you to correct keystone distortion in vertical and horizontal directions.                             <ul style="list-style-type: none"> <li>"H/V-Keystone" <a href="#">p.34</a></li> </ul> </li> <li>If pressed when the Configuration menu or the Help screen is displayed, these buttons select menu items and setting values.                             <ul style="list-style-type: none"> <li>"Using the Configuration Menu" <a href="#">p.57</a></li> <li>"Using the Help" <a href="#">p.78</a></li> </ul> </li> </ul>
5 [Help] button	<p>Displays and closes the help screen which shows you how to deal with problems if they occur.</p> <ul style="list-style-type: none"> <li>"Using the Help" <a href="#">p.78</a></li> </ul>
6 [Esc] button	<ul style="list-style-type: none"> <li>Stops the current function.</li> <li>If pressed when the Configuration menu is displayed, it moves to the previous menu level.                             <ul style="list-style-type: none"> <li>"Using the Configuration Menu" <a href="#">p.57</a></li> </ul> </li> </ul>
7 [Tele]/[Wide] buttons	<ul style="list-style-type: none"> <li>Adjusts the size of the projection screen. Press the [Tele] button to reduce the size of the projection screen and press the [Wide] button to increase the size of the projection screen.</li> <li>Corrects keystone distortion in the horizontal direction when the Keystone screen is displayed.                             <ul style="list-style-type: none"> <li>"H/V-Keystone" <a href="#">p.34</a></li> </ul> </li> <li>If pressed when the Configuration menu or the Help screen is displayed, these buttons select menu items and setting values.                             <ul style="list-style-type: none"> <li>"Using the Configuration Menu" <a href="#">p.57</a></li> <li>"Using the Help" <a href="#">p.78</a></li> </ul> </li> </ul>
8 [Menu] button	<p>Displays and closes the Configuration menu.</p> <ul style="list-style-type: none"> <li>"Using the Configuration Menu" <a href="#">p.57</a></li> </ul>

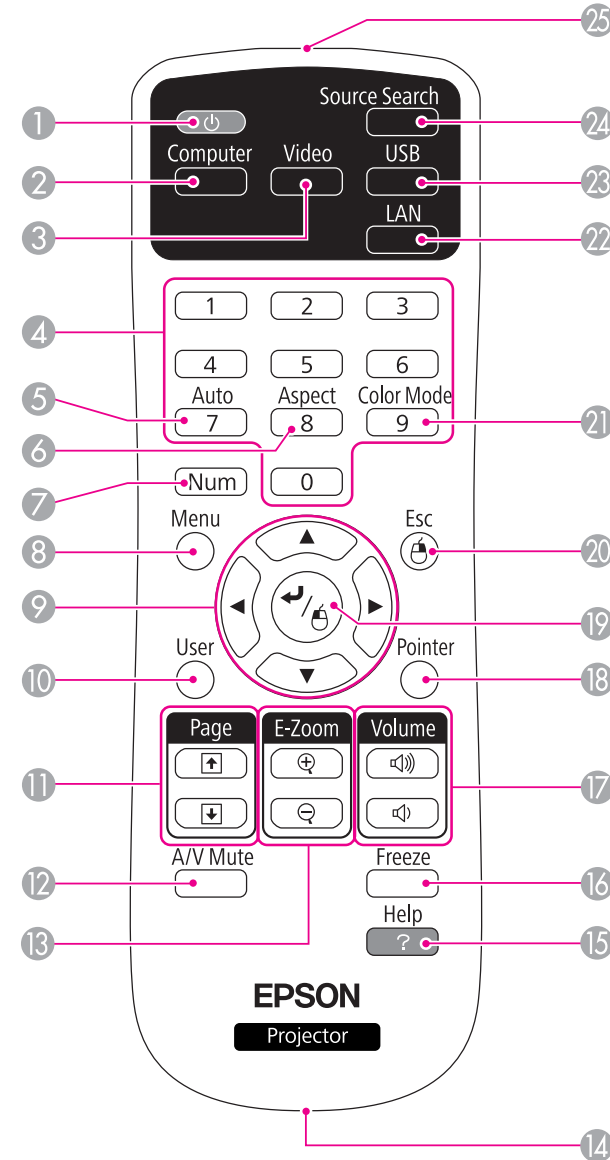
## Remote Control



Name	Function
① [Power] button	Turns the projector power on or off. ☛ "From Installation to Projection" p.28
② [Computer] button	Each time you press the button, the input changes between images from the Computer1 port and the Computer2 port.
③ [Video] button	Each time the button is pressed, the image cycles through the S-Video, Video, and HDMI ports.
④ Numeric buttons	<ul style="list-style-type: none"> <li>Enter the Password. ☛ "Setting Password Protect" p.52</li> <li>Use this button to enter numbers in <b>Network</b> settings from the Configuration menu.</li> </ul>
⑤ [Auto] button	If pressed while projecting analog RGB signals from Computer1 port or Computer2 port, you can automatically optimize Tracking, Sync., and Position.
⑥ [Aspect] button	Each time the button is pressed, the aspect mode changes. ☛ "Changing the Aspect Ratio of the Projected Image" p.40
⑦ [Num] button	Hold down this button and press the numeric buttons to enter passwords and numbers. ☛ "Setting Password Protect" p.52
⑧ [Menu] button	Displays and closes the Configuration menu. ☛ "Using the Configuration Menu" p.57

Name	Function
⑨  button	<ul style="list-style-type: none"> <li>When the Configuration menu or Help screen is displayed, pressing these buttons selects menu items and setting values. ☛ "Using the Configuration Menu" p.57</li> <li>When projecting a Slideshow, pressing these buttons displays the previous/next image, rotates the image, and so on. ☛ "Slideshow operating methods" p.103</li> <li>During Wireless Mouse function, the mouse pointer moves in the direction of the button that was pushed. ☛ "Using the Remote Control to Operate the Mouse Pointer (Wireless Mouse)" p.47</li> </ul>
⑩ [User] button	Select any frequently used item from the seven available Configuration menu items, and assign it to this button. By pressing the [User] button, the assigned menu item selection/adjustment screen is displayed, allowing you to make one-touch settings/adjustments. ☛ "Settings Menu" p.63 <b>Power Consumption</b> is assigned as the default setting.
⑪ [Page] buttons 	Changes pages in files such as PowerPoint files when using the following projection methods. <ul style="list-style-type: none"> <li>When using the Wireless Mouse function ☛ "Using the Remote Control to Operate the Mouse Pointer (Wireless Mouse)" p.47</li> <li>When using USB Display ☛ "Projecting with USB Display" p.30</li> <li>When connecting to a network</li> </ul> When projecting images using Slideshow, pressing these buttons displays the previous/next image file.
⑫ [A/V Mute] button	Turns the video and audio on or off. ☛ "Hiding the Image and Sound Temporarily (A/V Mute)" p.44

Name		Function
13	<b>[E-Zoom] buttons</b> [+] [-]	Enlarges or reduces the image without changing the projection size. ☛ "Enlarging Part of the Image (E-Zoom)" p.46
14	<b>Strap hole</b>	Allows you to attach a commercially available strap to the remote control.
15	<b>[Help] button</b>	Displays and closes the help screen which shows you how to deal with problems if they occur. ☛ "Using the Help" p.78
16	<b>[Freeze] button</b>	Pauses or resumes image playback. ☛ "Freezing the Image (Freeze)" p.44
17	<b>[Volume] buttons</b> [<] [>]	[<] Decreases the volume. [>] Increases the volume. ☛ "Adjusting the Volume" p.38
18	<b>[Pointer] button</b>	Displays the on-screen pointer. ☛ "Pointer Function (Pointer)" p.45
19	<b>[↵] button</b>	<ul style="list-style-type: none"> <li>When the Configuration menu or the Help screen is displayed, it accepts and enters the current selection and moves to the next level. ☛ "Using the Configuration Menu" p.57</li> <li>Acts as a mouse's left button when using the Wireless Mouse function. ☛ "Using the Remote Control to Operate the Mouse Pointer (Wireless Mouse)" p.47</li> </ul>
20	<b>[Esc] button</b>	<ul style="list-style-type: none"> <li>Stops the current function.</li> <li>If pressed when the Configuration menu is displayed, it moves to the previous level. ☛ "Using the Configuration Menu" p.57</li> <li>Acts as a mouse's right button when using the Wireless Mouse function. ☛ "Using the Remote Control to Operate the Mouse Pointer (Wireless Mouse)" p.47</li> </ul>

Name		Function
21	<b>[Color Mode] button</b>	Each time the button is pressed, the color mode changes. ☛ "Selecting the Projection Quality (Selecting Color Mode)" p.38
22	<b>[LAN] button</b>	Changes to the images projected with EasyMP Network Projection. When projecting using the optional Quick Wireless Connection USB Key, this button switches to that image.
23	<b>[USB] button</b>	Each time the button is pressed, it cycles through the following images: <ul style="list-style-type: none"> <li>USB Display</li> <li>Images from the device connected to the USB(TypeA) port</li> </ul>
24	<b>[Source Search] button</b>	Switches to the image from the input port where video signals are being input. ☛ "Automatically Detect Input Signals and Change the Projected Image (Source Search)" p.29
25	<b>Remote control light-emitting area</b>	Outputs remote control signals.

## Replacing the remote control batteries

If the remote control becomes unresponsive or inoperable after it has been used for some time, the batteries may have reached the end of their service life. When this happens, replace them with new batteries. Obtain two AA size manganese or alkaline batteries. You cannot use other batteries except for the AA size manganese or alkaline.

### Attention

Make sure you read the following manual before handling the batteries.

 [Safety Instructions](#)

### 1 Remove the battery cover.

While pushing the battery cover catch, lift the cover up.

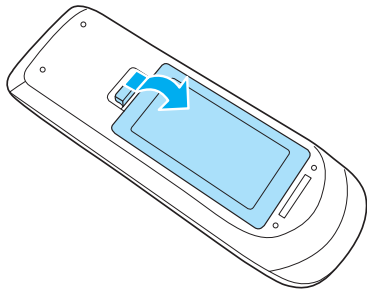

### 2 Replace the old batteries with new batteries.

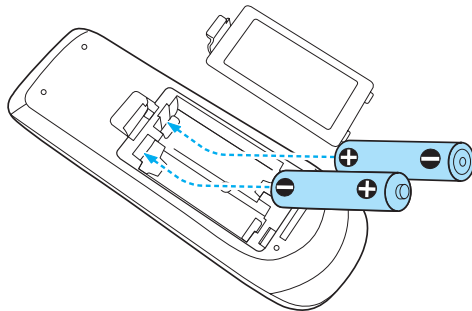

### Caution

Check the positions of the (+) and (-) marks inside the battery holder to ensure the batteries are inserted the correct way.

### 3 Reattach the battery cover.

Press the battery cover until it clicks into place.

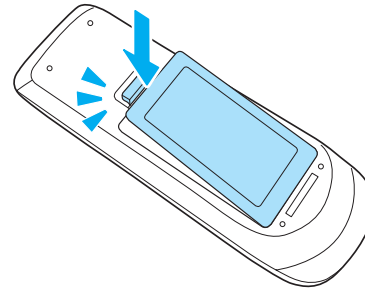

## Remote control operating range

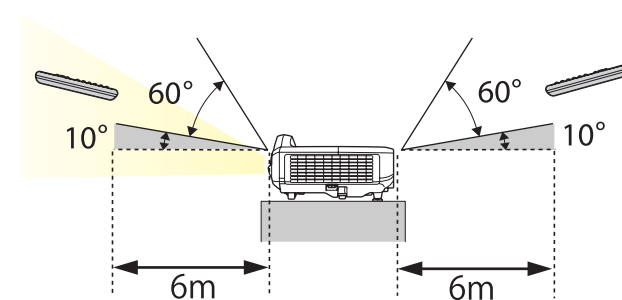
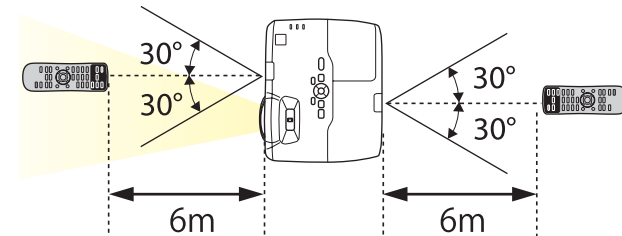



## Preparing the Projector

This chapter explains how to install the projector and connect projection sources.



## Installation Methods

The projector supports the following four different projection methods. Install the projector according to the conditions of the installation location.

- Project images from in front of the screen. (Front projection)

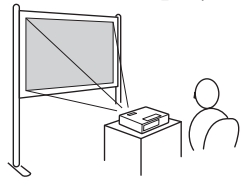

- Project images from behind a translucent screen. (Rear projection)

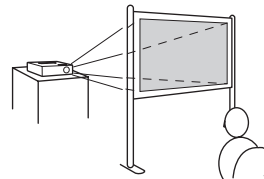

- Suspend the projector from a wall or ceiling and project images from in front of a screen. (Front/Ceiling projection)

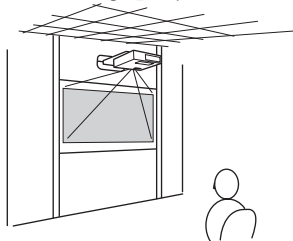

- Suspend the projector from the ceiling and project images from behind a translucent screen. (Rear/Ceiling projection)

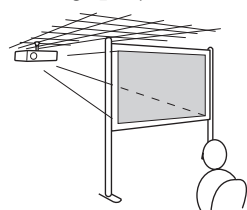

### Warning

- A special method of installation is required when suspending the projector from a wall or ceiling. If it is not installed correctly, it could fall causing an accident and injury.
- If you use adhesives on the wall mount plate fixing points or the ceiling mount fixing points to prevent the screws from loosening, or if you use things such as lubricants or oils on the projector, the projector case may crack causing it to fall from its mount. This could cause serious injury to anyone under the mount and could damage the projector. When installing or adjusting the mount, do not use adhesives to prevent the screws from loosening and do not use lubricant or oil and so on.

### Attention

- Do not use the projector on its side. This may cause malfunctions to occur.
- Do not cover the projector's air intake vent or air exhaust vent. If either of the vents are covered, the internal temperature could rise and cause a fire.



- When installing the projector on a wall or on the ceiling, make sure you use the correct tools for the installation method.
  - ☛ "Optional Accessories" [p.118](#)
- You can change the setting as follows by pressing down the [A/V Mute] button on the remote control for about five seconds.
  - Front ↔ Front/Ceiling**
  - Rear ↔ Rear/Ceiling**
- Set **Rear** or **Rear/Ceiling** from the configuration menu.
  - ☛ **Extended - Projection** [p.64](#)

The port name, location, and connector orientation differ depending on the source being connected.

---

## Connecting a Computer

To project images from a computer, connect the computer using one of the following methods.

① ② **When using the supplied computer cable**

Connect the computer's display output port to the projector's Computer1 or Computer2 port.

You can output audio from the projector's speaker by connecting the computer's audio output port to the projector's Audio1 or Audio2 port using a commercially available audio cable.

③ **When using a commercially available USB cable**

Connect the computer's USB port to the projector's USB(TypeB) port.

You can send the audio with the projected image.

④ **When using a commercially available HDMI cable**

Connect the computer's HDMI port to the projector's HDMI port.

You can send the audio with the projected image.



You can switch the audio input by using **Audio Input**.

☛ **Extended - Operation - Audio Input** [p.64](#)

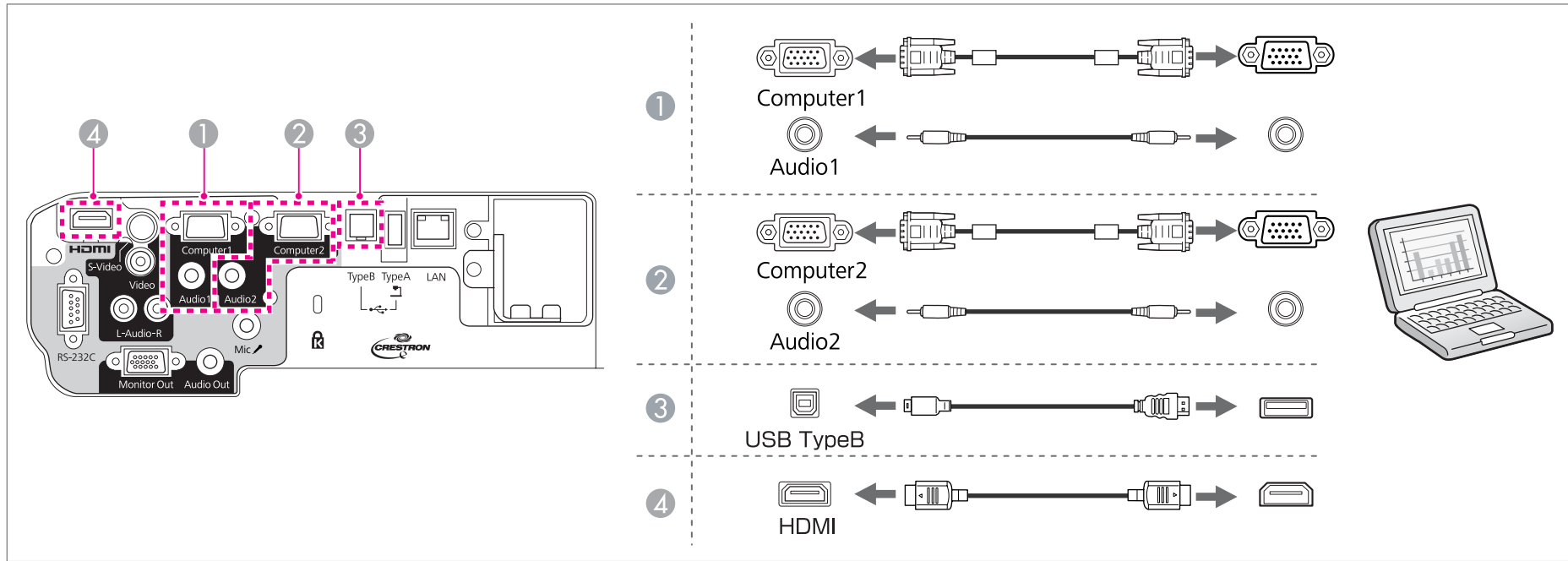

You can use the commercially available USB cable to connect the projector to a computer to project images from the computer. This function is called USB Display.

☛ "Projecting with USB Display" p.30

## Connecting Image Sources

To project images from DVD players or VHS video and so on, connect to the projector using one of the following methods.

**1 When using a commercially available video cable**

Connect the video output port on the image source to the projector's Video port using a commercially available video cable.

You can output audio from the projector's speaker by connecting the audio output port on the image source to the projector's Audio-L/R port using a commercially available audio cable.

**2 When using a commercially available S-video cable**

Connect the video output port on the image source to the projector's S-Video port using a commercially available video cable.

You can output audio from the projector's speaker by connecting the audio output port on the image source to the projector's Audio-L/R port using a commercially available audio cable.

3 4 **When using the optional component video cable**

 "Optional Accessories and Consumables" [p.118](#)

Connect the component output port on the image source to the projector's Computer1 or Computer2 port.

You can output audio from the projector's speaker by connecting the image source's audio output port to the projector's Audio1 or Audio2 port using a commercially available audio cable.

5 **When using a commercially available HDMI cable**

Connect the HDMI port on the image source to the projector's HDMI port using a commercially available HDMI cable.

You can send the audio with the projected image.



You can switch the audio input by using **Audio Input**.

 **Extended - Operation - Audio Input** [p.64](#)

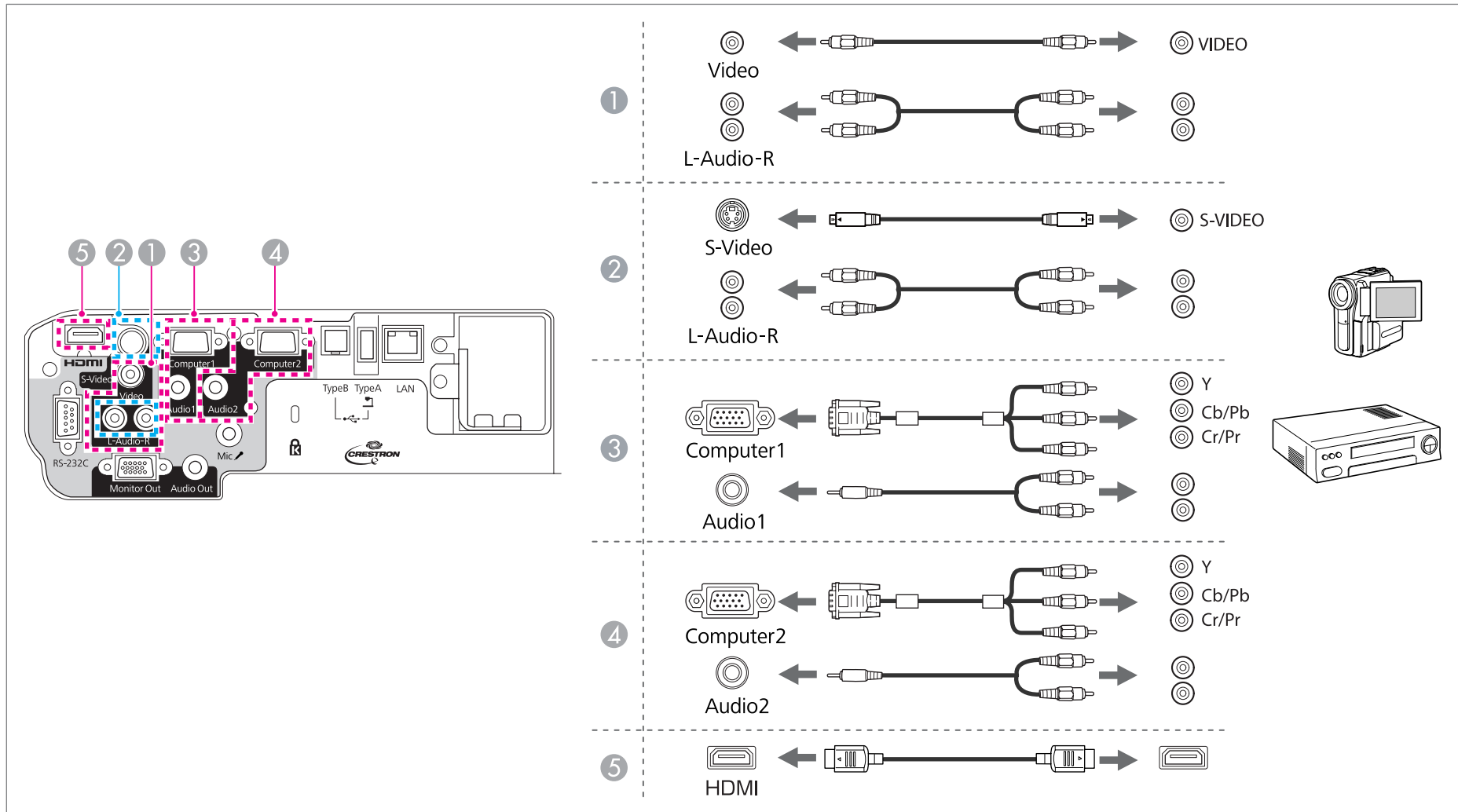

### Attention

- If the input source is on when you connect it to the projector, it could cause a malfunction.
- If the orientation or shape of the plug differs, do not try to force it in. The device could be damaged or could malfunction.



- If the source you want to connect to has an unusually shaped port, use the cable supplied with the device or an optional cable to connect to the projector.
- When using a commercially available 2RCA(L/R)/stereo mini-pin audio cable, make sure it is labeled "No resistance".

## Connecting USB Devices

You can connect devices such as USB memory, the optional Document Camera, and USB compatible hard disks and digital cameras. Using the USB cable supplied with the USB device, connect the USB device to the USB(TypeA) port on the projector.

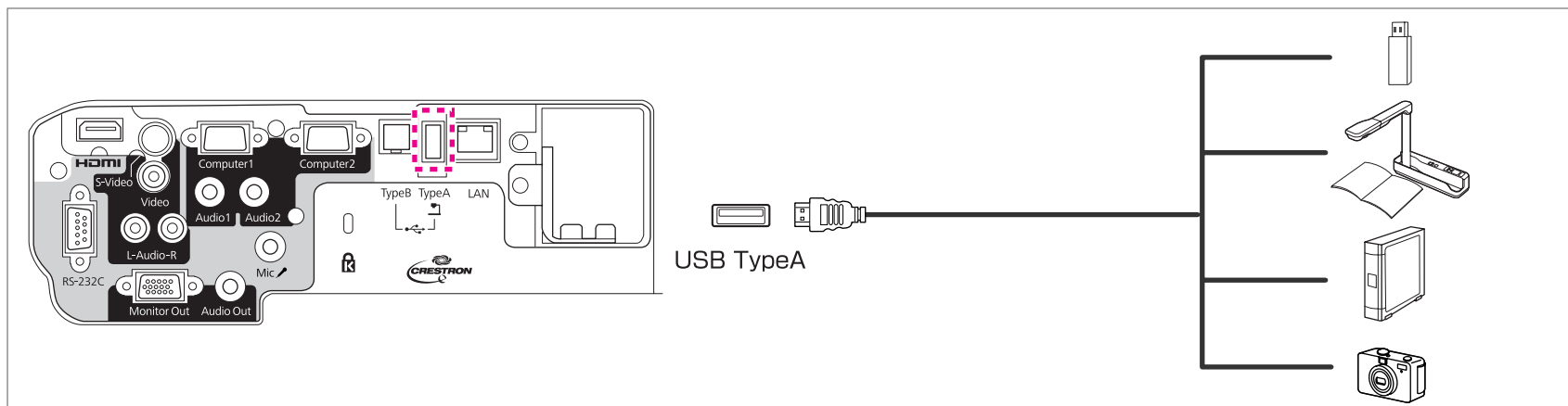

When the USB device is connected, you can project image files on the USB memory or digital camera using Slideshow.

☛ "Slideshow" [p.103](#)

If the Document Camera is connected while projecting images from another input port, press the [USB] button on the remote control, or the [Source Search] button on the control panel, to switch to images from the Document Camera.

☛ "Automatically Detect Input Signals and Change the Projected Image (Source Search)" [p.29](#)



- While projecting images from a USB device, if you want to connect an audio output device, connect it to the Audio2 port.

## Attention

- If you use a USB hub, operation may not be performed correctly. Devices such as digital cameras and USB devices should be connected to the projector directly.
- When connecting and using a USB-compatible hard disk, make sure you connect the AC adaptor supplied with the hard disk.
- Connect a digital camera or hard disk to the projector using a USB cable supplied with or specified for use with the device.
- Use a USB cable less than 3 m in length. If the cable exceeds 3 m, Slideshow may not function correctly.

## Removing USB devices

After finishing projecting, remove USB devices from the projector. For devices such as digital cameras or hard disks, turn off the device and then remove it from the projector.

## Connecting a microphone

You can output microphone audio from the projector's speaker by connecting a commercially available dynamic microphone.

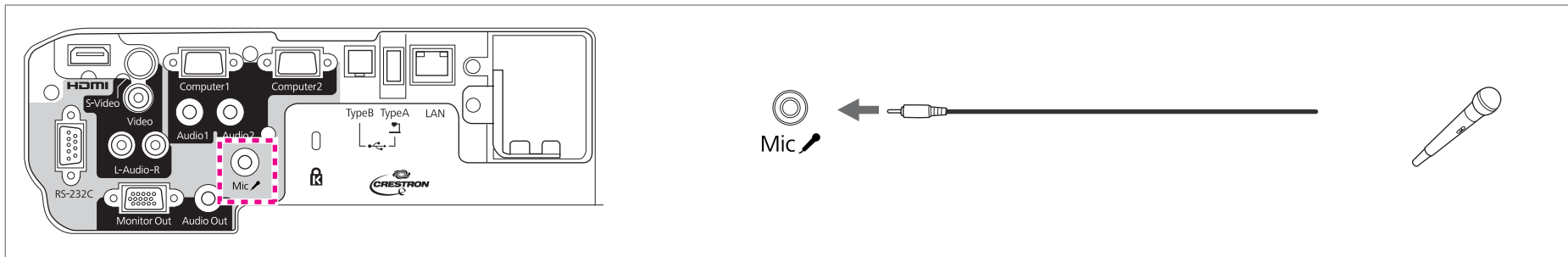

- Plug-in-power is not supported.
- Adjust **Mic Input Level** if the microphone audio is difficult to hear, or if it is too loud resulting in a crackling sound.  
 🖱️ **Settings - Mic Input Level** [p.63](#)
- Make the following settings to output audio from a microphone when the projector is turned off.  
 Set **Standby Mode** to **Communication On**. 🖱️ **Extended - Standby Mode** [p.64](#)  
 Set **Standby Microphone** to **On**. 🖱️ **Extended - Standby Microphone** [p.64](#)

## Connecting External Equipment

You can output images and audio by connecting an external monitor or speaker.

① **When outputting images to an external monitor**

Connect the external monitor to the projector's Monitor Out port using the cable supplied with the external monitor.

② **When outputting audio to an external speaker**

Connect the external speaker to the projector's Audio Out port using a commercially available audio cable.

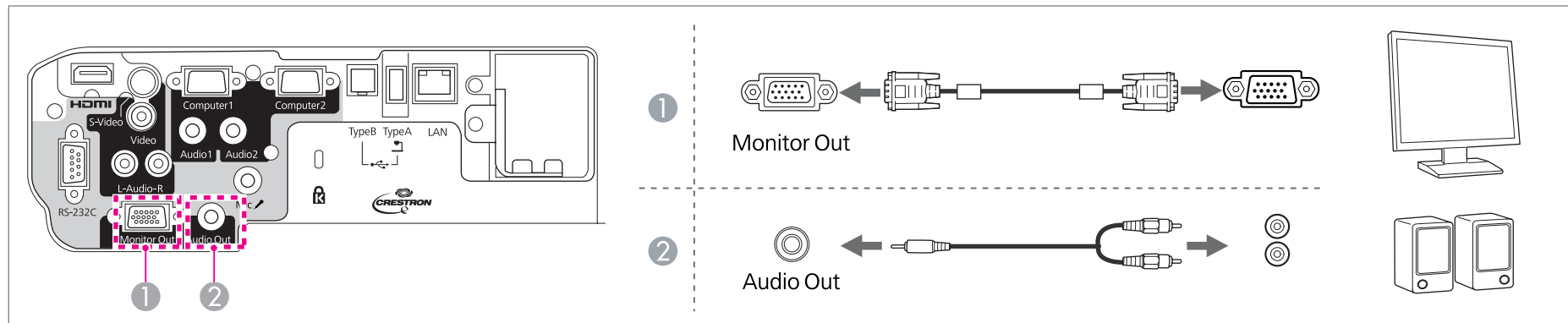

• If you set **Standby Mode** to **Communication On**, you can output images to an external monitor even if the projector is in standby mode.

☛ **Extended - Standby Mode** [p.64](#)

- Only analog RGB signals from the Computer1 port can be output to an external monitor. You cannot output signals input from other ports or component video signals.
- Setting gauges for functions such as Keystone, Configuration menu, or Help screens are not output to the external monitor.
- When the audio cable jack is inserted into the Audio Out port, audio stops being output from the projector's built-in speakers and switches to external output.

## Connecting a LAN Cable

Connect a LAN port on network hubs or other equipment to the projector's LAN port with a commercially available 100BASE-TX or 10BASE-T LAN cable.



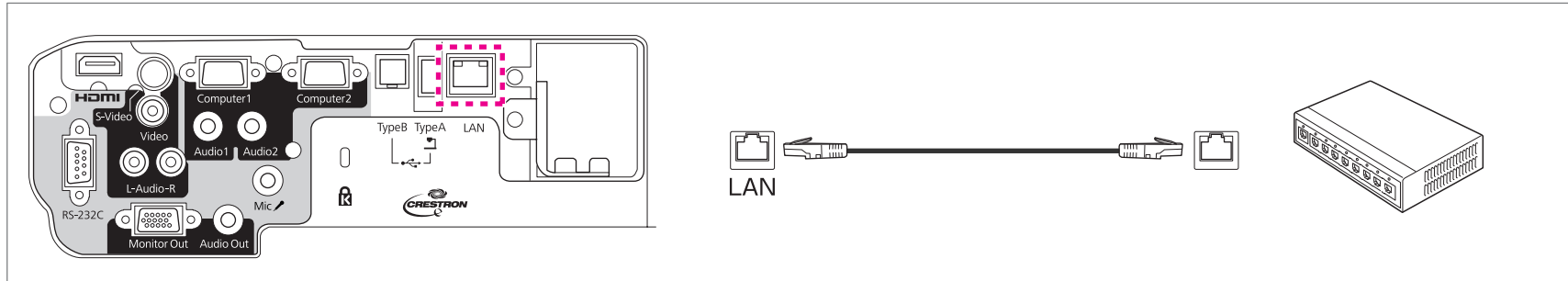

To prevent malfunctions, use a category 5 shielded LAN cable.

## Installing the Optional Wireless LAN Unit

- 1** Remove the stopper fixing screw, and then remove the wireless LAN unit's stopper.

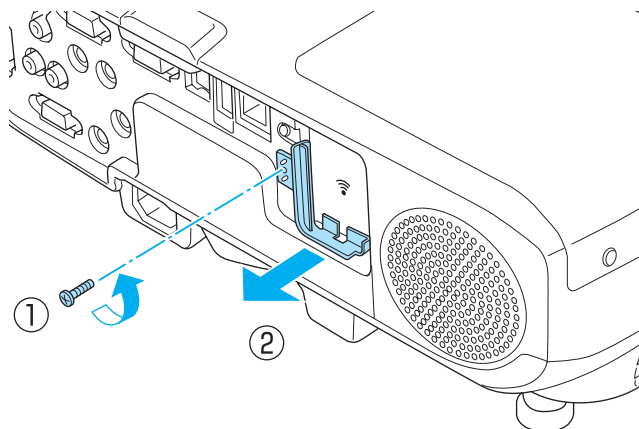

- 2** Install the Wireless LAN unit.

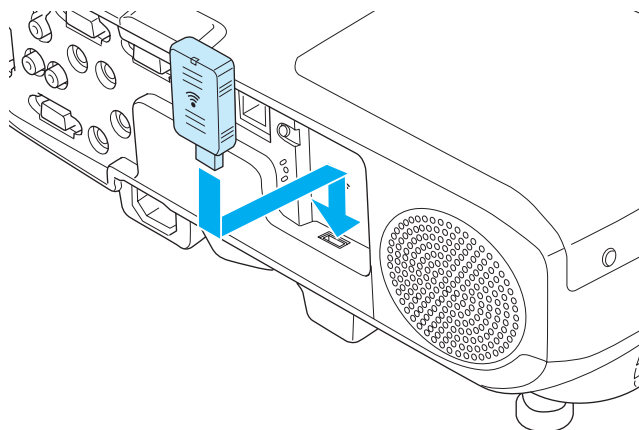

- 3** To avoid losing the wireless LAN unit, secure the stopper using the stopper fixing screw.

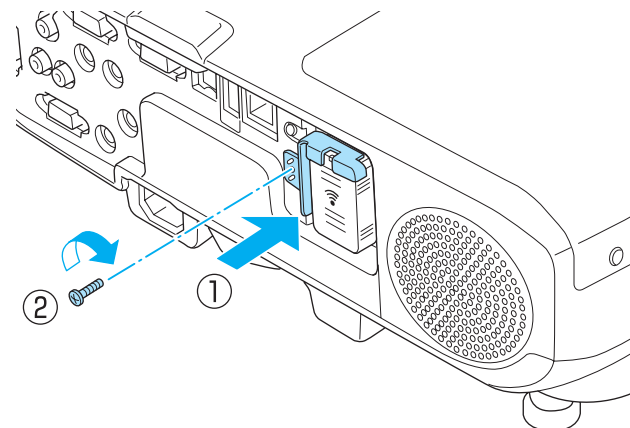



## Basic Usage

This chapter explains how to project and adjust images.

## From Installation to Projection

This section explains the procedure for connecting the projector to a computer with the computer cable and projecting images.

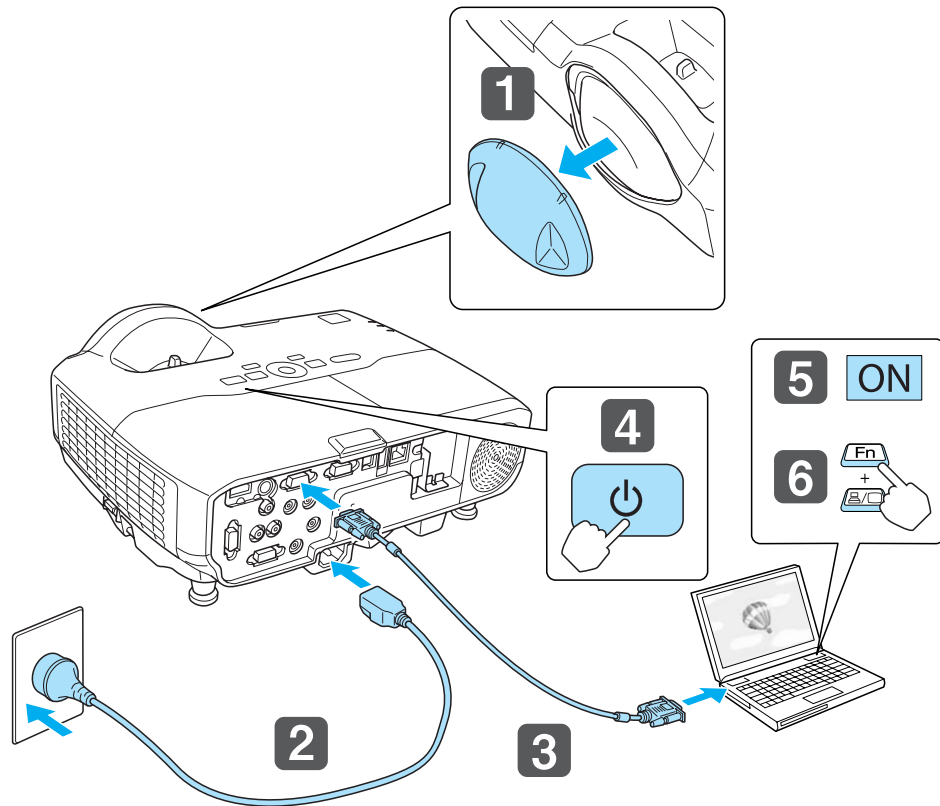

- 1** Remove the lens cover.
- 2** Connect the projector to an electrical outlet with the power cable.
- 3** Connect the projector to the computer with the computer cable.
- 4** Turn on the projector.

**5** Turn on the computer.

**6** Change the computer's screen output.

When using a laptop computer, you need to change the screen output from the computer.

Hold down the Fn key (function key), and press the  key.



The method for changing differs depending on the computer being used. See the documentation supplied with the computer.

If the image is not projected, you can change the projected image using one of the following methods.

- Press the [Source Search] button on the control panel or the remote control.
  - "Automatically Detect Input Signals and Change the Projected Image (Source Search)" [p.29](#)
- Press the button for the target port on the remote control.
  - "Switching to the Target Image Using the Remote Control" [p.30](#)



After projecting the image, adjust the image if necessary.

➤ "Correcting Keystone Distortion" [p.34](#)

➤ "Correcting the Focus" [p.38](#)

## Automatically Detect Input Signals and Change the Projected Image (Source Search)

Press the [Source Search] button to project images from the port currently receiving an image.

Because only images from ports receiving an image are projected, you can quickly project the image you want.

### Using Remote Control

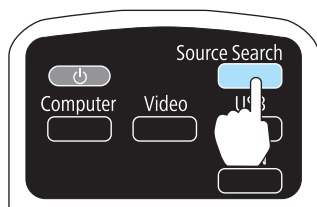

### Using the Control Panel

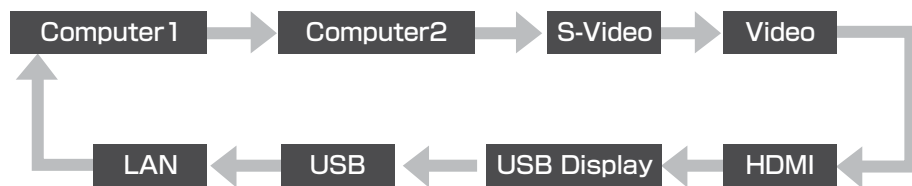
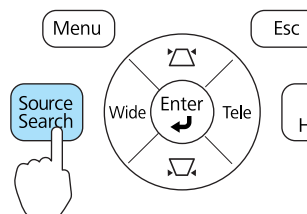

When two or more image sources are connected, press the [Source Search] button until the target image is projected.

When your video equipment is connected, start playback before beginning this operation.



The following screen is displayed while no image signals are input.

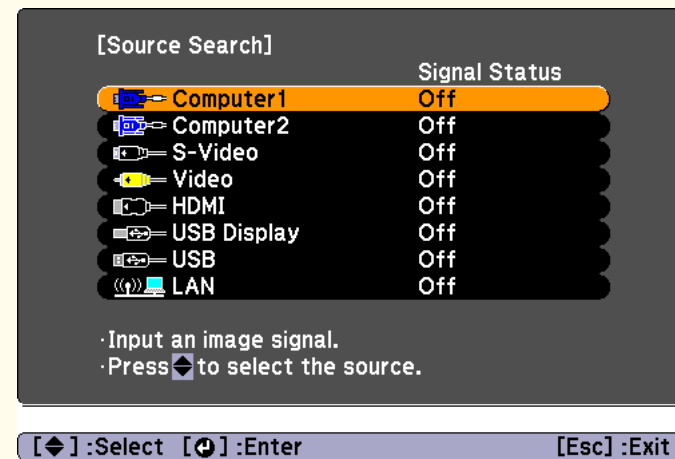

## Switching to the Target Image Using the Remote Control

You can change directly to the target image by pressing the following buttons on the remote control.

Remote control

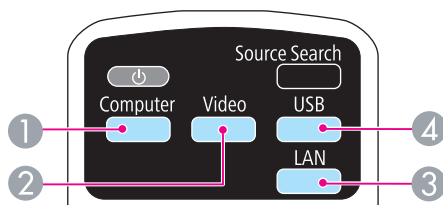

- ① Each time the button is pressed, it cycles through the following images:
  - Computer1 port
  - Computer2 port
- ② Each time the button is pressed, it cycles through the following images:
  - S-Video port
  - Video port
  - HDMI port
- ③ Changes to the images projected with EasyMP Network Projection. When projecting using the optional Quick Wireless Connection USB Key, this button switches to that image.
- ④ Each time the button is pressed, it cycles through the following images:
  - USB Display
  - Images from the device connected to the USB(TypeA) port

## Projecting with USB Display

You can use the commercially available USB cable to connect the projector to a computer to project images from the computer.

You can send the computer's audio with the projected image.

## System requirements

### For Windows

<b>OS</b>	Windows 2000*1	
	Windows XP*2	Professional 32 bit, Home Edition 32 bit, Tablet PC Edition 32 bit
	Windows Vista	Ultimate 32 bit, Enterprise 32 bit, Business 32 bit, Home Premium 32 bit, Home Basic 32 bit
	Windows 7	Ultimate 32/64 bit, Enterprise 32/64 bit, Professional 32/64 bit, Home Premium 32/64 bit, Home Basic 32 bit, Starter 32 bit
<b>CPU</b>	Mobile Pentium III 1.2 GHz or faster Recommended: Pentium M 1.6 GHz or faster	
<b>Amount of Memory</b>	256 MB or more Recommended: 512 MB or more	
<b>Hard Disk Free Space</b>	20 MB or more	
<b>Display</b>	Resolution of no less than 640x480 and no higher than 1600x1200. Display color of 16-bit color or greater	

\*1 Service Pack 4 only

\*2 Except for Service Pack 1

**For Mac OS**

<b>OS</b>	Mac OS X 10.5.1 or later Mac OS X 10.6.x
<b>CPU</b>	Power PC G4 1GHz or faster Recommended: Core Duo 1.83GHz or faster
<b>Amount of Memory</b>	512 MB or more
<b>Hard Disk Free Space</b>	20 MB or more
<b>Display</b>	Resolution of no less than 640x480 and no higher than 1680x1200. Display color of 16-bit color or greater

**Connecting for the first time**

The first time you connect the projector and the computer using the USB cable, the driver needs to be installed. The procedure is different for Windows and Mac OS.



- You do not need to install the driver the next time you connect.
- When inputting images from multiple sources, change the input source to USB Display.
- If you use a USB hub, operation may not be performed correctly. Connect the USB cable directly to the projector.

**For Windows**

- 1** Connect the computer's USB port to the projector's USB(TypeB) port using a commercially available USB cable.



For Windows 2000 or Windows XP, a message asking you if you want to restart your computer may be displayed. Select **No**.

**For Windows 2000**

Double-click **Computer**, **EPSON PJ\_UD**, and then **EMP\_UDSE.EXE**.

**For Windows XP**

Driver installation starts automatically.

**For Windows Vista/Windows 7**

When the dialog box is displayed, click **Run EMP\_UDSE.exe**.

- 2** When the License Agreement screen is displayed, click **Agree**.

- 3** Computer images are projected.  
It may take a while for computer images to be projected. Until the computer images are projected, leave the equipment as is and do not disconnect the USB cable or turn off the power of the projector.
- 4** Disconnect the USB cable when you are finished.  
When disconnecting the USB cable, there is no need to use **Safely Remove Hardware**.



- If it is not installed automatically, double-click **My Computer - EPSON\_PJ\_UD - EMP\_UDSE.EXE** on your computer.
- If nothing is projected for some reason, click **All Programs - EPSON Projector - Epson USB Display - Epson USB Display Vx.xx** on your computer.
- When using a computer running Windows 2000 under user authority, a Windows error message is displayed and you may not be able to use the software. In this case, try updating Windows to the latest version, restart, and then try to connect again.  
For more details, contact your local dealer or the nearest address provided in the following document.  
 [Epson Projector Contact List](#)

#### For Mac OS

- 1** Connect the computer's USB port to the projector's USB(TypeB) port using a commercially available USB cable.  
The Setup folder of USB Display is displayed in the Finder.
- 2** Double-click the **USB Display Installer** icon.
- 3** Follow the on-screen instructions to install.

- 4** When the License Agreement screen is displayed, click **Agree**.  
Enter the administrator authority password and start the installation.  
When the installation is complete, the USB Display icon is displayed in the Dock and menu bar.
- 5** Computer images are projected.  
It may take a while for computer images to be projected. Until the computer images are projected, leave the equipment as is and do not disconnect the USB cable or turn off the power of the projector.
- 6** When you have finished, select **Disconnect** from the menu bar or from the **USB Display** icon on the Dock. You can then disconnect the USB cable.



- If the USB Display setup folder is not displayed automatically in the Finder, double-click **EPSON PJ\_UD - USB Display Installer** on your computer.
- If nothing is projected for some reason, click the **USB Display** icon in the Dock.
- If there is no **USB Display** icon in the Dock, double-click **USB Display** from the Applications folder.
- If you select **Exit** from the **USB Display** icon menu on the Dock, USB Display does not start automatically when you connect the USB cable.

#### Uninstalling

##### For Windows 2000

- 1** Click **Start**, select **Settings**, and then click **Control Panel**.
- 2** Double-click **Add/Remove Programs**.
- 3** Click **Change or Remove Programs**.
- 4** Select **Epson USB Display** and click **Change/Remove**.



## For Windows XP

- 1 Click **Start**, and then click **Control Panel**.
- 2 Double-click **Add or Remove Programs**.
- 3 Select **Epson USB Display** and click **Remove**.

## For Windows Vista/Windows 7

- 1 Click **Start**, and then click **Control Panel**.
- 2 Click **Uninstall a program** under **Programs**.
- 3 Select **Epson USB Display** and click **Uninstall**.

## For Mac OS

- 1 Open the **Applications** folder, double-click **USB Display**, and then double-click **Tool**.
- 2 Run **USB Display Uninstaller**.

## Correcting Keystone Distortion

You can correct keystone distortion using one of the following methods.

- H/V-Keystone  
Manually correct distortion in the horizontal and vertical directions independently.

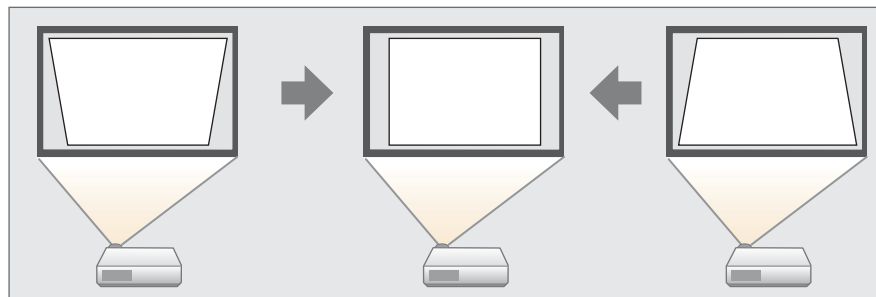

- Quick Corner  
Manually correct the four corners independently.

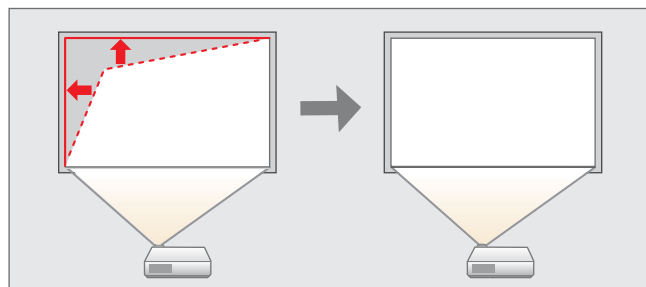

When you correct keystone distortion, the projected image may be reduced.

## H/V-Keystone

Manually correct distortion in the horizontal and vertical directions independently. H/V-Keystone correction is ideal for fine-tuning keystone distortion.

You can use H/V-Keystone to correct the projected image under the following conditions.

Correction angle: approx 15° right and left/approx. 15° up and down

- 1 Press the [↖] or [↗] buttons on the control panel during projection to display the Keystone screen.

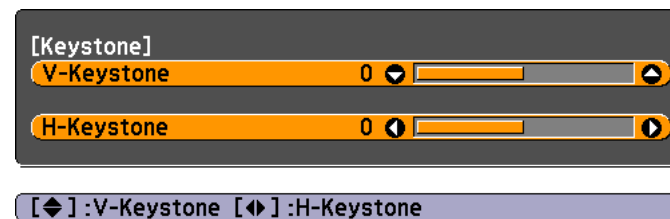

- 2 Press the following buttons to correct keystone distortion. Press the [↕] or [↔] buttons to correct vertical distortion.

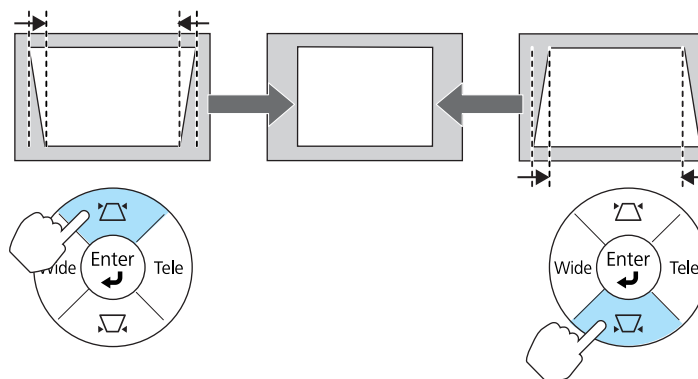

Press the [Tele] or [Wide] buttons to correct horizontal distortion.

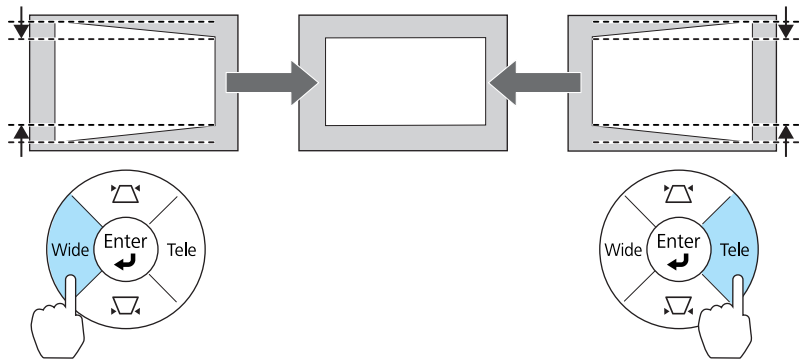

 You can set H/V-Keystone from the Configuration menu.  
 Settings - Keystone - H/V-Keystone p.63

## Quick Corner

This allows you to manually correct each of the four corners of the projected image separately.

**1** Press the [Menu] button while projecting.

 "Using the Configuration Menu" p.57

### Using Remote Control

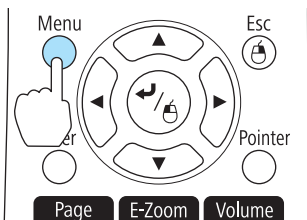

### Using the Control Panel

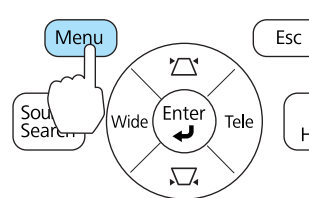



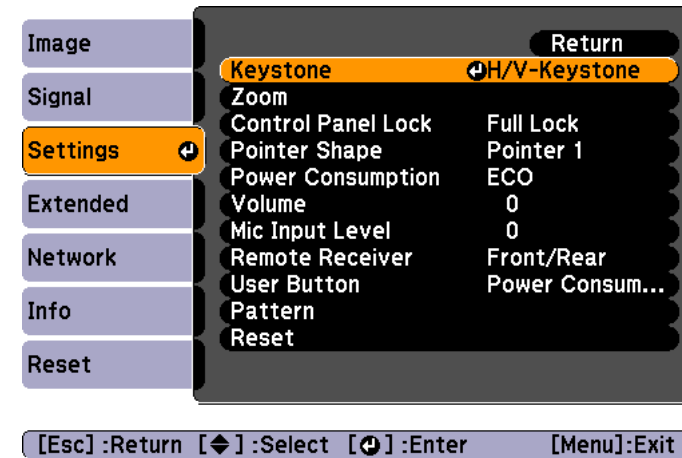

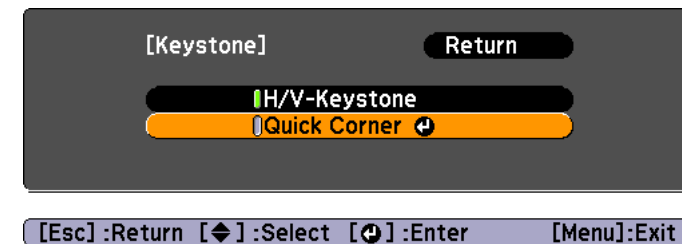

**2** Select **Keystone** from **Settings**.



**3** Select **Quick Corner**, and then press the [] button.



**4** Using the [], [], [], and [] buttons on the remote control, or the [], [], [Wide], and [Tele] buttons on the control panel, select the corner to correct, and then press the [] button.

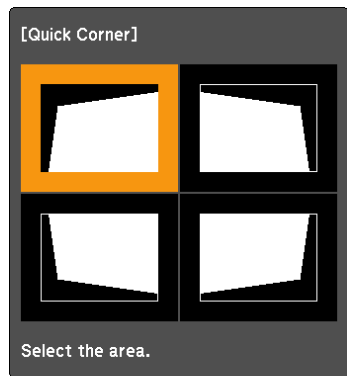

[◀ / ▶] : Select  
 [Enter] : Enter  
 [Esc] : Return (press for 2 seconds to reset/switch)

- 5** Using the [↶], [↷], [↵], and [↷] buttons on the remote control, or the [↶], [↷], [Wide], and [Tele] buttons on the control panel, correct the position of the corner.
- When you press the [↵] button, the screen shown in step 4 is displayed.
- If the message "Cannot adjust any further." is displayed while adjusting, you cannot adjust the shape any further in the direction indicated by the gray triangle.

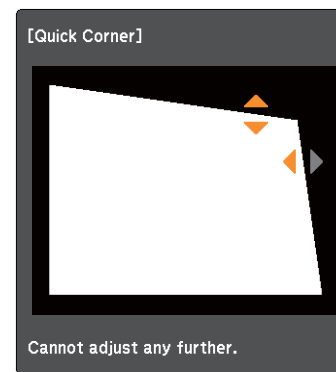

- 6** Repeat procedures 4 and 5 as needed to adjust any remaining corners.
- 7** When you are done, press the [Esc] button to exit the correction menu.
- Because **Keystone** was changed to **Quick Corner**, the corner selection screen from step 4 is displayed when you press the [↶] and [↷] buttons on the control panel next time. Change **Keystone** to **H/V-Keystone** if you want to perform horizontal and vertical correction using the [↶] and [↷] buttons on the control panel.
- ☛ **Settings - Keystone - H/V-Keystone p.63**



If the [Esc] button is held down for about two seconds while the corner selection screen from step 4 is displayed, the following screen is displayed.

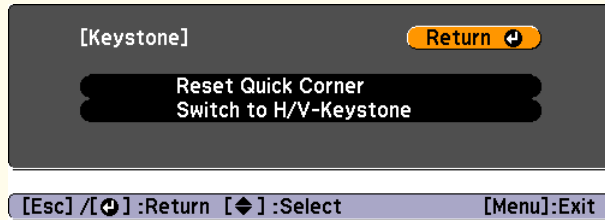

**Reset Quick Corner:** Resets the result of Quick Corner corrections.  
**Switch to H/V-Keystone:** Switches the correction method to H/V-Keystone.  
 🖱️ "Settings Menu" [p.63](#)

## Adjusting the Image Position

Press the foot lever to extend and retract the front foot. You can adjust the position of the image by tilting the projector up to 10 degrees.

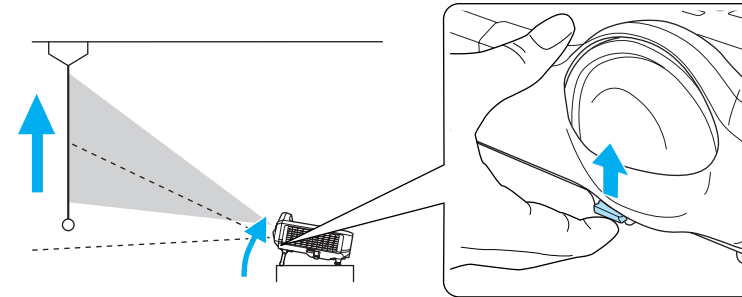

The larger the angle of tilt, the harder it becomes to focus. Install the projector so that it only needs to be tilted at a small angle.

## Adjusting the Image Size

Press the [Wide] and [Tele] buttons on the control panel to adjust the size of the projected image.

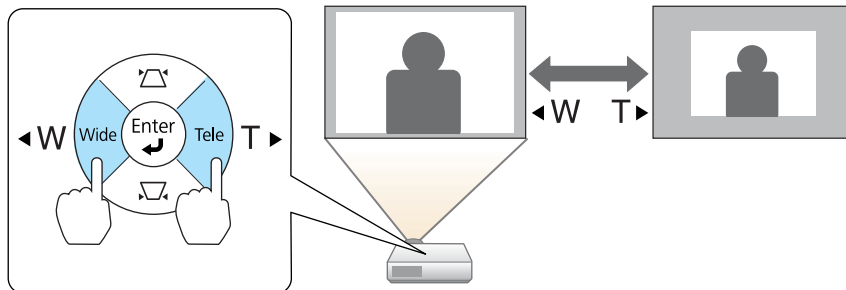

You can also make adjustments from the configuration menu.

🖱️ [Settings - Zoom p.63](#)

## Adjusting the Horizontal Tilt

Extend and retract the rear feet to adjust the projector's horizontal tilt.

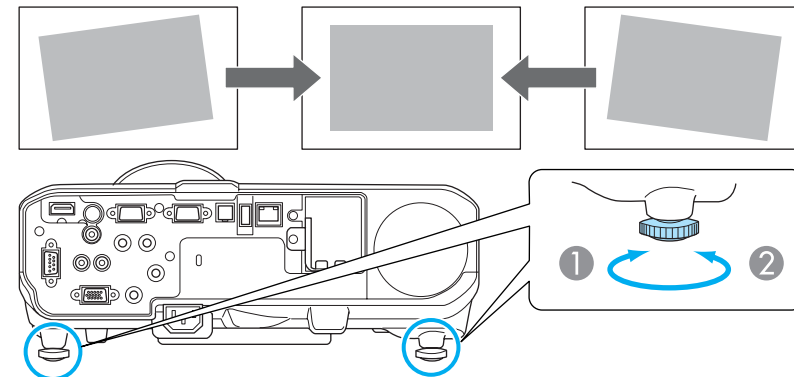

① Extend the rear foot.

- ② Retract the rear foot.

## Correcting the Focus

You can correct the focus using the focus ring.

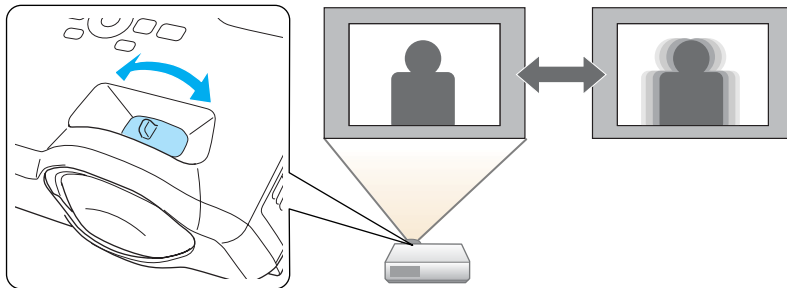

## Adjusting the Volume

You can adjust the volume using one of the following methods.

- Press the [Volume] buttons on the remote control to adjust the volume.
  - [🔊] Decreases the volume.
  - [🔊] Increases the volume.

### Remote control

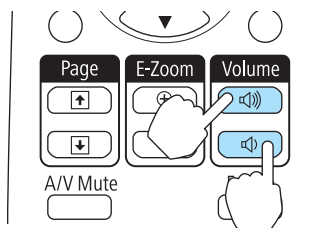

- Adjust the volume from the Configuration menu.
  - ☛ Settings - Volume p.63

### ⚠ Caution

Do not start when the volume is set too high. A sudden increase in volume may cause loss of hearing. Always lower the volume before powering off, so that you can power on and then gradually increase the volume.

## Selecting the Projection Quality (Selecting Color Mode)

You can easily obtain the optimum image quality simply by selecting the setting that best corresponds to your surroundings when projecting. The brightness of the image varies depending on the mode selected.

Mode	Application
<b>Dynamic</b>	Ideal for use in a bright room. This is the brightest mode, and reproduces shadow tones well.
<b>Presentation</b>	Ideal for making presentations using color materials in a bright room.
<b>Theatre</b>	Ideal for watching films in a dark room. Gives images a natural tone.
<b>Photo*1</b>	Ideal for projecting still pictures, such as photos, in a bright room. The images are vivid and brought into contrast.
<b>Sports*2</b>	Ideal for watching TV programmes in a bright room. The images are vivid and brought to life.
<b>sRGB</b>	Ideal for images that conform to the <u>sRGB</u> color standard.

Mode	Application
<b>Blackboard</b>	Even if you are projecting onto a blackboard (greenboard), this setting gives your images a natural tint, just like when projecting onto a screen.
<b>Whiteboard</b>	Ideal for making presentations using a whiteboard.

- \*1 This selection is only available when the input signal is RGB or when the source is USB Display, USB, or LAN.
- \*2 This can be selected when inputting component video signals, S-video signals, or composite video signals.

Each time you press the [Color Mode] button, the Color Mode name is displayed on the screen and the Color Mode changes.

### Remote control

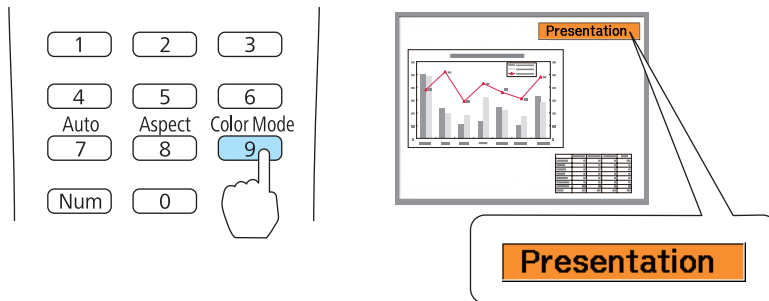

You can set Color Mode from the Configuration menu.  
**Image - Color Mode** p.60

## Setting Auto Iris

By automatically setting the luminance according to the brightness of the displayed image, it lets you enjoy deep and rich images.

**1** Press the [Menu] button.

"Using the Configuration Menu" p.57

### Using Remote Control

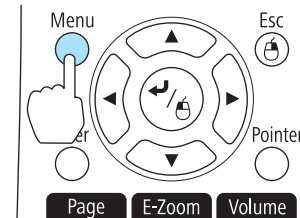

### Using the Control Panel

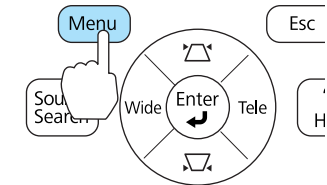

**2** Select **Auto Iris** from **Image**.

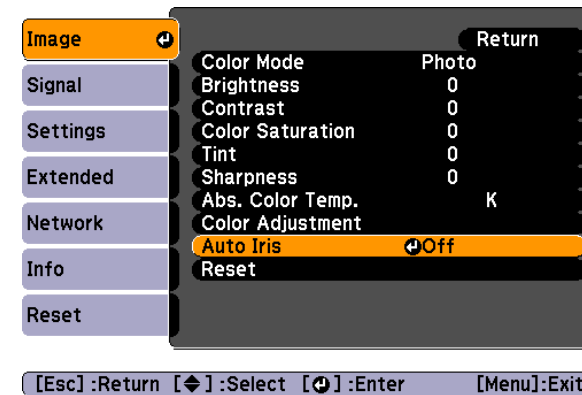

**3** Select **On**.

The setting is stored for each Color Mode.

**4** Press the [Menu] button to finish making settings.

Auto Iris can only be set when the **Color Mode** is set to **Dynamic** or **Theatre**.

## Changing the Aspect Ratio of the Projected Image

You can change the Aspect Ratio of the projected image to suit the type, the ratio of height and width, and the resolution of the input signals.

Available Aspect Modes vary depending on the image signal currently being projected.

### Changing methods

Each time you press the [Aspect] button, the Aspect Mode name is displayed on the screen and the aspect ratio changes.

#### Remote control

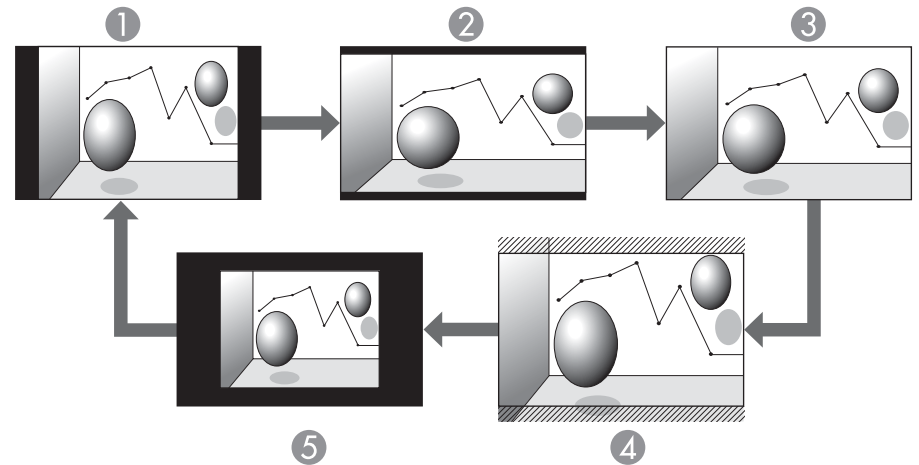
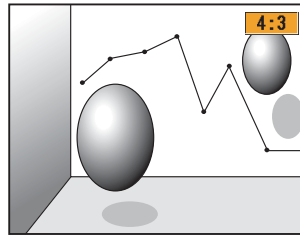
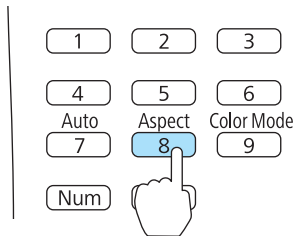

- ① Normal or Auto
- ② 16:9
- ③ Full
- ④ Zoom
- ⑤ Native

You can set the aspect ratio from the Configuration menu.  
 ➔ **Signal - Aspect p.61**

## Changing the aspect mode (EB-435W/EB-425W only)

Projecting images from video equipment or from the HDMI port

Each time the [Aspect] button on the remote control is pressed, the aspect mode changes in the order **Normal or Auto**, **16:9**, **Full**, **Zoom**, and **Native**.

Example: 1080p signal input (resolution: 1920x1080, aspect ratio: 16:9)

### Projecting images from a computer

The following shows projection examples for each aspect mode.

Aspect mode	Input Signal	
	XGA 1024X768(4:3)	WXGA 1280X800(16:10)
Normal		



Aspect mode	Input Signal	
	XGA 1024X768(4:3)	WXGA 1280X800(16:10)
<b>16:9</b>		
<b>Full</b>		
<b>Zoom</b>		
<b>Native</b>		



If parts of the image are missing, set the **Resolution** setting to **Wide** or **Normal** from the Configuration menu, according to the size of the computer panel.

☞ **Signal - Resolution** [p.61](#)

## Changing the aspect mode (EB-430/EB-420 only)

Projecting images from video equipment

Each time the [Aspect] button on the remote control is pressed, the aspect mode changes in the order **4:3** and **16:9**.

When inputting a 720p/1080i signal and the aspect mode is set to **4:3**, a 4:3 zoom is applied (the right and left sides of the image are cut off).

Example: 720p signal input (resolution: 1280x720, aspect ratio: 16:9)

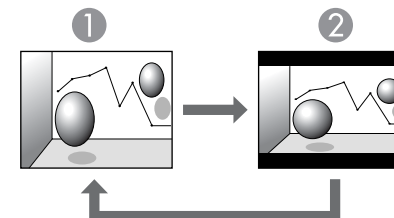

- ① 4:3
- ② 16:9

Projecting images from the HDMI port

Each time the [Aspect] button on the remote control is pressed, the aspect mode changes in the order **Auto**, **4:3**, and **16:9**.

Example: 1080p signal input (resolution: 1920x1080, aspect ratio: 16:9)

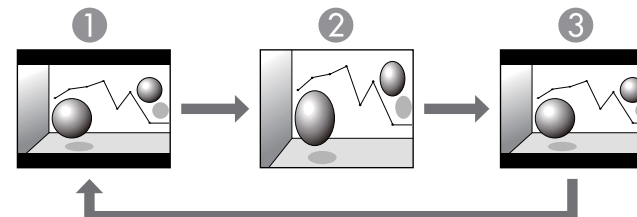

- ① Auto

- ② 4:3
- ③ 16:9

Projecting images from a computer

Each time the [Aspect] button on the remote control is pressed, the aspect mode changes in the order **Normal**, **4:3**, and **16:9**.

The following shows projection examples for each aspect mode.

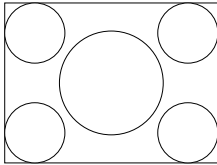
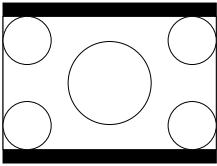
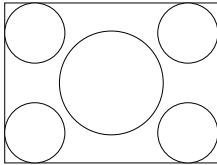
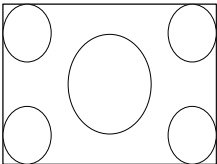
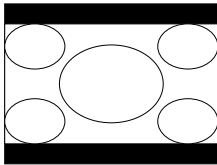
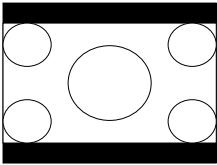
Aspect mode	Input Signal	
	XGA 1024X768(4:3)	WXGA 1280X800(16:10)
<b>Normal</b>		
<b>4:3</b>		
<b>16:9</b>		



If parts of the image are missing, set the **Resolution** setting to **Wide** or **Normal** from the Configuration menu, according to the size of the computer panel.

☞ **Signal - Resolution** [p.61](#)



# Useful Functions

This chapter explains useful functions for giving presentations and so on, and the security functions.

## Hiding the Image and Sound Temporarily (A/V Mute)

You can use this when you want to focus the audience's attention on what you are saying, or if you do not want to show details such as when you are changing between files during presentations from a computer.

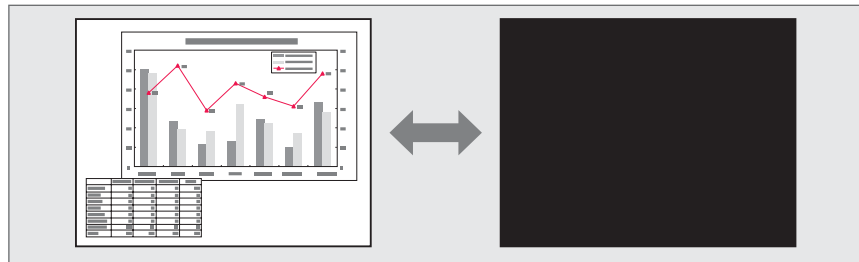

Each time you press the [A/V Mute] button, A/V Mute turns on or off.

### Remote control

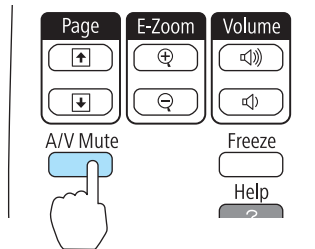

- If you use this function when projecting moving images, the images and sound continue to be played back by the source, and you cannot return to the point where A/V Mute was activated.
- Microphone audio is still output even when A/V Mute is turned on.
- You can select the screen displayed when the [A/V Mute] button is pressed from the Configuration menu.
  - **Extended - Display - A/V Mute** [p.64](#)
- The lamp is still lit during A/V Mute, so the lamp hours continue to accumulate.

## Freezing the Image (Freeze)

When Freeze is activated on moving images, the frozen image continues to project on the screen, so you can project a moving image one frame at a time like a still photo. Also, you can perform operations such as changing between files during presentations from a computer without projecting any images if the Freeze function is activated beforehand.

Each time you press the [Freeze] button, Freeze turns on or off.

### Remote control

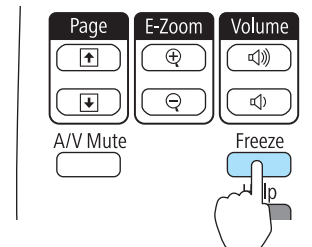



- Audio does not stop.
- For moving images, the images continue to play back while the screen is frozen, so it is not possible to resume projection from the point where the screen was frozen.
- If the [Freeze] button is pressed while the Configuration menu or the Help screen is displayed, the menu or the Help screen that is displayed is closed.
- Freeze still works while E-Zoom is being used.

## Pointer Function (Pointer)

This allows you to move a pointer icon on the projected image, and helps you draw attention to the area you are talking about.



### 1 Display the Pointer.

Each time you press the [Pointer] button, the pointer appears or disappears.



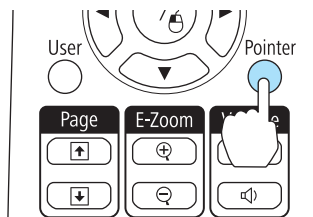

#### Remote control

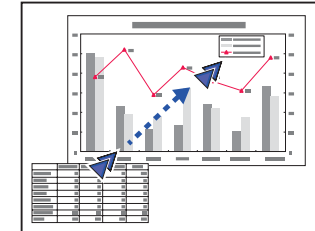
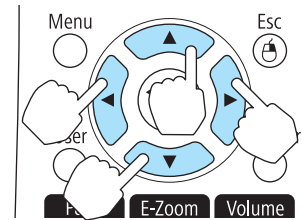

### 2 Move the Pointer icon (↗).

#### Remote control



When any pair of adjacent [, [, [, or [] buttons are pressed at the same time, the pointer can be moved diagonally.



You can select the shape of the pointer icon from the Configuration menu.

🖱️ **Settings - Pointer Shape** p.63

## Enlarging Part of the Image (E-Zoom)

This is useful when you want to expand images to see them in greater detail, such as graphs and tables.

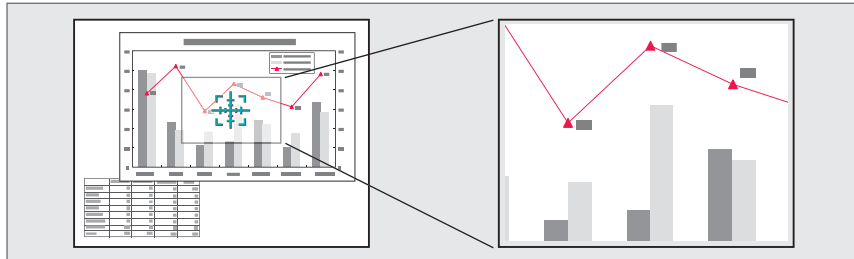

### 1 Start E-Zoom.

Press the [⊕] button to display the Cross (⊕).

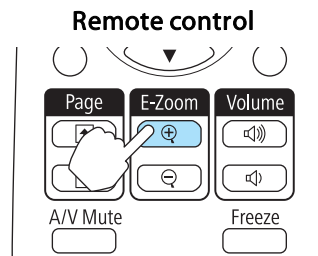

### 2 Move the Cross (⊕) to the area of the image that you want to enlarge.

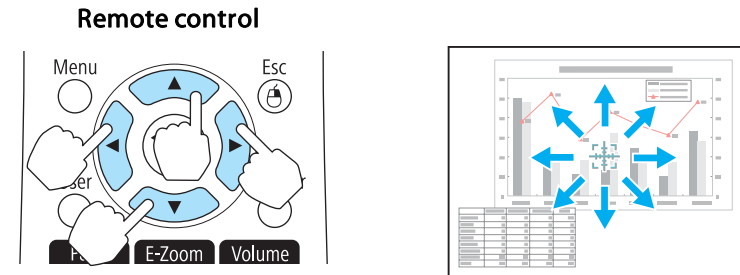

When any pair of adjacent [⬆], [⬇], [⬅], or [➤] buttons are pressed at the same time, the pointer can be moved diagonally.

### 3 Enlarge.

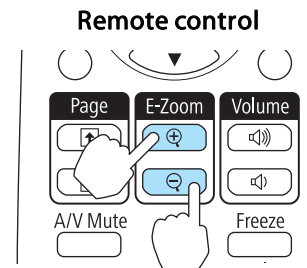

[⊕] button: Expands the area each time it is pressed. You can expand quickly by holding the button down.

[⊖] button: Reduces images that have been enlarged.

[Esc] button: Cancels E-Zoom.



- The enlargement ratio appears on the screen. The selected area can be enlarged to between 1 to 4 times in 25 incremental steps.
- During enlarged projection, press the [⬆], [⬇], [⬅], and [➤] buttons to scroll the image.

## Using the Remote Control to Operate the Mouse Pointer (Wireless Mouse)

When the USB port of a computer and the USB(TypeB) port on the projector are connected with a commercially available USB cable, you can use the remote control to control the computer's mouse pointer.

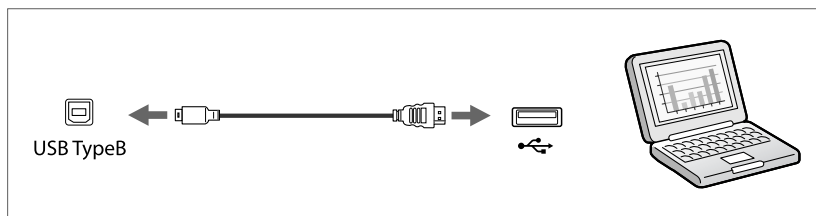

This is available when projecting images from a computer connected to the Computer1, Computer2, or HDMI ports. This is also available when projecting in USB Display.

The following operating systems are compatible with Wireless Mouse.

	Windows	Mac OS
OS	Windows 98 Windows 98SE Windows Me Windows 2000 Windows XP Windows Vista Windows 7	Mac OS X 10.3.x Mac OS X 10.4.x Mac OS X 10.5.x Mac OS X 10.6.x

It may not be possible to use the Wireless Mouse function under some versions of the operating systems.

Once the connection has been made, the mouse pointer can be operated as follows.

### Moving the mouse pointer

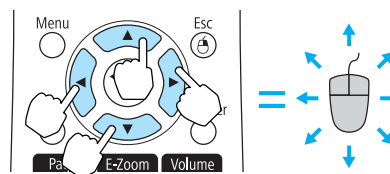

[Up] [Down] [Left] [Right] buttons:  
Moves the mouse pointer.

### Mouse clicks

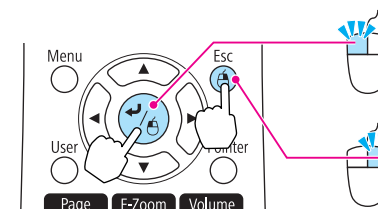

[Double Click] button: Left click. Press quickly twice to double-click.  
[Esc] button: Right click.

### Drag and drop

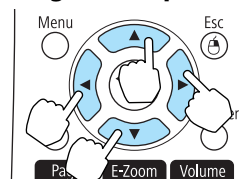

While holding down the [Left Click] button, press the [Up], [Down], [Left], and [Right] buttons.  
Release the [Left Click] button to drop at the desired location.

### Page Up/Down

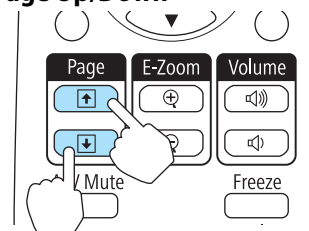

[Page Up] button: Moves to the previous page.  
[Page Down] button: Moves to the next page.



- When any pair of adjacent [▲], [▼], [◀], or [▶] buttons are pressed at the same time, the pointer can be moved diagonally.
- If the mouse button settings are set to reverse on the computer, the operation of the remote control buttons will also be reversed.
- The Wireless Mouse function does not operate under the following conditions.
  - When the configuration menu or a Help screen is displayed
  - When operating functions other than the Wireless Mouse function (such as adjusting the volume).
 However, when using the E-Zoom or Pointer function, the page up or down function is available.

## Saving a User's Logo

You can save the image that is currently being projected as a User's Logo. You can use the registered user's logo as a display when projection starts or no image signal is being input.

☞ **Extended - Display** p.64



Once a User Logo has been saved, the logo cannot be returned to the factory default.

**1** Project the image you want to save as the User's Logo, and then press the [Menu] button.

☞ "Using the Configuration Menu" p.57

### Using Remote Control

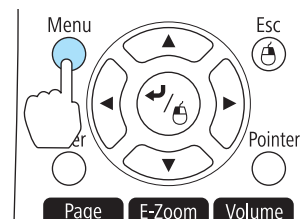

### Using the Control Panel

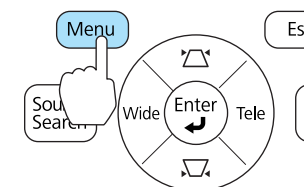

**2** Select **User's Logo** from **Extended**.



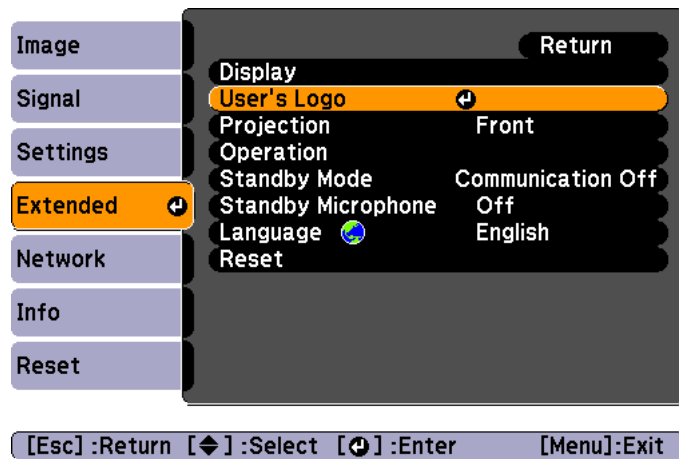

- When **User's Logo Protect** from **Password Protect** is set to **On**, a message is displayed and the User's Logo cannot be changed. You can make changes after setting **User's Logo Protect** to **Off**.
  - "Managing Users (Password Protect)" [p.52](#)
- If **User's Logo** is selected when Keystone, E-Zoom, Aspect, or Adjust Zoom is being performed, the function currently being performed is cancelled.

**3** When the message "Choose this image as the User's Logo?" is displayed, select **Yes**.



When you press the [↵] button on the remote control or the control panel, the screen size may change depending on the signal to match the actual resolution of the image signal.

**4** Move the box to select the part of the image to use as the User's Logo.

You can perform the same operations from the projector's control panel.

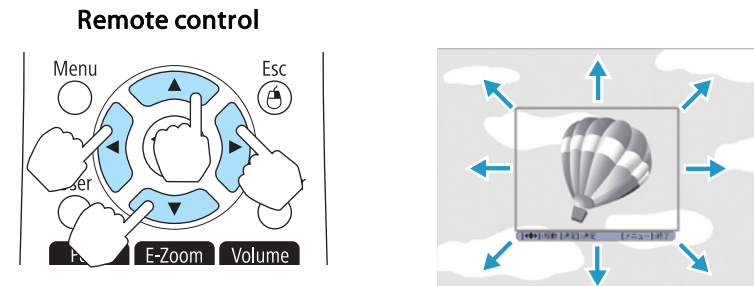

You can save at 400x300 dots in size.

**5** When you press the [↵] button and the message "Select this image?" is displayed, select **Yes**.

- 6** Select the zoom factor from the zoom setting screen.

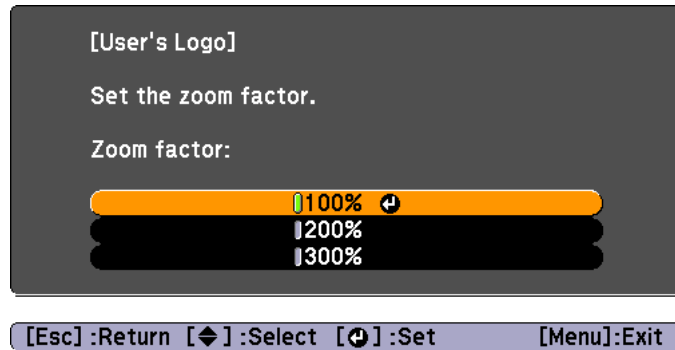

- 7** When the message "Save this image as the User's Logo?" is displayed, select **Yes**.

The image is saved. After the image has been saved, the message "Completed." is displayed.



- When a User's Logo is saved, the previous User's Logo is erased.
- It takes a while to save. Do not operate the projector or any connected equipment while it is saving, otherwise malfunctions may occur.

## Saving User Pattern

There are four types of patterns registered to the projector, such as ruled lines and grid patterns.

- ☛ **Settings - Pattern - Pattern Type** p.63

You can also save the image that is currently being projected as a User Pattern.



When a User Pattern is saved, the previous User Pattern is erased.

- 1** Project the image you want to use as the User Pattern, and then press the [Menu] button.

- ☛ "Using the Configuration Menu" p.57

### Using Remote Control

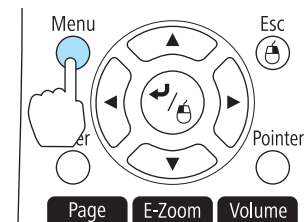

### Using the Control Panel

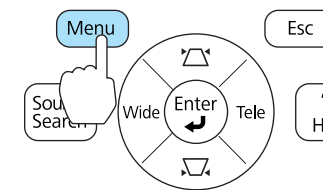

- 2** Select **Pattern** from **Settings**.

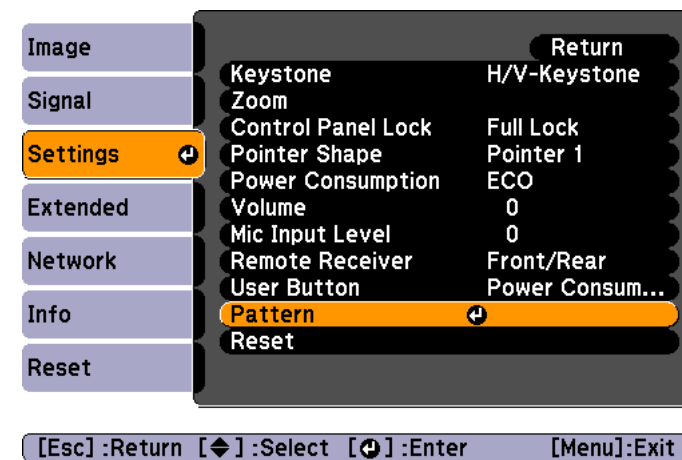

- 3** Select **User Pattern**.

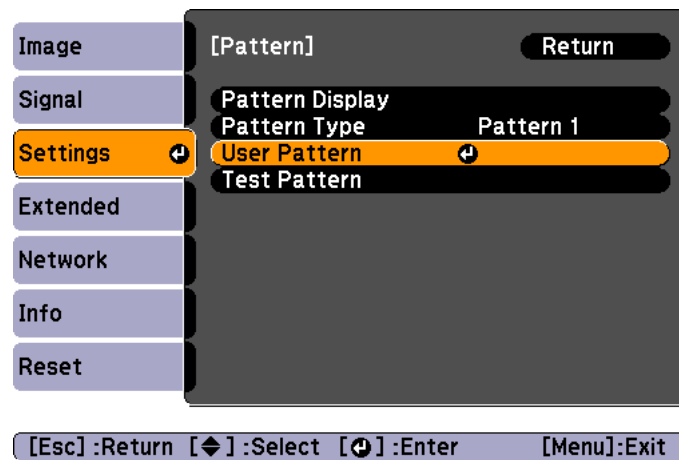

If **User Pattern** is selected when Keystone, E-Zoom, Aspect, or Adjust Zoom is being performed, the function currently being performed is cancelled.

**4** When "Do you want to use the currently projected image as the User Pattern?" is displayed, select **Yes**.

**5** When you press the [↵] button, the message "Do you want to use the currently projected image as the User Pattern?" is displayed. Then, select **Yes**.

The image is saved. After the image has been saved, the message "The User Pattern setting is complete." is displayed.



- Once a User Pattern has been saved, User Pattern cannot be returned to the factory default.
- It takes a while to save a User Pattern. Do not operate the projector or any connected equipment while it is saving, otherwise malfunctions may occur.

The projector has the following enhanced security functions.

- **Password Protect**  
You can limit who can use the projector.
- **Control Panel Lock**  
You can prevent people changing the settings on the projector without permission.  
☛ "Restricting Operation (Control Panel Lock)" [p.54](#)
- **Anti-Theft Lock**  
The projector is equipped with the following anti-theft security device.  
☛ "Anti-Theft Lock" [p.55](#)

## Managing Users (Password Protect)

When Password Protect is activated, people who do not know the password cannot use the projector to project images even if the projector power is on. Furthermore, the user's logo that is displayed when you turn on the projector cannot be changed. This acts as an anti-theft device as the projector cannot be used even if it is stolen. At the time of purchase, Password Protect is not activated.

### Kinds of Password Protect

The following three kinds of Password Protect settings can be made according to how the projector is being used.

- **Power On Protect**  
When **Power On Protect** is **On**, you need to enter a preset password after the projector is plugged in and turned on (this also applies to Direct Power On). If the correct password is not entered, projection does not start.

- **User's Logo Protect**

Even if someone tries to change the User's Logo set by the owner of the projector, it cannot be changed. When **User's Logo Protect** is set to **On**, the following setting changes for the User's Logo are prohibited.

- Capturing a User's Logo
- Setting **Display Background**, **Startup Screen**, or **A/V Mute** from **Display**  
☛ **Extended - Display** [p.64](#)

- **Network Protect**

When **Network Protect** is set to **On**, changing the settings for **Network** is prohibited.

- ☛ "Network Menu" [p.66](#)

## Setting Password Protect

Use the following procedure to set Password Protect.

- 1** During projection, hold down the [Freeze] button for about five seconds.

The Password Protect setting menu is displayed.

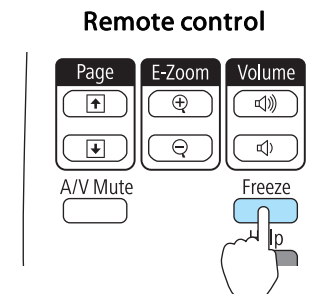



- If Password Protect is already activated, you must enter the password.  
If the password is entered correctly, the Password Protect setting menu is displayed.
- "Entering the Password" p.53
- When the password is set, stick the supplied password protect sticker in a visible position on the projector as a further theft deterrent.

- 2** Select the type of Password Protect you want to set, and then press the [↵] button.

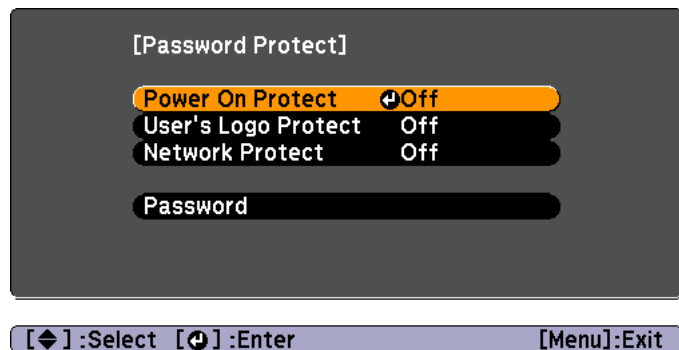

- 3** Select **On**, and then press the [↵] button.  
Press the [Esc] button, the screen displayed in step 2 is displayed again.

- 4** Set the password.
- (1) Select **Password**, and then press the [↵] button.
  - (2) When the message "Change the password?" is displayed, select **Yes** and then press the [↵] button. The default password is set to "0000". Change this to your own desired Password. If you select **No**, the screen displayed in step 2 is displayed again.

- (3) While holding down the [Num] button, enter a four digit number using the numeric buttons. The number entered is displayed as "\*\*\*\*". When you enter the fourth digit, the confirmation screen is displayed.

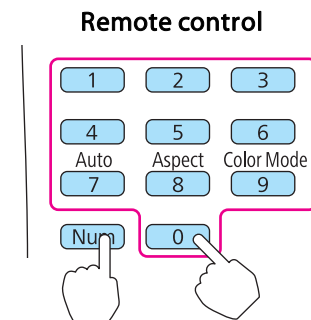

- (4) Re-enter the password.  
"Password accepted." is displayed.  
If you enter the password incorrectly, a message is displayed prompting you to re-enter the password.

## Entering the Password

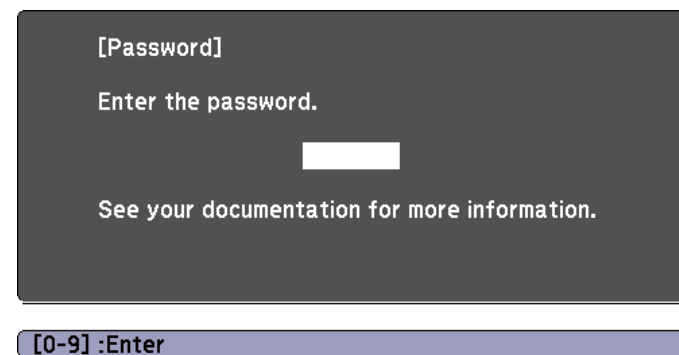

When the password entry screen is displayed, enter the password using the numeric buttons on the remote control.

While holding down the [Num] button, enter the password by pressing the numeric buttons.



When you enter the correct password, Password Protect is temporarily released.

### Attention

- If an incorrect password is entered three times in succession, the message "The projector's operation will be locked." is displayed for approximately five minutes, and then the projector switches to standby mode. If this happens, disconnect the power plug from the electrical outlet and then reinsert it and turn the projector's power back on. The projector displays the password entry screen again so that you can enter the correct password.
- If you have forgotten the password, make a note of the "Request Code: xxxxx" number that appears on the screen and contact the nearest address provided in the Epson Projector Contact List.  
 [Epson Projector Contact List](#)
- If you continue to repeat the above operation and input the wrong Password thirty times in succession, the following message is displayed and the projector does not accept any more Password entries. "The projector's operation will be locked. Contact Epson as described in your documentation."  
 [Epson Projector Contact List](#)

## Restricting Operation (Control Panel Lock)

Do one of the following to lock the operation buttons on the control panel.

- **Full Lock**  
All of the buttons on the control panel are locked. You cannot perform any operations from the control panel, including turning the power on or off.
- **Partial Lock**  
All of the buttons on the control panel, except for the [⏻] button, are locked.

This is useful at events or shows when you want to deactivate all buttons during projection or at schools when you want to limit button operation. The projector can still be operated using the remote control.

- 1 Press the [Menu] button while projecting.  
 "Using the Configuration Menu" p.57

### Using Remote Control

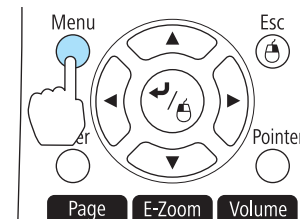

### Using the Control Panel

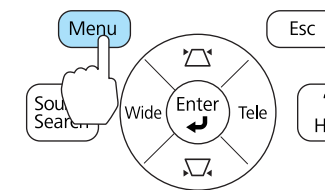

- 2 Select **Control Panel Lock** from **Settings**.

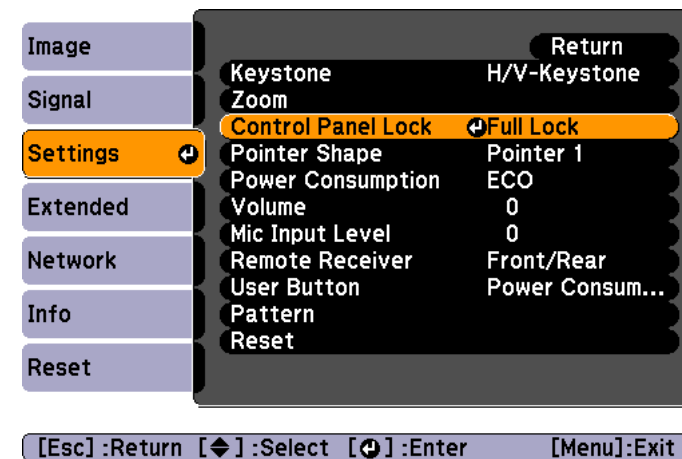

- 3 Select either **Full Lock** or **Partial Lock** according to your purpose.

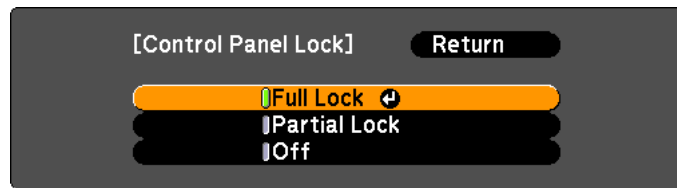

[Esc]:Return [◀]:Select [▶]:Set [Menu]:Exit

- 4** Select **Yes** when the confirmation message is displayed. The control panel buttons are locked according to the setting you chose.



You can release the control panel lock by one of the following two methods.

- Select **Off** from **Control Panel Lock**.
  -  **Settings - Control Panel Lock p.63**
- Press and hold down the [↵] button on the control panel for about seven seconds, a message is displayed and the lock is released.

## Anti-Theft Lock

The projector is equipped with the following types of anti-theft security devices.

- **Security slot**  
The security slot is compatible with the Microsaver Security System manufactured by Kensington. See the following for more details on the Microsaver Security System.  
 <http://www.kensington.com/>
- **Security cable installation point**  
A commercially available theft-prevention wire lock can be passed through the installation point to secure the projector to a desk or pillar.

### Installing the wire lock

Pass an anti-theft wire lock through the installation point.

See the documentation supplied with the wire lock for locking instructions.

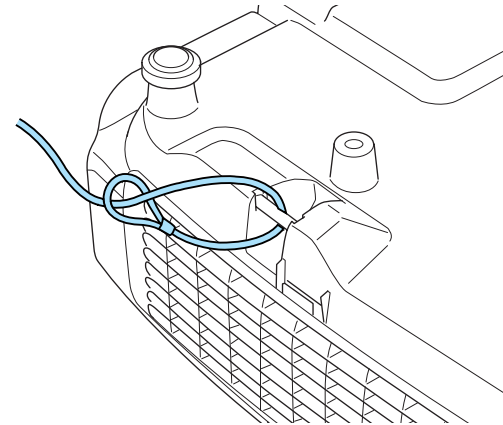



# Configuration Menu

This chapter explains how to use the Configuration menu and its functions.



This section explains how to use the Configuration menu.

Although steps are explained using the remote control as an example, you can perform the same operations from the control panel. Check the guide under the menu for the available buttons and their operations.

## 1 Display the Configuration menu screen.

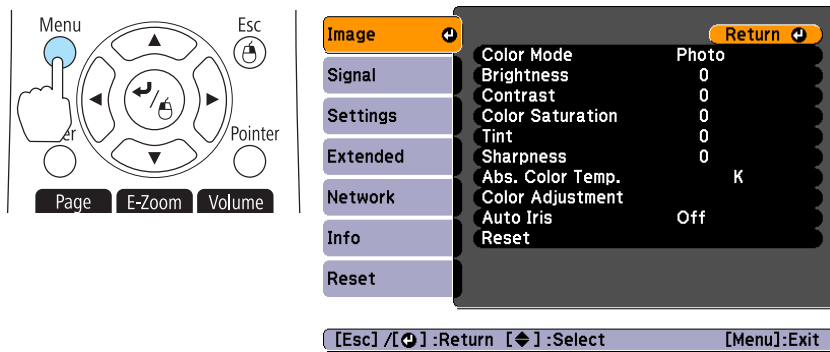

## 2 Select a top menu item.

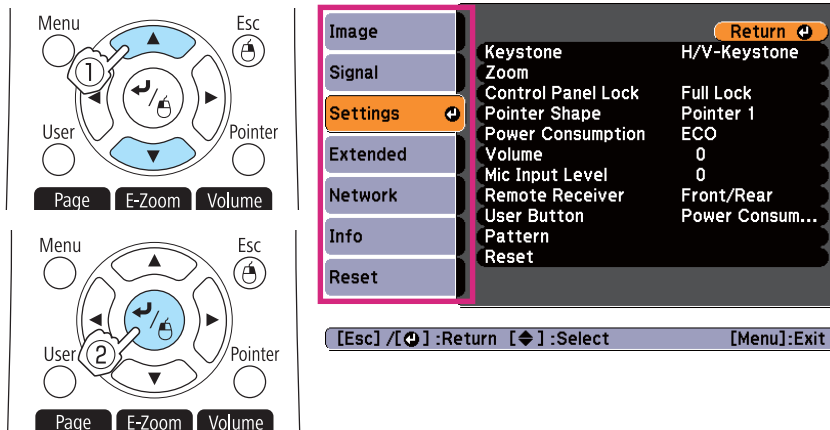

## 3 Select a submenu item.

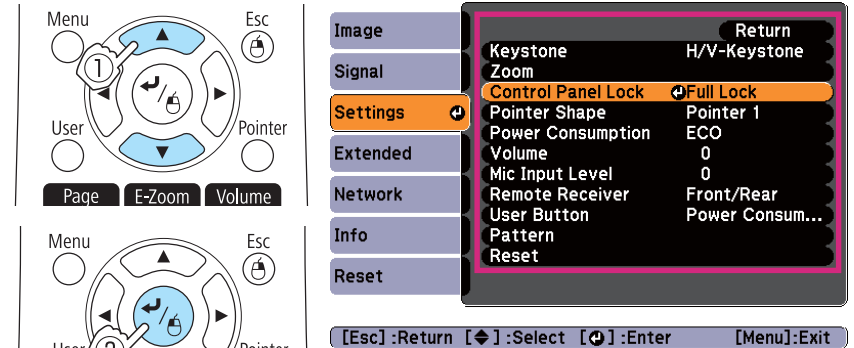

## 4 Change settings.

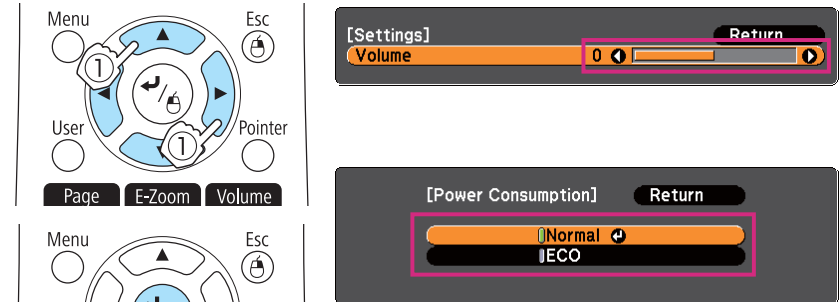

## 5 Press the [Menu] button to finish making settings.

## Configuration Menu Table

Settable items vary depending on the model being used and the image signal and source being projected.

Top Menu Name	Submenu Name	Items or Setting Values
Image menu ☛ p.60	Color Mode	Dynamic, Presentation, Theatre, Photo, Sports, sRGB, Blackboard, and Whiteboard
	Brightness	-24 - 24
	Contrast	-24 - 24
	Color Saturation	-32 - 32
	Tint	-32 - 32
	Sharpness	-5 - 5
	Abs. Color Temp.	5000K to 10000K
	Color Adjustment	Red: -16 to 16 Green: -16 to 16 Blue: -16 to 16
Auto Iris	On and Off	
Signal menu ☛ p.61	Auto Setup	On and Off
	Resolution	Auto, Wide, and Normal
	Tracking	-
	Sync.	-
	Position	Up, Down, Left, and Right
	Progressive	Off, Video, and Film/Auto
	Noise Reduction	Off, NR1, and NR2
	HDMI Video Range	Auto, Normal, and Expanded
Input Signal	Auto, RGB, and Component	

Top Menu Name	Submenu Name	Items or Setting Values
	Video Signal	Auto, NTSC, NTSC4.43, PAL, M-PAL, N-PAL, PAL60, and SECAM
	Aspect	Normal, Auto, 4:3, 16:9, Full, Zoom, and Native
	Overscan	Auto, Off, 4%, and 8%
Settings menu ☛ p.63	Keystone	H/V-Keystone and Quick Corner
	Zoom	0 (Wide) to 40 (Tele)
	Control Panel Lock	Full Lock, Partial Lock, and Off
	Pointer Shape	Pointer 1, Pointer 2, Pointer 3
	Power Consumption	Normal and ECO
	Volume	0 - 20
	Mic Input Level	0 - 5
	Remote Receiver	Front/Rear, Front, Rear and Off
	User Button	Power Consumption, Info, Progressive, Test Pattern, Resolution, Mic Input Level, and Pattern Display
	Pattern	Pattern Display, Pattern Type, User Pattern, and Test Pattern
Extended menu ☛ p.64	Display	Messages, Display Background, Startup Screen, and A/V Mute
	User's Logo	-
	Projection	Front, Front/Ceiling, Rear, and Rear/Ceiling
	Operation	Direct Power On, Sleep Mode, Sleep Mode Timer, High Altitude Mode, and Audio Input
	Standby Mode	Communication On and Communication Off

Top Menu Name	Submenu Name	Items or Setting Values
	Standby Microphone	On and Off
	Language	15 or 35 languages*1
Info menu ☛ p.74	Lamp Hours	-
	Source	-
	Input Signal	-
	Resolution	-
	Video Signal	-
	Refresh Rate	-
	Sync Info	-
	Status	-
	Serial Number	-
Reset menu ☛ p.75	Reset All	-
	Reset Lamp Hours	-

\*1 The number of supported languages differs depending on the region where the projector is used.

## Network menu

Top Menu Name	Submenu Name	Items or Setting Values
Basic menu ☛ p.68	Projector Name	-
	PJLink Password	-
	Web Control Password	-
	Projector Keyword	On and Off
Wireless LAN menu ☛ p.68	Wireless LAN Power	On and Off
	Connection Mode	Quick and Advanced
	Channel	1ch, 6ch, and 11ch

Top Menu Name	Submenu Name	Items or Setting Values
	Wireless LAN Sys.	802.11b/g and 802.11b/g/n
	SSID Auto Setting	On and Off
	SSID	-
	IP Settings	DHCP, IP Address, Subnet Mask, and Gateway Address
	SSID Display	On and Off
	IP Address Display	On and Off
Security menu ☛ p.70	Security	No, WEP, WPA-PSK, and WPA2-PSK
	WEP Encryption	128Bit and 64Bit
	Format	ASCII and HEX
	Key ID	1, 2, 3, 4
	Encryption Key 1, Encryption Key 2, Encryption Key 3, and Encryption Key 4	-
	Authentication Type	Open and Shared
	PSK	-
Wired LAN menu ☛ p.71	IP Settings	DHCP, IP Address, Subnet Mask, and Gateway Address
	IP Address Display	On and Off
Mail menu ☛ p.72	Mail Notification	On and Off
	SMTP Server	-
	Port Number	-
	Address 1 Setting, Address 2 Setting, and Address 3 Setting	-
Others menu ☛ p.73	SNMP	On and Off

Top Menu Name	Submenu Name	Items or Setting Values
	Trap IP Address 1 and Trap IP Address 2	-
	Priority Gateway	Wired LAN and Wireless LAN
	AMX Device Discovery	On and Off
	Crestron RoomView	On and Off
	Bonjour	On and Off

## Image Menu

Settable items vary depending on the image signal and source currently being projected. Setting details are saved for each image signal.

☛ "Automatically Detect Input Signals and Change the Projected Image (Source Search)" [p.29](#)

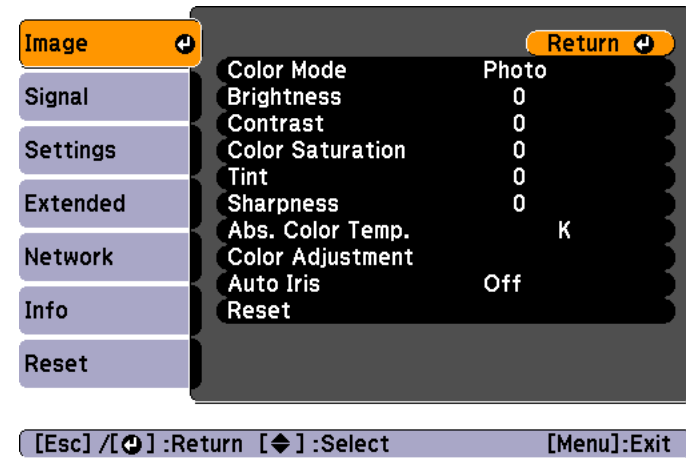

Sub-menu	Function
<b>Color Mode</b>	You can select the quality of the image to suit your surroundings. ☛ "Selecting the Projection Quality (Selecting Color Mode)" <a href="#">p.38</a>
<b>Brightness</b>	You can adjust the image brightness.
<b>Contrast</b>	You can adjust the difference between light and dark in the images.
<b>Color Saturation</b>	You can adjust the color saturation for the images.
<b>Tint</b>	You can adjust the image tint.
<b>Sharpness</b>	You can adjust the image sharpness.
<b>Abs. Color Temp.</b>	(This item cannot be selected if <b>Color Mode</b> is set to <u>sRGB</u> .) You can adjust the overall tint of the image. You can adjust tints in 10 stages from 5000 K to 10000 K. The image is tinted blue when a high value is selected and tinted red when a low value is selected.

Sub-menu	Function
<b>Color Adjustment</b>	(This item cannot be selected if <b>Color Mode</b> is set to <b>sRGB</b> .) You can adjust the color strength for <b>Red</b> , <b>Green</b> , and <b>Blue</b> individually.
<b>Auto Iris</b>	(This item can be set only if <b>Color Mode</b> is set to <b>Dynamic</b> or <b>Theatre</b> .) Set to <b>On</b> to adjust the iris to obtain the optimum light for images being projected. The setting is stored for each Color Mode. ☛ "Setting Auto Iris" <a href="#">p.39</a>
<b>Reset</b>	You can reset all adjustment values for the <b>Image</b> menu to their default settings. See the following to return all menu items to their default settings. ☛ "Reset Menu" <a href="#">p.75</a>

## Signal Menu

Settable items vary depending on the image signal and source currently being projected. Setting details are saved for each image signal.

You cannot make settings on the Signal menu when the source is USB Display, USB, or LAN.

☛ "Automatically Detect Input Signals and Change the Projected Image (Source Search)" [p.29](#)

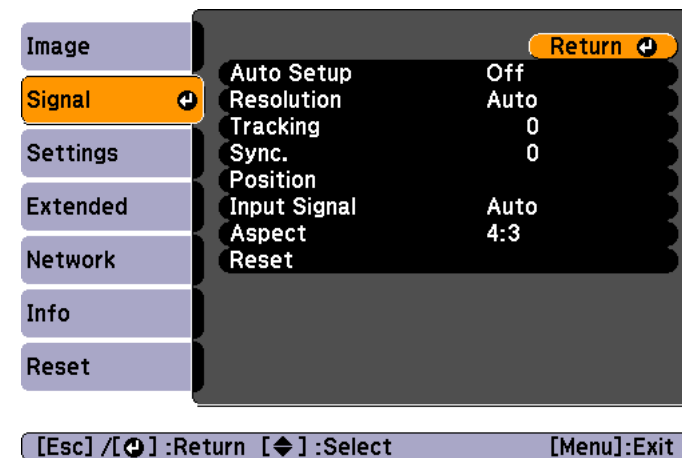

Sub-menu	Function
<b>Auto Setup</b>	Set to <b>On</b> to automatically adjust Tracking, Sync., and Position to the optimum state when the input signal changes.
<b>Resolution</b>	Set to <b>Auto</b> to automatically identify the resolution of the input signal. If images are not projected correctly when set to <b>Auto</b> , for example if some of the image is missing, adjust to <b>Wide</b> for wide screens, or set to <b>Normal</b> for 4:3 or 5:4 screens depending on the connected computer.
<b>Tracking</b>	You can adjust computer images when vertical stripes appear in the images.

Sub-menu	Function
<b>Sync.</b>	You can adjust computer images when flickering, fuzziness, or interference appear in the images.
<b>Position</b>	You can adjust the display position up, down, left, and right when a part of the image is missing so that all of the image is projected.
<b>Progressive</b>	<p><u>Interlace</u> (i) signal is converted to <u>Progressive</u> (p). (IP conversion)</p> <p><b>Off:</b> Ideal for images with a large amount of movement.</p> <p><b>Video:</b> Ideal for general video images.</p> <p><b>Film/Auto:</b> This is ideal for movie films, computer graphics, and animation.</p>
<b>Noise Reduction</b>	<p>(This cannot be set when a digital RGB signal is input, or when an interlace signal is being displayed when <b>Progressive</b> is set to <b>Off</b>.)</p> <p>Smooths out rough images. There are two modes. Select your favorite setting. It is recommended that this is set to <b>Off</b> when viewing image sources in which noise is very low, such as for DVDs.</p>
<b>HDMI Video Range</b>	When the projector's HDMI port is connected to a DVD player, the projector's video range is set according to the DVD player's video range setting.
<b>Input Signal</b>	<p>You can select the input signal from the Computer1 port or the Computer2 port.</p> <p>If set to <b>Auto</b>, the input signal is set automatically according to the connected equipment.</p> <p>If colors do not appear correctly when set to <b>Auto</b>, select the appropriate signal according to the connected equipment.</p>
<b>Video Signal</b>	You can select the input signal from the S-Video port or the Video port. If set to <b>Auto</b> , video signals are recognized automatically. If interference appears in the image or a problem occurs such as no image is being projected when set to <b>Auto</b> , select the appropriate signal according to the connected equipment.
<b>Aspect</b>	<p>You can set the <u>aspect ratio</u> for projected images.</p> <p>"Changing the Aspect Ratio of the Projected Image" p.40</p>



Sub-menu	Function
<b>Overscan</b>	Changes the output image ratio (the range of the projected image). You can set the cropping range to <b>Off</b> , <b>4%</b> , or <b>8%</b> . When the source is HDMI, <b>Auto</b> is available. When <b>Auto</b> is selected, it automatically changes to <b>Off</b> or <b>8%</b> according to the input signal.
<b>Reset</b>	<p>You can reset all adjustment values on the <b>Signal</b> menu to their default settings, except for <b>Input Signal</b>.</p> <p>See the following to return all menu items to their default settings.</p> <p>"Reset Menu" p.75</p>

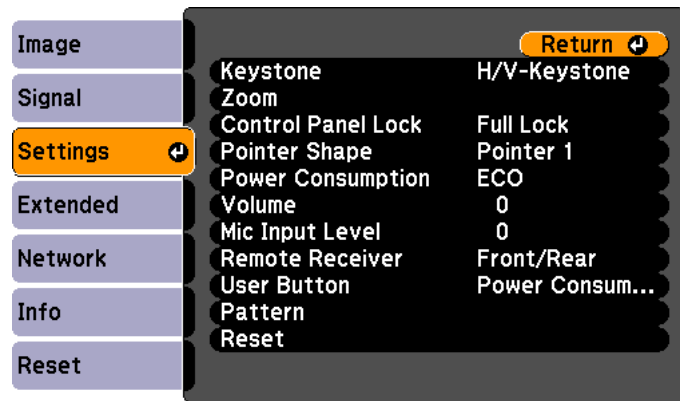



## Settings Menu



[Esc]/[⏪]:Return [⏩]:Select [Menu]:Exit

Sub-menu	Function
<b>Keystone</b>	<p>You can correct keystone distortion.</p> <ul style="list-style-type: none"> <li>When <b>H/V-Keystone</b> is selected: Adjust <b>V-Keystone</b> and <b>H-Keystone</b> to correct horizontal and vertical keystone distortion.</li> <li>When <b>Quick Corner</b> is selected: Select and correct the four corners of the projected image. ☛ "Quick Corner" p.35</li> </ul>
<b>Zoom</b>	Adjusts the projected image size.
<b>Control Panel Lock</b>	<p>You can use this to restrict operation of the projector's control panel.</p> <p>☛ "Restricting Operation (Control Panel Lock)" p.54</p>

Sub-menu	Function
<b>Pointer Shape</b>	<p>You can select the shape of the pointer.</p> <p>Pointer 1: </p> <p>Pointer 2: </p> <p>Pointer 3: </p> <p>☛ "Pointer Function (Pointer)" p.45</p>
<b>Power Consumption</b>	<p>You can set the lamp brightness to one of two settings. Select <b>ECO</b> if the images being projected are too bright, such as when projecting images in a dark room or onto a small screen. When <b>ECO</b> is selected, the amount of electricity consumed and the lamp's operating life are changed as follows, and fan rotation noise during projection is reduced.</p> <p>Electrical consumption: about 16 to 26% decrease, lamp life: about 1.2 to 1.5 times longer</p>
<b>Volume</b>	<p>You can adjust the volume. Setting values are saved for each source.</p>
<b>Mic Input Level</b>	<p>Adjust this if the microphone input level is low and the microphone audio output from the projector's speaker is difficult to hear, or if the input level is too high, resulting in a crackling sound in the audio from the microphone. When <b>Mic Input Level</b> is turned down to 0, no microphone audio is output from the speaker.</p> <p>When the microphone input level is raised, the audio from the connected device becomes quieter. When the microphone input level is lowered, the audio from the connected device becomes louder.</p>
<b>Remote Receiver</b>	<p>You can limit the reception of the operation signal from the remote control.</p> <p>When set to <b>Off</b>, you cannot perform any operations from the remote control. If you want to make operations from the remote control, hold down the [Menu] button on the remote control for at least 15 seconds to reset the setting to its default value.</p>



Sub-menu	Function
<b>User Button</b>	<p>You can select the item assigned from the Configuration menu with the remote control's [User] button. By pressing the [User] button the assigned menu item selection/adjustment screen is displayed, allowing you to make one-touch settings/adjustments. You can assign one of the following items to the [User] button.</p> <p><b>Power Consumption, Info, Progressive, Test Pattern, Resolution, Mic Input Level, and Pattern Display</b></p>
<b>Pattern</b>	<p><b>Pattern Display:</b> Display a pattern.</p> <p><b>Pattern Type:</b> You can select from Patterns 1 to 4 or User Pattern. Patterns 1 to 4 display projection lines such as ruled lines or a grid.</p> <p>Pattern 1:  Pattern 2: </p> <p>Pattern 3:  Pattern 4: </p> <p><b>User Pattern:</b> Captures a user pattern.   "Saving User Pattern" p.50</p> <p><b>Test Pattern:</b> When the projector is set up, a test pattern is displayed so that you can adjust the projection status without connecting equipment. While the test pattern is displayed, zoom, focus adjustments, and keystone correction can be performed. To cancel the Test Pattern, press the [Esc] button on the remote control or the control panel.</p> <div style="border: 1px solid black; padding: 5px; margin-top: 10px;"> <p><b>Attention</b></p> <p>If a pattern is displayed for a long time, a residual image may be visible in projected images.</p> </div>

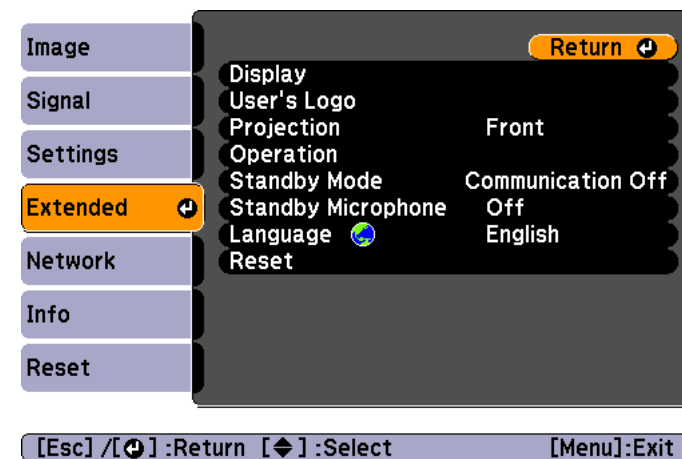

Sub-menu	Function
<b>Reset</b>	<p>You can reset all adjustment values in the <b>Settings</b> menu to their default settings, except for <b>Zoom</b> and <b>User Button</b>.</p> <p>See the following to return all menu items to their default settings.</p> <p> "Reset Menu" p.75</p>

## Extended Menu





Sub-menu	Function
<b>Display</b>	<p>You can make settings related to the projector's display.</p> <p><b>Messages:</b> When set to <b>Off</b>, the following items will not be displayed.</p> <p>Item names when the Source, Color Mode, or Aspect Ratio is changed, messages when no signal is being input, and warnings such as High Temp Warning.</p> <p><b>Display Background</b>*1: You can set the screen status for when no image signal is available to <b>Black</b>, <b>Blue</b>, or <b>Logo</b>.</p> <p><b>Startup Screen</b>*1: Set to <b>On</b> to display the <b>User's Logo</b> when projection starts.</p> <p><b>A/V Mute</b>*1: You can set the screen displayed when the remote control's [A/V Mute] button is pressed to <b>Black</b>, <b>Blue</b>, or <b>Logo</b>.</p>
<b>User's Logo</b> *1	<p>You can change the user's logo that is displayed as a background during Display Background, A/V Mute, and so on.</p> <p> "Saving a User's Logo" <a href="#">p.48</a></p>
<b>Projection</b>	<p>Select from one of the following projection methods depending on how the projector is installed.</p> <p><b>Front</b>, <b>Front/Ceiling</b>, <b>Rear</b>, and <b>Rear/Ceiling</b></p> <p>You can change the setting as follows by pressing down the [A/V Mute] button on the remote control for about five seconds.</p> <p><b>Front ↔ Front/Ceiling</b></p> <p><b>Rear ↔ Rear/Ceiling</b></p> <p> "Installation Methods" <a href="#">p.17</a></p>

Sub-menu	Function
<b>Operation</b>	<p><b>Direct Power On:</b> Set to <b>On</b> to turn on the projector simply by plugging it in.</p> <p>When the power cable is plugged in, note that the projector turns on automatically in cases such as a power outage being restored.</p> <p><b>Sleep Mode:</b> When this is set to <b>On</b>, the power is turned off automatically when no image signal is input and no operation is performed within a certain amount of time.</p> <p><b>Sleep Mode Timer:</b> When <b>Sleep Mode</b> is set to <b>On</b>, you can set the time before the projector automatically turns off within a range of 1 to 30 minutes.</p> <p><b>High Altitude Mode:</b> Set this to <b>On</b> when using the projector at an altitude of 1500 m or above.</p> <p><b>Audio Input:</b> When set to <b>Auto</b>, audio for the image currently being projected is output. If anything other than <b>Auto</b> is selected, audio for the selected audio input port is output. When the input source is HDMI, USB Display, or LAN, the audio for the image currently being projected is output regardless of the <b>Audio Input</b> setting.</p>
<b>Standby Mode</b>	<p>If you set <b>Communication On</b>, you can perform the following operations even if the projector is in standby mode.</p> <ul style="list-style-type: none"> <li>Monitoring and controlling the projector over the network. <ul style="list-style-type: none"> <li> "Monitoring and Controlling" <a href="#">p.108</a></li> </ul> </li> <li>Outputting analog RGB signals from the Computer1 port to an external monitor.</li> <li>Outputting audio from the microphone to the projector's speaker. <ul style="list-style-type: none"> <li>(Only when the <b>Standby Microphone</b> is set to <b>On</b>.)</li> <li> "Connecting Image Sources" <a href="#">p.19</a></li> </ul> </li> </ul>
<b>Standby Microphone</b>	<p>(This item is settable only when <b>Standby Mode</b> set to <b>Communication On</b>.)</p> <p>When set to <b>On</b>, you can output audio from the microphone from the projector's speaker even if the projector is in standby mode.</p>

Sub-menu	Function
Language	You can set the language for messages and menus.
Reset	You can reset the adjustment values for <b>Display</b> * <sup>1</sup> and <b>Operation</b> * <sup>2</sup> from the <b>Extended</b> menu to their default settings. See the following to return all menu items to their default settings. ☛ "Reset Menu" p.75

\*1 When **User's Logo Protect** is set to **On** in **Password Protect**, settings related to user's logo cannot be changed. You can make changes after setting **User's Logo Protect** to **Off**.

☛ "Managing Users (Password Protect)" p.52

\*2 Except for High Altitude Mode.

## Network Menu

When **Network Protect** is set to **On** in **Password Protect**, a message is displayed and the network settings cannot be changed. Turn **Network Protect Off** and then configure the network.

☛ "Setting Password Protect" p.52

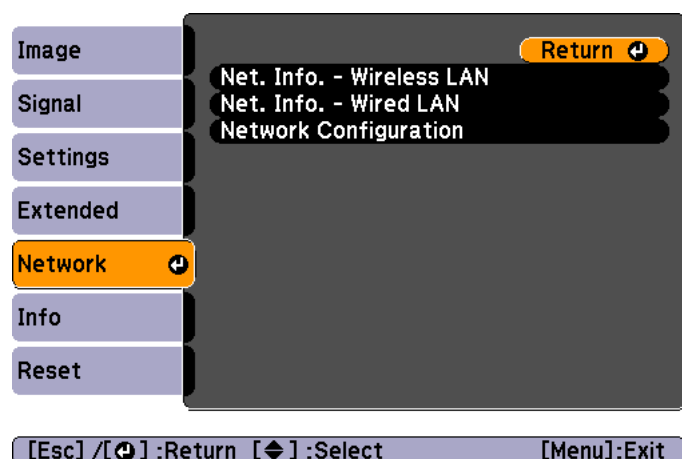

Sub-menu	Function
<b>Net. Info. - Wireless LAN</b>	Displays the following network setting status information. <ul style="list-style-type: none"> <li>• Connection Mode</li> <li>• Antenna Level</li> <li>• Projector Name</li> <li>• SSID</li> <li>• DHCP</li> <li>• IP Address</li> <li>• Subnet Mask</li> <li>• Gateway Address</li> <li>• MAC Address</li> <li>• Region Code*</li> </ul>
<b>Net. Info. - Wired LAN</b>	Displays the following network setting status information. <ul style="list-style-type: none"> <li>• Projector Name</li> <li>• DHCP</li> <li>• IP Address</li> <li>• Subnet Mask</li> <li>• Gateway Address</li> <li>• MAC Address</li> </ul>
<b>Network Configuration</b>	The following menus are available for setting network items. <b>Basic, Wireless LAN, Security, Wired LAN, Mail, Others, Reset, and Setup complete</b>

\* Displays available region information for the Wireless LAN unit being used. For more details, contact your local dealer or the nearest address provided in the Epson Projector Contact List.

☛ [Epson Projector Contact List](#)



By using a Web browser of a computer connected to the projector on a network, you can set functions and control the projector. This function is called Web Control. You can easily enter text using a keyboard to make settings for Web Control such as Security settings.

☛ "Changing Settings Using a Web Browser (Web Control)" p.108

## Notes on operating the Network menu

Selecting from the top menu and sub menus, and changing selected items is the same as making operations from the Configuration menu.

When done, make sure you go to the **Setup complete** menu, and select one of **Yes**, **No**, or **Cancel**. When you select **Yes** or **No**, you return to the Configuration menu.

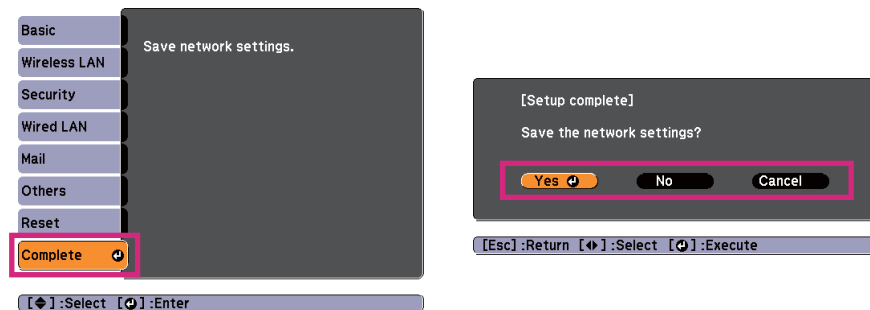







**Yes:** Saves the settings and exits the Network menu.



**No:** Does not save the settings and exits the Network menu.

**Cancel:** Continues displaying the Network menu.

## Soft keyboard operations

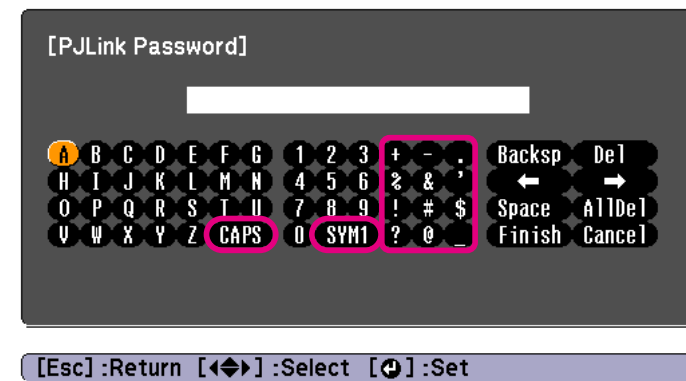
The Network menu contains items that require input of alphanumerics during setup. In this case, the following software keyboard is displayed. Use the , , , and  buttons on the remote control or the , , [Wide], and [Tele] buttons on the control panel to move the cursor to the desired key, and then press the  button to enter the alphanumeric character. Enter figures by holding down the [Num] button on the remote control, and pressing the numeric buttons. After inputting, press **Finish** on the keyboard to confirm your input. Press **Cancel** on the keyboard to cancel your input.



- Each time the **CAPS** key is selected and the  button is pressed, it sets and changes between upper case and lower case letters.
- Each time the **SYM1/2** key is selected and the  button is pressed, it sets and changes the symbol keys for the section enclosed by the frame.

## Basic menu

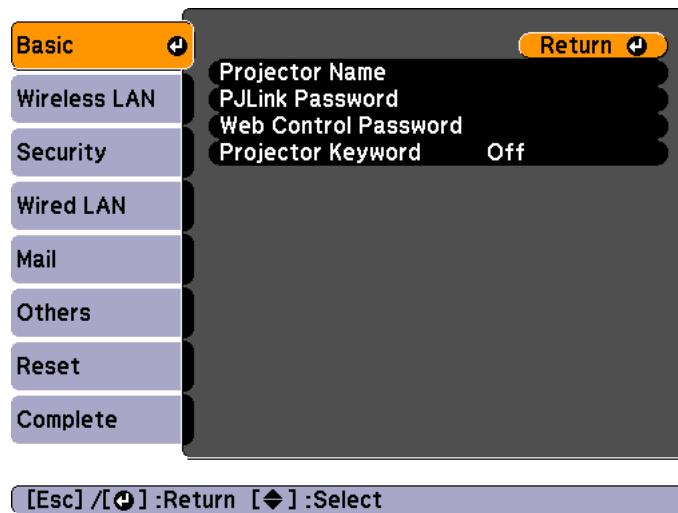

Sub-menu	Function
<b>Projector Name</b>	Displays the projector name used to identify the projector when connected to a network. When editing, you can enter up to 16 single-byte alphanumeric characters.
<b>PJLink Password</b>	Set a password to use when you access the projector using compatible PJLink software. You can enter up to 32 single-byte alphanumeric characters.
<b>Web Control Password</b>	Set a password to use when making settings and controlling the projector using Web Control. Enter no more than eight single-byte alphanumeric characters. Web Control is a computer function that allows you to set up and control the projector by using the Web browser on a computer connected on a Network.  "Changing Settings Using a Web Browser (Web Control)" p.108

Sub-menu	Function
<b>Projector Keyword</b>	When set to <b>On</b> , you have to enter the keyword when you try to connect the projector to a computer via a network. As a result, you can prevent presentations from being interrupted by connections from other computers. Normally this should be set to <b>On</b> .  <a href="#">EasyMP Network Projection Operation Guide</a>

## Wireless LAN menu

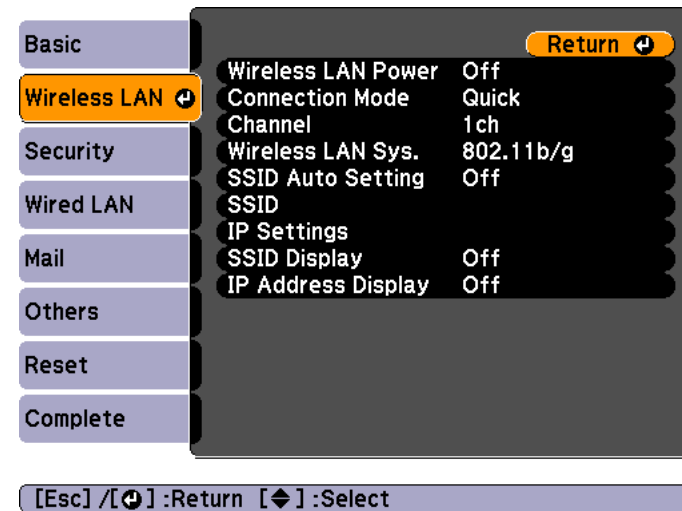

Sub-menu	Function
<b>Wireless LAN Power</b>	Turn <b>On</b> when connecting the projector to the computer over wireless LAN. If you do not want to connect via wireless LAN, turn it <b>Off</b> to prevent unauthorized access by others. This is set to <b>On</b> by default.



Sub-menu	Function
<b>Connection Mode</b>	Set the connection mode when using EasyMP Network Projection to connect the projector and computer. This is set to <b>Quick</b> by default. See the following manual for details on Connection Mode. <a href="#">EasyMP Network Projection Operation Guide</a>
<b>Channel</b>	(This can only be set if <b>Connection Mode</b> is set to <b>Quick</b> .) Select the frequency band used by the wireless LAN from <b>1ch</b> , <b>6ch</b> , or <b>11ch</b> . This is set to <b>11ch</b> by default.
<b>Wireless LAN Sys.</b>	Set the Wireless LAN Sys. to either <b>802.11b/g</b> or <b>802.11b/g/n</b> . The default value is <b>802.11b/g/n</b> .
<b>SSID Auto Setting</b>	(This can only be set if <b>Connection Mode</b> is set to <b>Quick</b> .) Set to <b>On</b> to speed up the projector search. Set to <b>Off</b> when connecting to multiple projectors at the same time. This is set to <b>On</b> by default.
<b>SSID</b>	(This can be set only if <b>SSID Auto Setting</b> is set to <b>Off</b> .) Enter an <b>SSID</b> . When an SSID is provided for the wireless LAN system in which the projector participates, enter the SSID. You can enter up to 32 single-byte alphanumeric characters.

Sub-menu	Function
<b>IP Settings</b>	(This can be set only if <b>Connection Mode</b> is set to <b>Advanced</b> .) You can make network settings. <b>DHCP:</b> Set to <b>On</b> to make network settings using <b>DHCP</b> . If this is set to <b>On</b> , you cannot set any more addresses. <b>IP Address:</b> You can input the <b>IP address</b> assigned to the projector. You can enter a number from 0 to 255 in each field of the address. However, the following IP addresses cannot be used. 0.0.0.0, 127.x.x.x, 224.0.0.0 to 255.255.255.255 (where x is a number from 0 to 255) <b>Subnet Mask:</b> You can input the <b>subnet mask</b> for the projector. You can enter a number from 0 to 255 in each field of the address. However, the following subnet masks cannot be used. 0.0.0.0, 255.255.255.255 <b>Gateway Address:</b> You can input the IP address for the gateway for the projector. You can enter a number from 0 to 255 in each field of the address. However, the following <b>Gateway addresses</b> cannot be used. 0.0.0.0, 127.x.x.x, 224.0.0.0 to 255.255.255.255 (where x is a number from 0 to 255)
<b>SSID Display</b>	To prevent the <b>SSID</b> from being displayed on the LAN Standby screen, set this to <b>Off</b> .
<b>IP Address Display</b>	To prevent the <b>IP address</b> from being displayed on the LAN Standby screen, set this to <b>Off</b> .

## Security menu



Sub-menu	Function
<b>Security</b>	Select the security type from the items that are displayed. When setting security, follow the instructions from the administrator of the network system you are about to access.
<b>WEP Encryption</b>	You can set the encryption method for WEP encryption. <b>128Bit:</b> Uses 128 (104) bit encoding. <b>64Bit:</b> Uses 64 (40) bit encoding.
<b>Format</b>	You can set the input method for the WEP encryption key to <b>ASCII</b> or <b>HEX</b> .
<b>Key ID</b>	You can select the WEP encryption ID key.

Sub-menu	Function
<b>Encryption Key 1/Encryption Key 2/Encryption Key 3/Encryption Key 4</b>	You can enter the key used for WEP encryption. Enter the key in single-byte characters following instructions from the network administrator for the network in which the projector participates. The type of character and the number that can be entered differ according to the <b>WEP Encryption</b> and <b>Format</b> settings. <b>128Bit - ASCII:</b> Single-byte alphanumeric, 13 characters. <b>64Bit - ASCII:</b> Single-byte alphanumeric, 5 characters. <b>128Bit - HEX:</b> 0 to 9 and A to F, 26 characters. <b>64Bit - HEX:</b> 0 to 9 and A to F, 10 characters.
<b>Authentication Type</b>	Set the WEP authentication type. <b>Open:</b> Uses open system authentication. <b>Shared:</b> Uses shared key authentication.
<b>PSK</b>	(This can only be set when <b>WPA-PSK</b> or <b>WPA2-PSK</b> are selected from <b>Security</b> .) You can enter a Pre-Shared Key (encrypted key) in single-byte alphanumeric characters. Enter at least 8 and up to 32 characters.

## Type of security

When the optional wireless LAN unit is installed and being used in Advanced connection mode, it is strongly recommended that you set security. Select one of the following security methods.

- **WEP**

Data is encrypted with a code key (WEP key). This mechanism prevents communication unless the encryption keys for the access point and the projector match.

- **WPA**

This is an encryption standard that improves security which is a weak point of WEP. Although there are multiple kinds of WPA encryption methods, this projector uses TKIP and AES.

WPA also includes user authentication functions. WPA authentication provides two methods: using an authentication server, or authenticating between a computer and an access point without using a server. This projector supports the latter method, without a server.



For setting details, follow the directions from the network administrator of your network.

### Wired LAN menu

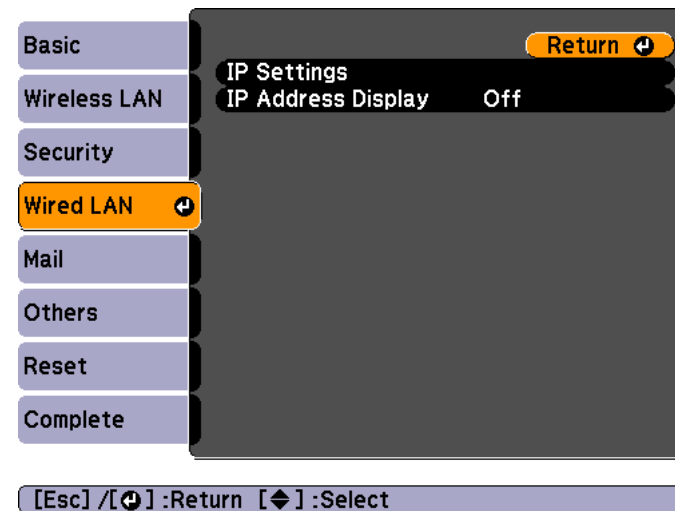

Sub-menu	Function
<b>IP Settings</b>	<p>You can make settings related to the following addresses.</p> <p><b>DHCP</b>▶▶: Set to <b>On</b> to configure the network using DHCP. If this is set to <b>On</b>, you cannot set any more addresses.</p> <p><b>IP Address</b>▶▶: You can input the IP address assigned to the projector. You can input a number from 0 to 255 in each field of the address. However, the following IP addresses cannot be used. 0.0.0.0, 127.x.x.x, 224.0.0.0 to 255.255.255.255 (where x is a number from 0 to 255)</p> <p><b>Subnet Mask</b>▶▶: You can input the subnet mask for the projector. You can input a number from 0 to 255 in each field of the address. However, the following subnet masks cannot be used. 0.0.0.0, 255.255.255.255</p> <p><b>Gateway Address</b>▶▶: You can input the IP address for the gateway for the projector. You can input a number from 0 to 255 in each field of the address. However, the following gateway addresses cannot be used. 0.0.0.0, 127.x.x.x, 224.0.0.0 to 255.255.255.255 (where x is a number from 0 to 255)</p>
<b>IP Address Display</b>	To prevent the IP address from being displayed on Network Info in the Network menu and on the LAN Standby screen, set this to <b>Off</b> .

## Mail menu

When this is set, you receive an email notification if a problem or warning occurs in the projector.

☛ "Using the Mail Notification Function to Report Problems" p.111

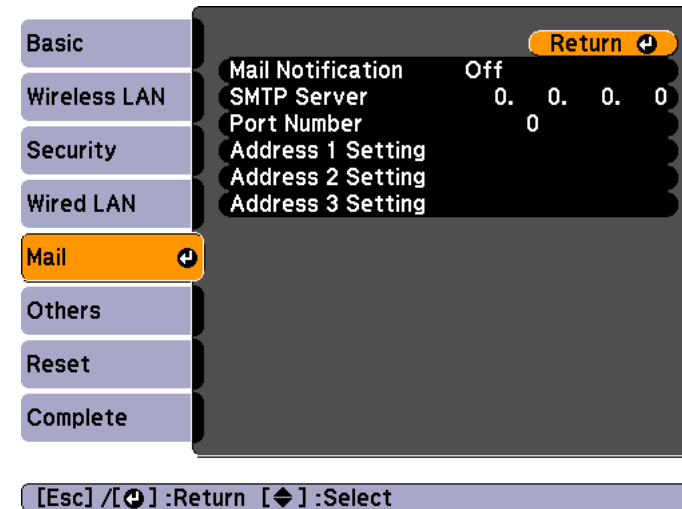

Sub-menu	Function
<b>Mail Notification</b>	Set to <b>On</b> to send an email to the preset addresses when a problem or warning occurs with a projector.
<b>SMTP Server</b>	<p>You can input the <b>IP address</b>▶▶ for the SMTP server for the projector.</p> <p>You can enter a number from 0 to 255 in each field of the address. However, the following IP addresses cannot be used. 127.x.x.x, 224.0.0.0 to 255.255.255.255 (where x is a number from 0 to 255)</p>
<b>Port Number</b>	You can input the port number for the SMTP server. The default value is 25. You can input numbers between 1 to 65535.



Sub-menu	Function
<b>Address 1 Setting/Address 2 Setting/Address 3 Setting</b>	<p>You can input the email address of the destination to send the notification email to. You can register up to three destinations. You can enter up to 32 single-byte alphanumeric characters for the email addresses.</p> <p>The address for destination 1 is the mail notification sender's address.</p> <p>You can select the problems or warnings to be notified about by email. When the selected problem or warning occurs in the projector, an email is sent to the specified destination address notifying that a problem or warning has occurred. You can select multiple items from the displayed items.</p>

### Others menu

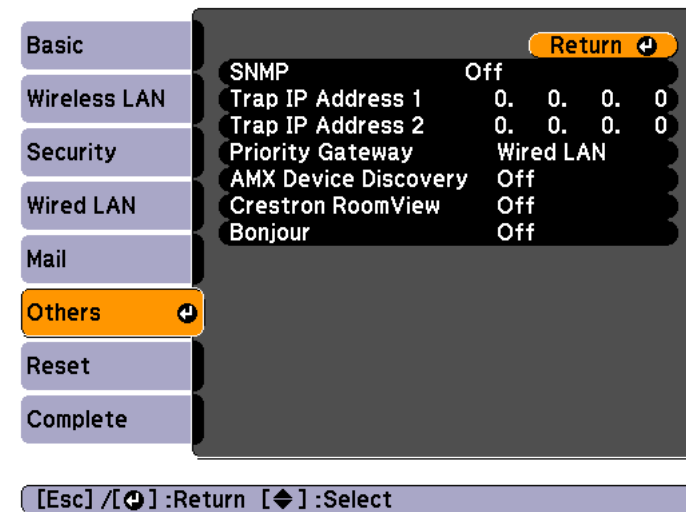

Sub-menu	Function
<b>SNMP</b>	<p>Set to <b>On</b> to monitor the projector using SNMP.</p> <p>To monitor the projector, you need to install the SNMP manager program on your computer. SNMP should be managed by a network administrator.</p> <p>The default value is <b>Off</b>.</p>
<b>Trap IP Address 1/Trap IP Address 2</b>	<p>You can register up to two IP addresses for the SNMP trap notification destination. You can enter a number from 0 to 255 in each field of the address. However, the following IP addresses cannot be used. 127.x.x.x, 224.0.0.0 to 255.255.255.255 (where x is a number from 0 to 255)</p>
<b>Priority Gateway</b>	<p>You can set the priority gateway to a <b>Wired LAN</b> or <b>Wireless LAN</b>.</p>

Sub-menu	Function
<b>AMX Device Discovery</b>	When the projector is connected to a network, set this to <b>On</b> to allow the projector to be detected by <u>AMX Device Discovery</u> . Set this to <b>Off</b> if you are not connected to an environment controlled with a controller from AMX or AMX Device Discovery.
<b>Crestron RoomView</b>	Set this to <b>On</b> only when monitoring or controlling the projector over the network using Crestron RoomView®. Otherwise, set this to <b>Off</b> .  "About Crestron RoomView®" <a href="#">p.114</a> When this is set to <b>On</b> , the following functions are not available. <ul style="list-style-type: none"> <li>• Web control</li> <li>• Message Broadcasting (EasyMP Monitor Plug-in)</li> </ul>
<b>Bonjour</b>	Set this to <b>On</b> when connecting to the network using Bonjour. See Apple's Web site for more information on the Bonjour service. <a href="http://www.apple.com/">http://www.apple.com/</a>

## Reset menu

Resets all of the network settings.

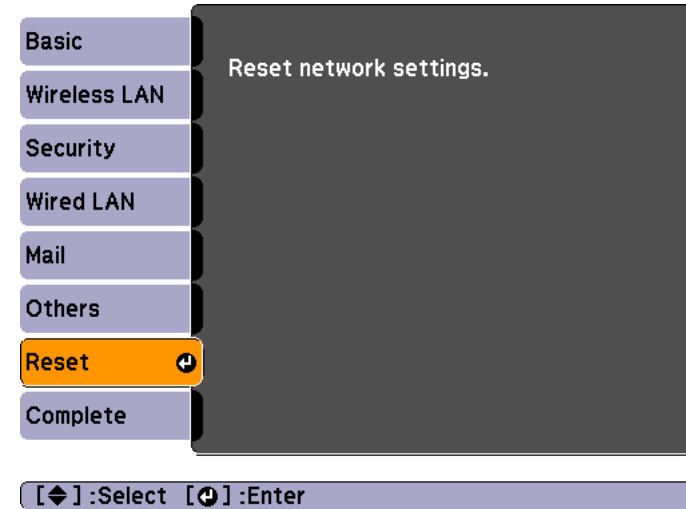

Sub-menu	Function
<b>Reset network settings.</b>	To reset all of the Network settings, select Yes.

## Info Menu (Display Only)

Lets you check the status of the image signals being projected and the status of the projector. Items that can be displayed vary depending on the source currently being projected. Depending on the model used, some input sources are not supported.

☛ "Automatically Detect Input Signals and Change the Projected Image (Source Search)" [p.29](#)

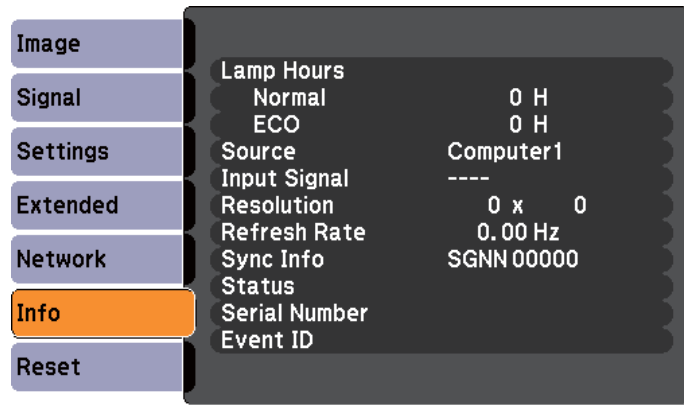

[◀] :Select [Menu] :Exit

Sub-menu	Function
<b>Lamp Hours</b>	You can display the cumulative lamp operating time*. When it reaches the lamp warning time, the characters are displayed in yellow.
<b>Source</b>	You can display the source name for the connected equipment currently being projected.
<b>Input Signal</b>	You can display the content of <b>Input Signal</b> set in the <b>Signal</b> menu according to the source.
<b>Resolution</b>	You can display the resolution.
<b>Video Signal</b>	You can display the settings for <b>Video Signal</b> in the <b>Signal</b> menu.
<b>Refresh Rate</b>	You can display the <u>refresh rate</u> ▶▶.
<b>Sync Info</b>	You can display the image signal Information. It may be needed if service is required.

Sub-menu	Function
<b>Status</b>	This information is about errors that have occurred with the projector. It may be needed if service is required.
<b>Serial Number</b>	Displays the projector's serial number.
<b>Event ID</b>	Displays the application error log. ☛ "About Event ID" <a href="#">p.92</a>

\* The cumulative use time is displayed as "0H" for the first 10 hours. 10 hours and above is displayed as "10H", "11H", and so on.

## Reset Menu

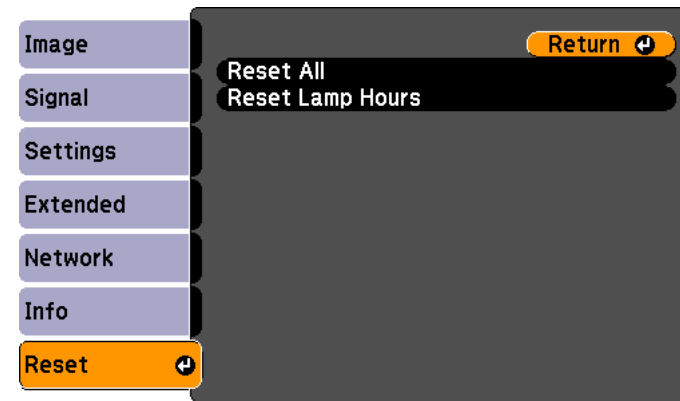

[Esc] / [Return] :Return [◀] :Select [Menu] :Exit

Sub-menu	Function
<b>Reset All</b>	You can reset all items in the Configuration menu to their default settings. The following items are not reset to their defaults: <b>Input Signal</b> , <b>Zoom</b> , <b>User's Logo</b> , all items for <b>Network</b> menus, <b>Lamp Hours</b> , <b>Language</b> , and <b>Password</b> .



Sub-menu	Function
<b>Reset Lamp Hours</b>	Clears the cumulative lamp hours use time. Reset this when you replace the lamp.



# Troubleshooting

This chapter describes how to identify problems and what to do if a problem is found.

If a problem occurs with the projector, the Help screen is displayed to assist you by pressing the Help button. You can solve problems by answering the questions.

- 1 Press the [Help] button.  
The Help screen is displayed.

### Using Remote Control

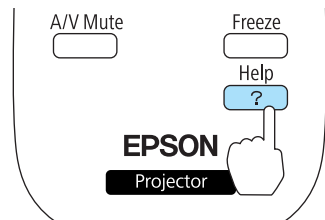

### Using the Control Panel

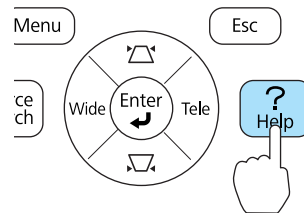

- 2 Select a menu item.

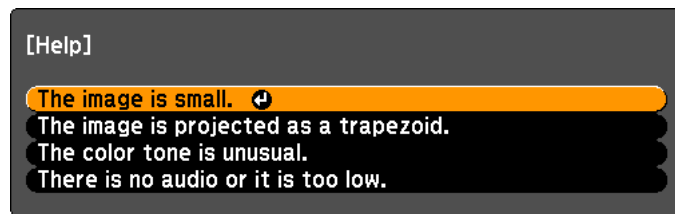

[◀] :Select [▶] :Enter [Help] :Exit

### Using Remote Control

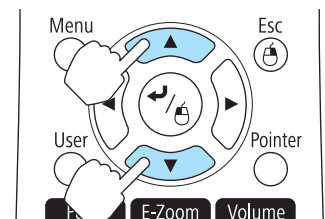

### Using the Control Panel

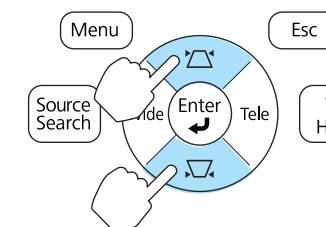

- 3 Confirm the selection.

### Using Remote Control

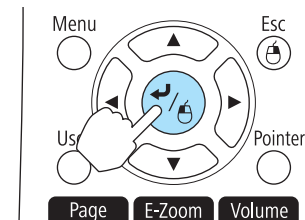

### Using the Control Panel

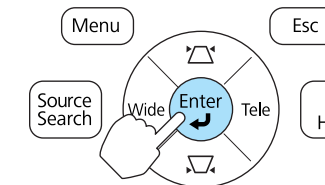

Questions and solutions are displayed as shown on the screen below.  
Press the [Help] button to exit the Help.

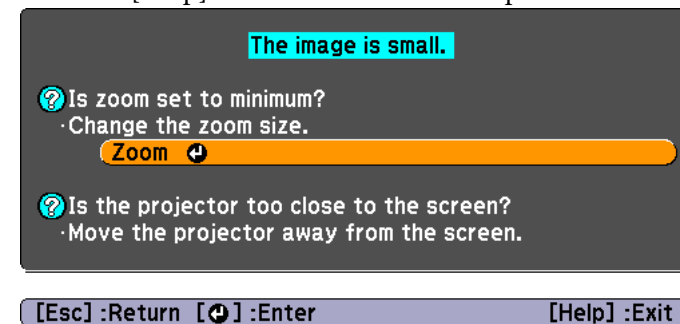

See the following if the Help function does not provide a solution to the problem.  
 "Problem Solving" [p.79](#)

If you are having a problem with the projector, first check the projector's indicators and see "Reading the Indicators".

See the following if the indicators do not show clearly what the problem might be.

☛ "When the Indicators Provide No Help" [p.82](#)



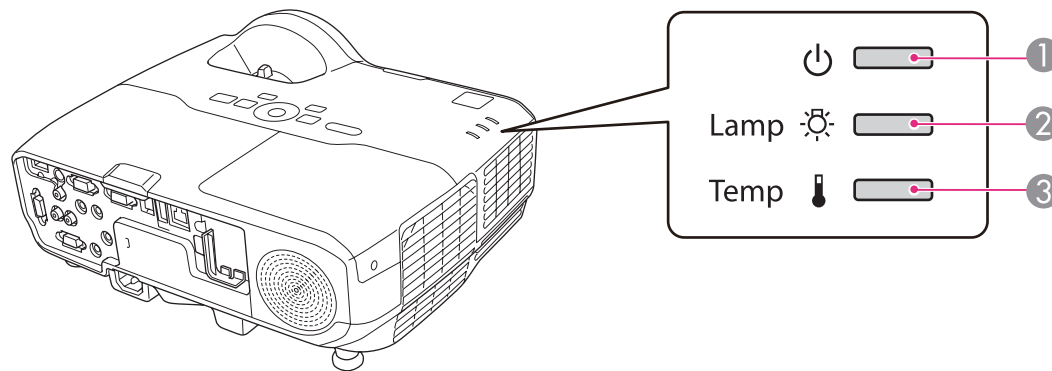

## Reading the Indicators

The projector is provided with the following three indicators that indicate the operating status of the projector.



### ① Power indicator

Indicates the operating status.

-  Standby condition  
When the [⏻] button is pressed in this condition, projection starts.
-  Preparing for network monitoring or cool down in progress  
All buttons are disabled while the indicator is flashing.
-  Warming up  
Warm-up time is about 30 seconds. After warm-up is complete, the indicator stops flashing.  
The [⏻] button is disabled during warm-up.
-  Projecting

### ② Lamp indicator

Indicates the projection lamp status.





### ③ Temp indicator































Indicates the internal temperature status.

See the following table for the status of indicators and how to resolve the problems.



















If all indicators are off, the power cable is not connected correctly or the power is not being supplied.

Sometimes, when the power cable is unplugged, the  indicator remains lit for a short period, but this is not a fault.

 : Lit  : Flashing  : Off  : Varies according to the projector status

Status	Cause	Remedy or Status
     	Internal Error	Stop using the projector, remove the power plug from the electrical outlet, and contact your local dealer or the nearest address provided in the Epson Projector Contact List.  <a href="#">Epson Projector Contact List</a>
     	Fan Error Sensor Error	Stop using the projector, remove the power plug from the electrical outlet, and contact your local dealer or the nearest address provided in the Epson Projector Contact List.  <a href="#">Epson Projector Contact List</a>
     	High Temp Error (overheating)	The lamp turns off automatically and projection stops. Wait for approximately five minutes. After approximately five minutes the projector switches to standby mode, so check the following two points. <ul style="list-style-type: none"> <li>• Check that the air filter and air exhaust vent are not blocked, and that the projector is not positioned against a wall.</li> <li>• If the air filter is clogged, clean or replace it.   <a href="#">"Cleaning the Air Filter" p.94</a>, <a href="#">"Replacing the Air Filter" p.99</a></li> </ul> If the error continues after checking the points above, stop using the projector, remove the power plug from the electrical outlet, and contact your local dealer or the nearest address provided in the Epson Projector Contact List.  <a href="#">Epson Projector Contact List</a>
		When using at an altitude of 1500 m or more, set <b>High Altitude Mode</b> to <b>On</b> .  <a href="#">"Extended Menu" p.64</a>
     	Lamp Error Lamp Failure	Check the following two points. <ul style="list-style-type: none"> <li>• Take out the lamp and check whether it is cracked.   <a href="#">"Replacing the Lamp" p.96</a></li> <li>• Clean the air filter.   <a href="#">"Cleaning the Air Filter" p.94</a></li> </ul>



Status	Cause	Remedy or Status
		<p><b>If it is not cracked:</b> Reinstall the lamp and turn on the power.</p> <p><b>If the error continues:</b> Replace the lamp with a new one and then turn on the power.</p> <p><b>If the error continues:</b> Stop using the projector, remove the power plug from the electrical outlet, and contact your local dealer or the nearest address provided in the Epson Projector Contact List.</p> <p>☛ <a href="#">Epson Projector Contact List</a></p>
		<p><b>If it is cracked:</b> Contact your local dealer or the nearest address provided in the Epson Projector Contact List. (Images cannot be projected until the lamp is replaced.)</p> <p>☛ <a href="#">Epson Projector Contact List</a></p>
		<p>When using at an altitude of 1500 m or more, set <b>High Altitude Mode</b> to <b>On</b>.</p> <p>☛ "Extended Menu" <a href="#">p.64</a></p>
     	Auto Iris Error Power Err.	<p>Stop using the projector, remove the power plug from the electrical outlet, and contact your local dealer or the nearest address provided in the Epson Projector Contact List.</p> <p>☛ <a href="#">Epson Projector Contact List</a></p>
     	High Temp Warning	<p>(This is not an abnormality. However, if the temperature rises too high again, projection stops automatically.)</p> <ul style="list-style-type: none"> <li>• Check that the air filter and air exhaust vent are not blocked, and that the projector is not positioned against a wall.</li> <li>• If the air filter is clogged, clean or replace it.                             <ul style="list-style-type: none"> <li>☛ "Cleaning the Air Filter" <a href="#">p.94</a>, "Replacing the Air Filter" <a href="#">p.99</a></li> </ul> </li> </ul>
     	Replace Lamp	<p>Replace it with a new lamp.</p> <p>☛ "Replacing the Lamp" <a href="#">p.96</a></p> <p>If you continue to use the lamp after the replacement period has passed, the possibility that the lamp may blow increases. Replace it with a new lamp as soon as possible.</p>













- See the following if the projector is not operating properly, even though the indicators are all showing normal.
  - ☛ "When the Indicators Provide No Help" [p.82](#)
- If the indicators are in a state not shown in this table, stop using the projector, remove the power plug from the electrical outlet, and contact your local dealer or the nearest address provided in the Epson Projector Contact List.
  - ☛ [Epson Projector Contact List](#)

## When the Indicators Provide No Help

If any of the following problems occur and the indicators do not offer a solution, refer to the pages given for each problem.

### Problems Relating to Images





<ul style="list-style-type: none"> <li>• <b>No images appear</b> Projection does not start, the projection area is completely black, or the projection area is completely blue.</li> </ul>	 <a href="#">p.83</a>
<ul style="list-style-type: none"> <li>• <b>Moving images are not displayed</b> Moving images played back from a computer appear black and the images are not projected.</li> </ul>	 <a href="#">p.84</a>
<ul style="list-style-type: none"> <li>• <b>Projection stops automatically</b></li> </ul>	 <a href="#">p.84</a>
<ul style="list-style-type: none"> <li>• <b>The message "Not supported" is displayed</b></li> </ul>	 <a href="#">p.84</a>
<ul style="list-style-type: none"> <li>• <b>The message "No Signal" is displayed</b></li> </ul>	 <a href="#">p.84</a>
<ul style="list-style-type: none"> <li>• <b>Images are fuzzy, out of focus, or distorted</b></li> </ul>	 <a href="#">p.85</a>
<ul style="list-style-type: none"> <li>• <b>Interference or distortion appear in images</b></li> </ul>	 <a href="#">p.85</a>
<ul style="list-style-type: none"> <li>• <b>The image is truncated (large) or small, or the aspect ratio is not suitable</b> Only part of the image is displayed, or the height and width ratios of the image are not correct.</li> </ul>	 <a href="#">p.86</a>
<ul style="list-style-type: none"> <li>• <b>Image colors are not right</b> The whole image appears purplish or greenish, images are black &amp; white, or colors appear dull.</li> </ul>	 <a href="#">p.87</a>
<ul style="list-style-type: none"> <li>• <b>Images appear dark</b></li> </ul>	 <a href="#">p.87</a>

### Problems when Projection Starts

<ul style="list-style-type: none"> <li>• <b>The projector does not turn on</b></li> </ul>	 <a href="#">p.88</a>
---	--

### Other Problems

<ul style="list-style-type: none"> <li>• <b>No sound can be heard or the sound is faint</b></li> </ul>	 <a href="#">p.89</a>
--	--

<ul style="list-style-type: none"> <li>• <b>No sound can be heard from the microphone</b></li> </ul>	 <a href="#">p.89</a>
<ul style="list-style-type: none"> <li>• <b>The remote control does not work</b></li> </ul>	 <a href="#">p.90</a>
<ul style="list-style-type: none"> <li>• <b>I want to change the language for messages and menus</b></li> </ul>	 <a href="#">p.90</a>
<ul style="list-style-type: none"> <li>• <b>Mail is not received even if an error occurs with the projector</b></li> </ul>	 <a href="#">p.90</a>

## Problems Relating to Images

### No images appear

Check	Remedy
Did you press the [⏻] button?	Press the [⏻] button to turn the power on.
Are all of the indicators off?	The power cable is not connected correctly or power is not being supplied. Connect the projector's power cable correctly. ☛ "From Installation to Projection" <a href="#">p.28</a> Check the breaker and so on to ensure power is being supplied.
Is A/V Mute active?	Press the [A/V Mute] button on the remote control to cancel A/V Mute. ☛ "Hiding the Image and Sound Temporarily (A/V Mute)" <a href="#">p.44</a>
Is the lens cover attached?	Remove the lens cover.
Are the Configuration menu settings correct?	Reset all of the settings. ☛ <b>Reset - Reset All</b> <a href="#">p.75</a>
Is the image to be projected completely black? (Only when projecting computer images)	Some input images, such as screen savers, may be completely black.
Is the image signal format setting correct? (Only when projecting images from a video source)	Change the setting according to the signal for the connected equipment. ☛ <b>Signal - Video Signal</b> <a href="#">p.61</a>
Is the USB cable connected correctly? (Only when projecting USB Display)	Check that the USB cable is connected correctly. Reconnect it if it is not connected or not connected properly.
Is Windows Media Center displayed in full screen? (Only when projecting using USB Display or network connection)	When Windows Media Center is displayed at full screen, you cannot project using USB Display or network connection. Reduce the screen size.
Is an application using the Windows DirectX function displayed? (Only when projecting using USB Display or network connection)	Applications using the Windows DirectX function may not display images correctly.

## Moving images are not displayed (only the moving image portion turns black)

Check	Remedy
<p>Is the computer's image signal being output to the LCD and the monitor? (Only when projecting images from a laptop computer or a computer with a built-in LCD screen)</p>	<p>Change the image signal from the computer to external output only. Check your computer's documentation, or contact the computer's manufacturer.</p>

## Projection stops automatically

Check	Remedy
<p>Is <b>Sleep Mode</b> set to <b>On</b>?</p>	<p>Press the [⏻] button to turn the power on. If you do not want to use Sleep Mode, change the setting to <b>Off</b>. ☛ <b>Extended - Operation - Sleep Mode</b> <a href="#">p.64</a></p>

## The message "Not supported" is displayed.

Check	Remedy
<p>Is the image signal format setting correct? (Only when projecting images from a video source)</p>	<p>Change the setting according to the signal for the connected equipment. ☛ <b>Signal - Video Signal</b> <a href="#">p.61</a></p>
<p>Do the image signal resolution and refresh rate correspond to the mode? (Only when projecting computer images)</p>	<p>See the documentation supplied with the computer for how to change the image signal resolution and refresh rate output from the computer. ☛ "Supported Monitor Displays" <a href="#">p.122</a></p>

## The message "No Signal" is displayed.

Check	Remedy
<p>Are the cables connected correctly?</p>	<p>Check that all the cables required for projection are securely connected. ☛ "From Installation to Projection" <a href="#">p.28</a></p>
<p>Is the correct port selected?</p>	<p>Change the image by pressing the [Source Search] button on the remote control or the control panel. ☛ "Automatically Detect Input Signals and Change the Projected Image (Source Search)" <a href="#">p.29</a></p>

Check	Remedy
Is the power of the connected computer or video equipment turned on?	Turn the power on for the equipment.
Are the image signals being output to the projector? (Only when projecting images from a laptop computer or a computer with a built-in LCD screen)	<p>If the image signals are only being output to the computer's LCD monitor or accessory monitor, change the output so that the image signals are also output externally. For some computer models, when the image signals are output externally, they no longer appear on the LCD monitor or accessory monitor.</p> <p>If the connection is made while the power of the projector or computer is already turned on, the Fn key (Function key) that changes the computer's image signal to external output may not work. Turn the projector and computer off and then back on again.</p> <ul style="list-style-type: none"> <li>☛ "From Installation to Projection" <a href="#">p.28</a></li> <li>☛ Computer's documentation</li> </ul>

## Images are fuzzy, out of focus, or distorted

Check	Remedy
Is the focus adjusted correctly?	Turn the focus ring to adjust the focus. ☛ "Correcting the Focus" <a href="#">p.38</a>
Is the projector at the correct distance?	Is it projecting outside of the recommended projection distance range? Setup within the recommended range. ☛ "Screen Size and Projection Distance" <a href="#">p.119</a>
Is the Keystone adjustment value too large?	Lower the projection angle to reduce the amount of Keystone correction. ☛ "Adjusting the Image Position" <a href="#">p.37</a>
Has condensation formed on the lens?	If the projector is suddenly taken from a cold environment to a warm environment, or if sudden ambient temperature changes occur, condensation may form on the surface of the lens, and this may cause the images to appear fuzzy. Set the projector up in the room about one hour before it is used. If condensation forms on the lens, turn the projector off and wait for the condensation to disappear.

## Interference or distortion appear in images

Check	Remedy
Is the image signal format setting correct? (Only when projecting images from a video source)	Change the setting according to the signal for the connected equipment. ☛ <b>Signal - Video Signal</b> <a href="#">p.61</a>

Check	Remedy
Are the cables connected correctly?	Check that all the cables required for projection are securely connected. ☛ "Connecting Equipment" <a href="#">p.18</a>
Is an extension cable being used?	If an extension cable is used, electrical interference may affect the signals. Use the cables supplied with the projector to check if the cables you are using may be causing the problem.
Is the correct resolution selected? (Only when projecting computer images)	Set the computer so that the signals being output are compatible with the projector. ☛ "Supported Monitor Displays" <a href="#">p.122</a> ☛ Computer's documentation
Are the <u>Sync</u> and <u>Tracking</u> settings adjusted correctly? (Only when projecting computer images)	Press the [Auto] button on the remote control or the [↵] button on the control panel to perform automatic adjustment. If the images are not adjusted correctly even after performing automatic adjustment, you can also make adjustments from the Configuration menu. ☛ <b>Signal - Tracking, Sync.</b> <a href="#">p.61</a>
Is <b>Transfer layered window</b> selected? (Only when projecting USB Display)	Click <b>All Programs - EPSON Projector - Epson USB Display - Epson USB Display Vx.xx Settings</b> , and then clear the <b>Transfer layered window</b> checkbox.

## The image is truncated (large) or small, or the aspect is not suitable

Check	Remedy
Is a wide-panel computer image being projected? (Only when projecting computer images)	Change the setting according to the signal for the connected equipment. ☛ <b>Signal - Resolution</b> <a href="#">p.61</a>
Is the image still being enlarged by E-Zoom?	Press the [Esc] button on the remote control to cancel E-Zoom. ☛ "Enlarging Part of the Image (E-Zoom)" <a href="#">p.46</a>
Is the display position adjusted correctly?	(Only when projecting analog RGB signals input from the Computer1 or Computer2 port) Press the [Auto] button on the remote control or the [↵] button on the control panel to adjust the position. You can also adjust the position from the Configuration menu. ☛ <b>Signal - Position</b> <a href="#">p.61</a>
Is the computer set for dual display? (Only when projecting computer images)	If dual display is activated in the <b>Display Properties</b> of the computer's Control Panel, only about half of the image on the computer screen is projected. To display the entire image on the computer screen, turn off the dual display setting. ☛ Computer video driver documentation

Check	Remedy
Is the correct resolution selected? (Only when projecting computer images)	Set the computer so that the signals being output are compatible with the projector. <ul style="list-style-type: none"> <li>☛ "Supported Monitor Displays" <a href="#">p.122</a></li> <li>☛ Computer's documentation</li> </ul>

## Image colors are not right

Check	Remedy
Do the input signal settings match the signals from the connected device?	Change the following settings according to the signal for the connected equipment. <ul style="list-style-type: none"> <li>• When the image is from a device connected to the Computer1 or Computer2 port.                             <ul style="list-style-type: none"> <li>☛ <b>Signal - Input Signal</b> <a href="#">p.61</a></li> </ul> </li> <li>• When the image is from a device connected to the Video or S-Video port.                             <ul style="list-style-type: none"> <li>☛ <b>Signal - Video Signal</b> <a href="#">p.61</a></li> </ul> </li> </ul>
Is the image Brightness adjusted correctly?	Adjust the <b>Brightness</b> setting from the Configuration menu. ☛ <b>Image - Brightness</b> <a href="#">p.60</a>
Are the cables connected correctly?	Check that all the cables required for projection are securely connected. ☛ "Connecting Equipment" <a href="#">p.18</a>
Is the <u>contrast</u> adjusted correctly?	Adjust the <b>Contrast</b> setting from the Configuration menu. ☛ <b>Image - Contrast</b> <a href="#">p.60</a>
Is color adjustment set to an appropriate value?	Adjust the <b>Color Adjustment</b> setting from the Configuration menu. ☛ <b>Image - Color Adjustment</b> <a href="#">p.60</a>
Are the color saturation and tint adjusted correctly? (Only when projecting images from a video source)	Adjust the <b>Color Saturation</b> and <b>Tint</b> settings from the Configuration menu. ☛ <b>Image - Color Saturation, Tint</b> <a href="#">p.60</a>

## Images appear dark

Check	Remedy
Is the image brightness set correctly?	Adjust the <b>Brightness</b> and <b>Power Consumption</b> settings from the Configuration menu. ☛ <b>Image - Brightness</b> <a href="#">p.60</a> ☛ <b>Settings - Power Consumption</b> <a href="#">p.63</a>

Check	Remedy
Is the <u>contrast</u> adjusted correctly?	Adjust the <b>Contrast</b> setting from the Configuration menu. ☛ <b>Image - Contrast</b> p.60
Is it time to replace the lamp?	When the lamp is nearly ready for replacement, the images become darker and the color quality declines. Replace the lamp with a new one. ☛ "Replacing the Lamp" p.96

## Problems when Projection Starts

### The projector does not turn on

Check	Remedy
Did you press the [⏻] button?	Press the [⏻] button to turn the power on.
Are all of the indicators off?	The power cable is not connected correctly or power is not being supplied. Disconnect and then reconnect the power cable. ☛ "From Installation to Projection" p.28 Check the breaker and so on to ensure power is being supplied.
Do the indicators turn on and off when the power cable is touched?	There is probably a poor contact in the power cable, or the power cable may be defective. Reinsert the power cable. If this does not solve the problem, stop using the projector, disconnect the power cable from the electrical outlet, and contact your local dealer or the nearest address provided in the Epson Projector Contact List. ☛ <i>Epson Projector Contact List</i>
Is the <b>Control Panel Lock</b> set to <b>Full Lock</b> ?	Press the [⏻] button on the remote control. If you do not want to use <b>Control Panel Lock</b> , change the setting to <b>Off</b> . ☛ <b>Settings - Control Panel Lock</b> p.63
Is the remote receiver set correctly?	Check the <b>Remote Receiver</b> from the Configuration menu. ☛ <b>Settings - Remote Receiver</b> p.63



## Other Problems

### No sound can be heard or the sound is faint

Check	Remedy
Check that the audio/video cable is securely attached to both the projector and audio source.	Disconnect the cable from the audio input port, and then reconnect the cable.
Is the volume adjusted to the minimum setting?	Adjust the volume so that sound can be heard. ● <b>Settings - Volume</b> p.63 ● "Adjusting the Volume" p.38
Is the Mic Input Level set at the maximum?	Lower the Mic Input Level. ● <b>Settings - Mic Input Level</b> p.63
Is A/V Mute active?	Press the [A/V Mute] button on the remote control to cancel A/V Mute. ● "Hiding the Image and Sound Temporarily (A/V Mute)" p.44
Is the audio cable's specification "No resistance"?	When using a commercially available audio cable, make sure it is labeled "No resistance".
Is it connected with an HDMI cable?	If no audio is output when connecting via an HDMI cable, set the connected equipment to PCM output.
Is <b>Output audio from the projector</b> selected? (Only when projecting USB Display)	Click <b>All Programs - EPSON Projector - Epson USB Display - Epson USB Display Vx.xx Settings</b> , and then select <b>Output audio from the projector</b> .
Is the correct audio input selected?	Check the <b>Audio Input</b> from the configuration menu. ● <b>Extended - Operation - Audio Input</b> p.64

### No sound can be heard from the microphone

Check	Remedy
Is the microphone connected correctly?	Disconnect the cable from the Mic port, and then reconnect the cable. ● "Connecting External Equipment" p.24
Is the microphone input volume turned down too low?	Adjust the microphone input volume so that sound can be heard. ● <b>Settings - Mic Input Level</b> p.63

## The remote control does not work

Check	Remedy
Is the remote control light-emitting area pointing towards the remote receiver on the projector during operation?	Point the remote control towards the remote receiver during operation. ☛ "Remote control operating range" <a href="#">p.15</a>
Is the remote control too far from the projector?	The operating range for the remote control is about 6 m. ☛ "Remote control operating range" <a href="#">p.15</a>
Is direct sunlight or strong light from fluorescent lamps shining onto the remote receiver?	Set the projector up in a location where strong light does not shine onto the remote receiver. Or set the remote receiver to <b>Off</b> from <b>Remote Receiver</b> in the Configuration menu. ☛ <a href="#">Settings - Remote Receiver p.63</a>
Is the correct setting for the <b>Remote Receiver</b> selected?	Check the <b>Remote Receiver</b> from the Configuration menu. ☛ <a href="#">Settings - Remote Receiver p.63</a>
Are the batteries dead or have the batteries been inserted in the wrong direction?	Insert new batteries in the correct direction. ☛ "Replacing the remote control batteries" <a href="#">p.15</a>

## I want to change the language for messages and menus

Check	Remedy
Change the language setting.	Adjust the Language setting from the Configuration menu. ☛ <a href="#">Extended - Language p.64</a>

## Mail is not received even if an error occurs with the projector



Check	Remedy
Is <b>Standby Mode</b> set to <b>Communication On</b> ?	To use the Mail Notification function when the projector is in standby, set <b>Communication On</b> in <b>Standby Mode</b> from the Configuration menu. ☛ <a href="#">Extended - Standby Mode p.64</a>
Did a fatal abnormality occur and the projector come to a sudden stop?	When the projector comes to a sudden stop, email cannot be sent. If the abnormal state continues, contact your local dealer or the nearest address provided in the Epson Projector Contact List. ☛ <a href="#">Epson Projector Contact List</a>



Check	Remedy
Is power being supplied to the projector?	Check that your electrical outlet or power source is functioning correctly.
Is the Mail Notification function set correctly in the Configuration menu?	An error notification email is sent according to the <b>Mail</b> settings in the Configuration menu. Check if it is set correctly. ☛ "Mail menu" <a href="#">p.72</a>

Check the numbers and then apply the following countermeasures. If you cannot resolve the problem, contact your network administrator, or contact your local dealer or the nearest address provided in the Epson Projector Contact List.

 [Epson Projector Contact List](#)

Event ID	Cause	Remedy
0432 0435	Failed to startup EasyMP Network Projection.	Restart the projector.
0434 0482 0484 0485	Network communication is unstable.	Check the network communication status, and reconnect after waiting for a while.
0433	Cannot play transferred images.	Restart EasyMP Network Projection.
0481	Communication was disconnected from the computer.	
0483 04FE	EasyMP Network Projection ended unexpectedly.	Check the network communication status, and then restart the projector.
0479 04FF	A system error occurred in the projector.	Restart the projector.
0891	Cannot find an access point with the same SSID.	Set the computer, the access point, and the projector to the same SSID.
0892	The WPA/WPA2 authentication type does not match.	Check that the wireless LAN security settings are correct.
0893	The WEP/TKIP/AES encryption type does not match.	 <a href="#">Security p.70</a>
0894	Communication was disconnected because the projector connected to an unauthorized access point.	Contact your network administrator for more information.
0898	Failed to acquire DHCP.	Check that the DHCP server is operating correctly. If you are not using DHCP, turn off the DHCP setting.  <a href="#">Wireless LAN - IP Settings p.68</a>
0899	Other communication errors	If restarting the projector or EasyMP Network Projection does not solve the problem, contact your local dealer or the nearest address provided in the Epson Projector Contact List.  <a href="#">Epson Projector Contact List</a>



# Maintenance

This chapter provides information on maintenance procedures to ensure the best level of performance from the projector for a long time to come.

You should clean the projector if it becomes dirty or if the quality of projected images starts to deteriorate.

### Attention

Turn off the projector's power before cleaning.

## Cleaning the Projector's Surface

Clean the projector's surface by wiping it gently with a soft cloth.

If the projector is particularly dirty, moisten the cloth with water containing a small amount of neutral detergent, and then firmly wring the cloth dry before using it to wipe the projector's surface.

### Attention

Do not use volatile substances such as wax, alcohol, or thinner to clean the projector's surface. The quality of the case may change or become discolored.

## Cleaning the Lens

Use a commercially available cloth for cleaning glasses to gently wipe the lens.

### Warning

Do not use sprays that contain flammable gas to remove dirt and dust from the lens. The projector may catch fire because of the high temperature of the lamp inside the projector.

### Attention

Do not rub the lens with harsh materials or subject the lens to shocks, as it can easily become damaged.

## Cleaning the Air Filter

Clean the air filter and the air intake vent when the following message is displayed.

"The projector is overheating. Make sure nothing is blocking the air vent, and clean or replace the air filter."

### Attention

- Dust collecting on the air filter may cause the internal temperature of the projector to rise, leading to a malfunction or early deterioration of optical parts. Clean the air filter immediately when the message is displayed.
- Do not rinse the air filter in water. Do not use detergents or solvents.

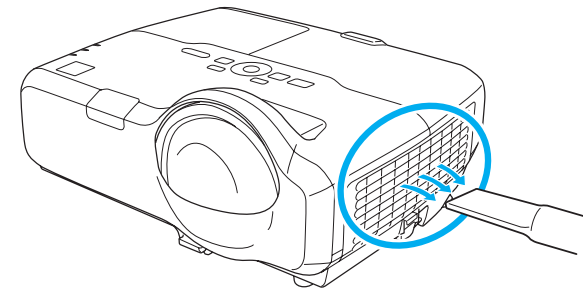



- If a message is frequently displayed, even after cleaning, it is time to replace the air filter. Replace it with a new air filter.
  - ☛ "Replacing the Air Filter" [p.99](#)
- It is recommended that you clean these parts at least once every three months. Clean them more often than this if using the projector in a particularly dusty environment.

This section explains how to replace the lamp and the air filter.

## Replacing the Lamp

### Lamp replacement period

It is time to replace the lamp when:

- The following message is displayed.  
"It is time to replace your lamp. Please contact your Epson projector reseller or visit [www.epson.com](http://www.epson.com) to purchase."

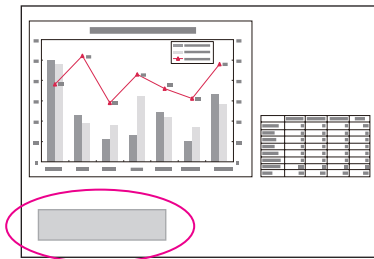

The message is displayed for 30 seconds.

- The lamp indicator flashes orange.

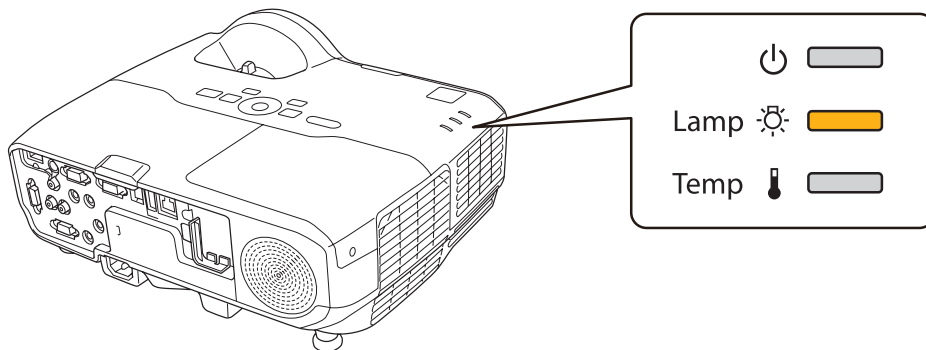

- The projected image gets darker or starts to deteriorate.

### Attention

- The lamp replacement message is set to appear after the following time periods in order to maintain the initial brightness and quality of the projected images.

#### EB-435W/EB-430

When **Power Consumption** is set to **Normal**: About 3900 hours

When **Power Consumption** is set to **ECO**: About 5900 hours

#### EB-425W/EB-420

When **Power Consumption** is set to **Normal**: About 4900 hours

When **Power Consumption** is set to **ECO**: About 5900 hours

☛ **Settings - Power Consumption p.63**

- If you continue to use the lamp after the replacement period has passed, the possibility that the lamp may blow increases. When the lamp replacement message is displayed, replace the lamp with a new one as soon as possible, even if it is still working.
- Do not repeatedly turn off the power and immediately back on. Turning the power on and off frequently may shorten the lamp's operating life.
- Depending on the individual characteristics of the lamp and the way it has been used, the lamp may become darker or stop working before the message is displayed. You should always have a spare lamp unit ready in case it is needed.

### How to replace the lamp

The lamp can be replaced even when the projector is suspended from a wall or ceiling.



## Warning

- When replacing the lamp because it has stopped working, there is a possibility that the lamp may be cracked. When replacing the lamp of a projector that has been installed on a wall or ceiling, assume that the lamp is cracked and stand to the side of the lamp cover, not underneath it. Also, remove the lamp cover gently.
- Never disassemble or modify a lamp. If a modified or disassembled lamp is installed in the projector and used, it could cause a fire, electric shock, or an accident.

## Caution

Wait until the lamp has cooled down sufficiently before removing the lamp cover. If the lamp is still hot, burns or other injuries may result. It takes approximately one hour after the power has been turned off for the lamp to sufficiently cool down.

- 1** After you turn off the projector's power and the confirmation buzzer beeps twice, disconnect the power cable.
- 2** Wait until the lamp has sufficiently cooled down, and then remove the lamp cover at the top of the projector.  
Loosen the lamp cover fixing screw with the screwdriver supplied with the new lamp unit or a Phillips (+) screwdriver. Then slide the lamp cover straight forward and lift to remove it.

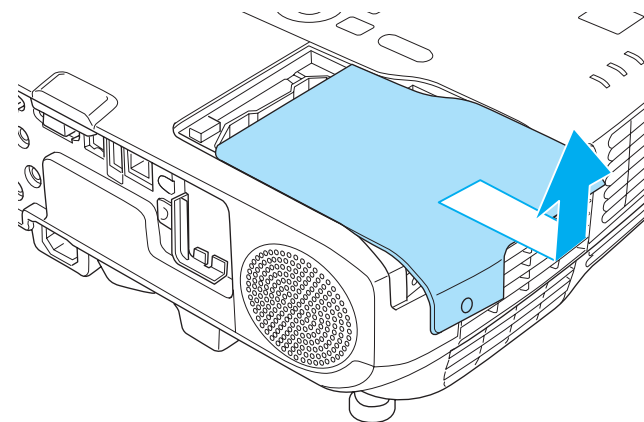
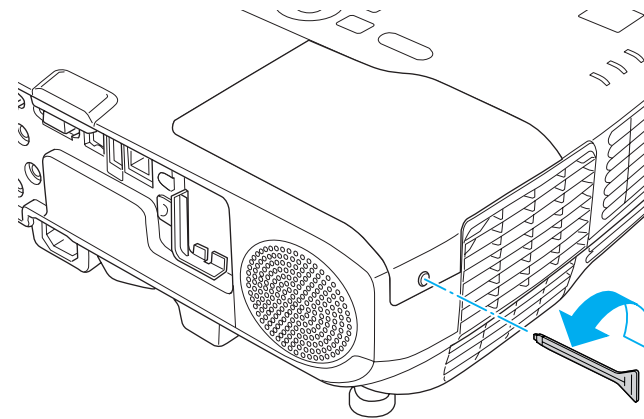

- 3** Loosen the two lamp fixing screws.

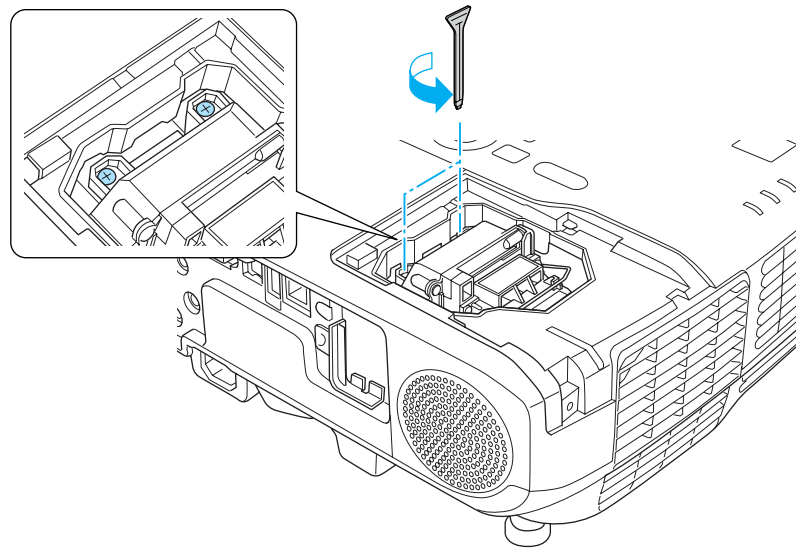

- 4** Remove the old lamp by pulling the handle.  
If the lamp is cracked, replace it with a new lamp, or contact your local dealer for further advice.

 [Epson Projector Contact List](#)

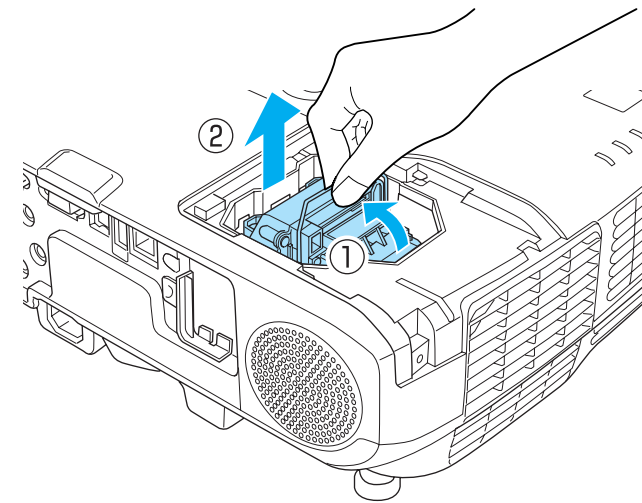

- 5** Install the new lamp.  
Insert the new lamp along the guide rail in the correct direction so that it fits in place, push in firmly, and once it is fully inserted tighten the two screws.

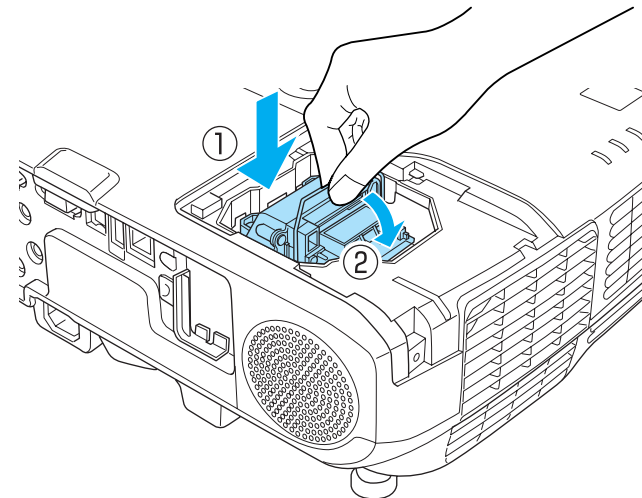

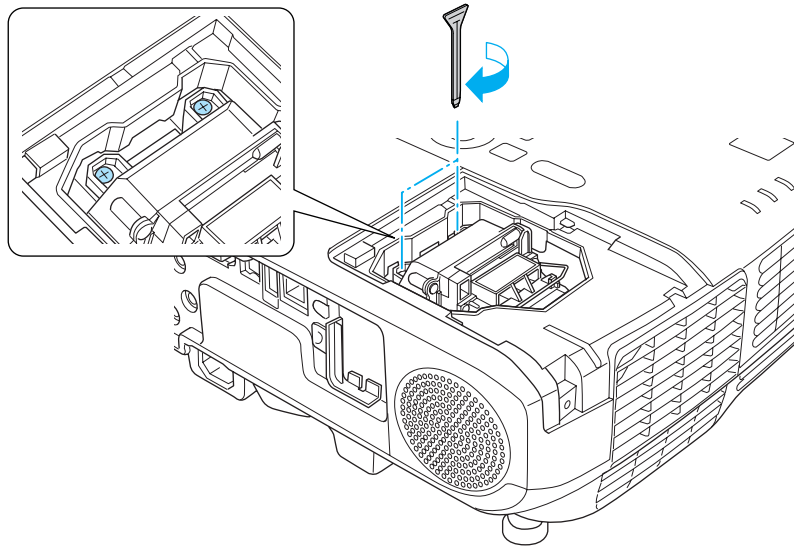

**6** Attach the lamp cover.

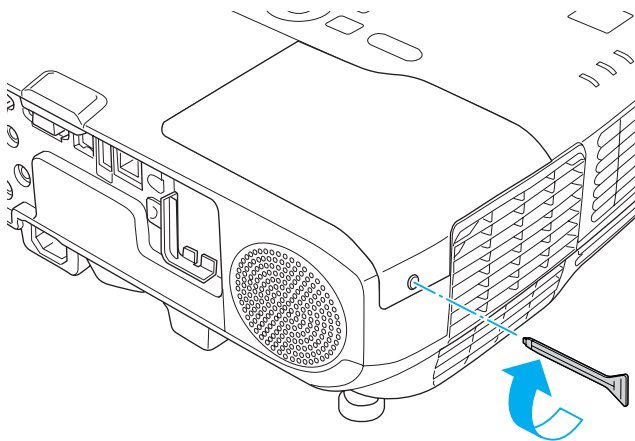

**Attention**

- Make sure you install the lamp securely. If the lamp cover is removed, the power turns off automatically as a safety precaution. If the lamp or the lamp cover is not installed correctly, the power does not turn on.
- This product includes a lamp component that contains mercury (Hg). Please consult your local regulations regarding disposal or recycling. Do not dispose of it with normal waste.

### Resetting the lamp hours

The projector records how long the lamp is on and a message and indicator notify you when it is time to replace the lamp. After replacing the lamp, make sure you reset the lamp hours from the Configuration menu.

☛ "Reset Menu" [p.75](#)

 Only reset the lamp hours after the lamp has been replaced. Otherwise, the lamp replacement period will not be indicated correctly.

## Replacing the Air Filter

### Air filter replacement period

If the message is displayed frequently even though the air filter has been cleaned, replace the air filter.

### How to replace the air filter

The air filter can be replaced even when the projector is suspended from a wall or ceiling.

**1** After you turn off the projector's power and the confirmation buzzer beeps twice, disconnect the power cable.

**2** Open the air filter cover.  
Press the tabs on the air filter cover and open the cover.

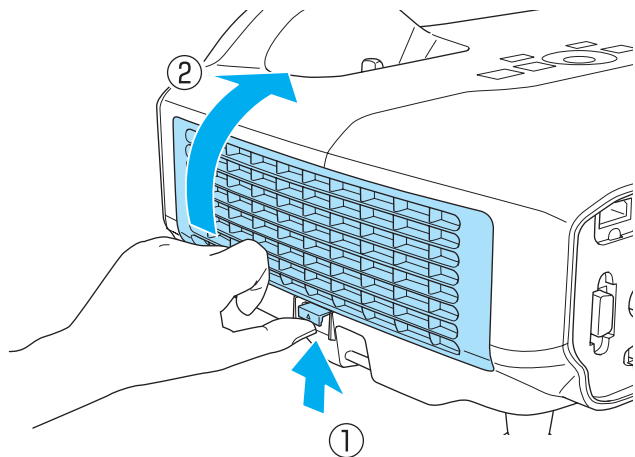

**3** Remove the air filter.  
Grip the tab in the center of the air filter, and pull the air filter straight out.

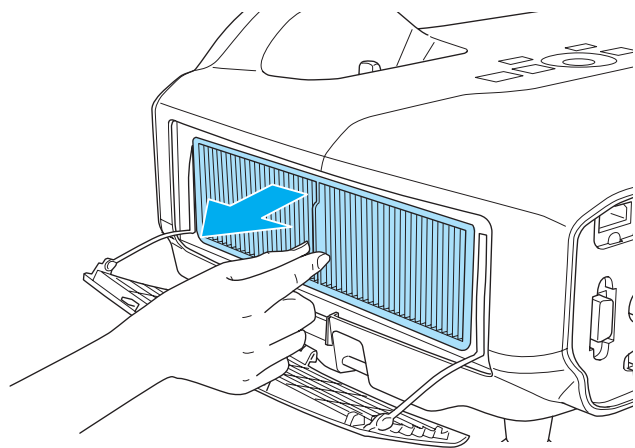

**4** Install the new air filter.

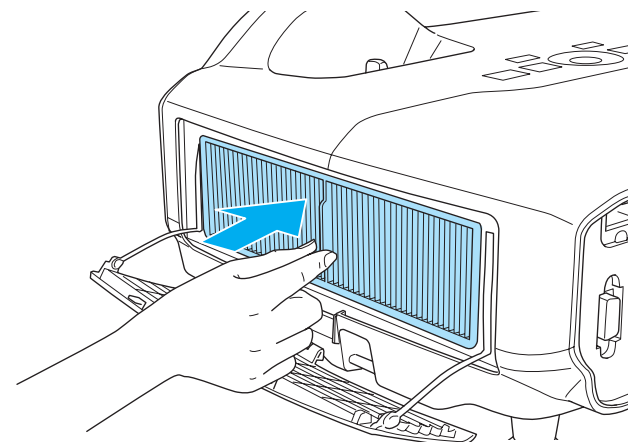

**5** Close the air filter cover.

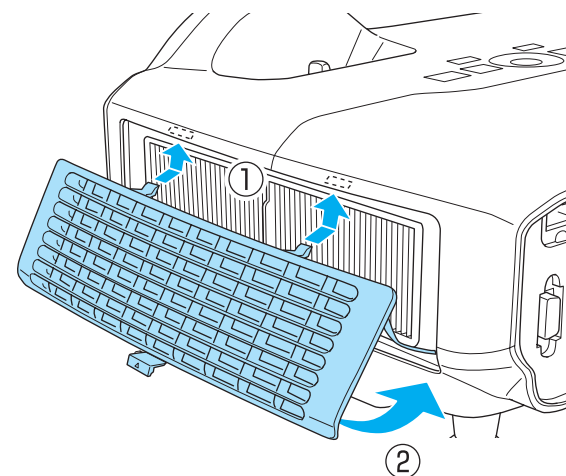



Dispose of used air filters properly in accordance with your local regulations.

Material of the frame part: Polypropylene

Material of the filter part: Polypropylene



# Appendix

## Projecting Without a Computer (Slideshow)

By connecting a USB storage device such as a USB memory or a USB hard disk to the projector, you can project the files stored on the device without using a computer. This function is called Slideshow.



- You may not be able to use USB storage devices that incorporate security functions.
- You cannot correct keystone distortion while projecting a Slideshow, even if you press the [↶] and [↷] buttons on the control panel.

## Specifications for files that can be projected using Slideshow

Type	File Type (Extension)	Notes
Image	.jpg	The following cannot be projected. - CMYK color mode format - Progressive format - Images with a resolution greater than 8192x8192 Due to the characteristics of JPEG files, images may not be projected clearly if the compression ratio is too high.
	.bmp	Cannot project images with a resolution greater than 1280x800.
	.gif	<ul style="list-style-type: none"> <li>• Cannot project images with a resolution greater than 1280x800.</li> <li>• Cannot project animated GIFs.</li> </ul>
	.png	Cannot project images with a resolution greater than 1280x800.



- When connecting and using a USB-compatible hard disk, make sure you connect the AC adaptor supplied with the hard disk.
- The projector does not support some file systems, so use media that has been formatted in Windows.
- Format the media in FAT16/32.

## Slideshow examples

### Projecting images stored on USB storage



- ☛ "Projecting the selected image" [p.105](#)
- ☛ "Projecting image files in a folder in sequence (Slideshow)" [p.106](#)

## Slideshow operating methods

Although the following steps are explained based on the remote control, you can perform the same operations from the control panel.

### Starting Slideshow

**1**

Change the source to USB.





- ☛ "Switching to the Target Image Using the Remote Control" [p.30](#)

## 2 Connect the USB storage device or digital camera to the projector.

☛ "Connecting USB Devices" p.22

Slideshow starts and the file list screen is displayed.

- JPEG files are displayed as thumbnails (file contents are displayed as small images).
- Other files or folders are displayed as icons as shown in the following table.

Icon	File	Icon	File
	JPEG files*		BMP files
	GIF files		PNG files

\* When it cannot be displayed as a thumbnail, it is displayed as an icon.



- You can also insert a memory card into a USB card reader and then connect the reader to the projector. However, some commercially available USB card readers may not be compatible with the projector.
- If the following screen (Select Drive screen) is displayed, press the [▲], [▼], [◀], and [▶] buttons to select the drive you want to use, and then press the [↵] button.

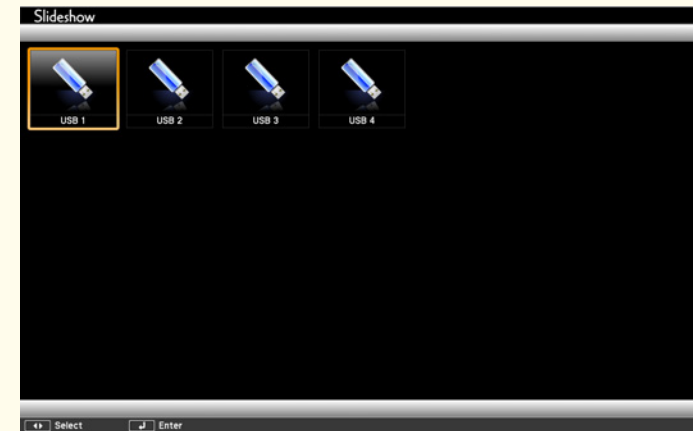

- To display the Select Drive screen, position the cursor on **Select Drive** at the top of the file list screen, and then press the [↵] button.

### Projecting images

- 1 Use the [▲], [▼], [◀], and [▶] buttons to select the file or folder you want to project.





If not all of the files and folders are displayed on the current screen, press the [↓] button on the remote control, or position the cursor on **Next Page** at the bottom of the screen and press the [↵] button.

To return to the previous screen, press the [↑] button on the remote control, or position the cursor on **Previous Page** at the top of the screen and press the [↵] button.

**2** Press the [↵] button.

The selected image is displayed.

When a folder is selected, the files in the selected folder are displayed. To return to the previous screen, position the cursor on **Back to Top** and press the [↵] button.

## Rotating images

You can rotate the played images in 90° increments. The rotating function is also available during Slideshow.

**1** Play images, or run Slideshow.

**2** While projecting, press the [▲] or [▼] button.

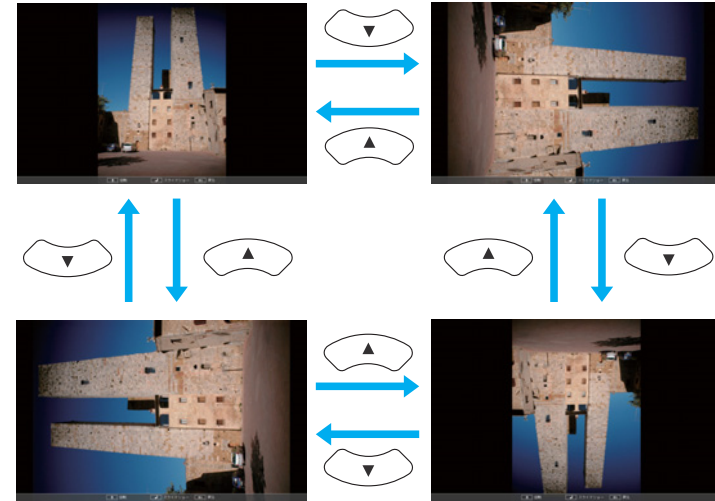

## Stopping Slideshow

To close Slideshow, disconnect the USB device from the USB port on the projector. For devices such as digital cameras or hard disks, turn off the device and then remove it from the projector.

## Projecting the selected image





### Attention

Do not disconnect the USB storage device while it is being accessed. Slideshow may not operate correctly.

**1** Start Slideshow.

The file list screen is displayed.



☛ "Starting Slideshow" p.103

- 2 Press the , , , and  buttons to select the image file you want to project.



- 3 Press the  button.  
The image is displayed.



Press the ,  buttons to move to the next or previous image file.







- 4 Press the [Esc] button to return to the file list screen.

## Projecting image files in a folder in sequence (Slideshow)

You can project the image files in a folder in sequence, one at a time. This function is called Slideshow. Use the following procedure to run Slideshow.



To change files automatically when you run Slideshow, set **Screen Switching Time** from **Option** in Slideshow to anything other than **No**. The default setting is 3 seconds.

- 1 Start Slideshow.  
The file list screen is displayed.  
☛ "Starting Slideshow" [p.103](#)
- 2 Use the , , , and  buttons to position the cursor over the folder for the Slideshow that you want to run, and then press the  button.
- 3 Select **Slideshow** at the bottom right of the file list screen, and then press the  button.  
Slideshow starts, and the image files in the folder are automatically projected in sequence, one at a time.  
When the last file is projected, the file list is displayed again automatically. If you set **Continuous Play** to **On** in the Option window, projection starts again from the beginning when it reaches the end.  
☛ "Image file display settings and Slideshow operation settings" [p.107](#)  
You can proceed to the next screen, return to the previous screen, or stop playback while projecting a Slideshow.



If **Screen Switching Time** on the Option screen is set to **No**, files do not change automatically when you select Play Slideshow. Press the [⏪] button, the [⏩] button, or the [⏹] button to continue to the next file.

You can use the following functions when projecting an image file with Slideshow.

- Freeze
  - ☛ "Freezing the Image (Freeze)" p.44
- A/V Mute
  - ☛ "Hiding the Image and Sound Temporarily (A/V Mute)" p.44
- E-Zoom
  - ☛ "Enlarging Part of the Image (E-Zoom)" p.46

### Image file display settings and Slideshow operation settings

You can set the file display order and Slideshow operations on the Option screen.

- 1** Press the [⏪], [⏩], [⏹] and [⏸] buttons to position the cursor over the folder where you want to set display conditions, and then press the [Esc] button. Select **Option** from the submenu displayed, then press the [⏩] button.
- 2** When the following Option screen is displayed, set each of the items.  
 Enable settings by positioning the cursor on the target item and pressing the [⏩] button.  
 The following table shows the details for each item.



<b>Display Order</b>	You can select to display the files in <b>Name Order</b> or <b>Date Order</b> .
<b>Sort Order</b>	You can select to sort the files <b>In Ascending</b> or <b>In Descending</b> order.
<b>Continuous Play</b>	You can set whether to repeat the Slideshow.
<b>Screen Switching Time</b>	You can set the time for a single file to be displayed in Play Slideshow. You can set a time between <b>No</b> (0) to 60 Seconds. When you set <b>No</b> , auto play is disabled.
<b>Effect</b>	You can set the screen effects when changing slides.

- 3** When you have finished making settings, use the [⏪], [⏩], [⏹], and [⏸] buttons to position the cursor over **OK**, and then press the [⏩] button.  
 The settings are applied.  
 If you do not want to apply the settings, position the cursor on **Cancel**, and then press the [⏩] button.

## About EasyMP Monitor

EasyMP Monitor lets you carry out operations such as checking the status of multiple Epson projectors that are connected to a network at a computer monitor, and controlling the projectors from the computer.

You can download EasyMP Monitor from the following Web site.

<http://www.epson.com>

The following provides brief descriptions of the monitoring and control functions that can be carried out using EasyMP Monitor.

- **Registering projectors for monitoring and control**

Projectors on the network can be searched for automatically, and you can then select which projectors you want to register from the projectors that are detected.

You can register target projectors by entering their IP addresses.

- **Registered projectors can also be assigned to groups so that they can be monitored and controlled in groups.**

- **Monitoring the status of registered projectors**

You can check the power status (ON/OFF) for projectors and problems or warnings that require attention by using the icons.

You can select groups of projectors or a single projector and then check the cumulative lamp operating time or information such as input sources, problems, and warnings for the projectors.

- **Controlling registered projectors**

Projectors can be selected in groups or as single projectors, and you can then carry out operations for the selected projectors such as turning the power on and off and switching their input sources.

You can use Web Control functions to change the settings in the projector's configuration menu.

If there are certain control actions which are carried out regularly at particular times or on particular days, you can use Timer Settings to register timer settings.

- **Mail Notification settings**

You can set e-mail addresses to which notifications are sent if a status that requires attention, such as a problem, occurs with a registered projector.

- **Sending messages to registered projectors**

You can use the Message Broadcasting plugin for EasyMP Monitor to send JPEG files to registered projectors.

Download the Message Broadcasting plugin from the Web site address provided at the beginning of this chapter.

## Changing Settings Using a Web Browser (Web Control)

By using the Web browser of a computer connected to the projector on a network, you can set the projector's functions and control the projector. This function allows you to perform setup and control operations remotely. In addition, since you can use the computer's keyboard, entering characters required for the setup is easier.

Use Microsoft Internet Explorer 6.0 or later as the Web browser. If using a Mac OS, use Safari or Firefox.



If you set **Standby Mode to Communication On**, you can use a Web browser to make settings and perform control even if the projector is in standby mode (when the power is off).

☛ **Extended - Standby Mode** [p.64](#)

## Projector setup

In a Web browser, you can set items that are usually set in the projector's Configuration menu. The settings are reflected in the Configuration menu. There are also items that can only be set in a Web browser.

Items in the Configuration menu that cannot be set by a Web browser

- Settings menu - Keystone - Quick Corner
- Settings menu - Pointer Shape
- Settings menu - Pattern
- Settings menu - User Button
- Extended menu - User's Logo
- Extended menu - Language
- Extended menu - Operation - High Altitude Mode
- Reset menu - Reset All and Reset Lamp Hours

The settings for items on each menu are the same as the projector's Configuration menu.

☛ "Configuration Menu" p.56

Items that can only be set with a Web browser

- SNMP Community Name
- Monitor Password

## Displaying the Web Control screen

Use the following procedure to display the Web Control screen.

Make sure the computer and projector are connected to the network. Use Advanced when connecting via a Wireless LAN.



If your Web browser is set up to connect via a proxy server, the Web Control screen cannot be displayed. To display Web Control, you need to make settings so that a proxy server is not used for a connection.

- 1 Start a Web browser on the computer.

- 2 Enter the IP address of the projector in the address input box of the Web browser, and press the Enter key on the computer's keyboard.

The Web Control screen is displayed.

When Web Control Password is set in the Network menu from the projector's Configuration menu, the password entry screen is displayed.

## Displaying the Web Remote screen

The Web Remote function allows you to perform projector remote control operations with a Web browser.

- 1 Display the Web Control screen.
- 2 Click **Web Remote**.

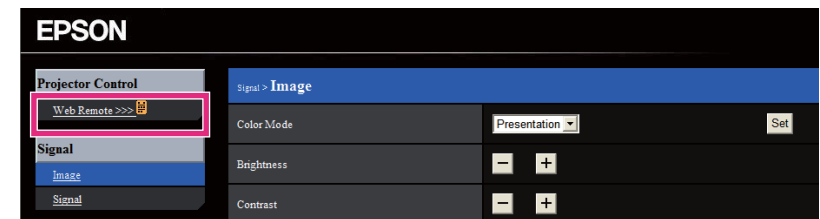

- 3 The Web Remote screen is displayed.

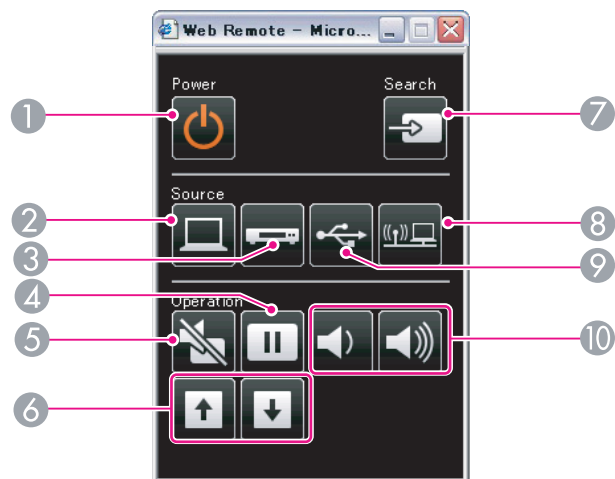

Name	Function
① [Power] button	Turns the projector power on or off. ☛ "From Installation to Projection" p.28
② [Computer] button	Each time you press the button, the input changes between images from the Computer1 port and the Computer2 port.
③ [Video] button	Each time the button is pressed, the image cycles through Video, S-Video, and HDMI ports.
④ [Freeze] button	Pauses or resumes image playback. ☛ "Freezing the Image (Freeze)" p.44
⑤ [A/V Mute] button	Turns the video and audio on or off. ☛ "Hiding the Image and Sound Temporarily (A/V Mute)" p.44

Name	Function
⑥ [Page] buttons [Up] [Down]	Changes pages in files such as PowerPoint files when using the following projection methods. <ul style="list-style-type: none"> <li>• When using the Wireless Mouse function                             <ul style="list-style-type: none"> <li>☛ "Using the Remote Control to Operate the Mouse Pointer (Wireless Mouse)" p.47</li> </ul> </li> <li>• When using USB Display                             <ul style="list-style-type: none"> <li>☛ "Projecting with USB Display" p.30</li> </ul> </li> <li>• When connecting to a network</li> </ul> When projecting images using Slideshow, pressing these buttons displays the previous/next image file.
⑦ [Source Search] button	Switches to the image from the input port where video signals are being input. ☛ "Automatically Detect Input Signals and Change the Projected Image (Source Search)" p.29
⑧ [LAN] button	Changes to the images projected with EasyMP Network Projection. When projecting using the optional Quick Wireless Connection USB Key, this button switches to that image. ☛ "Switching to the Target Image Using the Remote Control" p.30
⑨ [USB] button	Each time the button is pressed, it cycles through the following images: <ul style="list-style-type: none"> <li>• USB Display</li> <li>• Images from the device connected to the USB(TypeA) port</li> </ul> ☛ "Switching to the Target Image Using the Remote Control" p.30
⑩ [Volume] buttons [Left] [Right]	[Left] Decreases the volume. [Right] Increases the volume. ☛ "Adjusting the Volume" p.38

## Using the Mail Notification Function to Report Problems

When you set Mail Notification, notification messages are sent to the preset email addresses when a problem or warning occurs with a projector. This will enable the operator to be notified of problems with projectors even at locations away from the projectors.

☛ **Network - Mail - Mail Notification** [p.72](#)



- Up to a maximum of three notification destinations (addresses) can be registered, and notification messages can be sent to all three destinations at once.
- If a projector develops a critical problem and suddenly stops working, it may not be able to send a message notifying an operator of the problem.
- Controlling is possible if **Standby Mode** is set to **Communication On**, even if the projector is in standby state (when the power is off).

☛ **Extended - Standby Mode** [p.64](#)

### Reading Error Notification Mail

When the Mail Notification function is set to On and a problem or warning occurs in the projector, the following email will be sent.

Subject: EPSON Projector

Line 1: The name of the projector where the problem occurred

Line 2: The IP address set for the projector where the problem has occurred.

Line 3 and on: Details of the problem

The details of the problem are listed line by line. The main message contents are listed below.

- Internal error
- Fan related error
- Sensor error
- Lamp timer failure
- Lamp out
- Internal temperature error
- High-speed cooling in progress
- Lamp replacement notification
- No-signal  
No Signal is input to the projector. Check the connection status or check that the power for the signal source is turned on.
- Auto Iris Error
- Power Err. (Ballast)

See the following to deal with problems or warnings.

☛ "Reading the Indicators" [p.79](#)

## Management Using SNMP

By setting **SNMP** to **On** in the Configuration menu, notification messages are sent to the specified computer when a problem or warning occurs. This will enable the operator to be notified of problems with projectors even at locations away from the projectors.

☛ **Network - Others - SNMP** [p.73](#)



- SNMP should be managed by a network administrator or someone who is familiar with the network.
- To use the SNMP function to monitor the projector, you need to install the SNMP manager program on your computer.
- The managing function using SNMP cannot be used via wireless LAN in Quick connection mode.
- Up to two destination IP addresses can be saved.

## ESC/VP21 Commands

You can control the projector from an external device using ESC/VP21.

### Command list

When the power ON command is transmitted to the projector, the power turns on and it enters warm-up mode. When the projector's power has turned on, a colon ":" (3Ah) is returned.

When a command is input, the projector executes the command and returns a ":"; and then accepts the next command.

If the command being processed terminates abnormally, an error message is output and a ":" is returned.

The main contents are listed below.

Item		Command	
Power ON/OFF	On	PWR ON	
	Off	PWR OFF	
Signal selection	Computer1	Auto	SOURCE 1F
		RGB	SOURCE 11
		Component	SOURCE 14
	Computer2	Auto	SOURCE 2F

Item		Command
	RGB	SOURCE 21
	Component	SOURCE 24
	HDMI	SOURCE 30
	Video	SOURCE 41
	S-Video	SOURCE 42
	USB Display	SOURCE 51
	USB	SOURCE 52
	LAN	SOURCE 53
A/V Mute ON/OFF	On	MUTE ON
	Off	MUTE OFF

Add a Carriage Return (CR) code (0Dh) to the end of each command and transmit.

For more details, contact your local dealer or the nearest address provided in the Epson Projector Contact List.

 [Epson Projector Contact List](#)

### Cable layouts

Serial connection

- Connector shape: D-Sub 9-pin (male)



- Projector input port name: RS-232C

<At the projector>

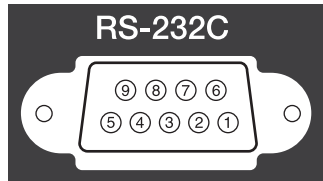

<At the computer>

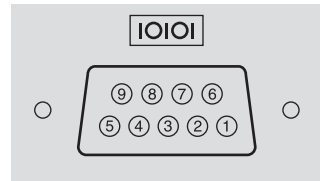

<At the projector>

(PC serial cable)

<At the computer>

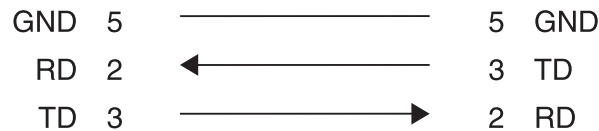

Signal Name	Function
GND	Signal wire ground
TD	Transmit data
RD	Receive data

Communications protocol

- Default baud rate setting: 9600 bps
- Data length: 8 bit
- Parity: None
- Stop-bit: 1 bit
- Flow control: None

## About PJLink

PJLink Class1 was established by the JBMIA (Japan Business Machine and Information System Industries Association) as a standard protocol for controlling network-compatible projector's as part of their efforts to standardize projector control protocols.

The projector complies with the PJLink Class1 standard established by the JBMIA.

See the following for more information on network settings related to PJLink.

☛ "Network Menu" [p.66](#)

It complies with all commands except for the following commands defined by PJLink Class1, and agreement was confirmed by the PJLink standard adaptability verification.

URL:<http://pjlink.jbmia.or.jp/english/>

- **Non-compatible commands**

	Function	PJLink Command
Mute settings	Image muting set	AVMT 11
	Audio muting set	AVMT 21

- **Input names defined by PJLink and corresponding projector sources**

Source	PJLink Command
Computer1	INPT 11
Computer2	INPT 12
Video	INPT 21
S-Video	INPT 22
HDMI	INPT 32
USB	INPT 41

Source	PJLink Command
LAN	INPT 52
USB Display	INPT 53

- Manufacturer name displayed for "Manufacture name information query"  
EPSON
- Model name displayed for "Product name information query"  
EB-420/CS500XN/PowerLite 420  
EB-425W/CS500WN/PowerLite 425W  
EB-435W/CS520WN/PowerLite 435W  
EB-430/CS510XN/PowerLite 430

## About Crestron RoomView®

Crestron RoomView® is an integrated control system provided by Crestron®. It can be used to monitor and control multiple devices connected on a network.

The projector supports the control protocol, and can therefore be used in a system built with Crestron RoomView®.

Visit the Crestron® Web site for details on Crestron RoomView®.

<http://www.crestron.com>

The following provides an overview of Crestron RoomView®.

- **Remote operation using a Web browser**  
You can operate a projector from your computer just like using a remote control.

### • Monitoring and control with application software

You can use Crestron RoomView® Express or Crestron RoomView® Server Edition provided by Crestron® to monitor devices in the system, to communicate with the help desk, and to send emergency messages. See the following Web site for details.

<http://www.crestron.com/getroomview>

This manual describes how to perform operations on your computer using a Web browser.



- You can only enter single-byte alphanumeric characters and symbols.
- The following functions cannot be used while using Crestron RoomView®.
  - ☛ "Changing Settings Using a Web Browser (Web Control)" [p.108](#)  
Message Broadcasting (EasyMP Monitor plug-in)
  - Controlling is possible if **Standby Mode** is set to **Communication On**, even if the projector is in standby state (when the power is off).
    - ☛ **Extended - Standby Mode** [p.64](#)

## Operating a projector from your computer

Displaying the operation window

Check the following before carrying out any operations.

- Make sure the computer and projector are connected to the network. When communicating with a wireless LAN, connect in Advanced connection mode.
  - ☛ "Wireless LAN menu" [p.68](#)
- Set **Crestron RoomView** to **On** from the **Network** menu.
  - ☛ **Network - Others - Crestron RoomView** [p.73](#)

- 1 Start a Web browser on the computer.
- 2 Enter the IP address of the projector in the address field of the Web browser, and press the Enter key on the keyboard.  
The operation window is displayed.

Using the operation window

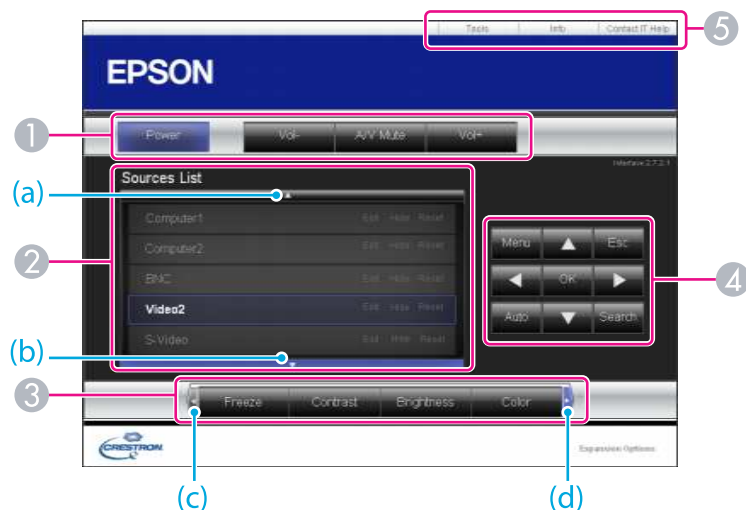

- 1 You can perform the following operations when you click the buttons.

Button	Function
<b>Power</b>	Turns the projector power on or off.
<b>Vol-/Vol+</b>	Adjusts the volume.

Button	Function
<b>A/V Mute</b>	Turns the video and audio on or off. ☞ "Hiding the Image and Sound Temporarily (A/V Mute)" p.44

- 2 Switch to the image from the selected input source. To display input sources that are not shown on the screen, click (a) or (b) to scroll up or down.  
You can change the source name if necessary.
- 3 You can perform the following operations when you click the buttons. To display buttons that are not shown on the screen, click (c) or (d) to scroll left or right.

Button	Function
<b>Freeze</b>	Pauses or resumes image playback. ☞ "Freezing the Image (Freeze)" p.44
<b>Contrast</b>	You can adjust the difference between light and dark in the images.
<b>Brightness</b>	You can adjust the image brightness.
<b>Color</b>	You can adjust the color saturation for the images.
<b>Sharpness</b>	You can adjust the image sharpness.
<b>Zoom</b>	Click the [⊕] button to enlarge the image without changing the projection size. Click the [⊖] button to reduce an image that was enlarged with the [⊕] button. Click the [▲], [▼], [◀], or [▶] button to change the position of an enlarged image. ☞ "Enlarging Part of the Image (E-Zoom)" p.46

- 4 [▲], [▼], [◀], or [▶] buttons have the same effects as [⊕][⊖][◀][▶] buttons on the remote control. You can perform the following operations when you click the other buttons.

Button	Function
<b>OK</b>	Performs the same operation as the [↵] button on the remote control. ☛ "Remote Control" p.12
<b>Menu</b>	Displays and closes the Configuration menu.
<b>Auto</b>	If clicked while projecting analog RGB signals from Computer1 port or Computer2 port, automatically optimizes the image by adjusting the Tracking, Sync., and Position.
<b>Search</b>	Switches to the image from the input port where video signals are being input. ☛ "Automatically Detect Input Signals and Change the Projected Image (Source Search)" p.29
<b>Esc</b>	Performs the same operation as the [Esc] button on the remote control. ☛ "Remote Control" p.12

5 You can perform the following operations when you click the tabs.

Tab	Function
<b>Contact IT Help</b>	Displays the Help Desk window. Used to send messages to, and receive messages from, the administrator using Crestron RoomView® Express.
<b>Info</b>	Displays information on the projector that is currently connected.
<b>Tools</b>	Changes settings in the projector that is currently connected. See the next section.

Using the tools window

The following window is displayed when you click the **Tools** tab on the operation window. You can use this window to change settings in the projector that is currently connected.

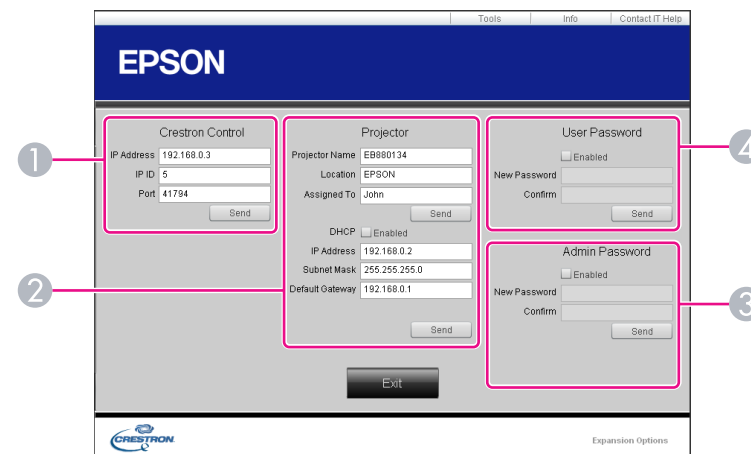

- 1 **Crestron Control**  
Make settings for Crestron® central controllers.
- 2 **Projector**  
The following items can be set.

Item	Function
<b>Projector Name</b>	Enter a name to differentiate the projector that is currently connected from other projectors on the network. (The name can contain up to 15 single-byte alphanumeric characters.)
<b>Location</b>	Enter an installation location name for the projector that is currently connected on the network. (The name can contain up to 32 single-byte alphanumeric characters and symbols.)
<b>Assigned To</b>	Enter a user name for the projector. (The name can contain up to 32 single-byte alphanumeric characters and symbols.)

Item	Function
<b>DHCP</b>	Select the <b>Enabled</b> check box to use DHCP. You cannot enter an IP address if DHCP is enabled.
<b>IP Address</b>	Enter the IP address to assign to the currently connected projector.
<b>Subnet Mask</b>	Enter a subnet mask for the currently connected projector.
<b>Default Gateway</b>	Enter the gateway address for the currently connected projector.
<b>Send</b>	Click this button to confirm the changes made to the <b>Projector</b> .

### 3 Admin Password

Select the **Enabled** check box to require a password to open the Tools window. The following items can be set.

Item	Function
<b>New Password</b>	Enter the new password when changing the password to open the Tools window. (The name can contain up to 26 single-byte alphanumeric characters.)
<b>Confirm</b>	Enter the same password as you entered in <b>New Password</b> . If the passwords are not the same, an error is displayed.
<b>Send</b>	Click this button to confirm the changes made to the <b>Admin Password</b> .

### 4 User Password

Select the **Enabled** check box to require a password to open the operation window on the computer. The following items can be set.

Item	Function
<b>New Password</b>	Enter the new password when changing the password to open the operation window. (The name can contain up to 26 single-byte alphanumeric characters.)
<b>Confirm</b>	Enter the same password as you entered in <b>New Password</b> . If the passwords are not the same, an error is displayed.
<b>Send</b>	Click this button to confirm the changes made to the <b>User Password</b> .

The following optional accessories and consumables are available. Please purchase these products as and when needed. The following list of optional accessories and consumables is current as of: August 2011. Details of accessories are subject to change without notice.

## Optional Accessories

### Document Camera ELPDC06/ELPDC11

Use when projecting images such as books, OHP documents, or slides.

### Computer cable ELPKC02

(1.8 m - for mini D-Sub15-pin/mini D-Sub 15pin)

This is the same as the computer cable supplied with the projector.

### Computer cable ELPKC09

(3 m - for mini D-Sub15-pin/mini D-Sub 15pin)

### Computer cable ELPKC10

(20 m - for mini D-Sub15-pin/mini D-Sub 15pin)

These are extension cables for when the computer cable supplied with the projector is too short.

### Component video cable ELPKC19

(3 m - for mini D-Sub 15-pin/RCA male×3)

Use to connect a [Component Video](#) source.

### Wireless LAN unit ELPAP07

Use when connecting the projector to a computer wirelessly and projecting.

### Quick Wireless Connection USB Key ELPAP08

Use when you want to quickly establish one-to-one connection between the projector and a computer with Windows installed.

### Wall mount\* ELPMB27

Use this arm type fitting when installing the projector on a wall.

### Interactive Unit ELPIU03

Use when operating the computer screen on the projection surface.

### Ceiling mount\* ELPMB23

Use when installing the projector on a ceiling.

### Ceiling pipe (450 mm)\* ELPFP13

### Ceiling pipe (700 mm)\* ELPFP14

Use when installing the projector on a high ceiling.

\* Special expertise is required to suspend the projector. Contact your local dealer or the nearest address provided in the Epson Projector Contact List.

 [Epson Projector Contact List](#)

## Consumables

### Lamp unit (for EB-425W/EB-420) ELPLP60

### Lamp unit (for EB-435W/EB-430) ELPLP61

Use as a replacement for a used lamp.

### Air filter ELPAF36

Use as a replacement for a used air filter.

## Projection Distance (For EB-430/EB-420)

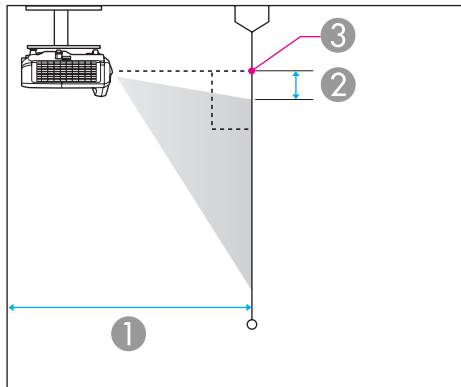
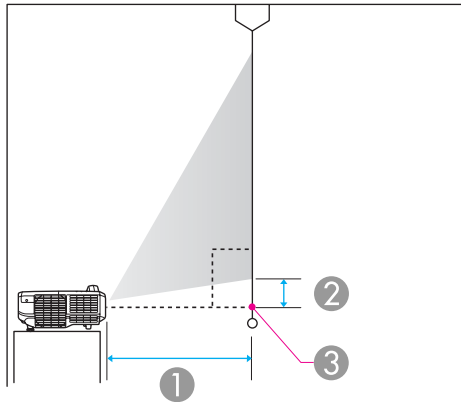

- ① Projection distance
- ② Distance from the center of the lens to the base of the screen (or to the top of the screen, if suspended from a wall or ceiling)
- ③ Center of lens

Unit: cm

4:3 Screen Size		①	②
		Minimum (Wide) to Maximum (Tele)	Minimum (Wide)
50"	100x76	55 - 75	6
60"	120x91	66 - 90	8
70"	140x105	78 - 106	9
80"	160x120	89 - 122	10
90"	180x135	101*	12
100"	200x150	112*	13
108"	219x165	122*	14

\* Project using Wide (maximum zoom).

Unit: cm

16:9 Screen Size		①	②
		Minimum (Wide) to Maximum (Tele)	Minimum (Wide)
50"	110x62	60 - 82	17
60"	130x75	72 - 99	21
70"	150x87	85 - 116	24
80"	180x100	98*	28
90"	200x110	110*	31
99"	219x123	121*	34

\* Project using Wide (maximum zoom).

## Projection Distance (For EB-435W/EB-425W)

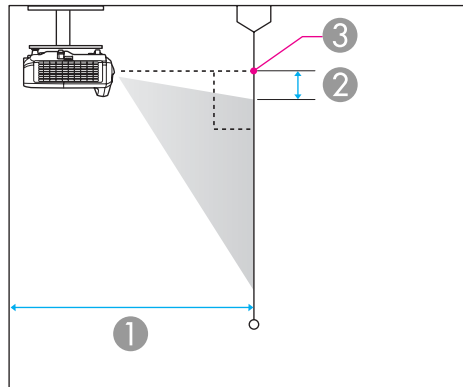
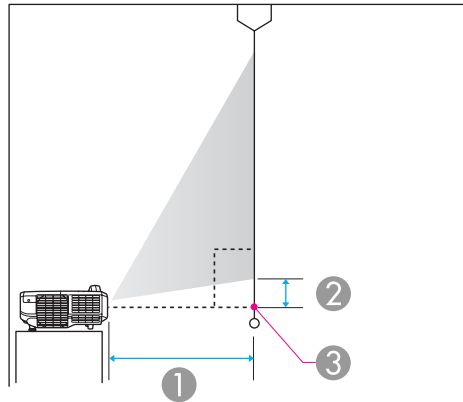

- ① Projection distance
- ② Distance from the center of the lens to the base of the screen (or to the top of the screen, if suspended from a wall or ceiling)
- ③ Center of lens

Unit: cm

4:3 Screen Size		①	②
		Minimum (Wide) to Maximum (Tele)	Minimum (Wide)
50"	100x76	58 - 79	9
60"	120x91	70 - 96	11
70"	140x105	82 - 112	13
80"	160x120	94*	14
90"	180x135	107*	16
102"	207x155	121*	18

\* Project using Wide (maximum zoom).

Unit: cm

16:9 Screen Size		①	②
		Minimum (Wide) to Maximum (Tele)	Minimum (Wide)
60"	130x75	63 - 87	14
70"	150x87	74 - 101	16
80"	180x100	85 - 116	19
90"	200x110	97*	21
100"	220x120	108*	23
113"	250x141	122*	26

\* Project using Wide (maximum zoom).

Unit: cm

16:10 Screen Size		①	②
		Minimum (Wide) to Maximum (Tele)	Minimum (Wide)
55"	115x72	56 - 77	9
60"	130x81	61 - 84	9





16:10 Screen Size		①	②
		Minimum (Wide) to Maximum (Tele)	Minimum (Wide)
70"	150x94	72 - 99	11
80"	170x110	83 - 113	13
90"	190x120	94*	14
100"	220x130	105*	16
116"	251x157	122*	18

\* Project using Wide (maximum zoom).

## Supported Resolutions

### Computer signals (analog RGB)

Signal	Refresh Rate (Hz)	Resolution (dots)
VGA	60/72/75/85	640x480
SVGA	56/60/72/75/85	800x600
XGA	60/70/75/85	1024x768
WXGA	60	1280x768
	60	1360x768
	60/75/85	1280x800
WXGA+	60/75/85	1440x900
SXGA	70/75/85	1152x864
	60/75/85	1280x1024
	60/75/85	1280x960
SXGA+	60/75	1400x1050
WSXGA+*1, 2	60	1680x1050
UXGA	60	1600x1200
MAC13"	67	640x480
MAC16"	75	832x624
MAC19"	75	1024x768
	59	1024x768
MAC21"	75	1152x870

\*1 EB-435W/EB-425W only

\*2 Only compatible when **Wide** is selected as the **Resolution** from the Configuration menu.

Images may also be projected when signals other than the above are input. However, some functions may be limited.

### Component Video

Signal	Refresh Rate (Hz)	Resolution (dots)
SDTV (480i)	60	720x480
SDTV (576i)	50	720x576
SDTV (480p)	60	720x480
SDTV (576p)	50	720x576
HDTV (720p)	50/60	1280x720
HDTV (1080i)	50/60	1920x1080

### Composite video

Signal	Refresh Rate (Hz)	Resolution (dots)
TV (NTSC)	60	720x480
TV (SECAM)	50	720x576
TV (PAL)	50/60	720x576

### Input signal from the HDMI port

Signal	Refresh Rate (Hz)	Resolution (dots)
VGA	60	640x480
SVGA	60	800x600
XGA	60	1024x768
WXGA	60	1280x800
SXGA	60	1280x960
	60	1280x1024
SXGA+	60	1400x1050
UXGA	60	1600x1200



Signal	Refresh Rate (Hz)	Resolution (dots)
SDTV (480i/480p)	60	720x480
SDTV (576i/576p)	50	720x576
HDTV (720p)	50/60	1280x720
HDTV (1080i)	50/60	1920x1080
HDTV (1080p)	24/30/50/60	1920x1080

## Projector General Specifications

<b>Product name</b>		EB-435W	EB-430	EB-425W	EB-420
<b>Dimensions</b>	345 (W) x 105 (H) x 277 (D) mm (not including raised section)				
<b>LCD panel size</b>		0.59" Wide	0.55"	0.59" Wide	0.55"
<b>Display method</b>	Polysilicon TFT active matrix				
<b>Resolution</b>		1,024,000 WXGA (1280 (W)x 800 (H) dots)x 3	786,432 XGA (1024 (W) x 768 (H) dots)x 3	1,024,000 WXGA (1280 (W)x 800 (H) dots)x 3	786,432 XGA (1024 (W) x 768 (H) dots)x 3
<b>Focus adjustment</b>	Manual				
<b>Zoom adjustment</b>	Digital (1-1.35)				
<b>Lamp</b>	UHE lamp, 230 W Model No.: ELPLP61			UHE lamp, 200 W Model No.: ELPLP60	
<b>Max. audio output</b>	16 W				
<b>Speaker</b>	1				
<b>Power supply</b>	100 to 240V AC ±10%, 50/60 Hz 3.4 to 1.5 A			100 to 240V AC ±10%, 50/60 Hz 3.0 to 1.3 A	
<b>Power consumption</b>	<b>100 to 120 V area</b>	Operating: 332 W Standby power consumption (Communication On): 6.8 W Standby power consumption (Communication Off): 0.28 W		Operating: 294 W Standby power consumption (Communication On): 6.2 W Standby power consumption (Communication Off): 0.29 W	
	<b>220 to 240 V area</b>	Operating: 316 W Standby power consumption (Communication On): 7.3 W Standby power consumption (Communication Off): 0.37 W		Operating: 283 W Standby power consumption (Communication On): 6.8 W Standby power consumption (Communication Off): 0.39 W	
<b>Operating altitude</b>	Altitude 0 to 2,286 m				
<b>Operating temperature</b>	+5 to +35°C (No condensation)				
<b>Storage temperature</b>	-10 to +60°C (No condensation)				
<b>Mass</b>		Approx. 3.9 kg	Approx. 3.9 kg	Approx. 3.8 kg	Approx. 3.8 kg

<b>Connectors</b>	<b>Computer1 port</b>	1	Mini D-Sub15-pin (female)
	<b>Computer2 port</b>	1	Mini D-Sub15-pin (female)

Video port	1	RCA pin jack
S-Video port	1	Mini DIN 4-pin
Audio1 port	1	Stereo mini pin jack
Audio2 port	1	Stereo mini pin jack
Audio-L/R port	1	RCA pin jack x 2 (L-R)
Mic port	1	Stereo mini pin jack
Audio Out port	1	Stereo mini pin jack
Monitor Out port	1	Mini D-Sub15-pin (female)
HDMI port	1	HDMI (Audio is only supported by PCM)
USB(TypeA) port*	1	USB connector (Type A)
USB(TypeB) port*	1	USB connector (Type B)
USB port (dedicated Wireless LAN unit)	1	USB connector (Type A)
LAN port	1	RJ-45
RS-232C port	1	Mini D-Sub 9-pin (male)

\* Supports USB 2.0. However, the operation of all USB compatible devices is not guaranteed.

This product is also designed for IT power distribution system with phase-to-phase voltage 230V.

Angle of tilt

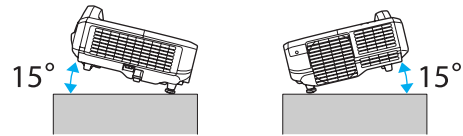

If you use the projector tilted at an angle of more than 15° it could be damaged and cause an accident.

**DECLARATION of CONFORMITY**

According to 47CFR, Part 2 and 15

Class B Personal Computers and Peripherals; and/or  
CPU Boards and Power Supplies used with Class B Personal Computers

We: Epson America, Inc.  
Located at: 3840 Kilroy Airport Way  
MS: 3-13  
Long Beach, CA 90806  
Tel: 562-290-5254

Declare under sole responsibility that the product identified herein, complies with 47CFR Part 2 and 15 of the FCC rules as a Class B digital device. Each product marketed, is identical to the representative unit tested and found to be compliant with the standards. Records maintained continue to reflect the equipment being produced can be expected to be within the variation accepted, due to quantity production and testing on a statistical basis as required by 47CFR 2.909. Operation is subject to the following two conditions : (1) this device may not cause harmful interference, and (2) this device must accept any interference received, including interference that may cause undesired operation.

Trade Name: EPSON  
Type of Product: LCD Projector  
Model: H447C/H448C/H449C/H469C

**FCC Compliance Statement  
For United States Users**

This equipment has been tested and found to comply with the limits for a Class B digital device, pursuant to Part 15 of the FCC Rules. These limits are designed to provide reasonable protection against harmful interference in a residential installation. This equipment generates, uses, and can radiate radio frequency energy and, if not installed and used in accordance with the instructions, may cause harmful interference to radio or television reception. However, there is no guarantee that interference will not occur in a particular installation. If this equipment does cause interference to radio and television reception, which can be determined by turning the equipment off and on, the user is encouraged to try to correct the interference by one or more of the following measures.

- Reorient or relocate the receiving antenna.
- Increase the separation between the equipment and receiver.
- Connect the equipment into an outlet on a circuit different from that to which the receiver is connected.
- Consult the dealer or an experienced radio/TV technician for help.

**WARNING**

The connection of a non-shielded equipment interface cable to this equipment will invalidate the FCC Certification or Declaration of this device and may cause interference levels which exceed the limits established by the FCC for this equipment. It is the responsibility of the user to obtain and use a shielded equipment interface cable with this device. If this equipment has more than one interface connector, do not leave cables connected to unused interfaces. Changes or modifications not expressly approved by the manufacturer could void the user's authority to operate the equipment.

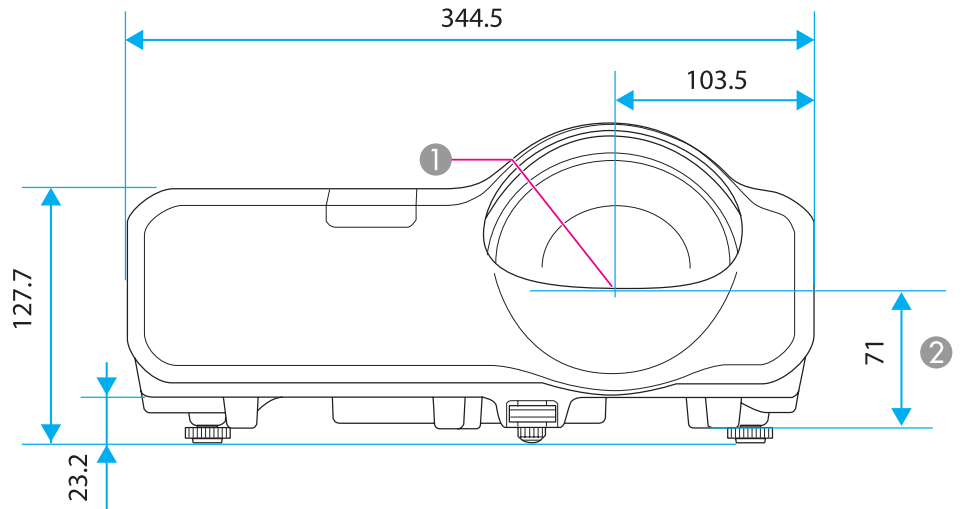

- ① Center of lens
- ② Measurements from the center of the lens to the wall mount plate fixing points or the ceiling mount fixing points.

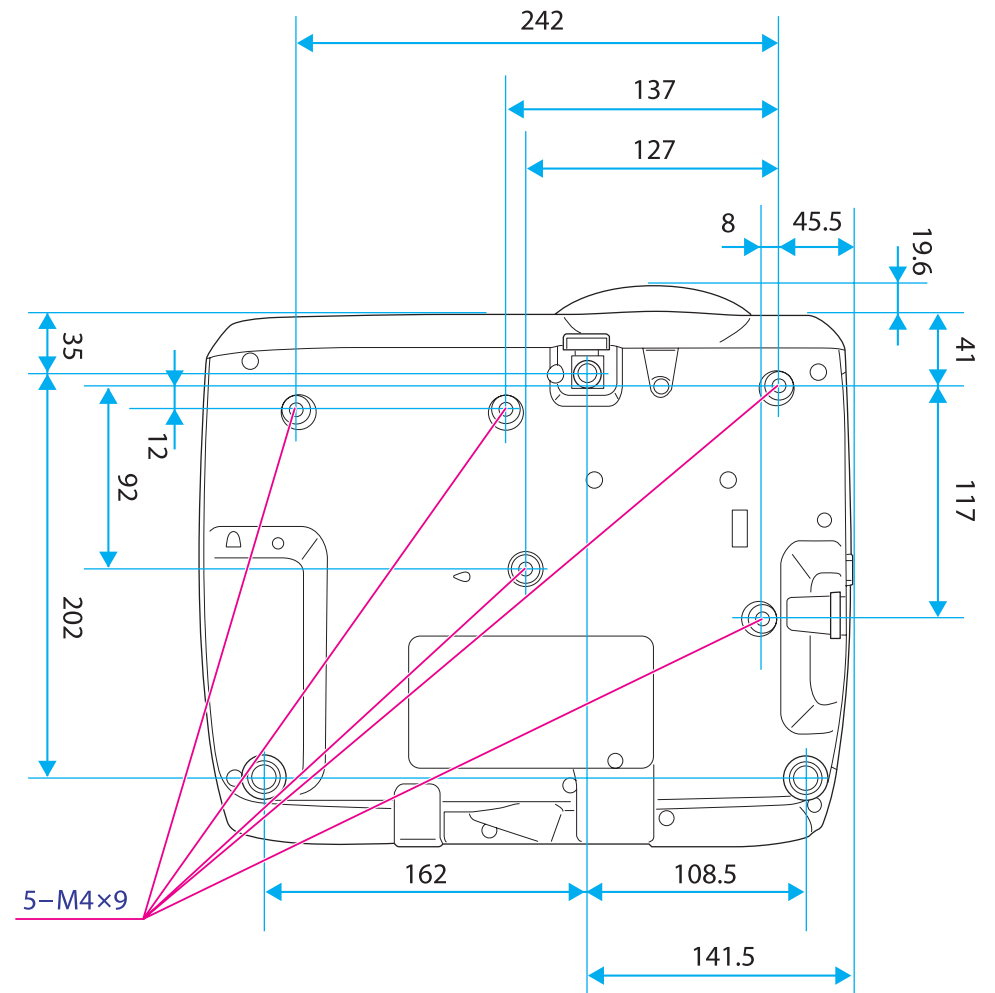

Units: mm



This section briefly explains the difficult terms that are not explained in the text of this guide. For details, refer to other commercially available publications.

<b>AMX Device Discovery</b>	AMX Device Discovery is a technology developed by AMX to facilitate AMX control systems for easy operation of the target equipment. Epson have implemented this protocol technology, and have provided a setting to enable the protocol function (ON). See the AMX Web site for more details. URL <a href="http://www.amx.com/">http://www.amx.com/</a>
<b>Aspect Ratio</b>	The ratio between an image's length and its height. Screens with a horizontal:vertical ratio of 16:9, such as HDTV screens, are known as wide screens. SDTV and general computer displays have an aspect ratio of 4:3.
<b>Component Video</b>	A method that separates the video signal into a luminance component (Y), and a blue minus luminance (Cb or Pb) and a red minus luminance (Cr or Pr).
<b>Composite video</b>	A method that combines the video signal into a luminance component and a color component for transmission down a single cable.
<b>Contrast</b>	The relative brightness of the light and dark areas of an image can be increased or decreased to make text and graphics stand out more clearly, or to make them appear softer. Adjusting this particular property of an image is called "contrast adjustment".
<b>DHCP</b>	An abbreviation of Dynamic Host Configuration Protocol, this protocol automatically assigns an <a href="#">IP address</a> to equipment connected to a network.
<b>Gateway Address</b>	This is a server (router) for communicating across a network (subnet) divided according to <a href="#">subnet mask</a> .
<b>HDCP</b>	HDCP is an abbreviation for High-bandwidth Digital Content Protection. It is used to prevent illegal copying and protect copyrights by encrypting digital signals sent over DVI and HDMI ports. Because the HDMI port on this projector supports HDCP, it can project digital images protected by HDCP technology. However, the projector may not be able to project images protected with updated or revised versions of HDCP encryption.
<b>HDTV</b>	An abbreviation for High-Definition Television that refers to high-definition systems which satisfy the following conditions. <ul style="list-style-type: none"> <li>• Vertical resolution of 720p or 1080i or greater (p = <a href="#">Progressive</a>, i = <a href="#">Interlace</a>)</li> <li>• Screen <a href="#">aspect ratio</a> of 16:9</li> </ul>
<b>Interlace</b>	Transmits information needed to create one screen by sending every other line, starting from the top of the image and working down to the bottom. Images are more likely to flicker because one frame is displayed every other line.
<b>IP Address</b>	A number to identify a computer connected to a network.
<b>Progressive</b>	Projects information to create one screen at a time, displaying the image for one frame. Even though the number of scan lines is the same, the amount of flicker in images decreases because the volume of information has doubled compared with an interlace system.
<b>SDTV</b>	An abbreviation for Standard Definition Television that refers to standard television systems which do not satisfy the conditions for <a href="#">HDTV</a> High-Definition Television.
<b>SNMP</b>	An abbreviation for Simple Network Management Protocol, which is the protocol for monitoring and controlling devices such as routers and computers connected to a TCP/IP network.

<b>sRGB</b>	An international standard for color intervals that was formulated so that colors that are reproduced by video equipment can be handled easily by computer operating systems (OS) and the Internet. If the connected source has an sRGB mode, set both the projector and the connected signal source to sRGB.
<b>SSID</b>	SSID is identification data for connecting to another device on a wireless LAN. Wireless communication is possible between devices that correspond to SSID.
<b>Subnet Mask</b>	This is a numerical value that defines the number of bits used for the network address on a divided network (subnet) from the IP address.
<b>SVGA</b>	A screen size standard with a resolution of 800 (horizontal) x 600 (vertical) dots.
<b>S-Video</b>	A method that separates the video signal into a luminance component (Y) and a color component (C).
<b>SXGA</b>	A screen size standard with a resolution of 1,280 (horizontal) x 1,024 (vertical) dots.
<b>Sync.</b>	The signals output from computers have a specific frequency. If the projector frequency does not match this frequency, the resulting images are not of a good quality. The process of matching the phases of these signals (the relative position of the crests and the troughs in the signal) is called Synchronization. If the signals are not synchronized, flickering, blurriness, and horizontal interference occur.
<b>Tracking</b>	The signals output from computers have a specific frequency. If the projector frequency does not match this frequency, the resulting images are not of a good quality. The process of matching the frequency of these signals (the number of crests in the signal) is called Tracking. If tracking is not carried out correctly, wide vertical stripes appear in the signal.
<b>Trap IP Address</b>	This is the <a href="#">IP address</a> for the destination computer used for error notification in SNMP.
<b>VGA</b>	A screen size standard with a resolution of 640 (horizontal) x 480 (vertical) dots.
<b>XGA</b>	A screen size standard with a resolution of 1,024 (horizontal) x 768 (vertical) dots.

All rights reserved. No part of this publication may be reproduced, stored in a retrieval system, or transmitted in any form or by any means, electronic, mechanical, photocopying, recording, or otherwise, without the prior written permission of Seiko Epson Corporation. No patent liability is assumed with respect to the use of the information contained herein. Neither is any liability assumed for damages resulting from the use of the information contained herein.

Neither Seiko Epson Corporation nor its affiliates shall be liable to the purchaser of this product or third parties for damages, losses, costs, or expenses incurred by the purchaser or third parties as a result of: accident, misuse, or abuse of this product or unauthorized modifications, repairs, or alterations to this product, or (excluding the U.S.) failure to strictly comply with Seiko Epson Corporation's operating and maintenance instructions.

Seiko Epson Corporation shall not be liable against any damages or problems arising from the use of any options or any consumable products other than those designated as Original Epson Products or Epson Approved Products by Seiko Epson Corporation.

The contents of this guide may be changed or updated without further notice.

Illustrations in this guide and the actual projector may differ.

---

## About Notations

Microsoft® Windows® 98 operating system  
Microsoft® Windows® Me operating system  
Microsoft® Windows® 2000 operating system  
Microsoft® Windows® XP Professional operating system  
Microsoft® Windows® XP Home Edition operating system  
Microsoft® Windows Vista® operating system  
Microsoft® Windows® 7 operating system

In this guide, the operating systems above are referred to as "Windows 98", "Windows Me", "Windows 2000", "Windows XP", "Windows Vista", and "Windows 7". Furthermore, the collective term Windows may be used to refer to Windows 98, Windows Me, Windows 2000, Windows XP,

Windows Vista, and Windows 7, and multiple versions of Windows may be referred to as, for example, Windows 98/Me/2000/XP/Vista, with the Windows notation omitted.

Mac OS X 10.3.x  
Mac OS X 10.4.x  
Mac OS X 10.5.x  
Mac OS X 10.6.x

In this guide, the operating systems above are referred to as "Mac OS X 10.3.9", "Mac OS X 10.4.x", "Mac OS X 10.5.x", and "Mac OS X 10.6.x". Furthermore, the collective term "Mac OS" is used to refer to them.

---

## General Notice:

IBM, DOS/V, and XGA are trademarks or registered trademarks of International Business Machines Corp.

Macintosh, Mac, Mac OS, and iMac are trademarks of Apple Inc.

Microsoft, Windows, Windows NT, Windows Vista, PowerPoint, and Windows logo are trademarks or registered trademarks of Microsoft Corporation in the United States and/or other countries.

WPA™ and WPA2™ are registered trademarks of Wi-Fi Alliance.

HDMI and High-Definition Multimedia Interface are the trademarks or registered trademarks of HDMI Licensing LLC. 

PJLink trademark is a trademark applied for registration or is already registered in Japan, the United States of America and other countries and areas.

Other product names used herein are also for identification purposes only and may be trademarks of their respective owners. Epson disclaims any and all rights in those marks.

©SEIKO EPSON CORPORATION 2011. All rights reserved.

- A**
- A/V Mute ..... 44
  - Abs. Color Temp. .... 60
  - Air exhaust vent ..... 8
  - Air filter replacement period ..... 99
  - Aspect ..... 40, 62
  - Auto Iris ..... 39, 61
  - Auto Setup ..... 61
- B**
- Basic menu ..... 68
  - Blackboard ..... 39
  - Brightness ..... 60
- C**
- Ceiling ..... 17, 65
  - Ceiling mount fixing points ..... 10
  - Cleaning ..... 94
  - Cleaning the air filter and air intake vent ..... 94
  - Cleaning the projector's surface ..... 94
  - Color Adjustment ..... 61
  - Color Mode ..... 38, 60
  - Color Saturation ..... 60
  - Computer port ..... 9
  - Configuration menu ..... 57
  - Connection mode ..... 69
  - Consumables ..... 118
  - Continuous ..... 107
  - Contrast ..... 60
  - Control panel ..... 11
  - Control Panel Lock ..... 54, 63
- D**
- Crestron RoomView ..... 114
  - Cross ..... 46
- D**
- Direct Power On ..... 65
  - Display ..... 65
  - Display Background ..... 65
  - Display Order ..... 107
  - Display settings ..... 107
  - Distance ..... 119
  - Document Camera ..... 118
  - Dynamic ..... 38
- E**
- EasyMP Monitor ..... 108
  - Email address ..... 73
  - ESC/VP21 ..... 112
  - Extended menu ..... 64
  - E-Zoom ..... 46
- F**
- Focus ring ..... 8
  - Foot adjust lever ..... 8
  - Freeze ..... 44
  - Front ..... 17, 65
  - Front adjustable foot ..... 8
  - Full Lock ..... 54
- G**
- Gateway Address ..... 69, 72
- H**
- H/V-Keystone ..... 34
  - HDMI port ..... 9
  - HDMI Video Range ..... 62
  - Help function ..... 78
  - High Altitude Mode ..... 65
  - How to replace the air filter ..... 99
  - How to replace the lamp ..... 96
- I**
- Image menu ..... 60
  - Indicators ..... 79
  - Info menu ..... 74
  - Input Signal ..... 62, 75
  - IP Address ..... 72
- K**
- Keystone ..... 63
- L**
- Lamp cover ..... 8
  - Lamp Hours ..... 75
  - Lamp indicator ..... 79
  - Lamp replacement period ..... 96
  - Language ..... 66
- M**
- Mail Notification ..... 72, 111
  - Mail Notification menu ..... 72
  - Message Broadcasting ..... 108
  - Messages ..... 65
  - Mic Input Level ..... 63

- Monitor displays ..... 122
- Mouse pointer ..... 47
- N**
- Network Configuration ..... 66
- Network information ..... 66
- Network menu ..... 66
- Noise Reduction ..... 62
- O**
- Operating temperature ..... 124
- Operation ..... 65
- Optional accessories ..... 118
- Overheating ..... 80
- P**
- Part names and functions ..... 8
- Password protect ..... 52
- Password protect sticker ..... 53
- Pattern ..... 64
- Photo ..... 38
- PJLink ..... 113
- PJLink Password ..... 68
- Pointer ..... 45
- Pointer Shape ..... 63
- Port Number ..... 72
- Position ..... 62
- Power Consumption ..... 63
- Power indicator ..... 79
- Power inlet ..... 9
- Power On Protect ..... 52
- Presentation ..... 38, 103
- Problem solving ..... 79
- Progressive ..... 62
- Projection ..... 65
- Projector Keyword ..... 68
- Projector Name ..... 68
- Projector setup ..... 108
- Q**
- Quick Corner ..... 63
- R**
- Reading mail ..... 111
- Rear ..... 17, 65
- Rear feet ..... 11
- Rear screen ..... 17
- Refresh Rate ..... 75
- Remote control ..... 12
- Remote receiver ..... 8
- Replacing batteries ..... 15
- Reset All ..... 75
- Reset Lamp Hours ..... 76
- Reset menu ..... 74, 75
- Resetting the lamp operating time ..... 99
- Resolution ..... 75
- Rotating images ..... 105
- S**
- Screen size ..... 119
- Screen switching time ..... 107
- Security menu ..... 70
- Select Drive ..... 104
- Settings menu ..... 63
- Sharpness ..... 60
- Signal menu ..... 61
- Sleep Mode ..... 65
- Slideshow ..... 103, 106
- SMTP Server ..... 72
- SNMP ..... 111
- Soft keyboard ..... 67
- Source ..... 75
- Source Search ..... 11, 29
- Specifications ..... 124
- Sports ..... 38
- sRGB ..... 38
- SSID ..... 69
- Standby Microphone ..... 65
- Standby Mode ..... 65
- Startup Screen ..... 65
- Storage temperature ..... 124
- Subnet Mask ..... 69, 72
- Supported monitor displays ..... 122
- S-Video port ..... 10
- Sync Info ..... 75
- Sync. .... 62
- T**
- Temp indicator ..... 79
- Theatre ..... 38
- Tint ..... 60
- Tracking ..... 61
- U**
- USB(TypeA) port ..... 9
- USB(TypeB) port ..... 9
- User Button ..... 64
- User Pattern ..... 50
- User's Logo ..... 48



User's Logo Protect ..... 52

**V**

Video port ..... 9

Video Signal ..... 62, 75

Volume ..... 63

**W**

Web browser ..... 108

Web Control ..... 109

Web Control Password ..... 68

Web Remote ..... 109

Whiteboard ..... 39

Wired LAN menu ..... 71

Wireless LAN menu ..... 68

Wireless LAN Power ..... 68

Wireless LAN system ..... 69

Wireless mouse function ..... 47

**Z**

Zoom ..... 63