

# Table of Contents

## Table of Contents .....1

## Usage Notice .....2

Safety Information .....2

Precautions .....3

Eye Safety Warnings .....6

## Introduction .....7

Package Overview .....7

Product Overview .....8

    Main Unit.....8

    Connection Ports .....9

    Remote Control.....10

## Installation .....11

Connecting the Projector.....11

Connect to Computer/Notebook.....11

Connect to Video.....12

Connect to 3D Video Devices .....13

Using the 3D glasses .....15

Powering On/Off the Projector .....16

    Powering On the Projector.....16

    Powering Off the Projector.....17

    Warning Indicator.....17

Adjusting the Projected Image .....18

    Adjusting the Projector's Height.....18

    Adjusting the Projector's Zoom / Focus.....18

    Adjusting Projection Image Size .....19

## User Controls .....20

Remote Control .....20

On-screen Display Menus .....22

    How to operate .....22

Menu Tree .....23

    IMAGE .....25

    IMAGE | Advanced .....27

    IMAGE | Advanced | PureEngine.....28

    IMAGE | Advanced | Color Settings.....29

    DISPLAY .....31

    DISPLAY | 3D .....33

    SYSTEM .....35

    SYSTEM | Lamp Settings.....37

SETUP .....38

SETUP | Signal -RGB Source.....40

SETUP | Signal -Video Source .....41

## Appendices.....42

Troubleshooting.....42

    Image Problems.....42

    Other Problems.....44

    Remote Control Problems .....44

    LED Lighting Messages.....45

    On Screen Messages .....46

Replacing the Lamp .....47

Compatibility Modes .....49

RS232 Commands and Protocol Function

List.....52

    RS232 Pin Assignments .....52

    RS232 Protocol Function List .....53

Ceiling Mount Installation .....56



Optoma Global Offices .....57

Regulation & Safety Notices.....59

    FCC Notice .....59

    Declaration of Conformity for EU countries ...60

## Safety Information

	The lightning flash with arrow head within an equilateral triangle is intended to alert the user to the presence of uninsulated "dangerous voltage" within the product's enclosure that may be of sufficient magnitude to constitute a risk of electric shock to persons.
	The exclamation point within an equilateral triangle is intended to alert the user to the presence of important operating and maintenance (servicing) instructions in the literature accompanying the appliance.

**WARNING:** TO REDUCE THE RISK OF FIRE OR ELECTRIC SHOCK, DO NOT EXPOSE THIS APPLIANCE TO RAIN OR MOISTURE. DANGEROUS HIGH VOLTAGES ARE PRESENT INSIDE THE ENCLOSURE. DO NOT OPEN THE CABINET. REFER SERVICING TO QUALIFIED PERSONNEL ONLY.

### Class B emissions limits

This Class B digital apparatus meets all requirements of the Canadian Interference-Causing Equipment Regulations.

### Important Safety Instruction

1. Do not block any ventilation openings. To ensure reliable operation of the projector and to protect from over heating, it is recommended to install the projector in a location that does not block ventilation. As an example, do not place the projector on a crowded coffee table, sofa, bed, etc. Do not put the projector in an enclosure such as a book case or a cabinet that restricts air flow.
2. Do not use the projector near water or moisture. To reduce the risk of fire and/or electric shock, do not expose the projector to rain or moisture.
3. Do not install near heat sources such as radiators, heaters, stoves or any other apparatus such as amplifiers that emits heat.
4. Clean only with dry cloth.
5. Only use attachments/accessories specified by the manufacturer.
6. Do not use the unit if it has been physically damaged or abused. Physical damage/abuse would be (but not limited to):
  - Unit has been dropped.
  - Power supply cord or plug has been damaged.
  - Liquid has been spilled on to the projector.
  - Projector has been exposed to rain or moisture.
  - Something has fallen in the projector or something is loose inside.Do not attempt to service the unit yourself. Opening or removing covers may expose you to dangerous voltages or other hazards. Please call Optoma before you send the unit for repair.
7. Do not let objects or liquids enter the projector. They may touch dangerous voltage points and short out parts that could result in fire or electric shock.
8. See projector enclosure for safety related markings.
9. The unit should only be repaired by appropriate service personnel.

## Precautions



*Please follow all warnings, precautions and maintenance as recommended in this user's guide.*



- ❖ When the lamp reaches the end of its life, the projector will not turn back on until the lamp module has been replaced. To replace the lamp, follow the procedures listed under "Replacing the Lamp" section.

- ■ Warning- Do not look into the projector's lens when the lamp is on. The bright light may hurt your eyes.
- ■ Warning- To reduce the risk of fire or electric shock, do not expose this projector to rain or moisture.
- ■ Warning- Please do not open or disassemble the projector as this may cause electric shock.
- ■ Warning- When replacing the lamp, please allow the unit to cool down.
- ■ Warning- This projector will detect the life of the lamp itself. Please be sure to change the lamp when it shows warning messages.
- ■ Warning- Reset the "Lamp Reset" function from the on-screen display "System|Lamp Setting" menu after replacing the lamp module.
- ■ Warning- When switching the projector off, please ensure the cooling cycle has been completed before disconnecting power. Allow 90 seconds for the projector to cool down.
- ■ Warning- Do not use lens cap when projector is in operation.
- ■ Warning- When the lamp is approaching to the end of its life time, the message "Replacement suggested" will show on the screen. Please contact your local reseller or service center to change the lamp as soon as possible.

# Usage Notice

## **Do:**

- ❖ Turn off and unplug the power plug from the AC outlet before cleaning the product.
- ❖ Use a soft dry cloth with mild detergent to clean the display housing.
- ❖ Disconnect the power plug from AC outlet if the product is not being used for a long period of time.

## **Do not:**

- ❖ Block the slots and openings on the unit provided for ventilation.
- ❖ Use abrasive cleaners, waxes or solvents to clean the unit.
- ❖ Use under the following conditions:
  - In extremely hot, cold or humid environments.
    - ▶ Ensure that the ambient room temperature is within 5°C ~ 35°C
    - ▶ Relative humidity is 10% ~ 85%
  - In areas susceptible to excessive dust and dirt.
  - Near any appliance generating a strong magnetic field.
  - In direct sunlight.

## **Viewing 3D PROJECTOR using the 3D function**

**IMPORTANT SAFETY INFORMATION. READ THE FOLLOWING WARNINGS BEFORE YOU OR YOUR CHILD USE THE 3D FUNCTION.**

### **Warning**

- ❖ Children and teenagers may be more susceptible to health issues associated with viewing in 3D and should be closely supervised when viewing these images.

### **Photosensitive Seizure Warning and Other Health Risks**

- ❖ Some viewers may experience an epileptic seizure or stroke when exposed to certain flashing images or lights contained in certain Projector pictures or video games. If you suffer from, or have a family history of epilepsy or strokes, please consult with a medical specialist before using the 3D function.
- ❖ Even those without a personal or family history of epilepsy or stroke may have an undiagnosed condition that can cause photosensitive epileptic seizures.



- ❖ Pregnant women, the elderly, sufferers of serious medical conditions, those who are sleep deprived or under the influence of alcohol should avoid utilizing the unit's 3D functionality.
- ❖ If you experience any of the following symptoms, stop viewing 3D pictures immediately and consult a medical specialist: (1) altered vision; (2) light-headedness; (3) dizziness; (4) involuntary movements such as eye or muscle twitching; (5) confusion; (6) nausea; (7) loss of awareness; (8) convulsions; (9) cramps; and/ or (10) disorientation. Children and teenagers may be more likely than adults to experience these symptoms. Parents should monitor their children and ask whether they are experiencing these symptoms.
- ❖ Viewing 3D PROJECTOR may also cause motion sickness, perceptual after effects, disorientation, eye strain and decreased postural stability. It is recommended that users take frequent breaks to lessen the potential of these effects. If your eyes show signs of fatigue or dryness or if you have any of the above symptoms, immediately discontinue use of this device and do not resume using it for at least thirty minutes after the symptoms have subsided.
- ❖ Watching 3D PROJECTOR while sitting too close to the screen for an extended period of time may damage your eyesight. The ideal viewing distance should be at least three times the screen height. It is recommended that the viewer's eyes are level with the screen.
- ❖ Watching 3D PROJECTOR while wearing 3D glasses for an extended period of time may cause a headache or fatigue. If you experience a headache, fatigue or dizziness, stop viewing 3D PROJECTOR and rest.
- ❖ Do not use the 3D glasses for any other purpose than for viewing 3D PROJECTOR. Wearing the 3D glasses for any other purpose (as general spectacles, sunglasses, protective goggles, etc.) may be physically harmful to you and may weaken your eyesight.
- ❖ Viewing in 3D may cause disorientation for some viewers. Accordingly, DO NOT place your 3D PROJECTOR near open stairwells, cables, balconies, or other objects that can be tripped over, run into, knocked down, broken or fallen over.

## Eye Safety Warnings



- ■ Avoid staring/facing directly into the projector beam at all times. Keep your back to the beam as much as possible.
- ■ When projector is used in a classroom, adequately supervise students when they are asked to point out something on the screen.
- ■ In order to minimize the lamp power, use room blinds to reduce ambient light levels.

## Package Overview

Unpack and inspect the box contents to ensure all parts listed below are in the box. If something is missing, please contact Optoma customer service.

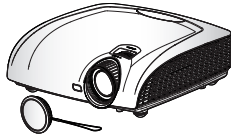

Projector with lens cap

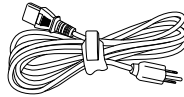

Power Cord 1.8m



- ❖ Due to different applications in each Country, some regions may have different accessories.



IR Remote Control

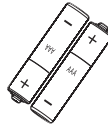

2 × AAA Batteries

### Documentation:

- User's Manual
- Warranty Card
- Quick Start Card
- WEEE Card

## Product Overview

### Main Unit

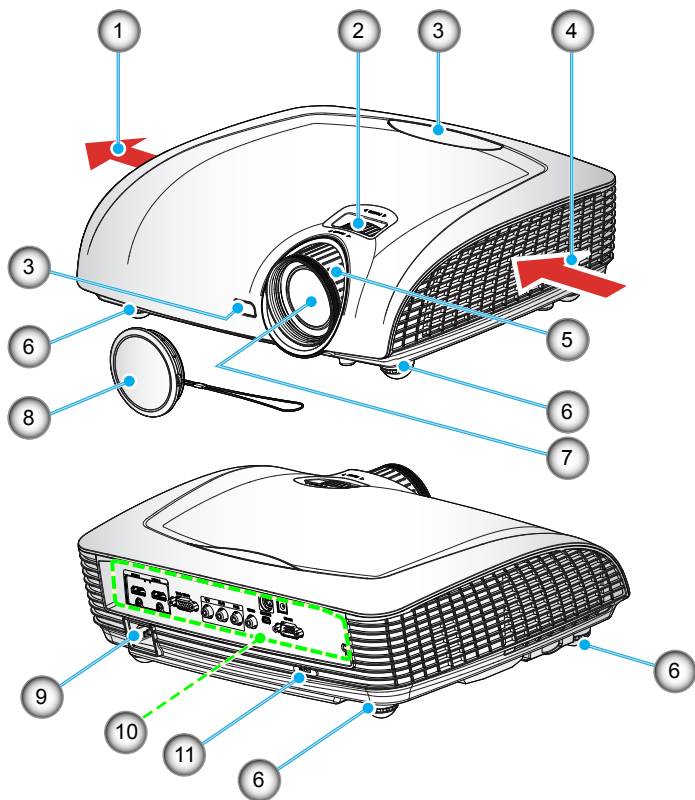

1. Ventilation (outlet)

2. Focus Ring

3. IR Receiver

4. Ventilation (inlet)

5. Zoom Ring

6. Tilt-Adjustment Feet

7. Zoom Lens

8. Lens Cap



9. Power Socket

10. Input / Output Connections

11. Kensington™ Lock Port

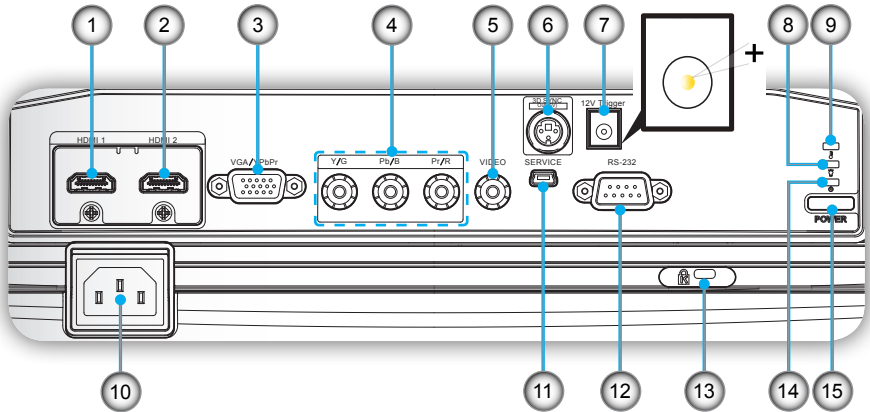
## Connection Ports



1. HDMI1 Input Connector
2. HDMI2 Input Connector
3. VGA-In/YPbPr Connector  
(PC Analog Signal/Component Video Input/HDTV/YPbPr)
4. Component Video Input Connector
5. Composite Video Input Connector
6. 3D Sync Out (5V) Connector
7. 12V Trigger Relay (12V, 250mA)
8. Lamp LED  (Indicates the projector's lamp status)
9. Temp LED  (Indicates the projector's temperature status)
10. Power Socket
11. USB Service
12. RS-232 Connector (9-pin)
13. Kensington™ Lock Port
14. Power LED  (Indicates the projector's status)
15. Power Button

## Remote Control

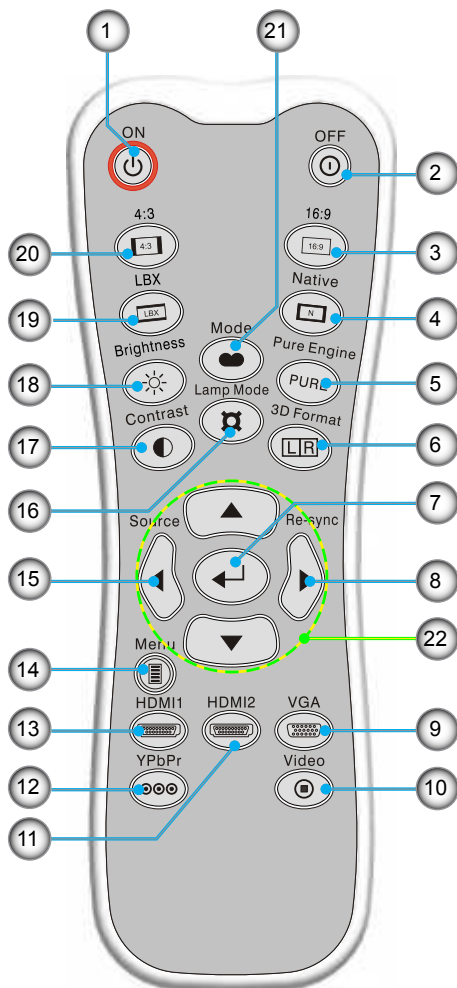

1. Power On
2. Power Off
3. 16:9
4. Native
5. PureEngine
6. 3D Format
7. Enter
8. Re-Sync
9. VGA Source
10. Video Source
11. HDMI 2 Source
12. YPbPr Source
13. HDMI 1 Source
14. Menu
15. Source
16. Lamp Mode
17. Contrast
18. Brightness
19. LBX
20. 4:3
21. Mode
22. Four Directional Select Keys

## Connecting the Projector

### Connect to Computer/Notebook

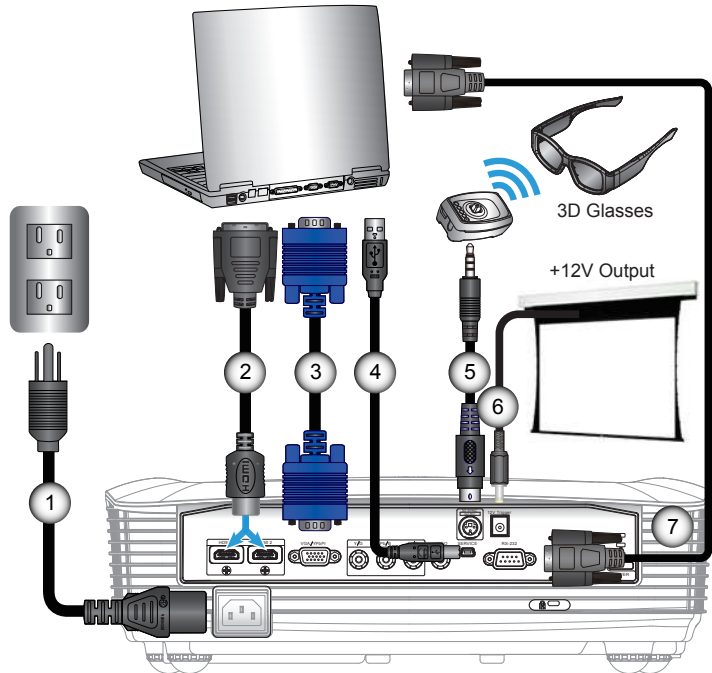

❖ Due to the difference in applications for each country, some regions may have different accessories.

❖ \* Optional Accessory

1. Power Cord
2. DVI/HDMI Cable \*
3. VGA Cable \*
4. USB Cable \*
5. Emitter Cable \*
6. 12V DC Plug \*
7. RS232 Cable \*

## Connect to Video

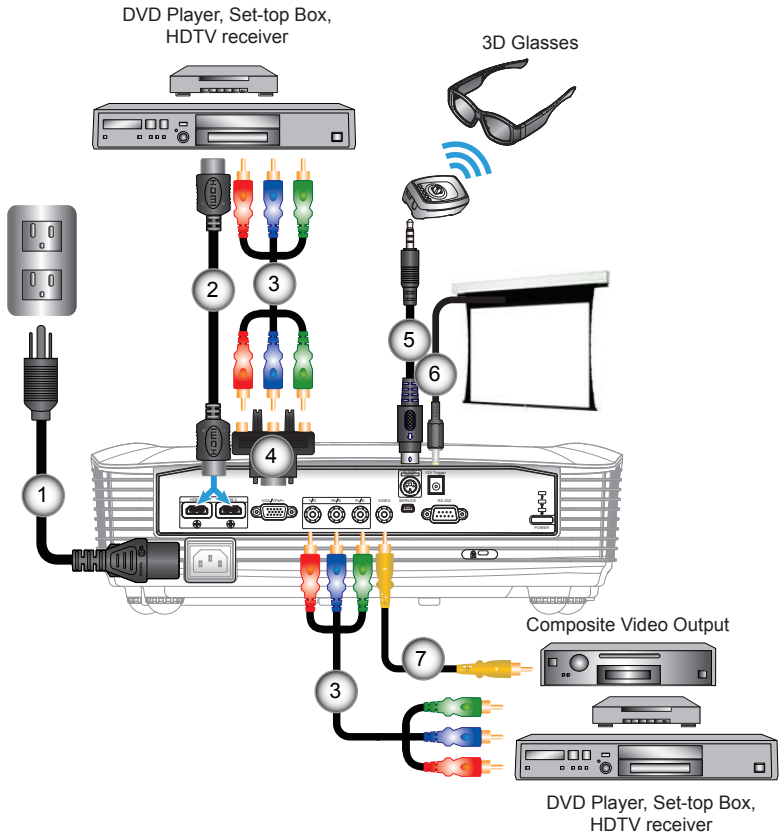

- ❖ Due to the difference in applications for each country, some regions may have different accessories.
- ❖ 12V Trigger is programmable trigger.
- ❖ For more detailed information about connecting to the 3D emitter and 3D glasses, please refer to their user's guides.
- ❖ Use high speed HDMI cable to connect Blue-ray 3D player.
- ❖ \* Optional Accessory

1. Power Cord
2. HDMI Cable \*
3. RCA Component Cable for YPbPr \*
4. VGA to RCA Component Cable for YPbPr \*
5. Emitter Cable \*
6. 12V DC Plug\*
7. Composite Video Cable \*



## Connect to 3D Video Devices



- ❖ The 3D video source device must be powered on before the 3D projector.

*Once you have connected your devices together with HDMI cables, as shown in the diagram, you are ready to begin. Power ON your 3D video source and your 3D projector.*

### PlayStation® 3 Games

- Make sure that you have updated your console to the latest software version in PlayStation® 3.
- Go to the “Settings menu -> Display settings -> Video output -> HDMI”. Select “Automatic” and follow the on-screen instructions.
- Insert your 3D game disc. Alternatively you can download games (and 3D updates) via the PlayStation® network.
- Launch the game. In the in-game menu, select “Play in 3D”.

### Blu-ray 3D™ Player

- Make sure that your player can support 3D Blu-ray™ disc and that 3D output is enabled.
- Insert the 3D Blu-ray™ disc into the player, press “Play”.

### 3D TV (e.g. SKY 3D, DirecTV)

- Contact your TV service provider to enable any 3D channels on your channel package.
- Once enabled, switch to the 3D channel.
- You should see two images side-by-side.
- Switch to the “SBS Mode” of the 3D projector. The option is located in the “Display” section of the projector OSD menu.

### 3D Device (e.g. 3D DV/DC) with 2D 1080i side by side signal output

- Connect your 3D device and switch to out 3D content with 2D side-by-side output to 3D Projector.
  - You should see two images side-by-side.
- Switch to the “SBS Mode” of the 3D projector. The option is located in the “Display” section of the projector OSD menu.

If watching 3D content from an HDMI 1.4a source (e.g. 3D Blu-ray) your 3D glasses should always be in sync. If watching 3D content from an HDMI 1.3 source (e.g. 3D broadcast using SBS mode) it may be necessary to use the projector’s 3D Sync-Invert option to optimize your 3D experience. The option is located in the “Display ->3D” section of the projector OSD menu.



- ❖ If input video is normal 2D, please press “3D Format” and switch to “Off”.
- ❖ If “SBS Mode” is active, 2D video content will not display correctly.

# Installation



All other product names, company names and trade names used herein are for identifications purposes only and may be trademarks or registered trademarks of their respective owners. All images have been simulated.



❖ For more detailed information, please refer to 3D glasses user's guide.

## Using the 3D glasses

1. To turn ON 3D glasses: Press the "Power" button and the LED will flash one time indicating the glasses are ready to use 3D mode.
2. Verify that 3D content is being sent to the projector and signal is compatible with projector specifications.
3. Turn on the "3D Mode" (DLP-Link/VESA 3D - depending on which type of glasses you are using) of the 3D projector. The option is located in the "Display" section of the projector OSD menu.
4. Turn on 3D glasses and verify image appears in 3D without eyestrain.
5. If the image does not appear in 3D, please check 3D device set up well to send out 3D image or not. Or "SBS Mode" should turn on when input signal is 2D 1080i side-by-side and repeat previous steps 1 ~ 4.
6. To use projector's "3D Sync-Invert" option to optimize your 3D experience. The option is located in the "Display" section of the projector OSD menu.
7. To turn OFF 3D glasses: Press the "Power" button and hold until the LED switches off.
8. For more detailed information, please refer to the 3D glasses user's guide, or manufacturer's Website.

## Powering On/Off the Projector

### Powering On the Projector

1. Remove the lens cap. ❶
2. Securely connect the power cord and signal cable. When connected, the Power LED will turn red.
3. Turn on the lamp by pressing “POWER” button on the back of the projector or pressing “” button on the remote control. The Power LED will flash blue. ❷

The startup screen will display in approximately 30 seconds. The first time you use the projector, you can select your preferred language from quick menu after the startup screen display.

4. Turn on your source that you want to display on the screen (computer, notebook, video player, etc). The projector will detect the source automatically and will display on the screen. If not, push menu button and go to “SETUP”. Make sure that the “Source Lock” has been set to “Off”.

- ❖ If you connected multiple sources at the same time, press the “SOURCE” button or direct source keys on the remote control to switch between inputs.



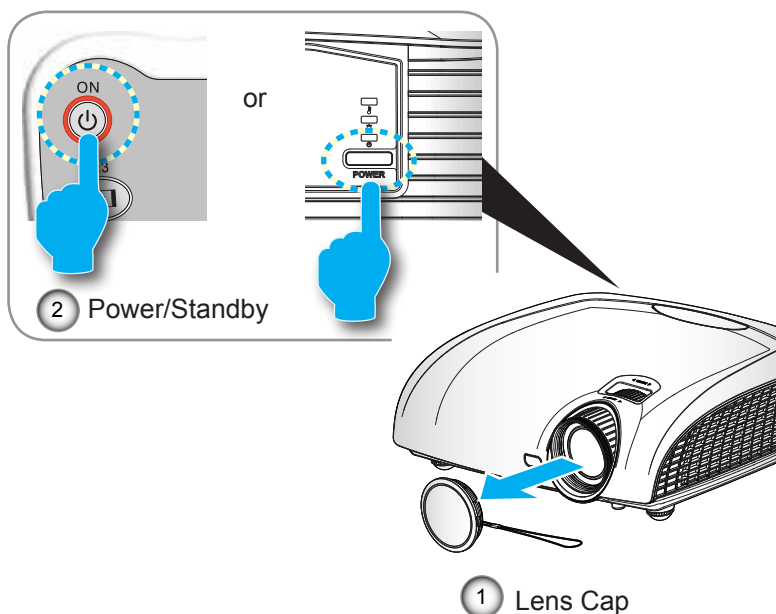

- ❖ Turn on the projector first and then select the signal sources.

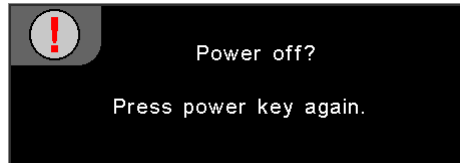

## Powering Off the Projector

1. Press the “” button on the remote control or “POWER” button on the back of the projector two times with one second interval to turn off the projector. First time, it will display the following message on the screen.



- Press the “” button again to confirm the shut down. If the button is not pressed, the message will disappear after 15 seconds.
2. The cooling fans continue to operate for about 60 seconds for cooling cycle and the Power LED will turn blue and flashing. When the lights solid red, the projector has entered standby mode. If you wish to turn the projector back on, you must wait until the projector has completed the cooling cycle and has entered standby mode. Once in standby mode, simply press “POWER” button or “” button to restart the projector.
  3. Disconnect the power cord from the electrical outlet and from the projector.
  4. Do not turn on the projector immediately following the power off procedure.

## Warning Indicator

- ❖ When the “LAMP” indicator is lit orange, the projector will shut down automatically. Please call the nearest Optoma facility for assistance.
- ❖ When the “TEMP” indicator turns red, it indicates the projector has overheated. The projector will shut down automatically. Under normal conditions, the projector can be switched on again after it has cooled down.
- ❖ When the “TEMP” indicator flashes red, it indicates the fan has failed.
- ❖ After the projector has cooled down, you can press and hold “” button on the remote control for 10 seconds to leave failure mode to standby mode.



- ❖ Contact the nearest service center if the projector displays these symptoms.

## Adjusting the Projected Image

### Adjusting the Projector's Height

*The projector is equipped with elevator feet for adjusting the image height.*

1. Locate the adjustable foot you wish to modify on the underside of the projector.
2. Rotate the adjustable ring clockwise to raise the projector or counter clockwise to lower it. Repeat with the remaining feet as needed.

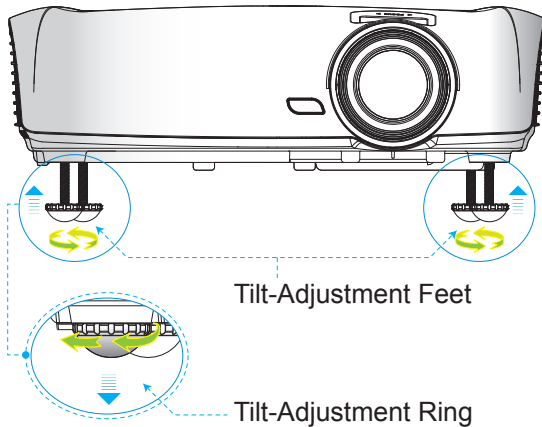

### Adjusting the Projector's Zoom / Focus

You may turn the zoom ring to zoom in or out. To focus the image, rotate the focus ring until the image is clear. The projector will focus at distances from 4.92 to 32.8 feet (1.0 to 10.0 meters).

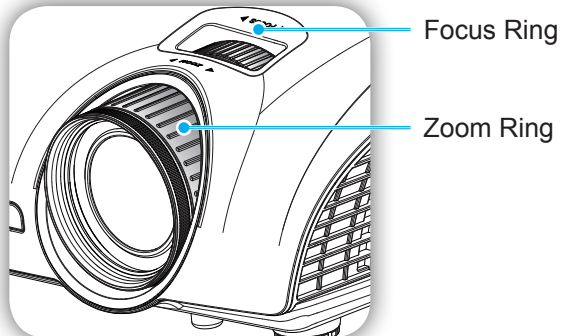

## Adjusting Projection Image Size

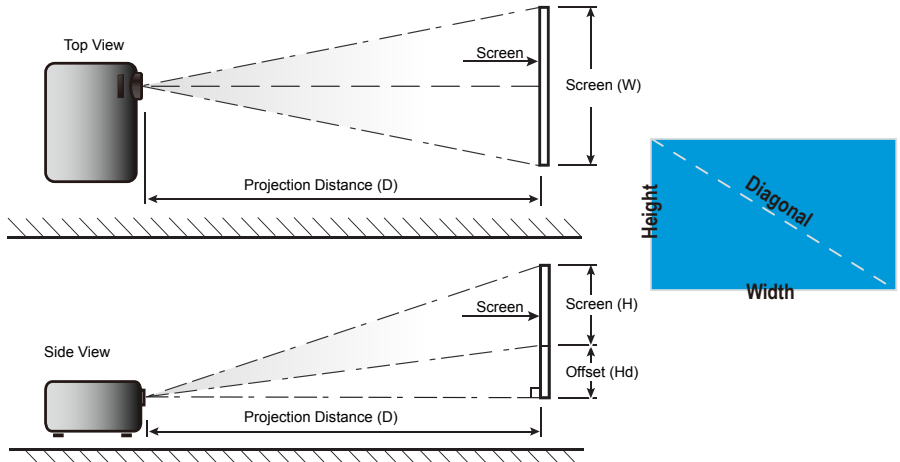

Diagonal length (inch) size of 16:9 Screen	Screen Size W x H				Projection Distance (D)				Offset (Hd)	
	(m)		(feet)		(m)		(feet)		(m)	(feet)
	Width	Height	Width	Height	wide	tele	wide	tele		
38	0.84	0.47	2.76	1.55	--	1.51	--	4.97	0.08	0.25
45	1.00	0.56	3.27	1.84	1.49	1.79	4.89	5.88	0.09	0.29
50	1.11	0.62	3.63	2.04	1.66	1.99	5.45	6.54	0.10	0.33
60	1.33	0.75	4.36	2.45	1.99	2.39	6.54	7.84	0.12	0.39
70	1.55	0.87	5.08	2.86	2.32	2.79	7.63	9.15	0.14	0.46
80	1.77	1.00	5.81	3.27	2.66	3.19	8.72	10.46	0.16	0.52
90	1.99	1.12	6.54	3.68	2.99	3.59	9.81	11.77	0.18	0.59
100	2.21	1.25	7.26	4.09	3.32	3.98	10.89	13.07	0.20	0.65
120	2.66	1.49	8.72	4.90	3.98	4.78	13.07	15.69	0.24	0.78
150	3.32	1.87	10.89	6.13	4.98	5.98	16.34	19.61	0.30	0.98
200	4.43	2.49	14.53	8.17	6.64	7.97	21.79	26.15	0.40	1.31
300	6.64	3.74	21.79	12.26	9.96	--	32.68	--	0.60	1.96



❖ This graph is for user's reference only.

## Remote Control



Using the Remote Control		
Power On		Turn on the projector.
Power Off		Turn off the projector.
Lamp Mode		Increase the brightness of the image.
Mode		Select the display mode from Cinema, Bright, Photo, Reference, 3D, ISF Day, ISF Night and User.
4:3		Scale the image to 4:3 aspect ratio.
16:9		Scale the image to 16:9 aspect ratio.
LBX		Enable the viewing of the letterboxed non- anamorphically enhanced movie at full screen width. Part of the original image will be lost if the image aspect ratio is less than 2.35:1.
Native		The input source will be displayed without scaling.
Brightness		Adjust the brightness of the image.
Contrast		Control the degree of difference between the lightest and darkest parts of the picture.
PureEngine	PURE	The PureEngine is a collection of advanced image processing technologies that enhances the quality of the displayed image.
3D Format		Press "3D Format" to switch between "Off" and "SBS", use up/down button to switch to "Top and Bottom" or "Frame Sequential then press "Enter" to confirm.





## Using the Remote Control

Enter		Confirm your item selection.
Source		Press "Source" to select an input signal.
Re-sync		Automatically synchronizes the projector to the input source.
Menu		Display or exit the on-screen display menus for projector.
HDMI 1		Press "HDMI 1" to choose source from HDMI 1 connector.
HDMI 2		Press "HDMI 2" to choose source from HDMI 2 connector.
VGA		Press "VGA" to choose source from VGA/YPbPr connector.
YPbPr		Press "YPbPr" to choose Component Video source.
Video		Press "Video" to choose Composite video source.
Four Directional Select Keys		Use ▲ ▼ ◀ ▶ to select items or make adjustments to your selection.

## On-screen Display Menus



The Projector has multilingual On-screen Display menus that allow you to make image adjustments and change a variety of settings. The projector will automatically detect the source.

### How to operate

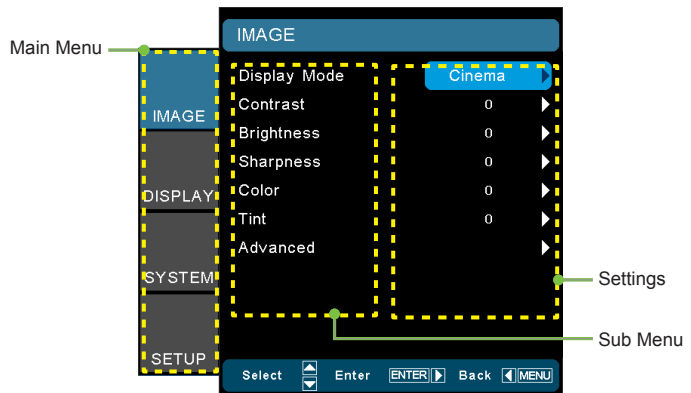
1. To open the OSD menu, press “Menu” on the Remote Control or Control Panel.
2. When OSD is displayed, use ▲▼ keys to select any item in the main menu. While making a selection on a particular page, press ► or “Enter” key to enter sub menu.
3. Use ▲▼ keys to select the desired item in the sub menu and then press ► or “Enter” key to view further settings. Adjust the settings by ◀▶ key.
4. Select the next item to be adjusted in the sub menu and adjust as described above.
5. Press “Enter” or “Menu” to confirm, and the screen will return to the main menu.
6. To exit, press “Menu” again. The OSD menu will close and the projector will automatically save the new settings.



## Menu Tree

Main Menu	Sub Menu	Settings	
<b>IMAGE</b>	Display Mode	Cinema / Bright / Photo / Reference / 3D / ISF Day / ISF Night / User	
	Contrast	-50~50	
	Brightness	-50~50	
	Sharpness	0~15	
	#1 Color	-50~50	
	#1 Tint	-50~50	
	Advanced	Noise Reduction 0~10 Gamma Film / Video / Graphics / Standard PureEngine PureDetail / PureColor / PureMotion / PureEngine Demo / Exit	
		+ Color Settings Color Temp. Warm / Medium / High RGB Gain/Bias Red Gain / Green Gain / Blue Gain / Red Bias / Green Bias / Blue Bias / Reset / Exit	
		Color Space AUTO / RGB / YUV #2 AUTO / RGB(0-255) / RGB(16-235) / YUV	
		Exit	
	<b>DISPLAY</b>	Format	#3 4:3 / 16:9 / LBX / Native #4 4:3 / SuperWide
		Zoom	0~10
		EdgeMask	0~5
		V Image Shift	-50~50
		V Keystone	-30~30
SuperWide		Off / On (16:9) / On (2.35:1) / Auto	
3D		3D Mode DLP-Link / VESA 3D 3D -> 2D 3D / L / R 3D Format Off / SBS / Top and Bottom / Frame Sequential #5 3D Sync. Invert On / Off	
		Exit	
<b>SYSTEM</b>		Menu Location	
		Lamp Settings	Lamp Hours Lamp Reminder On / Off Lamp Mode STD / Bright / Image AI Lamp Reset Cancel / Yes Exit
	Projection		
	Test Pattern	Off / Grid / White Pattern	
	Background Color	Dark Blue / Grey / Black	
	12V Trigger	On / Off	

# User Controls

Main Menu	Sub Menu	Settings	
<b>SETUP</b>	Language	English / Deutsch / Français / Italiano / Español / Português / Svenska / Nederlands / Norsk/Dansk / Polski / Русский / Suomi / Ελληνικά / Magyar / Čeština / عربي / 繁體中文 / 简体中文 / 日本語 / 한국어 / Türkçe / ไทย	
	Input Source	HDMI 1 / HDMI 2 / Component / VGA / Video / Exit	
	Source Lock	On / Off	
	High Altitude	On / Off	
	Information Hide	On / Off	
	Auto Power Off (min.)	0~180	
	Signal (VGA)	Frequency	0~100
		Phase	-50~50
		H. Position	-50~50
		V. Position	-50~50
		Automatic	Enable / Disable
	Signal (Video)	Exit	
		White Level	-50~50
		Black Level	-50~50
		Saturation	-50~50
		Hue	-50~50
		IRE	0 / 7.5
	Reset	Exit	
		Current	Cancel / Yes
		All	Cancel / Yes



- ❖ Please note that the on-screen display (OSD) menus vary according to the signal type selected and the projector model you are using.
- ❖ (#1) "Color" and "Tint" are only supported in Video mode.
- ❖ (#2) For HDMI model only.
- ❖ (#3) For SurperWide is "Off".
- ❖ (#4) For SurperWide is "On".
- ❖ (#5) "3D Sync Invert" is only available when 3D is enabled.

## IMAGE

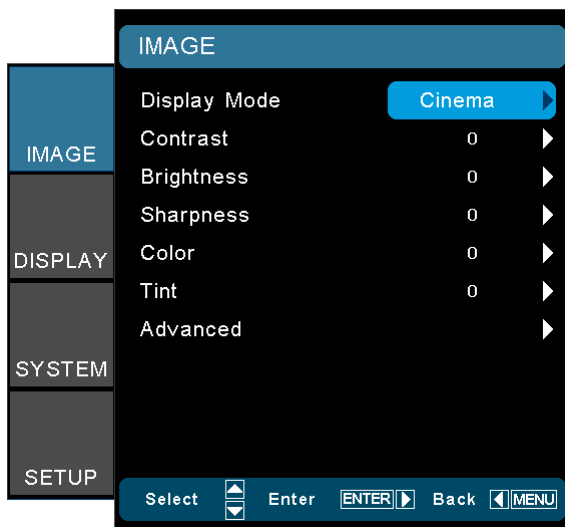

- ❖ “ISF Day” and “ISF Night” will not be shown when the ISF modes have not been calibrated.

### Display Mode

There are many factory presets optimized for various types of images.

- ▶ Cinema: For home theater.
- ▶ Reference: This mode is intended to reproduce, as close as possible, the image the way the movie director intended. Color, color temperature, brightness, contrast and gamma settings are all configured to standard reference levels. Pure-Engine Image processing is disabled.
- ▶ Photo: Optimized for displaying photographic images.
- ▶ Bright: Maximum brightness from PC input.
- ▶ 3D: Recommended setting for 3D mode enabled. Any further adjustments by the user in 3D will be saved in this mode for further use.
- ▶ ISF Day: Optimize the image with the ISF Day mode to be perfectly calibrated and high picture quality.
- ▶ ISF Night: Optimize the image with the ISF Night mode to be perfectly calibrated and high picture quality.
- ▶ User: User’s settings.

### Contrast

The contrast controls the degree of difference between the lightest and darkest parts of the picture. Adjusting the contrast changes the amount of black and white in the image.

# User Controls



❖ “Color” and “Tint” are only supported for composite and component sources.

- ▶ Press the ◀ to decrease the contrast.
- ▶ Press the ▶ to increase the contrast.

## Brightness

Adjust the brightness of the image.

- ▶ Press the ◀ to darken image.
- ▶ Press the ▶ to lighten the image.

## Color

Adjust a video image from black and white to fully saturated color.

- ▶ Press the ◀ to decrease the color saturation in the image.
- ▶ Press the ▶ to increase the color saturation in the image.

## Tint

Adjust the color balance of red and green.

- ▶ Press the ◀ to increase the amount of green in the image.
- ▶ Press the ▶ to increase the amount of red in the image.

## Sharpness

Adjust the sharpness of the image.

- ▶ Press the ◀ to decrease the sharpness.
- ▶ Press the ▶ to increase the sharpness.

## IMAGE | Advanced

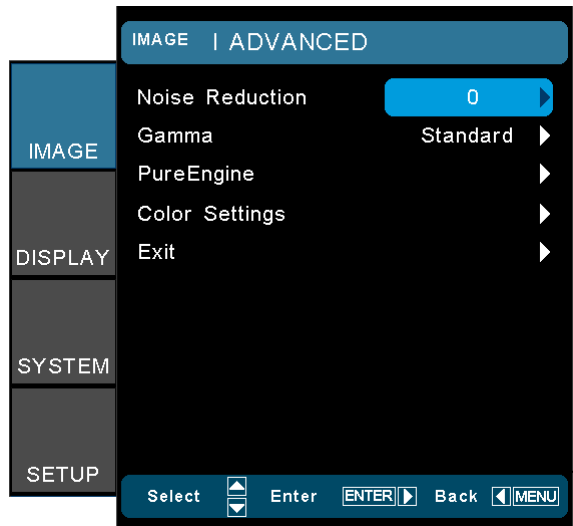

### Noise Reduction

The Noise Reduction reduces the amount of visible noise inter-laced signals. The range is from “0” to “10”. (0: Off)

### Gamma

This allows you to set up gamma curve type. After the initial setup and fine tuning is completed, utilize the Gamma Adjustment steps to optimize your image output.

- ▶ Film: for home theater.
- ▶ Video: for video or TV source.
- ▶ Standard: for standardized setting.
- ▶ Graphics: for image source.

### PureEngine

The PureEngine is a collection of advanced image processing technologies that enhances the quality of the displayed image.

### Color Settings

Press ▶ into the next menu and then use ▲ or ▼ to select item.

## IMAGE | Advanced | PureEngine

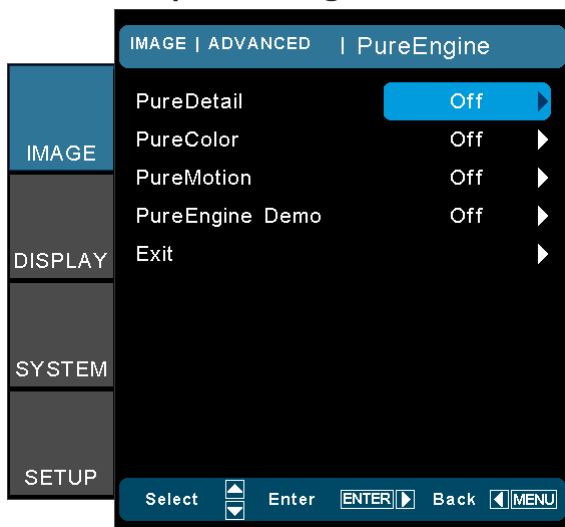

### PureDetail

PureDetail is an edge enhancement tool that enables the edges in the projected image to be enhanced, thus providing more perceived detail.

### PureColor

This adjustable item utilizes a new color-processing algorithm and enhancements to enable the picture's vividness to be significantly increased. The range is from "0" to "5".

### PureMotion

PureMotion uses sophisticated algorithms to ensure that the natural motion in the image is preserved.

### PureEngine Demo

This feature enables you to see the difference in the image quality between the raw unprocessed image and the image processed as processed by the PureEngine. Use this mode to check the adjustments that you make to the PureEngine settings.



- ❖ While the input source is 120Hz timing, the PureMotion function does not support this timing and will be gray out.



## IMAGE | Advanced | Color Settings

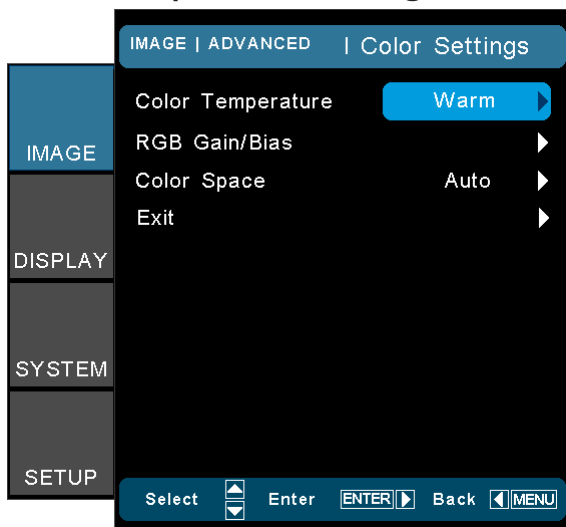

### Color Temperature

If set to cold temperature, the image looks more blue. (cold image)

If set to warm temperature, the image looks more red. (warm image)

### RGB Gain/Bias

Press ► into the next menu and then use ▲ or ▼ to select item.

- ▶ Use ◀ or ▶ to select Red, Green, or Blue for brightness (Gain) and contrast (Bias).
- ▶ Reset: Choose “Yes” to return the factory default settings for color adjustments.

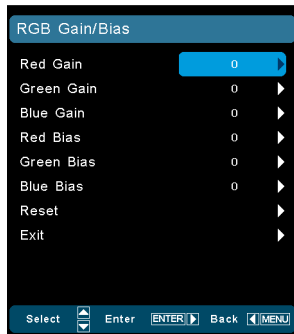

# User Controls



❖ (\*) For HDMI only.

## Color Space

Select an appropriate color matrix type from AUTO, RGB, RGB(0-255)<sup>(\*)</sup> RGB(16-235)<sup>(\*)</sup> or YUV.

## DISPLAY

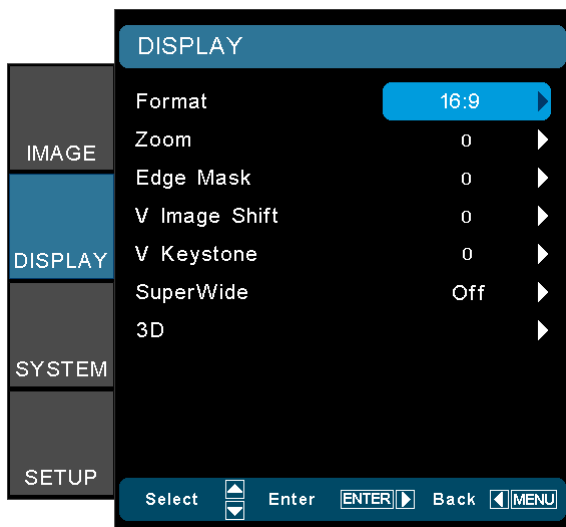

### Format

Use this function to choose your desired aspect ratio.

- ▶ 4:3: This format is for 4x3 input sources.
- ▶ 16:9: This format is for 16x9 input sources, like HDTV and DVD enhanced for Widescreen TV.
- ▶ LBX: This format is for non-16x9, letterbox source and for users who use external anamorphic lens to display 2.35:1 aspect ratio using full resolution.
- ▶ Native: This format displays the original image without scaling.
- ▶ AUTO: Automatically selects the appropriate display format.

Detail informations about LBX mode:

1. Some Letter-Box Format DVDs are not enhanced for 16x9 TVs. In this situation, the image will not look right when displayed in 16:9 mode. In this situation, please try to using the 4:3 mode to view the DVD. If the content is not 4:3, there will be black bars around the image in 16:9 display. For this type of content, you can use LBX mode to fill the image on the 16:9 display.
2. If you use an external anamorphic lens, this LBX mode also allows you to watch a 2.35:1 content (include Anamorphic DVD and HDTV film source) that support anamorphic wide is enhanced for 16x9 Display in a wide 2.35:1 image. In this case, there are no black bars. Lamp power and vertical resolution are fully utilized.

16:9 Screen	480i/p	576i/p	1080i/p	720p	PC
4:3	1440 x 1080 center				
16:9	1920 x 1080 center				
LBX	1920 x 1440 center, then get the central 1920 x 1080 image to display				
Native	No resize image, 1:1 mapping and centered. This format shows original image without scaling.				
Auto	If this format is select, Screen type will auto become 16:9 (1920x1080) If source is 4:3, auto resize to 1440 x1080 If source is 16:9 auto resize to 1920x1080 If source is 16:10 auto resize to 1920 x 1200 and cut 1920x1080 area to display				

## Zoom

- ▶ Press the ◀ to reduce the size of an image.
- ▶ Press the ▶ to magnify an image on the projection screen.

## Edge Mask

Edge mask function removes the noise in a video image. Edge mask the image to remove video encoding noise on the edge of video source.

## V Image Shift

Shift the projected image position vertically.

## V Keystone

Press the ◀ or ▶ to adjust image distortion vertically and make a squarer image.

## SuperWide

SuperWide is a feature that uses a special 2.0:1 aspect ratio screen enabling both 16:9 and 2.35:1 aspect ratio movies to be shown without black bars at the top and bottom of the screen.

- ▶ Off: Your desired aspect ratio can be selected 4:3, 16:9, LBX and Native.
- ▶ Auto: To solve the differences of the film formats, the option can keep the format in the same ratio.
- ▶ On (16:9): Only 16:9 format can be selected.
- ▶ On (2.35:1) Only 2.35:1 format can be selected.

## 3D

Press ▶ into the next menu and then use ▲ or ▼ to select item.



- ❖ "SuperWide" is Off" as default.
- ❖ How to use "Super-Wide":
  1. Obtain a 2.0:1 aspect ratio screen.
  2. Switch Super-Wide ON.
  3. Align the projector image correctly on the screen.
  4. Enjoy movies without black bars.

## DISPLAY | 3D

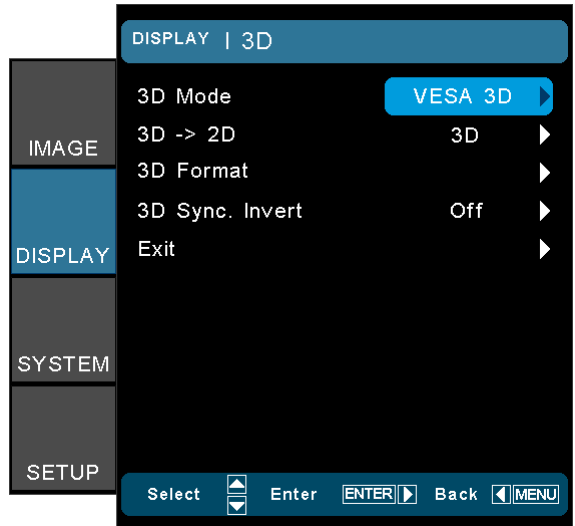

### 3D Mode

- ▶ DLP Link: Select “DLP Link” to use optimized settings for DLP Link 3D Glasses. (please refer to page 15).
- ▶ VESA 3D: Select “VESA 3D” to use optimized setting for VESA 3D Glasses. (please refer to page 13).

### 3D -> 2D

- ▶ 3D: Display 3D signal.
- ▶ L (Left): Display the left frame of 3D content.
- ▶ R (Right): Display the right frame of 3D content.

### 3D Format

- ▶ Off: Press the “Off” to disable 3D format conversion.
- ▶ SBS: Display 3D signal in “Side-by-Side” format.
- ▶ Top and Bottom: Display 3D signal in “Top and Bottom” format.
- ▶ Frame Sequential: Display 3D signal in “Frame Sequential” format.



- ❖ “3D Format” is only supported on non-HDMI 1.4a 3D timing.
- ❖ Press “Enter” to select 3D format.

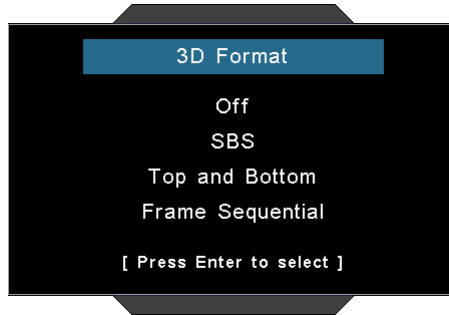

- ❖ “3D sync. Invert” function wouldn’t save the setting. It will set to “Off” when powers on and changes source.

## 3D Sync. Invert

- ▶ Press the “On” to invert left and right frame contents.
- ▶ Press the “Off” for default frame contents.

## SYSTEM

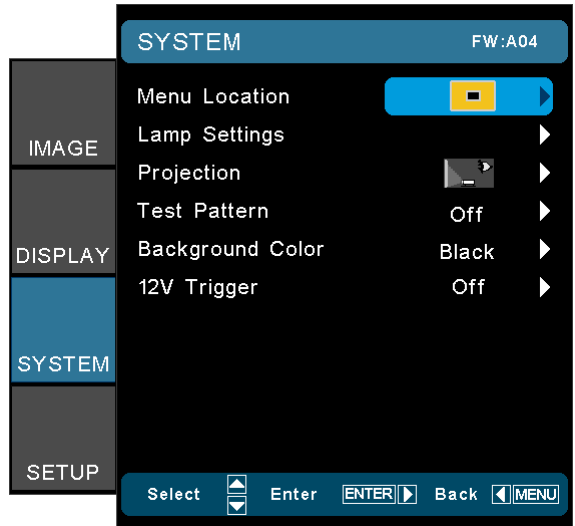

- ❖ Rear-Desktop and Rear-Ceiling are to be used with a translucent screen.





### Menu Location

Choose the menu location on the display screen.

### Lamp Setting

Press ► into the next menu and then use ▲ or ▼ to select item.

### Projection

- ▶  **Front-Projection**  
This is the default selection. The image is projected straight on the screen.
- ▶  **Rear-Desktop**  
When selected, the image will appear reversed.
- ▶  **Front-Ceiling**  
When selected, the image will turn upside down.
- ▶  **Rear-Ceiling**  
When selected, the image will appear reversed in upside down position



- ❖ "Test Pattern" function will gray out when 3D is on.

### Test Pattern

Display a test pattern. There are Grid, White and Off.

## Background Color

Use this feature to display a “Blue”, “Black”, or “Gray” screen when no signal is available.

## 12V Trigger

- ▶ Press the “Off” to disable the trigger.
- ▶ Press the “On” to enable the trigger and the programmable sub-menu. The sub-menu is accessed by selecting the “On” option then pressing the “Enter” button on the remote control. Checking an option in the sub-menu will activate the trigger when the corresponding display mode is selected. For the example, 4:3 has been selected – this means that Trigger B will be active when the projector display mode is set to 4:3. The trigger will be inactive for all the other display mode options.



## SYSTEM | Lamp Settings

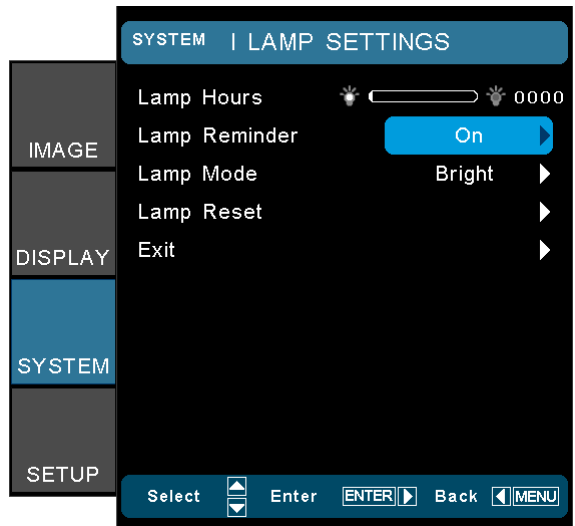

### Lamp Hour

Display the cumulative lamp operating time.

### Lamp Reminder

Choose this function to show or to hide the warning message when the changing lamp message is displayed. The message will appear up 30 hours before suggested replacement of lamp.

### Lamp Mode

- ▶ Bright: Choose “Bright” to increase the brightness.
- ▶ STD: Choose “STD” to dim the projector lamp which will lower power consumption and extend the lamp life.
- ▶ Image AI  
Image AI improves the contrast of the picture by optimizing the brightness of the lamp according to the picture content.

### Lamp Reset

Reset the lamp life hour after replacing the lamp.



- ❖ “Lamp Mode” can be independently set for 2D and 3D.

## SETUP

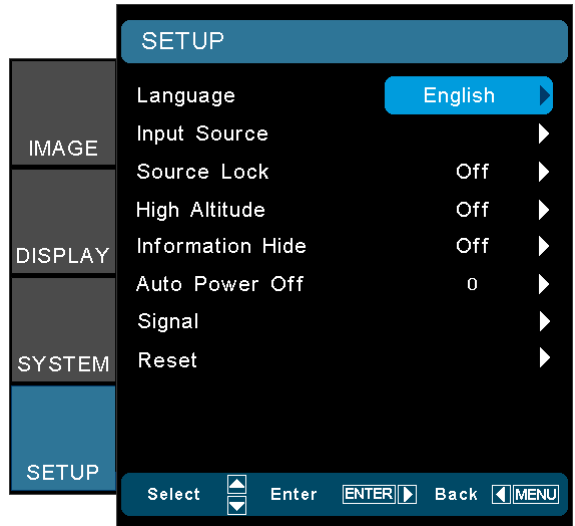

### Language

Choose the multilingual OSD menu. Press ◀ or ▶ into the sub menu and then use the ▲ or ▼ to select your preferred language. Press “Select (Enter)” to finalize the selection.



### Input Source

Use this option to enable / disable input sources. Press ▶ into the next menu and then use ▲ or ▼ to select item. Press “Select (Enter)” to finalize the selection. The projector will not search inputs that are de-selected.

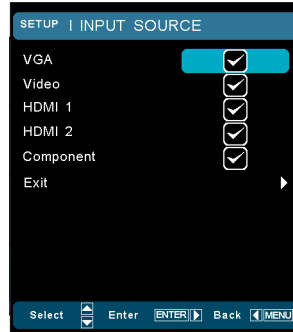

## Source Lock

- ▶ On: The projector will only search current input connection.
- ▶ Off: The projector will search for other signals if the current input signal is lost.

## High Altitude

Choose “On” to turn on High Altitude mode. Operates the fans at full speed continuously to allow for proper high altitude cooling of the projector.

## Information Hide

- ▶ Press “On” to hide the info message.
- ▶ Press “Off” to show the “searching” message.

## Auto Power Off

Set the interval of power-off of the system, if there is no signal input. (In minutes).

## Signal

Press ► into the next menu and then use ▲ or ▼ to select item.

## Reset

Return the adjustments and settings to factory default values.

- ▶ Current: Reset current signal’s settings to factory default values.
- ▶ All: Return the settings for all menus to factory default values.



## SETUP | Signal -RGB Source

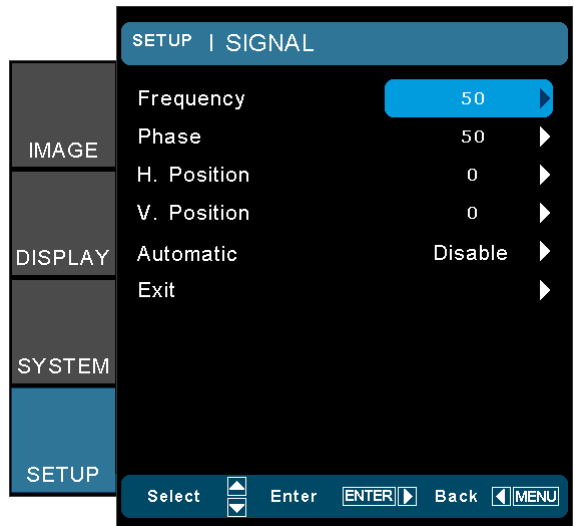

- ❖ "Signal" is only supported in Analog VGA (RGB) signal.

### Frequency

Change the display data frequency to match the frequency of your computer's graphic card. Use this function only if the image appears to flicker vertically.

### Phase

Synchronize the signal timing of the display with the graphic card. If the image appears to be unstable or flickers, use this function to correct it.

### H. Position

- ▶ Press the ◀ to move the image left.
- ▶ Press the ▶ to move the image right.

### V. Position

- ▶ Press the ◀ to move the image down.
- ▶ Press the ▶ to move the image up.

### Automatic

Automatically selects the signal. If you use this function, the Frequency and Phase items are grayed out, and if Signal is not automatic, the Frequency and Phase items will appear for user to manually tune and saved in settings after that for next time projector turns off and on again.

## SETUP | Signal -Video Source

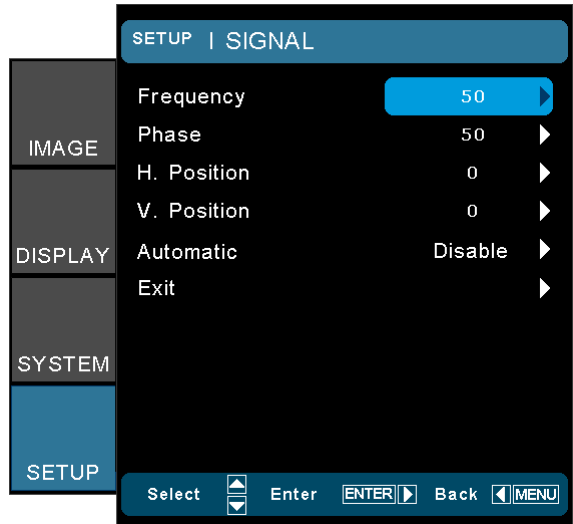

- ❖ "Signal" is not supported when the source is HDMI or DVI-D.
- ❖ "IRE" is only supported on NTSC signal.

### White Level

Allow user adjust White Level when inputting S-Video or Video/ CVBS signals.

### Black Level

Allow user adjust Black Level when inputting S-Video or Video/ CVBS signals.

### Saturation

Adjust a video image from black and white to fully saturated color.

- ▶ Press the ◀ to decrease the amount of color in the image.
- ▶ Press the ▶ to increase the amount of color in the image.

### Hue

Adjust the color balance of red and green.

- ▶ Press the ◀ to increase the amount of green in the image.
- ▶ Press the ▶ to increase the amount of red in the image.

### IRE

- ▶ Adjust measurement of composite video signals.

## Troubleshooting

*If you experience a problem with your projector, please refer to the following information. If a problem persists, please contact your local reseller or service center.*

### Image Problems

#### **No image appears on-screen**

- ▶ Ensure all the cables and power connections are correctly and securely connected as described in the “Installation” section.
- ▶ Ensure the pins of connectors are not crooked or broken.
- ▶ Check if the projection lamp has been securely installed. Please refer to the “Replacing the Lamp” section.
- ▶ Make sure you have removed the lens cap and the projector is switched on.

#### **Image is out of focus**

- ▶ Make sure the Lens cap is removed.
- ▶ Adjust the Focus Ring on the projector lens.
- ▶ Make sure the projection screen is between the required distance 4.9 to 32.8 feet (1.5 to 10.0 meters) from the projector.

#### **The image is stretched when displaying 16:9 DVD title**

- ▶ When you play anamorphic DVD or 16:9 DVD, the projector will show the best image in 16: 9 format on projector side.
- ▶ If you play the LBX format DVD title, please change the format as LBX in projector OSD.
- ▶ If you play 4:3 format DVD title, please change the format as 4:3 in projector OSD.
- ▶ If the image is still stretched, you will also need to adjust the aspect ratio by referring to the following:
- ▶ Please setup the display format as 16:9 (wide) aspect ratio type on your DVD player.

#### **Image is too small or too large**

- ▶ Adjust the zoom lever on the top of the projector.
- ▶ Move the projector closer to or further from the screen.
- ▶ Press “Menu” on the projector panel, go to “Display-->Format”. Try the different settings.

## **Image has slanted sides:**

- ▶ If possible, reposition the projector so that it is centered on the screen and below the bottom of the screen.
- ▶ Use “Display-->V Keystone” from the OSD to make an adjustment.

## **Image is reversed**

- ▶ Select “System-->Projection” from the OSD and adjust the projection direction.

## **Blurry double image**

- ▶ Press “3D Format” button and switch to “Off” to avoid normal 2D image is blurry double image.

## **Two images, side-by-side format**

- ▶ Press “3D Format” button and switch to “SBS” for input signal is HDMI 1.3 2D 1080i side-by-side.

## **Image does not display in 3D**

- ▶ Check if the battery of 3D glasses is drained.
- ▶ Check if the 3D glasses is turned on.
- ▶ When the input signal is HDMI 1.3 2D (1080i side-by-side half), press “3D Format” button and switch to “SBS”.

## Other Problems

### **The projector stops responding to all controls**

- ▶ If possible, turn off the projector, then unplug the power cord and wait at least 20 seconds before reconnecting power.

### **Lamp burns out or makes a popping sound**

- ▶ When the lamp reaches its end of life, it will burn out and may make a loud popping sound. If this happens, the projector will not turn on until the lamp module has been replaced. To replace the lamp, follow the procedures in the “Replacing the Lamp” section.

## Remote Control Problems

### **If the remote control does not work**

- ▶ Check the operating angle of the remote control is within  $\pm 15^\circ$  both horizontally and vertically of one of the IR receivers on the projector.
- ▶ Make sure there are not any obstructions between the remote control and the projector. Move to within 6 m (20 ft) of the projector.
- ▶ Make sure batteries are inserted correctly.
- ▶ Replace batteries if they are exhausted.



## LED Lighting Messages



- ❖ Power LED on: No signal; OSD menu appears and signal had been detected.
- ❖ Power LED off: Signal had been detected but OSD menu disappears.

Message	Power LED (Red)	Power LED (Blue)	Temp LED (Red)	Lamp LED (Orange)
Standby State (Input power cord)	Steady light	Off	Off	Off
Power on (Warming)	Off	Flashing	Off	Off
Power on and Lamp lighting	Off	Steady light *	Off	Off
Power off (Cooling)	Off	Flashing	Off	Off
Error (Lamp fail)	Flashing	Off	Off	Steady light
Error (Fan fail)	Flashing	Off	Flashing	Off
Error (Over Temp.)	Flashing	Off	Steady light	Off

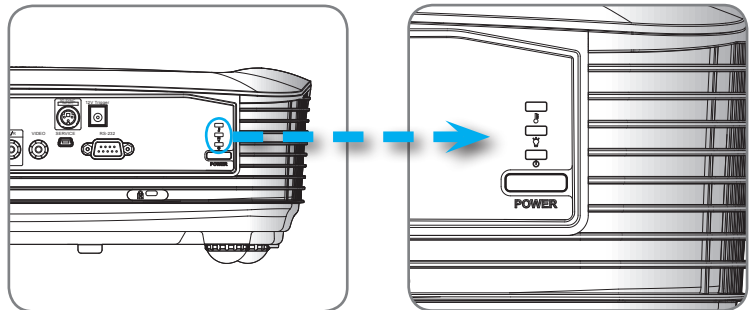

## On Screen Messages

- ❖ Power down timer active:

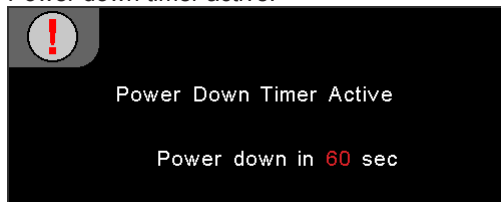

- ❖ Lamp warning:

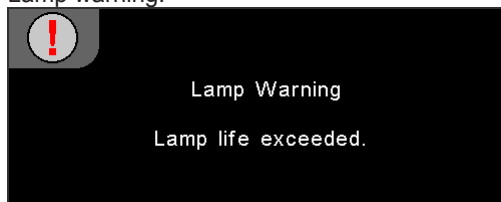

- ❖ Power off:

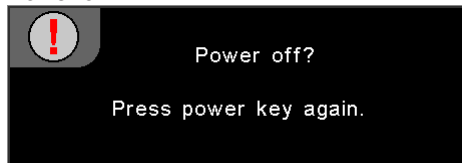

## Replacing the Lamp

The projector automatically detects the lamp life. When the lamp life is nearing the end of use, you will receive a warning message.

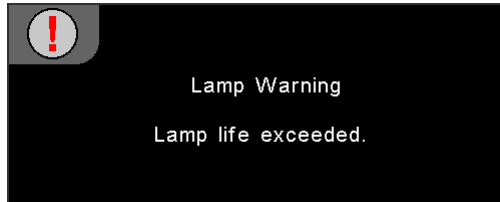

When you see this message, please contact your local reseller or service center to change the lamp as soon as possible. Make sure the projector has been cooled down for at least 30 minutes before changing the lamp.



Warning: If ceiling mounted, please use caution when opening the lamp access panel. It is recommended to wear safety glasses if changing the bulb when ceiling mounted. "Caution must be used to prevent any loose parts from falling out of projector."



Warning: Lamp compartment is hot! Allow it to cool down before changing lamp!



Warning: To reduce the risk of personal injury, do not drop the lamp module or touch the lamp bulb. The bulb may shatter and cause injury if it is dropped.



- ❖ The projector cannot be turned on if the lamp cover has not been placed back on the projector.
- ❖ Do not touch the glass area of the lamp. Hand oil can cause the lamp to shatter. Use a dry cloth to clean the lamp module if it was accidentally touched.

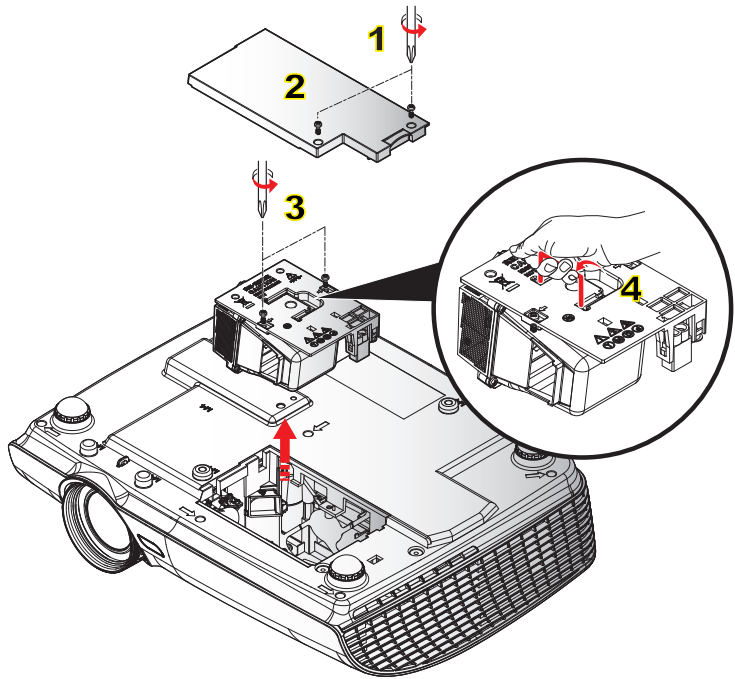

## ○ Lamp Replacing Procedure: ○

1. Switch off the power to the projector by pressing the Power button.
2. Allow the projector to cool down at least 30 minutes.
3. Disconnect the power cord.
4. Unscrew the two screws on the cover. **1**
5. Lift up and remove the cover. **2**
6. Use a screwdriver to remove the screw from the lamp module. **3**
7. Pull out the lamp module. **4**

**To replace the lamp module, reverse the previous steps.**

8. Turn on the projector and do "Lamp Reset" after the lamp module is replaced.

Lamp Reset: (i) Press "Menu" -> (ii) Select "System" -> (iii) Select "Lamp Settings" -> (iv) Select "Lamp Reset" -> (v) Select "Yes".

## Compatibility Modes

### ❖ Computer Compatibility for PC

Signal	Resolution	Frequency H. (KHz)	Refresh Rate (Hz)	Video	Digital	Analog
NTSC	-	15.734	60	O	-	-
PAL/SECAM	-	15.625	50	O	-	-
	720 x 400	31.5	70	-	O	O
	720 x 400	37.9	85	-	O	O
	720 x 576		50	-	O	O
VGA	640 x 480	31.5	60	-	O	O
	640 x 480		67	-	O	O
	640 x 480	37.9	72.8	-	O	O
	640 x 480	37.5	75	-	O	O
	640 x 480	43.3	85	-		O
SVGA	800 x 600	35.2	56.3	-	O	O
	800 x 600	37.9	60.3	-	O	O
	800 x 600	46.9	75	-	O	O
	800 x 600	48.1	72.2	-	O	O
	800 x 600	53.7	85.1	-		O
XGA	1024 x 768	48.4	60	-	O	O
	1024 x 768	56.5	70.1	-	O	O
	1024 x 768	60	75	-	O	O
	1024 x 768	68.7	85	-		O
HD720	1280 x 720		50	-	O	O
	1280 x 720		60	-	O	O
	1280 x 720	92.62	120	-	O	O
WXGA	1280 x 768	47.4	60	-	O	O
	1280 x 768		75	-		O
	1280 x 768		85	-		O
WXGA-800	1280 x 800		60	-	O	O
SXGA	1280 x 1024	64	60	-	O	O
	1280 x 1024	80	75	-	O	O
SXGA+	1400 x 1050		60	-	O	O
UXGA	1600 x 1200	75	60	-	O	O
HD1080	1920 x 1080		24	-	O	O
	1920 x 1080		50	-	O	O
	1920 x 1080		60	-	O	O
WUXGA	1920 x 1200		60	-		O

Signal	Resolution	Frequency H. (KHz)	Refresh Rate (Hz)	Video	Digital	Analog
HDTV	1920 x 1080i		50	-	○	○
	1920 x 1080i		60	-	○	○
	1920 x 1080p		24	-	○	○
	1920 x 1080p		50	-	○	○
	1920 x 1080p		60	-	○	○
	1280 x 720	45	60	○	-	-
	1280 x 720p		50	-	○	○
	1280 x 720p		60	-	○	○
SDTV	720 x 576	31.3	50	○	-	-
	720 x 576i		50	-	○	○
	720 x 576p		50	-	○	○
	720 x 480	31.5	60	○	-	-
	720 x 480i		60	-	○	○
	720 x 480p		60	-	○	○

## ❖ Computer Compatibility for MAC

Resolution	Refresh Rate (Hz)	Macbook compatibility		Macbook Pro (Intel) compatibility		Power Mac G5 compatibility		Power Mac G4 compatibility	
		Digital	Analog	Digital	Analog	Digital	Analog	Digital	Analog
800 x 600	60	○	○	○	○	-	-	○	○
800 x 600	72	○	○	○	○	-	○	○	○
800 x 600	75	○	○	○	○	-	○	○	○
800 x 600	85	-	○	-	○	-	○	-	○
1024 x 768	60	○	○	○	○	-	○	○	○
1024 x 768	70	○	○	○	○	-	○	○	○
1024 x 768	75	○	○	○	○	-	○	○	○
1024 x 768	85	-	○	-	○	-	○	-	○
1280 x 720	60	○	○	○	○	-	○	○	○
1280 x 768	60	○	○	○	○	-	-	○	○
1280 x 768	75	-	○	-	○	-	○	-	○
1280 x 768	85	-	○	-	○	-	-	-	○
1280 x 800	60	○	○	-	○	-	○	○	○
1280 x 1024	60	○	○	-	○	-	○	○	○
1280 x 1024	75	○	○	-	○	-	○	○	○
1920 x 1080	60	○	○	-	○	-	○	○	○
1920 x 1200	60	-	○	-	○	-	○	-	○

## ❖ 3D Input Video Compatibility

Input Resolution	HDMI 1.4a 3D Input	Input Timing			
	HDMI 1.4a 3D Input	1280 x 720p @ 50Hz	Top-and-Bottom		
		1280 x 720p @ 60Hz	Top-and-Bottom		
		1280 x 720p @ 50Hz	Frame packing		
		1280 x 720p @ 60Hz	Frame packing		
		1920 x 1080i @ 50 Hz	Side-by-Side (Half)		
		1920 x 1080i @ 60 Hz	Side-by-Side (Half)		
		1920 x 1080p @ 24 Hz	Top-and-Bottom		
		1920 x 1080p @ 24 Hz	Frame packing		
	HDMI 1.3 3D Content	1920 x 1080i @ 50Hz	Side-by-Side (Half)	While 3D Format is "SBS"	
		1920 x 1080i @ 60Hz	Side-by-Side (Half)		
		1280 x 720p @ 50Hz	Side-by-Side (Half)		
		1280 x 720p @ 60Hz	Side-by-Side (Half)	While 3D Format is "Top and Bottom"	
		1920 x 1080i @ 50Hz	Top-and-Bottom		
		1920 x 1080i @ 60Hz	Top-and-Bottom		
		1280 x 720p @ 50Hz	Top-and-Bottom		
		1280 x 720p @ 60Hz	Top-and-Bottom		
	2D Input (include HDMI/VGA port)	1024 x 768 @ 120Hz	Frame sequential	Auto apply 3D Mode	
		1024 x 768 @ 120Hz	Frame sequential		
	2D Input (include HDMI/VGA/ Component/ Composite port)	480i	HQFS	While 3D Format is "Frame sequential"	
576i		HQFS			

## RS232 Commands and Protocol Function List

### RS232 Pin Assignments

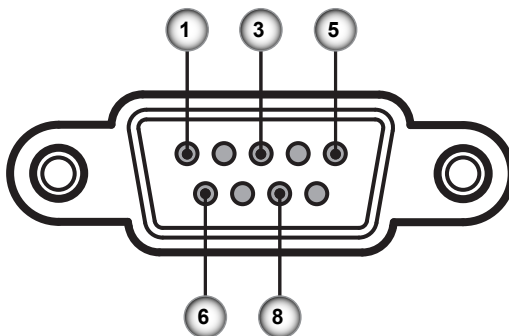

Pin no.	Name	I/O (From Projector Side)
1	NC	—
2	RXD	IN
3	TXD	OUT
4	NC	—
5	GND	Signal Ground
6	NC	—
7	RTS	—
8	CTS	—
9	NC	—



## RS232 Protocol Function List

### Optoma Data and HT Projectors

### HD33

Baud Rate 9600  
 Data Bits 8  
 Parity None  
 Stop Bits 1  
 Flow Control None  
 UART16550 FIFO Disable

Note: There is a <CR> after all ASCII commands, 0D is the HEX code for <CR> in ASCII code

Projector Return (Pass): P  
 Projector Return (Fail): F

XX=01-99, projector's ID, XX=00 is for all projectors

Lead Code	X	X	X	X	X	n	CR					
Function	Projector ID	Command ID	space	variable	carriage return							
Power		On/Off			ASCII	Pass	Fail					
Re-sync					m1/m0 & 2	-X000 n	P					
						-X001 n	P					
						-X002 n	P					
Direct Source Commands	HDMI 1	HDMI 1			m1		F					
		VGA 1			m5		F					
		VGA 1 Component			m6							
		Video			m10							
		Component RCA			m14							
		HDMI 2			m15							
		Cinema			m1	-X020 n	P	F				
		Bright			m2							
		Photo			m3							
		Reference			m4							
Display Mode	List	List			m5							
		ISF Day			m7							
		ISF Night			m8							
		3D			m9							
		Contrast			m	-50 +50	-X022 n	P				
		Brightness			m	-50 +50	-X021 n	P				
		Color			m	-50 +50	-X025 n	P				
		Tim			m	-50 +50	-X044 n	P				
		Sharpness			m	0 +15	-X023 n	P				
						m	0 +10	-X0186 n	P			
IMAGE	Advanced	Noise Reduction	Film	Curve Type		m1	-X035 n	P				
				Reset		m7 +7	-X0182 n					
						m5 +5	-X0183 n					
				Video		m2	-X026 n					
				Curve Type		m7 +7	-X0184 n					
				Offset		m5 +5	-X0185 n					
				Reset		m1	-X0207 n					
				Graphics		m3	-X038 n					
				Curve Type		m7 +7	-X0186 n					
				Offset		m5 +5	-X0187 n					
				Reset		m1	-X0208 n					
				Standard		m4	-X035 n					
				Curve Type		m7 +7	-X0188 n					
				Offset		m5 +5	-X0189 n					
				Reset		m1	-X0209 n					
				PureMotion		m0	-X0180 n					
				LOW		m1	-X0190 n					
				MED		m2	-X0190 n					
				HIGH		m3	-X0190 n					
				120Hz		m4	-X0190 n					
				PureDetail		m0	-X041 n					
				1		m1	-X041 n					
				2		m2	-X041 n					
				3		m3	-X041 n					
				PureColor		m0	-X042 n					
				OFF		m1	-X042 n					
				1		m2	-X042 n					
				2		m3	-X042 n					
				3		m4	-X042 n					
				4		m5	-X042 n					
				PureEngine Demo		m0	-X0187 n					
				OFF		m1	-X0187 n					
				H Split		m2	-X0187 n					
				V Split		m2	-X0187 n					
				Red Gain		m	-50 +50	-X024 n				
				Green Gain		m	-50 +50	-X025 n				
				Blue Gain		m	-50 +50	-X026 n				
				Red Bias		m	-50 +50	-X027 n				
				Green Bias		m	-50 +50	-X028 n				
				Blue Bias		m	-50 +50	-X029 n				
				Reset		m1	-X033 n					
				Warm		m1	-X0210 n					
				Medium		m2	-X0210 n					
				Cold		m3	-X0210 n					
				Auto		m1	-X037 n	P				
				Color Space		RGB (0-255)*	RGB (0-255) supports when HDMI is detected	m2				
						RGB(16 - 235)*	RGB(16 - 235) supports when HDMI is detected	m4				
						YUV		m3				
				DISPLAY	Format	4:3			m1	-X060 n	P	
						16:9			m2			
						LUX			m3			
						Native			m6			
						Auto3D			m9			
						SuperWide			m9			
						Edge Mask			m0-5	-X061 n	P	
						-Zoom			m0-10	-X062 n	P	
						V Image Shift (1-1)			m	-50 +50	-X064 n	P
						V Keystone			m	-50 +50	-X066 n	P
				3D	3D Mode	DLP Link/VESA 3D			m	-30 +30	-X060 n	P
						3D / L / R			m	m2	-X060 n	P
						3D / L / R			m	m2	-X060 n	P
						3D Format	Off/Serial Top and Bottom/Frame Sequential	Decoding HDMI 1.3 3D format	m0/m1/m2/m3			
						3D Sync. Invert	On/Off		m0/m1	-X040 n		
						Off			m0	-X040 n		
						On (16:9)			m1	-X040 n		
						On (2.35:1)			m2	-X040 n		
						Auto			m3	-X040 n		

# Appendices

Lead Code	Projector ID	Command ID	scope	variable	CR			
SYSTEM	Menu Location	Top Left	m1	-XX72 n	P	F		
		Top/Short	m2					
		Centre	m3					
		Bottom Left	m4					
		Bottom Right	m5					
	Lamp Setting	Lamp Hour	m1+m2	-XX108 n	n	n	F	
		Lamp Reminder	On/Off				F	
		Lamp Mode	Bright/STD/ Image AI	m1+m2 & 2	-XX109 n	P	F	
		Lamp Reset	Yes	m1	-XX111 n	P	F	
			No	m2				
	Projection	Front/Desktop	On/Off	m1	-XX71 n	P	F	
		Rear/Desktop	On/Off	m2				
		Front/Ceiling	On/Off	m3				
	Test Pattern	Front/Ceiling	On/Off	m4				
		Rear/Ceiling	On/Off	m5				
	Background Color	Blue	Off / Gnd / White	m1+m2	-XX108 n	P	F	
		Black		m1	-XX104 n			
		Grey		m2				
	12v Trigger		On/Off	m3+m1	-XX102 n			
				m2				
SETUP	Language	English	m1	-XX70 n	P	F		
		German	m2					
		French	m3					
		Italian	m4					
		Spanish	m5					
		Portuguese	m6					
		Polish	m7					
		Dutch	m8					
		Swedish	m9					
		Norwegian/Danish	m10					
		Finnish	m11					
		Greek	m12					
		Traditional Chinese	m13					
		Simplified Chinese	m14					
		Japanese	m15					
		Korean	m16					
		Russian	m17					
		Hungarian	m18					
		Czech	m19					
		Arabic	m20					
	Thai	m21						
	Turkish	m22						
	Input Source	HDMI 1	On/Off	m1	-XX39 n	P	F	
		HDMI 2	On/Off	m7				
		3 x RCA Component	On/Off	m8				
	Signal	Video	On/Off	m10				
		Source Lock	On/Off	m1+m2 & 2	-XX109 n	P	F	
		High Altitude	On/Off	m1+m2 & 2	-XX101 n	P	F	
		Information Hide	On/Off	m1+m2 & 2	-XX102 n	P	F	
		Auto Power Off (min)		On/Off	m1+m2	-XX104 n	P	F
					m1+m2	-XX01 n	P	F
		Reset	Automatic	Enable/Disable	m1+m2	-XX01 n	P	F
			Frequency Tracking	On/Off	m1+m2	-XX03 n	P	F
			Phase	On/Off	m1+m2	-XX04 n	P	F
			H. Position	On/Off	m1+m2	-XX05 n	P	F
	V. Position		On/Off	m1+m2	-XX06 n	P	F	
	White level		On/Off	m1+m2	-XX07 n	P	F	
	Black level		On/Off	m1+m2	-XX08 n	P	F	
	Reset	Saturation	On/Off	m1+m2	-XX09 n	P	F	
		Flux	On/Off	m1+m2	-XX03 n	P	F	
		IRE	0 IRE / 7.5 IRE	m1+m2	-XX04 n	P	F	
	Projector ID		Yes	m1	-XX112 n	P	F	
			No	m2				
	Reset System Alert			n = 00 - 99	-XX79 n	P	F	
	Information from Projector Automatically when:			m1	-XX69 n	P	F	
	Standby Mode			m0		INF/0a		
	Warming up			m1		INF/0a		
	Cooling Down			m2		INF/0a		
	Out of Range			m3		INF/0a		
	Lamp Fail			m4				
Thermal System Error			m5					
Fan Lock			m6					
Over Temperature			m7					
Lamp Hours Running Out			m8					
READ/Return Information from projector	Information		m1	-XX100 n	h abbbccddd			
	f = Power Status	On/Off	m1					
	h = Lamp Hour		m2					
	b = Input Source Commands	None	m0					
		VGA	m0					
		Video	m0					
		HDMI1	m0					
		HDMI2	m0					
		Component	m1					
	f = Firmware Version		m0					
	b = Display mode	None	m0					
		Cinema	m1					
		Right	m2					
		Movie	m3					
		gSlide	m4					
		User1	m5					
		User2	m6					
		ISF Day	m7					
		ISF Night	m8					
		3D	m9					
	Model Name		m1	-XX181 n	Ok	a=1 H1B3 a2 H1B3		
		Depends	a=011Z					
	RS232 Version No		m1	-XX182 n	Ok			
		Depends	a=7?					
	Input Source Commands	None/VGA/Video/HDMI1/HDMI2	m1	-XX121 n	Ok	a=02/05/07/11		
	Software Version		m1	-XX122 n	Okddd			
	Display Mode		m1		Ok	a=1/2/3/4/5/7/8/9 Cinema=1 Bright=2 Phase=3 Reference=4 User=5 ISF Day=7 ISF Night=8 3D=9		
	Power State	None/ID	m1	-XX123 n	Ok	a=10		
	Brightness	On/Off	m1	-XX125 n	Ok			



## Ceiling Mount Installation

1. To prevent damage to your projector, please use the Optoma ceiling mounting mount.
2. If you wish to use a third party ceiling mount kit, please ensure the screws used to attached a mount to the projector met the following specifications:
  - ▶ Screw type: M4\*3
  - ▶ Maximum screw length: 10mm
  - ▶ Minimum screw length: 7.5mm



❖ Please note that damage resulting from incorrect installation will invalidate the warranty.



### Warning:

1. If you buy a ceiling mount from another company, please be sure to use the correct screw size. Screw size will vary depending on the thickness of the mounting plate.
2. Be sure to keep at least 10cm gap between the ceiling and the bottom of the projector.
3. Avoid installing the projector near a heat source.

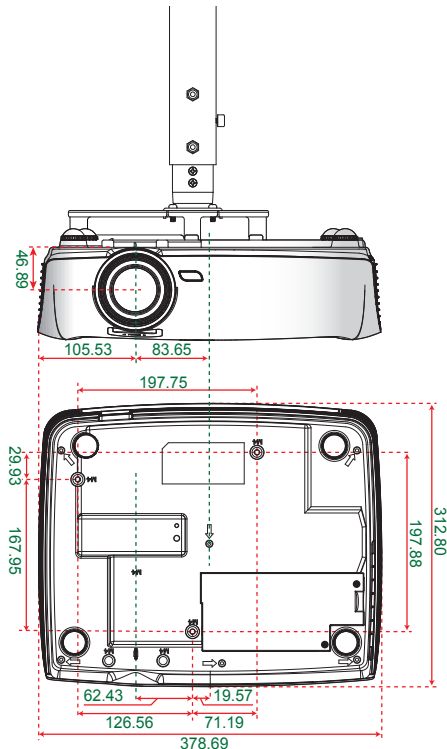



## Optoma Global Offices

For service or support please contact your local office.



### USA

3178 Laurelview Ct.  
Fremont, CA 94538, USA  
www.optomausa.com

 888-289-6786  
 510-897-8601  
 services@optoma.com



### Canada

2420 Meadowpine Blvd., Suite #105  
Mississauga, ON, L5N 6S2, Canada  
www.optoma.ca

 888-289-6786  
 510-897-8601  
 services@optoma.com



### Latin America

3178 Laurelview Ct.  
Fremont, CA 94538, USA  
www.optomausa.com

 888-289-6786  
 510-897-8601  
 services@optoma.com



### Europe

42 Caxton Way, The Watford Business Park Watford, Hertfordshire, WD18 8QZ, UK  
www.optoma.eu  
Service Tel: +44 (0)1923 691865

 +44 (0) 1923 691 800  
 +44 (0) 1923 691 888  
 service@tsc-europe.com



### Benelux BV

Randstad 22-123  
1316 BW Almere  
The Netherlands  
www.optoma.nl

 +31 (0) 36 820 0253  
 +31 (0) 36 548 9052



### France

Bâtiment E  
81-83 avenue Edouard Vaillant  
92100 Boulogne Billancourt, France

 +33 1 41 46 12 20  
 +33 1 41 46 94 35  
 savoptoma@optoma.fr



### Spain

C/ José Hierro, 36 Of. 1C 28522  
Rivas Vaciamadrid,  
Spain

 +34 91 499 06 06  
 +34 91 670 08 32



## Deutschland

Wiesenstrasse 21 W  
D40549 Düsseldorf,  
Germany

 +49 (0) 211 506 6670  
 +49 (0) 211 506 66799  
 info@optoma.de

## Scandinavia



Lerpeveien 25  
3040 Drammen  
Norway

 +47 32 98 89 90  
 +47 32 98 89 99  
 info@optoma.no

PO.BOX 9515  
3038 Drammen  
Norway

## Korea

WOOMI TECH.CO.,LTD.  
4F, Minu Bldg. 33-14, Kangnam-Ku,  
seoul,135-815, KOREA

 +82+2+34430004  
 +82+2+34430005



## Japan

東京都足立区綾瀬3-25-18  
株式会社オーエスエム  
サポートセンター: 0120-46-5040

 info@osscreen.com  
www.os-worldwide.com



## Taiwan

5F., No. 108, Minchiuan Rd.  
Shindian City,  
Taipei Taiwan 231, R.O.C.  
www.optoma.com.tw

 +886-2-2218-2360  
 +886-2-2218-2313  
 services@optoma.com.tw  
asia.optoma.com



## Hong Kong

Unit A, 27/F Dragon Centre,  
79 Wing Hong Street,  
Cheung Sha Wan,  
Kowloon, Hong Kong

 +852-2396-8968  
 +852-2370-1222  
www.optoma.com.hk

## China

5F, No. 1205, Kaixuan Rd.,  
Changning District  
Shanghai, 200052, China

 +86-21-62947376  
 +86-21-62947375  
www.optoma.com.cn

## Regulation & Safety Notices

*This appendix lists the general notices of your projector.*

### FCC Notice

This device has been tested and found to comply with the limits for a Class B digital device pursuant to Part 15 of the FCC rules. These limits are designed to provide reasonable protection against harmful interference in a residential installation. This device generates, uses and can radiate radio frequency energy and, if not installed and used in accordance with the instructions, may cause harmful interference to radio communications.

However, there is no guarantee that interference will not occur in a particular installation. If this device does cause harmful interference to radio or television reception, which can be determined by turning the device off and on, the user is encouraged to try to correct the interference by one or more of the following measures:

- ❖ Reorient or relocate the receiving antenna.
- ❖ Increase the separation between the device and receiver.
- ❖ Connect the device into an outlet on a circuit different from that to which the receiver is connected.
- ❖ Consult the dealer or an experienced radio/television technician for help.

### **Notice: Shielded cables**

All connections to other computing devices must be made using shielded cables to maintain compliance with FCC regulations.

### **Caution**

Changes or modifications not expressly approved by the manufacturer could void the user's authority, which is granted by the Federal Communications Commission, to operate this projector.

### **Operation Conditions**

This device complies with Part 15 of the FCC Rules. Operation is subject to the following two conditions:

1. This device may not cause harmful interference and
2. This device must accept any interference received, including interference that may cause undesired operation.

### **Notice: Canadian users**

This Class B digital apparatus complies with Canadian ICES-003.

### **Remarque à l'intention des utilisateurs canadiens**

Cet appareil numérique de la classe B est conforme à la norme NMB-003 du Canada.

## Declaration of Conformity for EU countries

- EMC Directive 2004/108/EC (including amendments)
- Low Voltage Directive 2006/95/EC
- R & TTE Directive 1999/5/EC (if product has RF function)



### Disposal instructions

Do not throw this electronic device into the trash when discarding. To minimize pollution and ensure utmost protection of the global environment, please recycle it.

