

Table of Contents

Usage Notice

<i>Precautions</i>	<i>2</i>
--------------------------	----------

Introduction

<i>Product Features</i>	<i>3</i>
<i>Package Overview</i>	<i>4</i>
<i>Product Overview</i>	<i>5</i>

Installation

<i>Connecting the Projector to Desktop Computer</i>	<i>8</i>
<i>Connecting the Projector to Portable Computer</i>	<i>9</i>
<i>Connecting the Projector to Other Video Sources</i>	<i>10</i>
<i>Powering On/Off the Projection Display</i>	<i>12</i>
<i>Adjusting the Projected image</i>	<i>14</i>







User Controls

<i>Panel Control & Remote Control</i>	<i>16</i>
<i>On-Screen Display Menus</i>	<i>18</i>

Appendices

<i>Troubleshooting</i>	<i>22</i>
<i>Changing the Lamp</i>	<i>24</i>
<i>Specifications</i>	<i>25</i>
<i>Compatibility Modes</i>	<i>26</i>

Usage Notice

-  **Warning-** Do not look into the lens. The bright light may hurt your eyes.
-  **Warning-** To reduce the risk of fire or electric shock, do not expose this product to rain or moisture.
-  **Warning-** Please do not open or disassemble the product as this may cause electric shock.
-  **Warning-** When changing the lamp, please allow unit to cool down, and follow all changing instructions.
-  **Warning-** This product will detect the life of the lamp itself. Please be sure to change the lamp when it shows warning messages.
-  **Warning-** After changing a new lamp, please reset the lamp life from OSD menu.
-  **Warning-** Before switching off the product, please keep the cooling fan running for a few minutes.

Precautions

Follow all warnings, precautions and maintenance as recommended in this user's manual to maximize the life of your unit.

Do:

- Turn off the product before cleaning.
- Use a soft cloth moistened with mild detergent to clean the display housing.
- Disconnect the power plug from AC outlet if the product is not being used for a long period of time.

Don't:

- Block the slots and openings on the unit provided for ventilation.
- Use abrasive cleaners, waxes or solvents for your cleaning.
- Use under the following conditions:
 - Extremely hot, cold or humid environment.
 - In areas susceptible to excessive dust and dirt.
 - Near any appliance generating a strong magnetic field.
 - Place in direct sunlight.

Introduction

Product Features

This product, is an XGA single chip DMD™ Projector. The outstanding features of it are listed as follows:

- ❑ True XGA, 1024 x 768 addressable pixels
- ❑ 5 lbs (2.3 kgs) lightweight compact design
- ❑ Single chip DMD™ technology
- ❑ SXGA compression and VGA, SVGA resizing
- ❑ 120 Watts user replaceable UHP lamp
- ❑ Mac/ NEC PC-98/ FM Towns compatible
- ❑ NTSC/ PAL/ SECAM compatible
- ❑ Full function remote control
- ❑ Real plug & play with auto image function
- ❑ User friendly Multilingual on-screen display menu
- ❑ Advanced electronic keystone correction and picture in picture function
- ❑ Luxurious carrying case included

Package Overview

This projection display comes with all the items shown below. Check to make sure your unit is complete. Contact your dealer immediately if anything is missing.

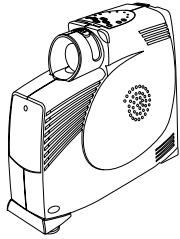

Projection Display

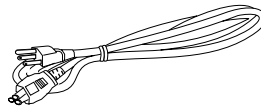

Power Cord

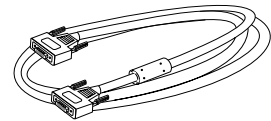

VGA Cable



S-Video Cable

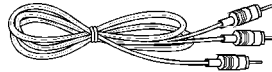

Audio-In Cable for Computer



Composite Video Cable



Audio Cable



User's Manual



Warranty Card

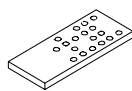

Remote Control



Carrying Case

Product Overview

Main Unit

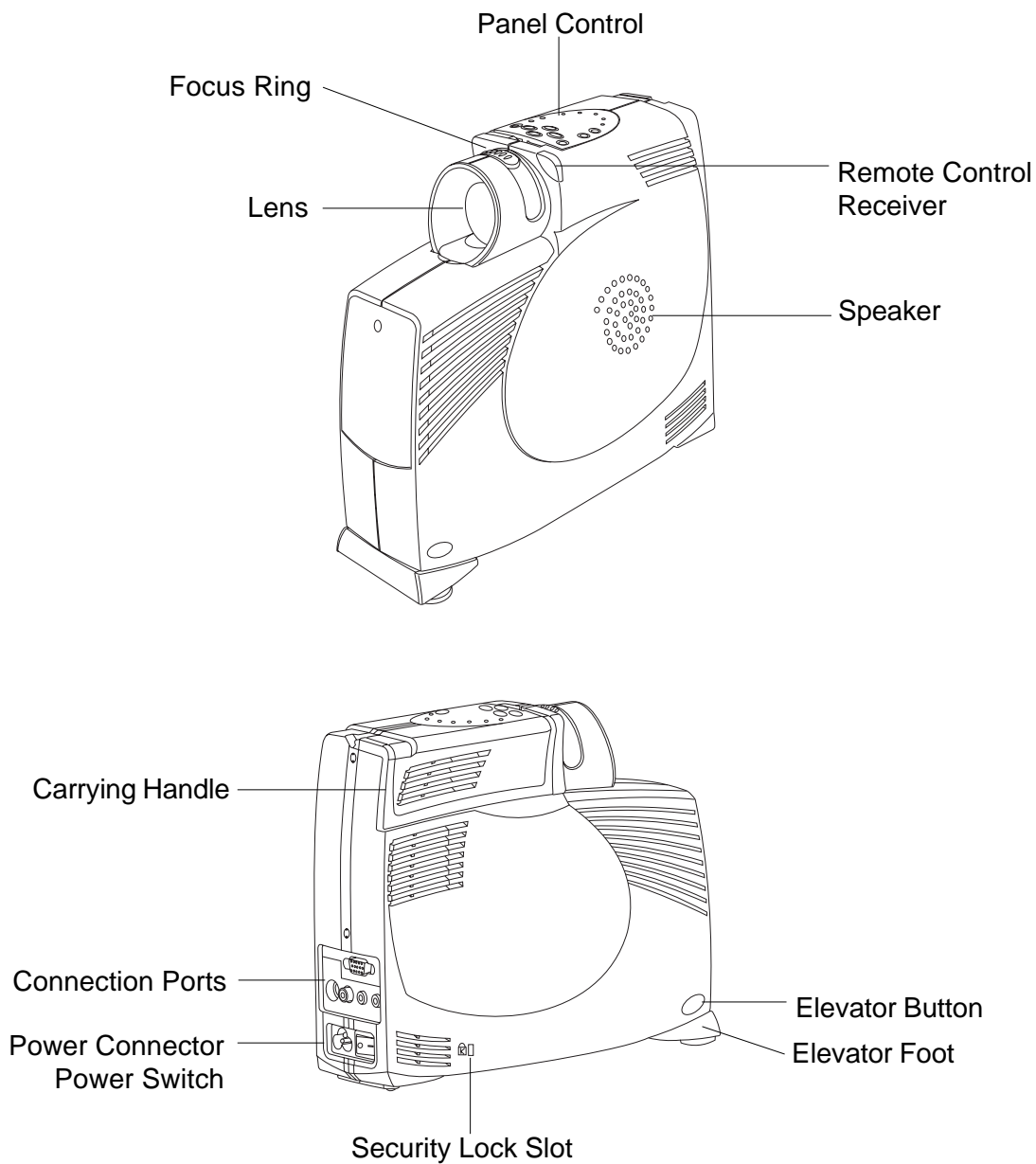

Connection Ports

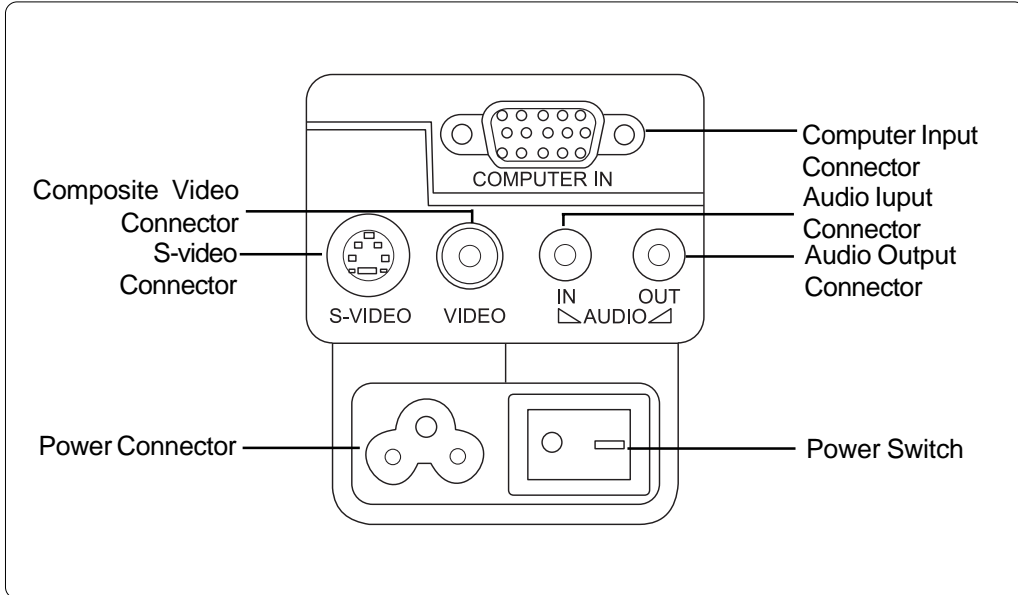

Panel Control

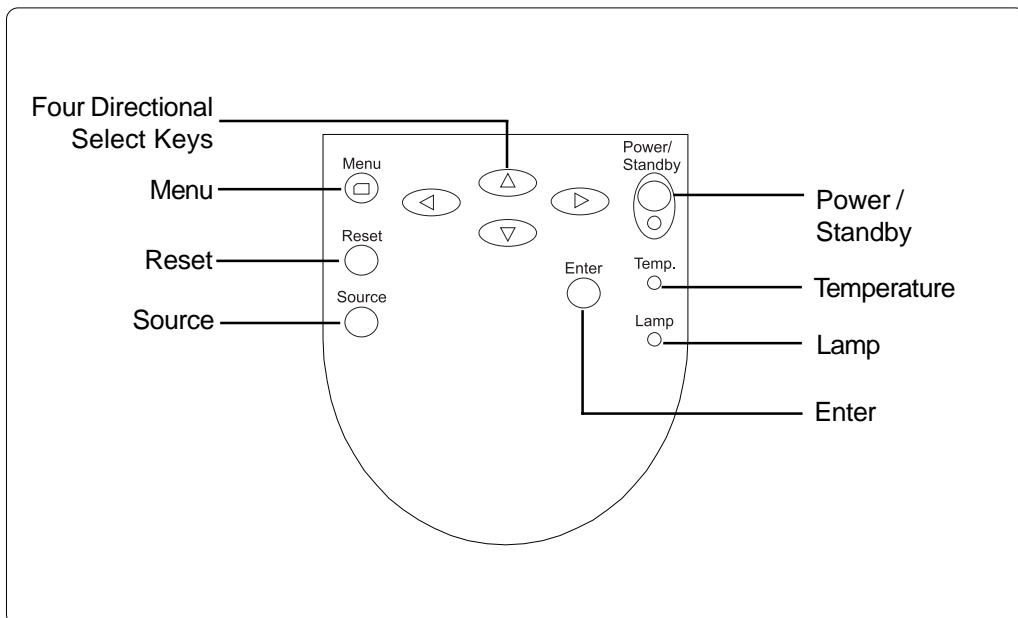

Remote Control

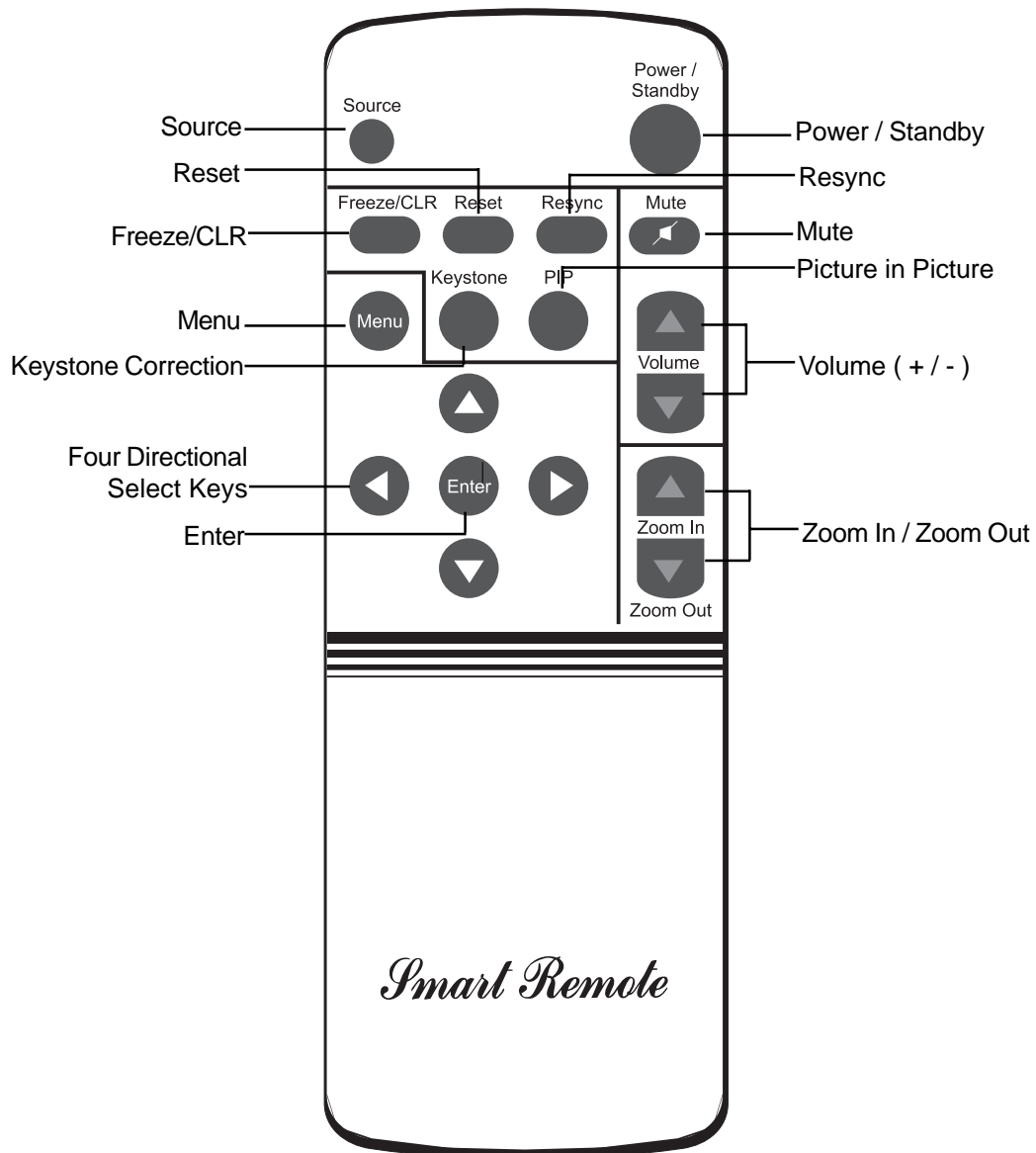

Installation

Connecting the Projector to Desktop Computer

1. Make sure the projector and your computer are turned off.
2. Connect one end of the projector signal cable to the projector; connect the other end to the VGA connector on the computer and tighten the screws.
3. Connect one end of the power cord into the back of projector; connect the other end to an electrical outlet.

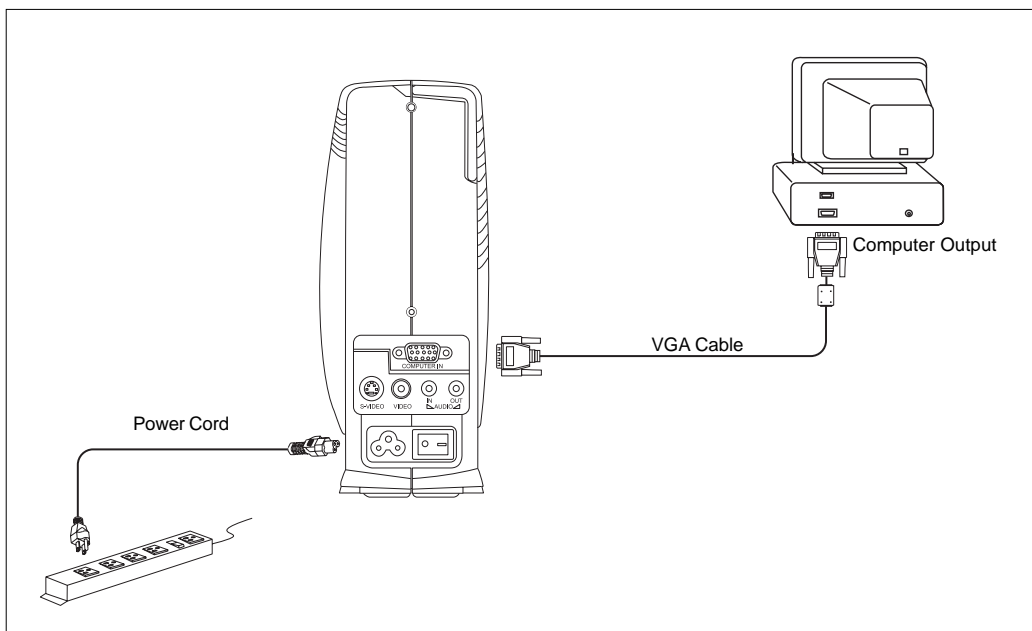

❖ *To ensure the projection display works well with your computer, please configure the display mode of your graphic card to make it less than or equal to 1024 X 768 resolution. Make sure timing of the display mode is compatible with the projection display. Refer to the “Compatibility Modes” section on page 26.*

Connecting the Projector to Portable Computer

1. Make sure the projector and your notebook are turned off.
2. Connect one end of the projector signal cable to the projector; connect the other end to the VGA connector on the notebook and tighten the screws.
3. Connect one end of the power cord into the back of projector; connect the other end to an electrical outlet.

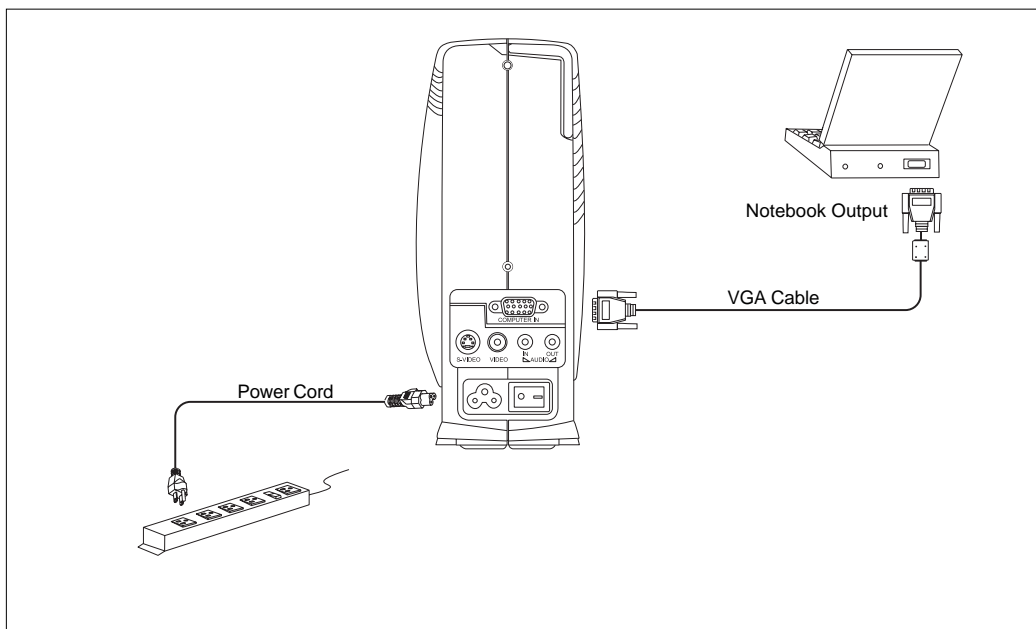

Connecting the Projector to Other Video Sources

❖ If your video player uses a round, one-prong composite video connector, you'll need the video cable. If your video player uses a round, four-prong s-video connector, you'll need the s-video cable (See page 11 for detail information).

Both cables are shipped with the projector.

If you use the video cable:

1. Plug the video cable connector into the “Video out” port on your video player; plug the other end into the “Video” port on your projector.
2. Plug the audio cable white connector into the left “Audio out” port on your video player; plug the cable’s red connector into the right “Audio out” port on the video player; plug the other end into the “Audio in” port on your projector.
3. If you need to use an external speaker (built in amplifier), plug the audio cable white connector into the “Audio in” port on your speaker; plug the cable’s red connector into the red “Audio in” port on the speaker; plug the other end into the “Audio out” port on the projector.
4. Connect one end of the power cord into the back of projector; connect the other end to an electrical outlet.

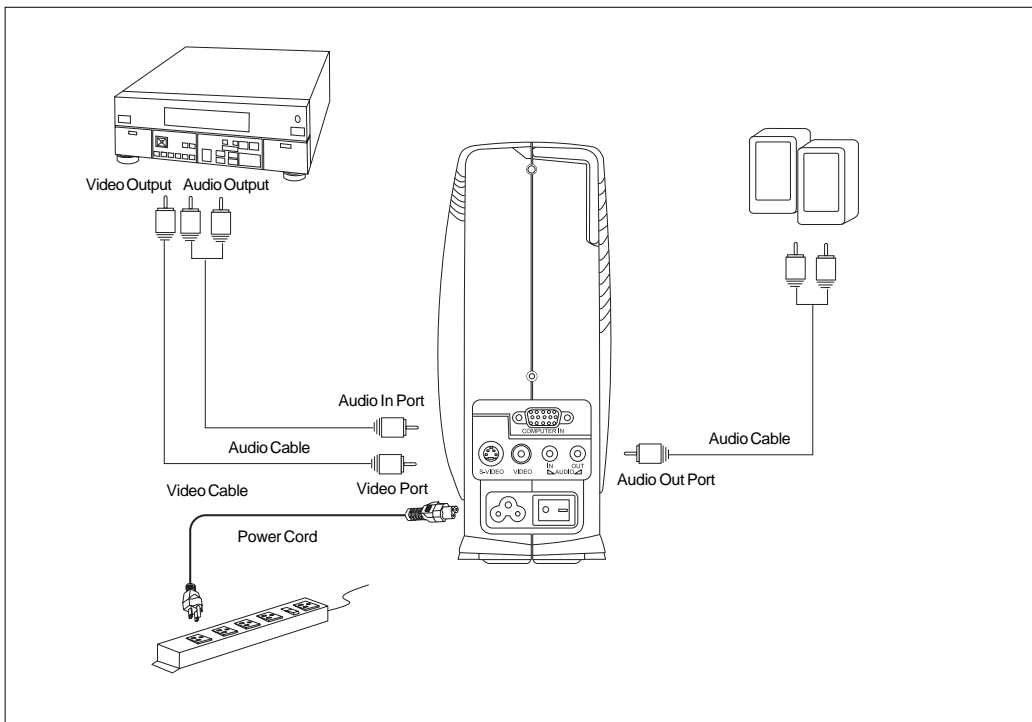

If you use the s-video cable:

1. Plug the s-video cable connector into the “S-Video” port on your video player; plug the other end into the “S-Video” port on your projector.
2. Plug the audio cable white connector into the left “Audio out” port on your video player; plug the cable’s red connector into the right “Audio out” port on the video player; plug the other end into the “Audio in” port on your projector.
3. If you need to use an external speaker (built in amplifier), plug the audio cable white connector into the white “Audio in” port on your speaker; plug the cable’s red connector into the red “Audio in” port on the speaker; plug the other end into the “Audio out” port on your projector.
4. Connect one end of the power cord into the back of projector; connect the other end to an electrical outlet.

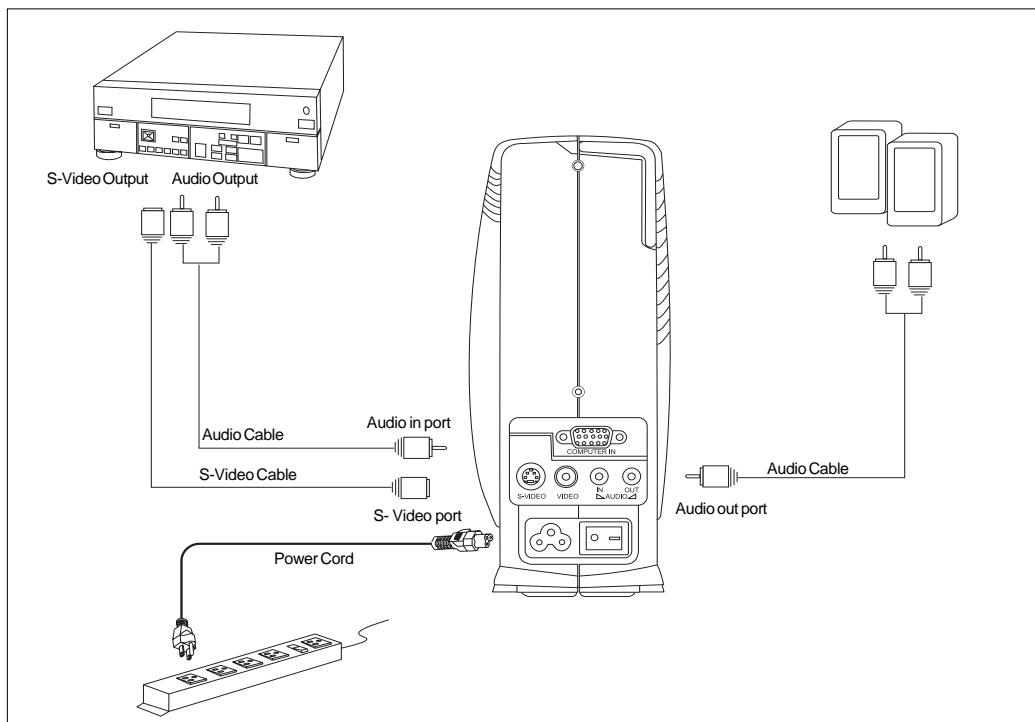

Power On/Off the Projection Display

◆ Powering On the Projection Display

1. Remove the lens cap. ❶
2. Ensure that the power cord and signal cable are securely connected.
3. Turn on the main power switch on the back of the projector and allow the projector to warm up for 1-2 minutes. ❷
4. Turn on the lamp by pressing “Power/Standby” button on the Panel Control. ❸
The startup screen will display for 30 seconds and the Power/Standby indicator will light solid green.
5. Turn on your source (computer, notebook, or video player ,etc.). The projector will detect your source automatically.

* If the screen displays “No Signal” , please make sure the signal cables are securely connected.

* If you connect multiple sources at the same time, use the “Source” button on the Remote Control or Panel Control to switch.

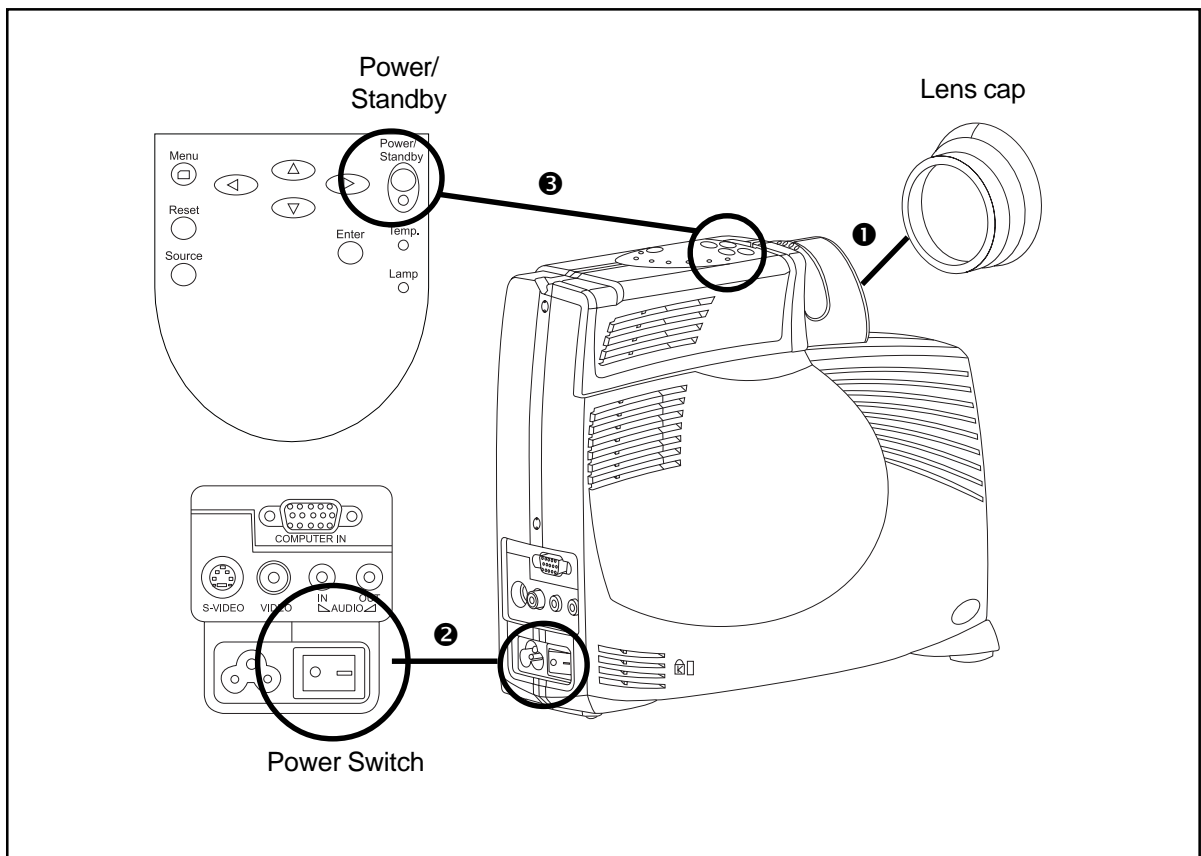

◆ Powering Off the Projection Display

1. Press the “Power/Standby” button to turn off the projector lamp.
2. After pressing the “Power/Standby” button, you will see a message “Power off the lamp?” on the on-screen display. Press the “Power/Standby” button again to confirm. Otherwise the message will disappear after 5 seconds.
3. “LAMP” LED indicator will flash amber for about one minute. After the “LAMP” LED indicator stops flashing, you can turn off the main power switch on the back of the projector.
**If you want to turn on the main power switch immediately, you must allow about 10 minutes for thermal dissipation.*
4. Disconnect the power cord from the electrical outlet and the projector.

* When the “LAMP” indicator lights solid amber; please change the lamp module immediately.

* When the “TEMP” indicator lights solid amber, it indicates the display has been overheated. The display will automatically shut itself down. Under normal conditions, the display can be switched on again for your presentation. If the problem persists, you should contact your local dealer or our service center.

Adjusting the Projected Image

◆ Adjusting the Projector Height

The projector is equipped with an elevator foot for adjusting the projector height.

To raise the projector:

1. Press and hold the elevator button **①**.
2. Raise the projector to the desired display angle **②**, then release the button to lock the elevator foot into position.

To lower the projector:

1. Press and hold the elevator button.
2. Lower down the projector, then release the button to lock the elevator foot into position.

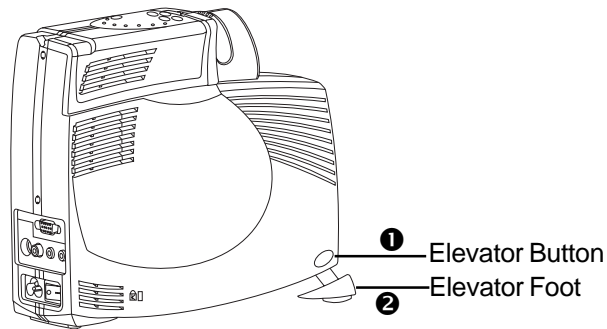

* When you adjust the projector height; please place the projector on a flat surface and avoid falling down of the projector.

* For safety purpose, when you adjust the projector height; please loosen the wheels **①** under the elevator foot and pull the stands out **②** .

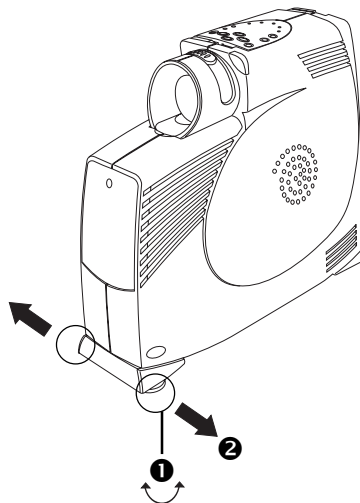

◆ **Adjusting the Projector Focus**

To focus the image, rotate the focus ring until the image is clear. The projector will focus at distances from 3.3 feet to 33 feet (1m to 10m).

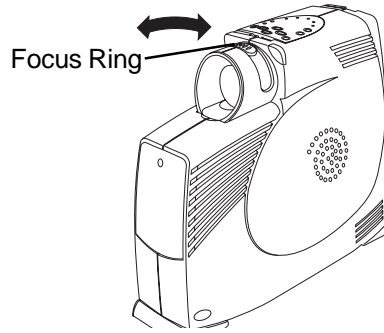

◆ **Image Size Adjustment**

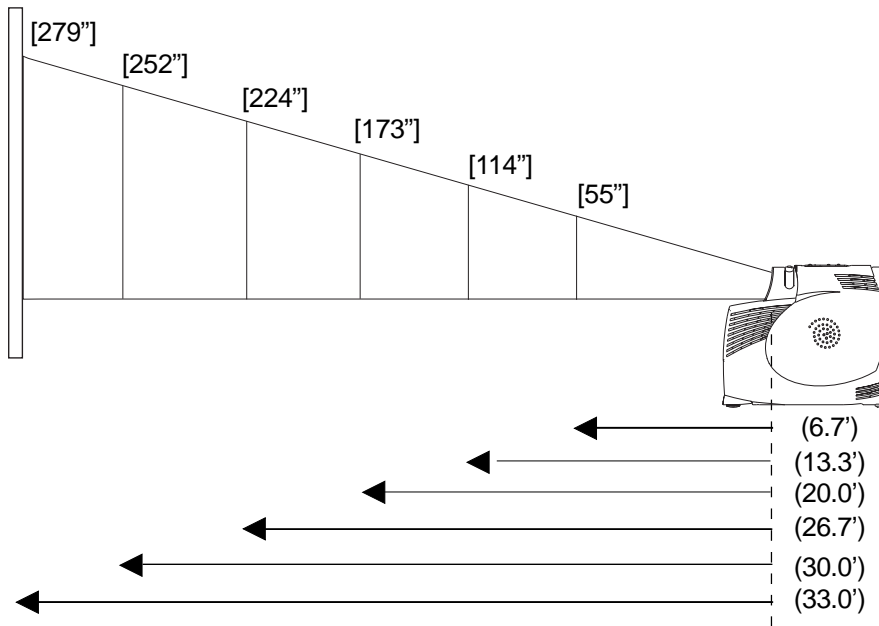

Screen Diagonal	28"	55"	84"	114"	141"	173"	196"	224"	252"	279"
Screen Width	22.4"	44"	67.2"	91.2"	112.8"	138.4"	156.8"	179.2"	201.6"	223.2"
Screen Height	16.8"	33"	50.4"	68.4"	84.6"	103.8"	117.6"	134.4"	151.2"	167.4"
Projection Distance	3.3'	6.7'	10.0'	13.3'	16.7'	20.0'	23.3'	26.7'	30.0'	33.0'

*This graph is for user's reference only.

User Controls

There are two ways for you to control the functions: Remote Control and Panel Control.

Remote Control

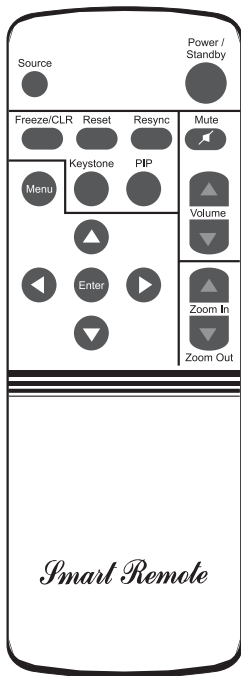

Panel Control

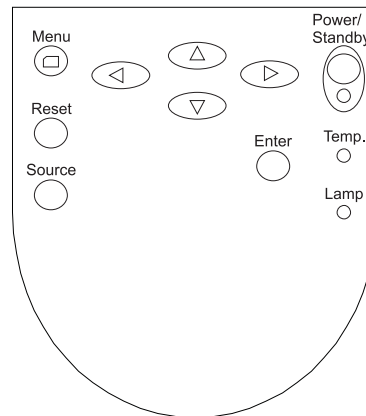

Power / Standby

- ▶ Power the lamp on and off when the main power switch is turned on.

Menu

- ▶ Press “Menu” to open the on-screen display (OSD) menus and to switch among different menus. To exit OSD, press the “Freeze/CLR” button or select the “Exit Menu” icon and press “Enter” button. The projector saves any changes you made automatically.

Source

- ▶ Press “Source” to choose between video and computer sources.





Reset

- ▶ When you press the “Reset” button, the OSD menu displays a message “Reset All Yes/NO ?”. Select “Yes” to confirm or select “No” to cancel. This function will reset all user adjustable parameters to factory default settings.



Enter

- ▶ Press “Enter” to confirm your selection.

Four Directional Select Keys

- ▶ Use  or  to select items. Use  or  to make adjustments for your selection.

Volume

- ▶ To increase the volume, press 
- ▶ To decrease the volume, press 
- ▶ To mute the volume, press “Mute”

Resync

- ▶ Automatically synchronizes the projector to the input source.

Freeze/CLR

- ▶ Press the “Freeze/CLR” button to still the screen image.
- ▶ When the OSD is displayed, press the “Freeze/CLR” button to exit the OSD.

PIP (Picture in Picture)

- ▶ Display a video source image on a small screen. (Computer mode only).
Please refer to “Page 20” for more information.

Zoom In (Computer mode only)

- ▶ Magnifies an image up to a factor of 32 times on the projection screen.
- ▶ When the “Zoom” icon is displayed, you can use the four directional select keys to change the vertical or horizontal positioning of the image.

Zoom Out (Computer mode only)





- ▶ Diminishes the zoom in image.
- ▶ When the “Zoom” icon is displayed, you can use the four directional select keys to change the vertical or horizontal positioning of the image.

Keystone

- ▶ Adjusts image distortion caused by tilting the projector.

OSD Menu

How to operate

- ▶ *The Projector has a multilingual On-Screen Display(OSD) menu that allows you to make image adjustments and change a variety of settings. In computer source, the OSD will be the “Computer OSD”. In video source, the OSD will be the “ Video OSD”. The projector will detect the source automatically.*
- ▶ *To open the OSD menu, press the “menu” button on the Remote Control or Panel Control.*
- ▶ *To select among different menus, press the” Menu” button again. Then use   to select different items and use   to adjust your selection.*
- ▶ *To exit the OSD, choose the “Exit Menu” and press the enter button.*
- ▶ *When the OSD is displayed, press the “Freeze/CLR” button to exit the OSD.*

Language

▶ Language

You can display the multilingual OSD menu . Use the “ Up” and “ Down” key to select the language you prefer. The menus redraw immediately.

Display

▶ Brightness

Adjusting the brightness of the image.

- Press the left key to darken the image.
- Press the right key to lighten the image.

▶ Contrast

The contrast controls the degree of difference between the lightest and darkest parts of the picture. Adjusting the contrast changes the amount of black and white in the image.

- Press the left key to decrease the contrast.
- Press the right key to increase the contrast

▶ Keystone Correction

Adjusts image distortion caused by tilting the projector.

▶ Color Temperature

Adjusts the color temperature. The range is from 6500°K to 7700°K . The factory default is 7100°K . With the higher temperature, the screen looks colder; with the lower temperature, the screen looks warmer.

▶ **Tint (Video mode only)**

The tint adjusts the red-green color balance in the projected image.

- Press the left key to increase the amount of green in the image.
- Press the right key to increase the amount of red in the image.

▶ **Color (Video mode only)**

The color setting adjusts a video image from black and white to fully saturated color.

- Press the left key to decrease the amount of color in the image.
- Press the right key to increase the amount of color in the image.

Image (Computer mode only)

▶ **Tracking**

Choose “Tracking” item to synchronize the signal timing of the display with that of the graphic card. When you experience an unstable or flickering image, use this function to correct it.

▶ **Frequency**

“Frequency” is for changing the display data frequency to match the frequency of your computer’s graphic card. When you experience a vertical flickering bar, use this function to make an adjustment.

▶ **Horizontal Position**

- Press the left button to move the image left.
- Press the right button to move the image right.

▶ **Vertical Position**

- Press the left button to move the image up.
- Press the right button to move the image down.

▶ **Auto-Image**

The projector automatically adjusts tracking, frequency and vertical and horizontal position for most computers.

* *The image options are available only for computer sources. The projector sets these options automatically for video sources.*

Audio

▶ **Volume**

- Press the left button to decrease the volume.
- Press the right button to increase the volume.

▶ **Bass**

The Bass setting controls the lower frequencies of your audio source.

- Press the left button to decrease the bass.
- Press the right button to increase the bass.

▶ Treble

The treble setting controls the higher frequencies of your audio source.

- Press the left button to decrease the treble.
- Press the right button to increase the treble.

▶ Mute

- Choose the left icon to make the volume function ineffective.
- Choose the right icon to make the volume function effective.

▶ Mono / Stereo / Stereo-enhance

- Mono: Mono sound effect.
- Stereo: Stereo sound effect.
- Stereo-enhance: Stereo-enhance sound effect.

Projection

▶ Front-Desktop

The factory default setting.

▶ Rear-Desktop

When you select this function, the projector reverses the image so you can project behind a translucent screen.

▶ Front-Ceiling

When you select this function, the projector turns the image upside down for ceiling-mounted projection.

▶ Rear-Ceiling

When you select this function, the projector reverses and turns the image upside down at same time. You can project from behind a translucent screen with ceiling mounted projection.

▶ 16 : 9 (Video mode only)

You can select this function to fit your DVD aspect ratio type.

▶ 4 : 3 (Video mode only)

You can select this function to fit your DVD aspect ratio type.

▶ PIP

Choose “On” to turn on the PIP screen. When the PIP screen displayed, use the four directional select keys to change the PIP screen position. Choose “Off” to turn off the PIP screen.

Lamp

▶ **Lamp Warning**

Choose this function to show or hide the warning message when the lamp changing warning message is displayed.

▶ **Lamp Reset**

Reset the lamp setting only when the lamp changing is done.

Exit Menu

▶ **Exit Menu**

When you want to close the OSD menu, choose this item and select “Yes” to exit menu.

▶ **Reset All**

Choose “Yes” to return the display parameters of the current mode to its factory default settings.

Appendices

Troubleshooting

If you are experiencing trouble with the projection display, refer to the following. If the problem persists, please contact your local dealer or our service center.

Problem: No image appears on screen.

- ▶ Ensure all the cables and power connections are correctly and securely connected as described in the “Installation” section.
- ▶ If the projector is plugged into a power strip, make sure the power strip is turned on.
- ▶ Ensure the pins of connectors are not crooked or broken.
- ▶ Check if the projection lamp has been securely installed. Please refer to the “Changing the lamp” section.
- ▶ Make sure you have removed the lens cap and the projector is switched on.

Problem: Partial, scrolling or incorrectly displayed image.

- ▶ Press the “Resync” button on the Remote Control.
- ▶ If you are using a PC:
If the resolution of your computer is higher than 1024 x 768. Follow the steps outlined below to reset the resolution.

For Windows 3.x:

1. In the Windows Program Manager, click the “Windows Setup” icon in the Main group.
2. Verify that your display resolution setting is less than or equal to 1024x 768.

For Windows 95:

1. Open “My Computer” icon, the “Control Panel” folder, and then double click the “Display” icon.
2. Select the “Setting” tab.
3. In the “Desktop Area” you will find the resolution setting. Verify that the resolution setting is less than or equal to 1024 x 768 resolution.

If the projection display is still not projecting the whole image, you will need to also change the monitor display you are using. Refer to the following steps.

4. Follow above steps 1~2. Click on the “Advanced Properties ” button.
 5. Select the “Change” button under the “Monitor” tab .
 6. Click on “ Show all devices ”. Then select “ Standard monitor types ” under the “ Manufactures ” box; choose the resolution mode you need under the “ Models” box.
 7. Verify that the resolution setting of the monitor display is less than or equal to 1024 x 768.
- ▶ If you are using a Notebook PC:
 1. You are required to implement above steps of resolution setting of computer first.
 2. Switch the Notebook PC display to the “external display only” or “CRT only” mode.
 - ▶ If you are experiencing difficulty in changing resolutions or your monitor freezes, restart all the equipment and the projection display.

Problem: The screen of the Notebook or PowerBook computer is not displaying your presentation.

- ▶ If you are using Notebook PC:

Some Notebook PCs may deactivate their own computers’ screens when a second display device is in use. Each of them has different way to be reactivated. Refer to your computer’s documentation for detailed information.
- ▶ If you are using an Apple PowerBook:

In Control Panels, open the PowerBook Display to select Video Mirroring “On”.

Problem: Image is unstable or flickering

- ▶ Use “Tracking” to correct it.
- ▶ Change the monitor color setting from your computer.

Problem: Image has vertical flickering bar

- ▶ Use “Frequency” to make an adjustment.
- ▶ Check and reconfigure the display mode of your graphic card to make it compatible with the product.

Problem: Image is out of focus

- ▶ Adjust the Focus Ring on the projector lens.
- ▶ Make sure the projection screen is between the required distance 3.3ft.(1m)~ 33ft.(10m) from the projector.

Problem : The screen is outstretched when displaying 16:9 DVD.

The projector itself will automatically detect 16:9 DVD and adjust the aspect ratio by digitization to full screen with 4:3 default setting.

If the projection display is still outstretched, you will also need to adjust the aspect ratio by referring to the following:

- ▶ Please select 4:3 aspect ratio type on your DVD player if you are playing a 16:9 DVD.
- ▶ If you can not select 4:3 aspect ratio type on your DVD player, please select 4:3 On-Screen-Display(OSD) function of the projector for your display.

Changing the lamp

The projection display will detect the lamp life itself. It will show you a warning message “Lamp is running out of standard lifetime. Be sure to replace the lamp as soon as possible.”. When you see this message, change the lamp as soon as possible.

Make sure the projection display has been cooled for at least 30 minutes before changing the lamp.

⚠ Warning: Lamp compartment is hot! Allow it to cool before changing lamps!

▶ Lamp Changing Procedure:

1. Turn off the power to the projector by pressing the Power/Standby button.
2. Allow the projector to cool down at least 30 minutes.
3. Turn off the main power switch.
4. Disconnect the power cord.
5. Use screwdriver to remove the screw from the cover. ❶
6. Remove the cover. ❷
7. On the left side of the lamp module, push the electrical connector up to disengage it from the projector base. ❸
8. Remove the three screws from the lamp module. ❹
9. Pull out the lamp module. ❺

To replace the lamp module, reverse the previous steps.

⚠ Warning: To reduce the risk of personal injury, do not drop the lamp module or touch the lamp bulb. The bulb may shatter and cause injury if it is dropped.

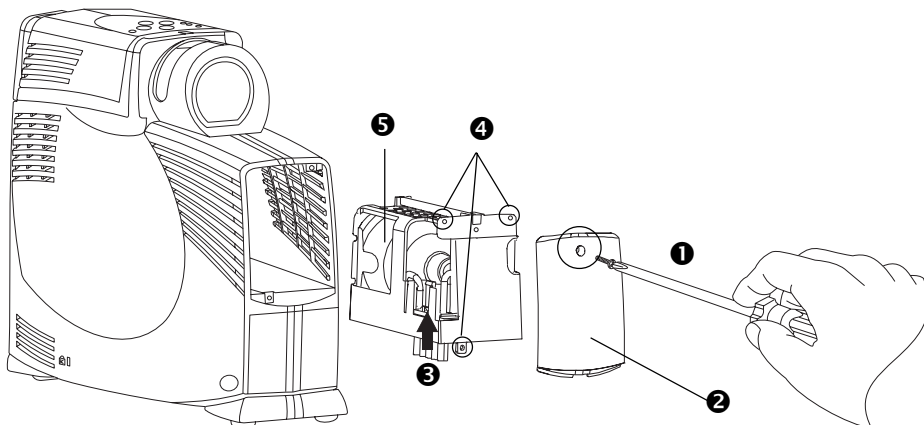

Specifications

Light Valve	- Single Chip DMD Technology
Contrast Ratio	- 400:1 (Full On / Full Off) - 200:1 (ANSI Contrast)
Lamp	- 120W User Replaceable UHP Lamp
Number of Pixels	- 1024 pixels(H) X 768 lines(V)
Displayable Color	- 16.7M colors
Projection Lens	- F2.88 f=30.7mm
Projection Screen Size	- 30"(1m)~ 300"(10m) Diagonal
Computer Compatibility	- IBM & VESA VGA 640 x 350, 70/85Hz 640 x 480, 70/85Hz 720 x 400, 70/85Hz 640 x 480, 60/72/75/85Hz VESA SVGA 800 x 600, 56/60/72/75/85Hz VESA XGA 1024 x 768, 60/70/75/85Hz SXGA 1280 x 1024 compressed 60/75Hz - Apple Macintosh LC 13" 640 x 480, 67Hz Apple Macintosh II 13" 640 x 480, 67Hz Apple Macintosh 16" 832 x 624, 75Hz Apple Macintosh 19" 1024 x 768, 75Hz - NEC PC-98 series 640 x 400, 56Hz 640 x 480, 60/70Hz - Fujitsu FM Towns 640 x 400, 55Hz 640 x 480, 60Hz
Video Compatibility	- NTSC/NTSC 4.43/ PAL/ SECAM compatible - Composite video & S-Video capability
H. Frequency	- 30kHz~90kHz horizontal scan
V. Frequency	- 50Hz~85Hz vertical refresh
Multimedia Audio	- One internal speaker with 3 watt output - Audio Line Output
Power Supply	- AC input 90~264V Auto-Switching Power Supply
Power Consumption	- 190 watts at normal operation
I/O Connectors	- Power: AC Power Input Socket - Computer Input: One 15-pin D-sub Computer Input - Video Input: One Composite Video RCA Input One S-Video Input - Audio Input: One Phone Jack for Audio Input - Audio Output: One Phone Jack for Audio Line out
Weight	- 5 lbs. / 2.3 kgs
Dimensions (W x H x D)	- 3.5 x 8.6 x 9.9 inches / 88 x 213 x 252 mm
Environmental	- Operating Temperature: 10 ^o ~ 40 ^o C/50 ^o ~ 104 ^o F Humidity: 80% maximum - Storage Temperature: -20 ^o ~ -60 ^o C/ -4 ^o ~ -140 ^o F Humidity: 80% maximum
Safety Regulation	- FCC,CE ,VCCI,BSMI,UL,CUL,TUV

Compatibility Modes

Mode	Resolution	H. Frequency (kHz)	V. Frequency (Hz)
IBM & VESA VGA	640 x 350	31.5	70
IBM & VESA VGA	640 x 350	37.9	85
IBM & VESA VGA	640 x 480	31.5	70
IBM & VESA VGA	640 x 480	37.9	85
IBM & VESA VGA	720 x 400	31.5	70
IBM & VESA VGA	720 x 400	37.9	85
IBM & VESA VGA	640 x 480	31.5	60
IBM & VESA VGA	640 x 480	37.9	72
IBM & VESA VGA	640 x 480	37.5	75
IBM & VESA VGA	640 x 480	43.3	85
VESA SVGA	800 x 600	35.2	56
VESA SVGA	800 x 600	37.9	60
VESA SVGA	800 x 600	48.1	72
VESA SVGA	800 x 600	46.9	75
VESA SVGA	800 x 600	53.7	85
VESA XGA	1024 x 768	48.4	60
VESA XGA	1024 x 768	56.5	70
VESA XGA	1024 x 768	60	75
VESA XGA	1024 x 768	68.7	85
VESA XGA	1152 x 864	77	95
VESA XGA	1280 x 960	85	85
VESA SXGA	1280 x 1024	64	60
VESA SXGA	1280 x 1024	80	75
Apple Macintosh LC 13"	640 x 480	34.98	66.66
Apple Macintosh II 13"	640 x 480	35	66.68
Apple Macintosh 16"	832 x 624	49.72	74.55
Apple Macintosh 19"	1024 x 768	60.24	75
NEC PC-98 series	640 x 400	24.83	56.42
NEC PC-98 series	640 x 400	31.5	70
NEC PC-98 series	640 x 480	31.47	59.94
Fujitsu FM-Towns	640 x 480	24.37	55.37
Fujitsu FM-Towns	640 x 480	31.5	60

* SXGA 1280 x 1024 compression computer image.