

ViewSonic®



PLED-W200 LED Projector User Guide

IMPORTANT: Please read this User Guide to obtain important information on installing and using your product in a safe manner, as well as registering your product for future service. Warranty information contained in this User Guide will describe your limited coverage from ViewSonic Corporation, which is also found on our web site at <http://www.viewsonic.com> in English, or in specific languages using the Regional selection box in the upper right corner of our website. "Antes de operar su equipo lea cuidadosamente las instrucciones en este manual"

Model No. VS13903

Compliance Information

FCC Statement

This device complies with part 15 of FCC Rules. Operation is subject to the following two conditions: (1) this device may not cause harmful interference, and (2) this device must accept any interference received, including interference that may cause undesired operation.

This equipment has been tested and found to comply with the limits for a Class B digital device, pursuant to part 15 of the FCC Rules. These limits are designed to provide reasonable protection against harmful interference in a residential installation. This equipment generates, uses, and can radiate radio frequency energy, and if not installed and used in accordance with the instructions, may cause harmful interference to radio communications. However, there is no guarantee that interference will not occur in a particular installation. If this equipment does cause harmful interference to radio or television reception, which can be determined by turning the equipment off and on, the user is encouraged to try to correct the interference by one or more of the following measures:

- Reorient or relocate the receiving antenna.
- Increase the separation between the equipment and receiver.
- Connect the equipment into an outlet on a circuit different from that to which the receiver is connected.
- Consult the dealer or an experienced radio/TV technician for help.

Warning: You are cautioned that changes or modifications not expressly approved by the party responsible for compliance could void your authority to operate the equipment.

For Canada

- This Class B digital apparatus complies with Canadian ICES-003.
- Cet appareil numérique de la classe B est conforme à la norme NMB-003 du Canada.

CE Conformity for European Countries

 The device complies with the EMC Directive 2004/108/EC and Low Voltage Directive 2006/95/EC.

Following information is only for EU-member states:

The mark is in compliance with the Waste Electrical and Electronic Equipment Directive 2002/96/EC (WEEE).



The mark indicates the requirement NOT to dispose the equipment including any spent or discarded batteries or accumulators as unsorted municipal waste, but use the return and collection systems available.



If the batteries, accumulators and button cells included with this equipment, display the chemical symbol Hg, Cd, or Pb, then it means that the battery has a heavy metal content of more than 0.0005% Mercury or more than, 0.002% Cadmium, or more than 0.004% Lead.



Important Safety Instructions

1. Read these instructions.
2. Keep these instructions.
3. Heed all warnings.
4. Follow all instructions.
5. Do not use this unit near water.
6. Clean with a soft, dry cloth.
7. Do not block any ventilation openings. Install the unit in accordance with the manufacturer's instructions.
8. Do not install near any heat sources such as radiators, heat registers, stoves, or other devices (including amplifiers) that produce heat.
9. Do not defeat the safety purpose of the polarized or grounding-type plug. A polarized plug has two blades with one wider than the other. A grounding type plug has two blades and a third grounding prong. The wide blade and the third prong are provided for your safety. If the provided plug does not fit into your outlet, consult an electrician for replacement of the obsolete outlet.
10. Protect the power cord from being walked on or pinched particularly at plugs. Convenience receptacles and the point where they exit from the unit. Be sure that the power outlet is located near the unit so that it is easily accessible.
11. Only use attachments/accessories specified by the manufacturer.
12. Use only with the cart, stand, tripod, bracket, or table specified by the manufacturer, or sold with the unit. When a cart is used, use caution when moving the cart/unit combination to avoid injury from tipping over. 
13. Unplug this unit when unused for long periods of time.
14. Refer all servicing to qualified service personnel. Servicing is required when the unit has been damaged in any way, such as: if the power-supply cord or plug is damaged, if liquid is spilled onto or objects fall into the unit, if the unit is exposed to rain or moisture, or if the unit does not operate normally or has been dropped.

Declaration of RoHS Compliance

This product has been designed and manufactured in compliance with Directive 2002/95/EC of the European Parliament and the Council on restriction of the use of certain hazardous substances in electrical and electronic equipment (RoHS Directive) and is deemed to comply with the maximum concentration values issued by the European Technical Adaptation Committee (TAC) as shown below:

Substance	Proposed Maximum Concentration	Actual Concentration
Lead (Pb)	0.1%	< 0.1%
Cadmium (Cd)	0.01%	< 0.01%
Hexavalent Chromium (Cr ⁶⁺)	0.1%	< 0.1%
Polybrominated biphenyls (PBB)	0.1%	< 0.1%
Polybrominated diphenyl ethers (PBDE)	0.1%	< 0.1%

Certain components of products as stated above are exempted under the Annex of the RoHS Directives as noted below:

Examples of exempted components are:

1. Lead in glass of cathode ray tubes, electronic components, fluorescent tubes, and electronic ceramic parts (e.g. piezoelectronic devices).
2. Lead in high temperature type solders (i.e. lead-based alloys containing 85% by weight or more lead).
3. Lead as an alloying element in steel containing up to 0.35% lead by weight, aluminium containing up to 0.4% lead by weight and as a copper alloy containing up to 4% lead by weight.

Copyright Information

Copyright © ViewSonic® Corporation, 2011. All rights reserved.

Macintosh and Power Macintosh are registered trademarks of Apple Inc.

Microsoft, Windows, Windows NT, and the Windows logo are registered trademarks of Microsoft Corporation in the United States and other countries.

ViewSonic, the three birds logo, OnView, ViewMatch, and ViewMeter are registered trademarks of ViewSonic Corporation.

VESA is a registered trademark of the Video Electronics Standards Association. DPMS and DDC are trademarks of VESA.

PS/2, VGA and XGA are registered trademarks of International Business Machines Corporation.

Disclaimer: ViewSonic Corporation shall not be liable for technical or editorial errors or omissions contained herein; nor for incidental or consequential damages resulting from furnishing this material, or the performance or use of this product.

In the interest of continuing product improvement, ViewSonic Corporation reserves the right to change product specifications without notice. Information in this document may change without notice.

No part of this document may be copied, reproduced, or transmitted by any means, for any purpose without prior written permission from ViewSonic Corporation.

Product Registration

To meet your future needs, and to receive any additional product information as it becomes available, please register your product on the Internet at: www.viewsonic.com. The ViewSonic® Wizard CD-ROM also provides an opportunity for you to print the registration form, which you may mail or fax to ViewSonic.

For Your Records	
Product Name:	PLED-W200 ViewSonic LED Projector
Model Number:	VS13903
Document Number:	PLED-W200_UG_ENG Rev. 1A 09-21-11
Serial Number:	_____
Purchase Date:	_____

Product disposal at end of product life

The lamp in this product contains mercury which can be dangerous to you and the environment. Please use care and dispose of in accordance with local, state or federal laws.

ViewSonic respects the environment and is committed to working and living green. Thank you for being part of Smarter, Greener Computing. Please visit ViewSonic website to learn more.

USA & Canada: <http://www.viewsonic.com/company/green/recycle-program/>

Europe: <http://www.viewsoniceurope.com/uk/kbase/article.php?id=639>

Taiwan: <http://recycle.epa.gov.tw/recycle/index2.aspx>

Table of contents

Introduction	5
Projector features	5
Package contents	6
Projector overview	7
Using the product	8
Control panel	8
Connection ports	10
Remote control	11
Replacing the battery	13
Remote control operation	14
Connection	15
Connecting a computer	16
Connecting a component video source device	18
Connecting a composite video source device	19
Operation	20
Powering on/off the projector	20
Adjusting the projector height	21
Adjusting the projector focus	21
Adjusting projection image size	22
Menu operation	23
Displaying files with SD card	30
Maintenance	43
Cleaning the lens	43
Cleaning the projector housing	43
Specifications	44
Dimensions	45
Appendix	46
LED Indicator Messages	46
Compatibility modes	47
Troubleshooting	48
IR control code	49

Introduction

Projector features

The projector integrates high-performance optical engine projection and a user - friendly design to deliver high reliability and ease of use.

The projector offers the following features:

- Advanced LED light source provides a longer life span than traditional lamps.
- Single chip 0.45" Texas Instruments DLP® technology
- WXGA (1280 x 800 pixels)
- The projector is small and light, making it useful for business trips and leisure activities.
You can listen music, view documents, videos and photos anywhere.
- Multiple input ports, including PC, AV, USB, and SD card provide flexible connectivity with peripheral devices.
- Equipped with 2W x 2 speakers with headphone jack input port
- User-friendly, multi-language on-screen display

Note

- *The information in this manual is subject to change without notices.*
- *The reproduction, transfer or copy of all or any part of this document is not permitted without express written consent.*

Package contents

When you unpack the projector, make sure you have all these components:

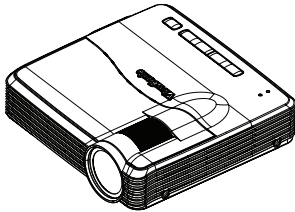

Projector

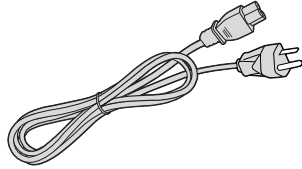

AC power cord

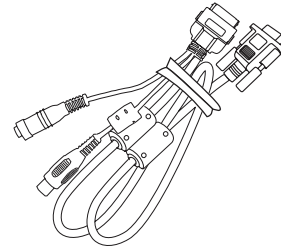

Multi-input cable

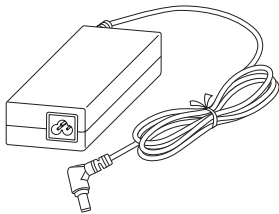

AC adapter



Remote control with battery

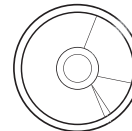

ViewSonic CD wizard



Quick start guide



Projector carrying bag

Note

- **Contact your dealer immediately if any items are missing, appear damaged, or if the unit does not work.**
- **For maximum protection of the product, please save the original shipping carton and packing materials and repack your product as it was originally packed at the factory if you need to ship it.**

Projector overview

Front view

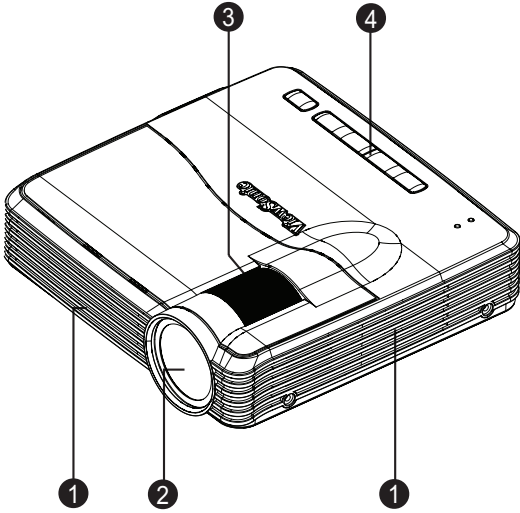

- 1. Ventilation holes
- 2. Projection lens
- 3. Focus ring
- 4. Control panel

Rear/bottom view

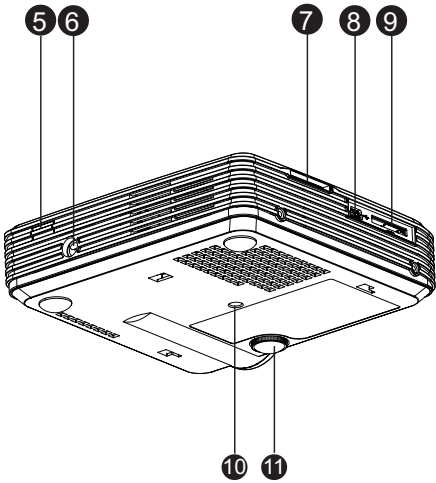

- 5. Rear IR remote control sensor
- 6. AC adapter inlet
- 7. SD card slot
- 8. Mini-B USB jack
- 9. Multi-input socket
- 10. Tripod socket
- 11. Elevator foot

Using the product

Control panel

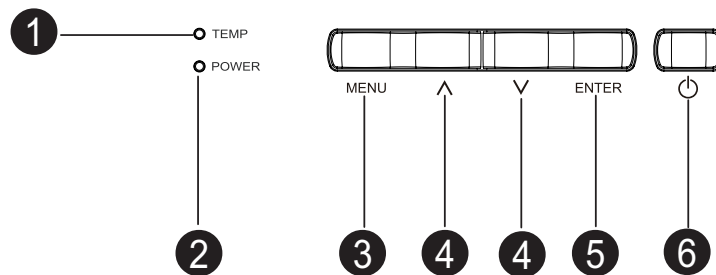

1. **TEMP** (Temperature LED indicator)
Refer to “LED Indicator Messages”.
2. **POWER** (Power LED indicator)
Refer to “LED Indicator Messages”.
3. **MENU**
 - When the projector is not in SD Card mode:
Display or exit the on-screen display menus.
 - When the projector is in music/video file browser mode:
Change to options or file browser window.
 - When the projector is in photo file browser/photo file list mode:
Change column, row and options.
 - When the projector is in video full screen:
Turn on/off control bar.
 - When the projector is in photo full screen:
Show control bar 5 seconds.
4. **Up/Down keys**
 - When the On-Screen Display (OSD) menu is on:
Select the main menu and desired menu items.
 - When the projector is in SD Card main menu page:
Navigate left/right to select items.
 - When the projector is in music/video file browser mode:
Navigate up/down to select items in file browser window.
Navigate left/right to select items in options mode.
 - When the projector is in music playback mode:
Select previous/next options.
 - When the projector is in video full screen:
Fast forward/rewind the video at the intervals of 2X, 4X, 8X, 16X, 32X.

- When the projector is in photo file browser/photo file list mode:
Navigate in the chosen column, row and options.
- When the projector is in photo full screen:
Select previous/next file.

5. **ENTER**

- When the OSD menu is on:
Confirm your selection of items.
Selects a menu option.
- When the projector is in SD Card main menu page:
Enter to file browser mode.
- When the projector is in music/video/photo file browser/music playback/photo file list mode:
Start to work for the selected item.
- When the projector is in video full screen:
Play or pause a video.
- When the projector is in photo full screen:
Start/stop slideshow.

6. **⏻ Power**

Turn the projector on or off.

Connection ports

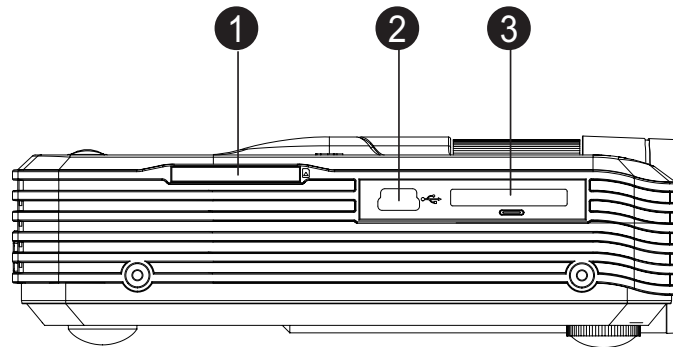

- 1. SD card slot**
Supports photo, music, video and Office viewer.
- 2. Mini-B USB jack**
Supports USB display.
- 3. Multi-input socket**
Supports RGB (PC)/component video (YPbPr/ YCbCr) /composite video/audio input.

Remote control

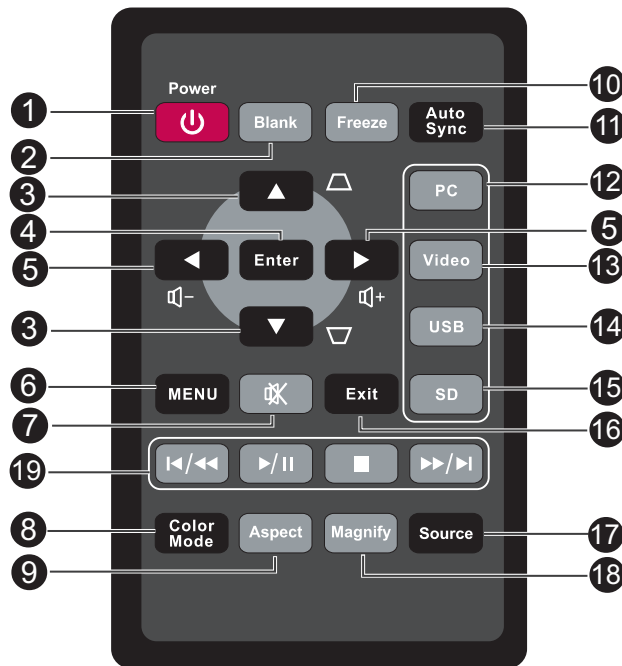

1. **Power**
Turn the projector on or off.
2. **Blank**
Hide the screen picture.
3. **Keystone (Up/Down) keys**
Manually correct distorted images resulting from an angled projection.
4. **Enter**
Confirmed selections.
5. **Volume (Left/Right) keys**
When the On-Screen Display (OSD) menu is activated, the #3, and #5 keys are used as directional arrows to select the desired menu items and to make adjustments.
Adjust the volume level.
6. **MENU**
Display on-screen display menus.
7. **Mute**
Cut off the sound temporarily.
8. **Color Mode**
Select the picture setup mode.
9. **Aspect**
Select the display aspect ratio.
10. **Freeze**
Freeze the projected image.

11. Auto Sync

Automatically determines the best picture timings for the displayed image.

12. PC

Display computer/component signal.

13. Video

Display composite video signal.

14. USB

Display USB display signal.

15. SD

Display SD card signal.

16. Exit

Goes back to previous OSD menu.

17. Source

Display the source selection bar.

18. Magnify

Magnifies or reduces the projected picture size.

19. Playback keys (SD card source only)

- Previous/rewind key
- Play/pause key
- Stop key
- Next/fast-forward key

Note

- *The keys for remote control operation on SD Card source are framed in red color. See ["Displaying files with SD card"](#) on page 30 for details.*



Replacing the battery

For the first time use:

Remove the transparent insulation tape by pulling it before use.

For battery change:

1. Push the catch to the left and remove the battery holder.

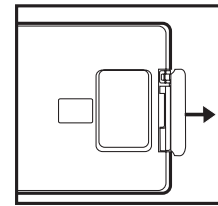

2. Remove the old Lithium coin cell and install new one (CR2025). Ensure that the side with the mark “+” is up.

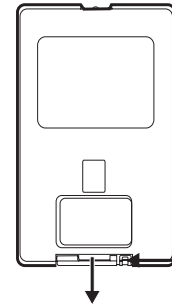

3. Push the battery holder back into the remote control until you feel a click.

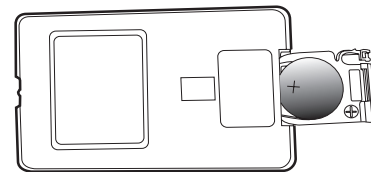
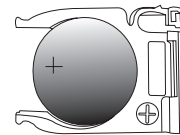

Caution

- *Risk of explosion if battery is replaced by an incorrect type.*
- *Dispose of used batteries according to the instructions.*
- *Make sure the plus and minus terminals are correctly aligned when loading a battery.*

Note

- *Keep the battery out of the reach of children.*
- *Do not recharge the battery or expose the battery to fire or water.*
- *Do not dispose the used battery along with household waste. Dispose used batteries according to local regulations.*
- *Danger of explosion may happen if batteries are incorrectly replaced. Replace only with the same type recommended by the manufacturer.*
- *Battery should not be in or near to fire or water, keep batteries in a dark, cool and dry place.*
- *If suspect battery leakage, wipe out the leakage and then replace a new battery. If the leakage adheres to your body or clothes, rinse well with water immediately.*

Remote control operation

Point the remote control at the infrared remote sensor and press a button.

- Operating the projector from the rear

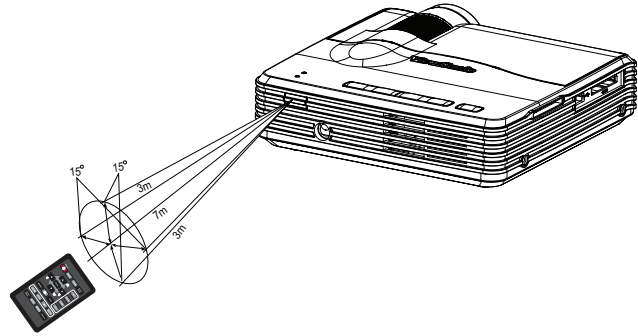

Note

- *The remote control may not operate when there is sunlight or other strong light such as a fluorescent lamp shining on the remote sensor.*
- *Operate the remote control from a position where the remote sensor is visible.*
- *Do not drop the remote control or jolt it.*
- *Keep the remote control out of locations with excessively high temperature or humidity.*

Connection

Using the AC adapter

The projector must be used with the provided AC adapter. Damage caused by the use of an incorrect adapter is not covered under the warranty.

1. Insert the plug from the AC adapter into the DC IN terminal.
2. Insert the appropriate end of the power cord into the AC adapter.
3. Insert the plug on the power cord into a wall outlet.

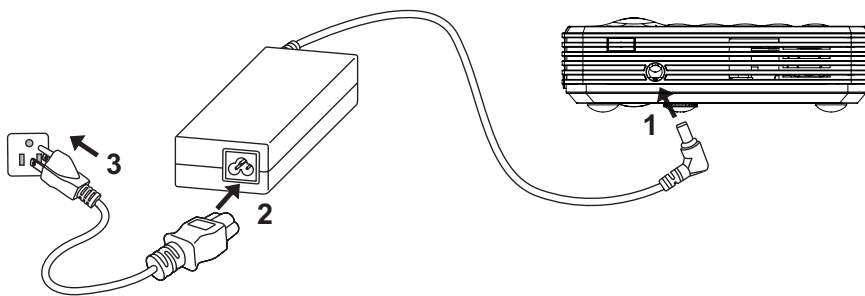

Important

- *In the connections shown above, some cables may not be included with the projector (see "[Package contents](#)" on page 6). They are commercially available from electronics stores.*
- *For detailed connection methods, see pages [16-19](#).*

Connecting a computer

The projector provides a VGA input socket that allows you to connect it to both IBM® compatibles and Macintosh® computers. A Mac adapter is needed if you are connecting legacy version Macintosh computers.

To connect the projector to a notebook or desktop computer:

- Using a VGA cable
1. Take the supplied multi-input cable and connect one end to the D-Sub output socket of the computer.
 2. Connect the other end of the multi-input cable to the multi-input socket on the projector.
 3. If you wish to make use of the projector speaker, take a suitable audio cable and connect one end of the cable to the audio output socket of the computer, and the other end to the audio input socket of the multi-input cable.

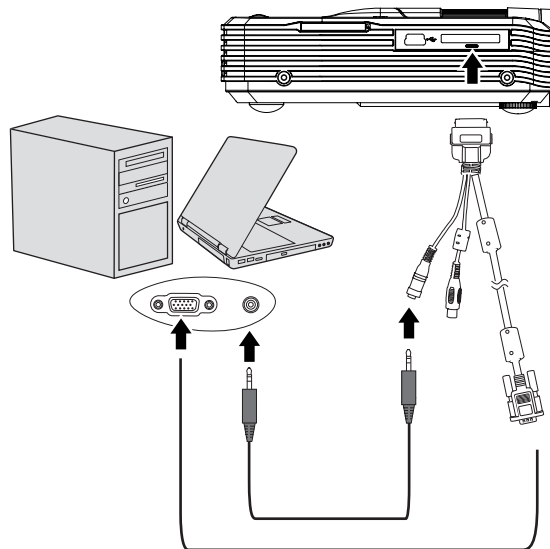

Important

- **Many notebooks do not turn on their external video ports when connected to a projector. Usually a key combo like FN + F3 or CRT/LCD key turns the external display on/off. Locate a function key labeled CRT/LCD or a function key with a monitor symbol on the notebook. Press FN and the labeled function key simultaneously. Refer to your notebook's documentation to find your notebook's key combination.**

- Using a USB cable

1. Take a USB cable and connect the type A end to the USB output jack of the computer.
2. Connect the mini-B type end of the USB cable to the mini-B USB jack on the projector. When you connect the projector to a computer, you can display computer's image on the screen.
3. If computer's screen can't be projected, please go to "My Computer", find the "USB Display" (same as using a flash disk drive), then double click it to install the USB driver.

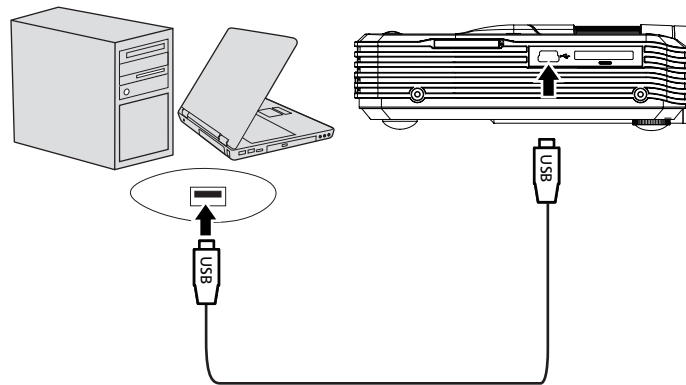

Connecting a component video source device

Examine your Video source device to determine if it has a set of unused Component Video output sockets available:

- If so, you can continue with this procedure.
- If not, you will need to reassess which method you can use to connect to the device.

To connect the projector to a Component Video source device:

1. Take a Component Video to VGA (D-Sub) adaptor cable and connect the end with 3 RCA type connectors to the Component Video output sockets of the Video source device. Match the color of the plugs to the color of the sockets; green to green, blue to blue, and red to red.
2. Connect the other end of the Component Video to VGA (D-Sub) adaptor cable (with a D-Sub type connector) to the D-Sub jack of the multi-input cable.
3. Connect the other end of the multi-input cable to the multi-input socket on the projector.
4. If you wish to make use of the projector speaker, take a suitable audio cable and connect one end of the cable to the audio output sockets of the Video source device, and the other end to the audio input socket of the multi-input cable.

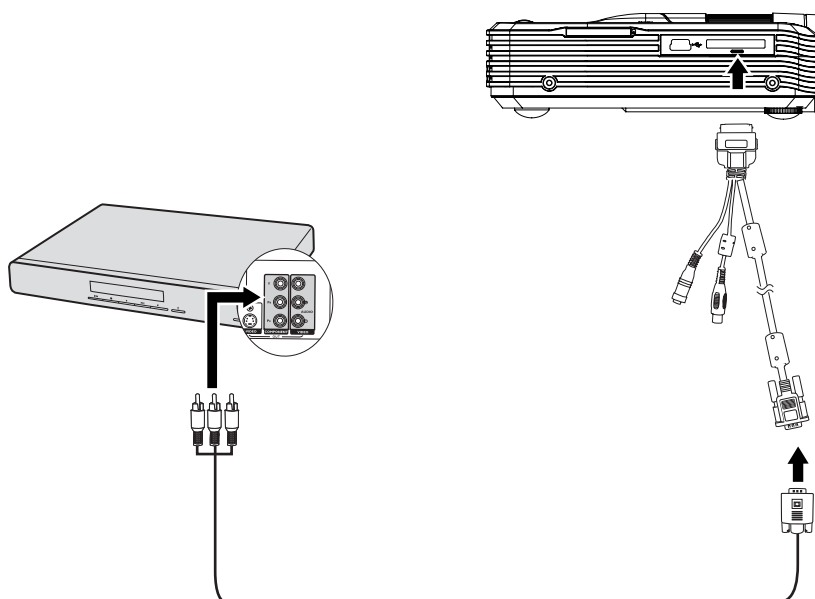

Connecting a composite video source device

Examine your Video source device to determine if it has a set of unused composite Video output sockets available:

- If so, you can continue with this procedure.
- If not, you will need to reassess which method you can use to connect to the device.

To connect the projector to a composite Video source device:

1. Take a Video cable and connect one end to the composite Video output socket of the Video source device.
2. Connect the other end of the Video cable to the Video jack of the multi-input cable.
3. Connect the other end of the multi-input cable to the multi-input socket on the projector.
4. If you wish to make use of the projector speaker, take a suitable audio cable and connect one end of the cable to the audio output sockets of the Video source device, and the other end to the audio input socket of the multi-input cable.

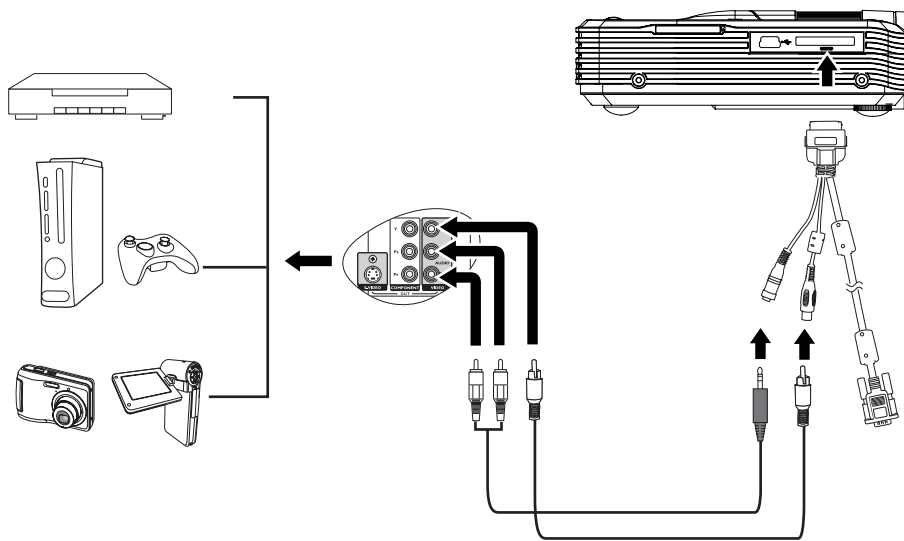

Operation

Powering on/off the projector

Powering on the projector:



1. Connect the power using the AC adapter and peripheral signal cable(s) connections.
2. Press  to turn on the projector.
The projector takes several seconds or so to warm up.
3. Turn on your source (computer, notebook, DVD, etc.). The projector automatically detects your source.
 - If you are connecting multiple sources to the projector simultaneously, press **MENU** on the projector or **Source** on the remote control to select your desired signal or press your desired signal key on the remote control.



Warning

- *Never look into the lens when the LED light is on. This can damage your eyes.*
- *This focal point concentrates high temperature. Do not place any object near it to avoid possible fire hazard.*

Powering off the projector:

1. Press  to turn off the projector. You will see a message "Power off? Press Power again" appear on the screen.
2. Press  again to confirm.
3. Disconnect the power cord from the wall socket if the projector will not be used in an extended period of time.

Adjusting the projector height

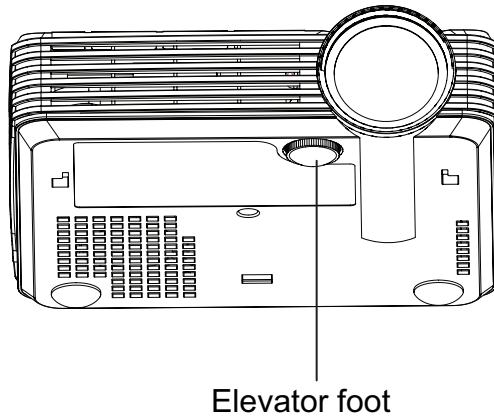

The projector is equipped with an elevator foot to adjust the image height. To raise or lower the image, turn the elevator foot to fine-tune the height.

Note

- *To avoid damaging the projector, make sure that the elevator foot is fully retracted before placing the projector in its carrying case.*

Adjusting the projector focus

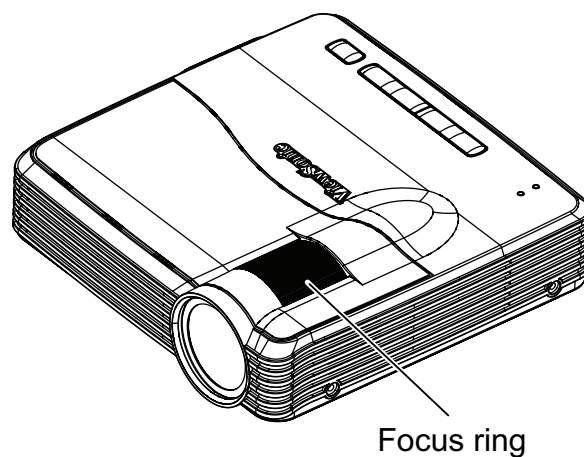

Focus the image by rotating the focus ring. A still image is recommended for focusing.

Adjusting projection image size

Refer to the graphic and table below to determine the screen size and projection distance.

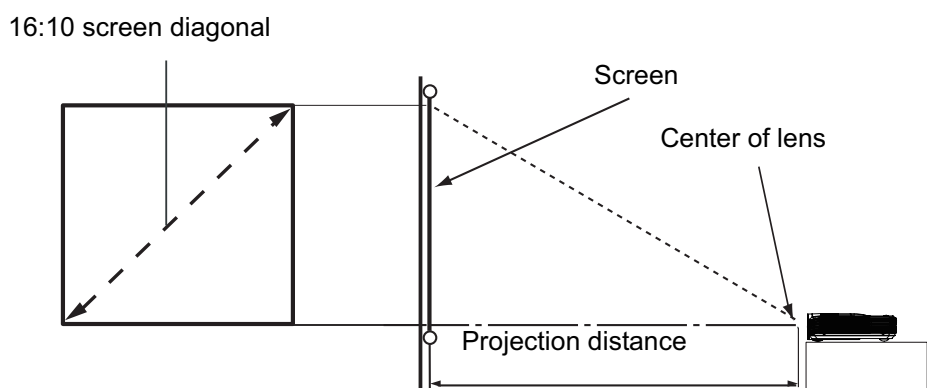

16:10 screen diagonal		Recommended projection distance from screen in mm
Inches*	mm**	
		Average
24	610	621
40	1016	1034
56	1422	1448
72	1829	1862
80	2032	2069

* Screen Diagonal (inch) = $40/1034 * \text{Projection Distance (mm)}$

Ex: $24 = 40/1034 * 621$

** Screen Diagonal (mm) = $40 * 25.4 / 1034 * \text{Projection Distance (mm)}$

Ex: $610 = 40 * 25.4 / 1034 * 621$

There is +/-10% tolerance among these numbers due to optical component variations.

Note

- **Position the projector in a horizontal position; other positions can cause heat build-up and damage to the projector.**
- **Keep a space of 30 cm or more between the sides of the projector.**
- **Do not use the projector in a smoky environment. Smoke residue may build-up on critical parts and damage the projector or its performance.**

Menu operation

The projector has multilingual on-screen display menus that allow you to make image adjustments and change a variety of settings.

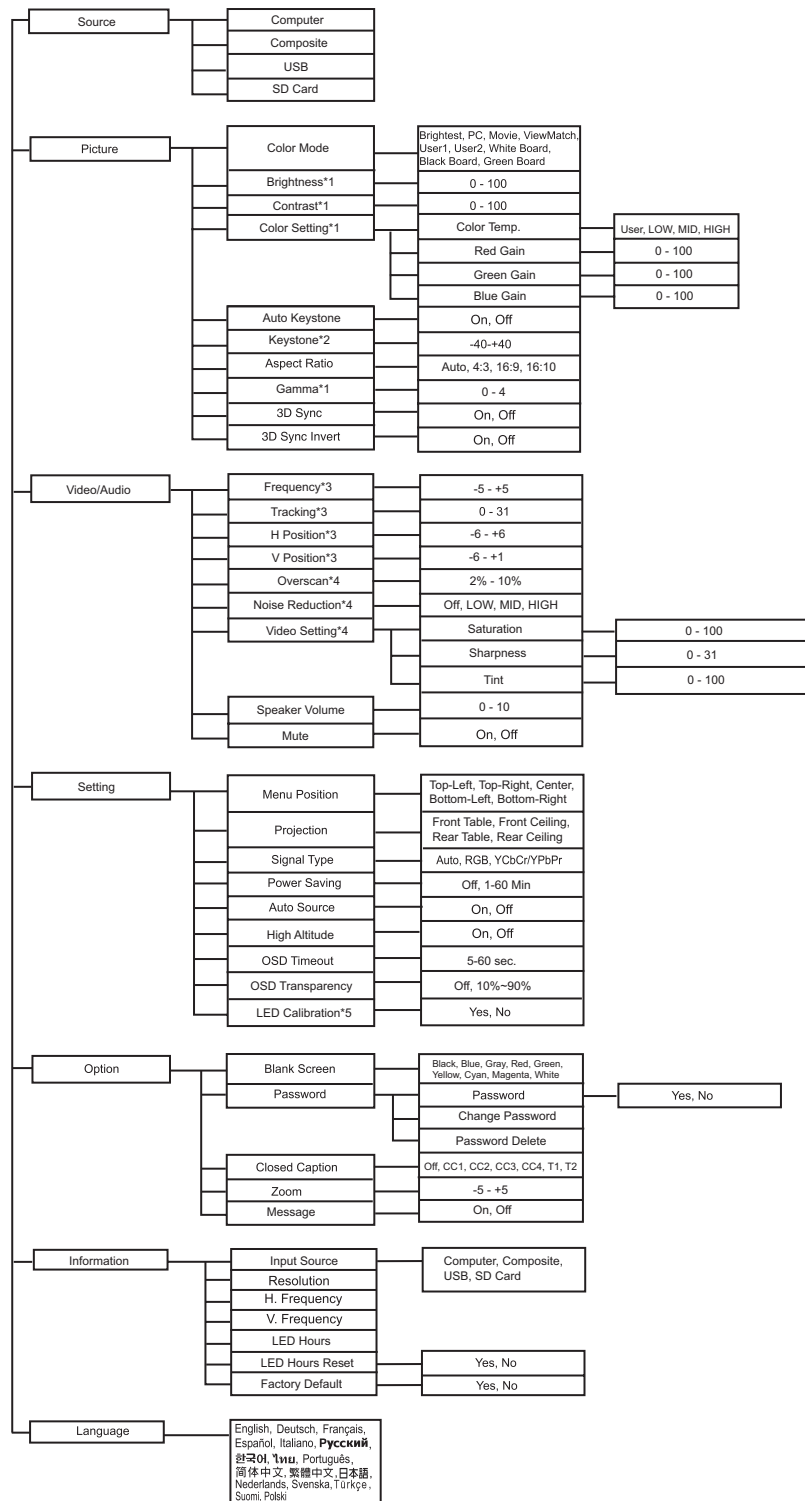

*1 It is only available when Color Mode is set to User1 or User 2.

*2 It is only available when Auto Keystone is set to Off.

*3 It is only available under computer mode.

*4 It is only available under video mode.

*5 It is only available when no source is connected.

How to operate

- Using the keypad:

1. Press **MENU** to open the OSD menu.
2. When OSD is displayed, use ▲/▼ to select any feature in the main menu.
3. After selecting the desired main menu item, press **ENTER** to enter sub-menu for feature setting.
4. Use ▲/▼ to select the desired item and press **ENTER** to confirm.
5. Adjust the settings with ▲/▼, and then press **ENTER**.
6. If you want to select the menu option, press **ENTER** until the desired item is displayed.
7. Press **MENU** to return to the main menu.
8. To exit OSD, press **MENU** again. The OSD menu will close and the projector will automatically save the new settings.

- Using the remote control:

1. Press **MENU** to open the OSD menu.
2. When OSD is displayed, use ◀/▶ to select any feature in the main menu.
3. After selecting the desired main menu item, press ▼ to enter sub-menu for feature setting.
4. Use ▲/▼ to select the desired item, adjust the settings or select the menu option with ◀/▶.
5. Press **MENU** to return to the main menu.
6. To exit OSD, press **MENU** again. The OSD menu will close and the projector will automatically save the new settings.

Source

There are four types of sources for selection.

- Computer: Display computer/component signal.
- Composite: Display composite video signal.
- USB: Display USB signal.
- SD Card: Display SD card signal.

Picture

Color Mode

There are many factory presets optimized for various types of images.

- Brightest: For the brightest environment.
- PC: For computer or notebook.
- Movie: For home theater.
- ViewMatch: For accuracy color performance.
- User 1: Memorize user 1 defined settings.
- User 2: Memorize user 2 defined settings.
- White Board: For white projection screen type.
- Black Board: For black projection screen type.
- Green Board: For green projection screen type.

Brightness

Brighten or darken the image.

Contrast

Set the difference between light and dark areas.

Color Setting

Adjust the color temperature. At higher temperature the screen looks colder; at lower temperature, the screen looks warmer. If you select "User", then you can change the intensity of each of 3 color (Red, Green, Blue) to customize user color temperature.

Auto Keystone

Automatically correct distorted images resulting from an angled projection.

Keystone

Manually correct distorted images resulting from an angled projection.

Aspect Ratio

Select how the picture fits on the screen:

- Auto : Scales an image proportionally to fit the projector's native resolution in its horizontal or vertical width.
- 4:3 : Scales an image so that it is displayed in the center of the screen with a 4:3 aspect ratio.
- 16:9 : Scales an image so that it is displayed in the center of the screen with a 16:9 aspect ratio.
- 16:10: Scale an image so that it is displayed in the center of the screen with a 16:10 aspect ratio.

Gamma

Effect the represent of dark scenery. With greater gamma value, dark scenery will look brighter.

3D Sync (for TI 3D DLP-LINK only)

- On: Enable 3D function.
- Off: Disable 3D function.

3D Sync Invert

- On: Invert left and right frame contents.
- Off: Default frame contents.

When the 3D Sync function is on:

- The brightness level of the projected image will decrease.
- The Color Mode cannot be adjusted.
- The Keystone can only be adjusted within limited degrees.
- The Zoom can only magnify the pictures to limited sizes.

Video/Audio

Frequency

Adjust the timing of the projector relative to the computer.

Tracking

Adjust the phase of the projector relative to the computer.

H Position (Horizontal Position)

Adjust the image left or right within the projection area.

V Position (Vertical Position)

Adjust the image up or down within the projection area.

Overscan

Remove noise around the image.

Noise Reduction

Reduce temporal and/or spatial noise in the image.

Video Setting

Allow you to enter the Video Setting menu.

- Saturation: Adjust a video image from black and white to fully saturated color.
- Sharpness: Sharpen or soften the image.
- Tint: Shift colors toward red or green.

Speaker Volume

Adjust the projector's volume level.

Mute

Cut off the sound temporarily.

Setting

Menu Position

Choose the menu location on the display screen.

Projection

Adjust the picture to match the orientation of the projector: upright or upside-down, in front of or behind the screen. Invert or reverse the image accordingly.

Signal Type

Specify the source to the multi-input terminal that you wish to project.

- Auto : Automatically detect the input signal type from the input terminal.
- RGB : For VGA signal
- YCbCr/YPbPr: For component signal

Power Saving

If the input source is not detected and no operation is performed for a specific period of time, projector will automatically turn off.

Auto Source

Automatically scan through all the input sources.

High Altitude

Use this function to allow the fans operates at full speed continuously to achieve proper high altitude cooling of the projector.

OSD Timeout

Duration of OSD menu display countly starts (at idle state by second).

OSD Transparency

Select to change the transparency level of the OSD background.

LED Calibration

Press **ENTER** after choosing “Yes”, please wait for 10 seconds to finish the white color fine tune process. (This function can be used after 30 minutes turning on.) It helps to adjust LED color performance.

Option

Blank Screen

Blank the screen temporarily, and select the screen color when this function is active.

Password

Set, change or delete the password. When the password function is added, image projection will require to input the preset password when turning on the projector.

Closed Caption

Enable or disable closed captions by selecting CC1 (closed caption1, the most common channel), CC2, CC3, CC4, T1, T2 or OFF.

Zoom

Zoom in and out the images.

Message

Enable or disable the message box at the right bottom of the screen.

Information

Input Source

Display the current input source.

Resolution

Display current input source resolution.

H. Frequency

Display current image horizontal frequency.

V. Frequency

Display current image vertical frequency.

LED Hours

Display the LED's elapsed operating time (in hours).

LED Hours Reset

Reset the LED Hour to 0 hours.

Factory Default

Restore settings to factory default.

The following settings will still remain: Auto Keystone, Keystone, Aspect Ratio, Projection, High Altitude, Language, LED Hours.

Language

Select the language used by the on-screen menu.

Displaying files with SD card

The projector can display files saved in the SD card (up to SDHC 32G) when you have connected to projector.

- Photo supports minimum resolution 64 x 64; maximum resolution over 4000 x 4000.
- Music and Video support maximum 2GB file size.
- Office Viewer supports Word/Excel/PPT/PDF playback

To display files:

1. Turn on the power of the projector.
2. Insert an SD card to the SD card slot on the projector.

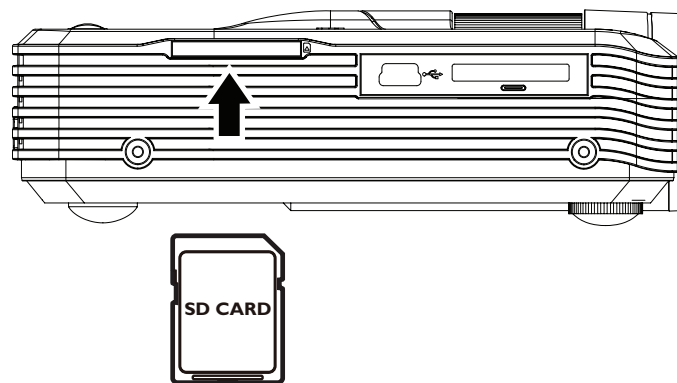

3. Select SD card source.
4. Storages are classified into Music, Movie, Photo and Office Viewer items in the main menu page. Press ▲/▼ on the keypad or ◀/▶ on the remote control to select desired item and then press **ENTER** on the keypad or **Enter** on the remote control to enter different file browser.

Main menu page



- Keypad operation

Button	Operation
▲	Navigate left to select items.
▼	Navigate right to select items.
ENTER	Enter to file browser mode.

- Remote control operation

Button	Operation
Source	Change sources. (see Note)
Enter	Enter to file browser mode.
◀	Navigate left to select items.
▶	Navigate right to select items.

Note

- *When the projector is under the main menu page of SD Card, you can switch to USB source just once.*

Music file browser window

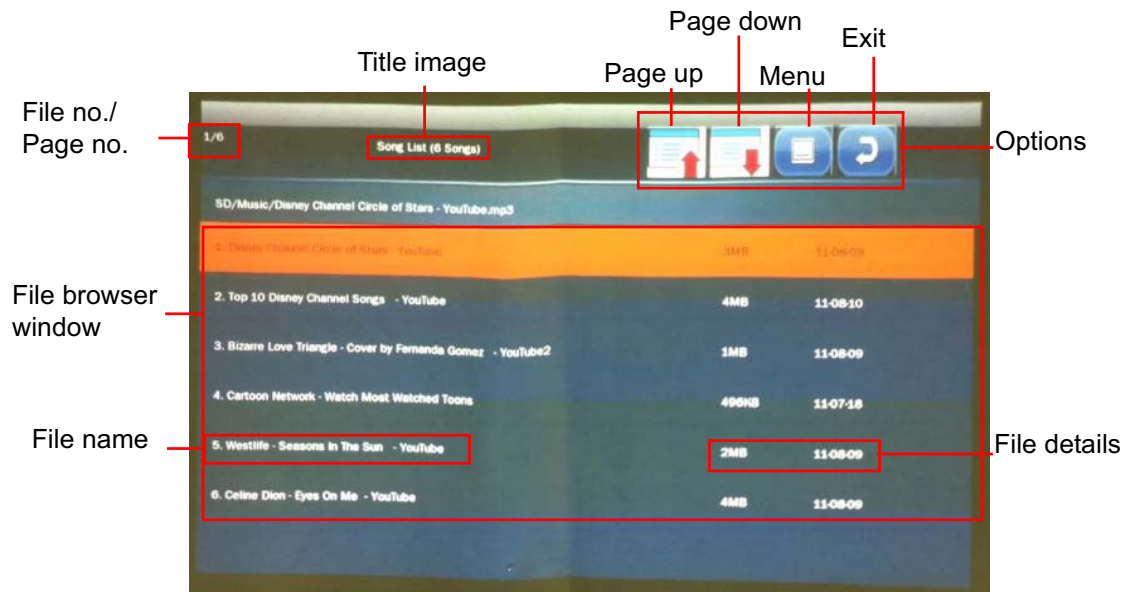

Note

- *You will only see relevant and supported files in each of file browser.*
- Keypad operation

Button	Operation
MENU	Change to options or file browser window.
▲	<ul style="list-style-type: none"> • Navigate to select items in the options. • Navigate upward to select items in file browser window.
▼	<ul style="list-style-type: none"> • Navigate to select items in the options. • Navigate downward to select items.
ENTER	Start to work for the selected item.

- Remote control operation

Button	Operation
Source	Change sources except USB.
Enter	Play music.
Exit	Go back to the upper level of OSD.
▲	Navigate upward to select items.
▼	Navigate downward to select items.
⏪/⏩	Page up
⏮/⏭	Page down

Play music



- Keypad operation

Button	Operation
▲	Select previous item in control bar.
▼	Select next item in control bar.
ENTER	Start to work for the selected item.

- Remote control operation

Button	Operation
Source	Change sources except USB.
Enter	Start to work for the selected control bar item.
Exit	Go back to music file browser mode.
▲	Navigate left to select items in control bar.
▼	Navigate right to select items in control bar.
◀	Audio volume down.
▶	Audio volume up.
▶/	Play or pause music.
■	Stop music playback.
◀/◀◀	Play previous music.
▶▶/▶	Play next music.
🔇	Mute or unmute the sound.

- Play type

🔁	Normal play
🔀	Shuffle play
🔁	One track repeat play
🔁	All tracks repeat play

Video file browser mode

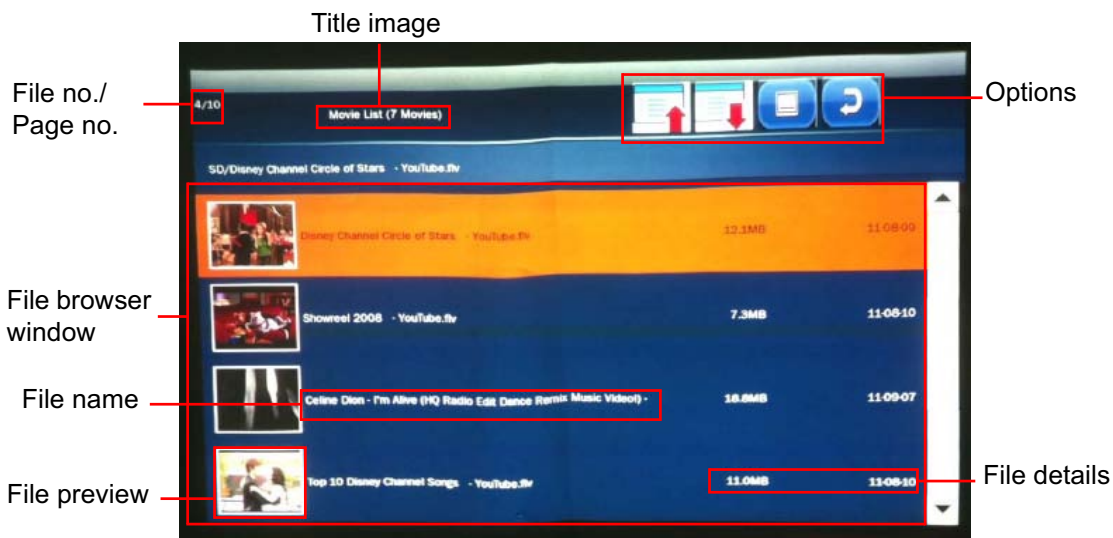

- Keypad operation

Button	Operation
MENU	Change to options or file browser window.
▲	<ul style="list-style-type: none"> Navigate to select items in the options. Navigate upward to select items in file browser window.
▼	<ul style="list-style-type: none"> Navigate to select items in the options. Navigate downward to select items in file browser window.
ENTER	Start to work for the selected item.

- Remote control operation

Button	Operation
Source	Change sources except USB.
Enter	Play a video.
Exit	Go back to the upper level of OSD.
▲	Navigate upward to select items in file browser window.
▼	Navigate downward to select items in file browser window.
⏪/⏩	Page up
⏮/⏭	Page down

Video full screen

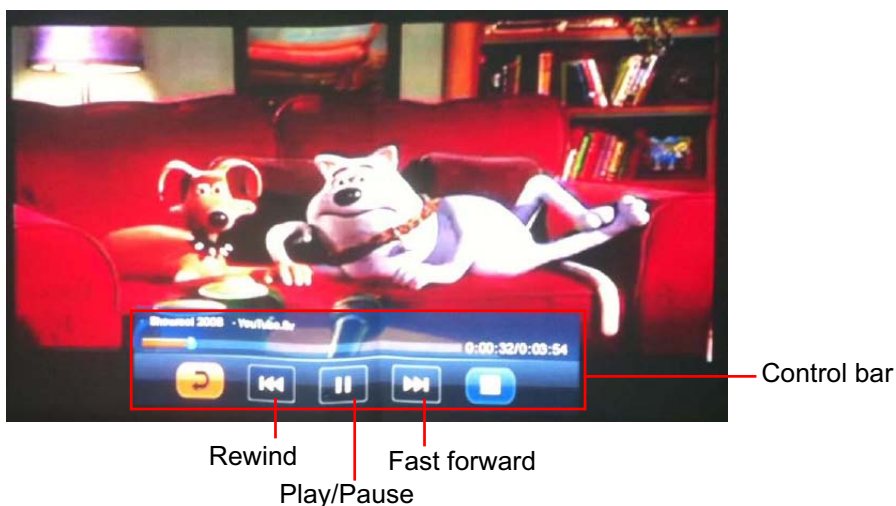

- Keypad operation

Button	Operation
MENU	Turn on/off control bar.
▲	<ul style="list-style-type: none"> • Rewind the video at the intervals of 2X, 4X, 8X, 16X, 32X. • Navigate to select items when control bar is on.
▼	<ul style="list-style-type: none"> • Fast forward the video at the intervals of 2X, 4X, 8X, 16X, 32X. • Navigate to select items when control bar is on.
ENTER	<ul style="list-style-type: none"> • Play or pause a video. • Start to work for the selected item when control bar is on.

- Remote control operation

Button	Operation
Source	Change sources except USB.
MENU	Display on-screen display menus.
Enter	Start to work for the selected item when control bar is on.
Exit	Go back to video file browser mode or file list mode.
▲	Navigate left to select items when control bar is on.
▼	<ul style="list-style-type: none"> • Turn on/off control bar. • Navigate right to select items when control bar is on.
◀	Audio volume down.
▶	Audio volume up.
▶/	Play or pause a video.
■	Stop video playback.
◀/◀◀	Rewind the video at the intervals of 2X, 4X, 8X, 16X, 32X.

▶▶/▶	Fast forward the video at the intervals of 2X, 4X, 8X, 16X, 32X.
🔇	Mute or unmute the sound.

Photo file browser mode

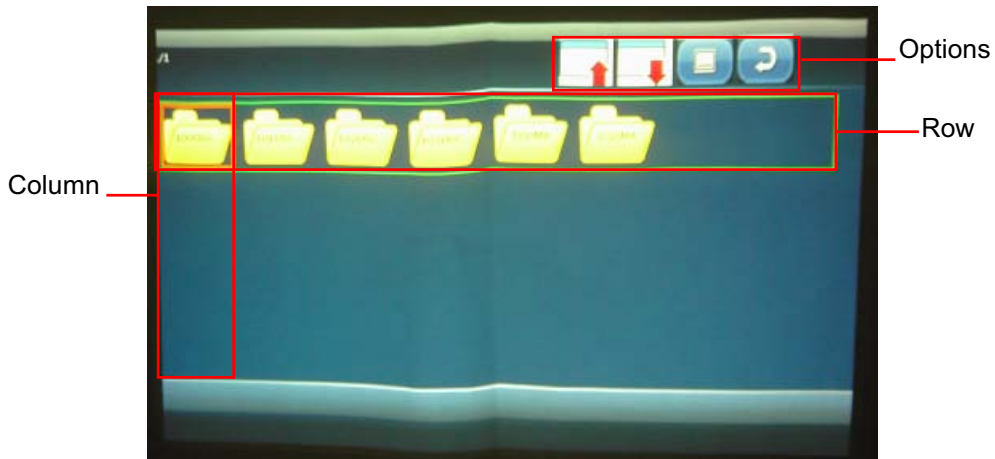

- Keypad operation

Button	Operation
MENU	Change to column, row or options.
▲	Navigate in the selected column, row and options.
▼	Navigate in the selected column, row and options.
ENTER	Start to work for the selected item.

- Remote control operation

Button	Operation
Source	Change sources except USB.
MENU	Display on-screen display menus.
Enter	Open files or folders.
Exit	Go back to the upper level of OSD.
▲	Navigate upward to select files or folders.
▼	Navigate downward to select files or folders.
◀	Navigate left to select files or folders.
▶	Navigate right to select files or folders.

Photo file list mode



- Keypad operation

Button	Operation
MENU	Change to column, row or options.
▲	Navigate in the selected column, row and options.
▼	Navigate in the selected column, row and options.
ENTER	Start to work for the selected item.

- Remote control operation

Button	Operation
Source	Change sources except USB.
MENU	Display on-screen display menus.
Enter	Display the photo in full screen.
Exit	Go back to the upper level of OSD.
▲	Navigate upward to select files or folders.
▼	Navigate downward to select files or folders.
◀	Navigate left to select files or folders.
▶	Navigate right to select files or folders.

Photo full screen

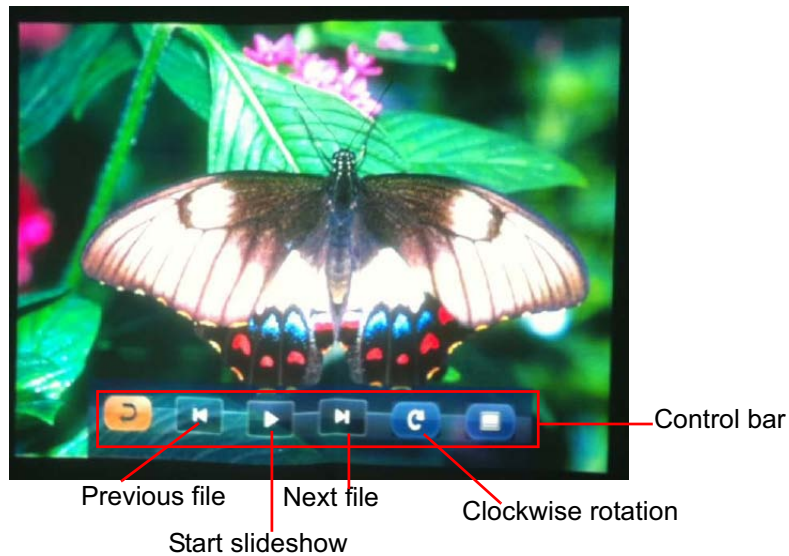

- Keypad operation

Button	Operation
MENU	Show control bar 5 seconds.
▲	<ul style="list-style-type: none"> Select previous file. Navigate to select items when control bar is on.
▼	<ul style="list-style-type: none"> Select next file. Navigate to select items when control bar is on.
ENTER	<ul style="list-style-type: none"> Start/stop slideshow. Start to work for the selected control bar item.

- Remote control operation

Button	Operation
Source	Change sources except USB.
MENU	Display on-screen display menus.
Enter	Start to work for the selected control bar item.
Exit	Go back to photo browser mode or file list mode.
▼	Show control bar 5 seconds.
◀	Navigate left to select items when control bar is on.
▶	Navigate right to select items when control bar is on.
▶/	Enter slideshow mode.
■	Stop slideshow.
◀/◀◀	Display previous file.
▶▶/▶	Display next file.

Office Viewer browser mode



- Keypad operation

Button	Operation
MENU	Go back to the upper level of OSD.
▲	Navigate upward to select items.
▼	Navigate downward to select items.
ENTER	Start to work for the selected item.

- Remote control operation

Button	Operation
Source	Change sources except USB.
MENU	Go back to the upper level of OSD.
Enter	Open files or folders.
Exit	Go back to the upper level of OSD.
▲	Navigate upward to select files or folders.
▼	Navigate downward to select files or folders.

Office Viewer full screen

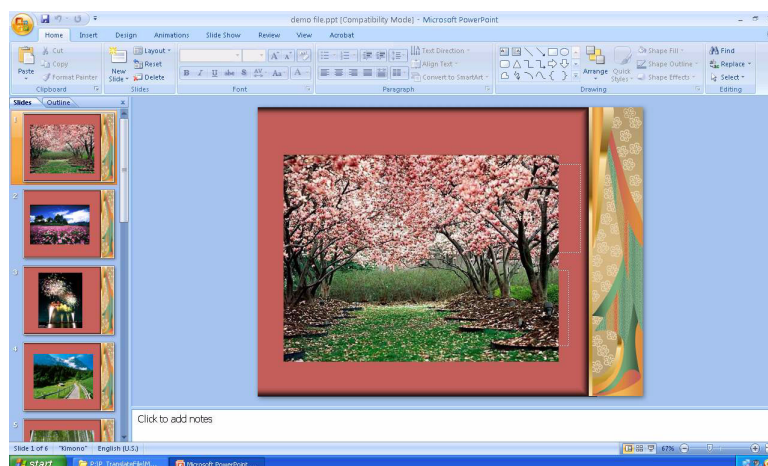

- Keypad operation

Button	Operation
MENU	Leave current document and go back to office viewer browser.
▲	<ul style="list-style-type: none"> • Move to previous page while page is not zoomed. • Move the display to the top of the page while zoomed.
▼	<ul style="list-style-type: none"> • Move to next page while page is not zoomed. • Move the display to bottom of the page while zoomed.
ENTER	Enlarge current page.

- Remote control operation

Button	Operation
Source	Change sources except USB.
MENU	Display on-screen display menus.
Enter	Enlarge current page.
Exit	Leave current document and go back to office viewer browser.
▲	<ul style="list-style-type: none"> • Move to previous page while page is not zoomed. • Move the display to the top of the page while zoomed.
▼	<ul style="list-style-type: none"> • Move to next page while page is not zoomed. • Move the display to bottom of the page while zoomed.
◀	Move the display to the right of the page.
▶	Move the display to the left of the page.

Supported file formats

Items	File extension
Document	AdobePDF 1.0~1.4 (PDF)
	MS PowerPoint 97~2010 (ppt, pptx)
	MS Excel 95, 97~2007 (xls, xlsx)
	MS Word 95~2007 (doc, docx)
Photo	JPEG(jpg, jpeg), BMP, PNG
Music	MP3, MP2, WMA, RA, AMR, APE, ASF, M4A, FLAC, OGG, WAV

Items	File Extension	Codec	Description
Video	AVI	H.264	Max 1920 x 1080 30fps
	MOV	MPEG-4	
	MP4	Divx	
	MPG	Xvid	
	3GP	H.263	
	3G2	MPEG-1	
	MKV	MPEG-2	
	VOB	Sorenson Spark	
	DAT	M-JPEG	
	M4V		
FLV			
Subtitles	MKV build-in		

Maintenance

The projector needs proper maintenance. You should keep the lens clean as dust, dirt or spots will project on the screen and diminish image quality. If any other parts need replacing, contact your dealer or qualified service personnel. When cleaning any part of the projector, always switch off and unplug the projector first.

Warning

- ***Never open any of the covers on the projector. Dangerous electrical voltages inside the projector can cause severe injury. Do not attempt to service this product yourself. Refer all servicing to qualified service personnel.***

Cleaning the lens

Gently wipe the lens with lens cleaning paper. Do not touch the lens with your hands.

Cleaning the projector housing

Gently wipe with a soft cloth. If dirt and stains are not easily removed, use a soft cloth dampened with water, or water and neutral detergent, and wipe dry with a soft, dry cloth.

Note

- ***Turn off the projector and remove the AC power cord from the power outlet before beginning maintenance work.***
- ***Make sure the lens is cool before cleaning.***
- ***Do not use detergents or chemicals other than those noted above. Do not use benzene or thinners.***
- ***Do not use chemical sprays.***
- ***Use a soft cloth or lens paper only.***

Specifications

Display system	Single 0.45" DLP panel
Resolution	WXGA (1280 x 800 pixels)
F/No.	1.928
Focal length	26.95mm
Light source	LED
Input terminal	Computer input, component input (through RGB input), Video input, Audio input (3.5mm), mini-B USB type x 1 (Supports USB display), SD card slot x 1 (Supports Photo, Music, Video and Office Viewer)
Scanning frequency	
Horizontal frequency	30 - 100 KHz
Vertical frequency	50 - 85 Hz
Environment	Operating: Temperature: 5°C to 35°C Humidity: 35%-85% Storage: Temperature: -20°C to 60°C Humidity: 85 % max.
Power requirement	DC19V, 3.42A
Power consumption	48 W (Max.); < 0.5 W (Standby)
Dimension (W x D x H)	129.7 x 126.8 x 39.6 mm
Weight	408g (14.4oz)
Note: Design and Specifications are subject to change without prior notice.	

Dimensions

129.7 mm (W) x 126.8 mm (D) x 39.6 mm (H)

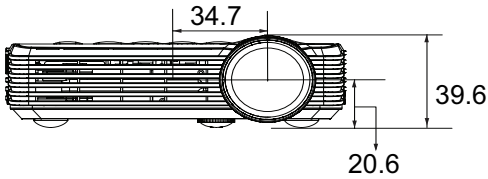
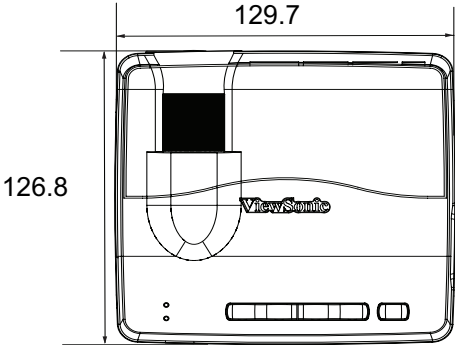

Appendix

LED Indicator Messages

Status/Problem	LED indicators	
	Power LED (Blue)	Temp LED (Red)
Standby	Solid	Off
Power on	Flashing for 10 times then solid	Off
Fan error	Solid	Flashing
Over temperature error	Solid	Solid

Compatibility modes

Computer:

Mode	Resolution	H Sync (kHz)	V-Sync (Hz)
VGA	640 x 480	31.47	59.94
	640 x 480	37.86	72.81
	640 x 480	37.50	75.00
	640 x 480	43.27	85.01
SVGA	800 x 600	35.16	56.25
	800 x 600	37.88	60.32
	800 x 600	48.08	72.19
	800 x 600	46.88	75.00
	800 x 600	53.67	85.06
XGA	1024 x 768	48.36	60.00
	1024 x 768	56.48	70.07
	1024 x 768	60.02	75.03
	1024 x 768	68.68	85.00
SXGA	1280 x 1024	63.98	60.02
	1280 x 1024	77	72
	1280 x 1024	80	75
	1280 x 960	60.00	60.00
	1280 x 960	75.2	75
SXGA+	1400 x 1050	65.3	60
WXGA	1280 x 800	49.7	60
UXGA	1600 x 1200	75	60
WXGA	1280 x 768	47.8	60
	1280 x 720	44.8	60
	1280 x 800	49.6	60
	1366 x 768	47.7	60
	1440 x 900	59.9	60
WSXGA+	1680 x 1050	65.3	60
	1920 x 1080	66.6	60

Video:

Compatibility	H-Sync [KHz]	V-Sync [Hz]
480i	15.734	60
480p	31.469	60
576i	15.625	50
576p	31.25	50
720p	45.0	60
720p	37.5	50
1080i	33.75	60
1080i	28.125	50

Troubleshooting

Refer to the symptoms and measures listed below before sending the projector for repairs. If the problem persists, contact your local reseller or service center. Please refer to "LED Indicator Messages" as well.

Start-up problems

If no lights turn on:

- Be sure that the power connection is correct.
- Press the power button again.
- Unplug the AC adapter and wait for a short while, then plug it in and press the power button again.

Image problems

If the searching source is displayed:

- Press **MENU** on the projector or **Source** on the remote control to select an active input source.
- Be sure the external source is turned on and connected.
- For a computer connection, ensure your notebook computer's external video port is turned on. Refer to the computer manual.

If the image is out of focus:

- While displaying the on-screen menu, adjust the focus ring.
- Check the projection lens to see if it needs cleaning.

If the image is flickering or unstable for a computer connection:

- Press **MENU** on the projector or **Menu** on the remote control, go to **Video/Audio** and adjust **Frequency** or **Tracking**.

Remote control problems

If the remote control does not operate:

- Be sure nothing is blocking the remote control receiver on the rear of the projector. Use the remote control within the effective range.
- Aim the remote control at the rear of the projector.
- Move the remote control so it is more directly in rear of the projector and not as far to the side.

IR control code

System code: 83F4

Format : NEC

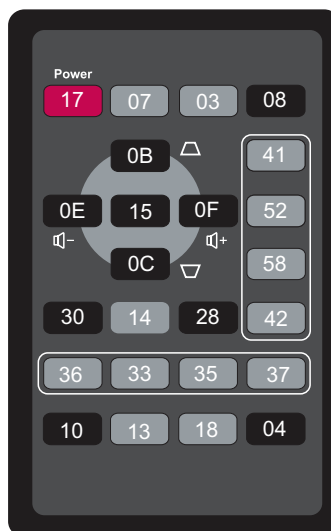

Customer Support

For technical support or product service, see the table below or contact your reseller.

Note : You will need the product serial number.

Country/Region	Website	T = Telephone F = FAX	Email
Australia/New Zealand	www.viewsonic.com.au	AUS= 1800 880 818 NZ= 0800 008 822	service@au.viewsonic.com
Canada	www.viewsonic.com	T (Toll-Free)= 1-866-463-4775 T (Toll)= 1-424-233-2533 F= 1-909-468-3757	service.ca@viewsonic.com
Europe	www.viewsoniceurope.com	www.viewsoniceurope.com/uk/Support/Calldesk.htm	
Hong Kong	www.hk.viewsonic.com	T= 852 3102 2900	service@hk.viewsonic.com
India	www.in.viewsonic.com	T= 1800 266 0101	service@in.viewsonic.com
Ireland (Eire)	www.viewsoniceurope.com/uk/	www.viewsoniceurope.com/uk/support/call-desk/	service_ie@viewsoniceurope.com
Korea	www.kr.viewsonic.com	T= 080 333 2131	service@kr.viewsonic.com
Latin America (Argentina)	www.viewsonic.com/la/	T= 0800-4441185	soporte@viewsonic.com
Latin America (Chile)	www.viewsonic.com/la/	T= 1230-020-7975	soporte@viewsonic.com
Latin America (Columbia)	www.viewsonic.com/la/	T= 01800-9-157235	soporte@viewsonic.com
Latin America (Mexico)	www.viewsonic.com/la/	T= 001-8882328722	soporte@viewsonic.com
Renta y Datos, 29 SUR 721, COL. LA PAZ, 72160 PUEBLA, PUE. Tel: 01.222.891.55.77 CON 10 LINEAS Electroser, Av Reforma No. 403Gx39 y 41, 97000 Mérida, Yucatán. Tel: 01.999.925.19.16 Other places please refer to http://www.viewsonic.com/la/soporte/index.htm#Mexico			
Latin America (Peru)	www.viewsonic.com/la/	T= 0800-54565	soporte@viewsonic.com
Macau	www.hk.viewsonic.com	T= 853 2870 0303	service@hk.viewsonic.com
Middle East	ap.viewsonic.com/me/	Contact your reseller	service@ap.viewsonic.com
Puerto Rico & Virgin Islands	www.viewsonic.com	T= 1-800-688-6688 (English) T= 1-866-379-1304 (Spanish) F= 1-909-468-3757	service.us@viewsonic.com soporte@viewsonic.com
Singapore/Malaysia/Thailand	www.viewsonic.com.sg	T= 65 6461 6044	service@sg.viewsonic.com
South Africa	ap.viewsonic.com/za/	Contact your reseller	service@ap.viewsonic.com
United Kingdom	www.viewsoniceurope.com/uk/	www.viewsoniceurope.com/uk/support/call-desk/	service_gb@viewsoniceurope.com
United States	www.viewsonic.com	T (Toll-Free)= 1-800-688-6688 T (Toll)= 1-424-233-2530 F= 1-909-468-3757	service.us@viewsonic.com

Limited Warranty

VIEWSONIC® PROJECTOR

What the warranty covers:

ViewSonic warrants its products to be free from defects in material and workmanship, under normal use, during the warranty period. If a product proves to be defective in material or workmanship during the warranty period, ViewSonic will, at its sole option, repair or replace the product with a like product. Replacement product or parts may include remanufactured or refurbished parts or components.

Limited Three (3) year General Warranty

Subject to the more limited one (1) year warranty set out below, North and South America: Three (3) years warranty for all parts excluding the lamp, three (3) years for labor, and one (1) year for the original lamp from the date of the first consumer purchase; Europe except Poland: Three (3) years warranty for all parts excluding the lamp, three (3) years for labor, and ninety (90) days for the original lamp from the date of the first consumer purchase; Poland: Two (2) years warranty for all parts excluding the lamp, two (2) years for labor, and ninety (90) days for the original lamp from the date of the first consumer purchase.

Limited One (1) year Heavy Usage Warranty:

Under heavy usage settings, where a projector's use includes more than fourteen (14) hours average daily usage, North and South America: One (1) year warranty for all parts excluding the lamp, one (1) year for labor, and ninety (90) days for the original lamp from the date of the first consumer purchase; Europe: One (1) year warranty for all parts excluding the lamp, one (1) year for labor, and ninety (90) days for the original lamp from the date of the first consumer purchase.

Other regions or countries: Please check with your local dealer or local ViewSonic office for the warranty information.

Lamp warranty subject to terms and conditions, verification and approval. Applies to manufacturer's installed lamp only. All accessory lamps purchased separately are warranted for 90 days.

Who the warranty protects:

This warranty is valid only for the first consumer purchaser.

What the warranty does not cover:

1. Any product on which the serial number has been defaced, modified or removed.
2. Damage, deterioration, failure, or malfunction resulting from:
 - a. Accident, abuse, misuse, neglect, fire, water, lightning, or other acts of nature, improper maintenance, unauthorized product modification, or failure to follow instructions supplied with the product.
 - b. Operation outside of product specifications.
 - c. Operation of the product for other than the normal intended use or not under normal conditions.
 - d. Repair or attempted repair by anyone not authorized by ViewSonic.
 - e. Any damage of the product due to shipment.
 - f. Removal or installation of the product.
 - g. Causes external to the product, such as electric power fluctuations or failure.
 - h. Use of supplies or parts not meeting ViewSonic's specifications.
 - i. Normal wear and tear.
 - j. Any other cause which does not relate to a product defect.
3. Removal, installation, and set-up service charges.

How to get service:

1. For information about receiving service under warranty, contact ViewSonic Customer Support (please refer to "Customer Support" page). You will need to provide your product's serial number.
2. To obtain warranted service, you will be required to provide (a) the original dated sales slip, (b) your name, (c) your address, (d) a description of the problem, and (e) the serial number of the product.
3. Take or ship the product freight prepaid in the original container to an authorized ViewSonic service center or ViewSonic.
4. For additional information or the name of the nearest ViewSonic service center, contact ViewSonic.

Limitation of implied warranties:

There are no warranties, express or implied, which extend beyond the description contained herein including the implied warranty of merchantability and fitness for a particular purpose.

Exclusion of damages:

ViewSonic's liability is limited to the cost of repair or replacement of the product. ViewSonic shall not be liable for:

1. Damage to other property caused by any defects in the product, damages based upon inconvenience, loss of use of the product, loss of time, loss of profits, loss of business opportunity, loss of goodwill, interference with business relationships, or other commercial loss, even if advised of the possibility of such damages.
2. Any other damages, whether incidental, consequential or otherwise.
3. Any claim against the customer by any other party.

Effect of state law:

This warranty gives you specific legal rights, and you may also have other rights which vary from state to state. Some states do not allow limitations on implied warranties and/or do not allow the exclusion of incidental or consequential damages, so the above limitations and exclusions may not apply to you.

Sales outside the U.S.A. and Canada:

For warranty information and service on ViewSonic products sold outside of the U.S.A. and Canada, contact ViewSonic or your local ViewSonic dealer.

The warranty period for this product in mainland China (Hong Kong, Macao and Taiwan Excluded) is subject to the terms and conditions of the Maintenance Guarantee Card.

For users in Europe and Russia, full details of warranty provided can be found in www.viewsoniceurope.com under Support/Warranty Information.

4.3: Projector Warranty

PRJ_LW01 Rev. 1h 06-25-07

Mexico Limited Warranty

VIEWSONIC® PROJECTOR

What the warranty covers:

ViewSonic warrants its products to be free from defects in material and workmanship, under normal use, during the warranty period. If a product proves to be defective in material or workmanship during the warranty period, ViewSonic will, at its sole option, repair or replace the product with a like product. Replacement product or parts may include remanufactured or refurbished parts or components & accessories.

How long the warranty is effective:

3 years for all parts excluding the lamp, 3 years for labor, 1 year for the original lamp from the date of the first consumer purchase.

Lamp warranty subject to terms and conditions, verification and approval. Applies to manufacturer's installed lamp only.

All accessory lamps purchased separately are warranted for 90 days.

Who the warranty protects:

This warranty is valid only for the first consumer purchaser.

What the warranty does not cover:

1. Any product on which the serial number has been defaced, modified or removed.
2. Damage, deterioration or malfunction resulting from:
 - a. Accident, misuse, neglect, fire, water, lightning, or other acts of nature, unauthorized product modification, unauthorized attempted repair, or failure to follow instructions supplied with the product.
 - b. Any damage of the product due to shipment.
 - c. Causes external to the product, such as electrical power fluctuations or failure.
 - d. Use of supplies or parts not meeting ViewSonic's specifications.
 - e. Normal wear and tear.
 - f. Any other cause which does not relate to a product defect.
3. Any product exhibiting a condition commonly known as "image burn-in" which results when a static image is displayed on the product for an extended period of time.
4. Removal, installation, insurance, and set-up service charges.

How to get service:

For information about receiving service under warranty, contact ViewSonic Customer Support (Please refer to the attached Customer Support page). You will need to provide your product's serial number, so please record the product information in the space provided below on your purchase for your future use. Please retain your receipt of proof of purchase to support your warranty claim.

For Your Records

Product Name: _____

Model Number: _____

Document Number: _____

Serial Number: _____

Purchase Date: _____

Extended Warranty Purchase? _____ (Y/N)

If so, what date does warranty expire? _____

1. To obtain warranty service, you will be required to provide (a) the original dated sales slip, (b) your name, (c) your address, (d) a description of the problem, and (e) the serial number of the product.
2. Take or ship the product in the original container packaging to an authorized ViewSonic service center.
3. Round trip transportation costs for in-warranty products will be paid by ViewSonic.

Limitation of implied warranties:

There are no warranties, express or implied, which extend beyond the description contained herein including the implied warranty of merchantability and fitness for a particular purpose.

Exclusion of damages:

ViewSonic's liability is limited to the cost of repair or replacement of the product. ViewSonic shall not be liable for:

1. Damage to other property caused by any defects in the product, damages based upon inconvenience, loss of use of the product, loss of time, loss of profits, loss of business opportunity, loss of goodwill, interference with business relationships, or other commercial loss, even if advised of the possibility of such damages.
2. Any other damages, whether incidental, consequential or otherwise.
3. Any claim against the customer by any other party.
4. Repair or attempted repair by anyone not authorized by ViewSonic.

Contact Information for Sales & Authorized Service (Centro Autorizado de Servicio) within Mexico:	
Name, address, of manufacturer and importers: México, Av. de la Palma #8 Piso 2 Despacho 203, Corporativo Interpalmas, Col. San Fernando Huixquilucan, Estado de México Tel: (55) 3605-1099 http://www.viewsonic.com/la/soporte/index.htm	
NÚMERO GRATIS DE ASISTENCIA TÉCNICA PARA TODO MÉXICO: 001.866.823.2004	
Hermosillo: Distribuciones y Servicios Computacionales SA de CV. Calle Juarez 284 local 2 Col. Bugambilias C.P: 83140 Tel: 01-66-22-14-9005 E-Mail: disc2@hmo.megared.net.mx	Villahermosa: Compumantenimientos Garantizados, S.A. de C.V. AV. GREGORIO MENDEZ #1504 COL, FLORIDA C.P. 86040 Tel: 01 (993) 3 52 00 47 / 3522074 / 3 52 20 09 E-Mail: compumantenimientos@prodigy.net.mx
Puebla, Pue. (Matriz): RENTA Y DATOS, S.A. DE C.V. Domicilio: 29 SUR 721 COL. LA PAZ 72160 PUEBLA, PUE. Tel: 01(52).222.891.55.77 CON 10 LINEAS E-Mail: datos@puebla.megared.net.mx	Veracruz, Ver.: CONEXION Y DESARROLLO, S.A DE C.V. Av. Americas # 419 ENTRE PINZÓN Y ALVARADO Fracc. Reforma C.P. 91919 Tel: 01-22-91-00-31-67 E-Mail: gacosta@qplus.com.mx
Chihuahua Soluciones Globales en Computación C. Magisterio # 3321 Col. Magisterial Chihuahua, Chih. Tel: 4136954 E-Mail: Cefeo@soluglobales.com	Cuernavaca Compusupport de Cuernavaca SA de CV Francisco Leyva # 178 Col. Miguel Hidalgo C.P. 62040, Cuernavaca Morelos Tel: 01 777 3180579 / 01 777 3124014 E-Mail: aquevedo@compusupporteva.com
Distrito Federal: QPLUS, S.A. de C.V. Av. Coyoacán 931 Col. Del Valle 03100, México, D.F. Tel: 01(52)55-50-00-27-35 E-Mail : gacosta@qplus.com.mx	Guadalajara, Jal.: SERVICRECE, S.A. de C.V. Av. Niños Héroes # 2281 Col. Arcos Sur, Sector Juárez 44170, Guadalajara, Jalisco Tel: 01(52)33-36-15-15-43 E-Mail: mmiranda@servicrece.com
Guerrero Acapulco GS Computación (Grupo Sesicomp) Progreso #6-A, Colo Centro 39300 Acapulco, Guerrero Tel: 744-48-32627	Monterrey: Global Product Services Mar Caribe # 1987, Esquina con Golfo Pérsico Fracc. Bernardo Reyes, CP 64280 Monterrey N.L. México Tel: 8129-5103 E-Mail: aydeem@gps1.com.mx
MERIDA: ELECTROSER Av Reforma No. 403Gx39 y 41 Mérida, Yucatán, México CP97000 Tel: (52) 999-925-1916 E-Mail: rrrb@sureste.com	Oaxaca, Oax.: CENTRO DE DISTRIBUCION Y SERVICIO, S.A. de C.V. Murguía # 708 P.A., Col. Centro, 68000, Oaxaca Tel: 01(52)95-15-15-22-22 Fax: 01(52)95-15-13-67-00 E-Mail: gpotai2001@hotmail.com
Tijuana: STD Av Ferrocarril Sonora #3780 L-C Col 20 de Noviembre Tijuana, Mexico	FOR USA SUPPORT: ViewSonic Corporation 381 Brea Canyon Road, Walnut, CA. 91789 USA Tel: 800-688-6688 (English); 866-323-8056 (Spanish); Fax: 1-800-685-7276 E-Mail: http://www.viewsonic.com



ViewSonic®