



Please read this manual carefully before operating your set.
Retain it for future reference.
Record model number and serial number of the set.
See the label attached on the bottom of the set and quote this information to your dealer when you require service.

Model number :
Serial number :

LG LCOS PROJECTOR

CF181D OWNER'S MANUAL

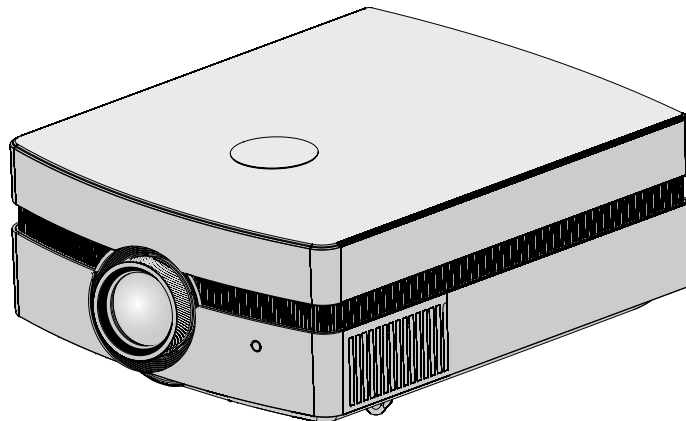

LCOS PROJECTOR

Warning

This is a class B product. In a domestic environment this product may cause radio interference, in which case the user may be required to take adequate measures.

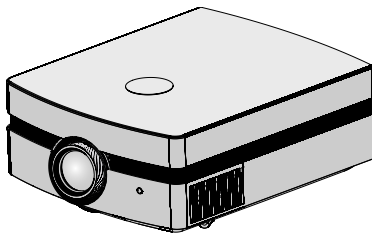

Contents

Safety Instructions.....4

Names of parts

Main Body7
 Connecting Part8
 Control Panel9
 Remote Control10
 Installing Batteries.....10
 Projector Status Indicators.....11
 Accessories.....12
 Optional Extras12

Installing and Composition

Installation Instructions13
 Positioning the Projector14
 Using Kensington Security System.....15
 Turning on the Projector16
 Turning off the Projector16
 Focus and Position of the Screen Image.....17
 Selecting source mode17

Connection

Connecting to a Desktop PC18
 Connecting to a Video Source18
 Connecting to a DVD19
 Connecting to a D-TV Set-Top Box19

Function

PICTURE Menu Options

Picture mode20
 Adjusting Video20

ADV.PICTURE Menu Options

Auto Iris Function21
 TruMotion Demo Function.....21
 Advanced Control Function.....22
 Advanced Picture Reset Function23

SCREEN Menu Options

To Change PJT Mode24
 Using Aspect Ratio Function.....24
 Using Keystone Function25
 Test Pattern Function25
 Auto configure Function25
 RGB Config. Function26
 Screen Reset Function26

OPTION Menu Options

Using Still Function27
 Selecting Language27
 Using Blank Function27
 Selecting Blank image color28
 Sleep time Function28
 Auto sleep Function29
 Option Reset Function29

INFORMATION Menu Options

To See The Projector Information29

Information

Supported Monitor Display.....30
 Maintenance.....31
 Replacing the Lamp32
 Specifications35

Disposal of your old appliance

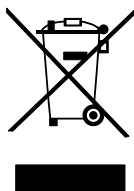



1. When this crossed-out wheeled bin symbol is attached to a product it means the product is covered by the European Directive 2002/96/EC.
2. All electrical and electronic products should be disposed of separately from the municipal waste stream via designated collection facilities appointed by your government or your local authorities.
3. The correct disposal of your old appliance will help prevent potential negative consequences for the environment and human health.
4. For more detailed information about disposal of your old appliance, please contact your city office, waste disposal service or the shop where you purchased the product.

Safety Instructions

Please take note of the safety instructions to prevent any potential accident or misuse of the projector.

→ Safety Instructions are given in two forms as detailed below.

 **WARNING** : The violation of this instruction may cause serious injuries and even death.

 **NOTES** : The violation of this instruction may cause light injuries or damage to the projector.

→ After reading this manual, keep it in the place that the user can access it easily.

Indoor Installation		 WARNING
Do not place the Projector in direct sunlight or near heat sources such as radiators, fires and stove etc. This may cause a fire hazard !	Do not place inflammable materials beside the projector This may cause a fire hazard !	Do not allow children to hang on the installed projector. They may cause the projector to fall, causing injury or death.

Indoor Installation		 NOTES
Disconnect the power and remove all connections before moving.	Do not place the projector close to sources of steam or oil such as a humidifier. This may create a fire hazard or an electric shock hazard !	Do not place the projector where it might be exposed to dust. This may cause a fire hazard or damage to the unit!
When installing the projector on a table, be careful not to place it near the edge. This may cause the projector to fall causing serious injury to a child or adult and serious damage to the projector. Only use a suitable stand.	Only use the projector on a level and stable surface. It may fall and cause injury and/or damage to the unit.	Ensure good ventilation around the projector. The distance between the projector and the wall should be more than 30cm/12 inches. An excessive increase in its internal temperature may cause a fire hazard or damage to the unit!

Do not block the vents of the projector or restrict air-flow in any way. This would cause the internal temperature to increase and could cause a fire hazard or damage to the unit!	Do not place the projector directly on a carpet, rug or place where ventilation is restricted. This would cause its internal temperature to increase and might create a fire hazard or damage the unit.
--	--

Outdoor Installation		 WARNING
Do not use the projector in a damp place such as a bathroom where it is likely to get wet. This may cause a fire or an electric shock hazard !		

Power		 WARNING
Earth ground wire should be connected. If the earth ground wire is not connected, there is a possible danger of electric shock! If grounding methods are not possible, a separate circuit breaker should be installed by a qualified electrician. Do not connect ground to telephone wires, lightning rods or gas pipe.	The power plug should be inserted fully into the power outlet to avoid a fire hazard ! This may cause a fire hazard or damage the unit.	Do not place heavy objects on the power cord. This may cause a fire or an electric shock hazard !

Power

 **WARNING**

Do not use too many plugs on the same outlet.
It may result in overheating of the outlet and cause a fire hazard !

Power

 **NOTES**

Never touch the power plug with a wet hand
This may cause an electric shock hazard !

Hold the plug firmly when unplugging. If you pull the cord, it may be damaged.
This may cause a fire hazard !

Prevent dust collecting on the power plug pins or outlet.
This may cause a fire hazard !

Do not plug when the power cord or the plug is damaged or any part of the power outlet is loose.
This may cause a fire or an electric shock hazard or damage to the unit!

Ensure the power cord does not come into contact with sharp or hot objects such as a heater.
This may cause a fire or an electric shock hazard or damage to the unit!

Place the projector where people will not trip or tread on the power lead.
This may cause a fire or an electric shock hazard or damage to the unit!

Do not turn the projector On/Off by plugging-in or unplugging the power plug to the wall outlet.
(Do not use the power plug for switch.)
It may cause mechanical failure or could cause an electric shock.

Using

 **WARNING**

Do not place anything containing liquid on top of the projector such as flowerpot, cup, cosmetics or candle.
This may cause a fire hazard or damage to the unit!

In case of impact shock or damage to the projector switch it off and unplug it from the power outlet and contact your service center.
This may cause a fire or an electric shock hazard or damage to the unit!

Do not allow any objects to fall into the projector.
This may cause an electric shock hazard or damage to the unit!

If water is spilt into the projector unplug it from the power outlet immediately and consult your Service Agent.
This may cause an electric shock hazard or damage to the unit!

Dispose of used batteries carefully and safely.
In the case of a battery being swallowed by a child please consult a doctor immediately.

In the event that an image does not appear on the screen please switch it off and unplug it from the power outlet and contact your Service Agent.
This may cause a fire or an electric shock hazard or damage to the unit!

Do not remove any covers (except lens cover). Or there is a high risk of Electric Shock!

Don't look directly onto the lens when the projector is in use. Eye damage may occur!

Do not touch metal parts during or soon after operation since the vents and lamp cover will remain very hot!

CAUTION concerning Power

Do not overload wall outlets. Overloaded wall outlets, loose or damaged wall outlets, extension cords, frayed power cords, or damaged or cracked wire insulation are dangerous. Any of these conditions could result in electric shock or fire. Periodically examine the cord of your appliance. If its appearance indicates damage or deterioration, unplug it, discontinue use of the appliance, and have the cord replaced with an exact replacement part by an authorized service personnel.

Protect the power cord from physical or mechanical abuse, such as being twisted, kinked, pinched, closed in a door, or walked upon. Pay particular attention to plugs, wall outlets, and the point where the cord exits the appliance.

Using

 WARNING

Never touch the wall outlet when there is leakage of gas, open the windows and ventilate.

It can cause a fire or a burn by a spark.

Do not drop the projector or allow impact shock.

This may cause mechanical failure or personal injury !

Don't look at laser beam directly as it can cause eye damage!

Always open the lens door or remove the lens cap when the projector lamp is on.

Using

 NOTES

Do not place heavy objects on top of projector.

This may cause mechanical failure or personal injury!

Take care not to impact the lens particularly when moving the projector.

Do not touch the lens of the projector. It is delicate and easily damaged.

Do not use any sharp tools on the projector as this will damage the casing.

Cleaning

 WARNING

Do not use water while cleaning the projector

This may cause damage to the projector or an electric shock hazard.

In the unlikely event of smoke or a strange smell from the projector, switch it off, unplug it from the wall outlet and contact your dealer or service center.

This may cause a fire or an electric shock hazard or damage to the unit!

Use an air spray or soft cloth that is moist with a neutral detergent and water for removing dust or stains on the projection lens.

Cleaning

 NOTES

Contact the Service Center once a year to clean the internal parts of the projector.

Accumulated dust can cause mechanical failure.

When cleaning the plastic parts such as projector case, unplug the power and wipe it with a soft cloth. Do not use cleanser, spray water or wipe with a wet cloth. Especially, never use cleanser (glass cleaner), automobile or industrial shiner, abrasive or wax, benzene, alcohol etc., which can damage the product. Use an air spray or soft cloth that is moist with a neutral detergent and water for removing dust or stains on the projection lens.

It can cause fire, electric shock or product damage (deformation, corrosion and damage).

Others

 WARNING

Do not attempt to service the projector yourself. Contact your dealer or service center.

This may cause damage to the projector and could give an electric Shock as well as invalidating the warranty.

Others

 NOTES

Be sure to unplug if the projector when not used for a long period.

Accumulated dust may cause a fire hazard or damage to the unit!

Refer lamp servicing to qualified service personnel.

Do not mix new batteries with old batteries.

This may cause the batteries to over-heat and leak.

Only use the specified type of battery.

This could cause damage to the remote control.

Names of parts

Main Body

* The projector is manufactured using high-precision technology. You may, however, see on the Projector screen tiny black points and/or bright points (red, blue, or green). This can be a normal result of the manufacturing process and does not always indicate a malfunction.

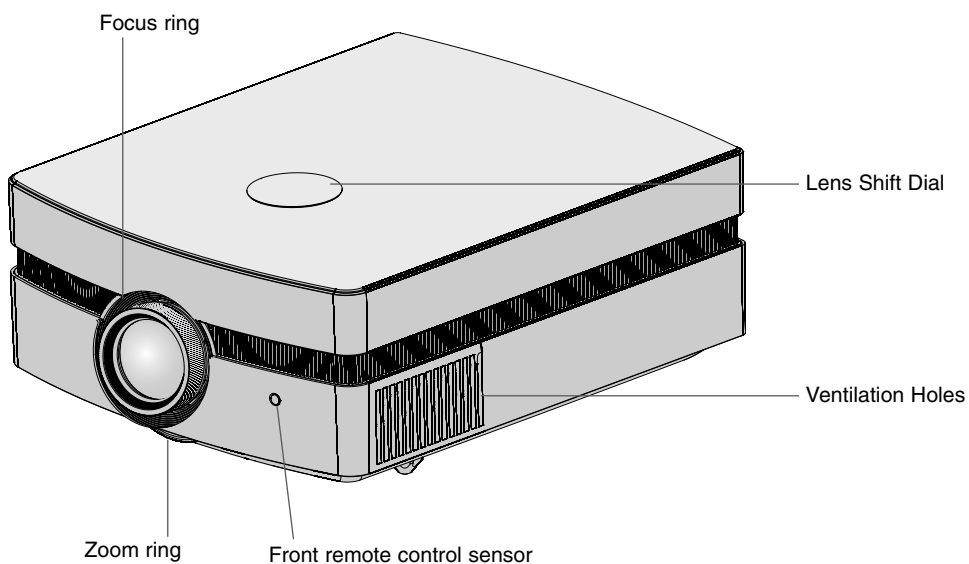

Connecting Part

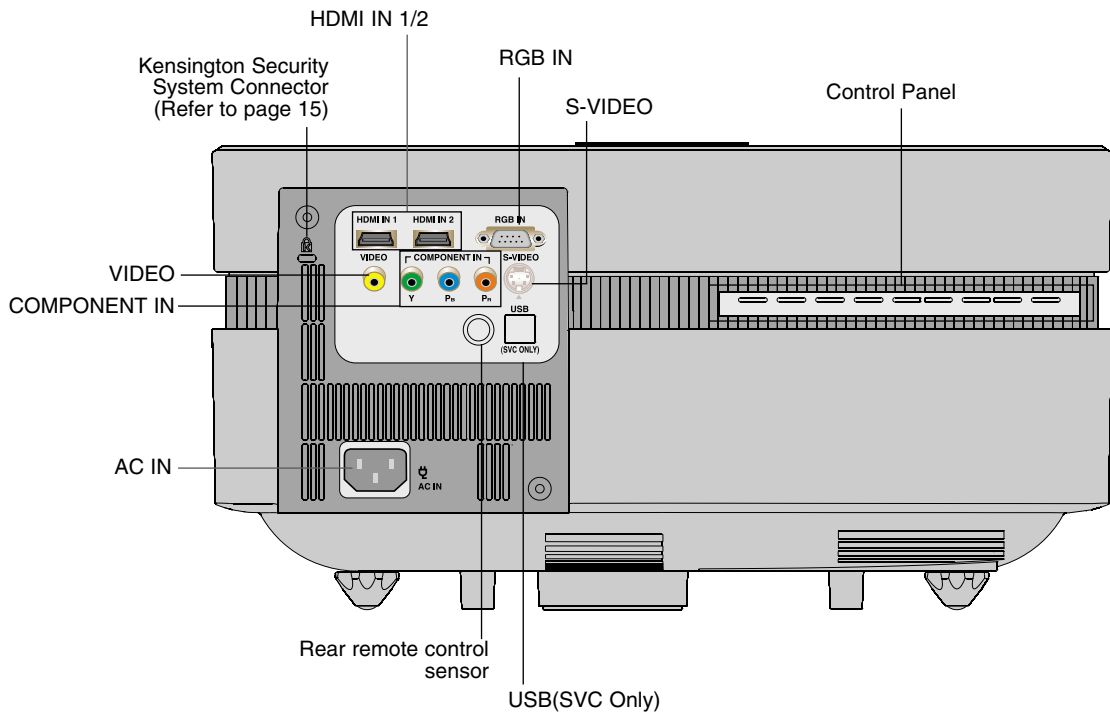

Control Panel

POWER Button
Turn ON/OFF the projector.

INPUT Button
Switches to RGB, HDMI, Video,
S-Video or Component mode.

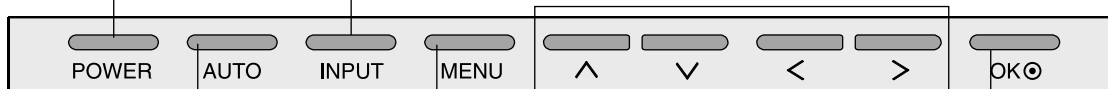

OK Button
Checks present mode and
saves the function changes.

^/∇/◀/▶ Button
Adjusts functions of menus

MENU Button
Selects or closes menus.

AUTO Button
It automatically corrects the position and
shaking of the image in RGB mode.

Remote Control

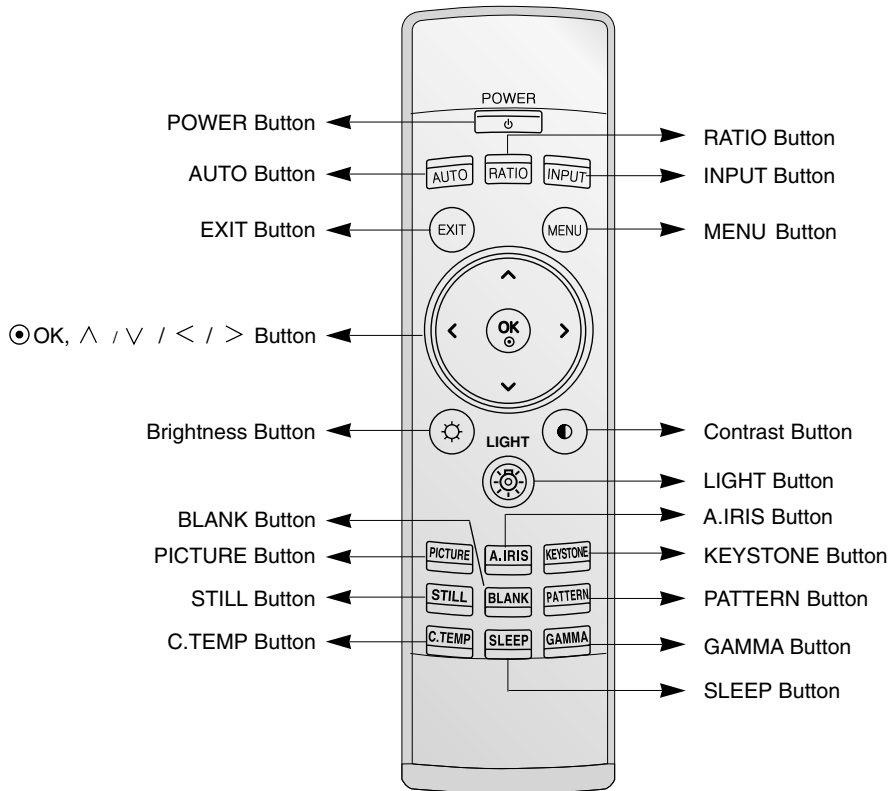

Installing Batteries

CAUTION

RISK OF EXPLOSION IF BATTERY IS REPLACED WITH AN INCORRECT TYPE.
DISPOSE OF USED BATTERIES ACCORDING TO THE INSTRUCTIONS.

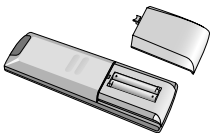

- Open the battery compartment cover on the back of the remote control.
- Insert the specified type of batteries with correct polarity, match "+" with "+", and match "-" with "-".
- Install two 1.5V AAA batteries. Don't mix used batteries with new batteries.

Projector Status Indicators

* Lamp indicator, operation indicator and temperature indicator at the top of the projector show the user the operating status of the projector.

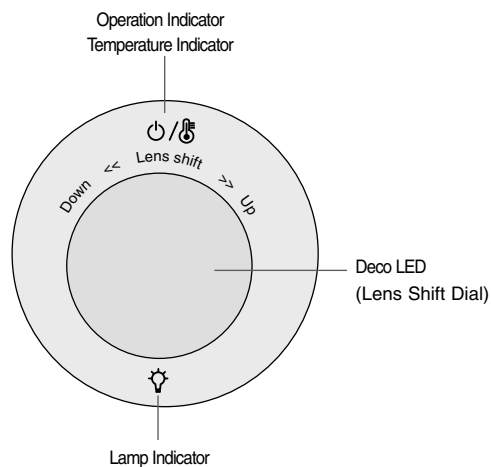
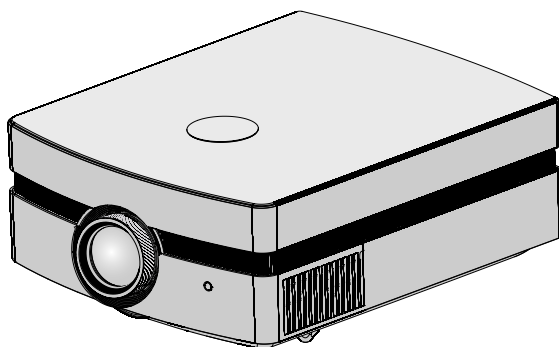

Operation Indicator / Temperature Indicator	Red	Standby.
	Green	Unit is in operation (Lamp is turned on)
	Orange(flashing)	The lamp is cooling (60 seconds).
	Green (flashing)	The projector has been turned off due to excessive heat (60 seconds).
	Off	Power off.
	Orange	This is the warning message of excessive heat when the projector is on. Turn the projector off and check the ventilator.
	Red(flashing)	Power has turned off due to problem with the internal cooling fan. Contact your service center.
Lamp Indicator	Red	Projector lamp is reaching the end of its life and needs to be replaced with a new lamp.
	Red(flashing)	An error has occurred in the projector lamp. Turn the projector on again after sufficient amount of time. If this indicator flashes red again, contact your local service center.
	Green (flashing)	The lamp cover and filter cover is opened.
Deco LED (Lens Shift Dial)	Blue (flashing)	Lamp is starting up.

Accessories



Remote Control

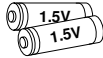

2 Batteries

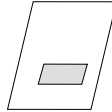

Owner's manual



CD Owner's manual



Polishing Cloth



Power Cord



Filter

Optional Extras

* Contact your dealer to purchase these items.

* The lamp is consumable and needs to be replaced with a new one when it is burned out. Contact your service personnel for replacing of lamp.

* Optional parts can be changed without notice to improve the quality of the product, and new optional parts can be added.

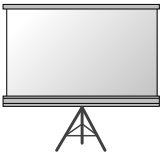

Projection Screen



Lamp



SCART to RCA jack

Ceiling mount for projector

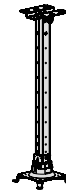
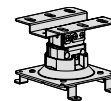

S-Video Cable



HDMI Cable



Component Cable



Computer Cable



Video Cable

Installing and Composition

Installation Instructions

* Don't place the projector in the following conditions. It may cause malfunction or product damage.

● Provide proper ventilation for this projector.

- The projector is equipped with ventilation holes(intake) on the bottom and ventilation holes(exhaust) on the front. Do not block or place anything near these holes, or internal heat build-up may occur, causing picture degradation or damage to the projector.

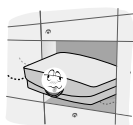

- Do not place the projector on a carpet, rug or other similar surface. It may prevent a adequate ventilation of the projector bottom. This product should be mounted to a wall or ceiling only.

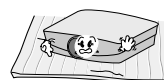

- Never push projector or spill any kind of liquid into the projector.

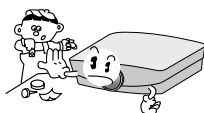

- Leave an adequate distance(30cm/12 inches or more) around the projector.

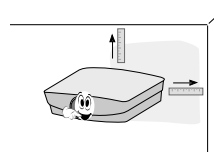

● Place this projector in adequate temperature and humidity conditions.

- Install this projector only in a location where adequate temperature and humidity is available. (refer p.35)

● Don't place the projector where it can be covered with dust.

- This may cause overheating of the projector.

● Do not obstruct the slots and openings of the projector. This may cause overheating and create a fire hazard.

- This projector is manufactured using high-precision technology. You may, however, see tiny black points and/or bright points (red, blue, or green) that continuously appear on the projector Screen. This is a normal result of the manufacturing process and does not indicate a malfunction.

● To display DTV programs, it is necessary to purchase a DTV receiver (Set-top Box) and connect it to the projector.

● When the remote control does not work during operation.

- The remote control may not work when a lamp equipped with electronic ballast or a three-wavelength lamp is installed. Replace those lamps with international standard products to use the remote control normally.

Positioning the Projector

1. Place the projector on a sturdy and horizontal surface.
2. Place the projector the desired distance from the screen. The distance between the projector and the screen determines the actual size of the image.
3. Position the projector so that the lens is set at a right angle to the screen. If the projector is not set at a right angle, the screen image will be crooked. The keystone adjustment may correct this (Refer to page 25.).
4. Once you have positioned the projector, connect the power and any input devices.

projection distance based on the picture format

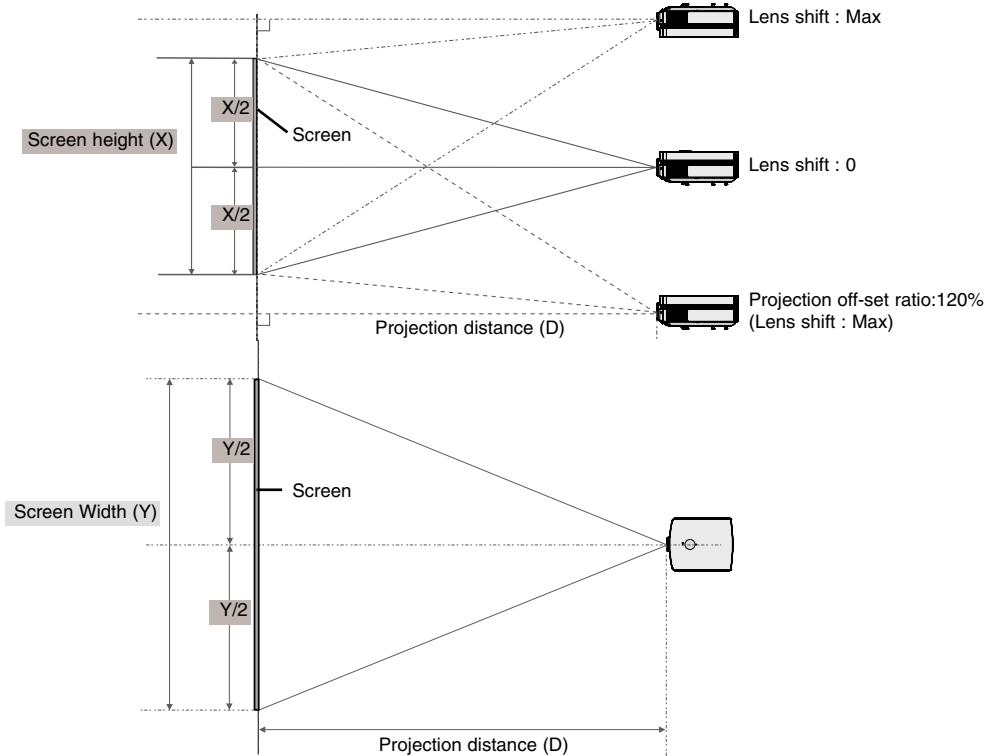

16 : 9 Scale					
Image				Projection Distance	
Diagonal Size (inch)	Diagonal Size (mm)	Horizontal Size (mm)	Vertical Size (mm)	Wide Distance (mm)	Tele Distance (mm)
30	762	664	374	877	1605
40	1016	886	498	1181	2152
50	1270	1107	623	1484	2699
60	1524	1328	747	1788	3246
70	1778	1550	872	2092	3794
80	2032	1771	996	2395	4341
90	2286	1992	1121	2699	4888
100	2540	2214	1245	3003	5435
120	3048	2657	1494	3610	6530
140	3556	3099	1743	4218	7624
160	4064	3542	1992	4825	8719
180	4572	3985	2241	5433	9813
200	5080	4428	2491	6040	10907
220	5588	4870	2740	6648	12002
240	6096	5313	2989	7255	13096
260	6604	5756	3238	7863	14191
280	7112	6199	3487	8470	15285
300	7620	6641	3736	9078	16380

* The longest/shortest distance show status when adjusted by the zoom function.
 * You can move an image up to 70% of the screen size from the lens center.

Using Kensington Security System

- This projector has a 'Kensington' Security System Connector on the side panel. Connect the 'Kensington' Security System cable as below.
- For the detailed installation and use of the Kensington Security System, refer to the user's guide included to the Kensington Security System set.
And for further information, contact <http://www.kensington.com>.
- The Kensington Security System is an optional item.

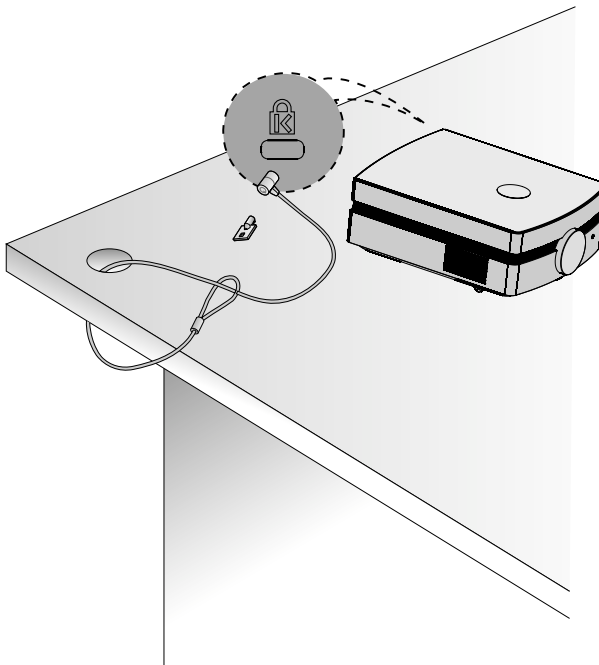

Turning on the Projector

1. Connect power cord correctly.
2. Remove the lens cap. If it is left on, it could become deformed due to the heat produced by the projection lamp.
3. Press the **POWER** button on the remote control or back cover.
 - An image will appear after the operation deco LED turns (Blue (flashing))(Refer to page 11).
 - Press the INPUT button on the remote control or the INPUT button on the control panel to select the input signal you want.

Note!

* Do not disconnect the power cord while the suction/discharge fan in operation. If the power cord is disconnected during the suction/ discharge fan in operation, it may takes longer to activate the lamp after turning on the power and the lifespan of the lamp may be shortened.

Turning off the Projector

1. Press the **POWER** button on the back cover or remote control.
2. Press the **POWER** button on the back cover or remote control again to turn off the power.
3. If the operation indicator is flashing orange, in other words the fan is working (60 seconds), do not disconnect the projector. When the indicator turns red, you may remove the power cord (Refer to page 11).
 - If the operation indicator LED is orange and flashing, the power button on the back cover or on the remote control will not operate.

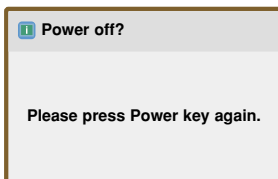

Focus and Position of the Screen Image

When an image appears on the screen, check if it is in focus and fits the screen well.

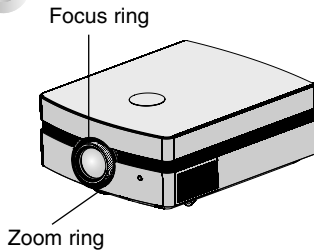

- To adjust the focus of the image, rotate the focus ring which is the outer ring on the lens.
- To adjust the size of the image, rotate the zoom ring which is the under ring on the lens.

When you need to move the screen image up or down, use the Lens shift dial on the projector to adjust the height as shown below.

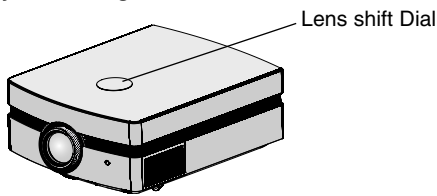

- Turn the Lens shift dial left or right to adjust the projector image up or down.

Note!

Turning the Lens shift dial with excessive power may cause damage to the projector.

Selecting source mode

1. Press the **INPUT** button.

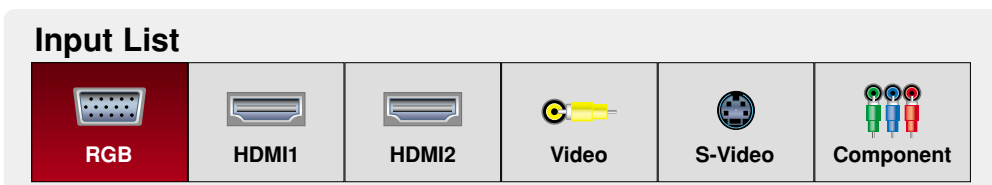

2. Selecting an input signal with the **INPUT** button will only change the projector only to connected inputs. You can change it to any inputs with the < , > button.

Connection

Connecting to a Desktop PC

- * You can connect the projector to a computer of VGA, SVGA, XGA, SXGA and 1080p/60Hz output.
- * Refer to page 30 for resolutions the projector supports.

< How to connect >

Connect the RGB IN of the projector and the computer output port with computer cable.

- * You may have to change the resolution that your PC exports to one supported by the projector. Refer to page 30. This projector may not support output from laptops when the laptop screen is on.

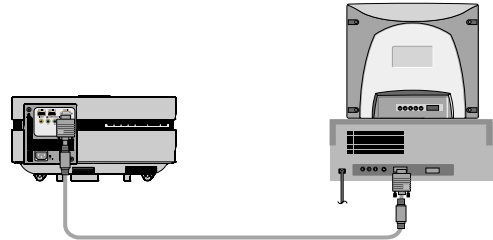

Connecting to a Video Source

- * You can connect a VCR, a camcorder or any other compatible video image source to the projector.

< How to connect 1 >

- a. Connect the Video input jacks of the projector to the output jacks of the A/V source with Video cable.

< How to connect 2 >

- b. Connect the S-Video input jack of the projector to the S-Video output jack of an A/V source with an S-Video cable.
 - * S-Video supports better video quality than a regular A/V connection.

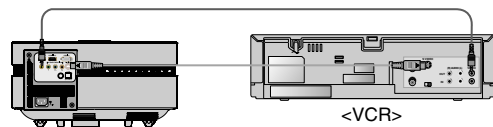

Connecting to a DVD

* The output jacks (Y, Pb, Pr) of the DVD might be labeled as Y, Pb, Pr / Y, B-Y, R-Y / Y, Cb, Cr according to the equipment.

< How to connect >

- a. Connect the DVD component cable to the Y, Pb and Pr of the COMPONENT IN of the projector.
 - * When connecting the component cable, match the jack colors with the component cable. (Y=green, Pb=blue, Pr=red)
- b. You may use HDMI instead of component if available on the DVD player. HDMI supports better quality than component.

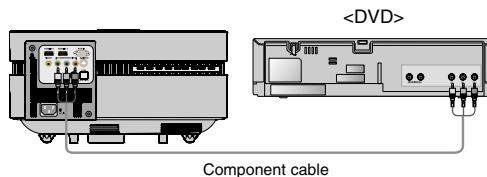

Signal	Component	HDMI
480i	O	X
480p	O	O
720p	O	O
1080i	O	O
1080p	O	O
576i	O	X
576p	O	O

Connecting to a D-TV Set-Top Box

- * To receive D-TV programs, it is necessary to purchase a D-TV receiver (Set-Top Box) and connect it to the projector.
- * Please refer to the owner's manual of the D-TV Set-Top Box for the connection between the projector and D-TV Set-Top Box.

< How to connect a HDMI source >

- a. Connect the HDMI IN of the projector and the HDMI output port of the DTV set-top box with an HDMI cable.
- b. Set the DTV receiver's resolution to one of the following:
480p(576p)/720p/1080i/1080p mode.

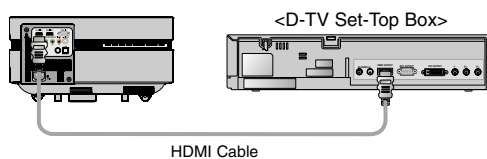

< How to connect a Component source >

- a. Connect the component cable connected to the DTV set-top box to the Y, Pb and Pr of the COMPONENT IN of the projector.
 - * When connecting the component cable, match the jack colors. (Y=green, Pb=blue, Pr=red)

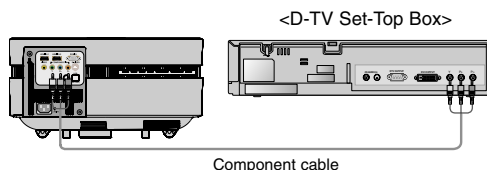

Function

* In this manual, the OSD(On Screen Display) may be different from your Projector's because it is just an example to help with the Projector operation.

* This operating guide explains operation of RGB(PC) mode mainly.

PICTURE Menu Options

Picture mode

* Use Picture mode function to set the projector for the best picture appearance.

1. Press the **PICTURE** button on the remote control.
2. Press the **<** , **>** button to adjust the screen condition as you want.

- Each press of the **<** , **>** button changes the screen as shown below.



- You can use this function through the **MENU** button.
- To exit the menu display, press the **EXIT** button.

Adjusting Video

1. Press the **MENU** button. Then, move to **PICTURE** with the **^** , **v** , **<** , **>** buttons and press the **OK** button.
2. Move to a sub-item with the **>** button. Then, use the **^** , **v** buttons to move to a desired function and press the **OK** button.
3. Use the **<** , **>** buttons to make a desired adjustment and then press the **OK** button.

- You can set image values differently for each input and **Picture Mode**.
- Saving after making adjustments will display **(User)** in adjusted **Picture Mode**. (except **Expert 1/2**)
- Execute **Picture Reset** for **Picture Mode** to restore back to default factory settings.
- You can adjust contrast by pressing the **⦿** button on the remote control.
- You can adjust brightness by pressing the **⚙** button on the remote control.
- Press the **MENU** or **EXIT** button to exit the menu screen.

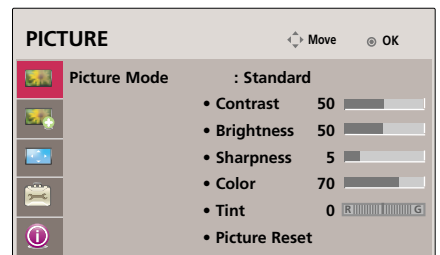

ADV. PICTURE Menu Options

Auto Iris Function

* This function adjusts the brightness of the entire image depending on inputted image to provide optimum image quality.

1. Press the **A.IRIS** button on the remote control.
2. Press the **<**, **>** button to adjust the screen condition as you want.

- Each press of the **<**, **>** button changes the screen as shown below.

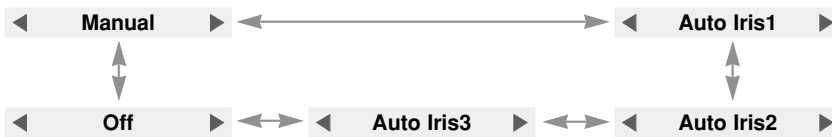

- **Manual** : You can adjust from **0** to **32** on **Advanced Control** of **ADV. PICTURE**.
- You can use this function through the **MENU** button.
- To exit the menu display, press the **EXIT** button.

TruMotion Demo Function

1. Press the **MENU** button. Then, move to **ADV. PICTURE** with the **^**, **v**, **<**, **>** buttons and press the **OK** button.
 2. Move to a sub-item with the **>** button. Then, use the **^**, **v** buttons to move to **TruMotion Demo** and press the **OK** button.
- Press the **MENU** or **EXIT** button to exit the menu screen.

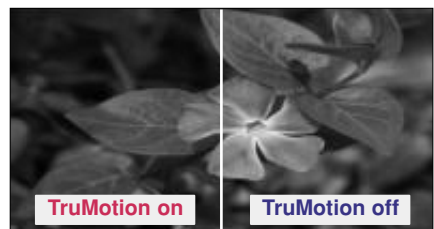
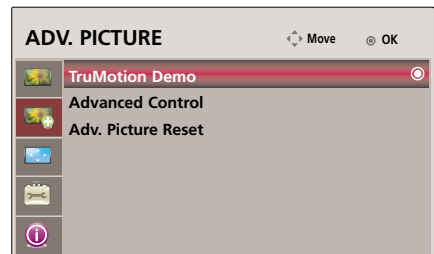

Advanced Control Function

1. Press the **MENU** button. Then, move to **ADV. PICTURE** with the $\wedge, \vee, <, >$ buttons and press the \odot **OK** button.
2. Move to a sub-item with the $>$ button. Then, use the \wedge, \vee buttons to move to **Advanced Control** and press the \odot **OK** button.
3. Move to a desired item with the \wedge, \vee buttons and then press the \odot **OK** button.
4. Use the $<, >$ buttons to make a desired adjustment and then press the \odot **OK** button.

- You can set image values differently for each input and **Picture Mode**.
- Press the **MENU** or **EXIT** button to exit the menu screen.

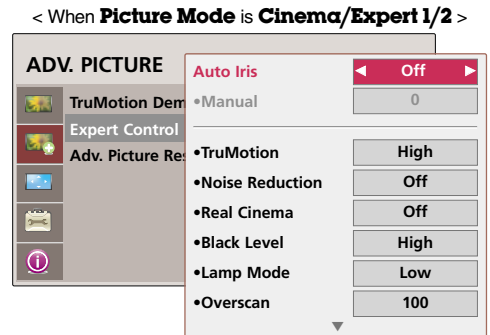
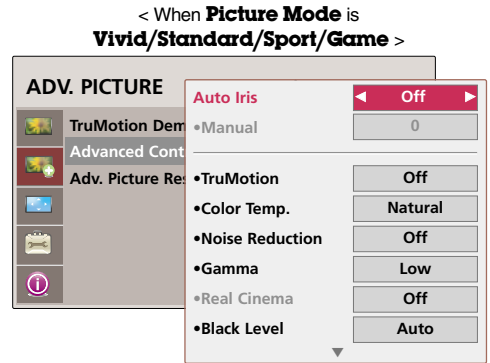

▶ **TruMotion** : Makes the moving image smoother through compensation.

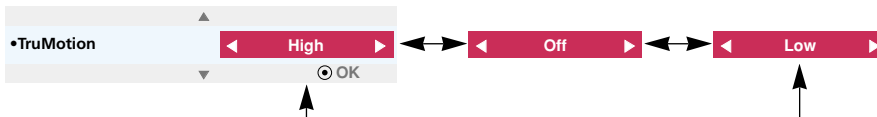

- This function cannot be set when PC signal is input.

▶ **Color Temp** : Selects the mood of screen colors.



- You can also use the **C.TEMP** button on the remote control.

▶ **Noise Reduction** : Removes noise from image without damaging it.

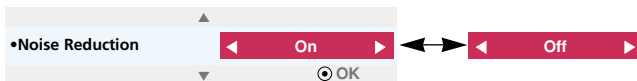

- You can use it only in **Video, S-Video, Component**(480i, 480p, 576i, 576p) and **HDMI**(480p, 576p) modes.

▶ **Gamma** : Sets the intensity of the picture.

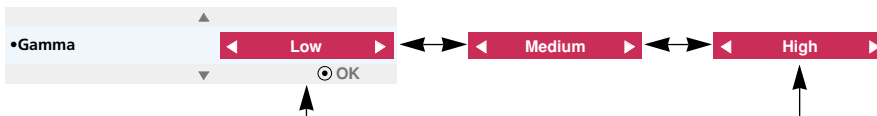

- You can also use the **GAMMA** button on the remote control.

▶ **Real Cinema** : Set up the picture for the best picture appearance for viewing movies.

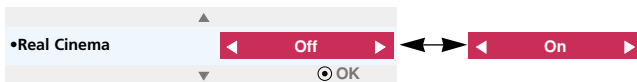

- You can use it only in **Video, S-Video, Component**(480i/576i/1080i 50/60Hz, 1080p 24Hz) and **HDMI**(1080i 50/60Hz, 1080p 24Hz) modes.

▶ **Black Level** : Adjusting the contrast and the brightness of the screen using the black level of the screen.

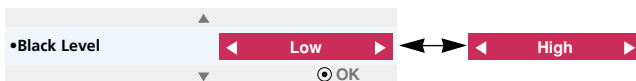

- You cannot set this function in SECAM, PAL 60 and PAL BGDK signals of **Video, S-Video** and **RGB** modes.

- ▶ **Lamp Mode** : Adjusts the lamp brightness.



- ▶ **Overscan** : You can adjust from **90, 92, 94...100**.



- This function cannot be set when the signal is 1080i and 1080p or **Aspect Ratio** is set as **Justscan**.
- Noise can occur at the edges of the screen at the signal of 1080i/1080p because of the malfunctioning of an image input device. In this case, change the signal into the one that can be set with **Overscan** and set **Overscan**.

- ▶ **Gamma Mode** : You can select this mode only when **Picture Mode** is **Cinema/Expert 1/2**.



- **Adjustment** : You can select **Low, Medium** or **High**.
- **Level** : You can adjust from **0** to **8**.
- **IRE** : Automatically set from **0** to **100** according to **Level** change.
- When you select **User** -> **Red/Green/Blue** : You can adjust from **-127** to **127**.

- ▶ **White Balance** : Adjusts the overall feeling of the screen to your choice. You can select this function only when **Picture Mode** is **Cinema/Expert 1/2**.

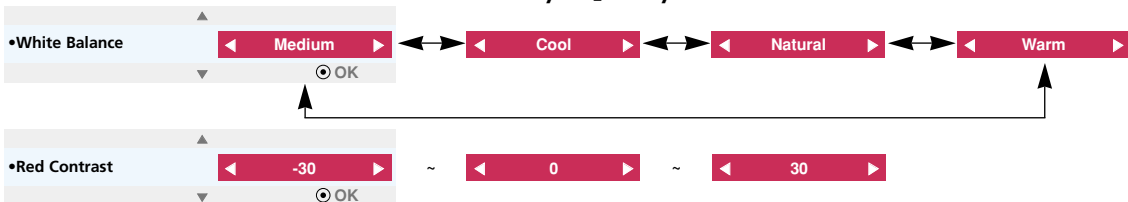

- **Red/Green/Blue Contrast** : You can adjust from **-30** to **30**.
- **Red/Green/Blue Brightness** : You can adjust from **-30** to **30**.

Advanced Picture Reset Function

* Settings of the selected **ADV PICTURE** function for each input and **Picture Mode** return to the default factory settings.

1. Press the **MENU** button. Then, move to **ADV. PICTURE** with the $\wedge, \vee, <, >$ buttons and press the \odot **OK** button.
2. Move to a sub-item with the $>$ button. Then, use the \wedge, \vee buttons to move to **Adv. Picture Reset** and press the \odot **OK** button.
3. Move to **Yes** with the $<, >$ buttons and then press the \odot **OK** button.
 - Press the **MENU** or **EXIT** button to exit the menu screen.

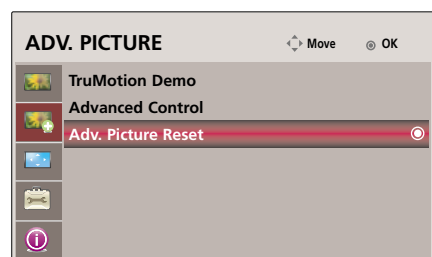

SCREEN Menu Options

To Change PJT Mode

* This function turns the projected image upside down or flips horizontal.

1. Press the **MENU** button. Then, move to **SCREEN** with the $\wedge, \vee, <, >$ buttons and press the \odot **OK** button.
2. Move to a sub-item with the $>$ button. Then, use the \wedge, \vee buttons to move to **PJT Mode** and press the \odot **OK** button.
3. Move to a desired item with the \wedge, \vee buttons and then press the \odot **OK** button.

- Select **Rear** when projecting from the back of the transparent screen purchased separately.
- Select **Ceiling** when installing the product on the ceiling.
- Press the **MENU** or **EXIT** button to exit the menu screen.

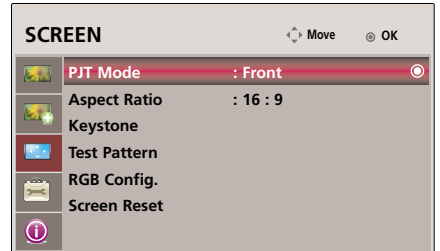

Using Aspect Ratio Function

1. Press the **RATIO** button on the remote control.
2. Use the $<, >$ buttons to select a desired screen size.

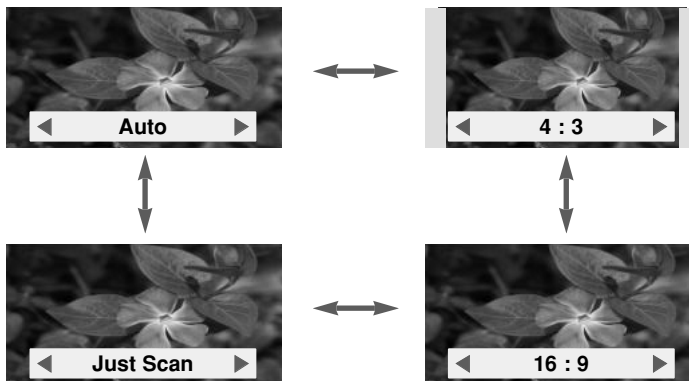

- Some options may not be available depending on input signals.
- You can use this function through the **MENU** button.
- To exit the menu display, press the **EXIT** button.

Using Keystone Function

* Use this function when the screen is not at a right angle to the projector and the image is a trapezoid shape.

* Only use the **Keystone** function when you can't get the best angle of projection.

1. Press the **KEYSTONE** button of remote control.
2. Move to a desired item with the \wedge , \vee buttons and then press the $>$ button.
3. Press the \wedge , \vee , $<$, $>$ button to adjust the screen condition as you want and then press the **OK** button.
 - **Keystone** can be adjusted from -100 to 100.
 - Execute **Reset** to restore back to default factory settings.
 - You can use this function through the **MENU** button.
 - To exit the menu display, press the **EXIT** button.

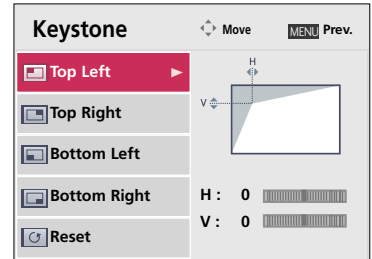

Test Pattern Function

* Execute this function when installing the projector to adjust the screen size and focus.

Press the **PATTERN** button of remote control.

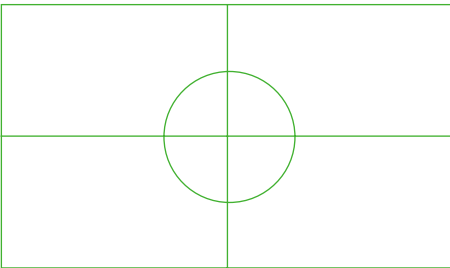

- You can use this function through the **MENU** button.
- To exit the menu display, press the **EXIT** button.

Auto configure Function

* This function assures you of getting the best video quality by automatically adjusting the horizontal size and synchronization of the image.

* Auto Tracking function works in RGB PC input only.

1. Press the **AUTO** button of the remote controller.
 - Image positioning and synchronization are automatically adjusted.
2. After automatic adjustments, if further manual adjustments are needed depending on PC **RGB Config.** on the **SCREEN** menu. In certain circumstances, you can't get the best picture quality by only using auto-correction.

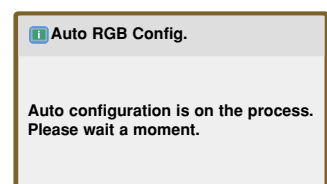

Note!

You can also use this function by using the **MENU** button. (Only in RGB mode)
For best results, perform this function while displaying a still image.

RGB Config. Function

1. Press the **MENU** button. Then, move to **SCREEN** with the $\wedge, \vee, <, >$ buttons and press the **OK** button.
2. Move to a sub-item with the $>$ button. Then, use the \wedge, \vee buttons to move to **RGB Config.** and press the **OK** button.
3. Move to a desired item with the \wedge, \vee buttons and then press the $>$ button.
4. Press the $\wedge, \vee, <, >$ button to adjust the screen condition as you want and then press the **OK** button.

- The **Auto Configure** function operates only for RGB input. If you execute screen adjustment for a video from PC graphic signal, optimal state may not be found. Execute the **Auto Configure** function for a still image.
- The variable range can be different depends on input resolutions.
- To exit the menu display, press the **EXIT** button.

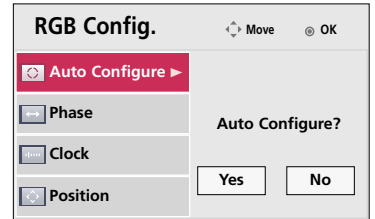

Screen Reset Function

* Settings of the selected **SCREEN** modes return to the default factory settings.

1. Press the **MENU** button. Then, move to **SCREEN** with the $\wedge, \vee, <, >$ buttons and press the **OK** button.
2. Move to a sub-item with the $>$ button. Then, use the \wedge, \vee buttons to move to **Screen Reset** and press the **OK** button.
3. Move to **Yes** with the $<, >$ buttons and then press the **OK** button.

- **Keystone** function is not reset.
- Press the **MENU** or **EXIT** button to exit the menu screen.

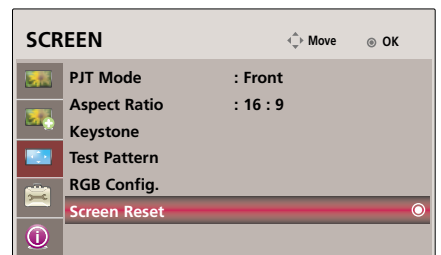

OPTION Menu Options

Using Still Function

1. Press the **STILL** button on the remote control.

* You can freeze the moving image.



2. To exit STILL, press any button.

* The STILL function will release automatically after approximately 10 minutes.

Selecting Language

1. Press the **MENU** button. Then, move to **OPTION** with the \wedge , \vee , \lt , \gt buttons and press the \odot OK button.
2. Move to a sub-item with the \gt button. Then, use the \wedge , \vee buttons to move to **Language** and press the \odot OK button.
3. Move to a desired item with the \wedge , \vee buttons and then press the \odot OK button.

- On-Screen-Display (OSD) is displayed in the selected language.
- Press the **MENU** or **EXIT** button to exit the menu screen.

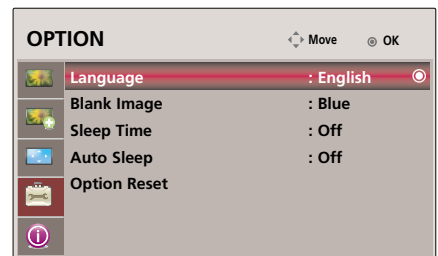

Using Blank Function

* This function may be effective if you need to get the attention of the audience during presentations, meetings or briefings.

1. Press the **BLANK** button on the remote control.

- The screen turns off to a background color.
- You can choose the background color.
(Refer to 'Selecting Blank image color')

2. Press any button to cancel the blank function.

- To temporarily turn off the lamp, press BLANK on the remote control. Do not block the projection lens with any objects when the projector is under operation as this could cause the objects to become heated and deformed or even cause a fire.

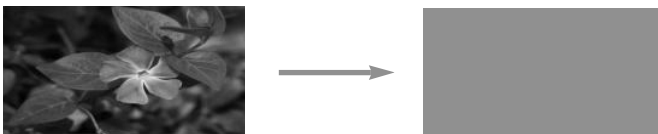

Selecting Blank image color

1. Press the **MENU** button. Then, move to **OPTION** with the $\wedge, \vee, <, >$ buttons and press the **OK** button.
2. Move to a sub-item with the $>$ button. Then, use the \wedge, \vee buttons to move to **Blank Image** and press the **OK** button.
3. Move to a desired item with the \wedge, \vee buttons and then press the **OK** button.
 - Background color will be altered to the selected Blank function color.
 - Press the **MENU** or **EXIT** button to exit the menu screen.

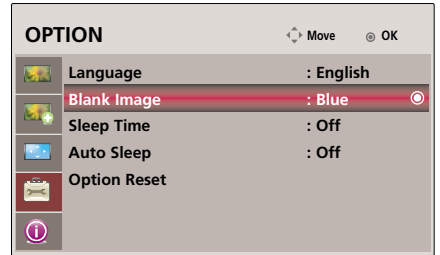

Sleep time Function

* The sleep timer turns the projector off at the preset time.

1. Press the **SLEEP** button of remote control.
2. Press the $<, >$ button to select the desired preset time.
 - Each press of the $<, >$ button changes the screen as shown below.

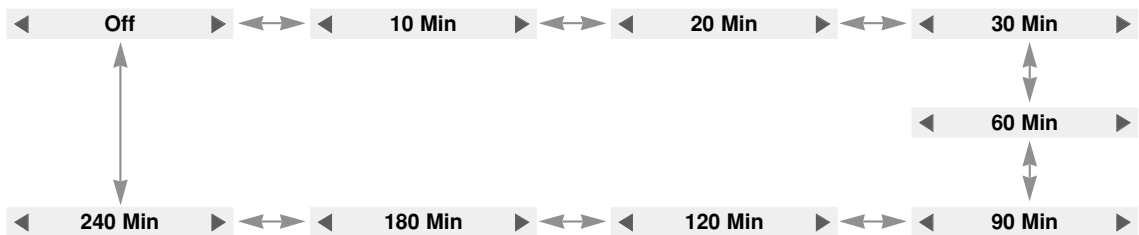

- You can use this function through the **MENU** button.
- To exit the menu display, press the **EXIT** button.

Auto sleep Function

* This function turns the projector off automatically after 10 minutes is passed when there is no signal.

1. Press the **MENU** button. Then, move to **OPTION** with the $\wedge, \vee, <, >$ buttons and press the \odot **OK** button.
2. Move to a sub-item with the $>$ button. Then, use the \wedge, \vee buttons to move to **Auto Sleep** and press the \odot **OK** button.
3. Move to **On** with the $<, >$ buttons and then press the \odot **OK** button.
 - Press the **MENU** or **EXIT** button to exit the menu screen.

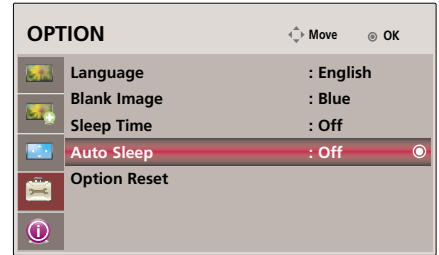

Option Reset Function

* Settings of the selected **OPTION** modes return to the default factory settings.

1. Press the **MENU** button. Then, move to **OPTION** with the $\wedge, \vee, <, >$ buttons and press the \odot **OK** button.
2. Move to a sub-item with the $>$ button. Then, use the \wedge, \vee buttons to move to **Option Reset** and press the \odot **OK** button.
3. Move to **Yes** with the $<, >$ buttons and then press the \odot **OK** button.
 - **Language** function is not reset.
 - Press the **MENU** or **EXIT** button to exit the menu screen.

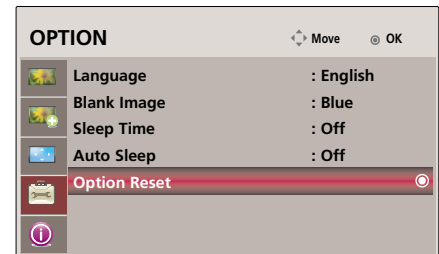

INFORMATION Menu Options

To See The Projector Information

1. Press the **MENU** button. Then, move to **INFORMATION** with the $\wedge, \vee, <, >$ buttons and press the \odot **OK** button.
2. You can see the current information of the projector.
 - Press the **MENU** or **EXIT** button to exit the menu screen.

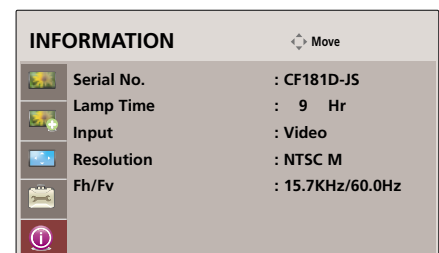

Supported Monitor Display

* The following table lists the display formats supported by the projector.

Format	Vertical Freq.(Hz)	Horizontal Freq.(kHz)
640X480	59.94Hz	31.469kHz
800X600	60.31Hz	37.879kHz
1024X768	60.00Hz	48.363kHz
1152X864	60.05Hz	54.348kHz
1280X720	59.855Hz	44.772kHz
1280X768	60.00Hz	47.693kHz
1280X960	60.00Hz	60.000kHz
1280X1024	60.02Hz	63.981kHz
1400X1050	59.978Hz	65.317kHz
1920X1080	60.00Hz	67.5kHz

* If the projector does not support the input signal, "Out of Range" message appears on the screen.

* The projector supports DDC1/2B type as Plug & Play function. (Auto recognition of PC monitor)

* The Synchronization input form for horizontal and vertical frequencies are Separate.

<DVD/DTV Input>

Signal	Component-*1	HDMI(DTV)-*2
60Hz	480i	O
	480p	O
	720p	O
	1080i	O
	1080p	O
50Hz	576i	O
	576p	O
	720p	O
	1080i	O
	1080p	O
24/25/30Hz	1080p	O

* Cable type
1- Component Cable
2- HDMI Cable

Maintenance

* The projector needs little maintenance. You should keep the lens clean because any dirt or stains may appear on the screen. If any parts need to be replaced, contact your dealer. When cleaning any part of the projector, always turn the power off and unplug the projector first.

Cleaning the lens

Clean the lens whenever you notice dirt or dust on the surface of it. Wipe the lens surface gently with an air spray or a soft, dry lint-free cloth. To remove dirt or stains on the lens, moisten a soft cloth with water and a neutral detergent and wipe the lens surface gently.

Cleaning the Projector Case

To clean the projector case, first unplug the power cable. To remove dirt or dust, wipe the casing with a soft, dry, lint-free cloth. To remove stubborn dirt or stains, moisten a soft cloth with water and a neutral detergent and then wipe the casing. Do not use alcohol, benzene, thinners or other chemical detergents as these can cause the casing to be warped or discolored.

Cleaning the Filter

When prompted to clean the filter while using the projector, take the following steps to clean it.

- 1 Turn off the projector and unplug the power cable. Turn it upside down and place it on a table or flat surface.

- 3 Turn the filter cover upside down, take the filter out and remove dust from it.

(When the filter is damaged, use additionally-provided new filter.)

- 2 Press as indicated by arrows with both hands and remove the filter cover.

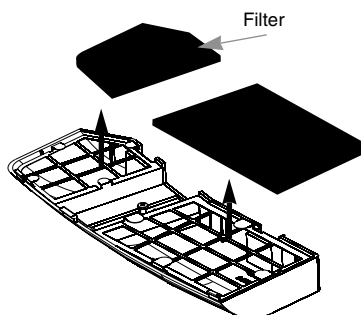
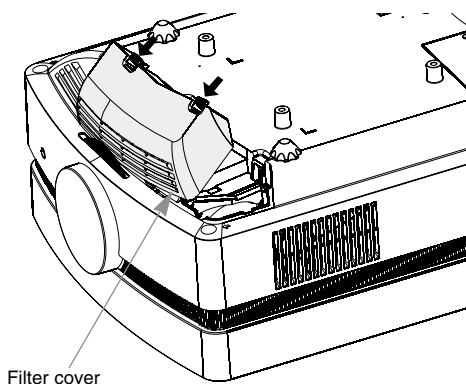

- 4 Insert the filter into the cover. Fit the cover onto the projector and press it until a click sound is heard.

Replacing the Lamp

Lamp Replacement

The change interval of lamp may depend on the use environment of Projector. You can see the used lamp time in the CHECKING LAMP TIME section of the Menu (page.29). You must replace the lamp when:

- The projected image gets darker or starts to deteriorate.
- The lamp indicator is red.
- The message “Replace the lamp” appears on the screen when turning the projector on.

<Top panel of the Projector>

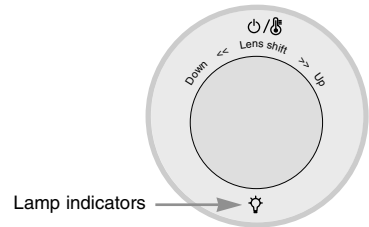

Be careful when replacing lamp

- Press the POWER button on the control panel or remote control to turn off power.
- If the operation indicator LED is orange and blinking, do not disconnect the main supply until the operation indicator LED is lit up constantly (red).
- Allow the lamp to cool for 1 hour before replacing it.
- Replace only with the same type lamp from an LG Electronics Service Center. Using another manufacturers lamp may cause damage to the Projector and lamp.
- Pull out the lamp only when replacing the lamp.
- Keep the lamp unit out of reach of children. Keep the Lamp away from heat sources such as radiators, stoves etc.
- To reduce the risk of fire do not expose the lamp to liquids or foreign materials.
- Do not place the lamp near any heat source.
- Make sure the new lamp is securely tightened with screws. If not, the image may be dark or there could be an increased risk of fire.
- Never touch the glass on the lamp. Image quality may be compromised or lamp life maybe reduced.

To obtain a replacement Lamp unit

Lamp model number is on page 35. Check the lamp model and then purchase it from an LG Electronics Service Center. Using another manufacturers lamp may cause damage to the projector.

Lamp unit disposal

Dispose of the used lamp by returning it to the LG Electronics Service Center.

Replacing the Lamp

- 1 Turn off the projector and unplug the power cable. Carefully place on a cushioned surface.

(Allow the lamp to cool for 1 hour before removing the used lamp from the projector.)

- 3 After lifting the lamp cover off, remove the two retaining screws on the lamp case with a screwdriver.

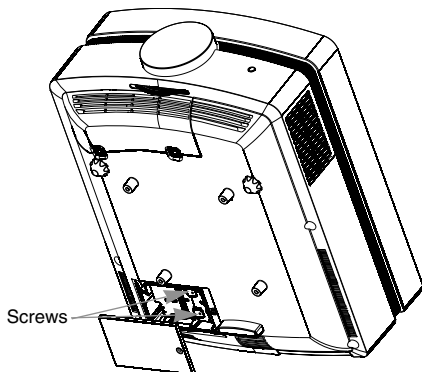

- 5 Pull out the handle slowly and remove the lamp case.

- 7 Tighten the screws you removed in step 3.

(Make sure they are fixed firmly.)

- 2 Unscrew the screw from the lamp cover using a screwdriver.

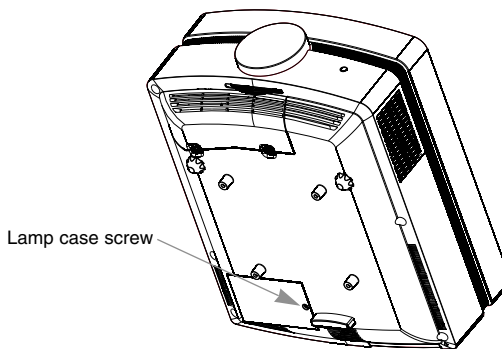

- 4 Lift the lamp up from the projector.

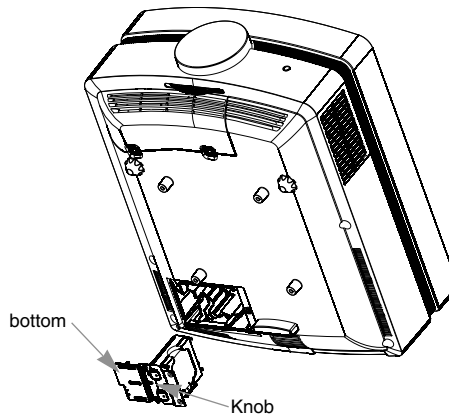

- 6 Insert the new lamp gently into the correct position. Push the lamp bottom to check if it is correctly installed.

- 8 Close the lamp cover and install the screws from step 2 to install the cover.

(If the lamp cover is not installed correctly the unit will not power on.)

Note!

Using another manufacturers lamp may cause damage to the projector or lamp. Make sure the lamp cover is securely fastened. If the lamp cover is not installed correctly the unit will not power on. If this fault persists contact an LG Authorized Service Center.

Regarding the projector lamp control

WARNING

- Don't turn off the projector at least in 5 minutes after activating it.
 - The frequent On/Off changes may cause the lamp to deteriorate.
- Don't pull out the power cord while the projector or the cooling fan are running.
 - It may shorten the life of the lamp.
- The life-span of depends on the environment its used in and how well its treated.
- The projector uses a high pressure mercury lamp. Shock or abuse to the projector can cause the lamp to burst.
- Continuing to use a lamp the projector has indicated needs replacement may burst.
- If the lamp burst, perform the following:
 - Remove the power cord immediately.
 - Let some fresh air in immediately (Ventilation).
 - Have a service center check the projector's condition and replace the lamp.
 - Do not disassemble the projector.

Specifications

MODEL	CF181D (CF181D-JS)
Resolution	1920(Horizontal) x 1080(Vertical)pixel
Horizontal / Vertical Ratio	16 : 9 (horizontal:vertical)
LCOS panel size	0.61 inches
Screen size (Projection distance)	Wide : 30 ~ 300 inches(0.9 ~ 9.1m) Tele : 30 ~ 300 inches(1.6 ~ 16.4m)
Projection off-set ratio	120%
Remote control distance	12m
Zoom ratio	1:1.8
Video compatibility	NTSC/PAL/SECAM/NTSC4.43/PAL-M/PAL-N/PAL 60
Power	AC 100 - 240V~50/60Hz, 3.0A-1.2A
Height(mm/inches)	173/6.8
Breadth(mm/inches)	366/14.4
Length(mm/inches)	447.5/17.6
Weight(kg/pound)	9.8/21.6

Operating Condition

Temperature

In operation : 32~104°F(0°C~40°C)
In storage and transit : -4~140°F(-20°C~60°C)

Humidity

In operation : 0~ 75% relative humidity by dry hygrometer
Not in operation : 0 ~ 85% relative humidity by dry hygrometer

Projector Lamp

Lamp model

AJ-LAF1

Lamp power consumption

220W

