

SHARP®

DATA PROJECTOR

MODEL

XG-SV100W

XG-SV200X

OPERATION MANUAL

Conference Series

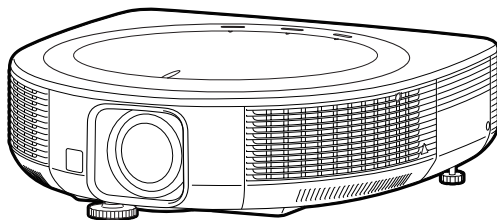

Introduction

Easy Start

Setup

Connections

Basic
Operation

Useful
Features

Appendix



IMPORTANT

- For your assistance in reporting the loss or theft of your Projector, please record the Model and Serial Number located on the bottom of the projector and retain this information.
- Before recycling the packaging, please ensure that you have checked the contents of the carton thoroughly against the list of “Supplied accessories” on page **11**.

Model No.:

Serial No.:

SPECIAL NOTE FOR USERS IN THE U.K.

The mains lead of this product is fitted with a non-rewireable (moulded) plug incorporating a 10A fuse. Should the fuse need to be replaced, a BSI or ASTA approved BS 1362 fuse marked  or  and of the same rating as above, which is also indicated on the pin face of the plug, must be used.

Always refit the fuse cover after replacing the fuse. Never use the plug without the fuse cover fitted.

In the unlikely event of the socket outlet in your home not being compatible with the plug supplied, cut off the mains plug and fit an appropriate type.

DANGER:

The fuse from the cut-off plug should be removed and the cut-off plug destroyed immediately and disposed of in a safe manner.

Under no circumstances should the cut-off plug be inserted elsewhere into a 13A socket outlet, as a serious electric shock may occur.

To fit an appropriate plug to the mains lead, follow the instructions below:

WARNING:

THIS APPARATUS MUST BE EARTHED.

IMPORTANT:

The wires in this mains lead are coloured in accordance with the following code:

Green-and-yellow	: Earth
Blue	: Neutral
Brown	: Live

As the colours of the wires in the mains lead of this apparatus may not correspond with the coloured markings identifying the terminals in your plug proceed as follows:

- The wire which is coloured green-and-yellow must be connected to the terminal in the plug which is marked by the letter E or by the safety earth symbol  or coloured green or green-and-yellow.
- The wire which is coloured blue must be connected to the terminal which is marked with the letter N or coloured black.
- The wire which is coloured brown must be connected to the terminal which is marked with the letter L or coloured red.

IF YOU HAVE ANY DOUBT, CONSULT A QUALIFIED ELECTRICIAN.

Authorized representative responsible for the European Union Community Market

SHARP ELECTRONICS (Europe) GmbH
Sonninstraße 3, D-20097 Hamburg

E.U. ONLY

The supplied CD-ROM contains operation instructions in English, German, French, Spanish, Italian, Dutch, Swedish, Portuguese, Chinese, Korean and Arabic. Carefully read through the operation instructions before operating the projector.

Die mitgelieferte CD-ROM enthält Bedienungsanleitungen in Englisch, Deutsch, Französisch, Spanisch, Italienisch, Niederländisch, Schwedisch, Portugiesisch, Chinesisch, Koreanisch und Arabisch. Bitte lesen Sie die Bedienungsanleitung vor der Verwendung des Projektors sorgfältig durch.

Le CD-ROM fourni contient les instructions de fonctionnement en anglais, allemand, français, espagnol, italien, néerlandais, suédois, portugais, chinois, coréen et arabe. Veuillez lire attentivement ces instructions avant de faire fonctionner le projecteur.

El CD-ROM suministrado contiene instrucciones de operación en inglés, alemán, francés, español, italiano, holandés, sueco, portugués, chino, coreano y árabe. Lea cuidadosamente las instrucciones de operación antes de utilizar el proyector.

Il CD-ROM in dotazione contiene istruzioni per l'uso in inglese, tedesco, francese, spagnolo, italiano, olandese, svedese, portoghese, cinese, coreano e arabo. Leggere attentamente le istruzioni per l'uso prima di usare il proiettore.

De meegeleverde CD-ROM bevat handleidingen in het Engels, Duits, Frans, Spaans, Italiaans, Nederlands, Zweeds, Portugees, Chinees, Koreaans en Arabisch. Lees de handleiding zorgvuldig door voor u de projector in gebruik neemt.

Den medföljande CD-ROM-skivan innehåller bruksanvisningar på engelska, tyska, franska, spanska, italienska, holländska, svenska, portugisiska, kinesiska, koreanska och arabiska. Läs noga igenom bruksanvisningen innan projektorn tas i bruk.

O CD-ROM fornecido contém instruções de operação em Inglês, Alemão, Francês, Espanhol, Italiano, Holandês, Sueco, Português, Chinês, Coreano e Árabe. Leia cuidadosamente todas as instruções de operação antes de operar o projetor.

附送之CD-ROM光碟中，有用英文、德文、法文、西班牙文、意大利文、荷蘭文、瑞典文、葡萄牙文、中文、韓國文和阿拉伯文所寫的使用說明書。在操作本投影機之前，請務必仔細閱讀整本使用說明書。

제공된 CD-ROM에는 영어, 독일어, 프랑스어, 스페인어, 이탈리아어, 네덜란드어, 스웨덴어, 포르투갈어, 중국어, 한국어, 아라비아어로 작성된 조작 설명서가 수록되어 있습니다. 프로젝터를 조작하기 전에 조작 지침을 상세하게 숙지하십시오.

يحتوي القرص المضغوط المرفق مع المنتج على تعليمات التشغيل باللغة الإنجليزية، الألمانية، الفرنسية، الإسبانية، الإيطالية، الهولندية، السويدية، البرتغالية، الصينية، الكورية والعربية. برجاء قراءة تعليمات التشغيل بعناية قبل الشروع في تشغيل جهاز الإسقاط.

Before using the projector, please read this operation manual carefully.

Introduction

ENGLISH

There are two important reasons for prompt warranty registration of your new SHARP Projector, using the REGISTRATION CARD packed with the projector.

1. WARRANTY

This is to assure that you immediately receive the full benefit of the parts, service and labor warranty applicable to your purchase.

2. CONSUMER PRODUCT SAFETY ACT

To ensure that you will promptly receive any safety notification of inspection, modification, or recall that SHARP may be required to give under the 1972 Consumer Product Safety Act, PLEASE READ CAREFULLY THE IMPORTANT "LIMITED WARRANTY" CLAUSE.



U.S.A. ONLY

WARNING: High brightness light source. Do not stare into the beam of light, or view directly. Be especially careful that children do not stare directly into the beam of light.



WARNING: To reduce the risk of fire or electric shock, do not expose this product to rain or moisture.

See bottom of projector.

	CAUTION RISK OF ELECTRIC SHOCK. DO NOT REMOVE SCREWS EXCEPT SPECIFIED USER SERVICE SCREW.	
CAUTION: TO REDUCE THE RISK OF ELECTRIC SHOCK, DO NOT REMOVE COVER. NO USER-SERVICEABLE PARTS EXCEPT LAMP UNIT. REFER SERVICING TO QUALIFIED SERVICE PERSONNEL.		



The lightning flash with arrowhead symbol, within an equilateral triangle, is intended to alert the user to the presence of uninsulated "dangerous voltage" within the product's enclosure that may be of sufficient magnitude to constitute a risk or electric shock to persons.



The exclamation point within a triangle is intended to alert the user to the presence of important operating and maintenance (servicing) instructions in the literature accompanying the product.

WARNING:

This is a Class A product. In a domestic environment this product may cause radio interference in which case the user may be required to take adequate measures.

WARNING: FCC Regulations state that any unauthorized changes or modifications to this equipment not expressly approved by the manufacturer could void the user's authority to operate this equipment.

U.S.A. ONLY

The enclosed computer cable must be used with the device. The cable is provided to ensure that the device complies with FCC Class A verification.

U.S.A. ONLY

INFORMATION

This equipment has been tested and found to comply with the limits for a Class A digital device, pursuant to Part 15 of the FCC Rules. These limits are designed to provide reasonable protection against harmful interference when the equipment is operated in a commercial environment. This equipment generates, uses, and can radiate radio frequency energy and, if not installed and used in accordance with the operation manual, may cause harmful interference to radio communications. Operation of this equipment in a residential area is likely to cause harmful interference, in which case the user will be required to correct the interference at his own expense.

U.S.A. ONLY

PRODUCT DISPOSAL

This product utilizes lamp containing a small amount of mercury. Disposal of these materials may be regulated due to environmental considerations. For disposal or recycling information, please contact your local authorities, the Electronics Industries Alliance: www.eiae.org, the lamp recycling organization www.lamprecycle.org, or Sharp at 1-800-BE-SHARP.

U.S.A. ONLY

Caution Concerning Lamp Replacement

- This projector utilizes a pressurized mercury lamp. A loud sound may indicate lamp failure. Lamp failure can be attributed to numerous sources such as: excessive shock, improper cooling, surface scratches or deterioration of the lamp due to a lapse of usage time.
The period of time up to failure largely varies depending on the individual lamp and/or the condition and the frequency of use. It is important to note that failure can often result in the bulb cracking.
- When the lamp replacement indicator and on-screen display icon are illuminated, it is recommended that the lamp be replaced with a new one immediately, even if the lamp appears to be operating normally.
- Should the lamp break, there is also a possibility that glass particles may spread inside of the projector. In such a case, it is recommended you contact your nearest Sharp Authorized Projector Dealer or Service Center to assure safe operation.
- Should the lamp break, the glass particles may spread inside the lamp cage or gas contained in the lamp may be vented into the room from the exhaust vent. Because the gas in this lamp includes mercury, ventilate the room well if the lamp breaks and avoid all exposure to the released gas. In case of exposure to the gas, consult a doctor as soon as possible.



Caution

- Do not remove the lamp unit from the projector right after use. The lamp will be very hot and may cause burns or injury.
 - Wait at least one hour after the power cord is disconnected to allow the surface of the lamp unit to fully cool before removing the lamp unit.
 - Do not touch the glass surface of the lamp unit or the inside of the projector.
 - Do not loosen other screws except for the lamp unit cover and lamp unit.
 - Make sure to reset the lamp timer only when replacing the lamp. If you reset the lamp timer and continue to use the same lamp, this may cause the lamp to become damaged or explode.
- **Carefully change the lamp by following the instructions described on pages 72 to 74.**
* **If you wish, you may have the lamp replaced at your nearest Sharp Authorized Projector Dealer or Service Center.**

* If the new lamp does not light after replacement, take your projector to the nearest Sharp Authorized Projector Dealer or Service Center for repair.

How to Read this Operation Manual

- The specifications are slightly different, depending on the model. However, you can connect and operate all models in the same manner.
- In this operation manual, the illustration and the screen display are simplified for explanation, and may differ slightly from the actual display.

Using the Menu Screen

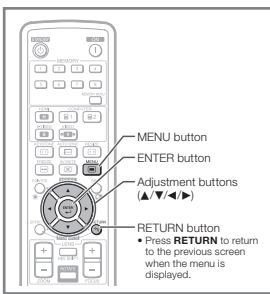
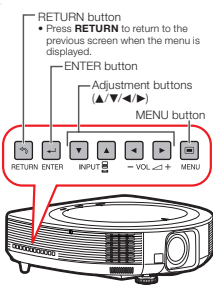

Buttons used in this operation

Menu Selections (Adjustments)

Example: Adjusting "Bright".
 • This operation can also be performed by using the buttons on the projector.

- 1 Press **MENU**.
 • The "Picture" menu screen for the selected input mode is displayed.
- 2 Press **▶** or **◀** and select "Picture" to adjust.

Example: "Picture" screen menu
 Menu item

Picture	Audio	SG	SCR	PRJ	Net
Picture Mode					
Contrast		0	100	100	100
Bright		0	100	100	100
Color		0	100	100	100
Tint		0	100	100	100
Sharp		0	100	100	100
Red		0	100	100	100
Blue		0	100	100	100
CLR Temp		0	100	100	100
BrilliantColor™		1	100	100	100
C.M.S.1					Off
C.M.S.2					Off
DNR					Level 2
Eco-Quiet					Off
◆◆Reset					
◆SEL./ADJ.					ENTER
◆RETURN					END

Button used in this step

On-screen display

InfoIndicates safeguards for using the projector.

Note Indicates additional information for setting up and operating the projector.

For Future Reference

Maintenance

Troubleshooting

Index

➔ P. 69

➔ PP. 81 to 83

➔ P. 87

Contents

Preparing

Introduction

How to Read this Operation Manual	3
Contents	4
IMPORTANT SAFEGUARDS	6
How to Access the PDF Operation Manuals.....	10
Accessories	11
Part Names and Functions.....	12
Side View	12
Top View	12
Front View	12
Rear View (Terminals).....	13
Inserting the Batteries.....	15
Usable Range.....	15

Easy Start

Easy Start	16
Setup and Projection	16

Setup

Setting Up the Projector	18
Video Setup.....	18
Setting Up the Projector	18
Standard Setup (Front Projection)	18
Screen Size and Projection Distance	19
Projection (PRJ) Mode	21
Ceiling-Mount Setup.....	21

Connections

Connecting the Projector to Other Equipment.....	22
Controlling the Projector by a Computer	25
Connecting the Power Cord.....	26

Using

Basic Operation

Turning the Projector On/Off	27
Turning the Projector On.....	27
Turning the Power Off (Putting the Projector into Standby Mode)	27
Image Projection	28
Shifting the Lens	28
Using the Adjustment Feet.....	29
Adjusting the Focus.....	30
Adjusting the Projected Image Size.....	30
Correcting Trapezoidal Distortion	31
Switching the Input Mode.....	34
Adjusting the Volume.....	35

Displaying the Black Screen and Turning Off the Sound Temporarily	35
Resize Mode	36

Useful Features

Operating with the Remote Control.....	40
Displaying and Setting the Break Timer	40
Displaying the Pointer	40
Using the Spot Function	40
Switching the Eco+Quiet Mode	40
Auto Sync (Auto Sync Adjustment)	41
Freezing a Moving Image.....	41
Selecting the Picture Mode.....	41
Displaying an Enlarged Portion of an Image	41
Using the Remote Control as the Wireless Computer Mouse.....	42
Menu Items.....	43
Using the Menu Screen	46
Menu Selections (Adjustments)	46
Picture Adjustment (“Picture” Menu)	48
Selecting the Picture Mode.....	48
Adjusting the Image.....	48
Adjusting the Color Temperature.....	49
Adjusting the Colors	49
Reducing Image Noise (DNR)	50
Eco+Quiet	50
Audio Adjustment (“Audio” Menu).....	51
Speaker Setting.....	51
Audio Input.....	51
Audio Output Type Setting.....	51
Adjusting the Audio	51
Signal Adjustment (“SIG” Menu)	52
Adjusting the Computer Image	52
Resolution Setting	52
Auto Sync Adjustment.....	52
Signal Type Setting	52
Setting the Video System	53
Setting the Video Setup.....	53
Selecting the Dynamic Range.....	53
Checking the Input Signal.....	53
Screen Adjustment (“SCR” Menu).....	54
Setting the Resize Mode.....	54
Selecting the Wall Color.....	54
Setting the Overscan	54
Setting the On-screen Display	54
Closed Caption	55
Selecting a Startup and Background Image	55
Reversing/Inverting Projected Images	55
Selecting the On-screen Display Language	55
Helpful Functions Set during Installation (“PRJ” menu)	56
Auto Power Off Function	56

Auto Restart Function.....	56
COMPUTER2 Select	56
STANDBY Mode.....	56
Selecting the Transmission Speed (RS-232C)	56
Fan Mode Setting	57
System Lock Function	57
Keylock Function	58
DLP® Link™	58
DLP® Link™ Invert	58
Memory Menu	59
Rotate Indicator	59
Returning to the Default Settings	60
Checking the Lamp Life Status	60
Setting Up the Projector Network	
Environment (“Net.” Menu)	61
Setting a Password	61
DHCP Client Setting	62
TCP/IP Setting	62
Returning to Default Settings (Network) ..	62
Restart Network Function	62
Confirming the Projector Information.....	63
Viewing Stereoscopic 3D Images.....	64
Precautions on Viewing Stereoscopic 3D Images	64
Information on the 3D Projection Function	66
Using 3D Viewing Mode	67
Appendix.....	68

Reference

Appendix

Maintenance.....	69
Maintenance Indicators	70
Regarding the Lamp.....	72
Lamp.....	72
Caution Concerning the Lamp.....	72
Replacing the Lamp	72
Removing and Installing the Lamp Unit.....	73
Resetting the Lamp Timer	74
Compatibility Chart	75
Attaching the Ceiling-mount Rotating Module (AN-SV100T).....	77
Attaching the Terminal Cover to the Module	78
Attaching the Ceiling Mount to the Ceiling	79
Troubleshooting.....	81
For SHARP Assistance.....	84
Specifications.....	85
Dimensions.....	86
Index.....	87

IMPORTANT SAFEGUARDS

CAUTION: Please read all of these instructions before you operate this product and save these instructions for later use.

Electrical energy can perform many useful functions. This product has been engineered and manufactured to assure your personal safety. BUT IMPROPER USE CAN RESULT IN POTENTIAL ELECTRICAL SHOCK OR FIRE HAZARDS. In order not to defeat the safeguards incorporated in this product, observe the following basic rules for its installation, use and servicing.

1. Read Instructions

All the safety and operating instructions should be read before the product is operated.

2. Retain Instructions

The safety and operating instructions should be retained for future reference.

3. Heed Warnings

All warnings on the product and in the operating instructions should be adhered to.

4. Follow Instructions

All operating and use instructions should be followed.

5. Cleaning

Unplug this product from the wall outlet before cleaning. Do not use liquid cleaners or aerosol cleaners. Use a damp cloth for cleaning.

6. Attachments

Do not use attachments not recommended by the product manufacturer as they may cause hazards.

7. Water and Moisture

Do not use this product near water—for example, near a bath tub, wash bowl, kitchen sink, or laundry tub; in a wet basement; or near a swimming pool; and the like.

8. Accessories

Do not place this product on an unstable cart, stand, tripod, bracket, or table. The product may fall, causing serious injury to a child or adult, and serious damage to the product. Use only with a cart, stand, tripod, bracket, or table recommended by the manufacturer, or sold with the product. Any mounting of the product should follow the manufacturer's instructions, and should use a mounting accessory recommended by the manufacturer.

9. Transportation

A product and cart combination should be moved with care. Quick stops, excessive force, and uneven surfaces may cause the product and cart combination to overturn.



10. Ventilation

Slots and openings in the cabinet are provided for ventilation to ensure reliable operation of the product and to protect it from overheating, and these openings must not be blocked or covered. The openings should never be blocked by placing the product on a bed, sofa, rug, or other similar surface. This product should not be placed in a built-in installation such as a bookcase or rack unless proper ventilation is provided or the manufacturer's instructions have been adhered to.

11. Power Sources

This product should be operated only from the type of power source indicated on the marking label. If you are not sure of the type of power supply to your home, consult your product dealer or local power company. For products intended to operate from battery power, or other sources, refer to the operating instructions.

12. Grounding or Polarization

This product is provided with one of the following types of plugs. If the plug should fail to fit into the power outlet, please contact your electrician.

Do not defeat the safety purpose of the plug.

- Two-wire type (mains) plug.
- Three-wire grounding type (mains) plug with a grounding terminal.
This plug will only fit into a grounding type power outlet.

13. Power-Cord Protection

Power-supply cords should be routed so that they are not likely to be walked on or pinched by items placed upon or against them, paying particular attention to cords at plugs, convenience receptacles, and the point where they exit from the product.

14. Lightning

For added protection for this product during a lightning storm, or when it is left unattended and unused for long periods of time, unplug it from the wall outlet and disconnect the cable system. This will prevent damage to the product due to lightning and power-line surges.

15. Overloading

Do not overload wall outlets, extension cords, or integral convenience receptacles as this can result in a risk of fire or electric shock.

16. Object and Liquid Entry

Never push objects of any kind into this product through openings as they may touch dangerous voltage points or short-out parts that could result in a fire or electric shock.

Never spill liquid of any kind on the product.

17. Servicing

Do not attempt to service this product yourself as opening or removing covers may expose you to dangerous voltage or other hazards. Refer all servicing to qualified service personnel.

18. Damage Requiring Service

Unplug this product from the wall outlet and refer servicing to qualified service personnel under the following conditions:

- When the power-supply cord or plug is damaged.
- If liquid has been spilled, or objects have fallen into the product.
- If the product has been exposed to rain or water.
- If the product does not operate normally by following the operating instructions. Adjust only those controls that are covered by the operating instructions, as an improper adjustment of other controls may result in damage and will often require extensive work by a qualified technician to restore the product to normal operation.

- If the product has been dropped or damaged in any way.
- When the product exhibits a distinct change in performance, this indicates a need for service.

19. Replacement Parts

When replacement parts are required, be sure the service technician has used replacement parts specified by the manufacturer or have the same characteristics as the original part. Unauthorized substitutions may result in fire, electric shock, or other hazards.

20. Safety Check

Upon completion of any service or repairs to this product, ask the service technician to perform safety checks to determine that the product is in proper operating condition.

21. Wall or Ceiling Mounting

This product should be mounted to a wall or ceiling only as recommended by the manufacturer.

22. Heat

This product should be situated away from heat sources such as radiators, heat registers, stoves, or other products (including amplifiers) that produce heat.

- DLP® and the DLP logo are registered trademarks of Texas Instruments and BrilliantColor™ and DLP® Link™ are trademarks of Texas Instruments.
- Microsoft® and Windows® are registered trademarks of Microsoft Corporation in the United States and/or other countries.
- PC/AT is a registered trademark of International Business Machines Corporation in the United States.
- Adobe® Reader® is a trademark of Adobe Systems Incorporated.
- Macintosh® is a registered trademark of Apple Computer, Inc. in the United States and/or other countries.
- HDMI, the HDMI logo and High-Definition Multimedia Interface are trademarks or registered trademarks of HDMI Licensing LLC.
- PJLink is a registered trademark or an application trademark in Japan, the United States, Canada, E.U., China and/or other countries/regions.
- All other company or product names are trademarks or registered trademarks of their respective companies.
- Some IC chips in this product include confidential and/or trade secret property belonging to Texas Instruments. Therefore you may not copy, modify, adapt, translate, distribute, reverse engineer, reverse assemble or discompile the contents thereof.

Observe the following safeguards when setting up your projector.

Caution concerning the lamp unit

- Potential hazard of glass particles if lamp ruptures. In case of lamp rupture, contact your nearest Sharp Authorized Projector Dealer or Service Center for replacement. See “Regarding the Lamp” on page 72.



Caution concerning the setup of the projector

- For minimal servicing and to maintain high image quality, SHARP recommends that this projector be installed in an area free from humidity, dust and cigarette smoke. When the projector is subjected to these environments, the vents and lens must be cleaned more often. As long as the projector is regularly cleaned, use in these environments will not reduce the overall operation life of the unit. Internal cleaning should only be performed by a Sharp Authorized Projector Dealer or Service Center.

Rest your eyes occasionally.

- Continuously watching the screen for long hours will cause eye strain. Take regular breaks to rest your eyes.

Do not set up the projector in places exposed to direct sunlight or bright light.

- Position the screen so that it is not in direct sunlight or room light. Light falling directly on the screen washes out the colors, making viewing difficult. Close the curtains and dim the lights when setting up the screen in a sunny or bright room.

Caution regarding placing of the projector

- Place the projector on a level site within the adjustment range (9 degrees) of the adjustment foot.

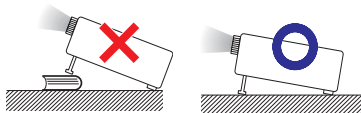

- After the projector is purchased, a faint smell from the vent may appear when the power is first turned on. This is normal and is not a malfunction. It will disappear after the projector is used for a while.

When using the projector in high-altitude areas such as mountains (at altitudes of approximately 1,500 meters (4,900 feet) or more)

- When you use the projector in high-altitude areas with thin air, set “Fan Mode” to “High”. Neglecting this can affect the longevity of the optical system.
- Use the projector at altitudes of 2,300 meters (7,500 feet) or less.

Warning about placing the projector in a high position

- When placing the projector in a high position, make certain it is carefully secure to avoid personal injury caused by the projector falling down.

Do not subject the projector to hard impact and/or vibration.

- Protect the lens so as not to hit or damage the surface of the lens.

Avoid locations with extremes of temperature.

- The operating temperature of the projector is from 41°F to 95°F (+5°C to +35°C).
- The storage temperature of the projector is from -4°F to 140°F (-20°C to +60°C).

Do not block the exhaust and intake vents.

- Allow at least 11 ¹³/₁₆ inches (30 cm) of space between the exhaust vent and the nearest wall or obstruction.
- Ensure that the intake vent and the exhaust vent are not obstructed.
- If the cooling fan becomes obstructed, a protection circuit will automatically put the projector into Standby mode to prevent overheat damage. This does not indicate a malfunction. (See pages 70 and 71.) Remove the projector power cord from the wall outlet and wait at least 10 minutes. Place the projector where the intake and exhaust vents are not blocked, plug the power cord back in and turn on the projector. This will return the projector to the normal operating condition.

Caution regarding usage of the projector

- If you are not to use the projector for a long time or before moving the projector, make certain you unplug the power cord from the wall outlet, and disconnect any other cables connected to it.
- Do not carry the projector by holding the lens.
- When storing the projector, ensure you attach the lens cover to the projector.
- Do not expose the projector to direct sunlight or place next to heat sources. Doing so may affect the cabinet color or cause deformation of the plastic cover.

Other connected equipment

- When connecting a computer or other audio-visual equipment to the projector, make the connections AFTER unplugging the power cord of the projector from the AC outlet and turning off the equipment to be connected.
- Please read the operation manuals of the projector and the equipment to be connected for instructions on how to make the connections.

Using the projector in other countries

- The power supply voltage and the shape of the plug may vary depending on the region or country you are using the projector in. When using the projector overseas, make sure you use an appropriate power cord for the country you are in.

Temperature monitor function



- If the temperature inside the projector increases, due to blockage of the air vents, or the setting location, the temperature warning indicator will blink. And if the temperature keeps on rising, “ TEMP.” will illuminate in the lower left corner of the picture with the temperature warning indicator blinking. If this state continues, the lamp will turn off, the cooling fan will run and then the projector will enter Standby mode. Refer to “Maintenance Indicators” on pages 70 and 71 for details.

Info

- The cooling fan regulates the internal temperature, and its performance is automatically controlled. The sound of the fan may change during projector operation due to changes in the fan speed. This does not indicate malfunction.

Closed Caption uses Bitstream Vera fonts

Copyright (c) 2003 by Bitstream, Inc. All Rights Reserved. Bitstream Vera is a trademark of Bitstream, Inc. Permission is hereby granted, free of charge, to any person obtaining a copy of the fonts accompanying this license (“Fonts”) and associated documentation files (the “Font Software”), to reproduce and distribute the Font Software, including without limitation the rights to use, copy, merge, publish, distribute, and/or sell copies of the Font Software, and to permit persons to whom the Font Software is furnished to do so, subject to the following conditions:

The above copyright and trademark notices and this permission notice shall be included in all copies of one or more of the Font Software typefaces.

The Font Software may be modified, altered, or added to, and in particular the designs of glyphs or characters in the Fonts may be modified and additional glyphs or characters may be added to the Fonts, only if the fonts are renamed to names not containing either the words “Bitstream” or the word “Vera”.

This License becomes null and void to the extent applicable to Fonts or Font Software that has been modified and is distributed under the “Bitstream Vera” names.

The Font Software may be sold as part of a larger software package but no copy of one or more of the Font Software typefaces may be sold by itself.

THE FONT SOFTWARE IS PROVIDED “AS IS”, WITHOUT WARRANTY OF ANY KIND, EXPRESS OR IMPLIED, INCLUDING BUT NOT LIMITED TO ANY WARRANTIES OF MERCHANTABILITY, FITNESS FOR A PARTICULAR PURPOSE AND NONINFRINGEMENT OF COPYRIGHT, PATENT, TRADEMARK, OR OTHER RIGHT. IN NO EVENT SHALL BITSTREAM OR THE GNOME FOUNDATION BE LIABLE FOR ANY CLAIM, DAMAGES OR OTHER LIABILITY, INCLUDING ANY GENERAL, SPECIAL, INDIRECT, INCIDENTAL, OR CONSEQUENTIAL DAMAGES, WHETHER IN AN ACTION OF CONTRACT, TORT OR OTHERWISE, ARISING FROM, OUT OF THE USE OR INABILITY TO USE THE FONT SOFTWARE OR FROM OTHER DEALINGS IN THE FONT SOFTWARE.

Except as contained in this notice, the names of Gnome, the Gnome Foundation, and Bitstream Inc., shall not be used in advertising or otherwise to promote the sale, use or other dealings in this Font Software without prior written authorization from the Gnome Foundation or Bitstream Inc., respectively. For further information, contact: fonts at gnome dot org.



How to Access the PDF Operation Manuals

PDF operation manuals in several languages are included in the CD-ROM. To utilize these manuals, you need to install Adobe® Reader® on your computer (Windows® or Macintosh®).

Please download Adobe® Reader® from the Internet (<http://www.adobe.com>).

Accessing the PDF Manuals

For Windows®:

- ① Insert the CD-ROM in the CD-ROM drive.
- ② Double click the “My Computer” icon.
- ③ Double click the “CD-ROM” drive.
- ④ **When you want to view the operation manual**
 - 1) Double click the “MANUALS” folder.
 - 2) Double click the language (name of the folder) that you want to view.
 - 3) Double click the pdf file to access the projector manuals.
- When you want to view the SETUP MANUAL**
 - 1) Double click the “SETUP” folder.
 - 2) Double click the language (name of the folder) that you want to view.
 - 3) Double click the pdf file to access the SETUP MANUAL.

For Macintosh®:

- ① Insert the CD-ROM in the CD-ROM drive.
- ② Double click the “CD-ROM” icon.
- ③ **When you want to view the operation manual**
 - 1) Double click the “MANUALS” folder.
 - 2) Double click the language (name of the folder) that you want to view.
 - 3) Double click the pdf file to access the projector manuals.
- When you want to view the SETUP MANUAL**
 - 1) Double click the “SETUP” folder.
 - 2) Double click the language (name of the folder) that you want to view.
 - 3) Double click the pdf file to access the SETUP MANUAL.

Note

- If the desired pdf file cannot be opened by double clicking the mouse, start Adobe® Reader® first, then specify the desired file using the “File”, “Open” menu.

SETUP MANUAL

Refer to the “SETUP MANUAL” contained on the supplied CD-ROM for details.

Connecting Pin Assignments	2
RS-232C Specifications and Commands	4
Operating the Projector Using the PJLink™ Protocol	10
Setting up the Projector Network Environment	11
Controlling the Projector via LAN	17
Resetting the Lamp Timer of the Projector via LAN	22
Troubleshooting	24

Accessories

Supplied accessories



Remote control
<RRMCGA960WJSA>



Two R-6 batteries
("AA" size, UM/SUM-3,
HP-7 or similar)

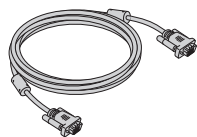

RGB cable
(10' (3.0 m))
<QCNWGA161WJPZ>

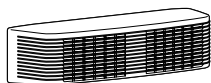

Terminal cover
<CCOVAE119WEF0>

Power cord*

(1)

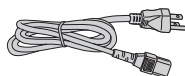

For U.S. and
Canada, etc.
(6' (1.8 m))

<QACCD A082WJPZ>

(2)

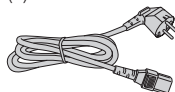

For Europe,
except U.K.
(6' (1.8 m))

<QACCV A024WJPZ>

(3)

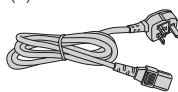

For U.K. and
Singapore
(6' (1.8 m))

<QACCB A104WJPZ>

(4)

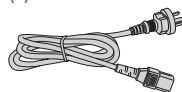

For Australia, New
Zealand and Oceania
(6' (1.8 m))

<QACCL A055WJPZ>

* Which power cords are supplied along with your projector depends on the region. Use the power cord that corresponds to the wall outlet in your country.

- Operation manuals (this manual <TINS-F099WJZZ> and CD-ROM <UDSKAA132WJZZ>)

Note

- Codes in "< >" are Replacement parts codes.

Optional accessories

- Lamp unit
- Ceiling-mount rotating module
- Ceiling-mount adaptor
- Ceiling-mount bracket
- Ceiling-mount unit
- Ceiling-mount extension tube

AN-SV10LP
AN-SV100T
AN-60KT
AN-XGCM55 (for U.S.A. only)
AN-TK201 <for AN-60KT>
AN-TK202 <for AN-60KT>
AN-EP101B <for AN-XGCM55>
(for U.S.A. only)

Note

- Some of the optional accessories may not be available depending on the region. Please check with your nearest Sharp Authorized Projector Dealer or Service Center.

Part Names and Functions

Numbers in refer to the main pages in this operation manual where the topic is explained.

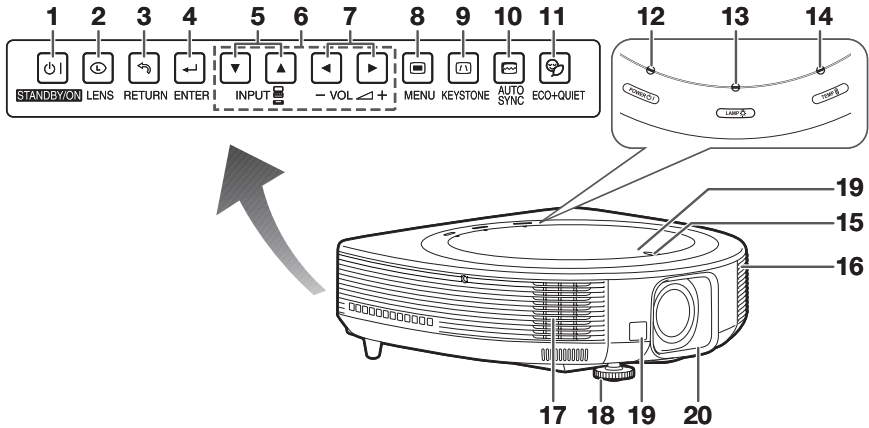

Side View

- 1** STANDBY/ON button 27
For turning the power on and putting the projector into Standby mode.
- 2** LENS button
For toggling the menu screens for adjustments of the lens (LENS SHIFT, FOCUS, ZOOM, etc.).
- 3** RETURN button 46
For returning to the previous menu screen during menu operations.
- 4** ENTER button 46
For setting items selected or adjusted on the menu.
- 5** INPUT buttons (▼/▲) 34
For switching Input mode.
- 6** Adjustment buttons (▲/▼/◀/▶) 46
For selecting menu items.
- 7** VOL +/- (Volume) buttons (◀/▶) 35
For adjusting the speaker sound level.
- 8** MENU button 46
For displaying adjustment and setting screens.
- 9** KEYSTONE button 31
For entering the Keystone Correction mode.

- 10** AUTO SYNC button 41
For automatically adjusting images when connected to a computer.
- 11** ECO+QUIET button 40
For lowering the noise of the cooling fan and extending the lamp life.

Top View

- 12** Power indicator 70
- 13** Lamp indicator 70
- 14** Temperature warning indicator 70

Front View

- 15** Rotate indicator 59
Turns on or blinks when the ceiling-mount rotating module (AN-SV100T) is connected.
- 16** Speaker 51
- 17** Exhaust vent 69
- 18** Adjustment foot 29
- 19** Remote control sensor 15
- 20** Lens cover 69

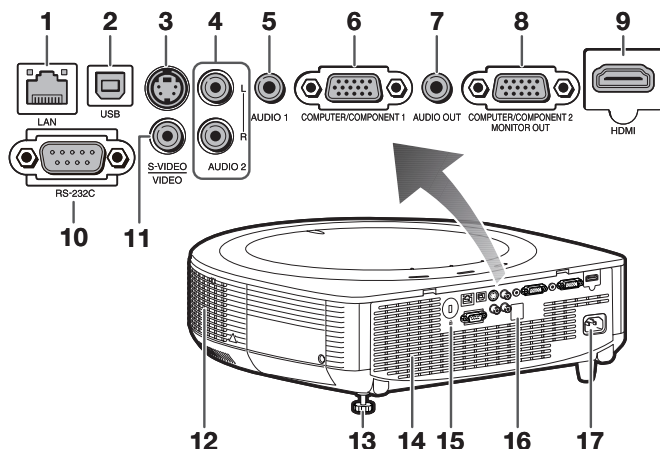

Rear View (Terminals)

- 1 LAN terminal **26**
Terminal for controlling the projector using a computer via network.
- 2 USB terminal **42**
Terminal connecting with the USB terminal on the computer for using the supplied remote control as the computer mouse.
- 3 S-VIDEO input terminal **23**
Terminal for connecting video equipment with an S-video terminal.
- 4 AUDIO 2 input terminal **24**
- 5 AUDIO 1 input terminal **24**
- 6 COMPUTER/COMPONENT 1 input terminal **22, 23**
Terminal for computer RGB and component signals.
- 7 AUDIO OUT terminal **24**
Audio output terminal of equipment connected to the audio input terminal.
- 8 MONITOR OUT* terminal **24**
(Output terminal for computer RGB and component signals)
Terminal for connecting a monitor.
COMPUTER/COMPONENT 2* input terminal **22, 23**
Terminal for computer RGB and component signals.
- 9 HDMI terminal **22, 23**
Terminal for HDMI input.
- 10 RS-232C terminal **25**
Terminal for controlling the projector using a computer.
- 11 VIDEO input terminal **23**
Terminal for connecting video equipment.
- 12 Exhaust vent **69**
- 13 Rear adjustment foot **29**
- 14 Intake vent **69**
- 15 Kensington Security Standard connector
- 16 Remote control sensor **15**
- 17 AC socket **26**
Connect the supplied power cord.

Using the Kensington Lock

- This projector has a Kensington Security Standard connector for use with a Kensington MicroSaver Security System. Refer to the information that came with the system for instructions on how to use it to secure the projector.

* You must switch the setting depending on whether you are using the terminal for MONITOR OUT or COMPUTER/COMPONENT 2 input.

Part Names and Functions (Continued)

Numbers in refer to the main pages in this operation manual where the topic is explained.

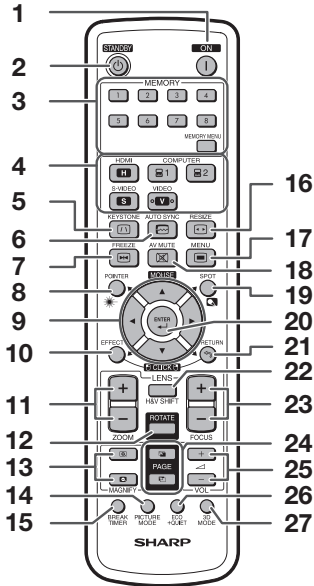

- 1 **ON button** 27
For turning the power on.
- 2 **STANDBY button** 27
For putting the projector into the Standby mode.
- 3 **MEMORY (1-8) buttons** 59
For displaying each "Load Memory" screen of "Memory Menu".
MEMORY MENU button 59
For displaying the Memory Menu screen.
- 4 **HDMI, COMPUTER 1/2, S-VIDEO, VIDEO buttons** 34
For switching to the respective input modes.
- 5 **KEYSTONE button** 31
For entering the Keystone Correction mode.
- 6 **AUTO SYNC button** 41
For automatically adjusting images when connected to a computer.
- 7 **FREEZE button** 41
For freezing images.
- 8 **POINTER button** 40
For displaying the pointer.
- 9 **MOUSE/Adjustment buttons** (▲/▼/◀/▶) 42, 46
 - For moving the computer cursor when with the USB connection (using a USB cable).
 - For selecting and adjusting menu items.

- 10 **L-CLICK/EFFECT button** 42, 40
 - For the Left click when with the USB connection (using a USB cable).
 - For changing the pointer or spot area.
- 11 **ZOOM buttons** 30
For adjusting the projected image size.
- 12 **ROTATE button**
For setting the rotation angle of the projector when the ceiling-mount rotating module (AN-SV100T) is connected.
- 13 **MAGNIFY buttons** 41
For enlarging/reducing part of the image.
- 14 **PICTURE MODE button** 41
For selecting the appropriate picture.
- 15 **BREAK TIMER button** 40
For displaying the break time.
- 16 **RESIZE button** 36
For switching the picture size (NORMAL, 16:9, etc.).
- 17 **MENU button** 46
For displaying adjustment and setting screens.
- 18 **AV MUTE button** 35
For temporarily displaying a black screen and turning off the sound.
- 19 **SPOT button** 40
For displaying the spotlight.
- 20 **ENTER button** 46
For setting items selected or adjusted on the menu.
- 21 **R-CLICK/RETURN button** 42, 46
 - For the Right click when with the USB connection (using a USB cable).
 - For returning to the previous menu screen during menu operations.
- 22 **H&V SHIFT button** 29
For shifting the lens horizontally and vertically.
- 23 **FOCUS buttons** 30
For adjusting the focus.
- 24 **PAGE UP/PAGE DOWN buttons** 42
Same as the [Page Up] and [Page Down] keys on a computer keyboard, when with the USB connection (using a USB cable).
- 25 **VOL +/- (Volume) buttons** 35
For adjusting the speaker sound level.
- 26 **ECO+QUIET button** 40
For lowering the noise of the cooling fan and extending the lamp life.
- 27 **3D MODE button** 67
For displaying the 3D mode menu screen.

Inserting the Batteries

1 Pull down the tab on the cover and remove the cover towards the direction of the arrow.

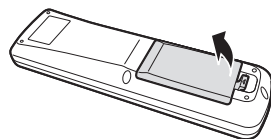

2 Insert the batteries.

- Insert the batteries making sure the polarities correctly match the \oplus and \ominus marks inside the battery compartment.

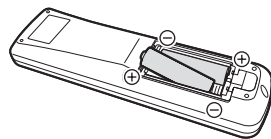

3 Insert the upper tab of the cover into the opening, and lower the cover until it clicks in place.

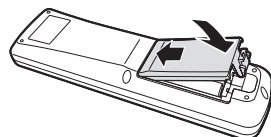

Incorrect use of the batteries may cause them to leak or explode. Please follow the precautions below



Caution

- Danger of explosion if battery is incorrectly replaced. Replace only with alkaline or manganese batteries.
- Insert the batteries making sure the polarities correctly match the \oplus and \ominus marks inside the battery compartment.
- Batteries of different types have different properties, therefore do not mix batteries of different types.
- Do not mix new and old batteries.
- This may shorten the life of new batteries or may cause old batteries to leak.
- Remove the batteries from the remote control once they have run out, as leaving them in can cause them to leak. Battery fluid from leaked batteries is harmful to skin, therefore ensure you wipe them first and then remove them using a cloth.
- The batteries included with this projector may run down in a short period, depending on how they are kept. Be sure to replace them as soon as possible with new batteries.
- Remove the batteries from the remote control if you will not be using the remote control for a long time.
- Comply with the rules (ordinance) of each local government when disposing of worn-out batteries.

Usable Range

The remote control can be used to control the projector within the ranges shown in the illustration.

Note

- Other remote control sensors are located on the rear and the top of the projector. (See pages 12 and 13.)
- The signal from the remote control can be reflected off a screen for easy operation. However, the effective distance of the signal may differ depending on the screen material.

When using the remote control

- Ensure that you do not drop it or expose it to moisture or high temperature.
- The remote control may malfunction under a fluorescent lamp. In this case, move the projector away from the fluorescent lamp.

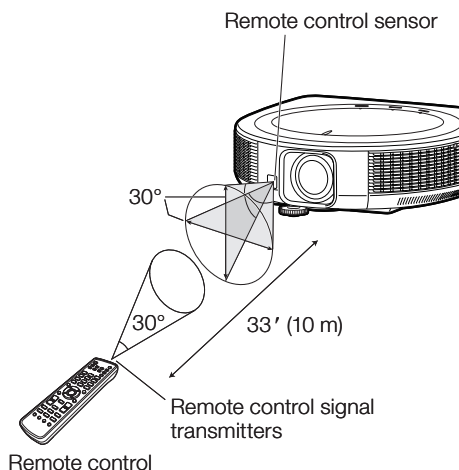

Easy Start

This section shows the basic operation (projector connecting with the computer). For details, see the page described below for each step.

Setup and Projection

In this section, connection of the projector and the computer is explained using one example.

3, 8 STANDBY/ON button

6, 7 ENTER button

6 ▼/▲ buttons, 7 INPUT buttons

6 ◀/▶ buttons

6 KEYSTONE button

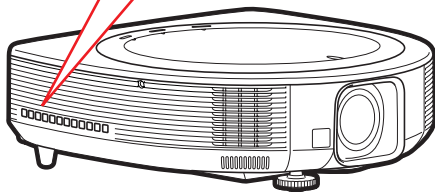
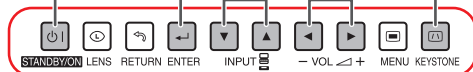

8 STANDBY button

3 ON button

7 HDMI, COMPUTER 1/2, S-VIDEO, VIDEO buttons

4, 6 Adjustment buttons (▲/▼/◀/▶)

6 ENTER button

3 H&V SHIFT button

5 FOCUS buttons

5 ZOOM buttons

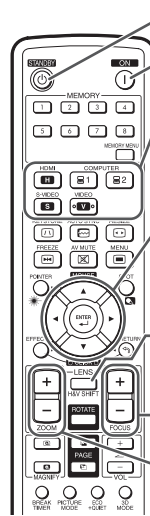

1. Place the projector facing a wall or a screen → P. 18

2. Connect the projector to the computer and plug the power cord into the AC socket of the projector

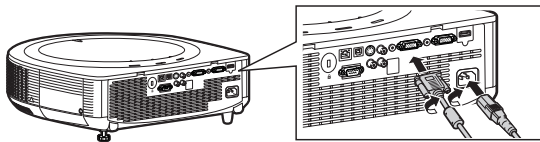

When connecting equipment other than a computer, see pages **23** and **24**.

→ PP. 22, 25, 26

3. Turn the projector on

Press **STANDBY/ON** on the projector or **ON** on the remote control.

→ P. 27

4. Adjust the angle

Adjust the projector angle:

- Shift the lens horizontally and vertically.
- 1 Press **H&V SHIFT** on the remote control.
 - 2 Press **▲**, **▼**, **◀** or **▶** on the remote control.
- Adjust the projector angle by rotating the adjustment feet.

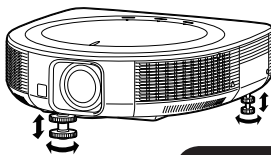

→ P. 29

5. Adjust the focus and the zoom

- 1 Press **FOCUS +/-** on the remote control to adjust the focus.
- 2 Press **ZOOM +/-** on the remote control to adjust the zoom.

→ P. 30

6. Correcting the image distortion due to the projection angle

- 1 Press **KEystone** on the projector or on the remote control.
- 2 Press **ENTER** on the projector or on the remote control.
- 3 Press **▲**, **▼**, **◀** or **▶** to move the position for the upper left of the image.
- 4 Press **ENTER** to set the position.
- 5 Repeat the same procedure with the positions for the upper right, lower right and lower left of the image.
 - When the position of the lower left is set, the correction is made and the display disappears.

→ P. 31

7. Select the Input mode

On the projector

Press **INPUT ▼/▲** to display the INPUT list. Use **INPUT ▼/▲** to select the Input mode, and use **◀/▶** to select the audio input terminal.

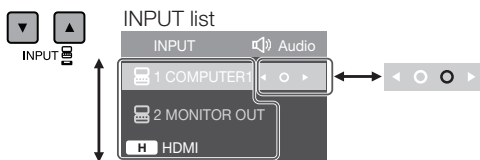

On the projector



On the remote control



On the remote control

Press **HDMI**, **COMPUTER 1/2**, **S-VIDEO**, **VIDEO** to select the Input mode.



→ P. 34

8. Turn the power off

Press **STANDBY/ON** on the projector or **STANDBY** on the remote control, and then press the button again while the confirmation message is displayed to put the projector into Standby mode.

On the projector



On the remote control



On-screen display

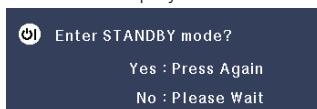

→ P. 27

Setting Up the Projector

Video Setup

If using this projector outside the U.S.A., please change setting to "0 IRE" in Video Setup. (See page 53.)

Setting Up the Projector

For optimal image quality, position the projector perpendicular to the screen with the projector's feet flat and level. Doing so will eliminate the need for Keystone correction and provide the best image quality. (See pages 31 to 33.)

Standard Setup (Front Projection)

- Place the projector at the required distance from the screen according to the desired picture size. (See pages 19 and 20.)

Indication of the Projection Image Size and Projection Distance

XG-SV200X

(Example: 4:3 Signal Input (Normal Mode))

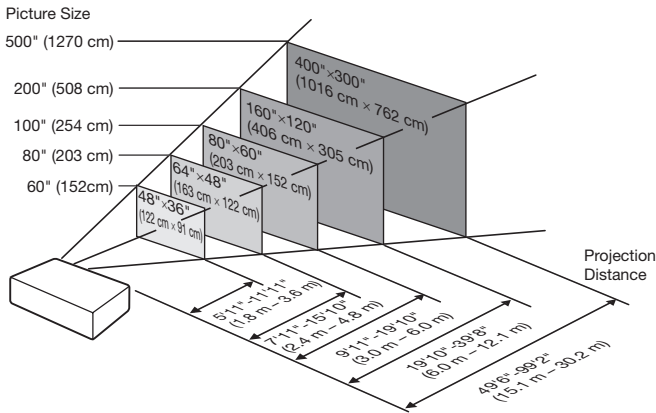

XG-SV100W

(Example: 16:10 Signal Input (Normal Mode))

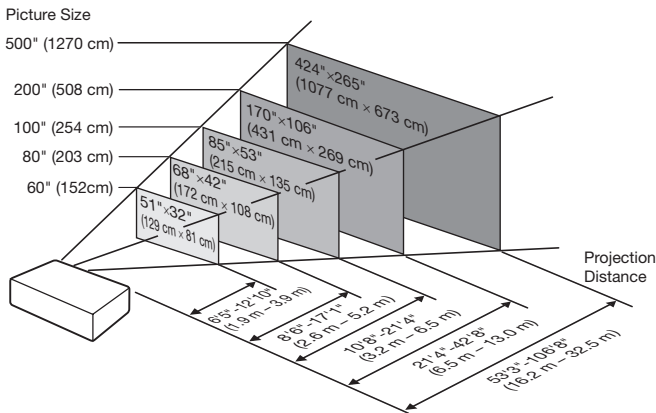

Screen Size and Projection Distance

[For XG-SV200X]

4:3 Signal Input (Normal Mode)

Picture (Screen) size			Projection distance [L]		Distance from the lens center to the bottom of the image [H]		Distance from the lens center to the center of the image[W]
Diagonal [χ]	Width	Height	Minimum [L1]	Maximum [L2]	Lower [H1]	Upper [H2]	
500" (1270 cm)	1016 cm (400")	762 cm (300")	15.1 m (49' 6")	30.2 m (99' 2")	-762 cm (-300")	0 cm (0")	±254 cm (±100")
400" (1016 cm)	813 cm (320")	610 cm (240")	12.1 m (39' 7")	24.2 m (79' 4")	-610 cm (-240")	0 cm (0")	±203 cm (±80")
300" (762 cm)	610 cm (240")	457 cm (180")	9.1 m (29' 8")	18.1 m (59' 6")	-457 cm (-180")	0 cm (0")	±152 cm (±60")
250" (635 cm)	508 cm (200")	381 cm (150")	7.5 m (24' 9")	15.1 m (49' 7")	-381 cm (-150")	0 cm (0")	±127 cm (±50")
200" (508 cm)	406 cm (160")	305 cm (120")	6.0 m (19' 10")	12.1 m (39' 8")	-305 cm (-120")	0 cm (0")	±102 cm (±40")
150" (381 cm)	305 cm (120")	229 cm (90")	4.5 m (14' 10")	9.1 m (29' 9")	-229 cm (-90")	0 cm (0")	±76 cm (±30")
120" (305 cm)	244 cm (96")	183 cm (72")	3.6 m (11' 11")	7.3 m (23' 10")	-183 cm (-72")	0 cm (0")	±61 cm (±24")
100" (254 cm)	203 cm (80")	152 cm (60")	3.0 m (9' 11")	6.0 m (19' 10")	-152 cm (-60")	0 cm (0")	±51 cm (±20")
80" (203 cm)	163 cm (64")	122 cm (48")	2.4 m (7' 11")	4.8 m (15' 10")	-122 cm (-48")	0 cm (0")	±41 cm (±16")
70" (178 cm)	142 cm (56")	107 cm (42")	2.1 m (6' 11")	4.2 m (13' 11")	-107 cm (-42")	0 cm (0")	±36 cm (±14")
60" (152 cm)	122 cm (48")	91 cm (36")	1.8 m (5' 11")	3.6 m (11' 11")	-91 cm (-36")	0 cm (0")	±30 cm (±12")
40" (102 cm)	81 cm (32")	61 cm (24")	1.2 m (4' 0")	2.4 m (7' 11")	-61 cm (-24")	0 cm (0")	±20 cm (±8")

16:9 Signal Input (16:9 Mode)

Picture (Screen) size			Projection distance [L]		Distance from the lens center to the bottom of the image [H]		Distance from the lens center to the center of the image[W]
Diagonal [χ]	Width	Height	Minimum [L1]	Maximum [L2]	Lower [H1]	Upper [H2]	
500" (1270 cm)	1107 cm (436")	623 cm (245")	16.4 m (53' 11")	32.9 m (108' 1")	-726 cm (-285 ^{59/64} ")	104 cm (40 ^{5/16} ")	±277 cm (±108 ^{29/32} ")
400" (1016 cm)	886 cm (349")	498 cm (196")	13.2 m (43' 2")	26.4 m (86' 5")	-581 cm (-228 ^{29/32} ")	83 cm (32 ^{11/16} ")	±221 cm (±87 ^{5/32} ")
300" (762 cm)	664 cm (261")	374 cm (147")	9.9 m (32' 4")	19.8 m (64' 10")	-436 cm (-171 ^{19/32} ")	62 cm (24 ^{29/64} ")	±166 cm (±65 ^{9/16} ")
250" (635 cm)	553 cm (218")	311 cm (123")	8.2 m (27' 0")	16.5 m (54' 0")	-363 cm (-143")	52 cm (20 ^{29/64} ")	±138 cm (±54 ^{15/32} ")
200" (508 cm)	443 cm (174")	249 cm (98")	6.6 m (21' 7")	13.2 m (43' 3")	-291 cm (-114 ^{29/64} ")	42 cm (16 ^{11/32} ")	±111 cm (±43 ^{37/64} ")
150" (381 cm)	332 cm (131")	187 cm (74")	4.9 m (16' 2")	9.9 m (32' 5")	-218 cm (-85 ^{51/64} ")	31 cm (12 ^{1/4} ")	±83 cm (±32 ^{11/16} ")
120" (305 cm)	266 cm (105")	149 cm (59")	3.9 m (12' 11")	7.9 m (25' 11")	-174 cm (-68 ^{41/64} ")	25 cm (9 ^{13/32} ")	±66 cm (±26 ^{9/64} ")
100" (254 cm)	221 cm (87")	125 cm (49")	3.3 m (10' 9")	6.6 m (21' 7")	-145 cm (-57 ^{19/64} ")	21 cm (8 ^{11/64} ")	±55 cm (±21 ^{51/64} ")
80" (203 cm)	177 cm (70")	100 cm (39")	2.6 m (8' 8")	5.3 m (17' 3")	-116 cm (-45 ^{5/16} ")	17 cm (6 ^{17/32} ")	±44 cm (±17 ^{1/16} ")
60" (152 cm)	133 cm (52")	75 cm (29")	2.0 m (6' 6")	4.0 m (13' 0")	-87 cm (-34 ^{5/16} ")	12 cm (4 ^{29/32} ")	±33 cm (±13 ^{5/64} ")
40" (102 cm)	89 cm (35")	50 cm (20")	1.3 m (4' 4")	2.6 m (8' 8")	-58 cm (-22 ^{7/16} ")	8 cm (3 ^{17/64} ")	±22 cm (±8 ^{23/32} ")

When using the projector with screen sizes not listed in the above charts, calculate the values according to the formulas.

	4:3 Signal		16:9 Signal	
	[m/cm]	[Feet/inches]	[m/cm]	[Feet/inches]
L1: Minimum projection distance (m/ft)	0.03018χ	0.03018χ / 0.3048	0.03288χ	0.03288χ / 0.3048
L2: Maximum projection distance (m/ft)	0.06047χ	0.06047χ / 0.3048	0.06588χ	0.06588χ / 0.3048
H1: Lower distance from the lens center to the bottom of the image (cm/in)	-1.524χ	-1.524χ / 2.54	-1.45281χ	-1.45281χ / 2.54
H2: Upper distance from the lens center to the bottom of the image (cm/in)	0χ	0χ / 2.54	0.20754χ	0.20754χ / 2.54
W: Distance from the lens center to the center of the image (cm/in)	±0.508χ	±0.508χ / 2.54	±0.55345χ	±0.55345χ / 2.54

χ : Picture diagonal size : 40"-500"

Note

- Allow a margin of error in the value in the diagrams above.
- When the distance from the lens center to the bottom of the image [H] is a negative number, this indicates that the bottom of the image is below the lens center.

Setting Up the Projector (Continued)

[For XG-SV100W]

16:10 Signal Input (Normal Mode)

Picture (Screen) size			Projection distance [L]		Distance from the lens center to the bottom of the image [H]		Distance from the lens center to the center of the image[W]
Diagonal [χ]	Width	Height	Minimum [L1]	Maximum [L2]	Lower [H1]	Upper [H2]	
500" (1270 cm)	1077 cm (424")	673 cm (265")	16.2 m (53' 3")	32.5 m (106' 8")	-673 cm (-265")	0 cm (0")	±255 cm (±100 ^{1/16} ")
400" (1016 cm)	862 cm (339")	538 cm (212")	13.0 m (42' 7")	26.0 m (85' 4")	-538 cm (-212")	0 cm (0")	±204 cm (±80 ^{23/64} ")
300" (762 cm)	646 cm (254")	404 cm (159")	9.7 m (32' 0")	19.5 m (64' 0")	-404 cm (-159")	0 cm (0")	±153 cm (±60 ^{17/64} ")
250" (635 cm)	538 cm (212")	337 cm (132")	8.1 m (26' 8")	16.3 m (53' 4")	-337 cm (-132 ^{1/2} ")	0 cm (0")	±128 cm (±50 ^{7/32} ")
200" (508 cm)	431 cm (170")	269 cm (106")	6.5 m (21' 4")	13.0 m (42' 8")	-269 cm (-106")	0 cm (0")	±102 cm (±40 ^{11/64} ")
150" (381 cm)	323 cm (127")	202 cm (79")	4.9 m (16' 0")	9.8 m (32' 0")	-202 cm (-79 ^{1/2} ")	0 cm (0")	±77 cm (±30 ^{9/64} ")
120" (305 cm)	258 cm (102")	162 cm (64")	3.9 m (12' 9")	7.8 m (25' 7")	-162 cm (-63 ^{19/32} ")	0 cm (0")	±61 cm (±24 ^{1/64} ")
100" (254 cm)	215 cm (85")	135 cm (53")	3.2 m (10' 8")	6.5 m (21' 4")	-135 cm (-53")	0 cm (0")	±51 cm (±20 ^{3/32} ")
80" (203 cm)	172 cm (68")	108 cm (42")	2.6 m (8' 6")	5.2 m (17' 1")	-108 cm (-42 ^{13/32} ")	0 cm (0")	±41 cm (±16 ^{3/64} ")
60" (152 cm)	129 cm (51")	81 cm (32")	1.9 m (6' 5")	3.9 m (12' 10")	-81 cm (-31 ^{51/64} ")	0 cm (0")	±31 cm (±12 ^{3/64} ")
40" (102 cm)	86 cm (34")	54 cm (21")	1.3 m (4' 3")	2.6 m (8' 6")	-54 cm (-21 ^{13/64} ")	0 cm (0")	±20 cm (±8 ^{1/32} ")

4:3 Signal Input (Normal Mode)

Picture (Screen) size			Projection distance [L]		Distance from the lens center to the bottom of the image [H]		Distance from the lens center to the center of the image[W]
Diagonal [χ]	Width	Height	Minimum [L1]	Maximum [L2]	Lower [H1]	Upper [H2]	
500" (1270 cm)	1016 cm (400")	762 cm (300")	18.4 m (60' 4")	36.8 m (120' 9")	-762 cm (-300")	0 cm (0")	±289 cm (±113 ^{5/7} ")
400" (1016 cm)	813 cm (320")	610 cm (240")	14.7 m (48' 3")	29.5 m (96' 8")	-610 cm (-240")	0 cm (0")	±231 cm (±90 ^{31/32} ")
300" (762 cm)	610 cm (240")	457 cm (180")	11.0 m (36' 2")	22.1 m (72' 6")	-457 cm (-180")	0 cm (0")	±173 cm (±68 ^{1/64} ")
250" (635 cm)	508 cm (200")	381 cm (150")	9.2 m (30' 2")	18.4 m (60' 5")	-381 cm (-150")	0 cm (0")	±144 cm (±56 ^{55/64} ")
200" (508 cm)	406 cm (160")	305 cm (120")	7.4 m (24' 1")	14.7 m (48' 4")	-305 cm (-120")	0 cm (0")	±116 cm (±45 ^{31/64} ")
150" (381 cm)	305 cm (120")	229 cm (90")	5.5 m (18' 1")	11.0 m (36' 3")	-229 cm (-90")	0 cm (0")	±87 cm (±34 ^{7/64} ")
120" (305 cm)	244 cm (96")	183 cm (72")	4.4 m (14' 6")	8.8 m (29' 0")	-183 cm (-72")	0 cm (0")	±69 cm (±27 ^{19/64} ")
100" (254 cm)	203 cm (80")	152 cm (60")	3.7 m (12' 1")	7.4 m (24' 2")	-152 cm (-60")	0 cm (0")	±58 cm (±22 ^{47/64} ")
80" (203 cm)	163 cm (64")	122 cm (48")	2.9 m (9' 8")	5.9 m (19' 4")	-122 cm (-48")	0 cm (0")	±46 cm (±18 ^{3/16} ")
70" (178 cm)	142 cm (56")	107 cm (42")	2.6 m (8' 5")	5.2 m (16' 11")	-107 cm (-42")	0 cm (0")	±40 cm (±15 ^{59/64} ")
60" (152 cm)	122 cm (48")	91 cm (36")	2.2 m (7' 3")	4.4 m (14' 6")	-91 cm (-36")	0 cm (0")	±35 cm (±13 ^{41/64} ")
40" (102 cm)	81 cm (32")	61 cm (24")	1.5 m (4' 10")	2.9 m (9' 8")	-61 cm (-24")	0 cm (0")	±23 cm (±9 ^{3/32} ")

When using the projector with screen sizes not listed in the above charts, calculate the values according to the formulas.

	16:10 Signal		4:3 Signal	
	[m/cm]	[Feet/inches]	[m/cm]	[Feet/inches]
L1: Minimum projection distance (m/ft)	0.03247χ	0.03247χ / 0.3048	0.03676χ	0.03676χ / 0.3048
L2: Maximum projection distance (m/ft)	0.06504χ	0.06504χ / 0.3048	0.07363χ	0.07363χ / 0.3048
H1: Lower distance from the lens center to the bottom of the image (cm/in)	-1.3462χ	-1.3462χ / 2.54	-1.524χ	-1.524χ / 2.54
H2: Upper distance from the lens center to the bottom of the image (cm/in)	0χ	0χ / 2.54	0χ	0χ / 2.54
W: Distance from the lens center to the center of the image (cm/in)	±0.51026χ	±0.51026χ / 2.54	±0.57765χ	±0.57765χ / 2.54

χ : Picture diagonal size : 40"-500"

Note

- Allow a margin of error in the value in the diagrams above.
- When the distance from the lens center to the bottom of the image [H] is a negative number, this indicates that the bottom of the image is below the lens center.

Projection (PRJ) Mode

The projector can use any of the 4 projection modes shown in the diagram below. Select the mode most appropriate for the projection setting in use. (You can set the PRJ mode in “SCR” menu. See page 55.)

- Table mounted, front projection
[Menu item → “Front”]

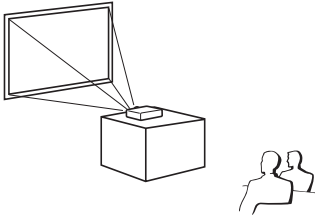

- Ceiling mounted, front projection
[Menu item → “Ceiling + Front”]

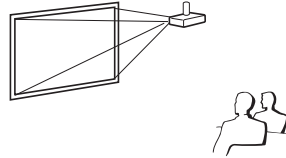

- Table mounted, rear projection
(with a translucent screen)
[Menu item → “Rear”]

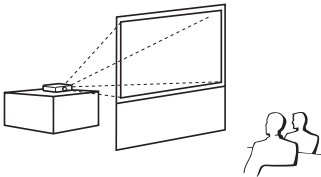

- Ceiling mounted, rear projection
(with a translucent screen)
[Menu item → “Ceiling + Rear”]

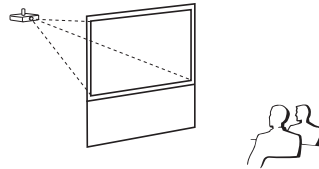

■ Ceiling-Mount Setup

It is recommended that you use the optional Sharp ceiling-mount adaptor and unit for this installation. Before mounting the projector, contact your nearest Sharp Authorized Projector Dealer or Service Center to obtain the recommended ceiling-mount adaptor and unit (sold separately).







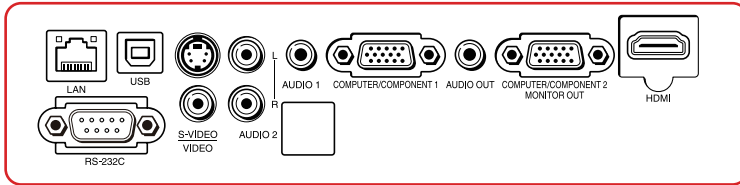

Connecting the Projector to Other Equipment

Before connecting, ensure that the power cord of the projector is unplugged from the AC outlet and turn off the equipment to be connected. After making all connections, turn on the projector and then the other pieces of equipment. When connecting a computer, ensure that it is the last equipment to be turned on after all the connections are made.

- For more details of connection and cables, refer to the operation manual of the connecting equipment.
- You may need other cables or connectors not listed below.



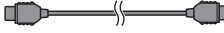









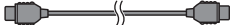











Terminals on the Projector

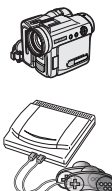
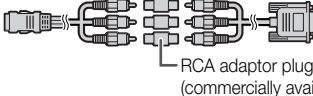

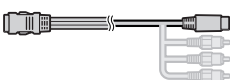
Equipment	Terminal on connected equipment	Cable	Terminal on the projector
	RGB output terminal 	RGB cable (supplied) 	COMPUTER/COMPONENT 1, 2  
	HDMI output terminal 	HDMI cable (commercially available) 	HDMI 

Note











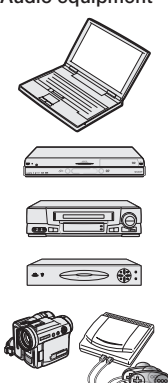

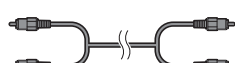
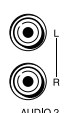

- Depending on specifications of equipment or the DVI⇔HDMI digital cable, the signal transmission may not work properly. (The HDMI specification does not support all connections to equipment that has digital output terminal using a DVI⇔HDMI digital cable.)
- You can also use the COMPUTER/COMPONENT 2 terminal as the MONITOR OUT terminal. To use this terminal as an input terminal, set "COMPUTER2 Select" to "Input" before connecting the external equipment. (See page 56.)
- See page 75 "Compatibility Chart" for a list of computer signals compatible with the projector. Use with computer signals other than those listed may cause some of the functions to not work.
- A Macintosh adaptor may be required for use with some Macintosh computers. Contact your nearest Macintosh Dealer.
- **Depending on the computer you are using, an image may not be projected unless the computer's external output port is switched on (e.g. Press "Fn" and "F5" keys simultaneously when using a SHARP notebook computer).** Refer to the specific instructions in your computer's operation manual to enable your computer's external output port.

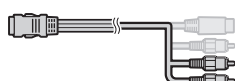
Equipment	Terminal on connected equipment	Cable	Terminal on the projector
Video equipment 	HDMI output terminal 	HDMI cable (commercially available) 	HDMI 
	Component video output terminal 	3 RCA to mini D-sub 15 pin cable 	COMPUTER/COMPONENT 1, 2  
	S-video output terminal 	S-video cable (commercially available) 	S-VIDEO  
	Video output terminal 	Video cable (commercially available) 	VIDEO  
Camera/Video game 	Component video output terminal	Cables for a camera or a video game/3 RCA to mini D-sub 15 pin cable  RCA adaptor plug (commercially available)	COMPUTER/COMPONENT 1, 2  
	S-video output terminal	Cables for a camera or a video game 	S-VIDEO  
	Video output terminal	Cables for a camera or a video game 	VIDEO  

Note

- Depending on specifications of equipment or the DVI⇄HDMI digital cable, the signal transmission may not work properly. (The HDMI specification does not support all connections to equipment that has digital output terminal using a DVI⇄HDMI digital cable.)
- HDMI (High-Definition Multimedia Interface) is a digital AV interface that can deliver a high-definition video signal, multi-channel audio signal, and bi-directional control signal all in just one cable.
- Because it is compatible with the HDCP (High-bandwidth Digital Content Protection) system, the digital video signal does not degrade when transmitted, and a high-quality image with a simple connection can be enjoyed.
- You can also use the COMPUTER/COMPONENT 2 terminal as the MONITOR OUT terminal. To use this terminal as an input terminal, set "COMPUTER2 Select" to "Input" before connecting the external equipment. (See page 56.)
- When you connect video equipment with a 21-pin RGB output (Euro-scart) to the projector, use a commercially available cable that fits in the projector terminal you want to connect.
- The projector does not support RGBC signals via the Euro-scart.

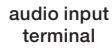
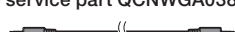
Connecting the Projector to Other Equipment (Continued)

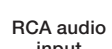
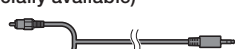
Equipment	Terminal on connected equipment	Cable	Terminal on the projector
	ø3.5 mm audio output terminal 	ø3.5 mm stereo or mono audio cable (commercially available or available as Sharp service part QCNWGA038WJPZ) 	AUDIO 1 
	RCA audio output terminal 	RCA audio cable (commercially available) 	AUDIO 2 
	Audio output terminal 	Cables for a camera or a video game 	
Monitor 	RGB input terminal 	RGB cable (supplied or commercially available) 	MONITOR OUT 
Amplifier 	ø3.5 mm audio input terminal 	ø3.5 mm stereo or mono audio cable (commercially available or available as Sharp service part QCNWGA038WJPZ) 	AUDIO OUT 
	RCA audio input terminal 	ø3.5 mm stereo minijack to RCA audio cable (commercially available) 	

Note

- You can also use the MONITOR OUT terminal as the COMPUTER/COMPONENT 2 terminal. To use this terminal as an output terminal, set "COMPUTER2 Select" to "Monitor Output" before connecting the external equipment. (See page 56.)
- When using the ø3.5 mm mono audio cable, the volume level will be half of when using the ø3.5 mm stereo audio cable.
- You can select "Audio 1", "Audio 2" or "HDMI" for "Audio Input" in the "Audio" menu. (See page 51.)
- RGB signals and Component signals can be output to the monitor.

This projector is able to process the following signals when connected to HDMI equipment:

- Video signal: For details, see "Digital Support" in the list of "Compatibility Chart" on page 75.
- Audio signal: Linear PCM audio
- Sampling frequency: 48kHz/44.1kHz/32kHz

Controlling the Projector by a Computer

When the RS-232C terminal on the projector is connected to a computer with an RS-232C serial control cable (cross type, commercially available), the computer can be used to control the projector and check the status of the projector. Refer to the "SETUP MANUAL" contained on the supplied CD-ROM for "RS-232C Specifications and Commands".

When connecting to a computer using an RS-232C serial control cable

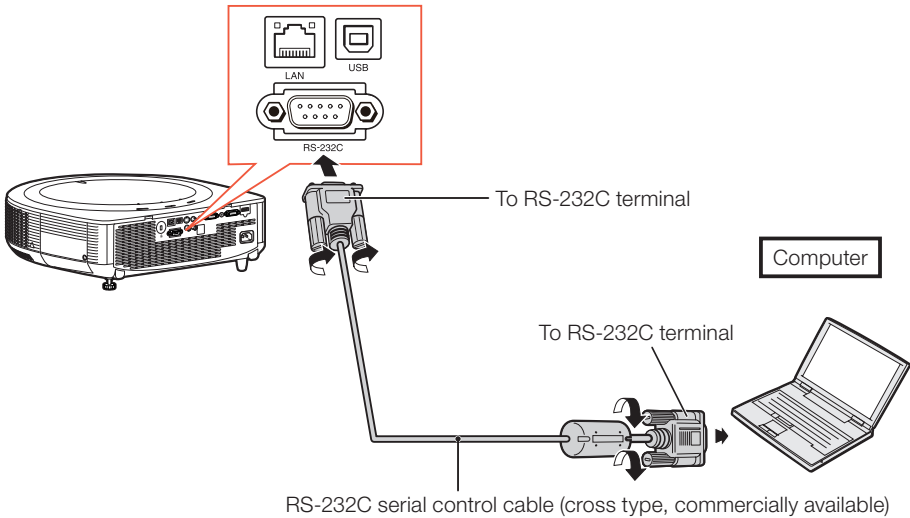

Note

- The RS-232C function may not operate if your computer terminal is not correctly set up. Refer to the operation manual of the computer for details.
- Refer to pages **2** to **9** of the "SETUP MANUAL" contained on the supplied CD-ROM for "Connecting Pin Assignments" and "RS-232C Specifications and Commands".

Info

- Do not connect the RS-232C cable to a port other than the RS-232C terminal on the computer. This may damage your computer or projector.
- Do not connect or disconnect an RS-232C serial control cable to or from the computer while it is on. This may damage your computer.

Controlling the Projector by a Computer (Continued)

When connecting to the LAN terminal using a LAN cable

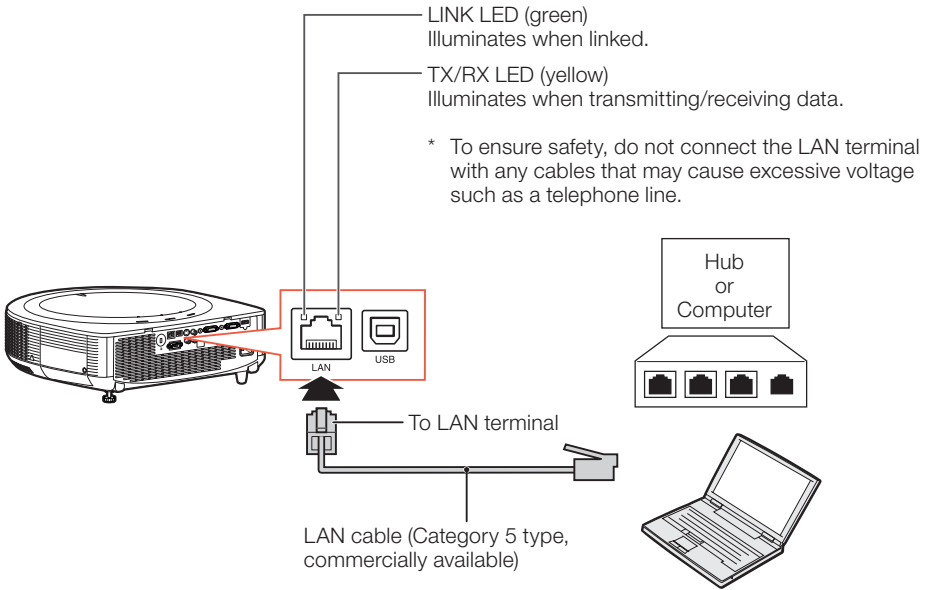

Note

- When connecting to a hub, use a straight-through Category 5 (CAT.5) type cable (commercially available).
- When connecting to a computer, use a cross-over Category 5 (CAT.5) type cable (commercially available).

Connecting the Power Cord

Plug the supplied power cord into the AC socket on the rear of the projector. Then plug into AC outlet.

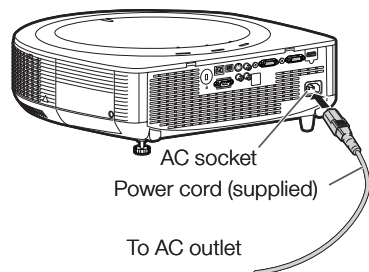

Turning the Projector On/Off

Turning the Projector On

Note that the connections to external equipment and power outlet should be done before performing the operations written below. (See pages 22 to 26.)

Press **STANDBY/ON** on the projector or **ON** on the remote control.

- The power indicator illuminates green.
- After the lamp indicator illuminates, the projector is ready to start operation.

Note

About the Lamp Indicator

The lamp indicator illuminates to indicate the status of the lamp.

Green: The lamp is on.

Blinking in green: The lamp is warming up.

Red: The lamp is shut down abnormally or the lamp should be replaced.

- When switching on the projector, a slight flickering of the image may be experienced within the first minute after the lamp has been illuminated. This is normal operation as the lamp's control circuitry is stabilising the lamp output characteristics. It should not be regarded as faulty operation.
- If the projector is put into Standby mode and immediately turned on again, the lamp may take some time to start projection.
- When System Lock is set, the keycode input box appears. To cancel the keycode setting, input the keycode that you have already set. See page 57 for details.

Info

When "Auto Restart" is set to "On":

- If the power cord is unplugged from the outlet or the breaker switch is turned off when the projector is on, then the projector automatically turns on when the power cord is plugged into the AC outlet or the breaker switch is turned on. (See page 56.)
- English is the factory default language. If you want to change the on-screen display to another language, change the language according to the procedure on page 55.

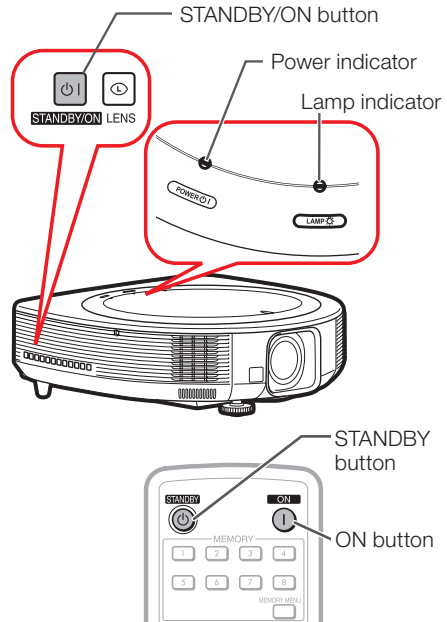

Turning the Power Off (Putting the Projector into Standby Mode)

Press **STANDBY/ON** on the projector or **STANDBY** on the remote control, then press that button again while the confirmation message is displayed, to put the projector into Standby mode.

- The projector cannot be turned on while cooling.

On-screen display (confirmation message)



Enter STANDBY mode?

Yes : Press Again

No : Please Wait

Info

Direct Power Off function:

- You can unplug the power cord from the AC outlet even if the cooling fan is still running.

Image Projection

Shifting the Lens

In addition to the zoom function and adjustment of projection angle using the adjustment feet, you can adjust the position of the projection using the lens shift function. This is a useful function in cases such as when the screen cannot be moved.

When moving upward or downward

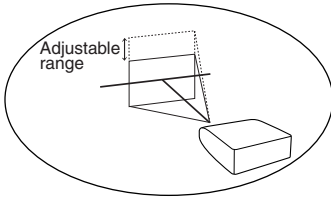

When moving in the left and right direction

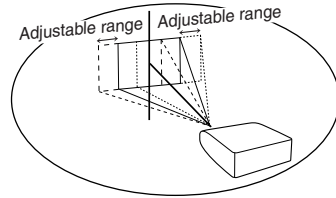

Adjustable range

- The adjustable range is shown below.
Horizontal range: $\pm 25\%$ (XG-SV200X)/ $\pm 23\%$ (XG-SV100W)
Vertical range: $\pm 50\%$
The adjustable range has limitations even within the range shown above.
- The image can be adjusted as shown on the diagram.
- Allow a margin of error in the value.

XG-SV200X

Position of the image when the image is centered, both vertically and horizontally, in lens shift

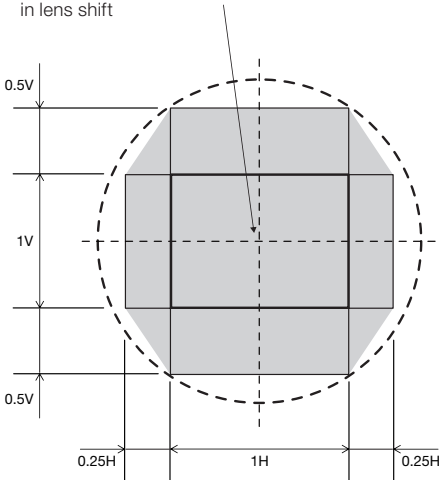

V : Height of the image
H : Width of the image

XG-SV100W

Position of the image when the image is centered, both vertically and horizontally, in lens shift

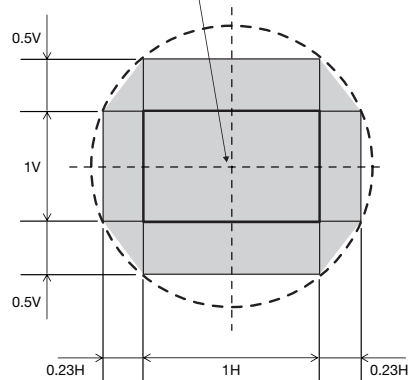

V : Height of the image
H : Width of the image

1 Press H&V SHIFT on the remote control.

- Pressing **ENTER** on the projector or on the remote control displays the test pattern. Checking the test pattern is useful for more accurate adjustment.

▼On-screen display

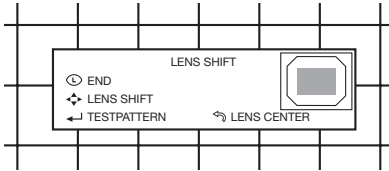

2 Press ▲, ▼, ◀ or ▶ on the projector or the remote control to adjust the image position.

Note

- When **RETURN** is pressed, the lens shift reset screen is displayed. Lens shift can be reset to factory default with this screen.

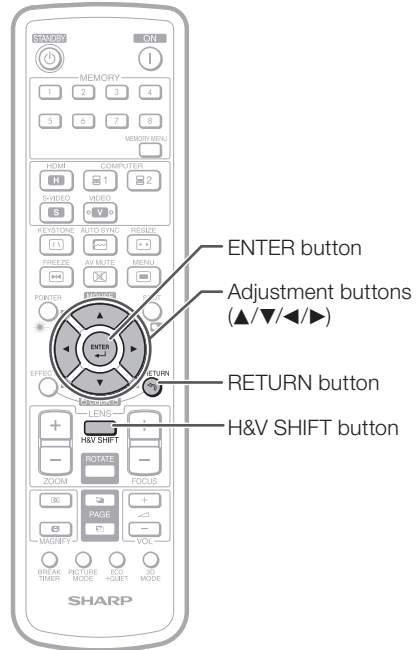

Using the Adjustment Feet

- When the position of the projected image cannot be adjusted with the lens shift function, use the adjustment feet to adjust the projected angle.
- The height of the projector can be adjusted using the adjustment feet when the screen is located higher than the projector, the screen is inclined or when the installation site is slightly inclined.
- Install the projector so that it is as perpendicular to the screen as possible.

1 Rotate the adjustment feet to adjust the projected angle.

- The projector is adjustable up to approximately 9 degrees (front) and approximately ± 2 degrees (rear) from the standard position.

Warning!

- Do not hold the lens and lens cover when projector angle is adjusted.
- Use caution not to pinch your finger in the space between the adjustment foot and the projector when the projector angle is lowered.

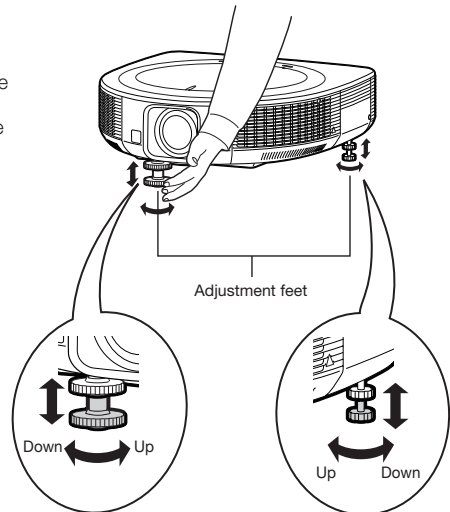

Image Projection (Continued)

Adjusting the Focus

Press **FOCUS +/-** on the remote control to adjust the focus.

▼On-screen display



Info

- It is recommended that the focus be adjusted after the projector has warmed up for at least 30 minutes.

Adjusting the Projected Image Size

Press **ZOOM +/-** on the remote control to adjust the projected image size.

▼On-screen display

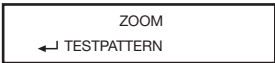

Note

- After you have pressed **FOCUS** or **ZOOM** on the remote control, you can display the test pattern by pressing **ENTER**. The test pattern is useful for making more accurate adjustments.
- For fine adjustments, when **H&V SHIFT**, **FOCUS** or **ZOOM** is pressed, the projected image moves a small amount in the desired direction for approximately one second. Hold down the buttons to move the projected image quickly.

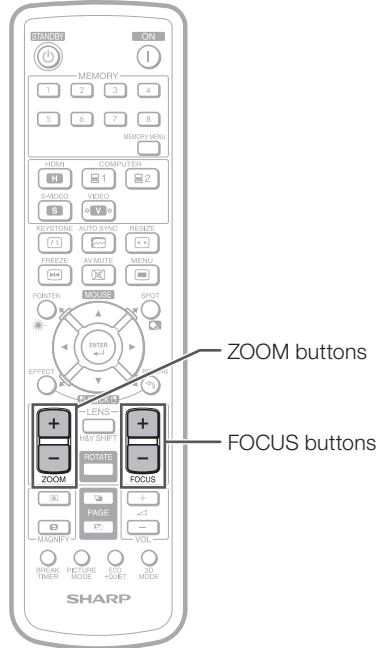

Correcting Trapezoidal Distortion

When the image is projected either from the top or from the bottom towards the screen at an angle, the image becomes distorted trapezoidally. The function for correcting trapezoidal distortion is called Keystone Correction.

There are the two types of the Keystone Correction.

- 1) "GEOMETRIC ADJUSTMENT" for correcting an image designating the corner of the projected image
- 2) "H&V KEYSTONE" for designating the correction of the horizontal and vertical axes

Selecting the Type of the Correction

Select the type of the keystone correction.

Press **KEYSTONE** on the projector or on the remote control.

- "GEOMETRIC ADJUSTMENT" will be displayed.
- Each time **KEYSTONE** is pressed, the display toggles as follows:

GEOMETRIC ADJUSTMENT → H&V KEYSTONE
 ↖ The display disappears. ↗

GEOMETRIC ADJUSTMENT	For correcting an image designating the corner of the projected image
H&V KEYSTONE	For correcting an image designating the horizontal or vertical axes

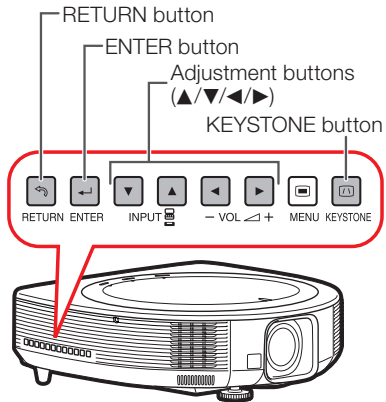
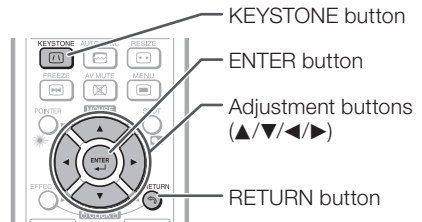

Image Projection (Continued)

GEOMETRIC ADJUSTMENT

1 Press **KEYSTONE** on the projector or on the remote control repeatedly until “**GEOMETRIC ADJUSTMENT**” is displayed.

2 Press **▲**, **▼**, **◀** or **▶** to move the position for the upper left of the image.

3 Press **ENTER** to set the position.

4 Repeat the same procedure with the positions for the upper right, lower right and lower left of the image.

- At this time, pressing **RETURN** on the projector or on the remote control returns to the previous screen.
- When the position of the lower left is set, the correction is made and the display disappears.

▼On-screen display

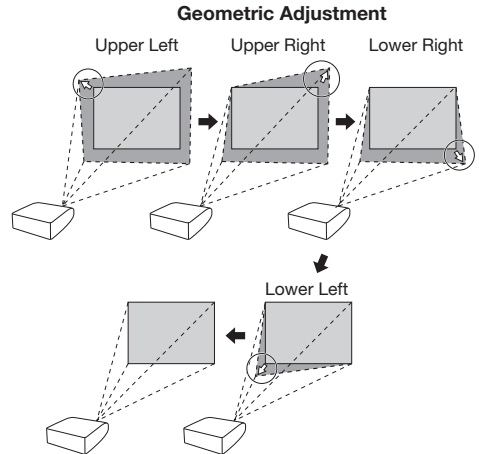
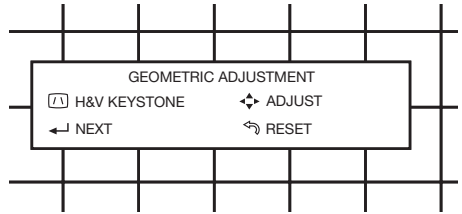

H&V KEYSTONE

1 Press **KEYSTONE** on the projector or on the remote control repeatedly until “H&V KEYSTONE” is displayed.

▼On-screen display

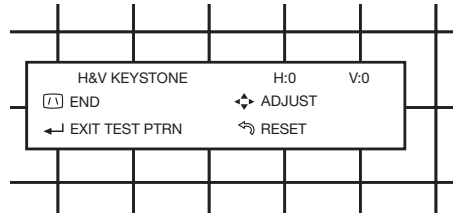

2 Press **▲** or **▼** to parallelize the left and right sides of the projected image.

Vertical Keystone Correction
(Adjustment with ▲ / ▼)

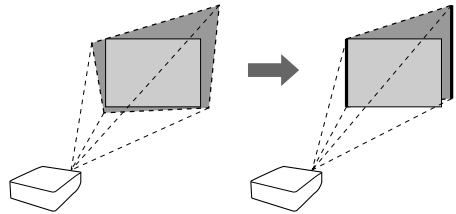

3 Press **◀** or **▶** to parallelize the upper and lower sides of the projected image.

Horizontal Keystone Correction
(Adjustment with ◀ / ▶)

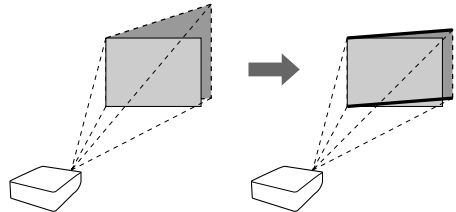

4 Press **KEYSTONE** to set the position.

Image Projection (Continued)

Switching the Input Mode

Select the appropriate input mode for the connected equipment.

Press **HDMI**, **COMPUTER 1/2**, **S-VIDEO** or **VIDEO** on the remote control to select the input mode.

- When you select the input mode with **INPUT** ▼/▲ on the projector:
 - When ▼/▲ is pressed, the Input list appears. While the Input list is displayed, follow the procedure below to switch the input mode.

INPUT list

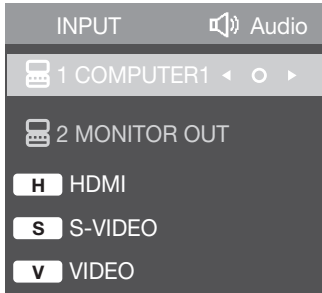

- Press ▼/▲ to select the desired input mode and then press **ENTER**.
 - If **ENTER** is not pressed, the projector switches to the selected input mode in a few seconds.

Note

- When no signal is received, "NO SIGNAL" will be displayed. When non-supported signal is received, "NOT REG." is displayed.

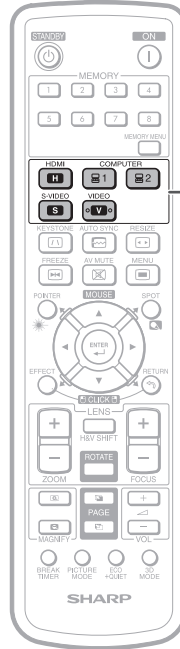

HDMI, COMPUTER 1/2, S-VIDEO, VIDEO buttons

Adjusting the Volume

Press **VOL +/-** on the remote control or on the projector to adjust the volume.

Note

- Pressing **VOL-** will lower the volume.
- Pressing **VOL+** will raise the volume.
- When the projector is connected to external equipment, the volume level of the external equipment changes in accordance with the volume level of the projector. Set the projector's volume to the lowest level when turning the projector on/off or when changing the input signal.
- When you do not want to output the sound from the projector's speaker while the projector is connected to external equipment, set "Speaker" in the "Audio" menu to "Off". (See page 51.)

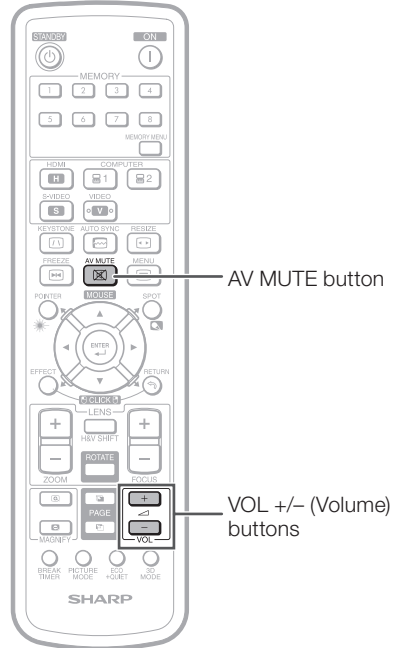

On-screen display



Displaying the Black Screen and Turning Off the Sound Temporarily

Press **AV MUTE** on the remote control to temporarily display a black screen and turn off the sound.

Note

- Pressing **AV MUTE** again will turn the projected image back on.

On-screen display



Image Projection (Continued)

Resize Mode

This function allows you to modify or customize the Resize mode to enhance the input image. Depending on the input signal, you can choose a desired image.

Press **RESIZE**.

- See page 54 for setting on menu screen.

[For XG-SV200X]

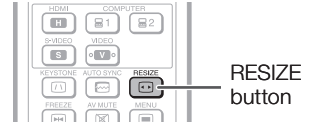

COMPUTER

	Main resolution	NORMAL	FULL	NATIVE	BORDER	16:9
4:3 aspect ratio	SVGA (800 × 600)	1024 × 768	—	800 × 600	768 × 576	1024 × 576
	XGA (1024 × 768)			—		
	SXGA (1152 × 864)			1152 × 864		
	UXGA (1600 × 1200)			1600 × 1200		
Other aspect ratios	SXGA (1280 × 1024)	968 × 768	1024 × 768	1280 × 1024	720 × 576	1024 × 576
	1280 × 720	1024 × 576		1280 × 720	—	
	1360 × 768	1024 × 578		1360 × 768	—	
	1366 × 768	1024 × 576		1366 × 768	—	
	1280 × 768	1024 × 614		1280 × 768	960 × 576	
	1280 × 800	1024 × 640		1280 × 800	922 × 576	

Input signal		For 4:3 screen			For 16:9 screen					
Computer	Image type	NORMAL	FULL	NATIVE	BORDER	16:9				
Resolution lower than XGA	 4:3 aspect ratio		—*1							
XGA				—*1						
Resolution higher than XGA	 5:4 aspect ratio									
SXGA (1280 × 1024)										
1280 × 720									—*1	—*1
1360 × 768 1366 × 768										
1280 × 768	 16:10 aspect ratio									
1280 × 800										

























■ : Cutout area on which images cannot be projected

⋯ : Area where the signals are off screen

*1 Same as NORMAL mode

[For XG-SV200X]

VIDEO/DTV

Input signal		For 4:3 screen			For 16:9 screen	
Video/DTV	Image type	NORMAL	AREA ZOOM	V-STRETCH	BORDER	16:9
480I, 480P, 576I, 576P, NTSC, PAL, SECAM	 4:3 aspect ratio					
	 Squeeze					
	 Letter box					
720P, 1035I, 1080I, 1080P	 16:9 aspect ratio					
540P	 16:9 aspect ratio				—*1	—*1
	 (4:3 aspect ratio in 16:9)					

 : Cutout area on which images cannot be projected

 : Area on which the image is not included in the original signals















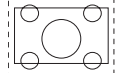



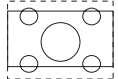

*1 Same as NORMAL mode.

Image Projection (Continued)

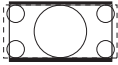
[For XG-SV100W]

COMPUTER

	Main resolution	NORMAL	FULL	NATIVE	16:9
4:3 aspect ratio	SVGA (800 × 600)	1068 × 800	1280 × 800	800 × 600	1280 × 720
	XGA (1024 × 768)			1024 × 768	
	SXGA (1152 × 864)			1152 × 864	
	SXGA+ (1400 × 1050)			1400 × 1050	
Other aspect ratios	SXGA (1280 × 1024)	1000 × 800	—	1280 × 1024	—
	1280 × 720	1280 × 720		—	
	1360 × 768	1280 × 722		1360 × 768	
	1366 × 768	1280 × 720		1366 × 768	
	1280 × 768	1280 × 768		—	
	1280 × 800	1280 × 800			

Input signal		Output screen image			
Computer	Image type	NORMAL	FULL	NATIVE	16:9
Resolution XGA and below	 4:3 aspect ratio				
Resolution higher than XGA				 *2	
SXGA (1280 × 1024)	 5:4 aspect ratio				
1280 × 720	 16:9 aspect ratio				
1360 × 768 1366 × 768	 16:9 aspect ratio				
1280 × 768	 15:9 aspect ratio				
1280 × 800	 16:10 aspect ratio		—*1		

■: Cutout area on which images cannot be projected











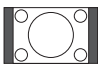
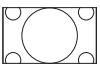
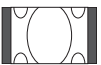















⋯: Area where the signals are off screen

*1 Same as NORMAL mode.

*2 In case SXGA+ input.

[For XG-SV100W]

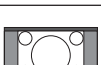
VIDEO/DTV

Input signal		Output screen image			
Video/DTV	Image type	NORMAL	AREA ZOOM	V-STRETCH	16:9
480I, 480P, 576I, 576P, NTSC, PAL, SECAM	 4:3 aspect ratio				
	 Squeeze				
	 Letter box				
720P, 1035I, 1080I, 1080P	 16:9 aspect ratio				—*1
	 16:9 aspect ratio				
540P	 16:9 aspect ratio				—*1
	 16:9 aspect ratio (4:3 aspect ratio in 16:9)				

 : Cutout area on which images cannot be projected

 : Area on which the image is not included in the original signals

*1 Same as NORMAL mode.

About Copyrights

- When using the Resize function to select an image size with a different aspect ratio to a TV program or video image, the image will look different from its original appearance. Keep this in mind while choosing an image size.
- The use of the Resize or Keystone Correction function to compress or stretch the image for commercial purposes/public displays in a café, hotel, etc. may be an infringement of copyright protected by law for copyright holders. Please use caution.

Operating with the Remote Control

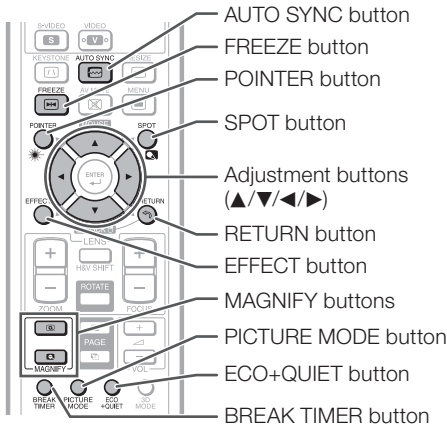

Displaying the Pointer

- 1 Press **POINTER** and press **▲/▼/◀/▶** on the remote control to move the pointer.
 - Press **EFFECT** to change the pointer icon (5 types).

Star	Finger1	Finger2	Heart	Underline

- 2 Press **POINTER** again.
 - The pointer will disappear.

Displaying and Setting the Break Timer

- 1 Press **BREAK TIMER**.
 - The timer starts to count down from 5 minutes.

On-screen display



- 2 Press **▲/▼/◀/▶** to adjust the length of the break time.
 - **Increases with ▲ or ▶**
5 minutes → 6 minutes → 60 minutes
 - **Shortens with ◀ or ▼**
4 minutes → 3 minutes → 1 minute
 - The break time can be set in units of one minute (up to 60 minutes).

Canceling the break timer display function

Press **BREAK TIMER**.

Note

- The Break Timer is not available while the projector is operating the following functions.
 - Auto Sync
 - Freeze
 - AV Mute

Using the Spot Function

- 1 Press **SPOT** and press **▲/▼/◀/▶** on the remote control to move the spot area.
 - Press **EFFECT** to change the spot area size (3 types).

1/9	1/25	1/8

- 2 Press **SPOT** again.
 - The spot area will disappear.

Switching the Eco+Quiet Mode

Press **ECO+QUIET** to switch the Eco+Quiet mode between on and off.

- When the Eco+Quiet is set to "ON", the sound of the cooling fan will turn down, the power consumption will decrease, and the lamp life will extend.

Note

- Refer to "Eco+Quiet" on page 50 for details.

Auto Sync (Auto Sync Adjustment)

Auto Sync function works when detecting input signal after the projector turns on.

Press **AUTO SYNC** to manually adjust with Auto Sync function.

Note

- When the optimum image cannot be achieved with Auto Sync adjustment, use manual adjustments. (See page 52.)

Freezing a Moving Image

1 Press **FREEZE**.
• The projected image is frozen.

2 Press **FREEZE** again to return to the moving image from the currently connected device.

Selecting the Picture Mode

You can select the appropriate Picture mode for the projected image, such as movie or video game.

Press **PICTURE MODE**.

- When pressing **PICTURE MODE**, the Picture mode changes in the following order:

→ STANDARD → PRESENTATION → MOVIE → GAME → sRGB*

Note

- See page 48 for details on the Picture mode.

* "sRGB" is displayed only when RGB signal is input.

Displaying an Enlarged Portion of an Image

Graphs, tables and other portions of projected images can be enlarged. This is helpful when providing more detailed explanations.

- 1** Press **MAGNIFY** on the remote control.
- Enlarges the image.
 - Pressing **MAGNIFY** enlarges or reduces the projected image.

Note

Press **MAGNIFY**.

→
×1 ×2 ×3 ×4 ×9

←
Press **MAGNIFY**.

- You can change the location of the enlarged image using **UP**, **DOWN**, **LEFT** and **RIGHT**.

2 Press **RETURN** on the remote control to cancel the operation.

- The magnification then returns to ×1.

Note

- The selectable magnifications differ depending on the input signal.
- This function is not available for the 3D mode.
- In the following cases, the image will return to the normal size (×1).
 - When switching the Input mode.
 - When **RETURN** has been pressed.
 - When the input signal is changed.
 - When the input signal resolution and refresh rate (vertical frequency) change.
 - When the Resize mode is changed.
 - When switching "DLP® Link™" between "On" and "Off".

Operating with the Remote Control (Continued)

Using the Remote Control as the Wireless Computer Mouse

When connecting the projector and the computer with a USB cable, you can use the remote control as the computer mouse.

Connecting with a USB cable

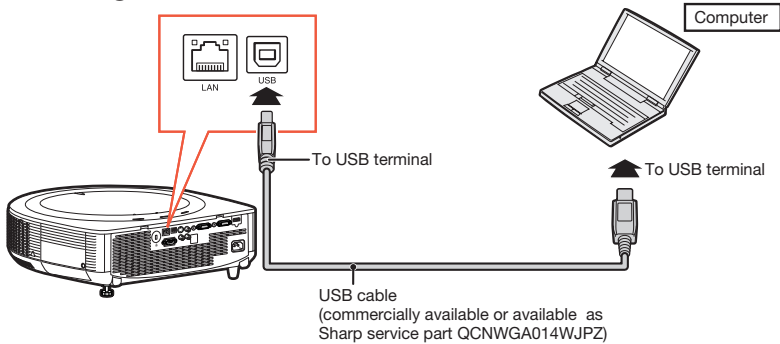

The mouse pointer can be operated in the following way after it is connected.

- **When moving the cursor**
Press MOUSE/Adjustment buttons (▲/▼/◀/▶).
- **When left-clicking**
Press **L-CLICK**.
- **When right-clicking**
Press **R-CLICK**.
- **When your computer supports only a one-click mouse (such as Macintosh)**
Press **L-CLICK** or **R-CLICK**.
L-CLICK and **R-CLICK** have common function.
- **When using [Page Up] or [Page Down]**
Same as the [Page Up] and [Page Down] keys on a computer keyboard.
Press **PAGE UP** or **PAGE DOWN**.

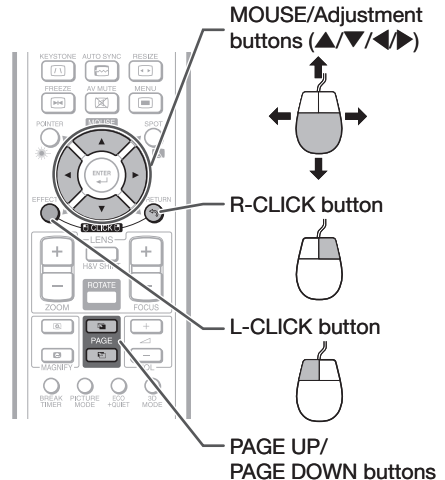

Note

- This function only works with the Microsoft® Windows® OS and Mac OS® that support USB.
- You cannot use this function when displaying the menu screen.
- Confirm that the computer recognizes the USB connection.



Menu Items

The following shows the items that can be set in the projector.

“Picture” menu

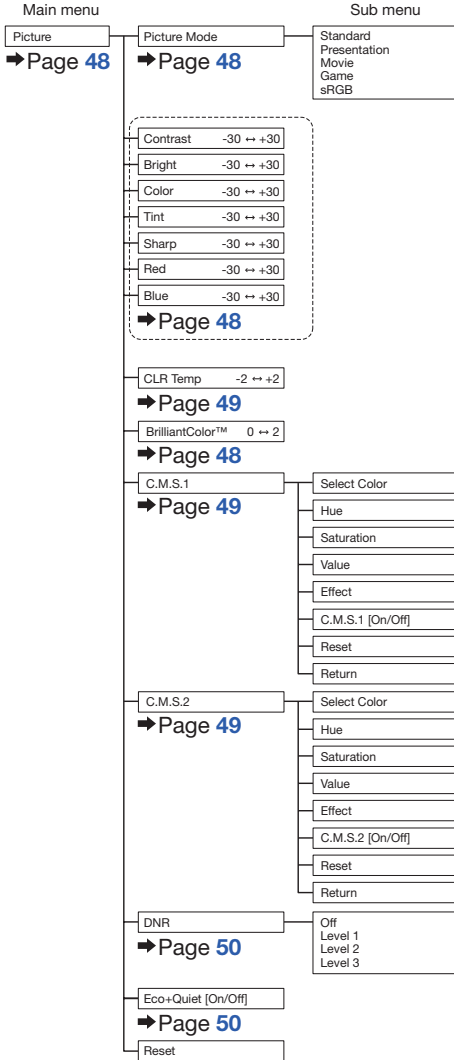

“Audio” menu

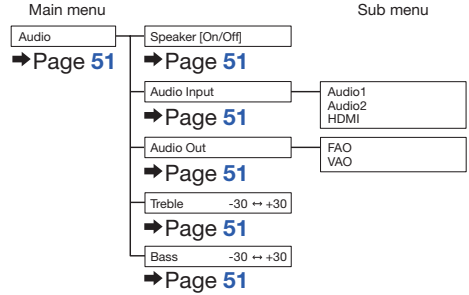



Menu Items (Continued)

“Signal adjustment (SIG)” menu

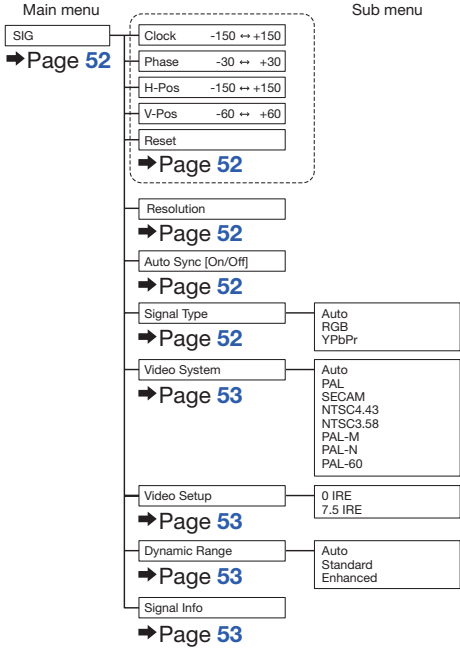

“Screen adjustment (SCR)” menu

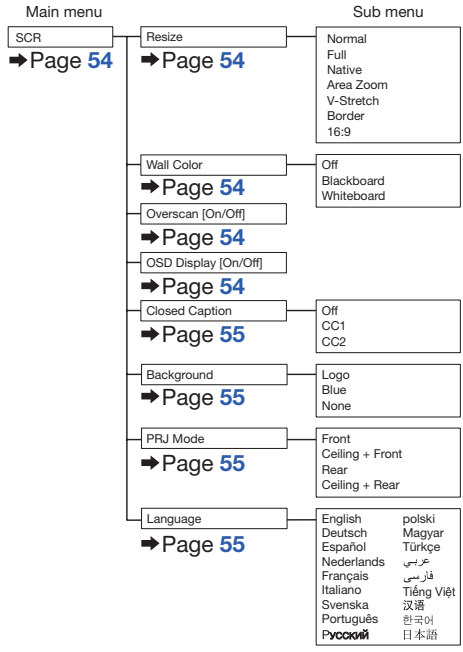

“Projector adjustment (PRJ)” menu

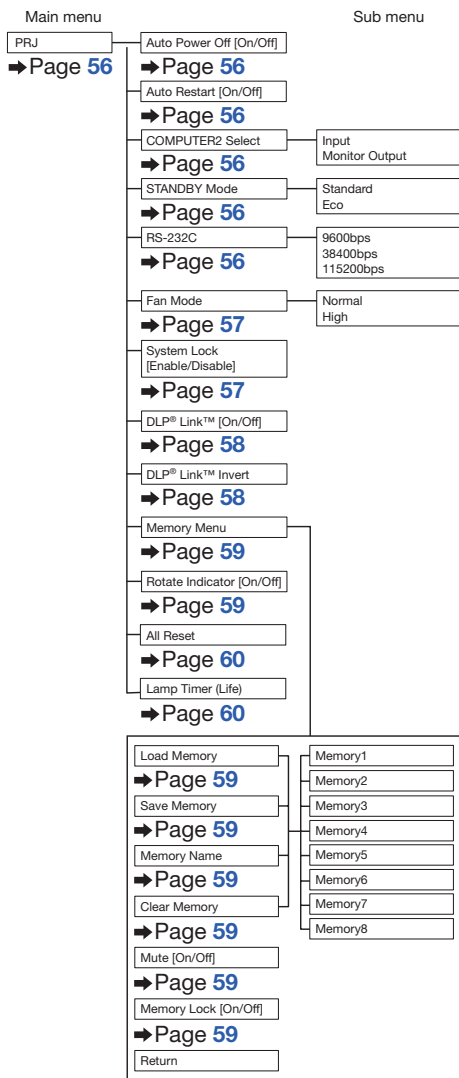

“Network (Net.)” menu

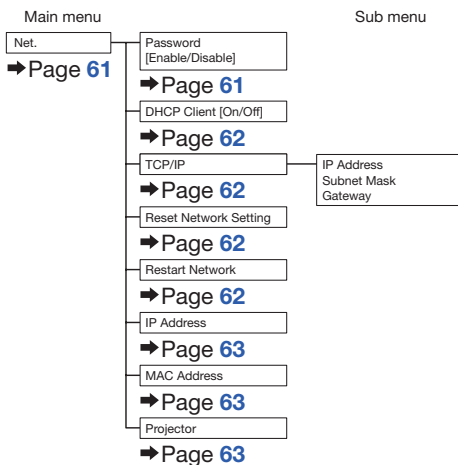

Using the Menu Screen

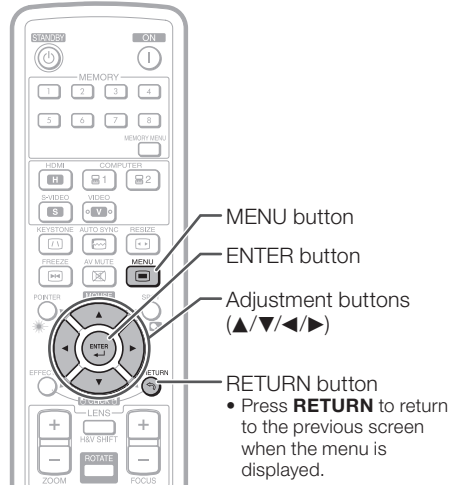
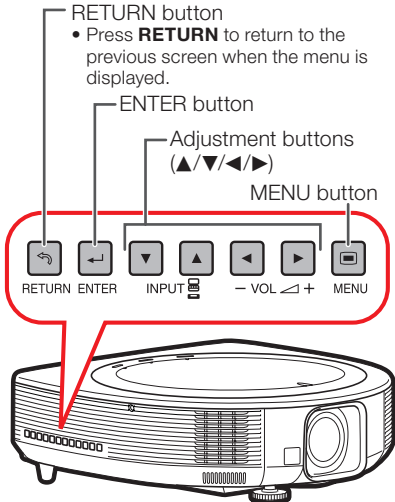

Menu Selections (Adjustments)

Example: Adjusting "Bright".

- This operation can also be performed by using the buttons on the projector.

1 Press **MENU**.

- The "Picture" menu screen for the selected input mode is displayed.

2 Press **▶** or **◀** and select "Picture" to adjust.

Example: "Picture" screen menu

Menu item

Picture	Audio	SIG	SCR	PRJ	Net.
Picture Mode			Standard		
Contrast	[0]		█		+
Bright	[0]		█		+
Color	[0]		█		+
Tint	[0]		█		+
Sharp	[0]		█		+
Red	[0]		█		+
Blue	[0]		█		+
CLR Temp	[0]		█		+
BrilliantColor™	[1]		█		+
C.M.S.1			Off		
C.M.S.2			Off		
DNR			Level 2		
Eco+Quiet			Off		
◆◆◆ Reset					
◆ SEL./ADJ.			↵ ENTER		
↶ RETURN			⏏ END		

3 Press ▲ or ▼ and select “Bright” to adjust.

- The selected item is highlighted.

To adjust the projected image while watching it

Press ENTER.

- The selected item (e.g. “Bright”) is displayed by itself at the bottom of the screen.
- When pressing ▲ or ▼, the following item (“Color” after “Bright”) will be displayed.

Note

- Press **ENTER** again to return to the previous screen.

4 Press ◀ or ▶ to adjust the item selected.

- The adjustment is stored.

5 Press MENU.

- The menu screen will disappear.

Note

- The **MENU** button is not available while the projector is operating:
 - Auto Sync/Break Timer/Freeze/AV Mute

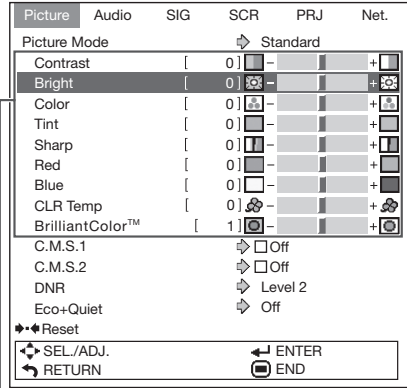

Items to be adjusted

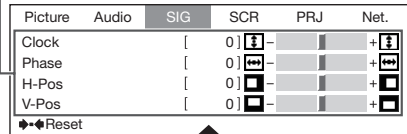

↑ Press ENTER.

The item displayed by itself

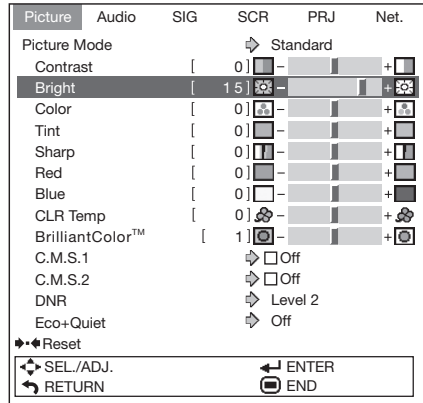

Picture Adjustment (“Picture” Menu)

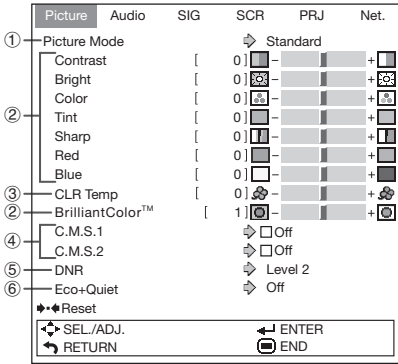

Info

- When “sRGB” is selected, the projected image may become dark, but this does not indicate a malfunction.

① Selecting the Picture Mode

Selectable items	Description
Standard	For standard image
Presentation	Brightens portions of image for more enhanced presentations.
Movie	Gives natural tint to the projected image.
Game	Gives sharpness to the projected image.
*sRGB	For high fidelity reproduction of images from a computer.

- “sRGB” is displayed only when RGB signal is input.
- You can set or adjust each item in the “Picture” menu to your preference. Any changes you make are retained in memory.

Note

- You can also press **PICTURE MODE** on the remote control to select the picture mode. (See page 41.)
- *sRGB is an international standard of color reproduction regulated by the IEC (International Electrotechnical Commission). As the fixed color area has been decided by the IEC, the images are displayed in a natural tint based on an original image, when “sRGB” is selected.
- For additional information about the sRGB function, visit “<http://www.srgb.com/>”.
- You cannot set the items, “Red”, “Blue”, “CLR Temp”, “Brilliant Color™”, “C.M.S.1” and “C.M.S.2”, when “sRGB” is selected.

② Adjusting the Image

Adjustment items	◀ button	▶ button
Contrast	For less contrast.	For more contrast.
Bright	For less brightness.	For more brightness.
Color*1	For less color intensity.	For more color intensity.
Tint*1	For making skin tones purplish.	For making skin tones greenish.
Sharp	For less sharpness.	For more sharpness.
Red*1	For weaker red.	For stronger red.
Blue*1	For weaker blue.	For stronger blue.
BrilliantColor™*1*2	For making the effect weaker.	For making the effect stronger.

*1 Not adjustable/selectable when selecting “sRGB”.
 *2 BrilliantColor™ uses Texas Instruments' BrilliantColor™ technology. As the BrilliantColor™ level is increased, the image becomes brighter while the color reproduction is kept at a high level.

Note

- “Color”, “Tint”, “Red”, “Blue”, “BrilliantColor™” and “CLR Temp” cannot be set when “sRGB” is selected.
- To reset all adjustment items, select “Reset” and press **ENTER**.

③ Adjusting the Color Temperature

Selectable items	Description
-2	For lower color temperature for warmer, reddish incandescent-like images.
0	↕
+2	For higher color temperature for cooler, bluish, fluorescent-like images.

Note

- Values on “CLR Temp” are only for general standard purposes.
- “CLR Temp” cannot be set when “sRGB” is selected.

④ Adjusting the Colors

You can select the color of the projected image to correct and then adjust it to the desired color by setting “Hue”, “Saturation”, “Value”, and “Effect”.

Note

- Before performing this adjustment, prepare the image to be adjusted.
- You can perform this adjustment easier in the still image than in the moving image.

1 Select “C.M.S.1” or “C.M.S.2” (C.M.S.: Color Management System), and press ENTER.

- If there is no data for the stored corrected color, the color selection screen and the picker is displayed. (Go to step 2.)

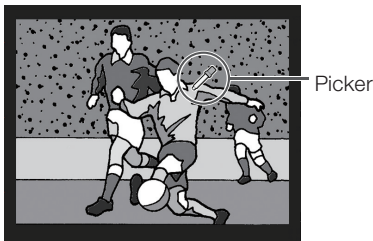

- If there is data for the stored corrected color, the C.M.S. color adjustment screen is displayed. (Go to step 3.)

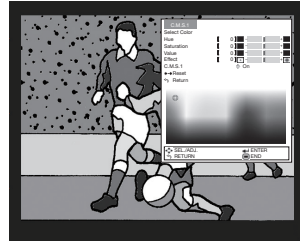

2 Use the picker and select the color of the projected image to correct. The picker can be operated by adjustment buttons (▲/▼/◀/▶) on the remote control.

- By enlarging the projected image using or **MAGNIFY**, more fine adjustment can be performed.



- By continuing to press the adjustment buttons (▲/▼/◀/▶), the picker moves rapidly.

After selecting the color of the projected image to correct, press **ENTER**. The C.M.S. color adjustment screen is displayed. (Go to step 3.)

Picture Adjustment (“Picture” Menu) (Continued)

Menu operation → Page 46

3 Set or adjust each item in the C.M.S. color adjustment screen.

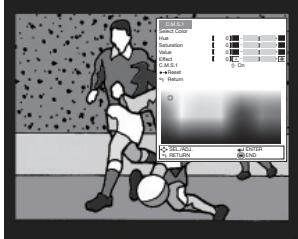

C.M.S. color adjustment screen:

Selectable items	Description
Select Color	Starts over the selection of the color to be corrected.
Hue	Sets the hue of the main colors.
Saturation	Sets the saturation of the main colors.
Value	Sets the value of the main colors.
Effect ¹	Specifies the range of color correction.
C.M.S.1 ² (or C.M.S.2)	Checks the appearance of the projected image after above correction.
Reset	Sets “Hue”, “Saturation”, “Value”, and “Effect” to their default values.
Return	Completes the correction and closes the C.M.S. color adjustment screen.

*1 To specify the range of color correction, select “Effect” and press ◀ or ▶ button.

◀ button	Specifies smaller range.
▶ button	Specifies larger range.

*2 To check the appearance of the projected image, select “C.M.S.1” (or “C.M.S.2”) and set to “On” or “Off”.

On	The appearance of the projected image after above color adjustment reflected can be checked.
Off	The appearance of the projected image in former color adjustment can be checked.

4 To complete the C.M.S. color adjustment, select “Return” and press **ENTER**.

Note

- The C.M.S. color adjustment can be made to one color each in “C.M.S.1” and “C.M.S.2”.
- “C.M.S.1” and “C.M.S.2” cannot be set when “sRGB” is selected.

5 Reducing Image Noise (DNR)

Video digital noise reduction (DNR) provides high quality images with minimal dot crawl and cross color noise.

Selectable items	Description
Off	The DNR function is not activated.
Level 1	Sets the DNR level for viewing a clearer picture.
Level 2	
Level 3	

Note

Set “DNR” to “Off” in the following cases:

- When the image is blurry.
- When the contours and colors of moving images drag.
- When TV broadcasts with weak signals are projected.

6 Eco+Quiet

Selectable items	Brightness	Fan Sound	Lamp life
On	Approx. 80%	Low	Approx. 2,500 hours
Off	100%	Normal	Approx. 1,500 hours

Note

- You can also use **ECO+QUIET** on the remote control or on the projector to switch the Eco+Quiet mode. (See page 40.)

Audio Adjustment (“Audio” Menu)

Menu operation → Page 46

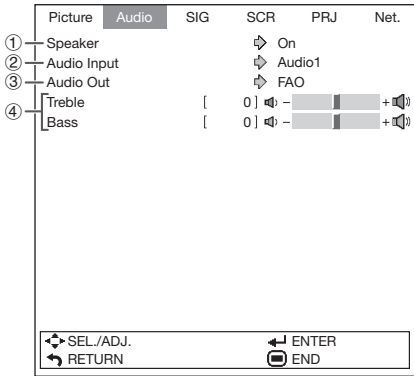

① Speaker Setting

This function allows you to set the audio output of the internal speaker to “On” or “Off” such as when the projector is connected to an external amplifier.

Selectable items	Description
On	The audio signal is output from the internal speaker.
Off	The audio signal is not output from the internal speaker.

② Audio Input

This function allows you to select an appropriate combination of audio input terminals for each input mode.

Selectable items	Description
Audio 1	The AUDIO 1 input terminal is used as an audio input terminal.
Audio 2	The AUDIO 2 input terminal is used as an audio input terminal.
HDMI	HDMI terminal is used as an audio input terminal. (This item is available with HDMI input.)

③ Audio Output Type Setting

This function determines whether the audio level output from the AUDIO output terminal is fixed or variable by linking with VOLUME.

Selectable items	Description
FAO (Fixed Audio Output)	Audio output that does not vary in strength with the volume level of the source projector.
VAO (Variable Audio Output)	Audio output that varies in strength with the volume level of the source projector.

Info

- When “Audio Out” has been set to “VAO”, first make sure to lower the volume of the projector before turning the power on or off and when switching the input.

④ Adjusting the Audio

This function allows you to adjust the projector’s audio.

Selectable items	◀ button	▶ button
Treble	For weaker treble	For stronger treble
Bass	For weaker bass	For stronger bass

Signal Adjustment (“SIG” Menu)

Menu operation → Page 46

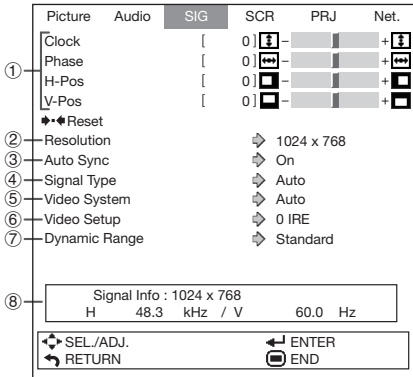

① Adjusting the Computer Image

If the optimum image cannot be obtained with Auto Sync adjustment, use the SIG function.

Selectable items	Description
Clock	Adjusts vertical noise.
Phase	Adjusts horizontal noise (similar to tracking on your VCR).
H-Pos	Centers the on-screen image by moving it to the left or right.
V-Pos	Centers the on-screen image by moving it up or down.

Note

- To reset all adjustment items, select “Reset” and press **ENTER**.
- The adjustable range of “H-Pos” (H-Position) and “V-Pos” (V-Position) may vary depending on the screen resolution of the computer.

② Resolution Setting

Ordinarily, the type of input signal is detected and the correct Resolution mode is automatically selected. However, for some signals, the optimal Resolution mode in “Resolution” may need to be selected to match the computer display mode.

Note

- See “Checking the Input Signal” on page 53 for information on the currently selected input signal.

③ Auto Sync Adjustment

Used to automatically adjust a computer image.

Selectable items	Description
On	Auto Sync adjustment will occur when the projector is turned on or when the input signals are switched, when connected to a computer.
Off	Auto Sync adjustment is not automatically performed.

Note

- Auto Sync adjustment is also performed by pressing **AUTO SYNC** on the projector or on the remote control.
- The Auto Sync adjustment may take some time to complete, depending on the image of the computer connected to the projector.

④ Signal Type Setting

This function allows you to select the input signal type RGB or Component for **COMPUTER/COMPONENT 1, 2**.

Selectable items	Description
Auto	Input signals are automatically recognized as RGB or component.
RGB	Set when RGB signals are received.
YPbPr	Set when Component signals are received.

⑤ Setting the Video System

The video input system mode is factory preset to “Auto”; however, a clear picture from the connected audio-visual equipment may not be received, depending on the Video signal difference. In that case, switch the Video signal.

Selectable items
Auto
PAL
SECAM
*NTSC4.43
NTSC3.58
PAL-M
PAL-N
PAL-60

* When reproducing NTSC signals in PAL video equipment.

Note

- The Video signal can only be set in VIDEO or S-VIDEO mode.
- When “Video System” is set to “Auto”, you may not receive a clear picture due to signal differences. Should this occur, switch to the video system of the source signal.

⑥ Setting the Video Setup

Selectable items	Description
0 IRE	Sets the black level to 0 IRE.
7.5 IRE	Sets the black level to 7.5 IRE.

Note

- This function is available for the following signals.
With COMPUTER/COMPONENT 1 or 2 input:
- 480I
With S-VIDEO or VIDEO input:
- NTSC3.58

⑦ Selecting the Dynamic Range

An optimum picture may not be displayed if an HDMI capable device’s output signal type and the projector’s input signal type do not match. If this should occur, switch “Dynamic Range”.

Selectable items	Description
Auto	When the black levels of the image show banding or appear faded, select the item that results in the best picture quality. (In most circumstances, “Standard” should be selected.)
Standard	
Enhanced	

Note

- The Dynamic Range can be selected only when “HDMI” input mode is selected.

⑧ Checking the Input Signal

This function allows you to check the current input signal information.

Screen Adjustment (“SCR” Menu)

Menu operation → Page 46

	Picture	Audio	SIG	SCR	PRJ	Net.
①	—	—	—	↔ Normal	—	—
②	—	—	—	↔ Off	—	—
③	—	—	—	↔ On	—	—
④	—	—	—	↔ On	—	—
⑤	—	—	—	↔ Off	—	—
⑥	—	—	—	↔ Logo	—	—
⑦	—	—	—	↔ Front	—	—
⑧	—	—	—	↔ English	—	—

↔ SEL./ADJ.	↔ ENTER
↔ RETURN	↔ END

① Setting the Resize Mode

Note

- For details of the Resize mode, see pages **36** to **39**.
- You can also press **RESIZE** on the remote control to set the resize mode. (See page **36**.)

② Selecting the Wall Color

This function allows you to project the image to a colored (white or dark green) surface or wall without using a screen.

Selectable items	Description
Off	The Wall Color function is not activated.
Blackboard	Projects images onto a blackboard (dark green).
Whiteboard	Projects images onto a whiteboard.

③ Setting the Overscan

This function allows you to set the overscan area (display area).

Selectable items	Description
On	The input area is displayed without the screen edges.
Off	The whole input area is displayed.

Note

- This function is available for the following signals.
With COMPUTER/COMPONENT 1 or 2 input:
 - 480P
 - 540P
 - 576P
 - 720P
 - 1035I
 - 1080I/1080P
- If noise appears at the screen edges when “Off” is selected, set the function to “On”.
- Also see “About Copyrights” on page **39**.

④ Setting the On-screen Display

This function allows you to turn the on-screen messages on or off.

Selectable items	Description
On	All On-screen Displays are displayed.
Off	INPUT/VOLUME/AV MUTE/FREEZE/AUTO SYNC/RESIZE/PICTURE MODE/ECO+QUIET/MAGNIFY/ “An invalid button has been pressed.” are not displayed.

⑤ Closed Caption

<For Americas only>

Info

- This function is available for NTSC3.58 signal.
- This function may not work depending on the resize mode.

- “Closed Caption” is a system which allows conversations, narration, and sound effects in TV programs (Limited regions) and home videos to be viewed as captions on the screen.
- Not all programs and videos will offer closed captioning. Please look for the **CC** symbol to ensure that captions will be shown.
- Two channels are available: CC1 and CC2.

Selectable items	Description
Off	—
CC1	Closed Caption mode for CH1 data
CC2	Closed Caption mode for CH2 data

Note

- Closed Caption may malfunction (white blocks, strange characters, etc.) if signal conditions are poor or if there are problems at the broadcast source. This does not necessarily indicate a problem with the projector.

⑥ Selecting a Startup and Background Image

Selectable items	Description
Logo	SHARP default image
Blue	Blue screen
None	Black screen

⑦ Reversing/Inverting Projected Images

This projector is equipped with a reverse/invert image function that allows you to reverse or invert the projected image for various applications.

Selectable items	Description
Front	Normal image (Projected from the front of the screen)
Ceiling + Front	Inverted image (Projected from the front of the screen with an inverted projector)
Rear	Reversed image (Projected from the rear of the screen or with a mirror)
Ceiling + Rear	Reversed and inverted image (Projected with a mirror)

Note

- Refer to “Projection (PRJ) Mode” on page **21** for details.

⑧ Selecting the On-screen Display Language

The projector can switch the on-screen display language among 18 languages.

Helpful Functions Set during Installation (“PRJ” menu)

Menu operation → Page 46

	Picture	Audio	SIG	SCR	PRJ	Net.
①	Auto Power Off			On		
②	Auto Restart			On		
③	COMPUTER2 Select			Monitor Output		
④	STANDBY Mode			Standard		
⑤	RS-232C			9600bps		
⑥	Fan Mode			Normal		
⑦	System Lock			Disable		
⑧	DLP® Link™			Off		
⑨	DLP® Link™ Invert					
⑩	Memory Menu					
⑪	Rotate Indicator			On		
⑫	◆◆All reset					
⑬	Lamp Timer (Life)	[0]h [0]min (100%)				
	SEL./ADJ.			ENTER		
	RETURN			END		

① Auto Power Off Function

Selectable items	Description
On	The projector automatically enters the standby mode when no input signal is detected for 15 minutes or longer.
Off	The Auto Power Off function will be disabled.

Note

- When the Auto Power Off function is set to “On”, 5 minutes before the projector enters the standby mode, the message “Enter STANDBY mode in X min.” will appear on the screen to indicate the remaining minutes.

② Auto Restart Function

Selectable items	Description
On	If the power cord is unplugged from the outlet or the breaker switch is turned off when the projector is on, then the projector automatically turns on when the power cord is plugged into the AC outlet or the breaker switch is turned on.
Off	The projector does not turn on automatically when the power cord is plugged into the AC outlet or the breaker switch is turned on.

③ COMPUTER2 Select

You can also use the MONITOR OUT terminal as the COMPUTER/COMPONENT 2 terminal. Select whether to use the terminal as an input terminal or output terminal.

Selectable items	Description
Input	The terminal can be used as an input terminal (COMPUTER/COMPONENT 2).
Monitor Output	The terminal can be used as an output terminal (MONITOR OUT).

Note

- Set this before connecting the external equipment.
- The setting cannot be changed when Input mode is “COMPUTER 2”.

④ STANDBY Mode

When set to “Eco”, power consumption is reduced in Standby mode.

Selectable items	Description
Eco	The monitor output, RS-232C and Network functions are switched off in Standby mode.
Standard	The monitor output, RS-232C and Network functions are activated even if the projector is in Standby mode.

⑤ Selecting the Transmission Speed (RS-232C)

Make sure that both the projector and computer are set for the same baud rate.

Selectable items	Description
9600 bps	Transmission speed is slow. ↕ Transmission speed is rapid.
38400 bps	
115200 bps	

Note

- Refer to the “SETUP MANUAL” contained on the supplied CD-ROM for RS-232C Specifications and Command Settings.
- Refer to the computer’s operation manual for instructions for setting the computer’s baud rate.

⑥ Fan Mode Setting

This function changes the fan rotation speed.

Selectable items	Description
Normal	Suitable for normal environments.
High	Select this when using the projector at altitudes of approximately 1,500 meters (4,900 feet) or more.

When “Fan Mode” is set to “High”, the fan rotation speeds up, and the fan noise becomes louder.

⑦ System Lock Function

This function prevents unauthorized use of the projector. Once this function is activated, users must enter the correct keycode each time the projector is turned on. **We suggest you record the keycode in a safe place where only authorized users have access.**

Info

- If you lose or forget your keycode, contact your nearest Sharp Authorized Projector Dealer or Service Center (see page 84). Even if the product warranty is valid, the keycode reset will incur a charge.

■ Setting/Changing the keycode

1 Select “System Lock”, then press **ENTER** or **▶**.

2 Select “Next”, then press **ENTER**.

- The screen for entering the keycode appears.

3 Press the 4 buttons on the remote control or on the projector to enter the preset keycode in “Old Code”.

- When setting the keycode for the first time, press **▼** on the projector for four times.

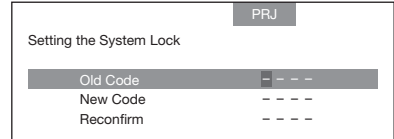

Note

- If you input a wrong keycode, the cursor returns to the first point of the “Old Code”.
- The preset keycode is 4 **▼** buttons on the projector. When you press the **▼** button four times, the keycode input screen disappears.

4 Press the 4 buttons on the remote control or on the projector to enter the new keycode in “New Code”.

Note

- You cannot use the following buttons for keycode: **STANDBY/ON, ON, STANDBY, ENTER, L-CLICK/EFFECT, R-CLICK/RETURN, MENU, ECO+QUIET, BREAK TIMER, ZOOM, FOCUS, H&V SHIFT, ROTATE, LENS, MEMORY MENU and MEMORY (1-8)**
- System lock function recognizes each button on the remote control or on the projector as an individual button, even if they share the same button name. **If you used the buttons on the projector in setting your keycode, the keycode cannot be canceled with the remote control.**

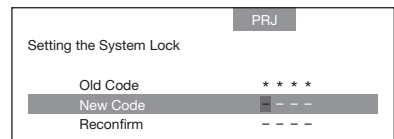

Helpful Functions Set during Installation (“PRJ” menu) (Continued)

Menu operation → Page 46

5 Enter the same keycode in “Re-confirm”.

Note

To cancel the keycode that you have already set

- Press ▼ on the projector for four times in steps 4 and 5 above.

When the System Lock is set

- When System Lock is set, the keycode input screen appears after the power is turned on. When it appears, enter the right keycode to start projection.

Input screen for keycode

System Lock

Taking the Keylock Off

Hold down **ENTER** on the projector for about 5 seconds.

On-screen display

Keylock function OFF

Info

- Even when Keylock function is set to “On”, **STANDBY/ON** on the projector can be used to turn on and off the power.
- Keylock cannot be set while the projector is: displaying the “Menu” screens, in Standby mode, warming up, changing input signals, operating the Auto Sync function, in Freeze mode or on the “System Lock” screen during warming up.

Keylock Function

Use this function to lock the operation buttons on the projector.

Locking the Operation Buttons

1 Hold down **ENTER** on the projector for about 5 seconds while the projector is being turned on.

- The Keylock function screen is displayed.

Use this function to lock the operation buttons on the projector.
(Except STANDBY/ON button)

Note: You can release the keylock by holding down **ENTER** on the projector for about 5 seconds.

Return

✓ On

SEL/ADJ.
RETURN

ENTER
END

8 DLP® Link™

See “Using 3D Viewing Mode” on page 67 for details.

9 DLP® Link™ Invert

See “Using 3D Viewing Mode” on page 67 for details.

2 Select “On”, then press **ENTER**.

On-screen display

Keylock function ON

- The Keylock function does not affect the operation with the remote control buttons.
- You cannot use the Keylock function while the projector is warming up.

⑩ Memory Menu

You can store the settings of the projector's lens shift (ZOOM, FOCUS) and others (such as INPUT, PICTURE MODE, RESIZE, Wall Color, PRJ Mode and KEYSTONE), or activate the stored settings.

You can also store the rotation angle when attaching the ceiling-mount rotating module (AN-SV100T) to the projector.

The Memory Menu screen can also be displayed by pressing **MEMORY MENU** on the remote control.

■ Load Memory

To activate the desired settings, select the item where the settings are stored.

Note

- Pressing any button while the projector is in the process of activating the "Load Memory" function will display messages:
 - "STOP": stops the activation of the "Load Memory" function.
 - "CONTINUE": allows the projector to the already set position.
 - "Return to the initial position.": let the projector go back to the initial position.
- The confirmation screen of "Load Memory" will also be displayed by pressing **MEMORY (1-8)** on the remote control. Press **MEMORY (1-8)** again to perform the "Load Memory" function.
- The memory has a margin of error of approximately $\pm 2\%$ (When the ceiling-mount rotating module (AN-SV100T) is attached, allow a margin of error of approximately ± 1.5 degrees). Use the remote control to make fine adjustments.

■ Save Memory

Select an item where you want to store the setting.

Note

- When you select an item where some setting has been stored, the stored setting will be overwritten and erased.

■ Memory Name

Select the item name you want to change. Use **◀/▶** to choose the characters to change, and **▲/▼** to select the characters to enter.

■ Clear Memory

Select the item where the settings you want to erase are stored. In this case, the memory name you have changed returns to the default setting.

Note

- Selecting "All Clear" erases all the stored settings.

■ Mute

Selectable items	Description
On	Does not display images while the projector is in the process of activating the "Load Memory" function.
Off	Displays images while the projector is in the activation process.

■ Memory Lock

Selectable items	Description
On	Protects the stored memories.
Off	Does not protect the stored memories.

⑪ Rotate Indicator

This function turns On/Off the Rotate indicator on the projector.

Selectable items	Description
On	The Rotate indicator lights up when the ceiling-mount rotating module (AN-SV100T) is connected. While the projector is rotating, the indicator blinks.
Off	The Rotate indicator does not light up.

Note

- This function only works when attaching the ceiling-mount rotating module to the projector.

Helpful Functions Set during Installation (“PRJ” menu) (Continued)

⑫ Returning to the Default Settings

This function allows you to initialize the settings you have made in the projector.



Note

The following items or menu cannot be initialized.

- “SIG” menu
Resolution
- “SCR” menu
Language
- “PRJ” menu
Lamp Timer (Life)
System Lock
COMPUTER2 Select
Memory Menu

⑬ Checking the Lamp Life Status

You can confirm the cumulative lamp usage time and the remaining lamp life (percentage).

Lamp usage condition	Remaining lamp life	
	“Life”	
	100%	5%
Operated exclusively while “Eco+Quiet” is “On”.	Approx. 2,500 hours	Approx. 125 hours
Operated exclusively while “Eco+Quiet” is “Off”.	Approx. 1,500 hours	Approx. 75 hours



Note

- It is recommended that the lamp be changed when the remaining lamp life becomes 5%.
- The lamp life may vary depending on the usage condition.

Setting Up the Projector Network Environment (“Net.” Menu)

Menu operation → Page 46

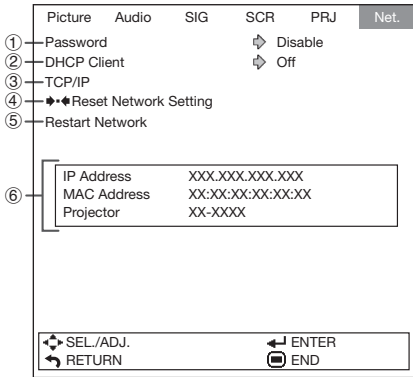

① Setting a Password

If you do not want others to change the setting for the “Net.” menu, set a password.

■ Setting a Password

- 1 Select “Password”, then press ►.
 - The screen for entering the password appears.

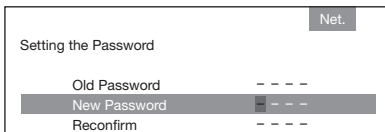

- 2 Press ▲ or ▼ to set the first digit in “New Password”, then press ►.

- 3 Enter the remaining 3 digits, then press ENTER.
 - To return to the previous digit, press ◀.

- 4 Enter the same password in “Reconfirm”, then press ENTER.
 - The status for “Password” changes to “Enable”.

Note

- Once after the password is set, you must enter the password to change the “Net.” menu settings.

■ Changing the Password

- 1 Select “Password”, then press ►.
 - The screen for entering the password appears.
- 2 Enter the password in “Old Password” using ▲, ▼, ► and ◀, then press ENTER.
- 3 Enter the password in “New Password” using ▲, ▼, ► and ◀, then press ENTER.
- 4 Enter the same password again in “Reconfirm” using ▲, ▼, ► and ◀, then press ENTER.

Note

- If you do not need the password protection for the “Net.” menu settings anymore, press ENTER without entering new password in steps 3 and 4.
- To cancel the password settings, press RETURN.

If you forget the password

If you forget the password, perform the following procedure to delete it, then set a new password.

On the projector, press



Note

- If ENTER is held down for more than 5 seconds, the operation buttons on the projector will be locked. (See page 58.)
- You cannot use the buttons on the remote control to delete the password.

Setting Up the Projector Network Environment (“Net.” Menu) (Continued)

Menu operation → Page 46

② DHCP Client Setting

Connect the LAN cable before turning the projector on. If not, the DHCP Client function does not work.

Selectable items	Description
On	Obtains configuration parameters for TCP/IP network automatically.
Off	Sets the TCP/IP manually.

Select “On” for “DHCP Client”. “Obtaining IP Address...” appears, then the menu screen appears. Confirm the parameters of IP Address, Subnet Mask and Gateway on the TCP/IP screen.

If the DHCP server is not available, “Could not obtain IP Address.” appears.

In this case, set the TCP/IP manually. (See the item ③.)

③ TCP/IP Setting

Set the TCP/IP manually.

1 Select “Off” for “DHCP Client”, then press **ENTER**.

2 Select “TCP/IP”, then press **ENTER**.

3 Enter “IP Address” using **▲**, **▼**, **▶** and **◀**, then press **ENTER**.

Setting the TCP/IP		Net.
IP Address	1 9 2 . 1 6 8 . 1 5 0 . 0 0 2	
Subnet Mask	2 5 5 . 2 5 5 . 2 5 5 . 0 0 0	
Gateway	0 0 0 . 0 0 0 . 0 0 0 . 0 0 0	

4 Enter “Subnet Mask” using **▲**, **▼**, **▶** and **◀**, then press **ENTER**.

5 Enter “Gateway” using **▲**, **▼**, **▶** and **◀**, then press **ENTER**.

Selectable items	Description
IP Address	Factory default setting: 192.168.150.002 Enter an IP address appropriate for the network.
Subnet Mask	Factory default setting: 255.255.255.000 Set the subnet mask to the same as that of the computer and equipment on the network.
Gateway	Factory default setting: 000. 000. 000. 000 * When not in use, set to “000. 000. 000. 000”.

Note

- Confirm the existing network’s segment (IP address group) to avoid setting an IP address that duplicates the IP addresses of other network equipment or computers. If “192.168.150.002” is not used in a network with an IP address of “192.168.150.XXX”, you don’t have to change the projector IP address.
- For details about each setting, consult your network administrator.

④ Returning to Default Settings (Network)

This function allows you to initialize the Network settings you have made in the projector.

Note

- If the values for IP Address, Subnet Mask or Gateway of the projector have been returned to the default settings, the computer cannot be connected to the projector depending on the computer’s network settings.

⑤ Restart Network Function

Restarts the network function.

Perform this function when the projector cannot be controlled via the network.

⑥ Confirming the Projector Information

You can confirm the following items.

Selectable items	Description
IP Address	The IP address of the projector is displayed.
MAC Address	The MAC address of the projector is displayed.
Projector	The projector name is displayed.

Note

- For information on how to change the projector name, see “SETUP MANUAL” contained in the supplied CD-ROM.

Viewing Stereoscopic 3D Images

Precautions on Viewing Stereoscopic 3D Images

Before viewing stereoscopic 3D images, please read this section carefully.

WARNING

- Under normal conditions, viewing stereoscopic 3D images is safe for any duration that you would normally view your screen. However, some people may experience discomfort. The following precautions are recommended to minimize the potential for experiencing visual problems or any adverse symptoms.
- Take regular breaks, at least 5 to 15 minutes after every 30 to 60 minutes of stereoscopic 3D viewing.
 - * Based on the guidelines issued by the 3D Consortium revised December 10, 2008.
- Maintain an appropriate distance from the screen. Viewing from too close a distance can strain your eyes. If you experience eye strain, immediately discontinue viewing.

If you experience any of the following symptoms during viewing:

- nausea
- queasiness/dizziness
- headache
- blurry vision or double vision that lasts longer than few seconds

Do not engage in any potentially hazardous activity (for example, driving a vehicle) until your symptoms have completely gone away. If symptoms persist, discontinue use and do not resume stereoscopic 3D viewing without discussing your symptoms with a physician.

- As you get more comfortable viewing stereoscopic 3D:
 - Adjust the parallax on the 3D-video playback equipment. (You may not be able to adjust the parallax on some models of equipment.)
 - Adjust the projected image to the most comfortable viewing size by zooming. (Projecting images on the smallest or largest screen size possible may eliminate the stereoscopic effect and strain your eyes.)
 - Use the DLP® Link™ Invert function to properly set the video for your left and right eyes. (For details on using “DLP® Link™ Invert”, see the section on its operation in this operation manual.)

WARNING

- The following people should limit stereoscopic 3D viewing:
 - Children under 6 years of age (to protect the eye growth process)
 - People with a history of photosensitivity
 - People with heart disease
 - People in poor health
 - People who are sleep deprived
 - People who are physically tired
 - People under the influence of drugs or alcohol

■ **Epilepsy**

A small percentage of the population may experience epileptic seizures when viewing certain types of images that contain flashing patterns of light.

IF YOU OR ANY MEMBER OF YOUR FAMILY HAS A HISTORY OF EPILEPSY

The following people should consult a physician before viewing stereoscopic 3D images.

- Anyone with a history of epilepsy, or who has a family member with a history of epilepsy
- Children under 6 years of age
- Anyone who has ever experienced epileptic seizures or sensory disturbances triggered by flashing light effects

SOME LIGHT PATTERNS MAY INDUCE SEIZURES IN PERSONS WITH NO PRIOR HISTORY OF EPILEPSY

Discontinue use if you experience any of the following symptoms while viewing stereoscopic 3D images.

- Involuntary movements, eye or muscle twitching
- Muscle cramps
- Nausea, dizziness, or queasiness
- Convulsions
- Disorientation, confusion, or loss of awareness of your surroundings

Viewing Stereoscopic 3D Images (Continued)

Information on the 3D Projection Function

- To display 3D images, this projector requires:

WHAT YOU WILL NEED

- 1) Source devices that support the field sequential format
 - For details on the supported signals, see the Compatibility Chart in this operation manual.
 - 2) 3D LCD shutter glasses that support the DLP® Link™* system
 - Contact your nearest Sharp Authorized Projector Dealer for purchasing details.
 - * DLP® Link™ is a trademark of Texas Instruments.
- The projected image may become dark when using the 3D projection function (with “DLP® Link™ ” set to “On”).
 - When “DLP® Link™” is set to “On”, the following functions may not work fully or may not be available at all.
 - Keystone
 - Resize
 - Magnify
 - 3D formats except for the field sequential method, such as ones used for Blu-ray 3D or DVD prepackaged media, are not compatible with this projector. (As of February 2011)
 - If the power of your left and right eyes greatly differs and you primarily use one eye for viewing the images, the images will not appear in 3D.

In addition, images may be difficult to view in 3D or images may not be able to be viewed in 3D depending on the individual or the content being displayed.
The stereoscopic effect varies with the individual.
 - 3D viewing is possible within the range that the 3D LCD shutter glasses are able to receive light signals reflected by the screen. However, most 3D images are manufactured to be viewed from directly in front of the screen, so 3D viewing is recommended directly in front of the screen as much as possible.
 - The range for receiving signals varies depending on the 3D LCD shutter glasses. For details, see the operation manual of your 3D LCD shutter glasses.
 - 3D images may not be able to be played back correctly on your computer.

Using 3D Viewing Mode

Use the following procedure to project 3D images.

For operation of the 3D LCD shutter glasses and the 3D-video playback equipment, see the corresponding operation manual.

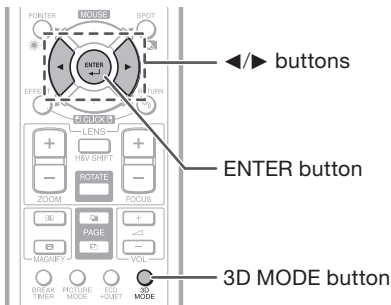

Projecting 3D images

- 1 Turn the projector on.
- 2 Turn the 3D-video playback equipment on.
 - Set the 3D-video playback equipment so that it outputs one of the signals listed in the Compatibility Chart in this operation manual.
- 3 Switch the Input mode of the projector to enable input of 3D video signals.
- 4 Operate the 3D-video playback equipment and play back the 3D content.
- 5 Turn the 3D LCD shutter glasses on and place them over your eyes.

- 6 Press **3D MODE** on the remote control to display the 3D MODE menu.

Info

- If "An invalid button has been pressed." is displayed, a 3D-compatible signal is not being input. Check the output signal on the playback equipment.

- 7 Press **▶** to set "DLP® Link™" to "On".

- 8 Press **ENTER** to switch the mode and enable more natural 3D image viewing.

Warning!

- If the projector, 3D-video playback equipment, and 3D LCD shutter glasses are not properly set, you may experience eye strain in addition to not being able to view the images in 3D.

- 9 Press **3D MODE**.
 - The 3D MODE menu will disappear.

Note

- If the images are not displayed in 3D, repeat steps 6 to 8.
- You can also use "DLP® Link™" and "DLP® Link™ Invert" on the menu screen to change the 3D setting.

Ending 3D projection

- 1 Press **3D MODE** on the remote control to display the 3D MODE menu.
- 2 Press **◀** to set "DLP® Link™" to "Off".
- 3 Press **3D MODE**.
 - The 3D MODE menu will disappear.

Viewing Stereoscopic 3D Images (Continued)

Appendix

■ How the 3D Projection Function (DLP Link™) Works

The 3D projection function of this projector is compatible with the DLP® Link™ system. To watch 3D images, you use a pair of 3D LCD shutter glasses that alternately display the projected images for the left and right eyes and are synchronized with a control (light) signal.

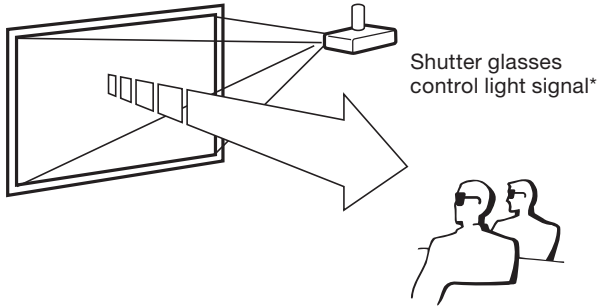

* The control light signal is transmitted from the lens of the projector, reflected by the screen, and received by the light reception sensor on the 3D LCD shutter glasses. Therefore, the range of 3D viewing varies depending on the specifications of the 3D LCD shutter glasses (light signal receiving sensitivity).

For details, see the operation manual of your 3D LCD shutter glasses.

■ For more information on the 3D projection function

Future information on the 3D projection function will be posted on the following web site.
<http://www.sharp-world.com/projector/>

Maintenance

Cleaning the projector

- Ensure that you have unplugged the power cord before cleaning the projector.
- The cabinet as well as the operation panel is made of plastic. Avoid using benzene or thinner, as these can damage the finish on the cabinet.
- Do not use volatile agents such as insecticides on the projector. Do not attach rubber or plastic items to the projector for long periods. The effects of some of the agents in the plastic may cause damage to the quality or finish of the projector.
- Wipe off dirt gently with a soft flannel cloth. Using a chemical cloth (wet/dry sheet type cloth, etc.) may deform the components of the cabinet or cause cracking.
- Wiping with a hard cloth or using strong force may scratch the cabinet surface.
- When the dirt is hard to remove, soak a cloth in a mild detergent diluted with water, wring the cloth well and then wipe the projector. Strong cleaning detergents may discolor, warp or damage the coating on the projector. Make sure to test on a small, inconspicuous area on the projector before use.

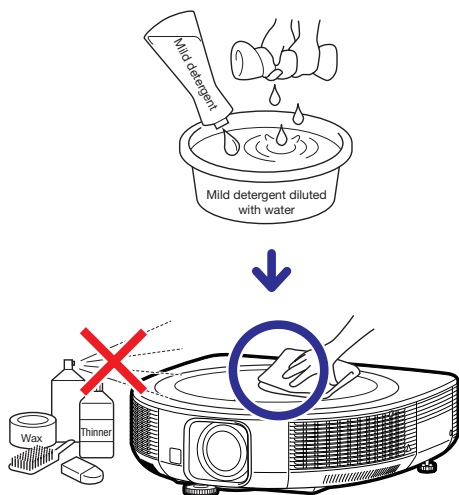

Cleaning the lens or lens cover

- Use a commercially available blower or lens cleaning paper (for glasses and camera lenses) for cleaning the lens or lens cover. Do not use any liquid type cleaning agents, as they may wear off the coating film on the surface of the lens or lens cover.
- As the surface of the lens or lens cover can easily get damaged, be careful not to scrape or hit the lens or lens cover.

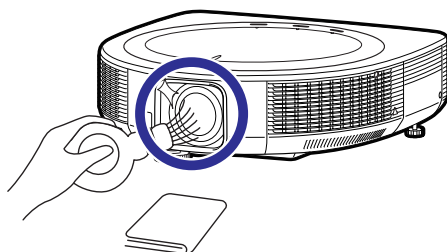

Cleaning the exhaust and intake vents

- Use a vacuum cleaner to clean dust from the exhaust vent and the intake vent.

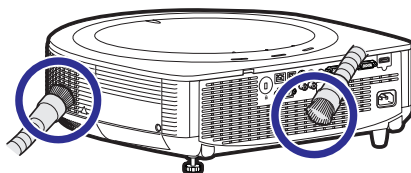

Info

- If you want to clean the air vents during projector operation, ensure you press **STANDBY/ON** on the projector or **STANDBY** on the remote control and put the projector into Standby mode. After the cooling fan has stopped, clean the vents.

Maintenance Indicators

- The warning lights (power indicator, lamp indicator and temperature warning indicator) on the projector indicate problems inside the projector.
- If a problem occurs, either the temperature warning indicator or the lamp indicator will illuminate red, and the projector will enter Standby mode. After the projector has entered Standby mode, follow the procedures given below.

Top View

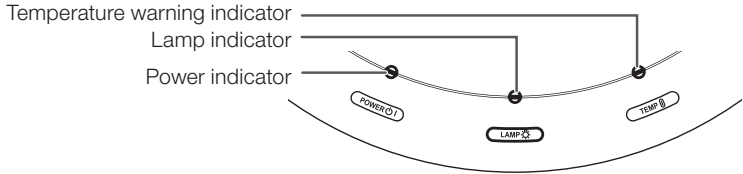



About the temperature warning indicator



If the temperature inside the projector increases, due to blockage of the air vents, or the setting location, the temperature warning indicator will blink. And if the temperature keeps on rising, “ TEMP.” will illuminate in the lower left corner of the picture with the temperature warning indicator blinking. If this state continues, the lamp will turn off, the cooling fan will run and then the projector will enter Standby mode. When you find the temperature warning indicator blinking, be sure to perform the measures described on page 71.

About the lamp indicator



- When the remaining lamp life becomes 5% or less,  (yellow) and “Change The Lamp.” will be displayed on the screen. When the percentage becomes 0%, it will change to  (red), the lamp will automatically turn off and then the projector will automatically enter Standby mode. At this time, the lamp indicator will illuminate in red.
- **If you try to turn on the projector a fourth time without replacing the lamp, the projector will not turn on.**

Indicators on the Projector

Power indicator	Red on	Normal (Standby)
	Green on	Normal (Power on)
	Red blinks	Abnormal (See page 71.)
	Green blinks	Normal (Cooling)
Lamp indicator	Green on	Normal
	Green blinks	The lamp is warming up.
	Red on	The lamp is shut down abnormally or requires to be changed. (See page 71.)
Temperature warning indicator	Off	Normal
	Red on/Red blinks	The internal temperature is abnormally high. (See page 71.)

Maintenance indicator			Problem	Cause	Possible Solution
	Normal	Abnormal			
Temperature warning indicator	Off	Red blinks (On)/ Red on (Standby)	The internal temperature is abnormally high.	<ul style="list-style-type: none"> • Temperatures around the projector are high. • Blocked air intake 	<ul style="list-style-type: none"> • Use the projector in an area with a temperature of lower than 95°F (+35°C). • Relocate the projector to an area with proper ventilation. (See page 8.)
				<ul style="list-style-type: none"> • Cooling fan breakdown • Internal circuit failure • Clogged air intake 	
Lamp indicator	Green on (Green blinks when the lamp is warming up.)	Red on	The lamp does not illuminate.	<ul style="list-style-type: none"> • The lamp is shut down abnormally. 	<ul style="list-style-type: none"> • Disconnect the power cord from the AC outlet, and then connect it again. • Carefully replace the lamp. (See page 72.) • Take the projector to your nearest Sharp Authorized Projector Dealer or Service Center (see page 84) for repair. • Please exercise care when replacing the lamp. • Securely install the cover.
		Red on (Standby)	Time to change the lamp. The lamp does not illuminate.	<ul style="list-style-type: none"> • Remaining lamp life becomes 5% or less. • Burnt-out lamp • Lamp circuit failure 	
Power indicator	Green on/ Red on/ Green blinks (Cooling)	Red blinks	The power indicator blinks in red when the projector is on.	<ul style="list-style-type: none"> • The lamp unit cover is open. 	<ul style="list-style-type: none"> • If the power indicator blinks in red even when the lamp unit cover are securely installed, contact your nearest Sharp Authorized Projector Dealer or Service Center (see page 84) for advice.

Info

- If the temperature warning indicator illuminates, and the projector enters Standby mode, follow the possible solutions above and then wait until the projector has cooled down completely before plugging in the power cord and turning the power back on. (At least 10 minutes.)
- If the power is turned off for a brief moment due to power outage or some other cause while using the projector, and the power supply recovers immediately after that, the lamp indicator will illuminate in red and the lamp may not be lit. In this case, unplug the power cord from the AC outlet, replace the power cord in the AC outlet and then turn the power on again.
- The cooling fan keeps the internal temperature of the projector constant and this function is controlled automatically. The sound of the cooling fan may change during operation because the fan speed may change and this is not a malfunction.

Regarding the Lamp

Lamp

- It is recommended that the lamp (sold separately) be replaced when the remaining lamp life becomes 5% or less, or when you notice a significant deterioration in the picture and color quality. The lamp life (percentage) can be checked with the on-screen display. (See page 60.)
- Purchase a replacement lamp of type AN-SV10LP from your place of purchase, nearest Sharp Authorized Projector Dealer or Service Center.

IMPORTANT NOTE TO U.S. CUSTOMERS:

The lamp included with this projector is backed by a 90-day parts and labor limited warranty. All service of this projector under warranty, including lamp replacement, must be obtained through a Sharp Authorized Projector Dealer or Service Center. For the name of the nearest Sharp Authorized Projector Dealer or Service Center, please call toll-free: 1-888-GO-SHARP (1-888-467-4277).

Hg LAMP CONTAINS MERCURY For State Lamp Disposal Information

www.lamprecycle.org or 1-800-BE-SHARP

U.S.A ONLY

Caution Concerning the Lamp

- This projector utilizes a pressurized mercury lamp. A loud sound may indicate lamp failure. Lamp failure can be attributed to numerous sources such as: excessive shock, improper cooling, surface scratches or deterioration of the lamp due to a lapse of usage time.
The period of time up to failure largely varies depending on the individual lamp and/or the condition and the frequency of use. It is important to note that failure can often result in the bulb cracking.
- When the lamp replacement indicator and on-screen display icon are illuminated, it is recommended that the lamp be replaced with a new one immediately, even if the lamp appears to be operating normally.
- Should the lamp break, there is also a possibility that glass particles may spread inside of the projector. In such a case, it is recommended you contact your nearest Sharp Authorized Projector Dealer or Service Center to assure safe operation.
- Should the lamp break, the glass particles may spread inside the lamp cage or gas contained in the lamp may be vented into the room from the exhaust vent. Because the gas in this lamp includes mercury, ventilate the room well if the lamp breaks and avoid all exposure to the released gas. In case of exposure to the gas, consult a doctor as soon as possible.

Replacing the Lamp



Caution

- Do not remove the lamp unit from the projector right after use. The lamp will be very hot and may cause burns or injury.
 - Wait at least one hour after the power cord is disconnected to allow the surface of the lamp unit to fully cool before removing the lamp unit.
 - **Carefully change the lamp by following the instructions described in this section.**
 - * **If you wish, you may have the lamp replaced at your nearest Sharp Authorized Projector Dealer or Service Center.**
- * If the new lamp does not light after replacement, take your projector to the nearest Sharp Authorized Projector Dealer or Service Center for repair.

Removing and Installing the Lamp Unit



Warning!

- Do not remove the lamp unit from the projector right after use. The lamp and parts around the lamp will be very hot and may cause burns or injury.



Info

- Do not touch the glass surface of the lamp unit or the inside of the projector.
- To avoid injury to yourself and damage to the lamp, make sure you carefully follow the steps below.
- Do not loosen other screws except for the lamp unit cover and lamp unit.

- 1 Press **STANDBY/ON** on the projector or **STANDBY** on the remote control to put the projector into Standby mode.**

- 2 Disconnect the power cord.**

- Unplug the power cord from the AC socket.
- Leave the lamp until it has fully cooled down (about 1 hour).

- 3 Remove the lamp unit cover.**

- Loosen the user service screw (①) that secures the lamp unit cover. Remove the lamp unit cover (②).

Optional
accessory

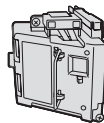

Lamp unit
AN-SV10LP

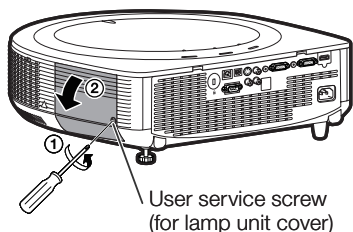
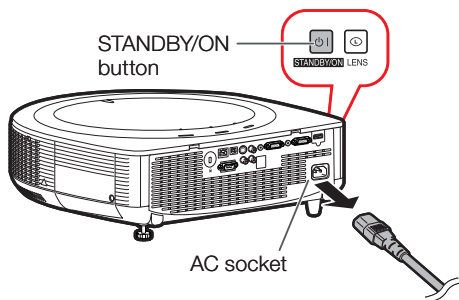

Regarding the Lamp (Continued)

4 Remove the lamp unit.

- Loosen the securing screws from the lamp unit. Hold the lamp unit by the handle and pull it in the direction of the arrow. At this time, keep the lamp unit horizontal and do not tilt it.

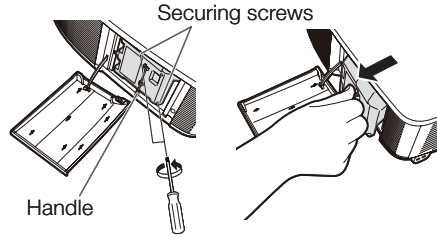

5 Insert the new lamp unit.

- Press the lamp unit firmly into the lamp unit compartment. Fasten the securing screw.

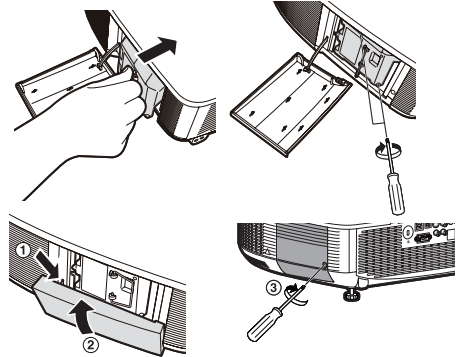

6 Replace the lamp unit cover.

- Align the tab on the lamp unit cover (1) and close it (2). Be careful not to get the strap caught in the cover. Then tighten the user service screw (3) to secure the lamp unit cover.

Info

- If the lamp unit and lamp unit cover are not correctly installed, the power will not turn on, even if the power cord is connected to the projector.

Resetting the Lamp Timer

Reset the lamp timer after replacing the lamp.

Info

- Make sure to reset the lamp timer only when replacing the lamp. If you reset the lamp timer and continue to use the same lamp, this may cause the lamp to become damaged or explode.

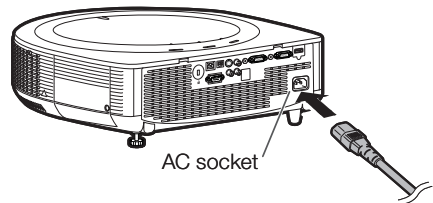

1 Connect the power cord.

- Plug the power cord into the AC socket of the projector.

2 Reset the lamp timer.

- While simultaneously holding down **MENU**, **ENTER** and **▼** on the projector, press **STANDBY/ON** on the projector and keep all four buttons pressed down until the lamp indicator starts blinking green.
- "LAMP 0000H" is displayed, indicating that the lamp timer is reset.

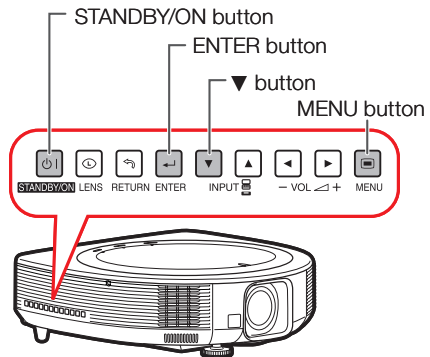

Compatibility Chart

Computer

- Multiple signal support
Horizontal Frequency: 15-110 kHz,
Vertical Frequency: 45-85 Hz,

- Pixel Clock: 12-165 MHz
Sync signal: Compatible with TTL level
- Compatible with sync on green signal

PC/MAC	Mode	Resolution	Horizontal frequency [kHz]	Vertical frequency [Hz]	Analog Support	Digital Support	Display	
							XG-SV100W	XG-SV200X
PC	VGA	640 × 480	26.2	50	✓		Upscale	Upscale
			31.5	60	✓	✓		
			34.7	70	✓			
			37.9	72	✓	✓		
			37.5	75	✓	✓		
			43.3	85	✓			
	SVGA	800 × 600	31.3	50	✓			
			35.2	56	✓	✓		
			37.9	60	✓	✓		
			46.8	70	✓	✓		
			48.1	72	✓	✓		
			46.9	75	✓	✓		
	XGA	1024 × 768	53.7	85	✓			
			40.3	50	✓			
			48.4	60	✓	✓		
			56.5	70	✓	✓		
			60.0	75	✓	✓		
			68.7	85	✓			
	WXGA	1280 × 800	45.0	60	✓	✓	TRUE	TRUE
			47.8	60	✓	✓		
			49.7	60	✓	✓		
			62.8	75	✓	✓		
			47.7	60	✓	✓		
			47.8	60	✓	✓		
	WXGA+	1440 × 900	55.9	60	✓			
			55.0	60	✓			
SXGA	1152 × 864	66.2	70	✓		Intelligent Compression	Intelligent Compression	
		67.5	75	✓				
		60.0	60	✓	✓			
		75.0	75	✓				
		64.0	60	✓	✓			
		80.0	75	✓	✓			
SXGA+	1400 × 1050	64.0	60	✓	✓			
		65.3	60	✓	✓			
WSXGA+	1680 × 1050	65.3	60	✓	✓			
		65.0	60	✓	✓			
UXGA	1600 × 1200	75.0	60	✓				
		75.0	60	✓				
MAC 13"	VGA	640 × 480	34.9	67	✓			
MAC 16"	SVGA	832 × 624	49.7	75	✓		Upscale	
MAC 19"	XGA	1024 × 768	60.2	75	✓		TRUE	
MAC 21"	SXGA	1152 × 870	68.7	75	✓		Intelligent Compression	

Note

- Optimum image quality will be achieved by matching your computer's output resolution to the resolution that corresponds to "TRUE" in the "Display" column shown above.
- When "Screen resolution" of the computer is different from the resolution displayed on the projected image, follow the procedures shown below.
 - Refer to "Resolution" on the "SIG" menu and select the same resolution as the resolution in "Screen resolution" of the computer.
 - Depending on the computer you are using, the output signal may not be faithful to the "Screen resolution" adjustment. Check the settings of the computer's signal output. If the settings cannot be changed, it is recommended that the resolution be set to the one that corresponds to "TRUE" in the "Display" column.

Compatibility Chart (Continued)

3D Supported Signals

Signal		Horizontal Frequency (kHz)	Vertical Frequency (Hz)	Analog Support	Digital Support
SVGA	800 × 600	37.9	60	✓	✓
		77.1	120		✓
XGA	1024 × 768	48.4	60	✓	✓
		98.6	120		✓
WXGA	1280 × 800	49.7	60	✓	✓
		101.6	120 ^{*1}		✓
	1280 × 720	45.0	60	✓	✓
		92.6	120		✓

*1 Reduced Blanking

Note

- Your computer graphics card must be able to display 3D stereoscopic signals. Please check with your computer/graphic card specifications or call your computer manufacturer to ensure this capability.

DTV

Signal	Horizontal Frequency (kHz)	Vertical Frequency (Hz)	Analog Support	Digital Support	Signal	Horizontal Frequency (kHz)	Vertical Frequency (Hz)	Analog Support	Digital Support
480I	15.7	60	✓		1080I	28.1	50	✓	✓
480P	31.5	60	✓	✓	1080I	33.8	60	✓	✓
540P	33.8	60	✓		1080P	27.0	24		✓
576I	15.6	50	✓		1080P	28.1	25		✓
576P	31.3	50	✓	✓	1080P	33.8	30		✓
720P	37.5	50	✓	✓	1080P	56.3	50	✓	✓
720P	45.0	60	✓	✓	1080P	67.5	60	✓	✓
1035I	33.8	60	✓						

Attaching the Ceiling-mount Rotating Module (AN-SV100T)

1 Press **STANDBY/ON** on the projector or **STANDBY** on the remote control to put the projector into Standby mode. Then disconnect the power cord.

2 Turn over the projector and place it upside down on a flat surface. Remove the connector cover.

3 Place the ceiling-mount rotating module on the bottom of the projector so that it is aligned with the module installation holes on the projector. (Make sure the three position-setting pins on the module are inserted into the position-setting holes on the projector.)

4 Using the supplied bolts, attach the ceiling-mount rotating module to the projector. First, lightly screw all four bolts and then tighten them firmly.

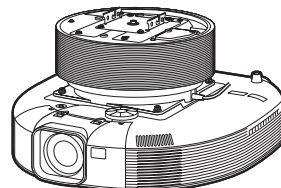
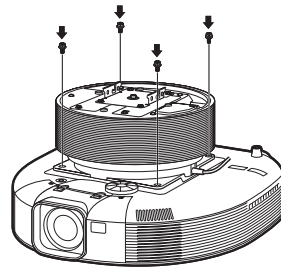
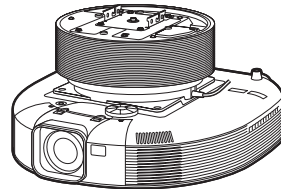
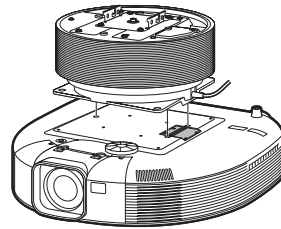
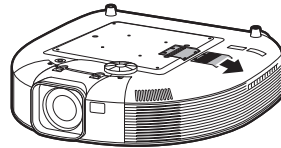

Attaching the Terminal Cover to the Module

- 1** Fix the hooks of the terminal covers (①) and fit the small protrusions on the covers into the slots on the ceiling-mount rotating module (AN-SV100T) (②).

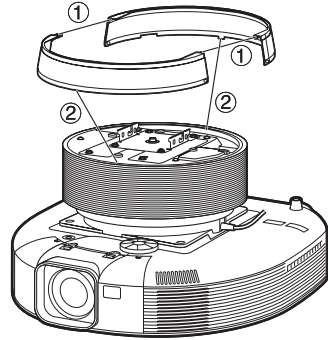

- 2** Fasten the terminal covers at the two points with the supplied screws.

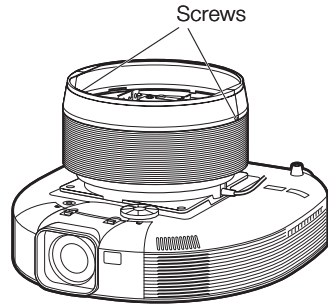

Attaching the Ceiling Mount to the Ceiling

When installed with the AN-TK201

1 Attach the ceiling mount to the ceiling.

- First, lightly screw an installation bolt into the smallest hole **1** and then proceed, doing the same for the holes **2**, **3** and **4**. Once the position has been decided, firmly tighten all four bolts.
- Use M8-type bolts. (Bolt type may vary depending on the method of installation.)
- Use the washers supplied with the ceiling mount.

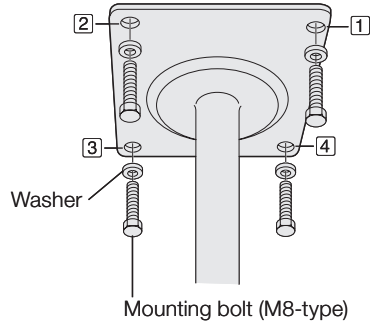

2 Attach the height-adjustment pole to the ceiling mount.

1. Insert the height-adjustment pole **1** into the ceiling mount.
2. Fix the pole in place with the sleeve and pole-fixing bolt **2**, according to the height of the screen.
3. Lock the bolt in place with the securing nut **3**.
4. Screw in the two stabilizing screws **4**.
5. Tighten the securing nut **3** firmly and fit the pin **5** into the hole on the pole-fixing bolt.

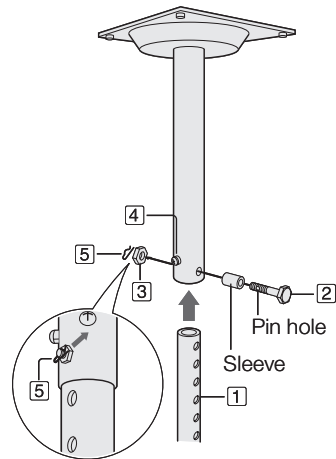

! Caution

- Ask your dealer or service shop to install the ceiling mount. Sharp will assume no responsibility whatsoever if inadequate installation causes your projector or attached devices to fall out of place.

Attaching the Ceiling Mount to the Ceiling (Continued)

When installed with the AN-TK202

1 Attach the ceiling mount to the ceiling.

- First screw a bolt into the hole **1** (smallest hole) and tighten it enough to keep the mount in place. Then, do the same for the holes **2**, **3** and **4**.

Position the four corners correctly, and then tighten all bolts firmly.



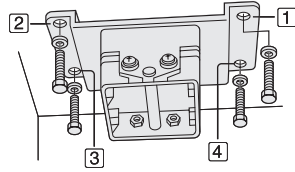

- Use M8-type bolts. (Bolt type may vary depending on the method of installation.)
- Use the washers supplied with the ceiling mount.



Caution

- Ask your dealer or service shop to install the ceiling mount. Sharp will assume no responsibility whatsoever if inadequate installation causes your projector or attached devices to fall out of place.

Troubleshooting

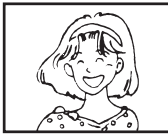
Problem	Check	Page
 No picture and no sound or projector does not start.	<ul style="list-style-type: none"> Projector power cord is not plugged into the wall outlet. 	26
	<ul style="list-style-type: none"> Power to the external connected devices is off. 	–
	<ul style="list-style-type: none"> The selected Input mode is wrong. 	34
	<ul style="list-style-type: none"> The AV Mute function is working. 	35
	<ul style="list-style-type: none"> Cables are incorrectly connected to the projector. 	22–26
	<ul style="list-style-type: none"> Remote control battery has run out. 	15
 Sound is heard but no picture appears (or picture is dark).	<ul style="list-style-type: none"> External output has not been set when connecting a notebook computer. 	22
	<ul style="list-style-type: none"> The lamp unit cover is not installed correctly. 	73, 74
	<ul style="list-style-type: none"> Cables are incorrectly connected to the projector. “Bright” is set to minimum position. Depending on the computer you are using, an image may not be projected unless the signal output setting of the computer is switched to the external output. Refer to the computer’s operation manual for how to switch its signal output settings. Is “On” selected in “DLP® Link™”? 	22–26 48 67
Dark or bluish image	<ul style="list-style-type: none"> Check that “Wall Color” is configured correctly. 	54
 Color is faded or poor.	<ul style="list-style-type: none"> Image adjustments are incorrectly set. Make adjustments of “Color” and “Tint” in “Picture Mode” and lower the “BrilliantColor™” value. 	48
	(S-Video, Video Input only) <ul style="list-style-type: none"> Video input system is incorrectly set. (COMPUTER/COMPONENT 1, 2 Input only)	53
	<ul style="list-style-type: none"> Input signal type (RGB/Component) is incorrectly set. 	52
 Picture is blurred; noise appears.	<ul style="list-style-type: none"> Adjust the focus. 	30
	<ul style="list-style-type: none"> The projection distance exceeds the focus range. 	19, 20
	<ul style="list-style-type: none"> There is fog on the lens. If the projector is carried from a cold room into a warm room, or if it is suddenly heated, condensation may form on the surface of the lens and the image will become blurred. Set up the projector at least one hour before it is to be used. If condensation should form, remove the power cord from the wall outlet and wait for it to clear. 	–
 Picture appears but no sound is heard.	(Computer Input only) <ul style="list-style-type: none"> Perform “SIG” Adjustments (“Clock” and “Phase” Adjustment) Noise may appear depending on the computer. 	52 –
	<ul style="list-style-type: none"> Cables are incorrectly connected to the projector. Volume is set to minimum. When the projector is connected to an external device and the volume is set to minimum, the sound is not output even if you turn up the volume of the external device. 	22–26 35
	<ul style="list-style-type: none"> “Speaker” is set to “Off”. 	51
Data image is not centered.	<ul style="list-style-type: none"> Make the necessary adjustments of each item in the “SIG” menu. 	52
	<ul style="list-style-type: none"> Depending on the computer you are using, the output resolution signal may be different from the one you have set. For details, refer to the operation manual of the computer. 	–
An unusual sound is occasionally heard from the cabinet.	<ul style="list-style-type: none"> If the picture is normal, the sound is due to cabinet shrinkage caused by room temperature changes. This will not affect operation or performance. 	–

Troubleshooting (Continued)

Problem	Check	Page
Maintenance indicator on the projector illuminates or blinks in red.	<ul style="list-style-type: none"> • See "Maintenance Indicators". 	70
Picture is green on COMPUTER (YPbPr)	<ul style="list-style-type: none"> • Change the input signal type setting. 	52
Picture is pink (no green) on COMPUTER (RGB)		
Picture is too bright and whitish.	<ul style="list-style-type: none"> • Image adjustments are incorrectly set. 	48
The cooling fan becomes noisy.	<ul style="list-style-type: none"> • When temperature inside the projector increases, the cooling fan runs faster. 	8, 9 69, 70, 71
The lamp does not light up even after the projector turns on.	<ul style="list-style-type: none"> • The lamp indicator is illuminating in red. Replace the lamp. 	70, 73, 74
The lamp suddenly turns off during projection.		
The image sometimes flickers.	<ul style="list-style-type: none"> • Cables are incorrectly connected to the projector or the connected equipment works improperly. • If this happens frequently, replace the lamp. 	22–26 73
The lamp needs much time to turn on.	<ul style="list-style-type: none"> • The lamp will eventually need to be changed. While the remaining lamp life draws to a close, replace the lamp. 	73
Picture is dark.		
The remote control cannot be used.	<ul style="list-style-type: none"> • Operate the remote control while pointing it at the projector's remote control sensor. • The remote control may be too far away from the projector. • When using the ceiling-mount rotating module (AN-SV100T) and rotating the projector, the signal transmission to the sensor may not work depending on the rotation angle of the projector. • If direct sunlight or a strong fluorescent lamp is shining on the projector's remote control sensor, place the projector where it will not be affected by strong light. 	15 –
	<ul style="list-style-type: none"> • The batteries may be depleted or inserted incorrectly. Make sure the batteries are inserted correctly or insert new ones. 	15
The Rotate indicator does not light up.	<ul style="list-style-type: none"> • Is "Off" selected in "Rotate Indicator" ? • Check the connection of the ceiling-mount rotating module (AN-SV100T) and projector. 	59 –
The lens shift function does not work.	<ul style="list-style-type: none"> • The lens cover is not attached correctly. 	12

Problem	Check	Page
3D images flicker when watching in a room.	<ul style="list-style-type: none"> • Images may appear to flicker when fluorescent light or ambient light enters your vision. <ul style="list-style-type: none"> – Turn off the lights. – Block any ambient light. 	–
Ghosting (a double image) occurs without the image appearing in 3D.	<ul style="list-style-type: none"> • Check that you are using 3D LCD shutter glasses that support the DLP® Link™ system. <ul style="list-style-type: none"> – Be sure to use 3D LCD shutter glasses that support the DLP® Link™ system. 	–
	<ul style="list-style-type: none"> • Check that the shutters on the 3D LCD shutter glasses are working properly. <ul style="list-style-type: none"> – Turn the 3D LCD shutter glasses off and then on again. – Check the batteries of the 3D LCD shutter glasses. – Check that the 3D LCD shutter glasses are set to 3D viewing mode. Some 3D LCD shutter glasses are equipped with a special viewing mode (such as “dual view mode”) in addition to the normal 3D viewing mode. See the operation manual of your 3D LCD shutter glasses. 	–
	<ul style="list-style-type: none"> • Check the settings of the projector. <ul style="list-style-type: none"> – Turn the DLP® Link™ function “On”. – Use “DLP® Link™ Invert” to change the setting. 	–
	<ul style="list-style-type: none"> • Check whether a signal that is not supported is being input. <ul style="list-style-type: none"> – Configure your 3D application at the correct resolution and refresh rate. <p>Make sure you are running your 3D application in resolutions that support 3D. To support 3D, your 3D application must be configured to run at the correct settings for this projector.</p> <p>For details on the supported signals, see “3D Supported Signals” of the Compatibility Chart.</p> 	76
	<ul style="list-style-type: none"> • If the projector is connected to a computer for 3D image playback, check that a stereoscopically-enabled application is being used. <ul style="list-style-type: none"> – Use the applicable software. – Set the applicable software to the field sequential format. 	–
	<ul style="list-style-type: none"> • Check that there are no obstructions between the screen and the 3D LCD shutter glasses. <ul style="list-style-type: none"> – Remove any obstructions. <p>Any obstructions may cause the glasses not to function properly causing the lenses to flicker or turn off. Do not place your hand or other objects in front of the 3D control signal sensor on the glasses.</p> 	–
	<ul style="list-style-type: none"> • Check whether there is a source of high intensity lighting nearby. <ul style="list-style-type: none"> – Block the light or turn it off. <p>High intensity lighting can interfere with communication between the 3D LCD shutter glasses and the screen resulting in some flicker.</p> 	–
	<ul style="list-style-type: none"> • Check whether two or more projectors are projecting 3D images at the same time. <ul style="list-style-type: none"> – Use only one projector at a time. 	–

This unit is equipped with a microprocessor. Its performance could be adversely affected by incorrect operation or interference. If this should happen, unplug the Unit and plug it in again after more than 5 minutes.

For SHARP Assistance

If you encounter any problems during setup or operation of this projector, first refer to the “Troubleshooting” section on pages 81 to 83. If this operation manual does not answer your question, please contact the SHARP Service departments listed below.

U.S.A.	Sharp Electronics Corporation 1-888-GO-SHARP (1-888-467-4277) lcdsupport@sharpsec.com http://www.sharppusa.com	Benelux	SHARP Electronics Benelux BV 0900-SHARPCE (0900-7427723) Nederland 9900-0159 Belgium http://www.sharp.nl http://www.sharp.be http://www.sharp.lu
Canada	Sharp Electronics of Canada Ltd. (905) 568-7140 http://www.sharp.ca	Australia	Sharp Corporation of Australia Pty. Ltd. 1300-135-022 http://www.sharp.net.au
Mexico	Sharp Electronics Corporation Mexico Branch (525) 716-9000 http://www.sharp.com.mx	New Zealand	Sharp Corporation of New Zealand Phone: (09) 573-0111 Fax: (09) 573-0112 http://www.sharp.net.nz
Latin America	Sharp Electronics Corp. Latin American Group (305) 264-2277 www.servicio@sharpsec.com http://www.sharpla.com	Singapore	Sharp-Roxy Sales (S) Pte. Ltd. 65-226-6556 ckng@srs.global.sharp.co.jp http://www.sharp.com.sg
Germany	Sharp Electronics (Europe) GMBH 01805-234675 http://www.sharp.de	Hong Kong	Sharp-Roxy (HK) Ltd. (852) 2410-2623 dcmktg@srh.global.sharp.co.jp http://www.sharp.com.hk
U.K.	Sharp Electronics (U.K.) Ltd. 08705 274277 http://www.sharp.co.uk/customersupport	Taiwan	Sharp Corporation (Taiwan) 0800-025111 http://www.sharp-scot.com.tw
Italy	Sharp Electronics (Italy) S.P.A. (39) 02-89595-1 http://www.sharp.it	Malaysia	Sharp-Roxy Sales & Service Co. (60) 3-5125678
France	Sharp Electronics France 01 49 90 35 40 hotlined@sef.sharp-eu.com http://www.sharp.fr	U.A.E.	Sharp Middle East Fze 971-4-81-5311 helpdesk@smef.global.sharp.co.jp
Spain	Sharp Electronica Espana, S.A. 93 5819700 sharpd@sees.sharp-eu.com http://www.sharp.es	Thailand	Sharp Thebnakorn Co. Ltd. 02-236-0170 svc@stcl.global.sharp.co.jp http://www.sharp-th.com
Switzerland	Sharp Electronics (Schweiz) AG 0041 1 846 63 11 cattaneo@sez.sharp-eu.com http://www.sharp.ch	Korea	Sharp Electronics Incorporated of Korea (82) 2-3660-2002 lcd@sharp-korea.co.kr http://www.sharpkorea.co.kr
Sweden	Sharp Electronics (Nordic) AB (46) 8 6343600 vision.support@sen.sharp-eu.com http://www.sharp.se	India	Sharp Business Systems (India) Limited (91) 11- 6431313 service@sharp-oa.com
Austria	Sharp Electronics (Europe) GMBH Branch Office Austria 0043 1 727 19 123 pogats@sea.sharp-eu.com http://www.sharp.at		

Specifications

Model		XG-SV100W	XG-SV200X
Display devices		0.65" DLP® Chip x1	0.7" DLP® Chip x1
Resolution		WXGA (1280 × 800)	XGA (1024 × 768)
Lens	F number	F 2.5 – 3.7	
	Zoom	Power, ×2.0 (f = 21.2 – 42.0 mm)	
	Focus	Power	
Input terminals	HDMI	x1	
	Computer/Component (mini D-sub 15 pin)	x2	
	S-Video (mini DIN 4 pin)	x1	
	Video (RCA)	x1	
	Audio (ø3.5 mm stereo minijack)	x1	
	Audio (RCA)	x1 (L/R)	
Output terminals	Computer/Component (mini D-sub 15 pin)	x1 (Shared with COMPUTER/COMPONENT 2; switchable)	
	Audio (ø3.5 mm stereo minijack)	x1 (variable audio output)	
Control and communication terminals	LAN (RJ-45)	x1	
	USB (Type B)	x1	
	RS-232C (mini DIN 9 pin)	x1	
Speaker		10 W (Mono)	
Projection lamp		400 W	
Rated voltage		AC 100 – 240 V	
Rated frequency		50/60 Hz	
Input current		5.2 A	
Power consumption	Eco+Quiet Off	AC 100 V	516 W
		AC 240 V	495 W
	Eco+Quiet On	AC 100 V	396 W
		AC 240 V	383 W
Power consumption (STANDBY Mode)	Standard	AC 100 V	12.2 W
		AC 240 V	12.8 W
	Eco	AC 100 V	0.35 W
		AC 240 V	0.70 W
Operation temperature		41°F to 95°F (+5°C to +35°C)	
Cabinet		Plastic	
Dimensions (main body only) [W × H × D]		15 61/64" × 4 33/64" × 16" (405 × 114.5 × 406.5 mm)	
Weight (approx.)		16.5 lbs. (7.5 kg)	

As a part of policy of continuous improvement, SHARP reserves the right to make design and specification changes for product improvement without prior notice. The performance specification figures indicated are nominal values of production units. There may be some deviations from these values in individual units.

This SHARP projector uses a DLP® chip. This very sophisticated panel contains 1,024,000 (XG-SV100W) or 786,432 (XG-SV200X) pixels (micromirrors). As with any high technology electronic equipment such as large screen TVs, video systems and video cameras, there are certain acceptable tolerances that the equipment must conform to.

This unit has some inactive pixels within acceptable tolerances which may result in inactive dots on the picture screen. This will not affect the picture quality or the life expectancy of the unit.



Dimensions

Units: inches (mm)

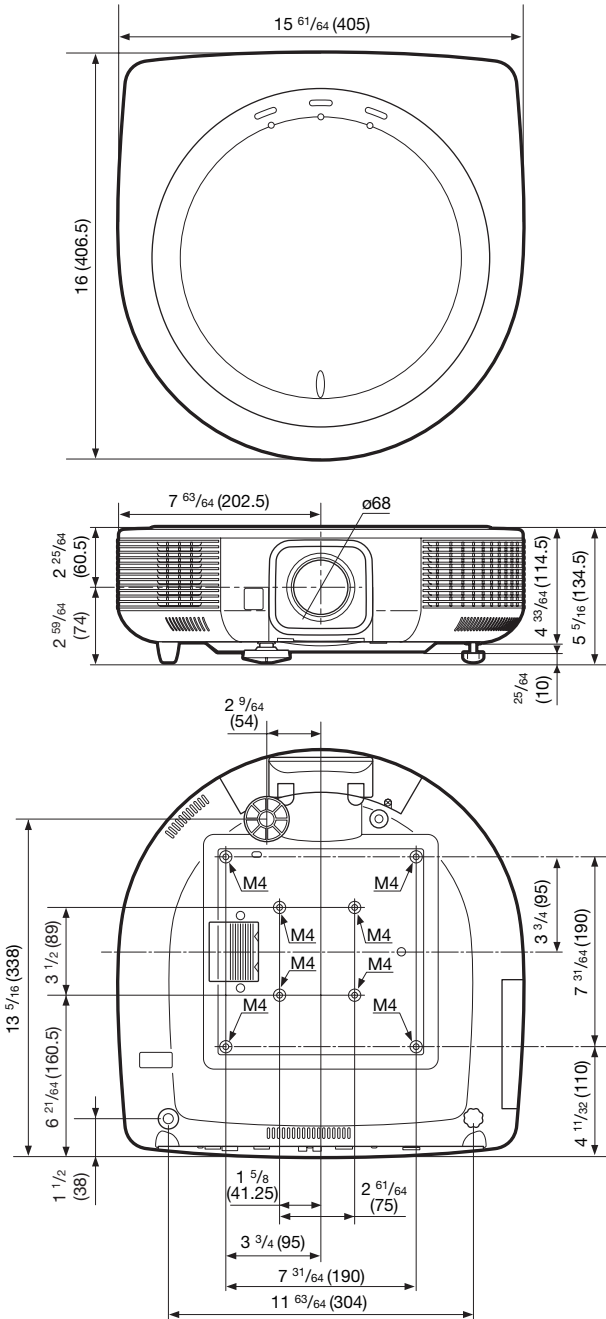

Index

16:9	36-39	MEMORY (1-8) buttons	59
3D MODE button	67	Memory Menu	59
AC socket	26	MEMORY MENU button	59
Adjustment buttons	46	MENU button	46
Adjustment foot	29	MONITOR OUT terminal	24
All Reset	60	MOUSE/Adjustment buttons	42, 46
AREA ZOOM	37, 39	NATIVE	36, 38
Aspect ratio	36, 38	Network	61
Audio Input	51	NORMAL	36-39
Audio Out	51	ON button	27
AUDIO 1, 2 terminals	24	Optional accessories	11
AUDIO OUT terminal	24	OSD Display	54
Auto Power Off	56	Overscan	54
Auto Restart	56	PAGE DOWN button	42
Auto Sync (Auto Sync adjustment)	41, 52	PAGE UP button	42
AUTO SYNC button	41	Password	61
AV MUTE button	35	PDF	10
Background	55	Phase	52
Bass	51	Picture Adjustment	48
Batteries	15	Picture Mode	41, 48
Blue	55	PICTURE MODE button	41
BORDER	36, 37	POINTER button	40
BREAK TIMER button	40	Power cord	26
Bright	48	Power indicator	70
BrilliantColor™	48	PRJ	56
Clock	52	PRJ Mode	21, 55
Closed Caption	55	R-CLICK/RETURN button	42, 46
CLR Temp (Color Temperature)	49	Red	48
C.M.S.	49	Remote control	14
Color	48	Remote control sensor	15
COMPUTER2 Select	56	Replacing the lamp	72, 73
COMPUTER/COMPONENT1, 2 input terminals	22, 23	Reset Network Setting	62
Contrast	48	Resize	36, 54
DHCP Client	62	RESIZE button	36
DLP® Link™	67	Resolution	52
DLP® Link™ Invert	67	Restart Network	62
DNR	50	RGB cable	22
Dynamic Range	53	ROTATE button	14
Eco+Quiet	40, 50	Rotate Indicator	59
ECO+QUIET button	40	RS-232C terminal	25
Effect	50	Saturation	50
ENTER button	46	SCR	54
Exhaust vent	12, 13, 69	Screen Size and Projection Distance	19, 20
Fan Mode	57	Select Color	50
FREEZE button	41	Sharp	48
FOCUS buttons	30	SIG	52
FULL	36, 38	Signal Info	53
Geometric adjustment	32	Signal Type	52
H-Pos	52	Speaker	51
H&V KEYSTONE	33	SPOT button	40
H&V SHIFT button	29	STANDBY button	27
HDMI terminal	22, 23	STANDBY Mode	56
Hue	50	STANDBY/ON button	27
INPUT modes	34	Supplied accessories	11
Intake vent	13, 69	S-VIDEO terminal	23
IP Address	63	System Lock	57
Kensington Security Standard connector	13	TCP/IP	62
Keypad	57	Temperature warning indicator	70
Keylock	58	Tint	48
KEYSTONE button	31	Treble	51
Keystone Correction	31	USB terminal	42
Lamp	72	Value	50
Lamp indicator	70	Video Setup	53
Lamp Timer (Life)	60	Video System	53
Lamp unit	73	VIDEO terminal	23
Language (on-screen display language)	55	VOL (Volume) buttons	35
LAN terminal	26	V-Pos	52
LENS button	12	V-STRETCH	37, 39
L-CLICK/EFFECT button	42, 40	Wall Color	54
MAC Address	63	ZOOM buttons	30
MAGNIFY buttons	41		

SHARP[®]
SHARP CORPORATION