





 **Optoma**[®]



MOBILE LED PROJECTOR
USER'S MANUAL



EYE SAFETY WARNINGS

-  Avoid staring/facing directly into the projector beam at all times. Keep your back to the beam as much as possible.
-  A stick or laser pointer is recommended to avoid the need for the user to enter the beam.
-  When projector is used in a classroom, adequately supervise students when they are asked to point out something on the screen.
-  In order to minimize power, use room blinds to reduce ambient light levels.

A.2.9.31 GLOSS OF HOUSING OF PERIPHERAL DEVICES (15TH / 22 MEETING AG1 EK1):

The requirements for the gloss of housing apply to peripheral devices used at the visual display workplace according to BildscharbV. Peripheral devices intended for use outside the visual display workplace can receive a GS-Mark if the scope is indicated in the User's Manual as well as the certificate.

That means the following wording is possible in situations where the use within the field of view is not intended and where sufficient hints are given in the User's Manual for the avoidance of such situations to ensure that display work is not affected.

Wording in the certificate: "This device is not intended for use in the direct field of view at visual display workplaces. To avoid incommoding reflexions at visual display workplaces this device must not be placed in the direct field of view."

REGULATION & SAFETY NOTICES

This appendix lists the general notices of your Projector.

FCC notice

This device has been tested and found to comply with the limits for a Class B digital device pursuant to Part 15 of the FCC rules. These limits are designed to provide reasonable protection against harmful interference in a residential installation. This device generates, uses, and can radiate radio frequency energy and, if not installed and used in accordance with the instructions, may cause harmful interference to radio communications.

However, there is no guarantee that interference will not occur in a particular installation. If this device does cause harmful interference to radio or television reception, which can be determined by turning the device off and on, the user is encouraged to try to correct the interference by one or more of the following measures:

- Reorient or relocate the receiving antenna.
- Increase the separation between the device and receiver.
- Connect the device into an outlet on a circuit different from that to which the receiver is connected.
- Consult the dealer or an experienced radio/television technician for help.

Notice: Shielded cables

All connections to other computing devices must be made using shielded cables to maintain compliance with FCC regulations.

Caution

Changes or modifications not expressly approved by the manufacturer could void the user's authority, which is granted by the Federal Communications Commission, to operate this device.

Operation conditions

This device complies with Part 15 of the FCC Rules. Operation is subject to the following two conditions:

1. this device may not cause harmful interference, and
2. this device must accept any interference received, including interference that may cause undesired operation.

Notice: Canadian users

This Class B digital apparatus complies with Canadian ICES-003.

Remarque à l'intention des utilisateurs canadiens

Cet appareil numérique de la classe B est conforme à la norme NMB-003 du Canada.

Declaration of Conformity for EU countries

- EMC Directive 2004/108/EC (including amendments)
- Low Voltage Directive 2006/95/EC
- R & TTE Directive 1999/5/EC. (if product has RF function)

IMPORTANT SAFETY INSTRUCTION

1. Do not block any ventilation openings. To ensure reliable operation of the projector and to protect from over heating, it is recommended to install the projector in a location that does not block ventilation. As an example, do not place the projector on a crowded coffee table, sofa, bed, etc. Do not put the projector in an enclosure such as a book case or a cabinet that restricts air flow.
2. Do not use the projector near water or moisture. To reduce the risk of fire and/or electric shock, do not expose the projector to rain or moisture.
3. Do not install near heat sources such as radiators, heaters, stoves or any other apparatus such as amplifiers that emits heat.
4. Do not use the projector in direct sunlight.
5. Do not use near any appliance generating a strong magnetic field.
6. Do not use the projector in areas susceptible to excessive dust and dirt.
7. Turn off the product before cleaning.
8. Disconnect the power cord if the product is not being used for a long period of time.
9. Ensure that the ambient room temperature is within 5- 35°C.
10. Relative Humidity is 5 - 35°C, 80% (Max.), non-condensing.
11. Do not drop, throw or try to bend your product.
12. May explode if disposed of in fire.
13. Clean only with dry cloth.
14. Only use attachments/accessories specified by the manufacturer.
15. Do not use the unit if it has been physically damaged or abused. Physical damage/abuse would be (but not limited to):
 - Unit has been dropped.
 - Charger or plug has been damaged.
 - Liquid has been spilled on to the projector.
 - Projector has been exposed to rain or moisture.
 - Something has fallen in the projector or something is loose inside.
 Do not attempt to service the unit yourself. Opening or removing covers may expose you to dangerous voltages or other hazards. Please contact your local reseller or service center before you send the unit for repair.
16. Do not let objects or liquids enter the projector. They may touch dangerous voltage points and short out parts that could result in fire or electric shock.
17. See projector enclosure for safety related markings.
18. The unit should only be repaired by appropriate service personnel.
19. Do not touch the projector for a long time while the projector is used.

DISPOSAL OF OLD ELECTRICAL & ELECTRONIC EQUIPMENT

(Applicable throughout the European Union and other European countries with separate collection programs)

This symbol found on your product or on its packaging, indicates that this product should not be treated as household waste when you wish to dispose of it. Instead, it should be handed over to an applicable collection point for the recycling of electrical and electronic equipment. By ensuring this product is disposed of correctly, you will help prevent potential negative consequences to the environment and human health, which could otherwise be caused by inappropriate disposal of this product. The recycling of materials will help to conserve natural resources.



This symbol is only valid in the European Union.

If you wish to discard this product, please contact your local authorities or dealer and ask for the correct method of disposal.

PRODUCT OVERVIEW

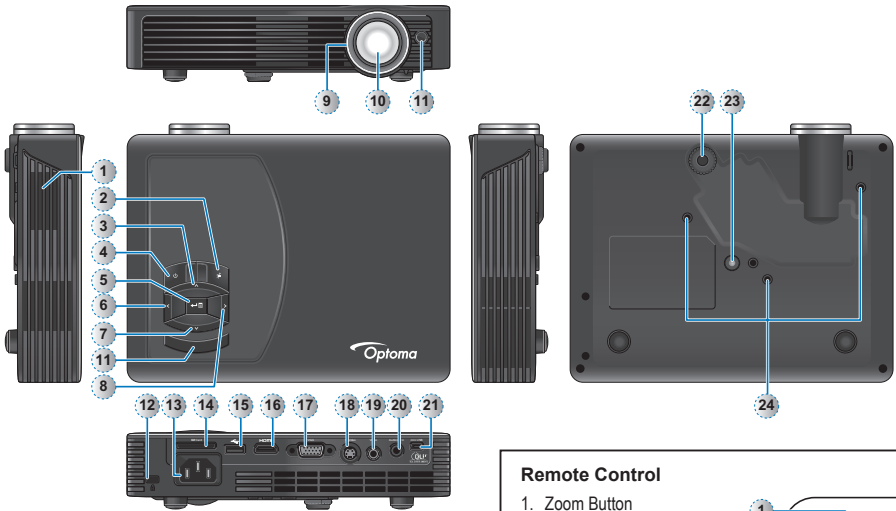

- 1. Speaker
- 2. Auto Source Button (⏻)
- 3. Up Button (▲)
- 4. Power Button (⏻)
- 5. OK Button (◀▶)
- 6. Left Button (◀)
- 7. Down Button (▼)
- 8. Right Button (▶)
- 9. Focus Dial
- 10. Lens
- 11. IR Receiver
- 12. Kensington Lock
- 13. DC Input
- 14. SD Card Slot
- 15. USB Type A Port
- 16. HDMI Connector
- 17. VGA Connector
- 18. S-Video Input Connector
- 19. Video In
- 20. Audio / AV In
- 21. Mini USB Port
- 22. Elevator Foot
- 23. Screw Hole for Tripod
- 24. Ceiling Mount Holes

<Note>
Items 3 and 5-8 are also function buttons. Functions vary depending on the current mode.

Remote Control

- 1. Zoom Button
- 2. Power Button
- 3. Up Button
- 4. Menu Button
- 5. OK Button
- 6. Left Button
- 7. Aspect Ratio Button
- 8. Down Button
- 9. Volume Up Button
- 10. Volume Down Button
- 11. Hide Button
- 12. LED Mode Button
- 13. Right Button
- 14. Media Button
- 15. VGA Button
- 16. HDMI Button
- 17. Video Button
- 18. S-Video Button

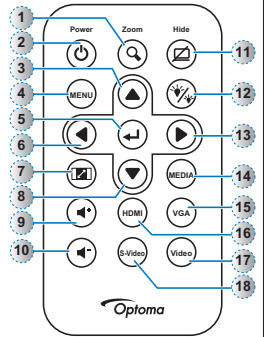

PACKAGE OVERVIEW

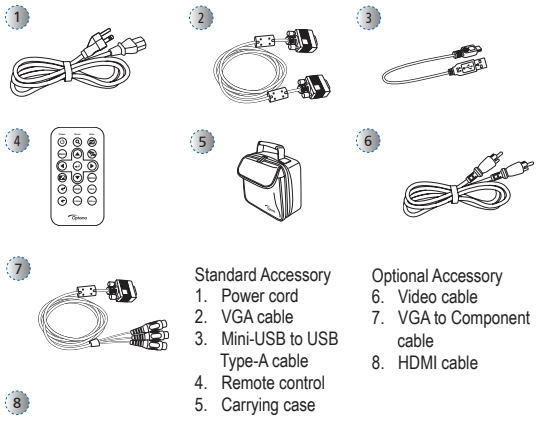

- Standard Accessory**
- 1. Power cord
 - 2. VGA cable
 - 3. Mini-USB to USB Type-A cable
 - 4. Remote control
 - 5. Carrying case
- Optional Accessory**
- 6. Video cable
 - 7. VGA to Component cable
 - 8. HDMI cable

<Note>
• The standard accessories may vary in each region due to different applications.
• The inclusive power cord varies per region.

POWER ON / OFF

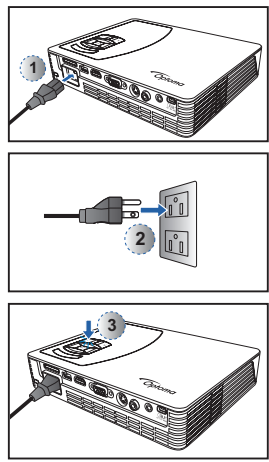

- 1. Connect the power cord to the AC IN input jack on the rear of the projector. (①)
- 2. Insert the plug at the other end of the power cord into a power outlet. (②)
The LED lights red in standby mode.
- 3. Press the Power button (⏻) to turn the projector on or off. (③)
The LED turns blue when the projector is turned on.

ADJUST PROJECTED IMAGE HEIGHT

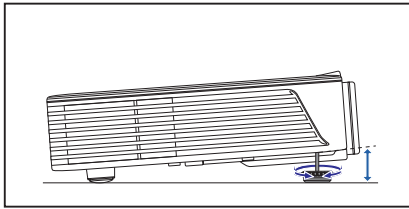

The projector is equipped with an elevator foot for adjusting the projected image height.

To adjust the height:
Turn the elevator foot to adjust the projected image position to the desired height.

<Note>

After a few seconds, if there is no changes, the projector will automatically adjust the image display via Auto Keystone function.

ADJUST THE PROJECTED IMAGE

| Projection Distance (A) | | Screen Size - Width (B) | | Screen Size - Height (C) | | Screen Diagonal (D) | |
|-------------------------|--------|-------------------------|--------|--------------------------|--------|---------------------|--------|
| Meter | Inch | (mm) | (inch) | (mm) | (inch) | (mm) | (inch) |
| 0.5 | 20.18 | 366.2 | 14.4 | 226.9 | 9 | 432 | 17 |
| 0.9 | 35.62 | 646.2 | 25.4 | 403.9 | 15.9 | 762 | 30 |
| 1.5 | 59.36 | 1077 | 42.4 | 673.1 | 26.5 | 1270 | 50 |
| 1.8 | 71.23 | 1292.3 | 50.9 | 807.7 | 31.8 | 1524 | 60 |
| 2.4 | 94.98 | 1723.1 | 67.8 | 1077 | 42.4 | 2032 | 80 |
| 3.0 | 118.72 | 2153.9 | 84.8 | 1346.2 | 53 | 2540 | 100 |
| 3.6 | 142.46 | 2584.7 | 101.8 | 1615.4 | 63.6 | 3048 | 120 |
| 4.5 | 178.08 | 3230.9 | 127.2 | 2019.3 | 79.5 | 3810 | 150 |
| 5.4 | 213.7 | 3877 | 152.6 | 2423.2 | 95.4 | 4572 | 180 |

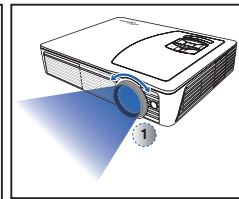
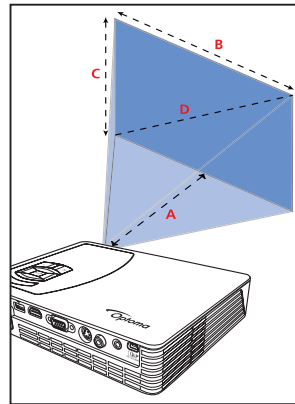

Adjust the focus (①) until the image is clear.

CONNECT INPUT SOURCE - VGA / S-VIDEO / HDMI

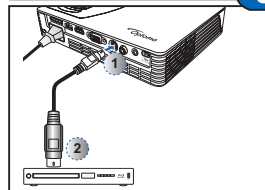
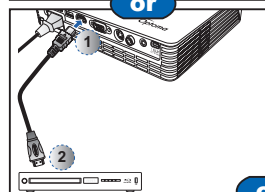

1. Connect the VGA / S-Video / HDMI device using an appropriate cable. (①~②)
2. After powering on the projector, press to switch input source.

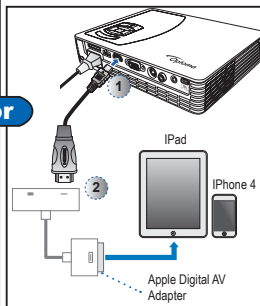

CONNECT INPUT SOURCE - COMPOSITE AV IN

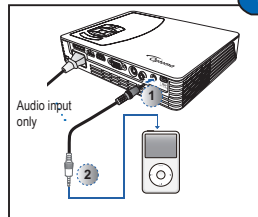
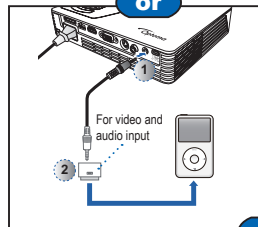
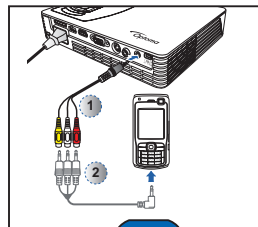

1. Connect the AV input source. (①~②)
2. After powering on the projector, press to switch input source.

<Note>

1. All other brand and product names are trademarks or registered trademarks of their respective companies.
2. The cables connecting the video output devices are not supplied, please contact the device vendor or Optoma.
3. iPod nano/iPod touch/iPhone/iPod classic (version 5 and above)
4. Designed for iPod/iPhone/Mobile phone/PMP with TV out functions. Using with devices with audio signal voltage > 0.3Vrms is not recommended.

CONNECT COMPUTER FOR USB DISPLAY

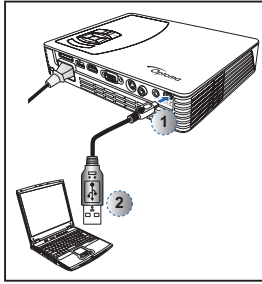

You can project your computer display using the projector's mini USB port.

1. Connect a laptop or PC using the supplied mini-USB to USB Type-A cable.
2. Turn on the projector.
3. Press </>/^/∨ to highlight **mini-USB > USB Display** and press ←/→ to enter USB display mode.
See "USB Display Mode" section in "USB Mode" on page 16.

INSERT SD CARD

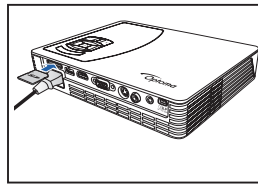

By default, the projector displays from the internal memory. However if an SD card is inserted, the projector reads from the SD card first.

Insert an SD card into the slot with the gold contacts facing down.

<Note>

- To remove the SD card, push the card to eject it from the slot.
- Do not remove the SD card while the projector is projecting image from the card. This can cause data loss or damage the card.
- Supports SD card size up to 32GB.
- The SD card is not included in the package.

INSERT USB FLASH DRIVE

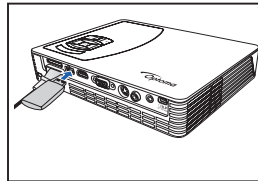

Plug a USB flash drive into the USB Type A port at the back of projector.

<Note>

- Support USB flash drive with FAT32 and NTFS format.

CONNECT COMPUTER FOR DATA TRANSFER

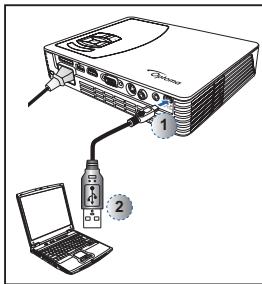

You can transfer data to the projector internal memory or the SD card.

1. Connect a laptop or PC using the supplied mini-USB to USB Type-A cable.
2. Turn on the projector.
3. Press </>/^/∨ to highlight **mini-USB > Data Transfer** and press ←/→ to enter data transfer mode.
4. Browse for Removable Disk.
5. Copy the files to your computer.
See "Data Transfer Mode" section in "USB Mode" on page 18.

<Note>

The laptop/PC can only detect the input source when the projector is switched on.

MOUNT THE PROJECTOR

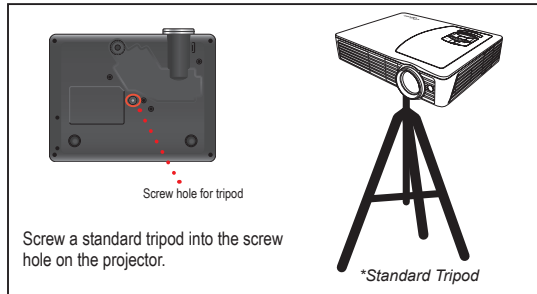

Screw a standard tripod into the screw hole on the projector.

*Standard Tripod

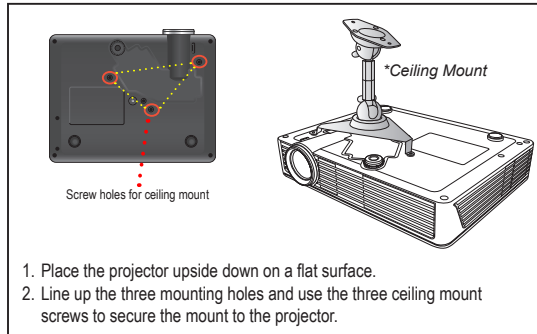

1. Place the projector upside down on a flat surface.
2. Line up the three mounting holes and use the three ceiling mount screws to secure the mount to the projector.

<Note>

The tripod and ceiling mount are optional accessories.

HOW TO USE THE MENU

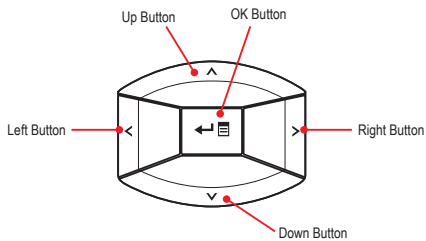

- Use </>/^/∨ to highlight the desired option and press ←|→ to confirm the selection.
- Buttons functionality varies depending on the current mode.

<Note>

A button guide appears on the lower left corner of most screens. The guide varies depending on the current mode. Press the corresponding button to select the option or operation.

Home menu



Press </>/^/∨ to select the menu item that you want to access and press ←|→ to enter the menu screen .

Submenu

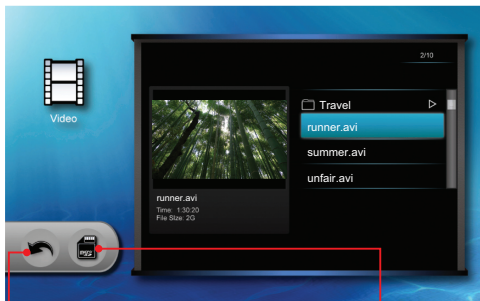

Back icon

Highlight this icon and press ←|→ to return to previous screen.

Data source icon

Press to switch the memory sources:
Internal memory » SD card » USB flash drive.

- Internal memory
- SD card
- USB flash drive (only supports FAT 32 format)

Submenu Items

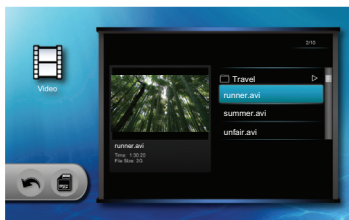

Video menu

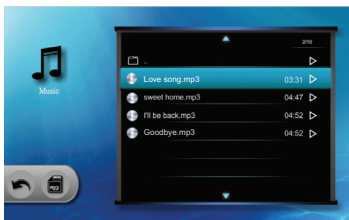

Music menu

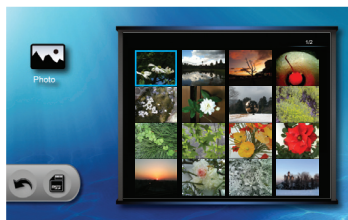

Photo menu



mini-USB menu



Office Viewer menu



Setup menu

Playing Videos from the Internal Memory, SD Card, or USB Flash Drive

If an SD card is inserted, the content of the memory card is read first. If you want to read data from the internal memory or USB flash drive, press in the appropriate screen to change the data source. See steps below.

1. Enter "Video" Menu

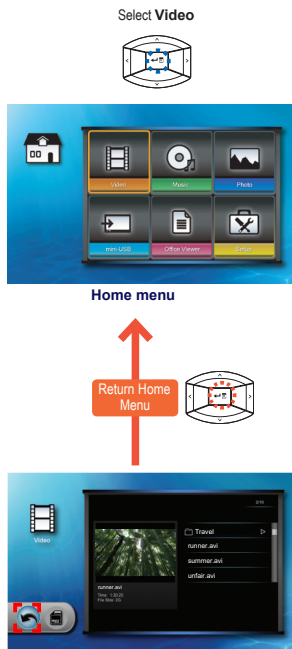

2. Select Data Source

The screen, the source icon on the button guide, and the sequence in which screens appear vary depending on the available data source.

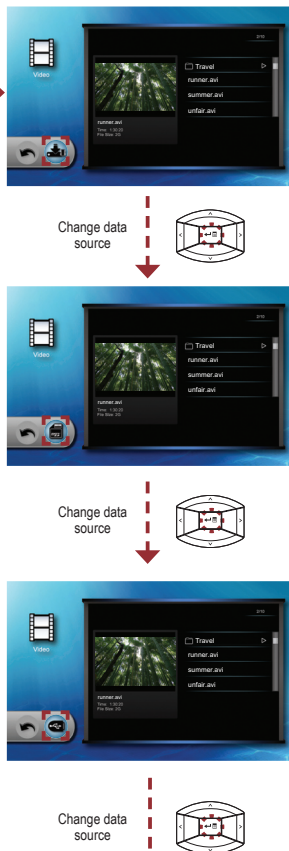

3. Select Video File



4. Playback File

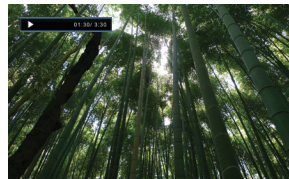

Video Playback mode (see page 8)

HOW TO PLAY VIDEOS - VIDEO PLAYBACK MODE

<Note>
The button guide disappears when the keypad is not used for 3 seconds.
To display the button guide, press any key.

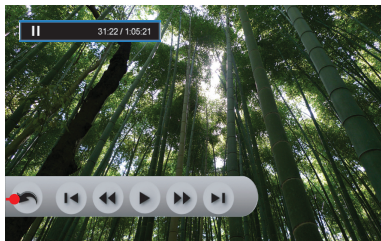

Highlight this icon and press to exit video playback mode.

| Media Playback Control | | | |
|------------------------|-----------------|--|---------------------|
| | Increase volume | | Rewind |
| | Decrease volume | | Fast forward |
| | Pause | | Previous video clip |
| | Play | | Next video clip |

VIDEO SETTINGS

1. Select "Setup"



Home menu

2. Enter "Setup" Menu



3. Enter "Video Setting" Menu

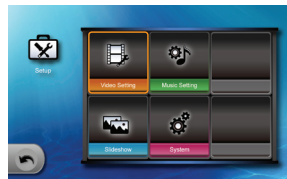

5. Select Option



| | | |
|-----------------|--|----------------------------|
| Repeat | | Repeat all |
| | | Repeat one |
| | | Repeat disabled |
| Browser display | | Browser display small icon |
| | | Browser display large icon |

4. Select Setting



Playing Music from the Internal Memory, SD Card, or USB Flash Drive

If an SD card is inserted, the content of the memory card is read first. If you want to read data from the internal memory or USB flash drive, press  in the appropriate screen to change the data source. See steps below.

3. Select Data Source

The screen, the source icon on the button guide, and the sequence in which screens appear vary depending on the available data source.

1. Select "Music"



2. Enter "Music" Menu

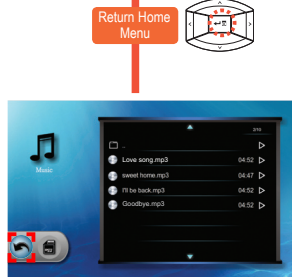
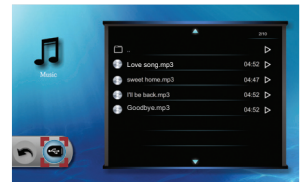
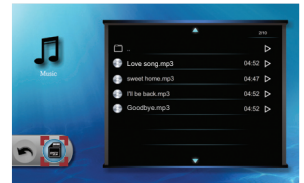
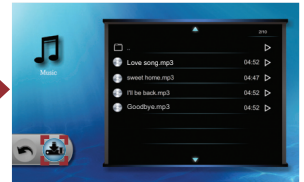

5. Playback File

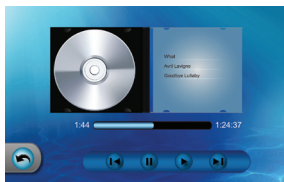

4. Select Music File

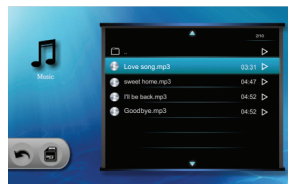

<Note>
The displayed screen may vary depending on the selected data source on the previous step.

HOW TO PLAY MUSIC - PLAYBACK MODE

<Note>
The button guide disappears when the keypad is not used for 3 seconds.
To display the button guide, press any key.

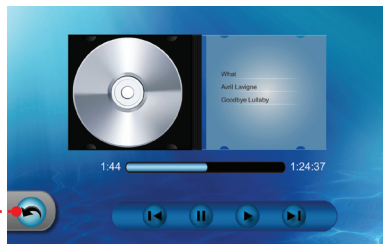

Highlight this icon and press to exit music playback mode.

| Media Playback Control | | | |
|------------------------|-----------------|--|----------------|
| | Increase volume | | Play |
| | Decrease volume | | Previous track |
| | Pause | | Next track |

MUSIC SETTINGS

1. Select "Setup"



Home menu

2. Enter "Setup" Menu



3. Select "Music Setting"

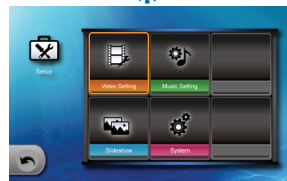

6. Select Option



| | | |
|---------|--|-----------------|
| Repeat | | Repeat all |
| | | Repeat one |
| | | Repeat disabled |
| Shuffle | | Shuffle on |
| | | Shuffle off |

5. Select Setting

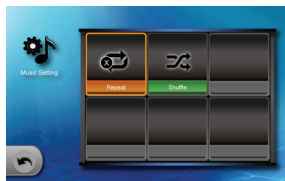

4. Enter "Music Setting" Menu

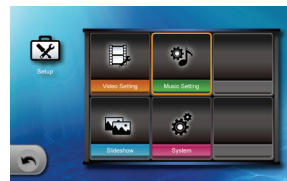

Viewing Photos from the Internal Memory, SD Card, or USB Flash Drive

If an SD card is inserted, the content of the memory card is read first. If you want to read data from the internal memory or USB flash drive, press  in the appropriate screen to change the data source. See steps below.

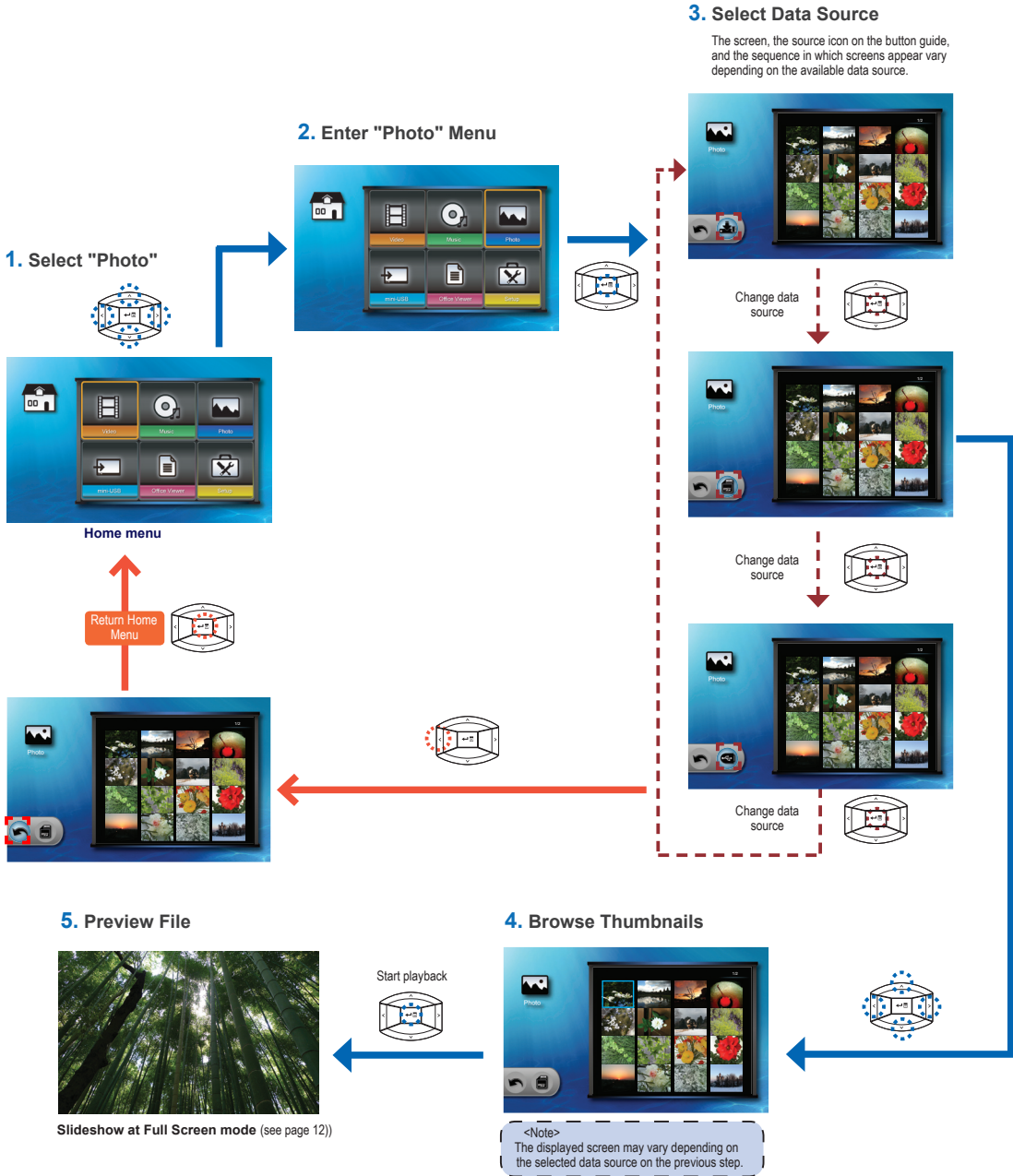

HOW TO VIEW PHOTOS - MODE: SLIDESHOW AT FULL SCREEN

During slideshow, photos are played continuously at a specified interval time while playing music stored in the internal memory as background.

<Note>
The button guide disappears when the keypad is not used for 3 seconds.
To display the button guide, press any key.

<Note>

- To change slideshow interval settings and enable/disable background music, see Slideshow Settings below.
- Make sure that background music setting is "On" to enable this feature.
- Save the music files (*.mp3 format) under the "/mnt/disk/bgm" folder in the internal memory via data transfer function.
- Only music files stored in the internal memory "/mnt/disk/bgm" folder can be played as background music.

Highlight this icon and press to exit slideshow mode.



| Media Playback Control | | | |
|------------------------|-----------------|--|---------------|
| | Increase volume | | Slideshow on |
| | Decrease volume | | Slideshow off |

SLIDESHOW SETTINGS

1. Select "Setup"



Home menu

2. Enter "Setup" Menu



3. Select "Slideshow"



6. Select Option



| | | |
|-------|--|---------------------------|
| Timer | | Timer: 2-second interval |
| | | Timer: 5-second interval |
| | | Timer: 10-second interval |
| Music | | Background music on |
| | | Background music off |

5. Select Setting



4. Enter "Slideshow" Menu



HOW TO VIEW DOCUMENTS - SOURCE: INTERNAL MEMORY / SD CARD / USB FLASH DRIVE

Viewing Documents from the Internal Memory, SD Card, or USB Flash Drive

If an SD card is inserted, the content of the memory card is read first. If you want to read data from the internal memory or USB flash drive, press  in the appropriate screen to change the data source. See steps below.

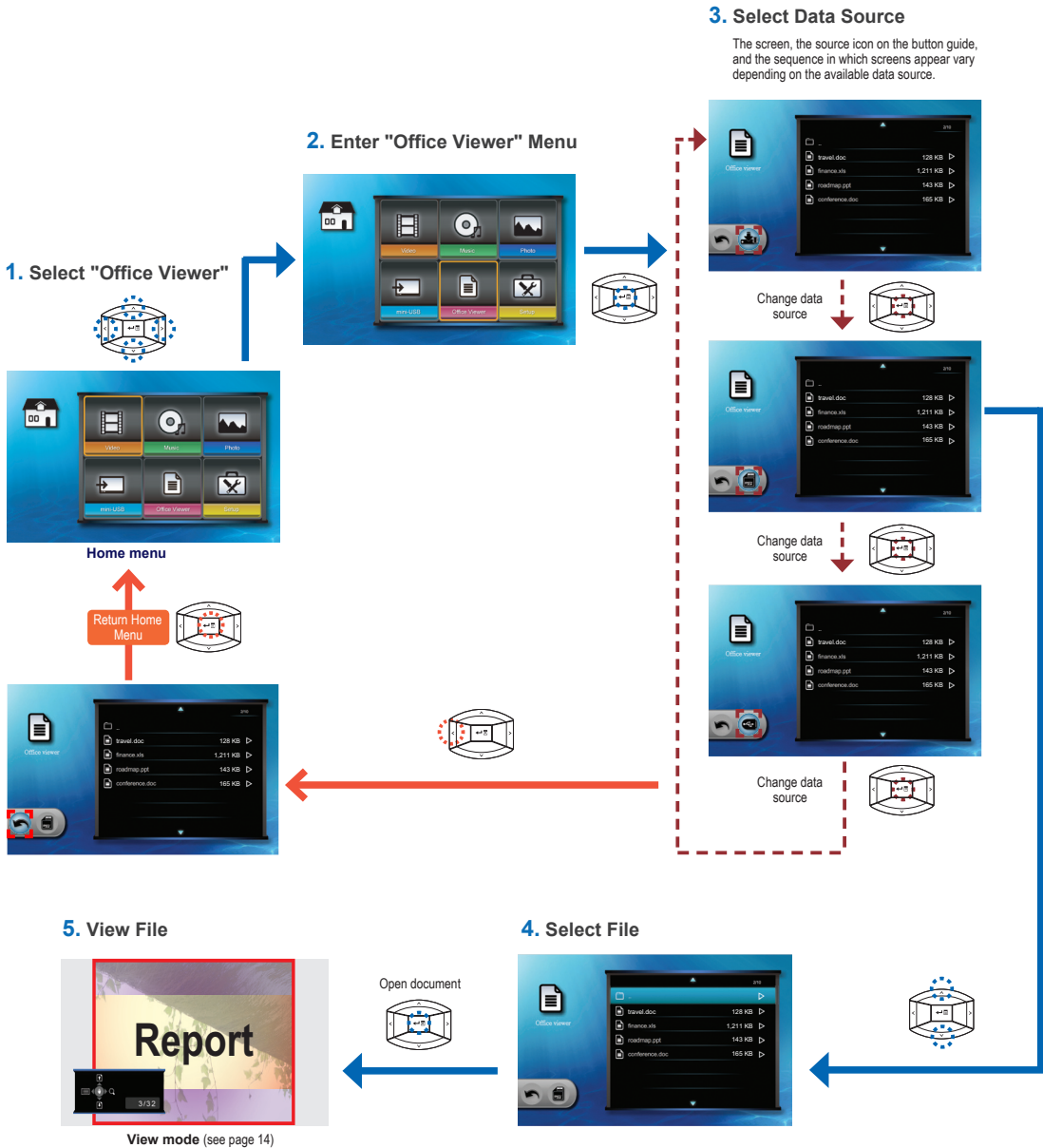

HOW TO VIEW DOCUMENTS - VIEW MODE

<Note>
The button guide disappears when the keypad is not used for 3 seconds.
To display the button guide, press any key.

Full screen view



Advanced menu mode



Media Playback Control

- | | | | |
|---|---------------------|--------|--------------------------|
| ▲ | Previous page | > or Q | Zoom in/out page |
| ▼ | Next page | ← | Enter advanced menu mode |
| ◀ | Return to file list | | |

Media Playback Control (Advanced Menu Mode)

- | | | | |
|---|-------------------|---|-------------------------|
| ▲ | Page up | ◀ | Move to the left |
| ▼ | Page down | ← | Exit advanced menu mode |
| > | Move to the right | | |

SELECT MENU LANGUAGE

1. Select "Setup"



Home menu

2. Enter "Setup" Menu



3. Select "System"

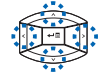

6. Select Language

Select item



Confirm selection



5. Enter "Language" Menu



4. Enter "System" Menu

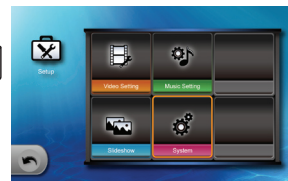

Select your preferred menu language:

| | | | | |
|---------|------------------------|---------|---------------------|--------------------|
| English | Portuguese (Brazilian) | Russian | Swedish | Simplified Chinese |
| French | German | Polish | Greek | Korean |
| Spanish | Italian | Dutch | Traditional Chinese | Japanese |

1. Select "Setup"



Home menu

2. Enter "Setup" Menu



3. Select "System"



6. Enter "Information" Menu



5. Select "Information"





4. Enter "System" Menu

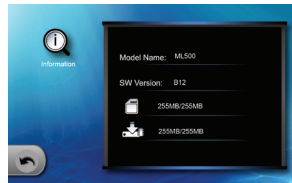

7. View Projector Information



 SD card capacity
 Internal memory capacity

RESET THE SYSTEM

<Note>
When the system is reset, all files stored in the internal memory will be deleted. Ensure all files are backed up before resetting.

1. Select "Setup"



Home menu

2. Enter "Setup" Menu

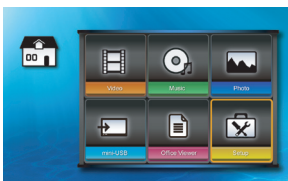

3. Select "System"

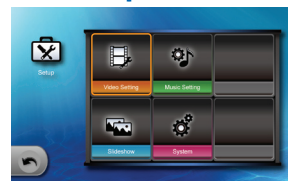

6. Enter "Reset" Menu



5. Select "Reset"



4. Enter "System" Menu



7. Confirm Reset

Select item

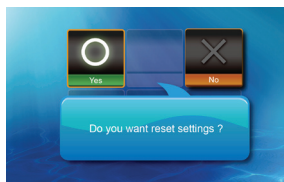

No

Yes

Reboot the projector

Return to Home menu



UPGRADE FIRMWARE

Software updates can be obtained from the OPTOMA website
www.optoma.com / www.optoma.eu / www.optoma.com.tw.

1. On your computer, create a folder named "upgrade".
2. Download the latest firmware from www.optoma.com and save it in the "upgrade" folder.
3. Copy the "upgrade" folder to the root folder of the SD card.
4. Insert the SD card into the SD card slot of the projector.
5. Follow the steps below.

1. Select "Setup"



Home menu

2. Enter "Setup" Menu



3. Select "System"



6. Enter "Upgrade" Menu



5. Select "Upgrade"



4. Enter "System" Menu



7. Confirm Upgrade

Select item

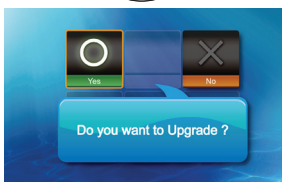

Yes

No

<Note>
 • A "No new firmware is found" message appears if there is no update file in the SD card.
 • Do not touch any buttons or turn off the projector while upgrading is in progress. Otherwise, this may damage the projector.
 • Do not remove the SD card until the upgrade is complete.

8. Wait to Complete



Upgrade may take a while to complete

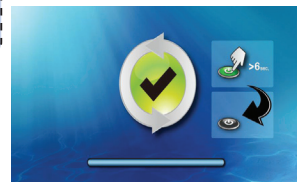

Reboot the projector

Return to Home menu



USB MODE

USB Display Mode

<Note>
 When using USB Display function for the first time:
 1. From the Windows desktop, browse for "USB Display V1.0.1" drive and double-click "dlusb_launcher.exe", see "Data Transfer Mode" below.
 2. USB display is not MAC compatible.

1. Select "mini-USB"



Home menu

2. Enter "mini-USB" Menu



3. Enter "USB Display" Mode



4. Connect to PC

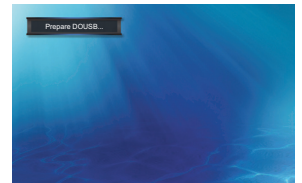

5. View PC Display



Press to exit USB display mode.

Data Transfer Mode

1. Select "mini-USB"



Home menu

2. Enter "mini-USB" Menu



3. Select "Data Transfer"



4. Enter "Data Transfer" Mode



5. Connect to PC



6. Start Transfer Data

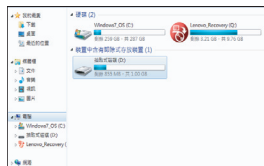

When data transfer completes, unplug the USB cable or press to exit PC mode.

ADJUST MENU SETTINGS FOR EXTERNAL INPUT SOURCE: VGA / COMPOSITE AV / HDMI

Selecting Input Source

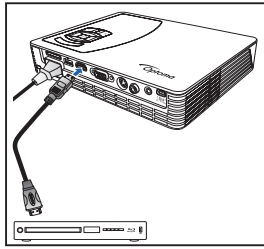

Once a video source device is connected and turned on, press  to switch input source.

Entering Menu Mode

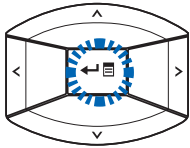

Press  to enter the menu mode.

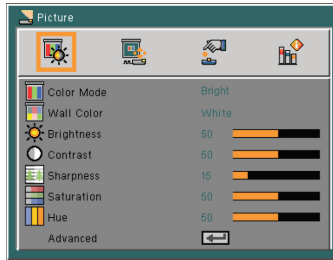

| Menu Operation | | |
|-------------------|-------------------|-------------------------|
| < | Select main menu | ↙ Enter current submenu |
| > | | ↘ Hide OSD menu |
| Submenu Operation | | |
| ↑ | Move up | < Adjust setting |
| ↓ | Move down | > |
| ↵ | Confirm selection | |

Menu Items

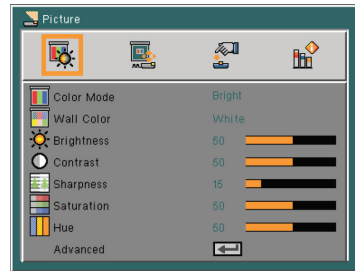

Picture menu

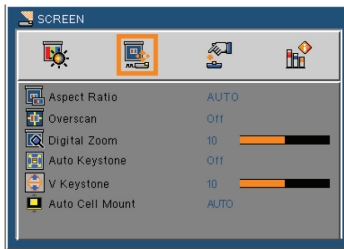

Screen menu

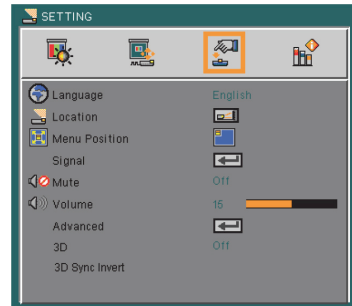

Setting menu

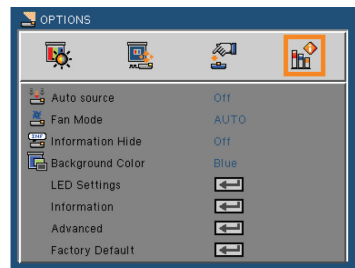

Options menu

1. Select Submenu

Select item

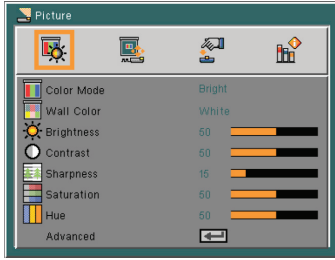

2. Enter Submenu



4. Confirm Settings

Confirm selection / setting



3. Adjust Settings

Adjust setting



Color Mode (Bright / PC / Movie / Picture / User)

Adjust setting



Wall Color (White / Light Yellow / Light Blue / Pink / Dark Green)

Adjust setting



Brightness (0~100)

Adjust setting



Contrast (0~100)

Adjust setting



Sharpness (0~100)

Adjust setting



Saturation (0~100)

Adjust setting



Hue (0~100)

Adjust setting

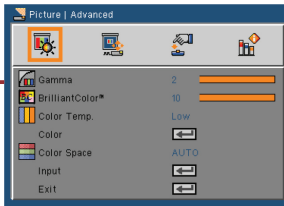

Advanced

| Submenu | Option |
|-----------------|---|
| Gamma | 0~2 |
| BrilliantColor™ | 0~10 |
| Color Temp. | Low / Middle / High |
| Color Space | Auto / RGB / YUB |
| Input | HDMI / VGA / COMPOSITE / S-Video / SD_CARD / USB_A / Mini USB_B |

1. Select Submenu

Select item

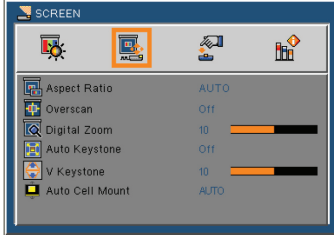

2. Enter Submenu



4. Confirm Settings

Confirm selection / setting



3. Adjust Settings

Adjust setting



Aspect Ratio (AUTO / 4:3 / 16:9 / 16:10)



Overscan (Off / On)



Digital Zoom (0-100)



Auto Keystone (Off / On)



V Keystone (-40-40)



Auto Cell Mount (Auto / Front Desktop / Front Inverted)

1. Select Submenu

Select item

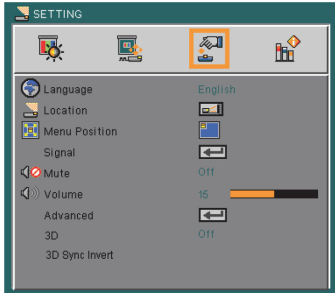

2. Enter Submenu



4. Confirm Settings

Confirm selection / setting



3. Adjust Settings

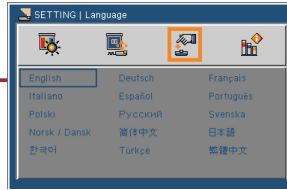

Adjust setting



Language (English / Italian / Polish / Korean / German / Spanish / Russian / Traditional Chinese / Turkish / French / Portuguese / Swedish / Japanese / Simplified Chinese)



Adjust setting



Location (Front Desktop / Rear Desktop)

Adjust setting



Menu Position (Top Left / Top Right / Center / Bottom Left / Bottom Right)

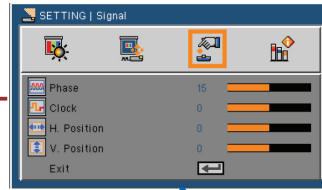

Adjust setting



Signal

| Submenu | Option |
|-------------|--------------------------------|
| Phase | |
| Clock | *range depends on input source |
| H. Position | |
| V. Position | |



Adjust setting



Mute (Off / On)



Adjust setting



Volume (0-100)

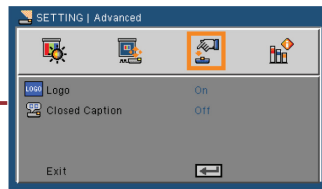

Adjust setting



Advanced

| Submenu | Option |
|----------------|---|
| Logo | Off / On |
| Closed Caption | Off / CC1 / CC2 / CC3 / CC4 / T1 / T2 / T3 / T4 |



Adjust setting



3D (Off / On)

1. Select Submenu

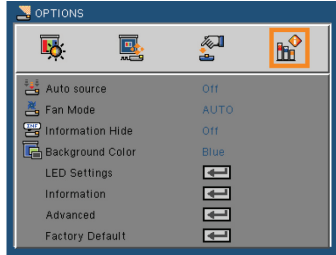
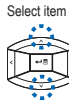

2. Enter Submenu



4. Confirm Settings

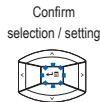

3. Adjust Settings

Adjust setting

Auto source Off On

Auto Source (Off / On)

Adjust setting

Fan Mode AUTO High Altitude

Fan Mode (Off / On)

Adjust setting

Information Hide Off On

Information Hide (Off / On)

Adjust setting

Background Color Black Blue

Background Color (Black / Blue)

Adjust setting

OPTIONS | LED Settings

LED Hours Used (Normal) 9999

LED Hours Used (ECO) 9999

ECO Mode Off

Exit

LED Settings

| Submenu | Option |
|-------------------------|-------------------------|
| LED Hours Used (Normal) | *display current status |
| LED Hours Used (ECO) | |
| ECO Mode | Off / On |

Adjust setting

OPTIONS | Information

Model Name ML500

Serial Number 000000

Source Computer 1

Resolution 1024 x 768 80.00Hz

Software Version A01

Exit

Information

Adjust setting

OPTIONS | Advanced

Direct Power On On

Auto Power Off (min) 0

Off Timer (min) 0

Keypad Lock Off

Exit

Advanced

| Submenu | Option |
|----------------------|----------|
| Direct Power On | Off / On |
| Auto Power Off (min) | 0-180 |
| Off Timer (min) | 0-995 |
| Keypad Lock | Off / On |
| Factory Default | No / Yes |

Timing Table

| Mode | Resolution | V-Sync (Hz) |
|----------------|---------------|-------------|
| VGA | 640 x 480 | 60 |
| | 800 x 600 | 60 |
| | 1024 x 768 | 60 |
| | 1280 x 720 | 60 |
| | 1280 x 800 | 60 |
| YPbPr, HDMI | 480i / 480P | 60 |
| | 576i / 576P | 50 |
| | 720P | 50 / 60 |
| | 1080i / 1080P | 50 / 60 |

<Note>
Video format does not support content with B-Frame function.

The projector uses Pictsel File Viewer to open and view Microsoft® office files and Adobe® PDF files.

Supported Versions

| Office Version |
|------------------------|
| Microsoft® Office 95 |
| Microsoft® Office 97 |
| Microsoft® Office 2000 |
| Microsoft® Office 2003 |
| Microsoft® Office 2007 |
| Microsoft® Office 2010 |

Compatible Document Format

| Microsoft® Office Application | File Extension |
|-------------------------------|----------------|
| Word | .doc |
| | .docx |
| Power Point | .ppt |
| | .ppx |
| Excel | .xls |
| | .xlsx |
| Adobe PDF | .pdf |



MEDIA FILE SUPPORT LIST: VIDEO

Video

| File Type | Video | Resolution | Bit Rate | Frame Rate | Audio Code | Remark |
|---------------------------|--|------------|----------|------------|--|--|
| AVI MKV | XVID MPEG4 H.264 M-JPEG WMV3 | 1080P | 20Mbps | 30fps | AC3 DTS MPEG1/2/3 PCM ADPCM AAC | No support VC-1 AP H.264 support less than 4 reference frames |
| TS | H.264 | 1080P | 20Mbps | 30fps | AC3 AAC MPEG1/2/3 DTS LPCM | H.264 support less than 4 reference frames |
| DAT VOB MPG MPEG | MPEG-1 | 1080P | 20Mbps | 30fps | MPEG1/2/3 AC3 DTS LPCM | |
| MOV MP4 3GP | MPEG-4 H.264 H.263 | 1080P | 20Mbps | 30fps | AAC AMR PCM ADPCM | H.264 support less than 4 reference frames |
| RM RMVB | RV3 RV4 | 720P | 5Mbps | 30fps | Cook(RA4) AAC(RA9) RACP(RA10) | |
| WMV | WMV3 | 1080P | 20Mbps | 30fps | WMA2 WMA3 | No support VC-1 AP |

| Image | | | |
|-----------------------|-------------|-------------|----------------------------------|
| Image Type (Ext name) | Sub Type | Encode Type | Max Pixels |
| JPEG JPG | Baseline | YUV400 | No Limit |
| | | YUV420 | No Limit |
| | | YUV422 | No Limit |
| | | YUV440 | No Limit |
| | | YUV444 | No Limit |
| | Progressive | YUV400 | Width<=10240 & Height <= 6400 |
| | | YUV420 | |
| | | YUV422 | |
| | | YUV440 | |
| | | YUV444 | |
| BMP | | | No Limit |

| Music | | |
|-----------------------|-------------------|-----------------|
| Music Type (Ext name) | Sample Rate (KHz) | Bit Rate (Kbps) |
| MP1/MP2/MP3 | 8-48 | 8-320 |
| WMA | 22-48 | 5-320 |
| OGG | 8-48 | 64-320 |
| ADPCM-WAV | 8-48 | 32-384 |
| PCM-WAV | 8-48 | 128-1536 |
| AAC | 8-48 | 8-256 |

If you experience a problem with your projector, please refer to the following information. If a problem persists, please contact your local retailer or service center.

Image Problems

- [?]** No image appears on-screen
 - Ensure the power cord is correctly and securely connected.
 - Ensure the pins of connectors are not crooked or broken.
 - Make sure the projector is switched on.
- [?]** Image is out of focus
 - Adjust the Focus Dial.
 - Make sure the projection screen is between the required distance 20.18 to 213.17 inches (0.5 to 5.4 meters) from the projector. See page 4.
- [?]** Image is too small or too large
 - Move the projector closer to or further from the screen.

Audio Problems

- [?]** No sound
 - During music playback, press **▲** or **▼**.

<Note>

When the projector temperature reaches 85°C, the projector automatically shuts down due to the built-in temperature protection. This is not a malfunction. Let the projector cool down before switching it on again.

APPENDIX

Clause for Office / Document Viewer

The copyright is owned by Pícsel to avoid rights violated by end customer and third parties.

1. All IPR, including but not limited to copyright, in the Pícsel Products is owned by Pícsel or its supplier.
2. The End User may not:
 - make copies of the Pícsel Products or make them available for use by third parties.
 - reverse engineer, disassemble, reverse translate, or in any way decode the Pícsel Products or any copy or part of it in order to derive any source code. Save only as is permitted by any applicable law.
3. Pícsel makes no representations or warranties whether express or implied (by statute or otherwise) relating to the performance, quality, merchantability, or fitness for a particular purpose of the Pícsel Products or otherwise and all such representations or warranties are specifically disclaimed and excluded.
4. Pícsel agrees and acknowledges that Pícsel and the Pícsel Products will not be specifically mentioned in the end user license agreement.

COPYRIGHT / TRADEMARK

Copyright © Optoma Company Limited.
All rights reserved.

Optoma reserves the right to make technical changes. Optoma assumes no liability for damages incurred directly or indirectly from errors, omissions, or discrepancies between the device and this documentation. Other brands or logos are trademarks or registered trademarks of their respective companies.

This device is not intended for use in the direct field of view at visual display workplaces.