

ViewSonic®



PJL6243 LCD Projector User Guide

IMPORTANT: Please read this User Guide to obtain important information on installing and using your product in a safe manner, as well as registering your product for future service. Warranty information contained in this User Guide will describe your limited coverage from ViewSonic Corporation, which is also found on our web site at <http://www.viewsonic.com> in English, or in specific languages using the Regional selection box in the upper right corner of our website. "Antes de operar su equipo lea cuidadosamente las instrucciones en este manual"

Compliance Information

FCC Statement

This device complies with part 15 of FCC Rules. Operation is subject to the following two conditions: (1) this device may not cause harmful interference, and (2) this device must accept any interference received, including interference that may cause undesired operation.

This equipment has been tested and found to comply with the limits for a Class B digital device, pursuant to part 15 of the FCC Rules. These limits are designed to provide reasonable protection against harmful interference in a residential installation. This equipment generates, uses, and can radiate radio frequency energy, and if not installed and used in accordance with the instructions, may cause harmful interference to radio communications. However, there is no guarantee that interference will not occur in a particular installation. If this equipment does cause harmful interference to radio or television reception, which can be determined by turning the equipment off and on, the user is encouraged to try to correct the interference by one or more of the following measures:

- Reorient or relocate the receiving antenna.
- Increase the separation between the equipment and receiver.
- Connect the equipment into an outlet on a circuit different from that to which the receiver is connected.
- Consult the dealer or an experienced radio/TV technician for help.

Warning: You are cautioned that changes or modifications not expressly approved by the party responsible for compliance could void your authority to operate the equipment.

For Canada

- This Class B digital apparatus complies with Canadian ICES-003.
- Cet appareil numérique de la classe B est conforme à la norme NMB-003 du Canada.

CE Conformity for European Countries

 The device complies with the EMC Directive 2004/108/EC and Low Voltage Directive 2006/95/EC.

Following information is only for EU-member states:

The mark is in compliance with the Waste Electrical and Electronic Equipment Directive 2002/96/EC (WEEE).

The mark indicates the requirement NOT to dispose the equipment including any spent or discarded batteries or accumulators as unsorted municipal waste, but use the return and collection systems available.

If the batteries, accumulators and button cells included with this equipment, display the chemical symbol Hg, Cd, or Pb, then it means that the battery has a heavy metal content of more than 0.0005% Mercury or more than, 0.002% Cadmium, or more than 0.004% Lead.



Important Safety Instructions

1. Read these instructions.
2. Keep these instructions.
3. Heed all warnings.
4. Follow all instructions.
5. Do not use this unit near water.
6. Clean with a soft, dry cloth.
7. Do not block any ventilation openings. Install the unit in accordance with the manufacturer's instructions.
8. Do not install near any heat sources such as radiators, heat registers, stoves, or other devices (including amplifiers) that produce heat.
9. Do not defeat the safety purpose of the polarized or grounding-type plug. A polarized plug has two blades with one wider than the other. A grounding type plug has two blades and a third grounding prong. The wide blade and the third prong are provided for your safety. If the provided plug does not fit into your outlet, consult an electrician for replacement of the obsolete outlet.
10. Protect the power cord from being walked on or pinched particularly at plugs. Convenience receptacles and the point where they exit from the unit. Be sure that the power outlet is located near the unit so that it is easily accessible.
11. Only use attachments/accessories specified by the manufacturer.
12. Use only with the cart, stand, tripod, bracket, or table specified by the manufacturer, or sold with the unit. When a cart is used, use caution when moving the cart/unit combination to avoid injury from tipping over.
13. Unplug this unit when unused for long periods of time.
14. Refer all servicing to qualified service personnel. Servicing is required when the unit has been damaged in any way, such as: if the power-supply cord or plug is damaged, if liquid is spilled onto or objects fall into the unit, if the unit is exposed to rain or moisture, or if the unit does not operate normally or has been dropped.



Declaration of RoHS Compliance

This product has been designed and manufactured in compliance with Directive 2002/95/EC of the European Parliament and the Council on restriction of the use of certain hazardous substances in electrical and electronic equipment (RoHS Directive) and is deemed to comply with the maximum concentration values issued by the European Technical Adaptation Committee (TAC) as shown below:

Substance	Proposed Maximum Concentration	Actual Concentration
Lead (Pb)	0.1%	< 0.1%
Mercury (Hg)	0.1%	< 0.1%
Cadmium (Cd)	0.01%	< 0.01%
Hexavalent Chromium (Cr ⁶⁺)	0.1%	< 0.1%
Polybrominated biphenyls (PBB)	0.1%	< 0.1%
Polybrominated diphenyl ethers (PBDE)	0.1%	< 0.1%

Certain components of products as stated above are exempted under the Annex of the RoHS Directives as noted below:

Examples of exempted components are:

1. Mercury in compact fluorescent lamps not exceeding 5 mg per lamp and in other lamps not specifically mentioned in the Annex of RoHS Directive.
2. Lead in glass of cathode ray tubes, electronic components, fluorescent tubes, and electronic ceramic parts (e.g. piezoelectronic devices).
3. Lead in high temperature type solders (i.e. lead-based alloys containing 85% by weight or more lead).
4. Lead as an alloying element in steel containing up to 0.35% lead by weight, aluminium containing up to 0.4% lead by weight and as a copper alloy containing up to 4% lead by weight.

Copyright Information

Copyright © ViewSonic® Corporation, 2011. All rights reserved.

Macintosh and Power Macintosh are registered trademarks of Apple Inc.

Microsoft, Windows, Windows NT, and the Windows logo are registered trademarks of Microsoft Corporation in the United States and other countries.

ViewSonic, the three birds logo, OnView, ViewMatch, and ViewMeter are registered trademarks of ViewSonic Corporation.

VESA is a registered trademark of the Video Electronics Standards Association. DPMS and DDC are trademarks of VESA.

PS/2, VGA and XGA are registered trademarks of International Business Machines Corporation.

Disclaimer: ViewSonic Corporation shall not be liable for technical or editorial errors or omissions contained herein; nor for incidental or consequential damages resulting from furnishing this material, or the performance or use of this product.

In the interest of continuing product improvement, ViewSonic Corporation reserves the right to change product specifications without notice. Information in this document may change without notice.

No part of this document may be copied, reproduced, or transmitted by any means, for any purpose without prior written permission from ViewSonic Corporation.

Product Registration

To meet your future needs, and to receive any additional product information as it becomes available, please register your product on the Internet at: www.viewsonic.com. The ViewSonic® Wizard CD-ROM also provides an opportunity for you to print the registration form, which you may mail or fax to ViewSonic.

For Your Records

Product Name:	PJL6243 ViewSonic LCD Projector
Model Number:	VS13911
Document Number:	PJL6243_UG_ENG Rev. 1A 03-07-11
Serial Number:	_____
Purchase Date:	_____

Product disposal at end of product life

The lamp in this product contains mercury which can be dangerous to you and the environment. Please use care and dispose of in accordance with local, state or federal laws.

ViewSonic respects the environment and is committed to working and living green. Thank you for being part of Smarter, Greener Computing. Please visit ViewSonic website to learn more.

USA & Canada: <http://www.viewsonic.com/company/green/recycle-program/>

Europe: <http://www.viewsoniceurope.com/uk/support/recycling-information/>

Taiwan: <http://recycle.epa.gov.tw/recycle/index2.aspx>

User Guide

Network Set-up and Operation

PJ Network Manager for Windows

Features and Design

This Multimedia Projector is designed with the most advanced technology for portability, durability, and ease of use. This projector utilizes built-in multimedia features, a palette of 16.77 million colors, and matrix liquid crystal display (LCD) technology.

◆ **Compact Design**

This projector is designed compact in size and weight. It is easy to carry and installed anywhere you wish to use.

◆ **Simple Computer System Setting**

The projector has the Multi-scan system to conform to almost all computer output signals quickly (p.28). Up to WUXGA resolution can be accepted.

◆ **Useful Functions for Presentations**

- The digital zoom function allows you to focus on the crucial information during a presentation (p.35).
- The MIC function and 10W audio output allows you to make a presentation without any external audio equipment (p.24).

◆ **Lamp Control**

Brightness of the projection lamp can be selected (pp.25, 52).

◆ **Direct Off Function**

With the Direct Off function, you can disconnect the power cord from the wall outlet or turn off the breaker even during projection (p.20).

◆ **Logo Function**

The Logo function allows you to customize the screen logo (pp.46-48). You can capture an image for the screen logo and use it for the starting-up display or between presentations.

◆ **Multilanguage Menu Display**

Operation menu is available in 20 languages: English, German, French, Italian, Spanish, Portuguese, Dutch, Swedish, Finnish, Polish, Hungarian, Romanian, Russian, Turkish, Kazakh, Vietnamese, Chinese, Korean, Japanese and Thai.(p.44)

◆ **Security Function**

The Security function helps you to ensure security of the projector. With the Key lock

function, you can lock the operation on the top control or remote control (p.53). PIN code lock function prevents unauthorized use of the projector (pp.19, 53-54).

◆ **Helpful Maintenance Functions**

Lamp and filter maintenance functions provide for better and proper maintenance of the projector.

◆ **LAN Network Function**

This projector is loaded with the Wired LAN network function. You can operate and manage the projector via network. For details, refer to the User Guide of "Network Set-up and Operation."

◆ **Auto Setup Function**

This function enables Input search, Auto Keystone correction and Auto PC adjustment by simple pressing the AUTO SETUP button on the top control (p.45).

◆ **Colorboard Function**

At the time of simple projection on the colored wall, you can get the close color image to the color image projected on a white screen by selecting the similar color to the wall color from the preset four colors.

◆ **Switchable Interface Terminal**

The projector provides a switchable interface terminal. You can use the terminal as computer input or monitor output conveniently. (p.49)

◆ **Power Management**

The Power management function reduces power consumption and maintains the lamp life (p.49).

◆ **Closed Caption**

This is a printed version of the program sound or other information displayed on the screen. You can turn on the feature and switch the channels. (p.51)

Table of Contents

Compliance Information	i	Computer Input	27
Important Safety Instructions	ii	Input Source Selection (RGB: Computer 1/ Computer 2)	27
Declaration of RoHS Compliance ...	iii	Computer System Selection	28
Copyright Information	iv	Auto PC Adjustment	29
Product Registration	iv	Manual PC Adjustment	30
Features and Design	2	Image Mode Selection	32
Table of Contents	3	Image Adjustment	33
To the Owner	4	Screen Size Adjustment	34
Safety Instructions	5	Video Input	36
Air Circulation	6	Input Source Selection (Video, S-video)	36
Installing the Projector in Proper Position	6	Input Source Selection (Component, RGB Scart 21-pin)	37
Moving the Projector	6	Video System Selection	38
Compliance	7	Image Mode Selection	39
Contents of package	7	Image Adjustment	40
Part Names and Functions	8	Screen Size Adjustment	42
Front	8	Setting	44
Back	8	Setting	44
Bottom	8	Information	57
Rear Terminal	9	Input Source Information Display	57
Top Control	10	Maintenance and Cleaning	58
Remote Control	11	WARNING indicator	58
Remote Control Battery Installation	12	Replacing the Filter	59
Remote Control Operating Range	12	Resetting the Filter Counter	59
Remote Control Code	12	Attaching the Lens Cap	60
Adjustable Foot	12	Cleaning the Projection Lens	60
Installation	13	Cleaning the Projector Cabinet	60
Setting up	13	Lamp Replacement	61
Connecting to a Computer	14	Appendix	63
Connecting to Video Equipment	15	Troubleshooting	63
Connecting to Component Video and RGB (Scart) Equipment	16	Menu Tree	66
Using the Ferrite Core	17	Indicators and Projector Condition	68
Connecting the AC Power Cord	17	Compatible Computer Specifications	69
Basic Operation	18	Technical Specifications	70
Turning On the Projector	18	PJ Link Notice	71
Turning Off the Projector	20	Attaching the Filter Cover to the Projector	71
How to Operate the On-Screen Menu	21	Configurations of Terminals	72
Menu Bar	22	Dimensions	73
Zoom and Focus Adjustment	23	Serial Control Interface	74
Auto Setup Function	23	Customer Support	76
Keystone Correction	23	Limited Warranty	77
Sound Adjustment	24		
Remote Control Operation	25		

Trademarks

Each name of corporations or products in this book is either a registered trademark or a trademark of its respective corporation.





To the Owner

Before installing and operating this projector, read this manual thoroughly.

This projector provides many convenient features and functions.

Operating the projector properly enables you to manage those features and maintains it in good condition for many years to come. Improper operation may result in not only shortening the product-life, but also malfunctions, fire hazard, or other accidents.

If your projector seems to operate improperly, read this manual again, check operations and cable connections and try the solutions in the "Troubleshooting" section on pages 63-65 of this manual. If the problem still persists, contact the dealer where you purchased the projector or the service center.

	CAUTION RISK OF ELECTRIC SHOCK DO NOT OPEN	
CAUTION: TO REDUCE THE RISK OF ELECTRIC SHOCK, DO NOT REMOVE COVER (OR BACK). NO USER-SERVICEABLE PARTS INSIDE EXCEPT LAMP REPLACEMENT. REFER SERVICING TO QUALIFIED SERVICE PERSONNEL.		
	THIS SYMBOL INDICATES THAT DANGEROUS VOLTAGE CONSTITUTING A RISK OF ELECTRIC SHOCK IS PRESENT WITHIN THIS UNIT.	
	THIS SYMBOL INDICATES THAT THERE ARE IMPORTANT OPERATING AND MAINTENANCE INSTRUCTIONS IN THE USER GUIDE WITH THIS UNIT.	

NOTE FOR CUSTOMERS IN THE US

 LAMP(S) INSIDE THIS PRODUCT CONTAIN MERCURY AND MUST BE RECYCLED OR DISPOSED OF ACCORDING TO LOCAL, STATE OR FEDERAL LAWS.



Safety Precaution

WARNING:

- **THIS APPARATUS MUST BE EARTHED.**
- **TO REDUCE THE RISK OF FIRE OR ELECTRIC SHOCK, DO NOT EXPOSE THIS APPLIANCE TO RAIN OR MOISTURE.**
 - This projector produces intense light from the projection lens. Do not stare directly into the lens, otherwise eye damage could result. Be especially careful that children do not stare directly into the beam.
 - Install the projector in a proper position. Improper positioning may reduce the lamp life and result in severe accident or fire hazard.
 - Allowing the proper amount of space on the top, sides, and rear of the projector cabinet is critical for proper air circulation and cooling of the unit. The dimension shown here indicate the minimum space required. If the projector is to be built into a compartment or similarly enclosed, these minimum distances must be maintained.
 - Do not cover the ventilation slot on the projector. Heat build-up can reduce the service life of your projector, and can also be dangerous.

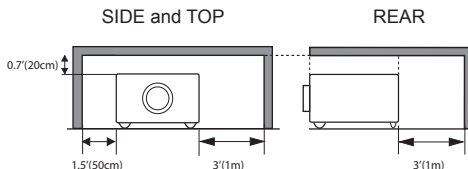

- If the projector is unused for an extended time, unplug the projector from the power outlet.
- Do not project the same image for a long time. The afterimage may remain on the LCD panels by the characteristic of panel.



CAUTION

DO NOT SET THE PROJECTOR IN GREASY, WET, OR SMOKY CONDITIONS SUCH AS IN A KITCHEN TO PREVENT A BREAKDOWN OR A DISASTER. IF THE PROJECTOR COMES IN CONTACT WITH OIL OR CHEMICALS, IT MAY BECOME DETERIORATED.



CAUTION

NOT FOR USE IN A COMPUTER ROOM AS DEFINED IN THE STANDARD FOR THE PROTECTION OF ELECTRONIC COMPUTER/DATA PROCESSING EQUIPMENT, ANSI/NFPA 75.

READ AND KEEP THIS USER GUIDE FOR LATER USE.

Safety Instructions

All the safety and operating instructions should be read before the product is operated.

Read all of the instructions given here and retain them for later use. Unplug this projector from AC power supply before cleaning. Do not use liquid or aerosol cleaners. Use a damp cloth for cleaning.

Follow all warnings and instructions marked on the projector.

For added protection to the projector during a lightning storm, or when it is left unattended and unused for long periods of time, unplug it from the wall outlet. This will prevent damage due to lightning and power line surges.

Do not expose this unit to rain or use near water... for example, in a wet basement, near a swimming pool, etc...

Do not use attachments not recommended by the manufacturer as they may cause hazards.

Do not place this projector on an unstable cart, stand, or table. The projector may fall, causing serious injury to a child or adult, and serious damage to the projector. Use only with a cart or stand recommended by the manufacturer, or sold with the projector. Wall or shelf mounting should follow the manufacturer's instructions, and should use a mounting kit approved by the manufacturers.

An appliance and cart combination should be moved with care. Quick stops, excessive force, and uneven surfaces may cause the appliance and cart combination to overturn.



Slots and openings in the back and bottom of the cabinet are provided for ventilation, to ensure reliable operation of the equipment and to protect it from overheating.

The openings should never be covered with cloth or other materials, and the bottom opening should not be blocked by placing the projector on a bed, sofa, rug, or other similar surface. This projector should never be placed near or over a radiator or heat register.

This projector should not be placed in a built-in installation such as a book case unless proper ventilation is provided.

Never push objects of any kind into this projector through cabinet slots as they may touch dangerous voltage points or short out parts that could result in a fire or electric shock. Never spill liquid of any kind on the projector.

Do not install the projector near the ventilation duct of air-conditioning equipment.

This projector should be operated only from the type of power source indicated on the marking label. If you are not sure of the type of power supplied, consult your authorized dealer or local power company.

Do not overload wall outlets and extension cords as this can result in fire or electric shock. Do not allow anything to rest on the power cord. Do not locate this projector where the cord may be damaged by persons walking on it.

Do not attempt to service this projector yourself as opening or removing Covers may expose you to dangerous voltage or other hazards. Refer all servicing to qualified service personnel.

Unplug this projector from wall outlet and refer servicing to qualified service personnel under the following conditions:

- When the power cord or plug is damaged or frayed.
- If liquid has been spilled into the projector.
- If the projector has been exposed to rain or water.
- If the projector does not operate normally by following the operating instructions. Adjust only those controls that are covered by the operating instructions as improper adjustment of other controls may result in damage and will often require extensive work by a qualified technician to restore the projector to normal operation.
- If the projector has been dropped or the cabinet has been damaged.
- When the projector exhibits a distinct change in performance-this indicates a need for service.

When replacement parts are required, be sure the service technician has used replacement parts specified by the manufacturer that have the same characteristics as the original part. Unauthorized substitutions may result in fire, electric shock, or injury to persons.

Upon completion of any service or repairs to this projector, ask the service technician to perform routine safety checks to determine that the projector is in safe operating condition.

Safety Instructions

Air Circulation

Openings in the cabinet are provided for ventilation. To ensure reliable operation of the product and to protect it from overheating, these openings must not be blocked or covered.

CAUTION

Hot air is exhausted from the exhaust vent. When using or installing the projector, the following precautions should be taken.

- Do not put any flammable object or spray can near the projector, hot air is exhausted from the ventilation holes.
- Keep the exhaust vent at least 3' (1 m) away from any objects.
- Do not touch a peripheral part of the exhaust vent, especially screws and metallic parts. These areas will become hot while the projector is being used.
- Do not put anything on the cabinet. Objects put on the cabinet will not only get damaged but also may cause fire hazard by heat.
- Make sure that there is no object under the projector to prevent from covering the bottom openings.

Cooling fans are provided to cool down the projector. The fans' running speed is changed according to the temperature inside the projector.

Air Intake Vent
(Filter)

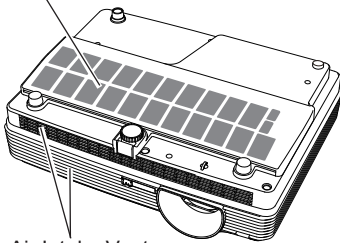

Air Intake Vent

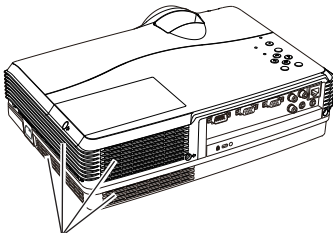

Exhaust Vent
(Hot air exhaust)

Installing the Projector in Proper Position

Install the projector properly. Improper installation may reduce the lamp life and cause a fire hazard.

Do not roll the projector more than 20 degrees from side to side.

Do not pitch the projector more than 30 degrees from above and below.



Do not point the projector up to project an image.



Do not point the projector down to project an image.



Do not put the projector on either side to project an image.

Moving the Projector

When moving the projector, retract the adjustable foot to prevent damage to the cabinet and use a suitable carrying case.

When this projector is not in use for an extended period, put it into a suitable case to protect the projector.

CAUTION IN CARRYING OR TRANSPORTING THE PROJECTOR

- Do not drop or bump the projector, otherwise damages or malfunctions may result.
- When carrying the projector, use a suitable carrying case.
- Do not transport the projector by courier or any other transport service in an unsuitable transport case. This may cause damage to the projector. For information about transporting the projector by courier or any other transport service, consult your dealer.
- Do not put the projector in a case before the projector is cooled enough.

Compliance

AC Power Cord Requirement

The AC Power Cord supplied with this projector meets the requirement for use in the country you purchased it.

AC Power Cord for the United States and Canada:

AC Power Cord used in the United States and Canada is listed by the Underwriters Laboratories (UL) and certified by the Canadian Standard Association (CSA).
AC Power Cord has a grounding-type AC line plug. This is a safety feature to be sure that the plug will fit into the power outlet. Do not try to defeat this safety feature. Should you be unable to insert the plug into the outlet, contact your electrician.

AC Power Cord for the United Kingdom:

This cord is already fitted with a moulded plug incorporating a fuse, the value of which is indicated on the pin face of the plug. Should the fuse need to be replaced, an ASTA approved BS 1362 fuse must be used of the same rating, marked thus \diamond . If the fuse cover is detachable, never use the plug with the cover omitted. If a replacement fuse cover is required, ensure it is of the same colour as that visible on the pin face of the plug (i.e. red or orange). Fuse covers are available from the Parts Department indicated in your User Instructions.

If the plug supplied is not suitable for your socket outlet, it should be cut off and destroyed.

The end of the flexible cord should be suitably prepared and the correct plug fitted.

WARNING : A PLUG WITH BARED FLEXIBLE CORD IS HAZARDOUS IF ENGAGED IN A LIVE SOCKET OUTLET.

The Wires in this mains lead are coloured in accordance with the following code:

- Green-and-yellowEarth
- BlueNeutral
- BrownLive

As the colours of the wires in the mains lead of this apparatus may not correspond with the coloured markings identifying the terminals in your plug proceed as follows:

The wire which is coloured green-and-yellow must be connected to the terminal in the plug which is marked by the letter E or by the safety earth symbol \perp or coloured green or green-and-yellow.

The wire which is coloured blue must be connected to the terminal which is marked with the letter N or coloured black.

The wire which is coloured brown must be connected to the terminal which is marked with the letter L or coloured red.









WARNING: THIS APPARATUS MUST BE EARTHED.

THE SOCKET-OUTLET SHOULD BE INSTALLED NEAR THE EQUIPMENT AND EASILY ACCESSIBLE.

Contents of package

Your projector should come with the items shown below. Check that all the items are included.

Require of your dealer immediately if any items are missing.

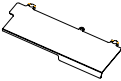
- | | | | |
|----------------------------------|---|---|--|
| (1) User Guide (CD-ROM x 1) | (1)  | (4)  | (7)  |
| (2) Quick Start Guide (Book x 1) | (2)  | (5)  | (8)  |
| (3) AC Power Cord | (3)  | (6)  | (9)  |

Part Names and Functions

Front

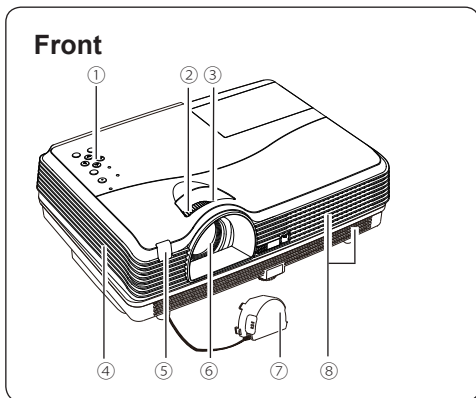

- ① Top controls and Indicators
 - ② Zoom Ring
 - ③ Focus Ring
 - ④ Speaker
 - ⑤ Infrared Remote Receiver
 - ⑥ Projection Lens
 - ⑦ Lens Cap
- (See page 60 for attaching.)

CAUTION

Do not turn on a projector with lens cap attached. High temperature from light beam may damage lens cap and result in fire hazard.

- ⑧ Air Intake Vent

Back

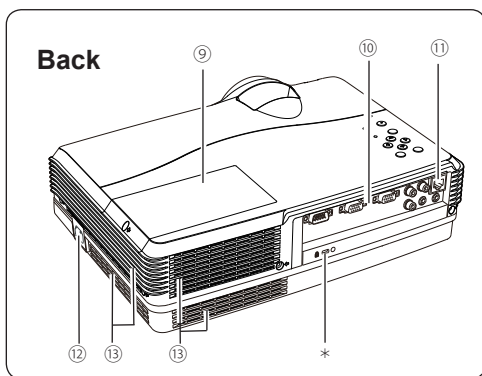

- ⑨ Lamp Cover
- ⑩ Terminals and Connectors
- ⑪ LAN Connection Terminal
- ⑫ Power Cord Connector

✓Note:

Replace only with the same types of the supplied cords or cables. Using improper cords or cables may cause an electric shock or a fire.

- ⑬ Exhaust Vents

CAUTION

Hot air is exhausted from the exhaust vent. Do not put heat-sensitive objects near this side.

Bottom

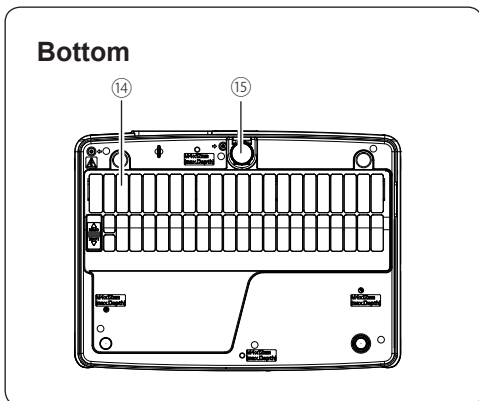

- ⑭ Filter
- ⑮ Adjustable Foot

✓Note:

⑪ LAN Connection Terminal is for the Network function. Refer to the User Guide of "Network Set-up and Operation".

* Kensington Security Slot

This slot is for a Kensington lock used to deter theft of the projector.

*Kensington is a registered trademark of ACCO Brands Corporation.

Rear Terminal

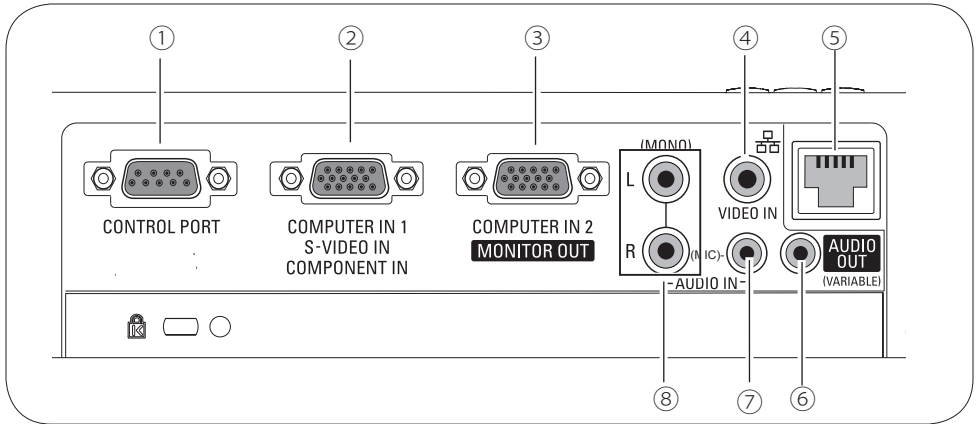

① CONTROL PORT

When the projector is controlled by a computer, connect to this jack with serial control cable.

② COMPUTER IN 1 /S-VIDEO IN / COMPONENT IN

Connect output signal from a computer, component video output, RGB scart 21-pin video output or S-video output to this terminal. (pp.14-16).

③ COMPUTER IN 2 / MONITOR OUT

- Connect analog RGB output signal from a computer to this terminal (p.14).
- This terminal can be used to output the incoming analog RGB and Component signal from COMPUTER IN 1 /S-VIDEO IN /COMPONENT IN terminal to the other monitor (pp.14,16).

④ VIDEO IN

Connect the composite video output signal to this jack (p.15).

⑤ LAN Connection Terminal

Connect the LAN cable (refer to the User Guide of "Network Set-up and Operation").

⑥ AUDIO OUT (VARIABLE)

Connect an external audio amplifier to this jack (pp.14-16). This terminal outputs sound from AUDIO IN terminal. Never plug headphones into this jack.

⑦ AUDIO IN (PC/MIC)

Connect the audio output signal from computer or video equipment connected to ② and ③ to this jack. Or connect the MIC to this jack. (pp.14-16).

⑧ AUDIO IN (L/R)

Connect the audio output signal from video equipment connected to ④ to this jack. For a mono audio signal (a single audio jack), connect it to L(MONO) jack. (p.15).

Note: When using AUDIO IN(PC/MIC) terminal as MIC input, these terminals can be used for PC audio input.

Top Control

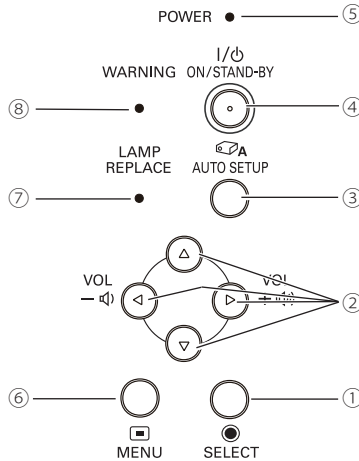

① SELECT button

- Execute the selected item (p.21).
- Expand or compress the image in the Digital zoom mode (p.35).

② POINT ▲▼◀▶ (VOLUME -/+) buttons

- Select an item or adjust the value in the On-Screen Menu (p.21).
- Pan the image in the Digital zoom +/- mode (p.35).
- Adjust the volume level (Point ◀▶ buttons) (p.24).

③ AUTO SETUP button

- Execute the setting of Auto setup (includes Input search, Auto PC adj. and Auto Keystone functions) in the setting menu. (pp.23, 45).

④ ON/STAND-BY button

- Turn the projector on or off (pp.18-20).

⑤ POWER indicator

- Lights red when the projector is in stand-by mode.
- Lights green during operations.
- Blinks green in the Power management mode (p.49).

⑥ MENU button

- Open or close the On-Screen Menu (p.21).

⑦ LAMP REPLACE indicator

- Lights yellow when the projection lamp reaches its end of life (pp.61, 68).

⑧ WARNING indicator

- Lights red when the projector detects an abnormal condition.
- Blinks red when the internal temperature of the projector exceeds the operating range (pp.58, 68).

Remote Control

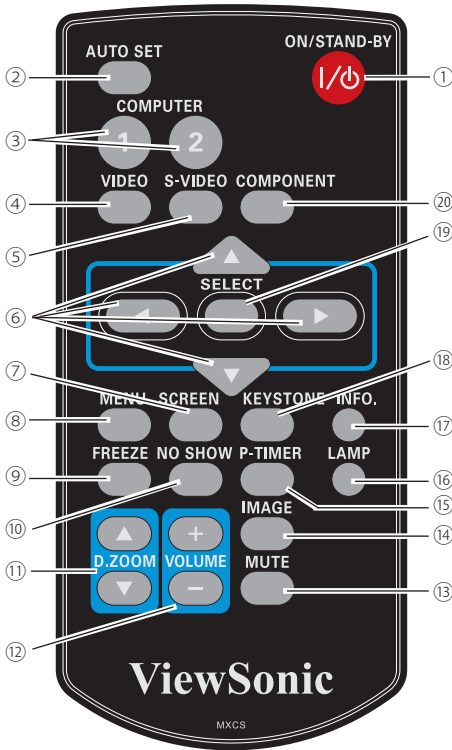

- ① **ON/STAND-BY button**
Turn the projector on or off. (pp.18-20)
- ② **AUTO SET button**
Execute the setting of Auto setup (includes Input search, Auto PC adj. and Auto Keystone functions) in the setting menu. (pp.23, 45)

✓**Note:**

- To ensure safe operation, please observe the following precautions:
- Do not bend, drop or expose the remote control to moisture or heat.
 - For cleaning, use a soft dry cloth. Do not apply benzene, thinner, spray, or any chemical material.

- ③ **COMPUTER 1/2 buttons**
Select the COMPUTER 1 or COMPUTER 2 input source. (pp.27, 37)
- ④ **VIDEO button**
Select the VIDEO input source. (p.36)
- ⑤ **S-VIDEO button**
Select the S-VIDEO input source. (p.36)
- ⑥ **Point ▲▼◀▶ buttons**
- Select an item or adjust the value in the On-Screen Menu. (p.21)
- Pan the image in the Digital zoom +/- mode. (p.35)
- ⑦ **SCREEN button**
Select a screen mode. (pp.26, 34-35, 42-43)
- ⑧ **MENU button**
Open or close the On-Screen Menu. (p.21)
- ⑨ **FREEZE button**
Freeze the picture on the screen. (p.25)
- ⑩ **NO SHOW button**
Temporarily turn off the image on the screen. (p.26)
- ⑪ **D.ZOOM ▲▼ buttons**
Zoom in and out the images. (pp.25, 35)
- ⑫ **VOLUME +/- buttons**
Adjust the volume level. (p.24)
- ⑬ **MUTE button**
Mute the sound. (p.24)
- ⑭ **IMAGE button**
Select the image mode. (pp.26, 32, 39)
- ⑮ **P-TIMER button**
Operate the P-timer function. (pp.26, 50)
- ⑯ **LAMP button**
Select a lamp mode. (pp.25, 52)
- ⑰ **INFO. button**
Operate the information function. (p.57)
- ⑱ **KEystone button**
Correct keystone distortion. (p.23)
- ⑲ **SELECT button**
- Execute the selected item. (p.21)
- Expand or compress the image in Digital zoom mode. (p.35)
- ⑳ **COMPONENT button**
Select the COMPONENT input source. (p.37)

Part Names and Functions

Remote Control Battery Installation

1 Open the battery compartment lid.



2 Install new batteries into the compartment.



3 Replace the compartment lid.

Two AAA size batteries

For correct polarity (+ and -), be sure battery terminals are in contact with pins in compartment.



To ensure safe operation, please observe the following precautions :

- Use two (2) AAA or LR03 type alkaline batteries.
- Always replace batteries in sets.
- Do not use a new battery with a used battery.
- Avoid contact with water or liquid.
- Do not expose the remote control to moisture or heat.
- Do not drop the remote control.
- If the battery has leaked on the remote control, carefully wipe the case clean and install new batteries.
- Risk of an explosion if battery is replaced by an incorrect type.
- Dispose of used batteries according to the instructions or your local disposal rule or guidelines.

Remote Control Operating Range

Point the remote control toward the projector (Infrared Remote Receiver) when pressing the buttons. Maximum operating range for the remote control is about 16.4'(5 m) and 60 degrees in front of the projector.

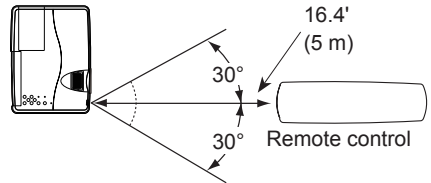

Remote Control Code

The 2 different remote control codes (Code 1–Code 2) are assigned to this projector. Switching the remote control codes prevents interference from other remote controls when several projectors or video equipment next to each other are operated at the same time. Change the remote control code for the projector first before changing that for the remote control. See "Remote control" in the Setting Menu on page 52.

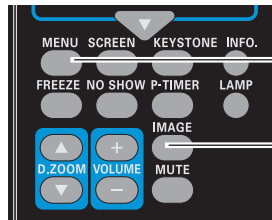

MENU button

IMAGE button

Press and hold the MENU and IMAGE buttons for more than five seconds to switch between the **Code 1** and **Code 2**. The initial code is set to **Code 1**.

Adjustable Foot

Projection angle can be adjusted up to 10.0 degrees with the adjustable foot.

Lift the front of the projector and push the foot lock latch on the projector.

Release the foot lock latch to lock the adjustable foot and rotate the adjustable foot to adjust the position and tilt.

To retract the adjustable foot, lift the front of the projector and push and undo the foot lock latch. Keystone distortion of the projected image can be corrected by menu operation. (see pages 23, 35, 43, 45)

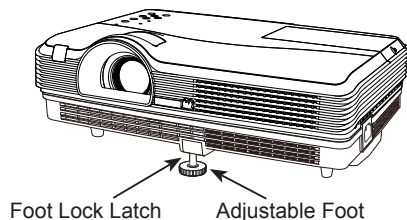

Installation

Setting up

Install the projector according to the environment and manner the projector will be used in. For the case of installation in a special state such as ceiling mount, the specified mounting accessories and service may be required. Before installing the projector, consult your dealer about your installation.

Arrangement

Refer to the following tables T-1 to determine the screen size and projection distance. The values shown in the table are calculated for a full size screen.

- (H) x (V) : Screen size
 (a) : Projection distance
 (from the projector's end)
 (b), (c) : Screen height

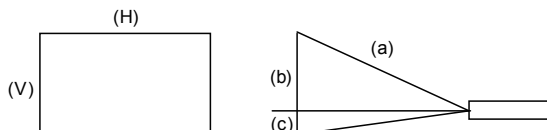

T-1

(1024X768) (±10%)

Screen Type	Screen size		Projection distance				Screen height			
	(H)	(V)	(a) min.		(a) max		(b)		(c)	
inch	m	m	m	inch	m	inch	cm	inch	cm	inch
40	0.8	0.6	1.1	45	1.4	54	52	20	-9	-4
50	1.0	0.8	1.4	56	1.7	68	65	26	-11	-4
60	1.2	0.9	1.7	68	2.1	82	78	31	-13	-5
70	1.4	1.1	2.0	79	2.4	96	91	36	-15	-6
80	1.6	1.2	2.3	91	2.8	109	105	41	-17	-7
90	1.8	1.4	2.6	102	3.1	123	118	46	-20	-8
100	2.0	1.5	2.9	114	3.5	137	131	52	-22	-9
120	2.4	1.8	3.5	137	4.2	164	157	62	-26	-10
150	3.0	2.3	4.4	171	5.2	206	196	77	-33	-13
200	4.1	3.0	5.8	229	7.0	275	261	103	-44	-17
250	5.1	3.8	7.3	286	8.7	344	327	129	-54	-21
300	6.1	4.6	8.7	344	10.5	413	392	154	-65	-26

Installation

Connecting to a Computer

Cables used for connection

- VGA Cables (Mini D-sub 15 pin) *(Only one cable is supplied.)
 - Audio Cables
- (*One cable is supplied; other cables are not supplied with the projector.)

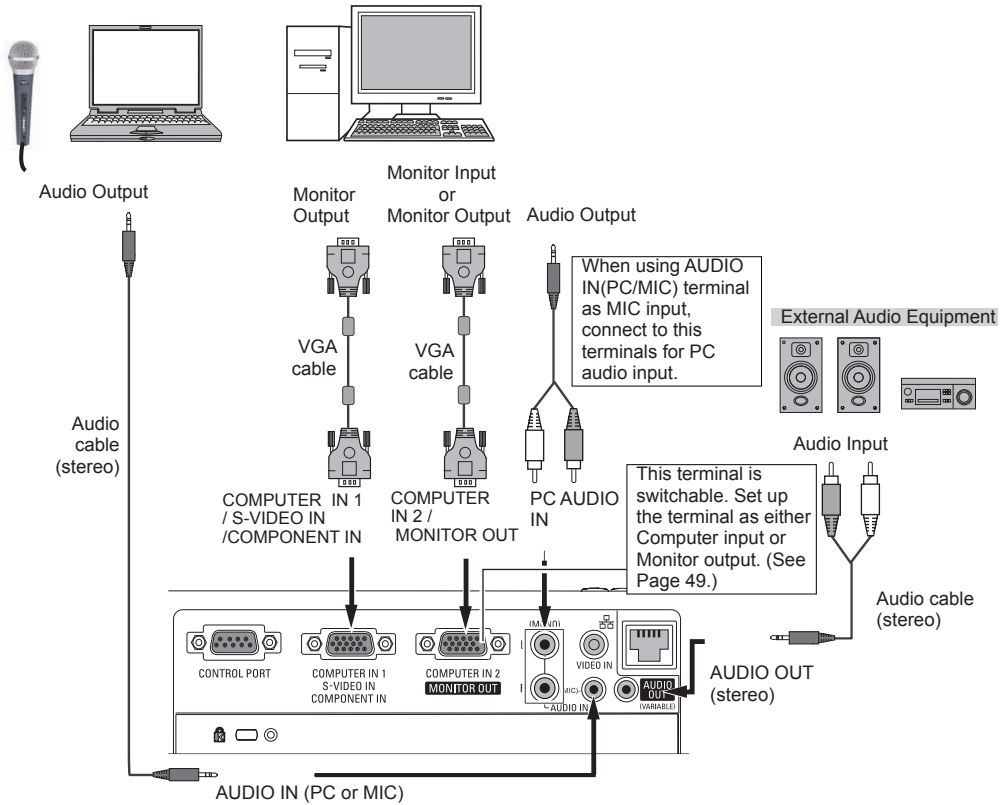

✓ **Note:**

- When the MIC function is set to **Off** in the Sound menu, the MIC function is disabled.
- When **MIC** is set to **On** in Sound Menu, AUDIO IN (PC/MIC) and AUDIO IN (L/R) terminals can be connected at the same time. At this time, AUDIO IN (PC/MIC) terminal as MIC input, AUDIO IN (L/R) terminal is as COMPUTER or VIDEO audio input.
- Input sound to the AUDIO IN terminal when using the COMPUTER IN 1/ S-VIDEO IN / COMPONENT IN and the COMPUTER IN 2/MONITOR OUT terminals as input.
- When the AUDIO OUT is plugged-in, the projector's built-in speaker is not available.
- When the cable is of the longer variety, it is advisable to use the COMPUTER IN 1/ S-VIDEO IN/ COMPONENT IN and not the COMPUTER IN 2/MONITOR OUT.



Unplug the power cords of both the projector and external equipment from the AC outlet before connecting cables.

Connecting to Video Equipment

Cables used for connection

- Video Cable
 - S-video Cable
 - S-video-VGA Cable
 - Audio Cables
- (Cables are not supplied with the projector.)

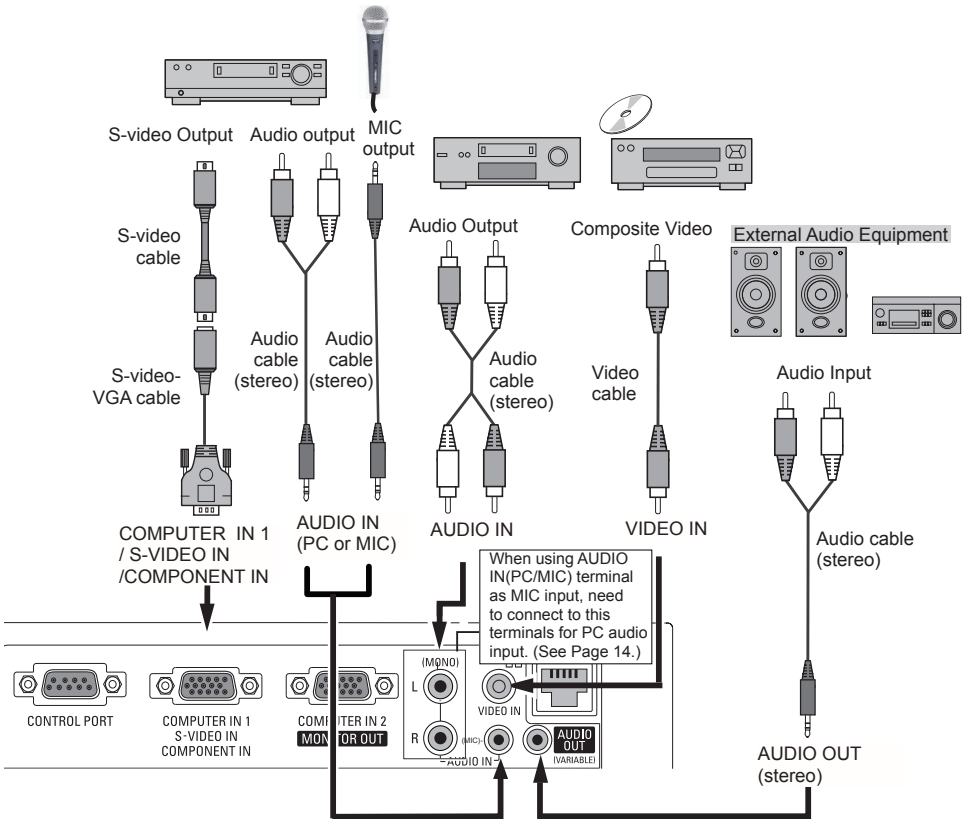

✓ Note:

- When the MIC function is set to **Off** in the Sound menu, the MIC function is disabled.
- When the AUDIO OUT is plugged-in, the projector's built-in speaker is not available.



Unplug the power cords of both the projector and external equipment from the AC outlet before connecting cables.

Installation

Connecting to Component Video and RGB (Scart) Equipment

Cables used for connection

- Audio Cables
- Scart-VGA Cable
- Component Cable
- Component-VGA Cable

(Cables are not supplied with this projector.)

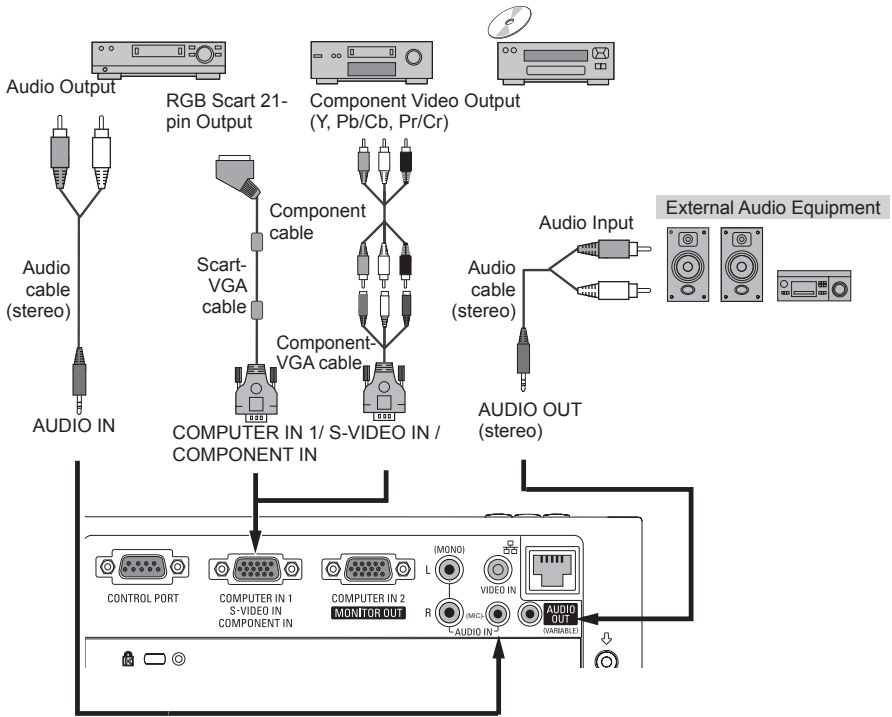

✓Note:

- When using MIC function, see page 14 for detail about connection.
- When the AUDIO OUT is plugged-in, the projector's built-in speaker is not available.



Unplug the power cords of both the projector and external equipment from the AC outlet before connecting cables.

Using the Ferrite Core

Before using the AC Power Cord, attach the ferrite core (supplied) as shown below. (See below for mounting location.)

The Power Cord with ferrite core must be used for RF interference suppression.

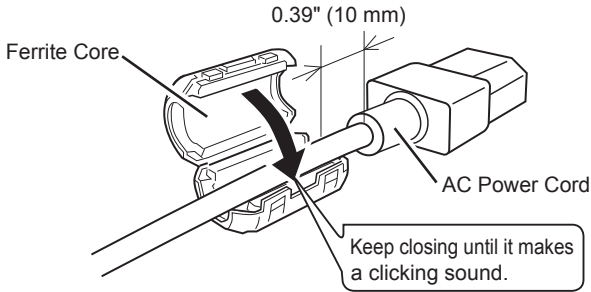

Connecting the AC Power Cord

This projector uses nominal input voltages of 100-240 V AC and it automatically selects the correct input voltage. It is designed to work with single-phase power systems having a grounded neutral conductor. To reduce the risk of electrical shock, do not plug into any other type of power system.

If you are not sure of the type of power being supplied, consult your authorized dealer or service center.

Connect the projector with all peripheral equipment before turning the projector on.

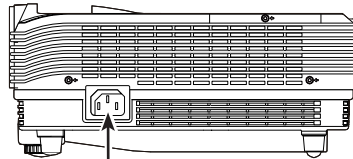

Connect the AC power cord (supplied) to the projector.

CAUTION



The AC outlet must be near this equipment and must be easily accessible.

✓ Note:

Unplug the AC power cord when the projector is not in use. When this projector is connected to an outlet with the AC power cord, it is in Stand-by mode and consumes a little electric power.

NOTE ON THE POWER CORD

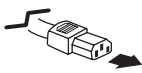
AC power cord must meet requirement of the country where you use the projector. Confirm the AC plug type with the chart below and proper AC power cord must be used. If supplied AC power cord does not match your AC outlet, contact your sales dealer.

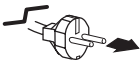
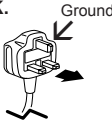
Projector side	AC outlet side		
 <p>To power cord connector on your projector.</p>	<p>For the U.S.A. and Canada</p>  <p>Ground</p> <p>To the AC outlet. (120 V AC)</p>	<p>For Continental Europe</p>  <p>To the AC outlet. (200 - 240 V AC)</p>	<p>For the U.K.</p>  <p>Ground</p> <p>To the AC outlet. (200 - 240 V AC)</p>

Basic Operation

Turning On the Projector

- 1 Complete peripheral connections (with a computer, VCR, etc.) before turning on the projector.
- 2 Connect the projector's AC power cord into an AC outlet. The POWER indicator lights red. Open the lens cap.
- 3 Press the ON/STAND-BY button on the top control or on the remote control. The POWER indicator lights green and the cooling fans start to operate. The preparation display appears on the screen.
- 4 After about 3 seconds, the input source that was selected the last time and the lamp control status icon (see page 52) appear on the screen.
- 5 If there is no signal input when start on the projector, or the current signal is missed while operating the projector, the Video/PC selection window will be displayed on the screen, please move the pointer to input source desired by pressing the Point ▲ ▼ buttons and press the SELECT button. And then follow the input signal guidance window to correct the signal and connection.

If the projector is locked with a PIN code, PIN code input dialog box will appear. Enter the PIN code as instructed on the next page.



The preparation display will disappear after 3 seconds.

Selected Input Source and Lamp Control

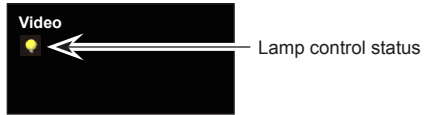

(See page 52 for Lamp control status.)

✓ Note:

The Filter warning and Lamp replacement icons may appear on the screen depending on the usage state of the projector.

Video / PC selection window



Input signal guidance window

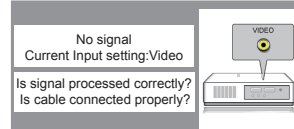

Video / PC selection window



Input signal guidance window

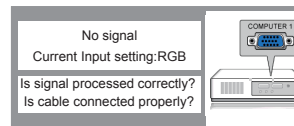

✓ Note:

- When the Logo select function is set to **Off**, the logo will not be shown on the screen (p.46).
- When **Off** is selected in the Display function, the preparation display will not be shown on the screen (p.46).
- When the Input Search function is set to **On 2**, the input signal will be searched automatically (p.45).
- When **Off** is selected in the Display function, the Video/PC selection window and the input signal guidance window are not shown on the screen. (p.46)

Enter a PIN code

Use the Point ▲▼ buttons to enter a number. Press the Point ► button to fix the number and move the red frame pointer to the next box. The number changes to *. If you fixed an incorrect number, use the Point ◀ button to move the pointer to the number you want to correct, and then enter the correct number.

Repeat this step to complete entering a four-digit number.

After entering the four-digit number, move the pointer to "Set". Press the SELECT button so that you can start to operate the projector.

If you entered an incorrect PIN code, **PIN code** and the number (* ***) will turn red for a moment. Enter the correct PIN code all over again.

PIN Code Input Dialog Box

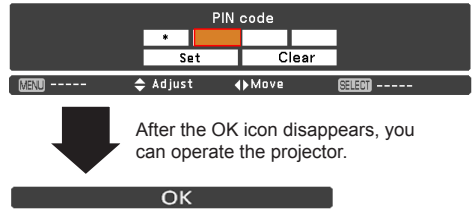

What is PIN code?

PIN (Personal Identification Number) code is a security code that allows the person who knows it to operate the projector. Setting a PIN code prevents unauthorized use of the projector.

A PIN code consists of a four-digit number. Refer to the PIN code lock function in the Setting Menu on pages 53-54 for locking operation of the projector with your PIN code.

✓Note:

- If the PIN code number is not entered or wrong PIN code number is entered within three minutes after the PIN code dialog box appeared, the projector will be turned off automatically.
- The "1234" is set as the initial PIN code at the factory.
- If you forget your PIN code, the projector can no longer be started.

Basic Operation

Turning Off the Projector

- 1 Press the ON/STAND-BY button on the top control or on the remote control, and **Power off?** appears on the screen.
- 2 Press the ON/STAND-BY button again to turn off the projector. The POWER indicator lights red and the cooling fans stop (default setting), and you can unplug the AC power cord.

If **L1** is selected in Fan menu (p.55), the POWER indicator starts to blink red and the cooling fans keep running for about 60 seconds, then the POWER indicator lights red and the cooling fans stop. You can unplug the AC power cord even if the cooling fans are still running.

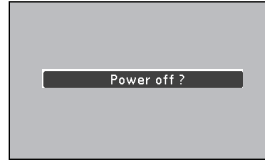

Power off? disappears after 4 seconds.



TO MAINTAIN THE LIFE OF THE LAMP, ONCE YOU TURN THE PROJECTOR ON, WAIT AT LEAST FIVE MINUTES BEFORE TURNING IT OFF.



DO NOT OPERATE THE PROJECTOR CONTINUOUSLY WITHOUT REST. CONTINUOUS USE MAY RESULT IN SHORTENING THE LAMP LIFE. TURN OFF THE PROJECTOR AND LET STAND FOR ABOUT AN HOUR IN EVERY 24 HOURS.

✓Note:

- When the Direct on function is set to **On**, the projector will be turned on automatically by connecting the AC power cord to an AC outlet (p.49).
- The running speed of cooling fans is changed according to the temperature inside the projector.
- Do not put the projector in a case before the projector is cooled enough.
- If the WARNING indicator blinks or lights red, see “WARNING indicator” on page 58.
- While the POWER indicator is blinking, the lamp is being cooled down and the projector cannot be turned on. Wait until the POWER indicator stops blinking to turn on the projector again.
- The projector can be turned on after the POWER indicator lights red.
- When **L2** is selected in Fan menu (p.55) and the projector is turned on right after it turns off, it takes a while to start projecting.

Direct Off Function

You can disconnect the power cord from the wall outlet or turn off the breaker even during projection without pressing the ON/STAND-BY button.

✓Note:

When using the Direct Off function, you can not restart the projector immediately after the power is disconnected. If the external power supply is suddenly cut off, the fans stop immediately. The lamp remains high temperature and needs to be cooled.

How to Operate the On-Screen Menu

The projector can be adjusted or set via the On-Screen Menu. The menus have a hierarchical structure, with a main menu that is divided into submenus, which are further divided into other submenus. For each adjustment and setting procedure, refer to respective sections in this manual.

- 1 Press the MENU button on the top control or the remote control to display the On-Screen Menu.
- 2 Use the Point ▲▼ buttons to highlight or select a main menu item. Press the Point ► or the SELECT button to access the submenu items. (The selected item is highlighted in orange.)
- 3 Use the Point ▲▼ buttons to select the desired submenu item and press the SELECT button to set or access the selected item.
- 4 Use the Point ▲▼◀► buttons to adjust the setting or switch between each option and press the SELECT button to activate it and return to the submenu.
- 5 Press the Point ◀ button to return to the main menu. Press the MENU button to exit the On-Screen Menu.

Top Control

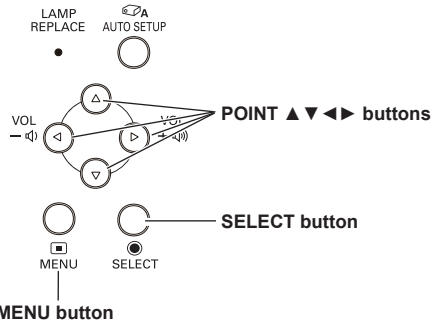

Remote Control

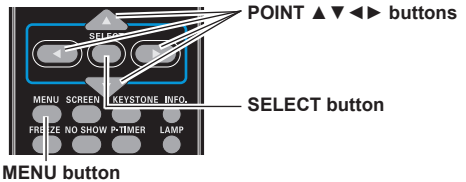

On-Screen Menu

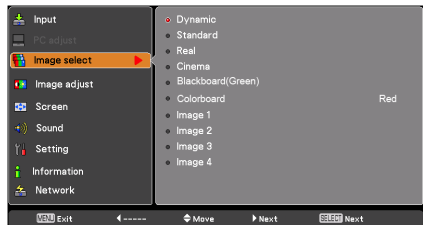

The currently set item is marked.

The selected item is highlighted in orange.

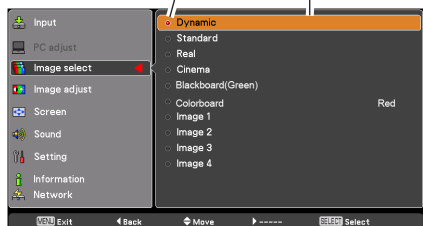

Basic Operation

Menu Bar

For detailed functions of each menu, see “Menu Tree” on pages 66-67.

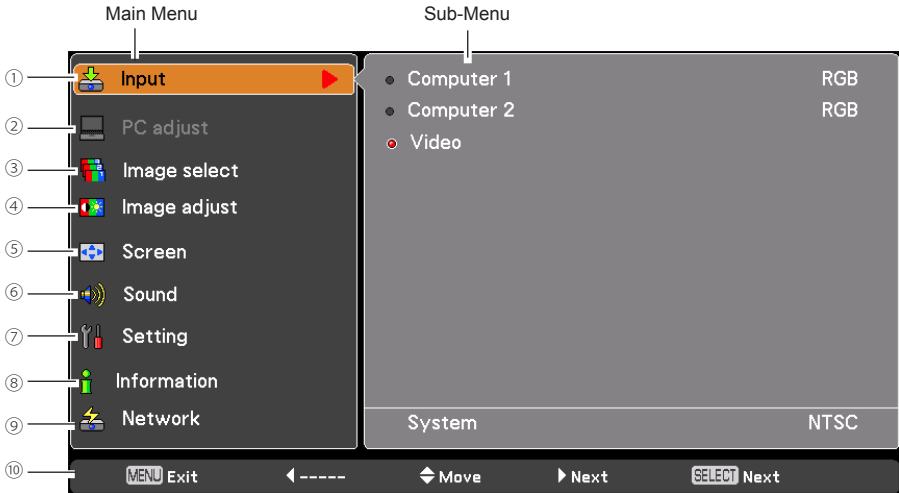

① Input

Used to select an input source from **Computer 1**, **Computer 2** or **Video** (pp.27, 36-37).

② PC adjust

Select **Auto PC adj.**, **Fine sync**, **Total dots**, **Horizontal**, **Vertical**, **Current mode**, **Clamp**, **Display area-H** and **Display area-V** to adjust the parameters to match with the PC input signal format (pp.29-31).

③ Image select

Used to select an image mode from among **Dynamic**, **Standard**, **Real**, **Cinema**, **Blackboard(Green)**, **Colorboard** and **Image 1-4**. (pp.32, 39)

④ Image adjust

For computer source, used to adjust computer image [**Contrast**, **Brightness**, **Iris**, **Color temp.**, **White balance (R/G/B)**, **Sharpness**, **Gamma**, **Reset** and **Store**] (p.33).

For Video source, used to adjust picture image [**Contrast**, **Brightness**, **Color**, **Tint**, **Iris**, **Color temp.**, **White balance (R/G/B)**, **Sharpness**, **Gamma**, **Noise reduction**, **Progressive**, **Reset** and **Store**] (pp.40-41).

⑤ Screen

For computer source, used to adjust size of the image [**Normal**, **Full**, **Wide(16:9)**, **Zoom**, **True**, **Custom**, **Custom adj.**, **Digital zoom +/-**, **Keystone**, **Ceiling**, **Rear** and **Reset**] (pp.34-35).

For Video source, used to set size of image [**Normal**, **Full**, **Wide(16:9)**, **Zoom**, **Custom**, **Custom adj.**, **Keystone**, **Ceiling**, **Rear** and **Reset**] (pp.42-43).

⑥ Sound

Used to adjust the volume or mute the sound or set configurations to the MIC functions (p.24).

⑦ Setting

Used to set the projector's operating configurations (pp.44-56).

⑧ Information

Display the input source information: **Input**, **H-sync freq.**, **V-sync freq.**, **Screen**, **Language**, **Lamp status**, **Lamp counter**, **Power management**, **Key lock**, **PIN code lock** and **Remote control**. (p.57)

⑨ Network

See User Guide of “Network Set-up and Operation”.

⑩ Guide

The key operation is displayed.

Zoom and Focus Adjustment

Rotate the Zoom Ring to zoom in and out.
Rotate the Focus Ring to adjust the focus of the image.

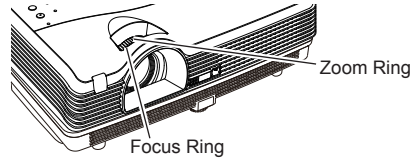

Auto Setup Function

Auto setup function is provided to automatically execute the setting of Auto setup (includes Input search, Auto PC adj. and Auto Keystone functions) in the setting menu by just pressing the AUTO SETUP button on the top control or the AUTO SET button on the remote control. Refer to page 45 for the setting of the Auto setup function.

✓**Note:**

- Auto Keystone corrects vertical distortion only; it does not correct horizontal distortion.
- Auto Keystone cannot work when Ceiling feature is set to **On** in the Setting menu (pp.35,43).
- Perfect correction of the image distortion cannot be ensured with the Auto setup function. If the distortion cannot be corrected properly by pressing the AUTO SETUP or AUTO SET button, adjust manually by pressing the KEYSTONE button on the remote control or selecting Keystone in the Screen menu (pp.35,43).
- **Fine sync, Total dots, Horizontal and Vertical** position of some computers cannot be fully adjusted with the Auto PC Adjustment function. When the image is not provided properly with this operation, manual adjustments are required (pp.30-31).

Top Control

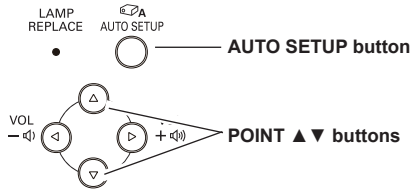

Remote Control

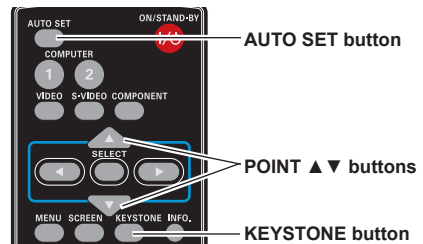

Keystone Correction

If a projected picture still has keystone distortion after pressing the AUTO SETUP button on the top control or the AUTO SET button on the remote control, correct the image manually as follows:

Press the KEYSTONE button on the remote control. The Keystone dialog box appears. Use the Point ▲ ▼ buttons to correct keystone distortion. The keystone adjustment can be stored (see pages 35,43).

Reduce the upper width with the Point ▲ button.

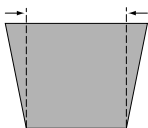

Reduce the lower width with the Point ▼ button.

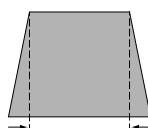

Keystone

- The white arrows indicate that there is no correction.
- A red arrow indicates the direction of correction.
- An arrow disappears at the maximum correction.
- If you press the KEYSTONE button on the remote control once more while the keystone dialog box is being displayed, the keystone adjustment will be canceled.
- The adjustable range is limited depending on the input signal.

Basic Operation

Sound Adjustment

Direct Operation

Volume

Press the VOLUME +/- buttons on the top control or on the remote control to adjust the volume. The volume dialog box appears on the screen for a few seconds.

Mute

Press the MUTE button on the remote control to select **On** to temporarily turn off the sound. To turn the sound back on, press the MUTE button again to select **Off** or press the VOLUME +/- buttons. The Mute function is also effective for the AUDIO OUT jack.

Menu Operation

- 1 Press the MENU button to display the On-Screen Menu. Use the Point **▲▼** buttons to select **Sound**. Press the Point **▶** or the SELECT button to access the submenu items.
- 2 Use the Point **▲▼** buttons to select the desired submenu item and press the SELECT button to access the selected item.

Volume

Press the Point **▶** button to turn up the volume; Press the Point **◀** button to turn down the volume.

Mute

Press the SELECT button to switch the mute function **On/Off**. When the sound is turned off, **On** is displayed. Press the VOLUME +/- buttons again or adjust MIC gain's volume to turn the sound back on.

MIC

Use the Point **▲▼** buttons to switch the MIC function **On/Off**, and then press the SELECT button. When **On** is selected, the synthesis volume (MIC and RCA) is output.

MIC gain

Press the Point **▶** button to turn up the MIC mixing gain; Press the Point **◀** button to turn down the MIC mixing gain.

Standby MIC out

When setting the Standby MIC out function to **On** and in Standby mode status, only MIC input volume can be output.

✓Note:

- When **Off** is selected in MIC function, the MIC gain and Standby MIC out functions are not available.
- Only the Standby mode is set to **Network**, **Standby MIC out** can be selected.
- If the MIC function is turned on when connecting PC audio to the AUDIO IN (a mini jack), loud sound may be output suddenly depending on the setting value of MIC gain.

Top Control

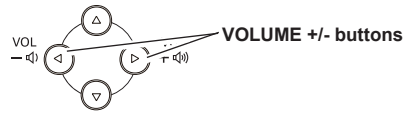

Remote Control



Volume Dialog Box

Approximate level of the volume.

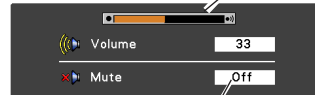

Press the MUTE button to set the Mute function **On** or **Off**. The dialog box disappears after 4 seconds.

Sound Menu

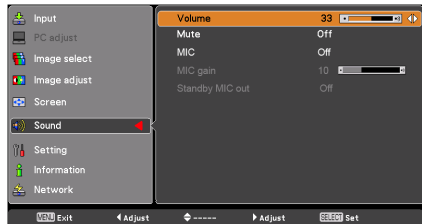

AUDIO INPUT SELECTION (see pages 14-15)

	AUDIO IN	
MIC Setup	RCA L/R terminal	Mini jack
MIC Off	Video audio input	PC audio input
MIC On	Video or PC audio input	MIC input

Remote Control Operation

Using the remote control for some frequently used operations is advisable. Just pressing one of the buttons enables you to make the desired operation quickly without calling up the On-Screen Menu.

COMPUTER 1/2, VIDEO, S-VIDEO and COMPONENT buttons

Press the COMPUTER 1/2, VIDEO, S-VIDEO and COMPONENT buttons on the remote control to select the input source. See pages 27, 36-37 for details.

FREEZE button

Press the FREEZE button on the remote control to freeze the picture on the screen, meanwhile, volume is muted. To cancel the Freeze function, press the FREEZE button again or press any other button. Fig.1 will appear on the screen while the Freeze function is working.

Fig.1



INFO. button



Display the input source information: **Input, H-sync freq., V-sync freq., Screen, Language, Lamp status, Lamp counter, Power management, Key lock, PIN code lock and Remote control** (p.57).

D.ZOOM buttons

Press the D.ZOOM buttons on the remote control to enter to the Digital zoom +/- mode. See page 35 for details.

LAMP button

Press the LAMP button on the remote control to select the lamp mode for changing the brightness on the screen.

-  High Brighter than the Normal mode.
-  Normal..... Normal brightness
-  Eco Lower brightness reduces the lamp power consumption and extends the lamp life.

Remote Control

COMPUTER 1/2 buttons

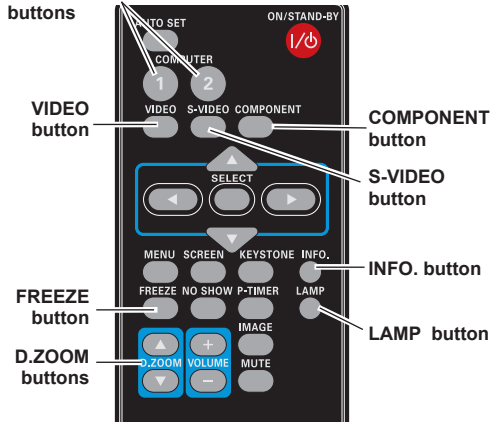

- ✓ **Note:**
See the next page for the description of other buttons.

Basic Operation

NO SHOW button

Press the NO SHOW button on the remote control to black out the image. To restore to normal, press the NO SHOW button again or press any other button. When the projected image is captured and is set as User in the Logo selection (p. 46), the screen changes each time you press the NO SHOW button as follows.

black out → the captured image → normal → •••••

✓ Note:

When use the MUTE button to release the No Show function, the mute function can not be operated at the same time.

Remote Control

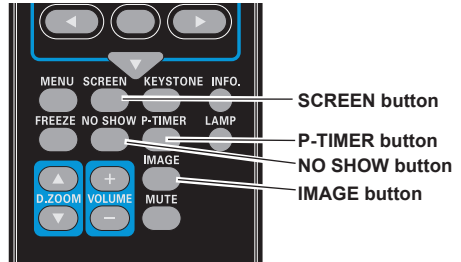

✓ Note:

See the previous page for the description of other buttons.

P-TIMER button

Press the P-TIMER button on the remote control to operate the Count up/Count down function. Refer to p.50 for detail of Setting for the P-timer function.

To stop the count time, press the P-TIMER button. To cancel the P-timer function, press and hold the P-TIMER button.

No Show



No show disappears after 4 seconds.

IMAGE button

Press the IMAGE button on the remote control to select a desired image mode of the screen. See pages 32, 39 for details.

P-Timer



SCREEN button

Select the screen size (See pages 34-35, 42-43 for details).

Computer Input

Input Source Selection (RGB: Computer 1/Computer 2)

Direct Operation

Choose either **Computer 1(RGB)** or **Computer 2(RGB)** by pressing the COMPUTER 1 or COMPUTER 2 button on the remote control.

Before using these buttons, correct input source should be selected through Menu operation as described below.

Remote Control

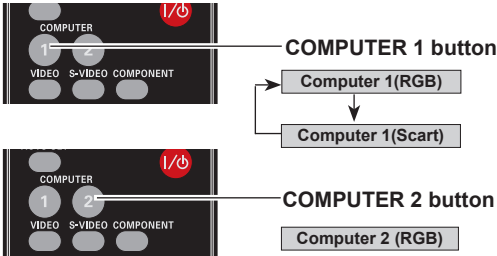

Menu Operation

- 1 Press the MENU button to display the On-Screen Menu. Use the Point ▲▼ buttons to select **Input** and then press the Point ► or the SELECT button.
- 2 Use the Point ▲▼ buttons to select **Computer 1**.
OR
Use the Point ▲▼ buttons to select **Computer 2** and then press the SELECT button.
- 3 When **Computer 1** is selected, press the Point ► button to access the submenu items. Use the Point ▲▼ buttons to select the RGB input source and then press the SELECT button.

✓ Note:

When the Input Search function is set to **On 1** or **On 2** in the Auto setup function, the input signal will be searched automatically (p.45).

Input Menu

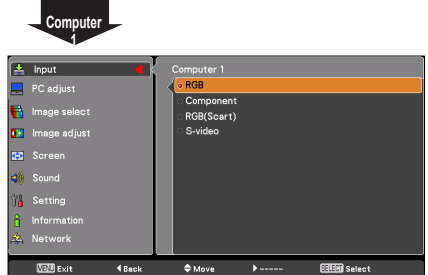
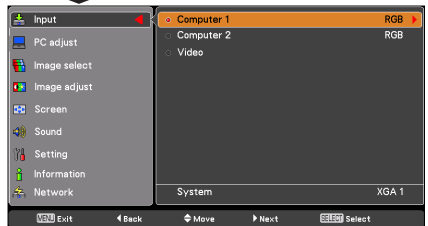
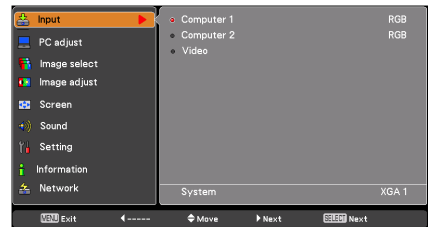

Computer System Selection

This projector automatically tunes to various types of computers with its Multi-scan system and Auto PC Adjustment. If a computer is selected as a signal source, this projector automatically detects the signal format and tunes to project a proper image without any additional settings. (Signal formats provided in this projector are shown on page 69.)

One of the following messages may appear when:

Auto When the projector cannot recognize the connected signal conforming to the provided PC systems, **Auto** is displayed on the System Menu box and the Auto PC Adjustment function works to display proper images. If the image is not projected properly, a manual adjustment is required (pp. 30-31).

----- There is no signal input from the computer. Check the connection between your computer and the projector. (See "Troubleshooting" on p. 63.)

Mode 1 The preset system is manually adjusted in the PC adjust Menu. The adjusted data can be stored in **Mode 1–10** (pp. 30-31).

SVGA 1 PC Systems provided in this projector is chosen. The projector chooses a proper system provided in the projector and displays it.

***Mode 1** and **SVGA 1** are examples.

PC System Menu

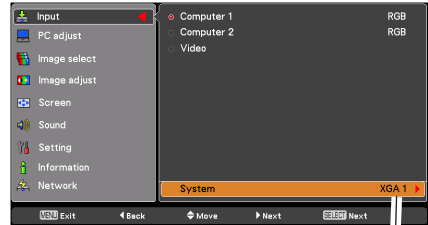

Selected system in the PC System Menu is displayed.

Selecting Computer System Manually

PC system can also be selected manually.

- 1 Press the MENU button to display the On-Screen Menu. Use the Point ▲▼ buttons to select **Input** and then press the Point ► or the SELECT button.
- 2 Use the Point ▲▼ buttons to select **System** and then press the Point ► or the SELECT button.
- 3 Use the Point ▲▼ buttons to select the desired system and then press the SELECT button.

PC System Menu

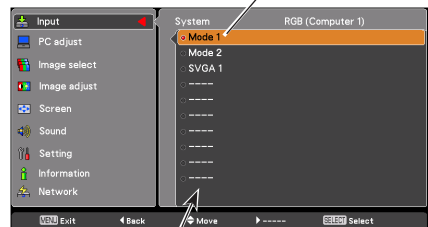

Customized **Mode (1–10)** set in the PC adjust Menu (pp. 30-31).

Systems in this dialog box can be selected.

Auto PC Adjustment

Auto PC Adjustment function is provided to automatically adjust **Fine sync**, **Total dots**, **Horizontal** and **Vertical** positions to conform to your computer.

Menu Operation

Auto PC adj.

- 1 Press the MENU button to display the On-Screen Menu. Use the Point ▲▼ buttons to select **PC adjust** and then press the Point ► or the SELECT button.
- 2 Use the Point ▲▼ buttons to select **Auto PC adj.** and then press the SELECT button.

To store adjustment parameters

The adjusted parameters from the Auto PC Adjustment can be stored in the projector. Once the parameters are stored, the setting can be done just by selecting a **Mode (1-10)** in the PC System Menu (see page 28). See also "Store" on page 31.

✓Note:

- **Fine sync**, **Total dots**, **Horizontal** and **Vertical** position of some computers cannot be fully adjusted with the Auto PC Adjustment function. When the image is not provided properly with this operation, manual adjustments are required (pp. 30-31).
- The Auto PC Adjustment cannot be operated when **480i**, **576i**, **480p**, **576p**, **720p**, **1035i** or **1080i** is selected in the PC System Menu (p. 28).

PC adjust Menu

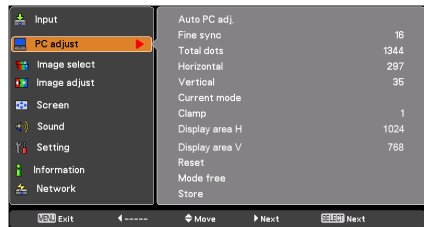

Use Point ▲▼ buttons to select **Auto PC adj.** and press the SELECT button. **Please wait...** appears while the Auto PC adjustment is in process.

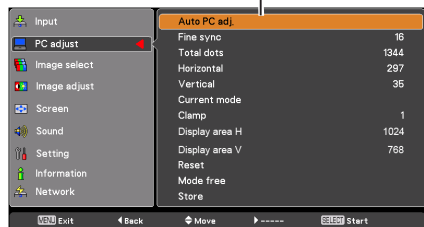

Computer Input

Manual PC Adjustment

Some computers employ special signal formats which may not be tuned by Multi-scan system of this projector. Manual PC Adjustment enables you to precisely adjust several parameters to match those signal formats. The projector has 10 independent memory areas to store those parameters manually adjusted. It allows you to recall the setting for a specific computer.

- 1 Press the MENU button to display the On-Screen Menu. Use the Point ▲▼ buttons to select **PC adjust** and then press the Point ► or the SELECT button.
- 2 Use the Point ▲▼ buttons to select the desired item and then press the SELECT button to display the adjustment dialog box. Use the Point ◀▶ buttons to adjust the setting value.

PC adjust Menu

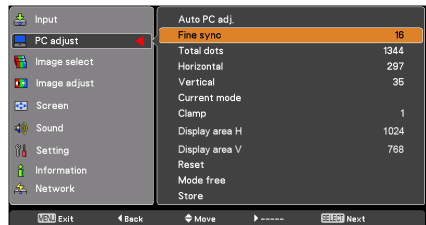
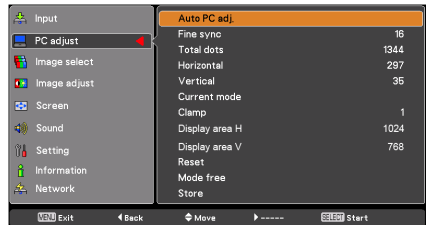
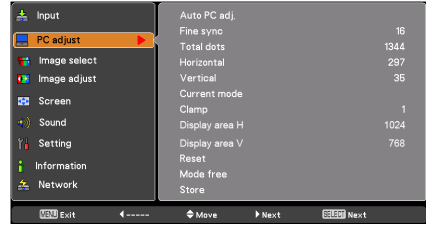

Fine sync

Use the Point ◀▶ buttons to adjust the value, eliminating a flicker from the image displayed (from 0 to 31).

Total dots

Use the Point ◀▶ buttons to adjust the number of total dots in one horizontal period to match your PC image.

Horizontal

Use the Point ◀▶ buttons to adjust the horizontal picture position.

Vertical

Use the Point ◀▶ buttons to adjust the vertical picture position.

Current mode

Press the SELECT button to show **H-sync freq.** and **V-sync freq.** of the connected computer.

Clamp

Use the Point ◀▶ buttons to adjust the clamp level. When the image has dark bars, try this adjustment.

Display area H

Use the Point ◀▶ buttons to adjust the horizontal area displayed by this projector.

Display area V

Use the Point ◀▶ buttons to adjust the vertical area displayed by this projector.

Reset

To reset the adjusted data, select **Reset** and press the SELECT button. A confirmation box appears and then select **Yes**. All adjustments will return to their previous figures.

Mode free

To clear the stored data, select **Mode free** and then press the Point ► or the SELECT button. Move the highlight to the Mode that you want to clear and then press the SELECT button.

Store

To store the adjusted data, select **Store** and then press the Point ► or the SELECT button. Move the highlight to one of the Modes 1 to 10 in which you want to store, and then press the SELECT button.

Mode free

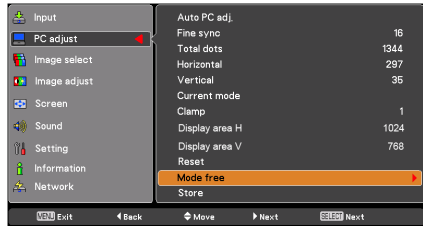

This Mode has stored parameters.

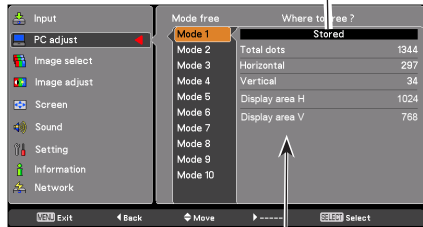

Values of **Total dots**, **Horizontal**, **Vertical**, **Display area H**, and **Display area V**.

Store

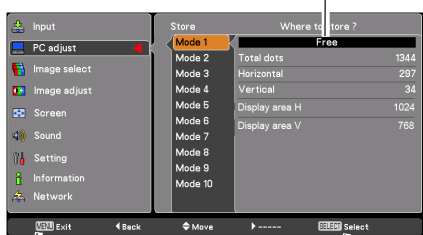

Press MENU button to close this dialog box.

Press SELECT button to store the data.

✓Note:

- **Display area (H/V)** cannot be selected when **480i**, **576i**, **480p**, **576p**, **720p**, **1035i** or **1080i** is selected in the PC System Menu (p.28).
- When input computer signal to the projector, **PC adjust** will become available.

Computer Input

Image Mode Selection

Direct Operation

Select the desired image mode among **Dynamic**, **Standard**, **Real**, **Cinema**, **Blackboard (Green)**, **Colorboard**, **Image 1**, **Image 2**, **Image 3** and **Image 4** by pressing the IMAGE button on the remote control.

Menu Operation

- 1 Press the MENU button to display the On-Screen Menu. Use the Point ▲▼ buttons to select **Image select** and then press the Point ► or the SELECT button.
- 2 Use the Point ▲▼ buttons to select the desired item and then press the SELECT button.

Remote Control

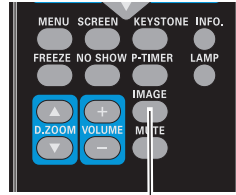
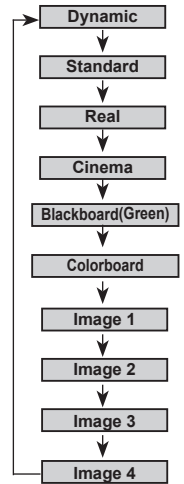

IMAGE button

IMAGE button



Dynamic

For viewing pictures in a bright room.

Standard

Normal picture mode preset on the projector.

Real

Picture mode with improved halftone for graphics.

Cinema

Picture mode adjusted with fine tone.

Blackboard (Green)

For the image projected on a blackboard.
This mode helps enhance the image projected on a blackboard. This is mainly effective on a green colored board, not truly effective on a black colored board.

Colorboard

At the time of simple projection on the colored wall, you can get the close color image to the color image projected on a white screen by selecting the similar color to the wall color from the preset four colors.

Image 1–4

For viewing with the user preset image mode in the Image Adjust Menu (see page 33).

Image select Menu

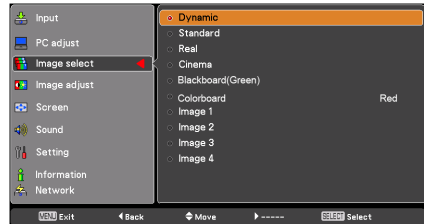
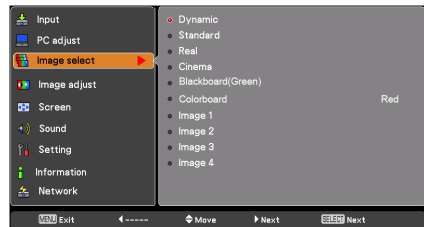

Image Adjustment

- 1 Press the MENU button to display the On-Screen Menu. Use the Point ▲▼ buttons to select **Image adjust** and then press the Point ► or the SELECT button.
- 2 Use the Point ▲▼ buttons select the desired item and then press the SELECT button to display the adjustment dialog box. Use the Point ◀▶ buttons to adjust the setting value.

Contrast

Press the Point ◀ button to decrease the contrast; press the Point ▶ button to increase the contrast (from 0 to 63).

Brightness

Press the Point ◀ button to decrease the brightness; press the Point ▶ button to increase the brightness (from 0 to 63).

Iris

Press the Point ◀▶ buttons to select **Off** or **On**.

Off Disabled.

On The iris function is activated.

Color temp.

Use the Point ◀▶ buttons to select the desired Color temp. level (**XLow**, **Low**, **Mid**, or **High**).

White balance (Red / Green / Blue)

Press the Point ◀ button to lighten R/G/B tone; press the Point ▶ button to deepen R/G/B tone (from 0 to 63).

Sharpness

Press the Point ◀ button to decrease the sharpness of the image; press the Point ▶ button to increase the sharpness of the image (from 0 to 15).

Gamma

Use the Point ◀▶ buttons to adjust the gamma value to obtain a better balance of contrast (from 0 to 15).

Reset

To reset the adjusted data, select **Reset** and press the SELECT button. A confirmation box appears and then select **Yes**. All adjustments will return to their previous figures.

Store

To store the adjusted data, select **Store** and press the Point ► or the SELECT button. Use the Point ▲▼ buttons to select one from Image 1 to 4 and press the SELECT button.

A confirmation box appears and then select **Yes**. Stored data can be called up by selecting an **Image (1-4)** in the Image Mode Selection on page 32.

Image Adjust Menu



Selected Image mode



Use the Point ◀▶ buttons to adjust the setting value.



Store



A confirmation box appears and then select **Yes**.

✓Note:

- When White balance **Red**, **Green** or **Blue** is adjusted, **Color temp.** will change to **User**.
- When **Blackboard(Green)** or **Colorboard** is selected in Image select, **Color temp.** will change to **Blackboard** or **Colorboard**.

Screen Size Adjustment

This projector has the picture screen resize function, which enables you to customize the image size.

- 1 Press the MENU button to display the On-Screen Menu. Use the Point ▲▼ buttons to select **Screen** and then press the Point ► or the SELECT button.
- 2 Use the Point ▲▼ buttons select the desired item and then press the SELECT button .

Normal

Provide the image to fit the screen size.

Full

Provide the full screen image.

Wide (16:9)

Provide the image at the 16:9 wide screen ratio.

Zoom

Scale the image proportionally to fit the entire screen. Either side of image may go over the screen.

True

Provide the image in its original size. When the original image size is larger or smaller than the screen size (1024 x 768), the projector enters to the panning mode automatically. Use the Point ▲▼◀▶ buttons to pan the image. When adjusted, the arrows will turn red. When reached to the correction limits, the arrows will disappear.

Custom

Provide the last stored aspect screen image.

Custom adj.

Adjust the screen scale and position manually with this function. Press the Point ► button at **Custom adj.** and the Custom adjustment menu is displayed on the screen, you can use the Point ▲▼ buttons to choose the item you want to adjust.

Scale H/V Adjust the Horizontal/Vertical screen scale.

H&V When set to **On**, the aspect ratio is fixed. The **Scale V** appears dimmed and becomes unavailable. Adjust **Scale H**, then the screen scale is automatically modified based on the aspect ratio.

Position H/V Adjust the Horizontal/Vertical screen position.

Common Save the adjusted scale or position to all the inputs. Press the SELECT button at **Common** to display a confirmation box. To save the scale or position, press the SELECT button at **Yes**. When **Custom** is selected, the saved scale or position is used.

Reset Reset the all adjusted values. Press the SELECT button at **Reset** to display a confirmation box. To reset, press the SELECT button at **Yes**.

Screen Menu

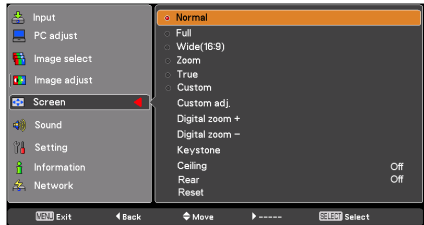
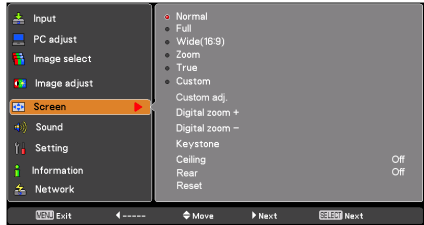

✓Note:

- This projector cannot display any resolution higher than 1920 x 1200. If your computer's screen resolution is higher than it, reset the resolution to the lower before connecting to the projector.
- The image data in other than 1024 x 768 is modified to fit the screen size in initial mode.
- **True** and **Digital zoom +/-** are disabled and cannot be displayed when **480i**, **576i**, **480p**, **576p**, **720p**, **1035i** or **1080i** is selected in the PC System Menu (p. 28).
- When **True** is selected in the Screen menu, **Digital zoom +/-** can not be selected.

Custom adj.

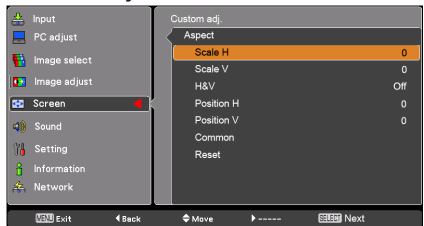

✓Note:

- When no signal is detected, **Normal** is set automatically .
- The adjustable range for **Scale H/V** and **Position H/V** is limited depending on the input signal.

Digital zoom +

Select **Digital zoom +**. The On-Screen Menu disappears and **D. zoom +** appears. Press the SELECT button to expand the image size. Use the Point **▲▼◀▶** buttons to pan the image. The Panning function can work only when the image is larger than the screen size. A projected image can be also expanded by pressing the **D.ZOOM ▲** or the SELECT button on the remote control.

Digital zoom -

Select **Digital zoom -**. The On-Screen Menu disappears and **D. zoom -** appears. Press the SELECT button to compress image size.

The projected image can be also compressed by pressing the **D.ZOOM ▼** or the SELECT button on the remote control.

To exit the Digital zoom +/- mode, press any button except the **D.ZOOM ▲▼** buttons, SELECT and Point buttons.

To return to the previous screen size, select a screen size from the Screen Size Adjustment Menu or select an input source from the Input Source Selection Menu (see page 27) again, or adjust the screen size with the **D.ZOOM ▲▼** buttons.

Keystone

This function is used to adjust keystone distortion of the projected image. Use the Point **▲▼** buttons to choose the item you want to adjust.

Keystone

To correct keystone distortion, press the SELECT button.

Keystone appears on the screen. Use the Point **▲▼** buttons to correct keystone distortion (p.23).

Store or Reset

To store or reset the keystone correction, press the Point **▶** button.

Store Keep the keystone correction even when the AC power cord is unplugged.

Reset Release the keystone correction when the AC power cord is unplugged.

Ceiling

When this function is set to **On**, the picture will be top/bottom and left/right reversed. This function is used to project the image from a ceiling-mounted projector.

Rear

When this function is set to **On**, the picture will be left/right reversed. This function is used to project the image from rear of the screen.

Reset

To reset the adjusted data, select Reset and press the SELECT button. A confirmation box appears and then select Yes. All adjustments will return to their previous figures.

Remote Control

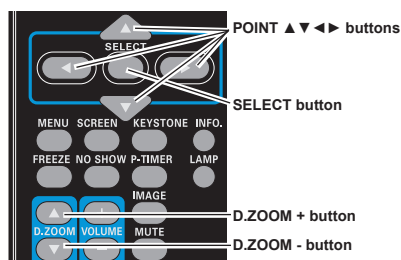

Keystone

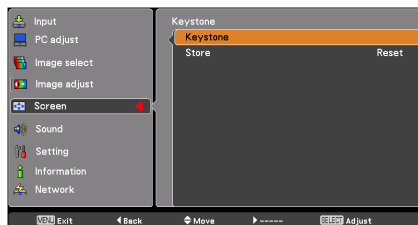

Ceiling

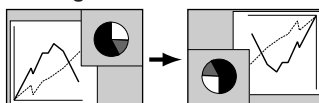

Rear

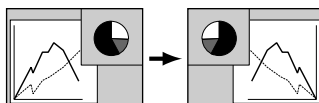

✓Note:

- The minimum compression ratio is limited depending on the input signal, when the Keystone function is working or when the custom is selected for the screen size.
- **True** and **Digital zoom +/-** are disabled and cannot be displayed when **480i**, **576i**, **480p**, **576p**, **720p**, **1035i** or **1080i** is selected in the PC System Menu (p.28).
- **Digital zoom +/-** cannot be selected when **True** is selected.
- The minimum compression ratio is limited at Normal screen size.

Video Input

Input Source Selection (Video, S-video)

Direct Operation

Choose **Video** or **S-video** by pressing the VIDEO or the S-VIDEO button on the remote control. Before using these buttons, correct input source should be selected through menu operation as described below.

Remote Control

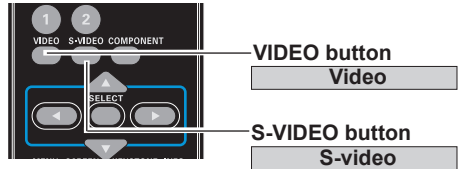

Menu Operation

- 1 Press the MENU button to display the On-Screen Menu. Use the Point ▲▼ buttons to select **Input** and then press the Point ► or the SELECT button.
- 2 Use the Point ▲▼ buttons to select **Video** and then press the SELECT button.

Video When video input signal is connected to the VIDEO jack, select **Video**.

Use the Point ▲▼ buttons to select **Computer 1**. And then press the Point ► button to access the submenu items. Use the Point ▲▼ buttons to select the **S-video** and then press the SELECT button.

S-video When the input source is coming from video equipment connected to the COMPUTER IN 1/S-VIDEO IN/COMPONENT IN terminal with a S-video-VGA cable, select **S-video**.

- ✓ **Note:** When the Input Search function is set to **On 1** or **On 2** in the Auto setup function, the input signal will be searched automatically (p.45).

Video

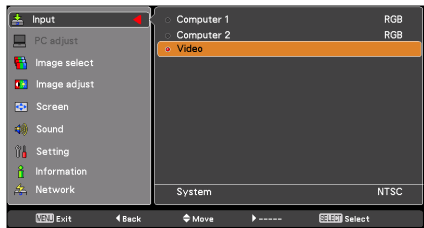

S-video

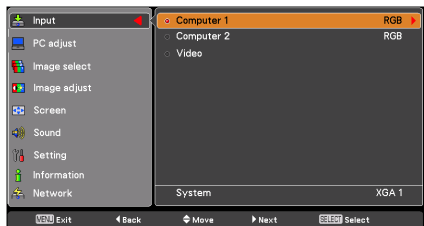

Press the Point ▲▼ buttons to select **S-video**.

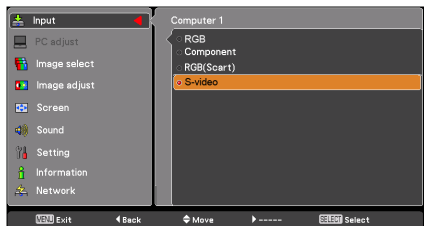

Input Source Selection (Component, RGB Scart 21-pin)

Direct Operation

Choose **Computer 1(Component)** or **Computer 1(Scart)** by pressing the COMPONENT or the COMPUTER 1 button on the remote control.

Before using these buttons, correct input source should be selected through Menu operation as described below.

Remote Control

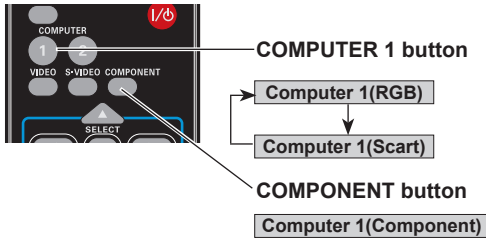

Menu Operation

- 1 Press the MENU button to display the On-Screen Menu. Use the Point ▲▼ buttons to select **Input** and then press the Point ► or the SELECT button.
- 2 Use the Point ▲▼ buttons to select **Computer 1** and then press the Point ► button.
- 3 Use the Point ▲▼ buttons to select **Component** or **RGB(Scart)** and then press the SELECT button.

Component When the input source is coming from video equipment connected to the COMPUTER IN 1/S-VIDEO IN/COMPONENT IN terminal with a Component-VGA Cable, select **Component**.

RGB (Scart) When the input source is coming from video equipment connected to the COMPUTER IN 1/S-VIDEO IN/COMPONENT IN terminal with a Scart-VGA Cable, select **RGB (Scart)**.

✓Note:

When the Input Search function is set to **On 1** or **On 2**, the input signal will be searched automatically (p.45).

Input Menu

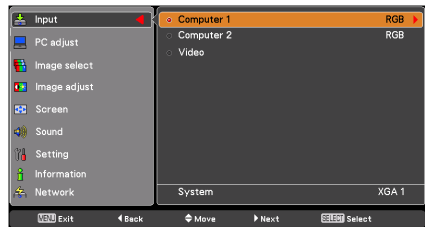
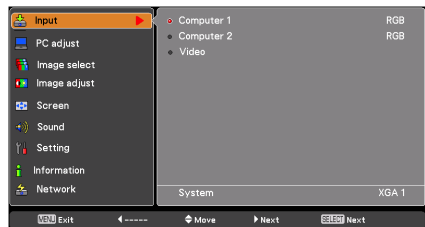

Press the Point ▲▼ buttons to select **Component** or **RGB(Scart)**.

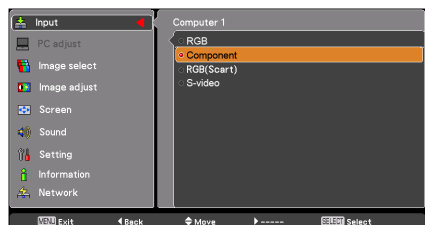

Video System Selection

- 1 Press the MENU button to display the On-Screen Menu. Use the Point ▲▼ buttons to select **Input** and then press the Point ► or the SELECT button.
- 2 Select **Video**, **Computer 1(S-video)** or **Computer 1(Component)** input source. (See pages 36-37)
- 3 Use the Point ▲▼ buttons to select **System** and then press the Point ► or the SELECT button. Use the Point ▲▼ buttons to select the desired system and then press the SELECT button.

AV System Menu (Video or S-video)

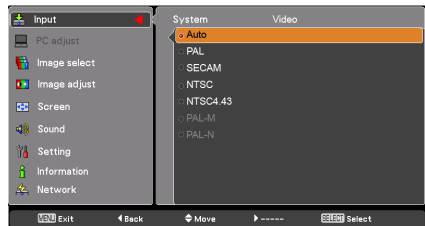
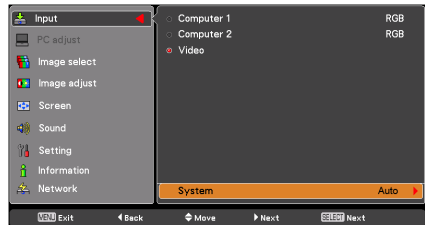

Video or S-video

Auto

The projector automatically detects an incoming video system, and adjusts itself to optimize its performance. When Video System is **PAL-M** or **PAL-N**, select the system manually.

PAL/SECAM/NTSC/NTSC4.43/PAL-M/PAL-N

If the projector cannot reproduce proper video image, select a specific broadcast signal format from among **PAL**, **SECAM**, **NTSC**, **NTSC 4.43**, **PAL-M** and **PAL-N**.

Component

Auto

The projector automatically detects an incoming video signal, and adjusts itself to optimize its performance.

COMPONENT VIDEO SIGNAL FORMAT

If the projector cannot reproduce proper video image, select a specific component video signal format from among **480i**, **576i**, **480p**, **576p**, **720p**, **1035i** and **1080i**.

AV System Menu (Component)

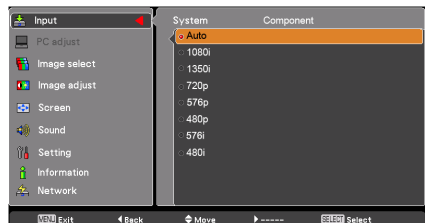
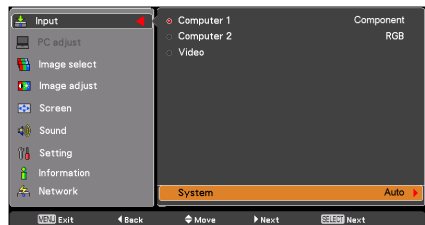

✓Note:

The AV System Menu cannot be selected when selecting **RGB (Scart)**.

Image Mode Selection

Direct Operation

Select the desired image mode among **Dynamic**, **Standard**, **Real**, **Cinema**, **Blackboard (Green)**, **Colorboard**, **Image 1**, **Image 2**, **Image 3** and **Image 4** by pressing the IMAGE button on the remote control.

Menu Operation

- 1 Press the MENU button to display the On-Screen Menu. Use the Point ▲▼ buttons to select **Image select** and then press the Point ► or the SELECT button.
- 2 Use the Point ▲▼ buttons to select the desired item and then press the SELECT button.

Remote Control

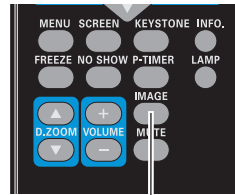
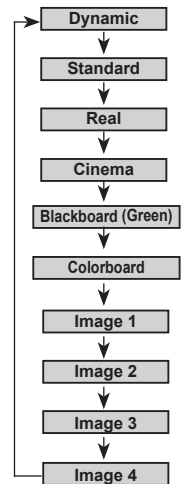

IMAGE button

IMAGE button



Dynamic

For viewing pictures in a bright room.

Standard

Normal picture mode preset on the projector.

Real

Picture mode with improved halftone for graphics.

Cinema

Picture mode adjusted with fine tone.

Blackboard (Green)

For the image projected on a blackboard.
This mode helps enhance the image projected on a blackboard. This is mainly effective on a green colored board, not truly effective on a black colored board.

Colorboard

At the time of simple projection on the colored wall, you can get the close color image to the color image projected on a white screen by selecting the similar color to the wall color from the preset four colors.

Image 1–4

For viewing with the user preset image mode in the Image Adjust Menu (see page 41).

Image select Menu

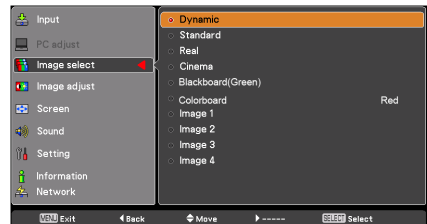
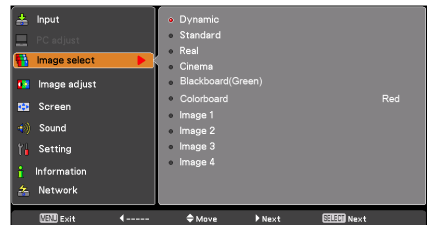

Image Adjustment

- 1 Press the MENU button to display the On-Screen Menu. Use the Point ▲▼ buttons to select **Image adjust** and then press the Point ► or the SELECT button.
- 2 Use the Point ▲▼ buttons select the desired item and then press the SELECT button to display the adjustment dialog box. Use the Point ◀▶ buttons to adjust the setting value.

Contrast

Press the Point ◀ button to decrease the contrast; press the Point ► button to increase the contrast (from 0 to 63).

Brightness

Press the Point ◀ button to decrease the brightness; press the Point ► button to increase the brightness (from 0 to 63).

Color

Press the Point ◀ button decrease the intensity of the color; press the Point ► button increase the intensity of the color (from 0 to 63).

Tint

Press the Point ◀▶ buttons to adjust the tint value to get a proper color balance (from 0 to 63).

Iris

Press the Point ◀▶ buttons to select **Off** or **On**.

Off Disabled.

On The iris function is activated.

Color temp.

Use the Point ◀▶ buttons to select the desired Color temp. level (**XLow**, **Low**, **Mid** or **High**).

White balance (Red / Green / Blue)

Press the Point ◀ button to lighten R/G/B tone; press the Point ► button to deepen R/G/B tone (from 0 to 63).

Sharpness

Press the Point ◀ button to decrease the sharpness of the image; press the Point ► button to increase the sharpness of the image (from 0 to 15).

Gamma

Use the Point ◀▶ buttons to adjust the gamma value to obtain a better balance of contrast (from 0 to 15).

Image Adjust Menu

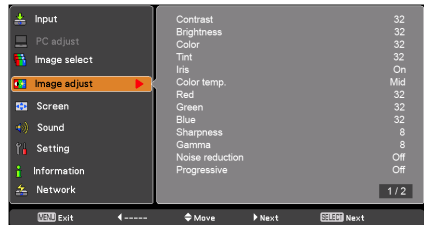

Selected Image mode

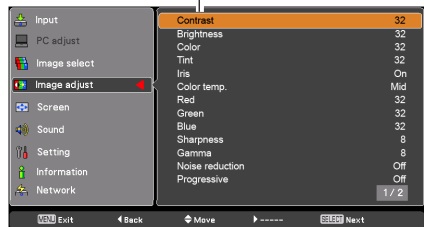

Use the Point ◀▶ buttons to adjust the setting value.



✓Note:

- When the **White balance Red**, **Green** or **Blue** is adjusted, the Color temp. level will change to **User**.
- Tint cannot be selected when the video system is **PAL**, **SECAM**, **PAL-M** or **PAL-N** (p. 38).
- When **Blackboard (Green)** or **Colorboard** is selected in Image select, **Color temp.** will change to **Blackboard** or **Colorboard**.

Noise reduction

Noise interference on the screen can be reduced. Select one of the following options to get smoother images.

- Off Disabled.
- L 1 Lower reduction
- L 2 Higher reduction

Progressive

An interlaced video signal can be displayed in progressive mode. Select one of the following options.

- Off Disabled.
- L 1 For an active picture.
- L 2 For a still picture.
- Film For watching a film. With this function, the projector reproduces pictures faithful to the original film quality.

Reset

To reset the adjusted data, select **Reset** and press the SELECT button. A confirmation box appears and then select **Yes**. All adjustments will return to their previous figures.

Store

To store the adjusted data, select **Store** and press the Point ► or the SELECT button. Use the Point ▲▼ buttons to select one from Image 1 to 4 and press the SELECT button.

A confirmation box appears and then select **Yes**. Stored data can be called up by selecting an **Image (1-4)** in the Image Mode Selection on page 39.

Store Menu

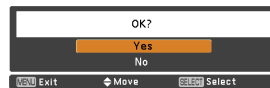

A confirmation box appears and then select **Yes**.

✓ Note:

Noise reduction and **Progressive** can not be selected when the input signal is **480p, 576p, 720p, 1035i or 1080i** (p.38).

Screen Size Adjustment

This projector has the picture screen resize function, which enables you to customize the image size.

- 1 Press the MENU button to display the On-Screen Menu. Use the Point ▲▼ buttons to select **Screen** and then press the Point ► or the SELECT button.
- 2 Use the Point ▲▼ buttons select the desired item and then press the SELECT button.

Normal

Provide the image to fit the screen size while maintaining the aspect ratio of the input signal.

Full

Provide the full screen image.

Wide (16:9)

Provide the image at the 16:9 wide screen ratio.

Zoom

Pan the horizontal direction of the image and cut the vertical direction of the image to fit the screen size (16:9). Only for 4:3 video aspect ratio signals.

Custom

Provide the last stored aspect screen image.

Custom adj.

Adjust the screen scale and position manually with this function.

Press the Point ► button at **Custom adj.** and the Custom adjustment menu is displayed on the screen, you can use the Point ▲▼ buttons to choose the item you want to adjust.

Scale H/V Adjust the Horizontal/Vertical screen scale.

H&V When set to **On**, the aspect ratio is fixed. The **Scale V** appears dimmed and becomes unavailable. Adjust **Scale H**, then the screen scale is automatically modified based on the aspect ratio.

Position H/V Adjust the Horizontal/Vertical screen position.

Common Save the adjusted scale or position to all the inputs. Press the SELECT button at **Common** to display a confirmation box. To save the scale or position, press the SELECT button at **Yes**. When **Custom** is selected, the saved scale or position is used.

Reset Reset the all adjusted values. Press the SELECT button at **Reset** to display a confirmation box. To reset, press the SELECT button at **Yes**.

Screen Menu

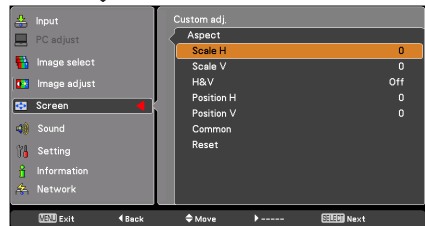
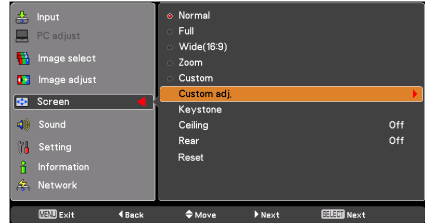

- ✓ **Note:**
- When no signal is detected, **Normal** is set automatically and the Aspect adjustment menu disappears.
 - The adjustable range for **Scale H/V** and **Position H/V** is limited depending on the input signal.

Keystone

This function is used to adjust keystone distortion of the projected image. Use the Point ▲▼ buttons to choose the item you want to adjust.

Keystone

To correct keystone distortion, press the SELECT button.

Keystone appears on the screen. Use the Point ▲▼ buttons to correct keystone distortion (p. 23).

Store or Reset

To store or reset the keystone correction, press the Point ► button.

Store Keep the keystone correction even when the AC power cord is unplugged.

Reset Release the keystone correction when the AC power cord is unplugged.

Keystone



Ceiling

When this function is set to **On**, the picture will be top/bottom and left/right reversed. This function is used to project the image from a ceiling-mounted projector.

Ceiling

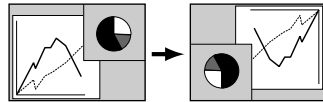

Rear

When this function is set to **On**, the picture will be left/right reversed. This function is used to project the image from rear of the screen.

Rear

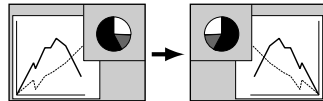

Reset

To reset the adjusted data, select Reset and press the SELECT button. A confirmation box appears and then select Yes. All adjustments will return to their previous figures.

Setting

Setting

This projector has a Setting menu that allows you to set up the other various functions described below.

- 1 Press the MENU button to display the On-Screen Menu. Press the Point ▲▼ buttons to select **Setting** and press the Point ► or the SELECT button to access the submenu items.
- 2 Use the Point ▲▼ buttons to select the desired item and then press the Point ► or the SELECT button to access the selected item.
- 3 Use the Point ▲▼ buttons select the desired item and then press the SELECT button.

Setting Menu



Language

The language used in the On-Screen Menu is available in English, German, French, Italian, Spanish, Portuguese, Dutch, Swedish, Finnish, Polish, Hungarian, Romanian, Russian, Turkish, Kazakh, Vietnamese, Chinese, Korean, Japanese and Thai.

Language

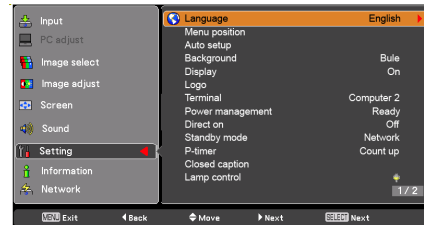

Menu position

This function is used to change the position of the On-Screen Menu. Select **Menu position** and press the SELECT button.

The Menu position changes each time you press SELECT button as follows.
the center → the bottom left → the bottom right → the top left → the top right→.....

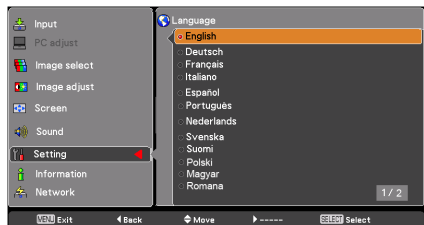

Auto setup

This function enables Input search, Auto Keystone correction and Auto PC adjustment by pressing the AUTO SETUP button on the top control or the AUTO SET button on the remote control. Settings for those functions can be altered as follows:

Input search

This function detects the input signal automatically. When a signal is found, the search will stop. Use the Point ▲ ▼ buttons to select one of the following options.

- Off** Input search does not work.
- On 1** Input search works under the following situation.
 - When pressing the AUTO SETUP button on the top control.
 - When pressing the AUTO SET button on the remote control.
- On 2** Input search works under the following situation.
 - When turning on the projector by pressing the ON/STAND-BY button on the top control or the remote control.
 - When pressing the AUTO SET button on the remote control.
 - When pressing the AUTO SETUP button on the top control.
 - When the current input signal is cut off.*

* If the No show or Freeze function is active, cancel it to activate the Input search. It is also unavailable when On-Screen menu is displayed.

Auto PC adj.

- On** Enables Auto PC Adjustment when pressing the AUTO SET button on the remote control or the AUTO SETUP button on the top control.
- Off** Disables Auto PC Adjustment.

Auto Keystone

- Auto** Always works and corrects keystone distortion according to the projector's tilt.
- Manual** Works only when pressing the AUTO SETUP button on the top control or the AUTO SET button on the remote control.
- Off** Disables Auto Keystone.

✓ Note:

- While **Input search** is set to **On 1** or **On 2**, the status of Input and Lamp are displayed every time the signal is switched.
- Only the last selected input source can be detected.

Auto setup

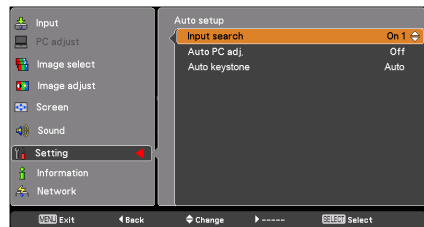
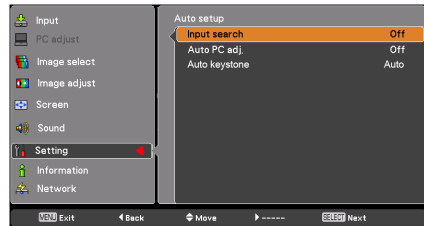
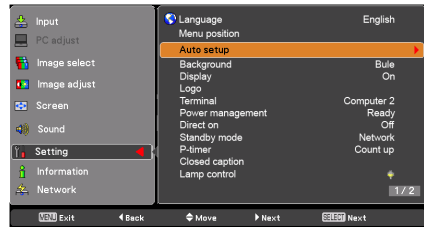

✓ Note:

- During **Input search** is in progress, If the MENU button or the ON/STAND-BY button is pressed, **Input search** will stop. If the COMPUTER 1/2 button or VIDEO or COMPONENT or S-VIDEO button is pressed, **Input search** will stop and go back to the button's input signal.
- **Input search**, **Auto PC adj.** and **Auto Keystone** can not be set **Off** at the same time.
- **Auto Keystone** corrects vertical distortion only, not correct horizontal distortion.
- The Auto Keystone function can not work when the Ceiling feature is set **On** in the Screen menu (pp. 35, 43).
- Perfect correction of the image distortion can not be ensured with the Auto setup function. If the distortion is not corrected properly by pressing the AUTO SETUP or the AUTO SET button, adjust manually by pressing the KEYSTONE button on the remote control or selecting **Keystone** in the Setting menu (pp. 23, 35, 43).
- **Fine sync**, **Total dots**, **Horizontal** and **Vertical** position of some computers cannot be fully adjusted with the Auto PC Adjustment function. When the image is not provided properly with this operation, manual adjustments are required (pp. 30-31).

Setting

Background

Select the background screen for when no input signal is detected. Press the Point ▲▼ buttons to switch between each option.

- Blue**..... Project a blue background.
- User**..... Project an image captured in the Logo setting.
- Black**..... Project a black background.

Display

This function decides whether to display On-Screen Displays.

- On**..... Show all the On-Screen displays. Use this function when you want to project images after the lamp becomes bright enough. The factory default setting is in this option.
- Off** Hide the On-Screen Displays except;
 - On-Screen Menu.
 - **Power off?** (p. 20)
 - P-Timer display. (p. 26)
 - **No signal** for Power management (p. 49)
 - **Please wait ...**
 - Arrows for the True function in the Screen Menu. (p. 34)

Logo select

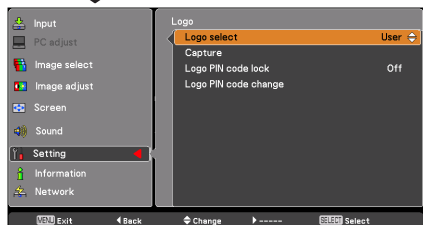
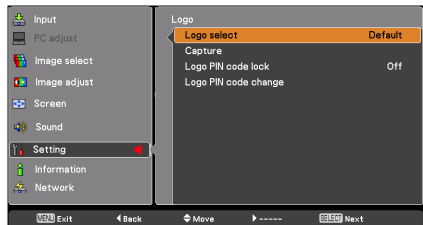
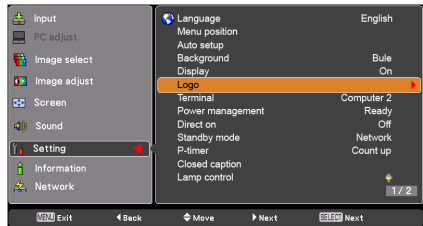

Logo (Logo and Logo PIN code lock settings)

This function allows you to customize the screen logo with **Logo select**, **Capture**, **Logo PIN code lock** and **Logo PIN code change** functions.

- ✓ **Note:** When **On** is selected in the Logo PIN code lock function, **Logo select** and **Capture** functions cannot be selected.

Logo select

This function decides on the starting-up display from among following options.

- User**..... Show the image you captured.
- Default** Show the factory-set logo.
- Off** Nothing is shown on the screen.

Capture

This function enables you to capture an image being projected to use it for a starting-up display or interval of presentations.

Select **Capture** and press the SELECT button. A confirmation box appears and select **Yes** to capture the projected image.

After capturing the projected image, go to the Logo select function and set it to **User**. Then the captured image will be displayed the next time you turn on the projector or when you press the NO SHOW button. (see page 26)

To cancel the capture function, select **Yes** in the "Quit?" confirmation box.

✓Note:

- Before capturing an image, select **Standard** in the Image select Menu to capture a proper image (pp. 32, 39).
- A signal from a computer can be captured up to XGA (1024 x 768). A signal from video equipment can be captured except for **720p**, **1035i**, and **1080i**.
- When capturing the image that has been adjusted by the Keystone function, the adjusted data is automatically reset and the projector captures an image without keystone correction.
- When Logo PIN code lock function is set to **On**, **Logo select** and **Capture** can not be selected.
- When starting to capture a new image, the previously stored image is cleared even if you cancel the capturing.
- When there is no captured image or it is interrupted while capturing an image, **User** can not be selected, you can only switch between **Default** and **Off**.

Logo PIN code lock

This function prevents an unauthorized person from changing the screen logo.

- Off** The screen logo can be changed freely from the Logo Menu (p. 46).
- On**..... The screen logo cannot be changed without a Logo PIN code.

If you want to change the **Logo PIN code lock** setting, press the SELECT button and the Logo PIN code dialog box appears. Enter a Logo PIN code by following the steps below. The initial **Logo PIN code** is set to "4321" at the factory.

Capture

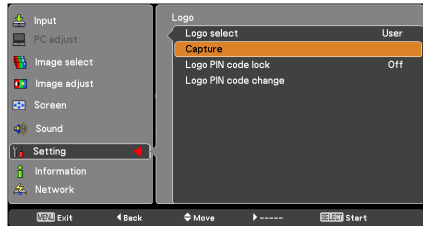

Logo PIN code lock

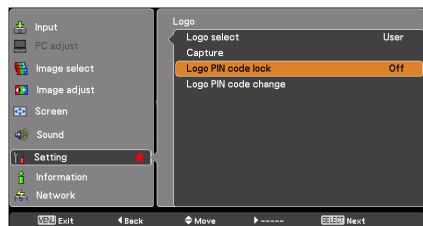

Enter a Logo PIN code

Use the Point ▲ ▼ buttons to enter a number. Press the Point ◀ ▶ buttons to fix the number and move the red frame pointer to the next box. The number changes to *. If you fixed an incorrect number, use the Point ◀ ▶ buttons to move the pointer to the number you want to correct, and then enter the correct number.

Repeat this step to complete entering a four-digit number.

After entering the four-digit number, move the pointer to **Set**. Press the SELECT button so that you can start to operate the projector.

If you entered an incorrect Logo PIN code, **Logo PIN code** and the number (****) will turn red for a moment. Enter the correct Logo PIN code all over again.

Change the Logo PIN code lock setting

Use the Point ▲ ▼ buttons to switch **On** or **Off**, and then press the SELECT button to make a choice.

Logo PIN code change

Logo PIN code can be changed to your desired four-digit number. Press the SELECT button to select **Logo PIN code change**. **Current logo PIN code** dialog box appears, use the Point ▲ ▼ buttons to enter the correct code. The New Logo PIN code input dialog box appears. Set a new Logo PIN code, confirmation box appears, choose **Yes** to set the new Logo PIN code.

Be sure to note the new Logo PIN code and keep it on hand. If you lost the number, you could no longer change the Logo PIN code setting.

Enter a Logo PIN code

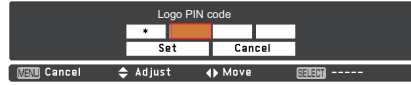

After a correct Logo PIN code is entered, the following dialog box appears.

Change the Logo PIN code lock setting

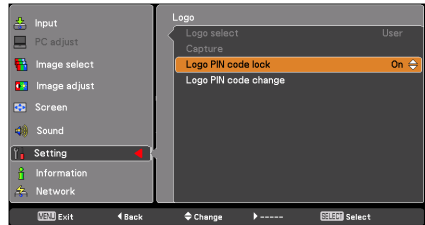

Change the Logo PIN code

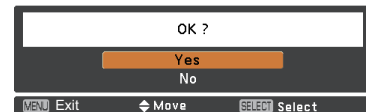
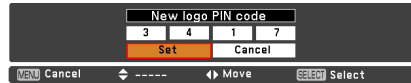
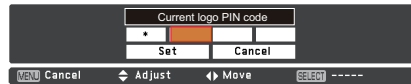
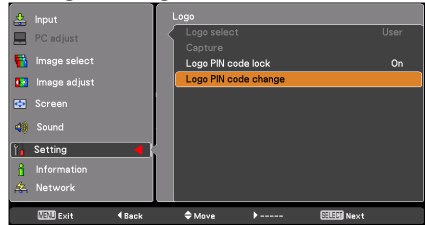

Terminal

The COMPUTER IN 2/MONITOR OUT terminal on the back of the projector is switchable for computer input or monitor output. (See page 9) Select **Computer 2** or **Monitor Out** with the Point ▲▼ buttons.

Computer 2 . . . computer input
Monitor Out . . . monitor out

Terminal function is not available when selecting **Computer 2** to the input source. Change the input source to the others (**Computer 1**, and so on) so that the Terminal function will be available. (pp.25, 36, 37)

Power management

For reducing power consumption as well as maintaining the lamp life, the Power management function turns off the projection lamp when the projector is not operated for a certain period.

Select one of the following options:

- Ready**..... When the lamp has been fully cooled down, the POWER indicator changes to green blinking. In this condition, the projection lamp will be turned on if the input signal is reconnected or any button on the top control or remote control is pressed.
- Shut down**..... When the lamp has been fully cooled down, the power will be turned off.
- Off**..... Power management function is off.
- Timer**..... If the input signal is interrupted and no button is pressed for more than 30 seconds, the timer display with **No signal** appears. It starts the countdown until the lamp is turned off. Use the Point ▲▼ buttons to set the Timer (1~30 min).

✓**Note:**
 Factory default is **Ready: 5 min.**

Direct on

When this function is set to **On**, the projector will be automatically turned on just by connecting the AC power cord to a wall outlet.

✓**Note:**
 Be sure to turn off the projector properly (see "Turning Off the Projector" on page 20). If the projector is turned off in the incorrect sequence, the Direct on function will not work properly.

Power management



Time left before Lamp is off.

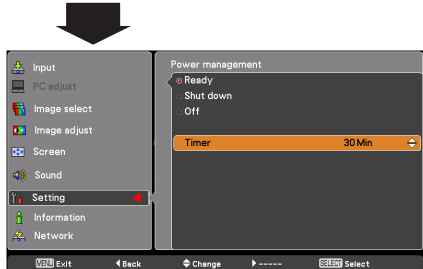
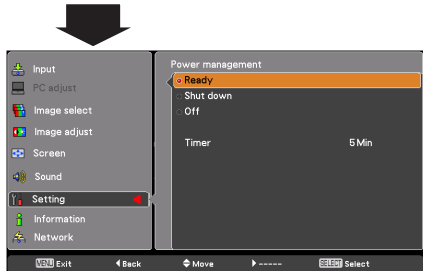
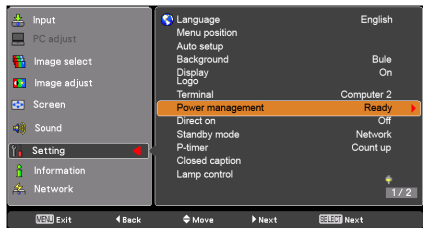

Setting

Standby mode

This function is available when operating the projector via network.

Network Supply the power to the network function even after turning off the projector by pressing the ON/STAND-BY button on the remote control. You can turn on/off the projector via network, modify network environment, and receive an e-mail about projector status while the projector is powered off.

Eco Select **Eco** when you do not use the projector via network. The projector's network function will stop when turning off the projector, you can not turn on the projector via network.

Refer to the User Guide of "Network Set-up and Operation".

✓Note:

- When selecting **Network**, the cooling fans may be running depending on the temperature inside the projector even if the projector is turned off.
- When **Eco** mode is selected and the projector is in Stand-by, the communication of RS-232C serial port is not available.

P-timer

This function allows you to change the setting of the P-timer and execute it.

Select one of the following options:

Count up..... The P-timer display **000:00** appears on the screen and the count starts (**000:00-180:00**)

Count down..... The time set in the Timer setting appears on the screen and the countdown starts.

Timer..... Use the Point **▲▼** buttons to set the Timer (**1-180 Min**). **Timer** is available in Count down only. Factory default value is **10 Min**.

Start It executes the count up or count down function. Press the **SELECT** button at **Start** and the indication changes into **Stop**. To stop **Count up** or **Count down**, press the **SELECT** button at **Stop** on the screen menu, then the indication changes into **Restart**. Press the **SELECT** button at **Restart** to resume **Count up** or **Count down**.

Reset..... Reset the P-timer values. Press the **SELECT** button at **Reset** to return to the following value;
Count up ... "000:00"
Count down ... Timer that you set

Exit..... To exit the P-timer operation.

X: disabled O: enabled

	Eco	Network
Serial command	x	O
Network	x	O
Monitor Out	x	O
Audio Out	x	x *1
Direct on	O	O

*1 When switch the Standby MIC out function **On** and in Standby mode status, only MIC volume can be output.

P-TIMER



P-timer display

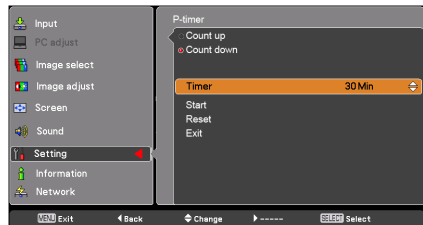
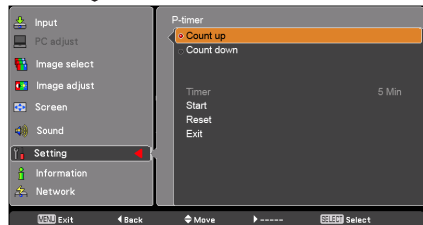
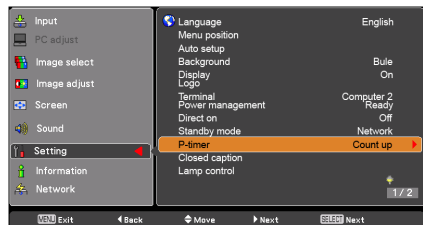

Stop or Cancel the P-timer via Remote Control

To stop the P-timer function, press the P-TIMER button. To cancel the P-timer, press and hold the P-TIMER button for a few seconds.

Closed Caption

Closed Caption is a printed version of the program sound or other information displayed on the screen. If the input signal contains closed captions, you can turn on the feature and switch the channels. Press the Point ▲▼ buttons to select **Off**, **CC1**, **CC2**, **CC3** or **CC4**. If the closed caption is not clear, you can change the text from **Color** to **White**.

✓Note:

The Closed Caption is available only under the situation below.

- When the input signal is **Component** (for adjustment only), **Video** or **S-video**, and the system is set to **Auto**, **NTSC** or **480i**, the Closed caption is available.
- If the system is set to **Auto**, and choose **NTSC** or **480i** as the input signal, the Closed caption function will be available.
- **Closed caption** will be unavailable when under other setting conditions.
- The Closed caption function is unavailable when On-Screen menu and P-timer are displayed.
- The item of Closed Caption is displayed in gray while it is not available.

Closed Caption

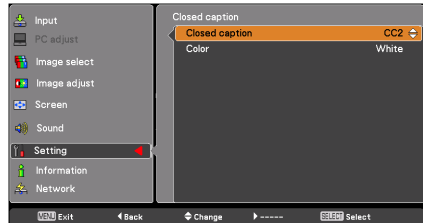
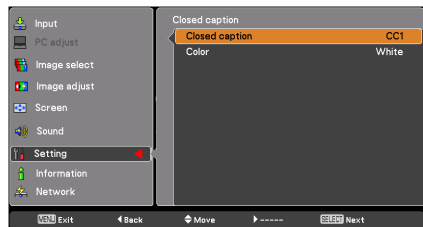
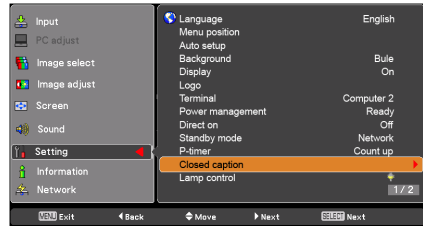

Press the Point ▲▼ buttons to select **Off**, **CC1**, **CC2**, **CC3** or **CC4**, and then press the SELECT button.

Setting

Lamp control

This function allows you to change brightness of the screen.

- High..... Brighter than the Normal mode.
- Normal..... Normal brightness
- Eco Lower brightness reduces the lamp power consumption and extends the lamp life.

✓Note:

Lamp mode can not be changed for a while after turning on the projector. Lamp needs some time to stabilize after the power is turned on. Stored lamp mode will be active after the lamp is stabilized.

Remote control

This projector provides two different remote control codes: the factory-set initial code (**Code 1**) and the secondary code (**Code 2**). This switching function prevents remote control interference when operating several projectors or video equipment at the same time. When operating the projector in **Code 2**, both the projector and the remote control must be switched to **Code 2**.

To change the code for the projector:

Select either **Code 1** or **Code 2** in this Setting Menu.

To change the code for the remote control:

Press and hold both the MENU and IMAGE buttons together for 5 seconds or more. After changing the code, make sure the remote control operates properly.

✓Note:

- When different codes are set on the projector and on the remote control, any operation cannot be made. In that case, switch the code on the remote control to fit the code on the projector.
- If the batteries are removed from the remote control for a long period of time, the remote control code will be reset.

Remote control

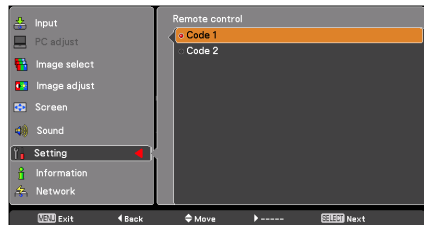



Security (Key lock and PIN code lock)

This function allows you to use the Key lock and PIN code lock function to set the security for the projector operation.

Key lock

This function locks the top control and remote control buttons to prevent operation by unauthorized persons. Select **Key lock** and then press the SELECT button, and select the desired item by pressing the Point ▲▼ buttons.

..... Unlocked.

..... Lock the operation of the top control. To unlock, use the remote control.

..... Lock the operation of the remote control. To unlock, use the top control.

If the top control accidentally becomes locked and you do not have the remote control nearby or there is something wrong with your remote control, contact the dealer where you purchased the projector or the service center.

Key lock

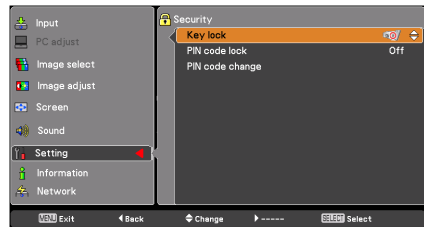
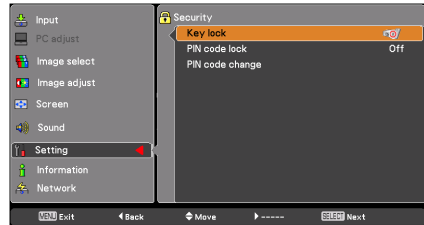

PIN code lock

This function prevents the projector from being operated by unauthorized persons and provides the following setting options for security.

Off Unlocked.

On 1 Enter the PIN code every time turning on the projector.

On 2 Enter the PIN code to operate the projector once the power cord is disconnected; as long as the AC power cord is connected, the projector can be operated without a PIN code.

Whenever you change the PIN code lock setting or the PIN code (the four-digit number), you are required to enter the PIN code. The "1234" is set as the initial PIN code at the factory.

If you want to change the PIN code lock setting, press the SELECT button and the PIN code dialog box appears.

When the projector is locked with the PIN code, the Security icon appears on the guide.

PIN code lock

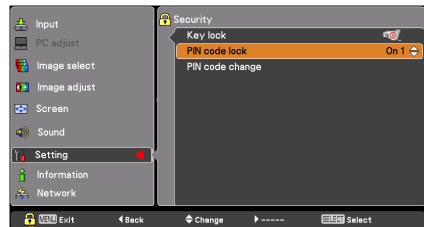

When the projector is locked with the PIN code, the Security icon appears on the guide.

Setting

Enter a PIN code

Use the Point ▲▼ buttons to enter a number. Press the Point ◀▶ buttons to fix the number and move the red frame pointer to the next box. The number changes to *. If you fixed an incorrect number, use the Point ◀▶ buttons to move the pointer to the number you want to correct, and then enter the correct number.

Repeat this step to complete entering a four-digit number.

After entering the four-digit number, move the pointer to **Set**. Press the SELECT button so that you can change the following PIN code lock setting.

If you entered an incorrect PIN code, **PIN code** and the number (****) will turn red for a moment. Enter the correct PIN code all over again.

Enter a PIN code

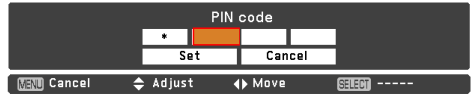

Change the PIN code

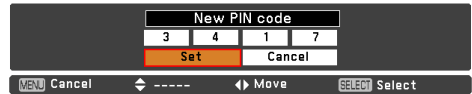
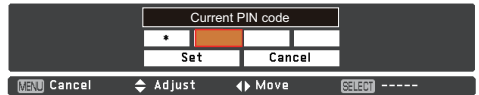

Change the PIN code lock setting

Use the Point ▲▼ buttons to select **Off**, **On 1** or **On 2**, and then press the SELECT button to make a choice.

Change the PIN code

The PIN code can be changed to your desired four-digit number. Press the SELECT button to select **PIN code change**. Pin code dialog box appears, use the Point ▲▼ buttons to enter the correct code. The New PIN code input dialog box appears. Set a new PIN code.

Fan

This function provides the following options in the cooling fans' operation when the projector is turned off (p.20).

- L 1 The cooling fans rotate for about 60 seconds.
- L 2 The cooling fans stop.

Fan control

Choose the running speed of cooling fans from the following options according to the ground elevation under which you use the projector.

- Off**..... Normal speed. Set this function to **Off** when using the projector in non-high altitude environment.
- On 1**..... Faster than Off mode. Select this mode when using the projector in high altitudes (about 1,000 meters to 2,000 meters above the sea level) where the fans have less cooling effect.
- On 2**..... Faster than **On 1** mode. Select this mode when using the projector in higher altitudes (about 2,000 meters to 3,000 meters above the sea level) where the fans have lesser cooling effect.

- ✓**Note:**
The fan noise becomes louder in **On 1** and **On 2**.

Video delay control

When you want to make a digital processing of a projected image faster, set this function. Use the Point ▲▼ buttons, select an item of **Off** or **On**.

- ✓**Note:**
Noise reduction and **Progressive** can not be selected when Video delay control function is set to **On**.

Lamp counter

Be sure to reset the Lamp replacement counter after the lamp is replaced. (p. 62)

Press the Point ▲▼ buttons to choose the Lamp counter function and then press the Point ► or the SELECT button to access the submenu items.

Lamp counter..... This item shows the total accumulated time of the lamp usage.

Lamp counter reset...Press the SELECT button to choose **Lamp counter reset**. Select **Yes** in the confirmation box if you want to reset the lamp counter, and then choose **Yes** in the second confirmation box to reset lamp counter.

- ✓**Note:**
When **L2** is selected in Fan menu and the projector is turned on right after it turns off, it takes a while to start projecting.

Lamp counter reset

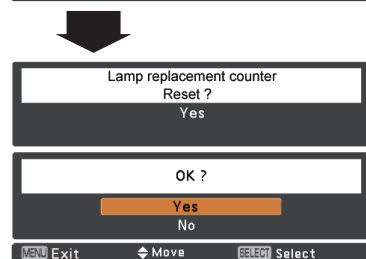
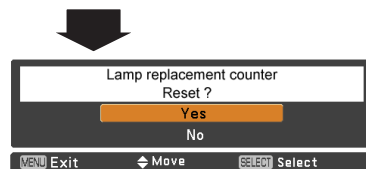
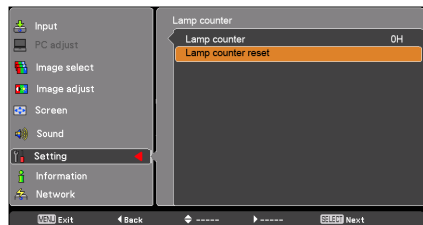

Setting

Filter counter

This function is used to set a frequency for the filter cleaning.

Use the Point ▲▼ buttons to select Filter counter and then press the Point ► or the SELECT button to access the submenu items.

Filter counter.....Show the total accumulated time of the filter use timer setting.

Timer..... To set a timer, when the projector reaches the time, the Filter warning icon (Fig.1) appears on the screen and the total accumulated time turns red, indicating that the filter replacement is necessary.

Filter counter reset... After replacing the filter, be sure to reset the timer. The Filter warning icon will not turn off until the filter counter is reset.

For details about resetting the timer, refer to "Resetting the Filter Counter" on page 59.

Fig.1 Filter warning icon



Filter warning icon appears on the screen at a set time (Off/2000H/3000H/4000H).

✓ **Note:**

- This icon also appears at turning on.
- The Filter warning icon (Fig.1) will not appear when the Display function is set to **Off** (p.46), during **Freeze** (p.25), or **No show** (p.26).

Warning log

This function records anomalous operations while the projector is in operation and use it when diagnosing faults. Up to 10 warning logs are displayed with the latest warning message at the top of the list, followed by previous warning messages in chronological order.

✓ **Note:**

When the Factory default function is executed, all the warning log records will be deleted.

Factory default

This function returns all setting values except for the **User logo**, **PIN code lock**, **Logo PIN code lock**, **Lamp counter** and **Filter counter** to the factory default settings.

Filter counter

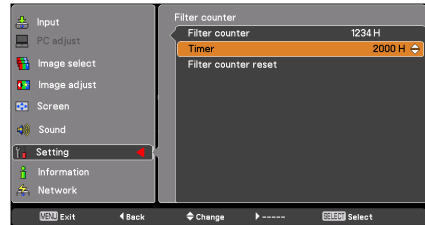

Press the SELECT button to select **Timer**, and then use the Point ▲▼ buttons to set the timer. Select from (Off/2000H/3000H/4000H) depending on the use environment.

Factory default

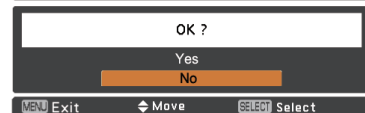
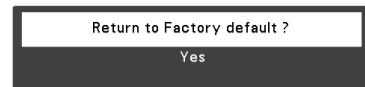
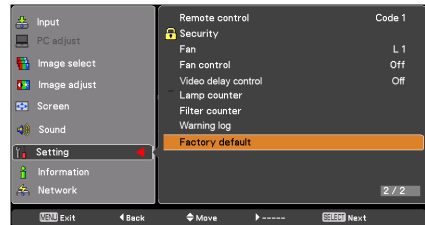

Information

Input Source Information Display

The Information Menu is used for checking the status of the image signal being projected and the operation of the projector.

Direct Operation

Press the INFO. button on the remote control to display the Information Menu.

Menu Operation

Press the Point ▲ ▼ buttons to select the Information. The Information Menu is displayed.

See below for displayed information.

Input

The selected input source is displayed.

H-sync freq.

The horizontal frequency of the input signal is displayed in **KHz**, or **----** **KHz** when no signal.

V-sync freq.

The vertical frequency of the input signal is displayed in **Hz**, or **----** **Hz** when no signal. Numbers of Hz doubles when during Interlace.

Screen

The selected screen size is displayed.

Language

The selected language is displayed.

Lamp status

The selected lamp mode is displayed.

Lamp counter

The cumulative lamp operating time is displayed.

Power management

Off, **Ready** or **Shut down**, and **Timer** are displayed.

Key lock

The selected Key lock icon is displayed.

PIN code lock

Off or **On1** or **On2** is displayed.

Remote control

The selected remote code is displayed.

Remote Control

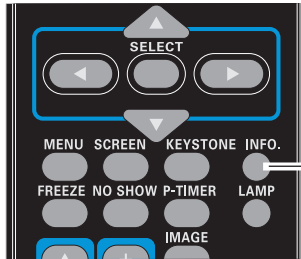

INFO. button

Information Menu

Input	Computer 1	RGB
H-sync freq.	43.4	KHz
V-sync freq.	60.0	Hz
Screen	Normal	
Language	English	
Lamp status		▼
Lamp counter	32	H
Power management	Ready	30 Min
Key lock		🔒
PIN code lock	On1	
Remote control	Code 1	

Maintenance and Cleaning

WARNING indicator

The WARNING indicator shows the state of the function which protects the projector. Check the state of the WARNING indicator and the POWER indicator to take proper maintenance.

The projector is shut down and the WARNING indicator is blinking red.

When the temperature inside the projector reaches a certain level, the projector will be automatically shut down to protect the inside of the projector. The POWER indicator is blinking while the projector is being cooled down. When the projector has cooled down enough (to its normal operating temperature), it can be turned on again by pressing the ON/STAND-BY button.

✓ **Note:**

The WARNING indicator continues to blink even after the temperature inside the projector returns to normal. When the projector is turned on again, the WARNING indicator stops blinking.

Top Control

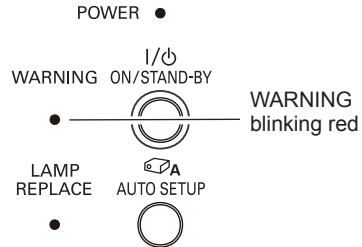

Then check the matters below:

- Did you provide appropriate space for the projector to be ventilated? Check the installing condition to see if the air vents of the projector are not blocked.
- Has the projector been installed near an Air-Conditioning/ Heating Duct or Vent? Move the installation of the projector away from the duct or vent.
- Is the filter clean? Clean the filter periodically.

The projector is shut down and the WARNING indicator lights red.

When the projector detects an abnormal condition, it is automatically shut down to protect the inside of the projector and the WARNING indicator lights red. In this case, unplug the AC power cord and reconnect it, and then turn the projector on once again to verify operation. If the projector cannot be turned on and the WARNING indicator still lights red, unplug the AC power cord and contact the service center.

Top Control

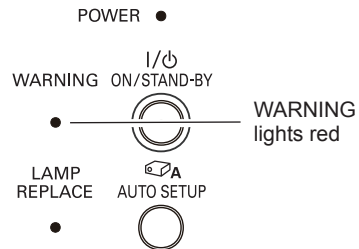

CAUTION

DO NOT LEAVE THE PROJECTOR WITH THE AC POWER CORD CONNECTED UNDER AN ABNORMAL CONDITION. IT MAY RESULT IN FIRE OR ELECTRIC SHOCK.

Replacing the Filter

Filter prevents dust from accumulating on the optical elements inside the projector. Should the Filter become clogged with dust particles, it will reduce cooling fans' effectiveness and may result in internal heat buildup and adversely affect the life of the projector. If a "Filter warning" icon appears on the screen, replace the Filter immediately. Replace the filter by following the steps below.

- 1 Turn off the projector, and unplug the AC power cord from the AC outlet.
- 2 Place the latch in the OPEN position and pull out the filter in the arrow direction.
- 3 Slide the new filter (along the guide rails). Make sure that the filter is inserted completely.) Place the latch back in the LOCK position.
- 4 Connect the AC power cord to the projector and turn on the projector.
- 5 Reset the filter counter.



CAUTION

- Do not operate the projector with the filter removed. Dust may accumulate on the optical elements degrading picture quality.
- Do not put anything into the air vents. Doing so may result in malfunction of the projector.
- Do not wash the filter with water or any other liquid Matter. Otherwise the filter may be damaged.

RECOMMENDATION

We recommend avoiding dusty/smoky environments when you operate the projector. Usage in these environments may cause poor image quality.

When using the projector under dusty or smoky conditions, dust may accumulate on a lens, LCD panels, or optical elements inside the projector degrading the quality of a projected image. When the symptoms above are noticed, contact your authorized dealer or service center for proper cleaning.

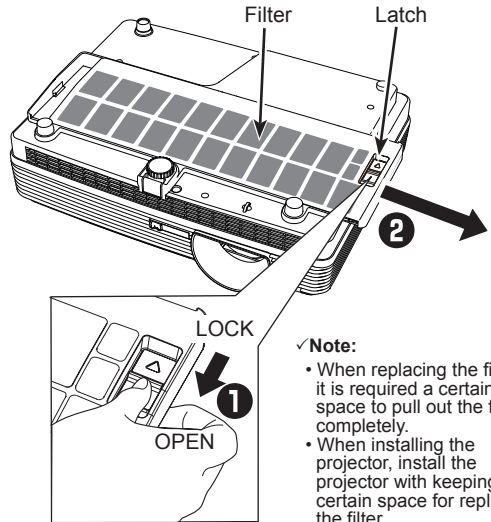

✓Note:

- When replacing the filter, it is required a certain space to pull out the filter completely.
- When installing the projector, install the projector with keeping a certain space for replacing the filter.

Resetting the Filter Counter

Be sure to reset the Filter counter after cleaning or replacing the filter.

- 1 Press the MENU button to display the On-Screen Menu. Use the Point ▲▼ buttons to select Setting and then press the Point ► or the SELECT button.
- 2 Use the Point ▲▼ buttons to select **Filter counter** and then press the Point ► or the SELECT button. Use the Point ▲▼ buttons to select **Filter counter reset** and then press the SELECT button. **Filter counter Reset?** appears. Select **Yes** to continue.
- 3 Another confirmation dialog box appears, select **Yes** to reset the Filter counter.

Filter counter reset

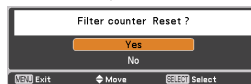
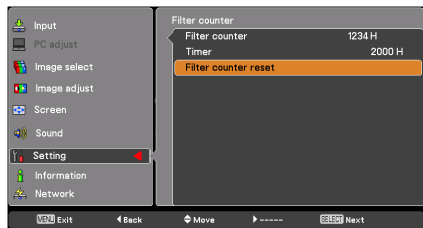

Filter counter Reset? appears.



Select **Yes**, then another confirmation box appears.

Select **Yes** again to reset the Filter counter.

Maintenance and Cleaning

Attaching the Lens Cap

When moving this projector or while not using it over an extended period of time, replace the lens cap.

Attach the lens cap according to the following procedures.

- 1 Thread the string through the hole on the lens cap and then tie a knot in the string to secure it in place.
- 2 To pass the other end of the string into the hole on the bottom of the projector and pull at it.

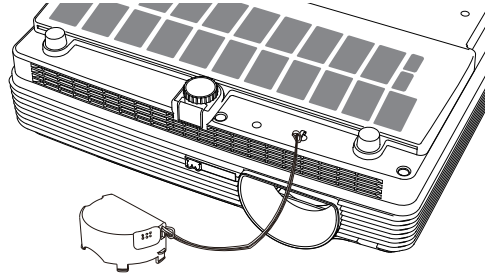

Cleaning the Projection Lens

Unplug the AC power cord before cleaning.

Gently wipe the projection lens with a cleaning cloth that contains a small amount of non-abrasive camera lens cleaner, or use a lens cleaning paper or commercially available air blower to clean the lens.

Avoid using an excessive amount of cleaner. Abrasive cleaners, solvents, or other harsh chemicals might scratch the surface of the lens.

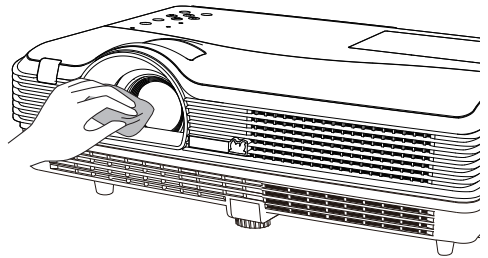

Cleaning the Projector Cabinet

Unplug the AC power cord before cleaning.

Gently wipe the projector body with a soft dry cleaning cloth. When the cabinet is heavily soiled, use a small amount of mild detergent and finish with a soft dry cleaning cloth. Avoid using an excessive amount of cleaner. Abrasive cleaners, solvents, or other harsh chemicals might scratch the surface of the cabinet.

When the projector is not in use, put the projector in an appropriate carrying case to protect it from dust and scratches.

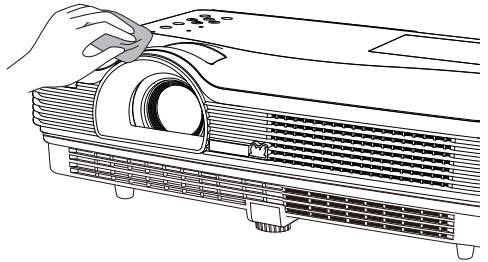

CAUTION

Do not use any flammable solvents or air sprays on the projector and in its vicinity. The explosion or fire hazard may occur even after the AC power cord is unplugged because the temperature inside the projector is extremely high due to the lamps. In addition, there is a risk that the internal parts may be damaged not only by the flammable air spray but also by the cold air.

Lamp Replacement

When the projection lamp of the projector reaches its end of life, the Lamp replacement icon appears on the screen and LAMP REPLACE indicator lights yellow.

Replace the lamp with a new one promptly. The timing when the LAMP REPLACE indicator should light is depending on the lamp mode.

Top Control

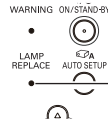

LAMP REPLACE indicator



Lamp replacement icon

✓ Note:

The Lamp replacement icon will not appear when the Display function is set to **Off** (p.46), during **Freeze** (p.25), or **No show** (p.26).



CAUTION

Allow a projector to cool for at least 45 minutes before you open the Lamp Cover. The inside of the projector can become very hot.



CAUTION

For continued safety, replace with a lamp of the same type. Do not drop a lamp or touch a glass bulb! The glass can shatter and may cause injury.



CAUTION

When replacing the lamp because it has stopped illuminating, there is a possibility that the lamp may be broken.

If replacing the lamp of a projector which has been installed on the ceiling, you should always assume that the lamp is broken, and you should stand to the side of the lamp cover, not underneath it. Remove the lamp cover gently. Small pieces of glass may fall out when the lamp cover is opened. If pieces of glass get into your eyes or mouth, seek medical advice immediately.

Follow these steps to replace the lamp.

- 1 Unplug the AC power cord. Let the projector cool for at least 45 minutes.
- 2 Loosen the screw and open the lamp cover.
- 3 Loosen the three (3) screws that secure the lamp. Lift the lamp out of the projector by using the handles.
- 4 Replace the lamp with a new one and secure the three (3) screws. Make sure that the lamp is set properly. Close the lamp cover and secure the screw.
- 5 Connect the AC power cord to the projector and turn on the projector.
- 6 **Reset the lamp counter.**
See "Lamp Counter" on page 55.

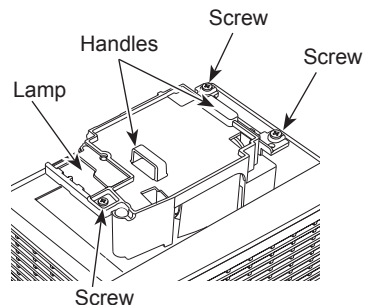
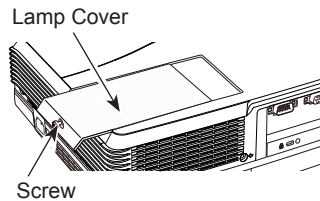

Maintenance and Cleaning

ORDER REPLACEMENT LAMP

Replacement lamp can be ordered through your dealer. When ordering a projection lamp, give the following information to the dealer.

- **Model No. of your projector : PJL6243**
- **Replacement Lamp Type No.: RLC-065**



LAMP HANDLING PRECAUTIONS

This projector uses a high-pressure lamp which must be handled carefully and properly.

Improper handling may result in accidents, injury, or create a fire hazard.

- Lamp life may differ from lamp to lamp and according to the environment of use. There is no guarantee of the same life for each lamp. Some lamps may fail or terminate their life in a shorter period of time than other similar lamps.
- If the projector indicates that the lamp should be replaced, i.e., if the LAMP REPLACE indicator lights up, replace the lamp with a new one IMMEDIATELY after the projector has cooled down.
(Follow carefully the instructions in the Lamp Replacement section of this manual.)
Continuous use of the lamp with the LAMP REPLACE indicator lighted may increase the risk of lamp explosion.
- A Lamp may explode as a result of vibration, shock or degradation as a result of hours of use as its lifetime draws to an end. Risk of explosion may differ according to the environment or conditions in which the projector and lamp are being used.

IF A LAMP EXPLODES, THE FOLLOWING SAFETY PRECAUTIONS SHOULD BE TAKEN.

If a lamp explodes, disconnect the projector's AC plug from the AC outlet immediately. Contact an authorized service center for a checkup of the unit and replacement of the lamp. Additionally, check carefully to ensure that there are no broken shards or pieces of glass around the projector or coming out from the cooling air circulation holes. Any broken shards found should be cleaned up carefully. No one should check the inside of the projector except those who are authorized trained technicians and who are familiar with projector service. Inappropriate attempts to service the unit by anyone, especially those who are not appropriately trained to do so, may result in an accident or injury caused by pieces of broken glass.

Appendix

Troubleshooting

Before calling your dealer or service center for assistance, check the items below once again.

- Make sure you have properly connected the projector to peripheral equipment as described on pages 14-16.
- Make sure all equipment is connected to AC outlet and the power is turned on.
- When the projector does not project an image from the connected computer, restart the computer.

Problem: – Solutions

No power

- Plug the power cord of the projector into the AC outlet.
- See if the POWER indicator lights red.
- The projector can be turned on after the POWER indicator turns red. See page 18.
- Check the WARNING indicator. If the WARNING indicator lights red, projector cannot be turned on. See page 58.
- Check the projection lamp. See page 61.
- Unlock the Key lock function for the projector. See page 53.

The initial display is not shown. – Make sure **Off** is not chosen at display function. See page 46.

The initial display is not same as the default set. – Make sure **User** or **Off** are not chosen at Logo (select) function. See page 46.

Input signal switches automatically. (or does not switch automatically) – Make sure Input search function is adjusted properly. See page 45.

When the projector is on and you press the input source buttons, an icon other than the Lamp mode icon appears. – That is the Filter warning icon. See page 56.

An icon other than Input mode or Lamp mode icon appears. – That is the Lamp replacement icon or the Filter warning icon. See page 61 or 56.

Image is out of focus.

- Adjust focus of the projector. See page 23.
- Provide proper distance between the projector and the projection screen. See page 13.
- Check the projection lens to see if it needs cleaning. See page 60.
- Moving the projector from a cool to warm place may result in moisture condensation on the projection lens. In such cases, leave the projector off and wait until condensation evaporates.

Image is Left/Right reversed. – Check the Ceiling/Rear function. See pages 35,43.
Image is Top/Bottom reversed. – Check the Ceiling function. See pages 35,43.

Picture is not bright enough.

- Check if the **Contrast** or **Brightness** is adjusted properly. See pages 33, 40.
- Check if **Image mode** is selected properly. See pages 32, 39.
- Check the lamp control function. See pages 25, 52.
- Check the LAMP REPLACE indicator. If it lights, the end of lamp life is approaching. Replace the lamp with a new one promptly. See page 61.

Appendix

No image	<ul style="list-style-type: none">– Check the connection between your computer or video equipment and the projector. See pages 14-16.– See if the input signal is correctly output from your computer. Some laptop computers may need to change the setting for monitor output when connecting to a projector. See your computer's instruction manual for the setting.– Check the Input signal, color system, video system or computer system mode.– Make sure the temperature is not out of the specified Operating Temperature (41°F–95°F [5°C–35°C]).– When No Show is operating, the image cannot be displayed. Press the NO SHOW button or any other button on the remote control.
No sound	<ul style="list-style-type: none">– Check the audio cable connection from audio input source.– Adjust the audio source.– Press the Volume + button. See page 24.– Press the Mute button. See page 24.– When the AUDIO OUT is plugged-in, the projector's built-in speaker is not available.– Is the image projected? You will hear the Computer and Video sound only when the image is projected.
The color is strange.	<ul style="list-style-type: none">– Check the Input signal, color system, video system or computer system mode.– Make sure the Blackboard is not selected on Image select menu. See pages 32, 39.
Some displays are not seen during the operation.	<ul style="list-style-type: none">– Check the Display function. See page 46.
Auto PC adjustment function does not work.	<ul style="list-style-type: none">– Check the Input signal. Auto PC adjustment function can not work when 480p, 576p, 720p, 480i, 576i, 1035i or 1080i is selected. See page 29.
The setting does not remain after turning off power.	<ul style="list-style-type: none">– Make sure you selected Store after adjusting setting. Some settings can not be stored if not registered with Store. See pages 33, 41.
Power management does not work.	<ul style="list-style-type: none">– Power management function can not work while Freeze or No Show function is running. See page 49.
Capture function does not work.	<ul style="list-style-type: none">– Check the connection and the input signal to see if there is signal.
Auto setup does not work properly.	<ul style="list-style-type: none">– Make sure Off is not selected at any function of Auto setup. See page 45.– Make sure On is not selected at the Ceiling function. See pages 35, 43.
Auto keystone function does not work even when the projector is tipped.	<ul style="list-style-type: none">– Make sure the Auto keystone function is not set to Manual. Press the AUTO SETUP button on the top control. See pages 23, 45.

The image is distorted or runs off. – Check **PC adjust** menu or **Screen** menu and adjust them. See pages 30-31, 34-35.

PIN code dialog box appears at start-up. – PIN code lock is being set. Enter a PIN code (the “1234” or numbers you have set). See pages 19, 53-54.

The Remote Control does not work.

- Check the batteries.
- Make sure no obstruction is between the projector and remote control.
- Make sure you are not too far from the projector when using the remote control. Maximum operating range is 16.4'(5 m).
- Make sure the code of the remote control is conformed to the projector's code. See page 52.
- Unlock the Key lock function for the remote control function. See page 53.

Indicator blinks or lights. – Check the status of the projector with referring to "Indicators and projector Condition". See page 68.

The exclamation mark appears on the screen. – Your operation is invalid. Operate correctly.

Top control does not work. – The top control is not available if the top control is locked at **Key lock** under **Security** of Setting section. See page 53.

Unable to unlock the Logo PIN code lock, Security key lock or Security PIN code lock. – Contact the dealer where you purchased the projector or the service center.



Service

appears on the screen

– The projector detects an abnormal condition. Unplug the AC power cord and contact the dealer where you purchased the projector or the service center.

WARNING :

High voltages are used to operate this projector. Do not attempt to open the cabinet.

If problems still persist after following all operating instructions, contact the dealer where you purchased the projector or the service center. Specify the model number and explain about the problem. We will advise you how to obtain service.

Menu Tree

Computer Input/Video Input

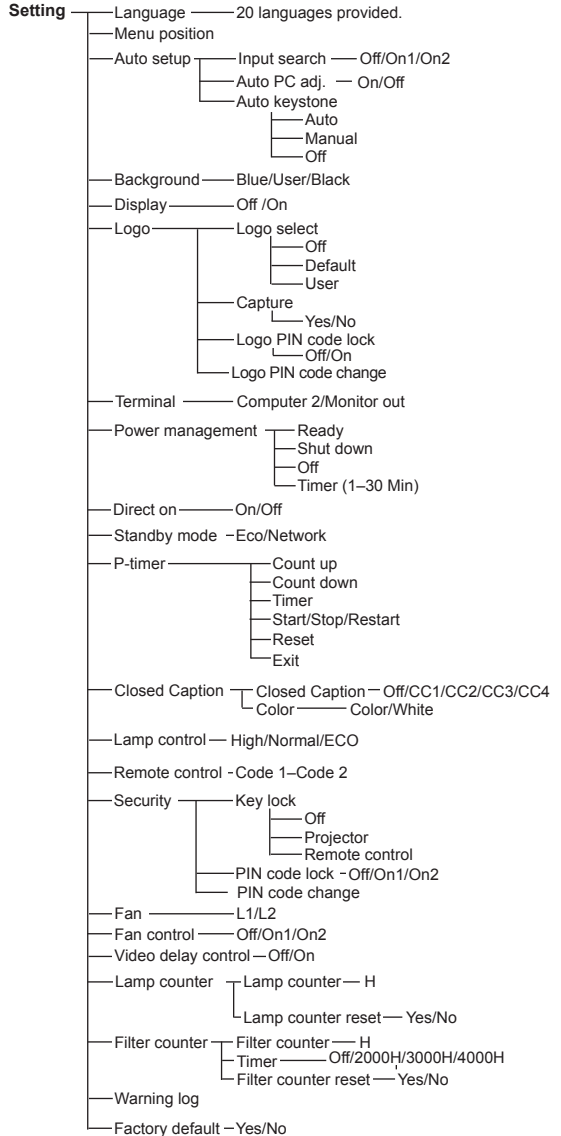
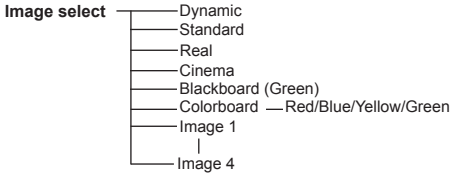
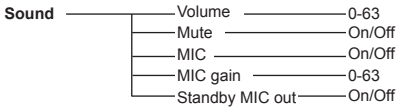
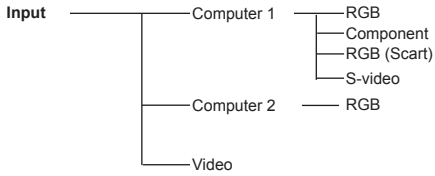

Video Input

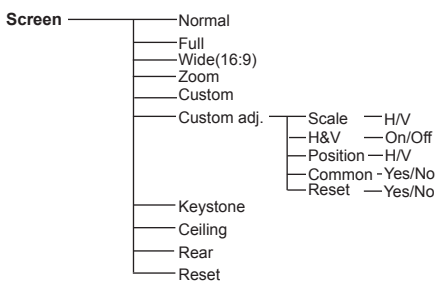
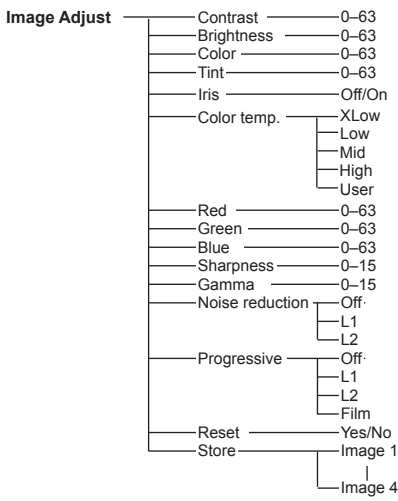
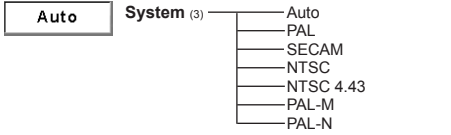
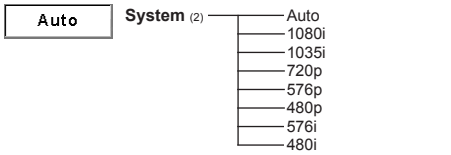

Computer Input

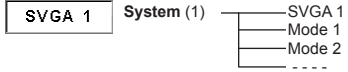



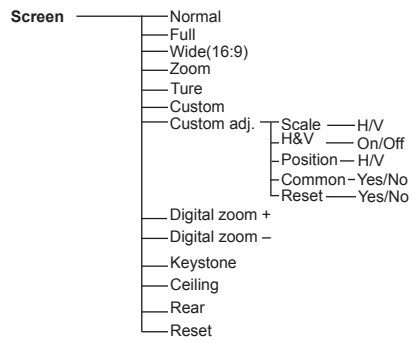
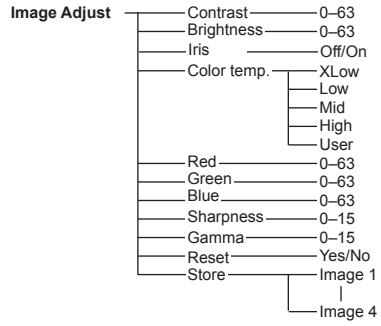
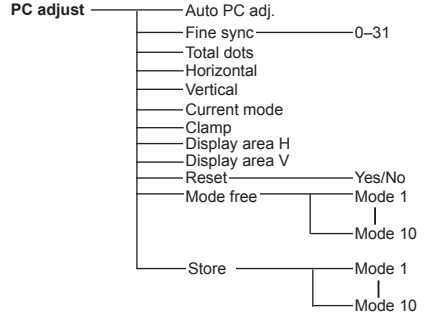





















* Systems displayed in the System Menu vary depending on an input signal.



Indicators and Projector Condition

Check the indicators for projector condition.

Indicators			Projector Condition
POWER red/ green	WARNING red	LAMP REPLACE yellow	
			The projector is off. (The AC power cord is unplugged.)
			The projector is in stand-by mode. Press the ON/STAND-BY button to turn on the projector.
			The projector is operating normally.
			The projector is preparing for stand-by or the projection lamp is being cooled down. The projector cannot be turned on until cooling is completed and the POWER indicator stops blinking.
			The projector is in the Power management mode.
			The temperature inside the projector is abnormally high. The projector cannot be turned on. When the projector is cooled down enough and the temperature returns to normal, the POWER indicator stops blinking and the projector can be turned on. (The WARNING indicator keeps blinking.)
			The projector has been cooled down enough and the temperature returns to normal. When turning on the projector, the WARNING indicator stops blinking.
			The projector detects an abnormal condition and cannot be turned on. Unplug the AC power cord and plug it again to turn on the projector. If the projector is turned off again, unplug the AC power cord and contact the dealer or the service center for service and checkup. Do not leave the projector on. It may cause an electric shock or a fire hazard.

 ••• green.

 ••• red

 ••• off

 ••• blinks green.

 ••• blinks red.

- ★ When the projection lamp reaches its end of life, the LAMP REPLACE indicator lights yellow. When this indicator lights yellow, replace the projection lamp with a new one promptly. (pp. 55, 61)

Compatible Computer Specifications

Basically this projector can accept the signal from all computers with the V-, H-Frequency mentioned below and less than 140 MHz of Dot Clock.

When selecting these modes, PC adjustment can be limited.

ON-SCREEN DISPLAY	RESOLUTION	H-Freq. (KHz)	V-Freq. (Hz)	ON-SCREEN DISPLAY	RESOLUTION	H-Freq. (KHz)	V-Freq. (Hz)
VGA 1	640 x 480	31.47	59.88	SXGA 5	1280 x 1024	63.74	60.01
VGA 2	720 x 400	31.47	70.09	SXGA 6	1280 x 1024	71.69	67.19
VGA 3	640 x 400	31.47	70.09	SXGA 7	1280 x 1024	81.13	76.107
VGA 4	640 x 480	37.86	74.38	SXGA 8	1280 x 1024	63.98	60.02
VGA 5	640 x 480	37.86	72.81	SXGA 9	1280 x 1024	79.976	75.025
VGA 6	640 x 480	37.50	75.00	SXGA 10	1280 x 960	60.00	60.00
VGA 7	640 x 480	43.269	85.00	SXGA 11	1152 x 900	61.20	65.20
MAC LC13	640 x 480	34.97	66.60	SXGA 12	1152 x 900	71.40	75.60
MAC 13	640 x 480	35.00	66.67	SXGA 13	1280 x 1024	50.00	^{86.00} (interface)
480p	640 x 480	31.47	59.88	SXGA 14	1280 x 1024	50.00	^{84.00} (interface)
576p	768 x 576	31.25	50.00	SXGA 15	1280 x 1024	63.37	60.01
480i	640 x 480	15.734	^{60.00} (interface)	SXGA 16	1280 x 1024	76.97	72.00
576i	768 x 576	15.625	^{50.00} (interface)	SXGA 17	1152 x 900	61.85	66.00
SVGA 1	800 x 600	35.156	56.25	SXGA 18	1280 x 1024	46.43	^{86.70} (interface)
SVGA 2	800 x 600	37.88	60.32	SXGA 19	1280 x 1024	63.79	60.18
SVGA 3	800 x 600	46.875	75.00	SXGA 20	1280 x 1024	91.146	85.024
SVGA 4	800 x 600	53.674	85.06	SXGA+ 1	1400 x 1050	63.97	60.19
SVGA 5	800 x 600	48.08	72.19	SXGA+ 2	1400 x 1050	65.35	60.12
SVGA 6	800 x 600	37.90	61.03	SXGA+ 3	1400 x 1050	65.12	59.90
SVGA 7	800 x 600	34.50	55.38	MAC21	1152 x 870	68.68	75.06
SVGA 8	800 x 600	38.00	60.51	MAC	1280 x 960	75.00	75.08
SVGA 9	800 x 600	38.60	60.31	MAC	1280 x 1024	80.00	75.08
SVGA 10	800 x 600	32.70	51.09	WXGA 1	1366 x 768	48.36	60.00
SVGA 11	800 x 600	38.00	60.51	WXGA 2	1360 x 768	47.70	60.00
MAC 16	832 x 624	49.72	74.55	WXGA 3	1376 x 768	48.36	60.00
MAC 19	1024 x 768	60.24	75.08	WXGA 4	1360 x 768	56.16	72.00
XGA 1	1024 x 768	48.36	60.00	WXGA 6	1280 x 768	47.776	59.87
XGA 2	1024 x 768	68.677	84.997	WXGA 7	1280 x 768	60.289	74.893
XGA 3	1024 x 768	60.023	75.03	WXGA 8	1280 x 768	68.633	84.837
XGA 4	1024 x 768	56.476	70.07	WXGA 9	1280 x 800	49.600	60.050
XGA 5	1024 x 768	60.31	74.92	WXGA 10	1280 x 800	41.200	50.000
XGA 6	1024 x 768	48.50	60.02	WXGA 11	1280 x 800	49.702	59.810
XGA 7	1024 x 768	44.00	54.58	WXGA 12	1280 x 800	63.98	60.02
XGA 8	1024 x 768	63.48	79.35	WUXGA 1	1920 x 1200	74.556	59.885
XGA 9	1024 x 768	36.00	^{87.17} (interface)	WUXGA 2	1920 x 1200	74.038	59.950
XGA 10	1024 x 768	62.04	77.07	WSXGA+ 1	1680 x 1050	65.290	59.954
XGA 11	1024 x 768	61.00	75.70	WXGA+ 1	1440 x 900	55.935	59.887
XGA 12	1024 x 768	35.522	^{86.96} (interface)	WXGA+ 2	1440 x 900	74.918	60.000
XGA 13	1024 x 768	46.90	58.20	UXGA 1	1600 x 1200	75.00	60.00
XGA 14	1024 x 768	47.00	58.30	UXGA 2	1600 x 1200	81.25	65.00
XGA 15	1024 x 768	58.03	72.00	UXGA 3	1600 x 1200	87.5	70.00
SXGA 1	1152 x 864	64.20	70.40	UXGA 4	1600 x 1200	93.75	75.00
SXGA 2	1280 x 1024	62.50	58.60	720p	1280 x 720	45.00	60.00
SXGA 3	1280 x 1024	63.90	60.00	720p	1280 x 720	37.50	50.00
SXGA 4	1280 x 1024	63.34	59.98	1035i	1920 x 1035	33.75	^{60.00} (interface)
				1080i	1920 x 1080	33.75	^{60.00} (interface)
				1080i	1920 x 1080	28.125	^{50.00} (interface)

√ **Note:**

The specifications are subject to change without notice.

Technical Specifications

Mechanical Information

Dimensions (W x H x D)	13.41" x 4.59" x 9.86" (340.5mm x 116.5mm x 250.5mm) (Not including protrusions)
Net Weight	6.4 lbs (2.9 kg)
Foot Adjustment	0° to 10°

Panel Resolution

LCD Panel System	0.63" TFT Active Matrix type, 3 panels
Panel Resolution	1,024 x 768 dots
Number of Pixels	2,359,296 (1,024 x 768 x 3 panels)

Signal Compatibility

Color System	PAL, SECAM, NTSC, NTSC4.43, PAL-M, and PAL-N
SD/HD TV Signal	480i, 480p, 576i, 576p, 720p, 1035i, and 1080i
Input Scanning Frequency	H-sync. 15 kHz–100 kHz, V-sync. 50–100 Hz

Optical Information

Projection Image Size (Diagonal)	Adjustable from 40" to 300"
Throw Distance	3.6' - 34.4' (1.1m - 10.5m)
Projection Lens	F 2.0 ~ 2.15 lens with f 18.38 mm ~ 22.06 mm with manual zoom and focus
Projection Lamp	215 W

Interface

Video Input Jack	RCA Type x 1
Audio Input Jack	RCA Type x 2
Computer In 1/S-video In/Component In	Mini Jack (stereo) x 1
/Computer In 2/Monitor Out/MIC Audio Input Jack	
Computer In 1/S-video In	Mini D-sub 15 pin x 1
/Component Input Jack	
Computer In 2 / Monitor Out Terminal	Mini D-sub 15 pin x 1
Control port	D-sub 9 pin x 1
Audio Output Jack	Mini Jack (stereo) x 1 (variable)
LAN Connection Terminal	RJ-45

Audio

Internal Audio Amp	10 W RMS
Built-in Speaker	1 speaker, ø1.6" (40mm)

Power

Voltage and Power Consumption	AC 100–120 V (3.6A Max. Ampere), 50/60 Hz (The U.S.A and Canada) AC 100–240 V (3.6A -2.0A Max. Ampere), 50/60 Hz (For other countries)
-------------------------------	---

Operating Environment

Operating Temperature	41°F–95°F (5 °C–35 °C)
Storage Temperature	14°F–140°F (-10°C–60 °C)

Remote Control

Battery	AAA or LR03 1.5V ALKALINE TYPE x 2
Operating Range	16.4' (5 m)±30°
Dimensions	2.0" (W) x 0.7" (H) x 4.3" (D) (52 mm x 18 mm x 110 mm)
Net Weight	2.37 oz (67 g) (including batteries)

- The specifications are subject to change without notice.
- LCD panels are manufactured to the highest possible standards. Even though 99.99% of the pixels are effective, a tiny fraction of the pixels (0.01% or less) may be ineffective by the characteristics of the LCD panels.

PJ Link Notice

This projector is compliant with PJLink Standard Class 1 of JBMIA (Japan Business Machine and Information System Industries Association). This projector supports all commands defined by PJLink Class 1 and is verified conformance with PJLink Standard Class 1.

For PJ Link password, see the User Guide of "Network Set-up and Operation."

Projector Input		PJLink Input	Parameter
Computer 1	RGB	RGB 2	12
	Component	RGB 3	13
	RGB (Scart)	RGB 5	15
	S-video	RGB 4	14
Computer 2	RGB	RGB 1	11
Video	Video	VIDEO 2	22

PJLink is a registered trademark of JBMIA and pending trademark in some countries.

PJLink™

Attaching the Filter Cover to the Projector

The supplied filter cover is designed for preventing dust accumulation on the filter when mounting the projector on the ceiling.

- 1 Turn over the projector.
- 2 Place the filter cover on the filter as the picture shown below.
- 3 Attach the projector to the ceiling mount in accordance with the instruction manuals which come with the ceiling mount.

✓ **Note:**

To keep the filter cover in position, be sure to attach the drop-prevention wire by threading it through the hole of the filter cover.

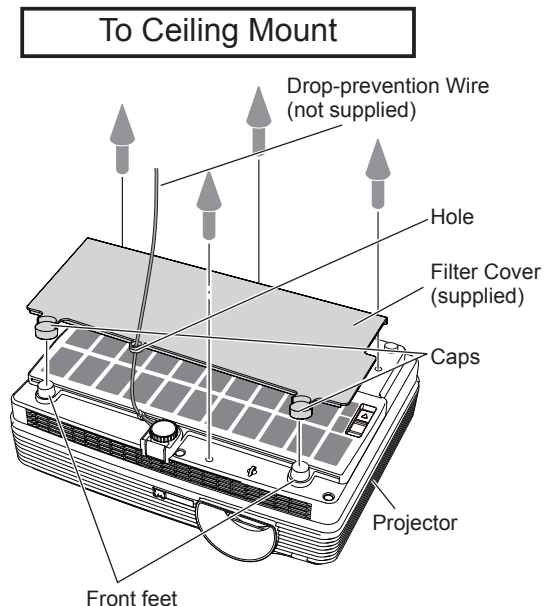

Configurations of Terminals

COMPUTER IN 1 / S-VIDEO IN/ COMPONENT IN

Terminal: Analog RGB (Mini D-sub 15 pin)

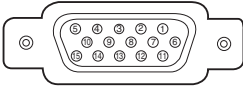

1	Red/Cr/S-C Input	9	+5V Power
2	Green/Y/S-Y Input	10	Ground (Vert.sync.)
3	Blue/Cb/--- Input	11	Ground
4	-----	12	DDC Data
5	Ground (Horiz.sync.)	13	Horiz. sync. Input/Output (Composite H/V sync.)
6	Ground (Red)	14	Vert. sync.
7	Ground (Green)	15	DDC Clock
8	Ground (Blue)		

COMPUTER IN 2/MONITOR OUT (ANALOG)

Terminal: Analog RGB (Mini D-sub 15 pin)

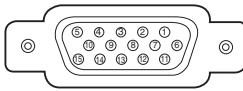

1	Red Input/Output	9	-----
2	Green Input/Output	10	Ground (Vert.sync.)
3	Blue Input/Output	11	-----
4	-----	12	-----
5	Ground (Horiz.sync.)	13	Horiz. sync. Input/Output
6	Ground (Red)	14	Vert. sync.
7	Ground (Green)	15	-----
8	Ground (Blue)		

CONTROL PORT CONNECTOR (D-sub 9 pin)

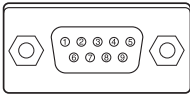

	Serial	5	SG
1	-----	6	-----
2	R X D	7	-----
3	T X D	8	-----
4	-----	9	-----

LAN TERMINAL

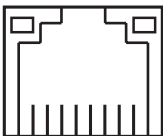

87654321

1	TX +	5	-----
2	TX -	6	RX -
3	RX +	7	-----
4	-----	8	-----

Serial Control Interface

This projector provides a function to control and monitor the projector's operations by using the RS-232C serial port.

Operation

- 1 Connect a RS-232C serial cross cable to CONTROL PORT on the projector and serial port on the PC. (See p.9)
- 2 Launch a communication software provided with PC and setup the communication condition as follows:
- 3 Type the command for controlling the projector and then enter the "Enter" key.

Example

When you want to change the input to COMPUTER 2, Type 'C' '0' '6' 'Enter'.

Functional Execution Command

Format

The command is sent from PC to the projector with the format below;

'C' [Command] 'CR'

Command: two characters (refer to the command table below.

- The projector decodes the command and returns the 'ACK' with the format below;
'ACK' 'CR'
- When the projector cannot decode the command, it returns with format below.
'?' 'CR'

Command	Function
C00	Turn the projector ON
C01	Turn the projector OFF (immediately OFF)
C02	Turn the projector OFF
C05	Computer 1
C06	Computer 2
C07	Video
C09	VOLUME +
C0A	VOLUME -
C0B	AUDIO MUTE ON
C0C	AUDIO MUTE OFF
C0D	VIDEO MUTE ON
C0E	VIDEO MUTE OFF
C0F	Screen Normal size(4 : 3)
C10	Screen Wide size(16 : 9)
C11	Image Standard
C12	Image Real
C13	Image Cinema
C14	Image 1
C15	Image 2
C16	Image 3
C17	Image 4
C18	Blackboard
C19	Dynamic

Baud rate	: 9600 / 19200 bps
Parity check	: none
Stop bit	: 1
Flow control	: none
Data bit	: 8

✓Note:

- The default of the baud rate is set to 19200 bps. If an error occurs in the communication, change the serial port and the communication speed (baud rate).
- Enter with ASCII 64-byte capital characters and onebyte characters.

Command	Function
C1C	MENU ON
C1D	MENU OFF
C1E	DISPLAY CLEAR
C20	BRIGHTNESS +
C21	BRIGHTNESS -
C27	IMAGE (Toggle)
C28	Direct on Enable
C29	Direct on Disable
C2A	Power Management Ready
C2B	Power Management OFF
C2E	Power Management Shut down
C30	D.ZOOM +
C31	D.ZOOM -
C34	Computer 1 S-Video
C39	Image Colorboard
C3A	POINTER RIGHT
C3B	POINTER LEFT
C3C	POINTER UP
C3D	POINTER DOWN
C3F	ENTER
C43	FREEZE ON
C44	FREEZE OFF
C50	Computer 1 Analog RGB
C51	Computer 1 Scart
C54	Computer 1 Component
C89	Auto PC ADJ.
C8A	PRESENTATION TIMER
C8B	PRESENTATION TIMER (Exit)
C8E	KEYSTONE ↑
C8F	KEYSTONE ↓

Status Read Command

Format

The command is sent from PC to the projector with the format below;

'CR' [Command] 'CR'

Command: one character (refer to the command table below.

The projector decodes the command and returns the 'Character string' with the format below;

Command	Function	Projector Return	Projector status
CR0	Status Read	00	Power On
		80	Stand-by mode
		40	Countdown
		20	Cooling down
		10	Power Malfunction
		28	Cooling down at the temperature anomaly
		88	Stand-by mode after Cooling down at the temperature anomaly.
		24	Cooling down at Power Management mode
		04	Power Management mode after Cooling down
		21	Cooling down after the projector is turned off when the lamps are out.
81	Stand-by mode after Cooling down when the lamps are out.		
CR6	Temperature Read	%1 %2 %3	%1 = Temperature at Sensor 1 (°C) %2 = Temperature at Sensor 2 (°C) %3 = Temperature at Sensor 3 (°C) (ex.) %1 = 12.3°C, %2 = 23.4°C, %3 = 34.5°C --> The projector displays "12.3 23.4 34.5" (For each sensor, two digit and the tenth place numbers are displayed with a space between each temperature.)
		?	Communication failure

The tables on pages 74 and 75 show the typical command lists for controlling the projector. Please consult your local dealer for further information of other commands.

Customer Support

For technical support or product service, see the table below or contact your reseller.

Note : You will need the product serial number.

Country/Region	Website	T = Telephone F = FAX	Email
Australia/New Zealand	www.viewsonic.com.au	AUS= 1800 880 818 NZ= 0800 008 822	service@au.viewsonic.com
Canada	www.viewsonic.com	T (Toll-Free)= 1-866-463-4775 T (Toll)= 1-424-233-2533 F= 1-909-468-3757	service.ca@viewsonic.com
Europe	www.viewsoniceurope.com	www.viewsoniceurope.com/uk/support/call-desk/	
Hong Kong	www.hk.viewsonic.com	T= 852 3102 2900	service@hk.viewsonic.com
India	www.in.viewsonic.com	T= 1800 11 9999	service@in.viewsonic.com
Ireland (Eire)	www.viewsoniceurope.com/uk/	www.viewsoniceurope.com/uk/ support/call-desk/	service_ie@viewsoniceurope.com
Korea	www.kr.viewsonic.com	T= 080 333 2131	service@kr.viewsonic.com
Latin America (Argentina)	www.viewsonic.com/la/	T= 0800-4441185	soporte@viewsonic.com
Latin America (Chile)	www.viewsonic.com/la/	T= 1230-020-7975	soporte@viewsonic.com
Latin America (Columbia)	www.viewsonic.com/la/	T= 01800-9-157235	soporte@viewsonic.com
Latin America (Mexico)	www.viewsonic.com/la/	T= 001-8882328722	soporte@viewsonic.com
Renta y Datos, 29 SUR 721, COL. LA PAZ, 72160 PUEBLA, PUE, Tel: 01.222.891.55.77 CON 10 LINEAS Electroser, Av Reforma No. 403Gx39 y 41, 97000 Mérida, Yucatán. Tel: 01.999.925.19.16 Other places please refer to http://www.viewsonic.com/la/soporte/index.htm#Mexico			
Latin America (Peru)	www.viewsonic.com/la/	T= 0800-54565	soporte@viewsonic.com
Macau	www.hk.viewsonic.com	T= 853 2870 0303	service@hk.viewsonic.com
Middle East	ap.viewsonic.com/me/	Contact your reseller	service@ap.viewsonic.com
Puerto Rico & Virgin Islands	www.viewsonic.com	T= 1-800-688-6688 (English) T= 1-866-379-1304 (Spanish) F= 1-909-468-3757	service.us@viewsonic.com soporte@viewsonic.com
Singapore/Malaysia/Thailand	www.ap.viewsonic.com	T= 65 6461 6044	service@sg.viewsonic.com
South Africa	ap.viewsonic.com/za/	Contact your reseller	service@ap.viewsonic.com
United Kingdom	www.viewsoniceurope.com/uk/	www.viewsoniceurope.com/uk/ support/call-desk/	service_gb@viewsoniceurope.com
United States	www.viewsonic.com	T (Toll-Free)= 1-800-688-6688 T (Toll)= 1-424-233-2530 F= 1-909-468-3757	service.us@viewsonic.com

Limited Warranty

VIEWSONIC® PROJECTOR

What the warranty covers:

ViewSonic warrants its products to be free from defects in material and workmanship, under normal use, during the warranty period. If a product proves to be defective in material or workmanship during the warranty period, ViewSonic will, at its sole option, repair or replace the product with a like product. Replacement product or parts may include remanufactured or refurbished parts or components.

Limited Three (3) year General Warranty

Subject to the more limited one (1) year warranty set out below, North and South America: Three (3) years warranty for all parts excluding the lamp, three (3) years for labor, and one (1) year for the original lamp from the date of the first consumer purchase; Europe except Poland: Three (3) years warranty for all parts excluding the lamp, three (3) years for labor, and ninety (90) days for the original lamp from the date of the first consumer purchase; Poland: Two (2) years warranty for all parts excluding the lamp, two (2) years for labor, and ninety (90) days for the original lamp from the date of the first consumer purchase.

Limited One (1) year Heavy Usage Warranty:

Under heavy usage settings, where a projector's use includes more than fourteen (14) hours average daily usage, North and South America: One (1) year warranty for all parts excluding the lamp, one (1) year for labor, and ninety (90) days for the original lamp from the date of the first consumer purchase; Europe: One (1) year warranty for all parts excluding the lamp, one (1) year for labor, and ninety (90) days for the original lamp from the date of the first consumer purchase.

Other regions or countries: Please check with your local dealer or local ViewSonic office for the warranty information.

Lamp warranty subject to terms and conditions, verification and approval. Applies to manufacturer's installed lamp only. All accessory lamps purchased separately are warranted for 90 days.

Who the warranty protects:

This warranty is valid only for the first consumer purchaser.

What the warranty does not cover:

1. Any product on which the serial number has been defaced, modified or removed.
2. Damage, deterioration, failure, or malfunction resulting from:
 - a. Accident, abuse, misuse, neglect, fire, water, lightning, or other acts of nature, improper maintenance, unauthorized product modification, or failure to follow instructions supplied with the product.
 - b. Operation outside of product specifications.
 - c. Operation of the product for other than the normal intended use or not under normal conditions.
 - d. Repair or attempted repair by anyone not authorized by ViewSonic.
 - e. Any damage of the product due to shipment.
 - f. Removal or installation of the product.
 - g. Causes external to the product, such as electric power fluctuations or failure.
 - h. Use of supplies or parts not meeting ViewSonic's specifications.
 - i. Normal wear and tear.
 - j. Any other cause which does not relate to a product defect.
3. Removal, installation, and set-up service charges.

How to get service:

1. For information about receiving service under warranty, contact ViewSonic Customer Support (please refer to “Customer Support” page). You will need to provide your product’s serial number.
2. To obtain warranted service, you will be required to provide (a) the original dated sales slip, (b) your name, (c) your address, (d) a description of the problem, and (e) the serial number of the product.
3. Take or ship the product freight prepaid in the original container to an authorized ViewSonic service center or ViewSonic.
4. For additional information or the name of the nearest ViewSonic service center, contact ViewSonic.

Limitation of implied warranties:

There are no warranties, express or implied, which extend beyond the description contained herein including the implied warranty of merchantability and fitness for a particular purpose.

Exclusion of damages:

ViewSonic’s liability is limited to the cost of repair or replacement of the product. ViewSonic shall not be liable for:

1. Damage to other property caused by any defects in the product, damages based upon inconvenience, loss of use of the product, loss of time, loss of profits, loss of business opportunity, loss of goodwill, interference with business relationships, or other commercial loss, even if advised of the possibility of such damages.
2. Any other damages, whether incidental, consequential or otherwise.
3. Any claim against the customer by any other party.

Effect of state law:

This warranty gives you specific legal rights, and you may also have other rights which vary from state to state. Some states do not allow limitations on implied warranties and/or do not allow the exclusion of incidental or consequential damages, so the above limitations and exclusions may not apply to you.

Sales outside the U.S.A. and Canada:

For warranty information and service on ViewSonic products sold outside of the U.S.A. and Canada, contact ViewSonic or your local ViewSonic dealer.

The warranty period for this product in mainland China (Hong Kong, Macao and Taiwan Excluded) is subject to the terms and conditions of the Maintenance Guarantee Card.

For users in Europe and Russia, full details of warranty provided can be found in www.viewsoniceurope.com under Support/Warranty Information.

4.3: Projector Warranty

PRJ_LW01 Rev. 1h 06-25-07

Mexico Limited Warranty

VIEWSONIC® PROJECTOR

What the warranty covers:

ViewSonic warrants its products to be free from defects in material and workmanship, under normal use, during the warranty period. If a product proves to be defective in material or workmanship during the warranty period, ViewSonic will, at its sole option, repair or replace the product with a like product. Replacement product or parts may include remanufactured or refurbished parts or components & accessories.

How long the warranty is effective:

3 years for all parts excluding the lamp, 3 years for labor, 1 year for the original lamp from the date of the first consumer purchase.

Lamp warranty subject to terms and conditions, verification and approval. Applies to manufacturer's installed lamp only.

All accessory lamps purchased separately are warranted for 90 days.

Who the warranty protects:

This warranty is valid only for the first consumer purchaser.

What the warranty does not cover:

1. Any product on which the serial number has been defaced, modified or removed.
2. Damage, deterioration or malfunction resulting from:
 - a. Accident, misuse, neglect, fire, water, lightning, or other acts of nature, unauthorized product modification, unauthorized attempted repair, or failure to follow instructions supplied with the product.
 - b. Any damage of the product due to shipment.
 - c. Causes external to the product, such as electrical power fluctuations or failure.
 - d. Use of supplies or parts not meeting ViewSonic's specifications.
 - e. Normal wear and tear.
 - f. Any other cause which does not relate to a product defect.
3. Any product exhibiting a condition commonly known as "image burn-in" which results when a static image is displayed on the product for an extended period of time.
4. Removal, installation, insurance, and set-up service charges.

How to get service:

For information about receiving service under warranty, contact ViewSonic Customer Support (Please refer to the attached Customer Support page). You will need to provide your product's serial number, so please record the product information in the space provided below on your purchase for your future use. Please retain your receipt of proof of purchase to support your warranty claim.

For Your Records

Product Name: _____ Model Number: _____
Document Number: _____ Serial Number: _____
Purchase Date: _____ Extended Warranty Purchase? _____ (Y/N)
If so, what date does warranty expire? _____

1. To obtain warranty service, you will be required to provide (a) the original dated sales slip, (b) your name, (c) your address, (d) a description of the problem, and (e) the serial number of the product.
2. Take or ship the product in the original container packaging to an authorized ViewSonic service center.
3. Round trip transportation costs for in-warranty products will be paid by ViewSonic.

Limitation of implied warranties:

There are no warranties, express or implied, which extend beyond the description contained herein including the implied warranty of merchantability and fitness for a particular purpose.

Exclusion of damages:

ViewSonic's liability is limited to the cost of repair or replacement of the product. ViewSonic shall not be liable for:

1. Damage to other property caused by any defects in the product, damages based upon inconvenience, loss of use of the product, loss of time, loss of profits, loss of business opportunity, loss of goodwill, interference with business relationships, or other commercial loss, even if advised of the possibility of such damages.
2. Any other damages, whether incidental, consequential or otherwise.
3. Any claim against the customer by any other party.
4. Repair or attempted repair by anyone not authorized by ViewSonic.

Contact Information for Sales & Authorized Service (Centro Autorizado de Servicio) within Mexico:	
Name, address, of manufacturer and importers: México, Av. de la Palma #8 Piso 2 Despacho 203, Corporativo Interpalmas, Col. San Fernando Huixquilucan, Estado de México Tel: (55) 3605-1099 http://www.viewsonic.com/la/soporte/index.htm	
NÚMERO GRATIS DE ASISTENCIA TÉCNICA PARA TODO MÉXICO: 001.866.823.2004	
Hermosillo: Distribuciones y Servicios Computacionales SA de CV. Calle Juarez 284 local 2 Col. Bugambillas C.P: 83140 Tel: 01-66-22-14-9005 E-Mail: disc2@hmo.megared.net.mx	Villahermosa: Compumantenimientos Garantizados, S.A. de C.V. AV. GREGORIO MENDEZ #1504 COL, FLORIDA C.P. 86040 Tel: 01 (993) 3 52 00 47 / 3522074 / 3 52 20 09 E-Mail: compumantenimientos@prodigy.net.mx
Puebla, Pue. (Matriz): RENTA Y DATOS, S.A. DE C.V. Domicilio: 29 SUR 721 COL. LA PAZ 72160 PUEBLA, PUE. Tel: 01(52).222.891.55.77 CON 10 LINEAS E-Mail: datos@puebla.megared.net.mx	Veracruz, Ver.: CONEXION Y DESARROLLO, S.A DE C.V. Av. Americas # 419 ENTRE PINZÓN Y ALVARADO Fracc. Reforma C.P. 91919 Tel: 01-22-91-00-31-67 E-Mail: gacosta@qplus.com.mx
Chihuahua Soluciones Globales en Computación C. Magisterio # 3321 Col. Magisterial Chihuahua, Chih. Tel: 4136954 E-Mail: Cefeo@soluglobales.com	Cuernavaca Compusupport de Cuernavaca SA de CV Francisco Leyva # 178 Col. Miguel Hidalgo C.P. 62040, Cuernavaca Morelos Tel: 01 777 3180579 / 01 777 3124014 E-Mail: aquevedo@compusupportcva.com
Distrito Federal: QPLUS, S.A. de C.V. Av. Coyoacán 931 Col. Del Valle 03100, México, D.F. Tel: 01(52)55-50-00-27-35 E-Mail : gacosta@qplus.com.mx	Guadalajara, Jal.: SERVICRECE, S.A. de C.V. Av. Niños Héroes # 2281 Col. Arcos Sur, Sector Juárez 44170, Guadalajara, Jalisco Tel: 01(52)33-36-15-15-43 E-Mail: mmiranda@servicrece.com
Guerrero Acapulco GS Computación (Grupo Sesicomp) Progreso #6-A, Colo Centro 39300 Acapulco, Guerrero Tel: 744-48-32627	Monterrey: Global Product Services Mar Caribe # 1987, Esquina con Golfo Pérsico Fracc. Bernardo Reyes, CP 64280 Monterrey N.L. México Tel: 8129-5103 E-Mail: aydeem@gps1.com.mx
MERIDA: ELECTROSER Av Reforma No. 403Gx39 y 41 Mérida, Yucatán, México CP97000 Tel: (52) 999-925-1916 E-Mail: rrrb@sureste.com	Oaxaca, Oax.: CENTRO DE DISTRIBUCION Y SERVICIO, S.A. de C.V. Murguía # 708 P.A., Col. Centro, 68000, Oaxaca Tel: 01(52)95-15-15-22-22 Fax: 01(52)95-15-13-67-00 E-Mail: gpotai2001@hotmail.com
Tijuana: STD Av Ferrocarril Sonora #3780 L-C Col 20 de Noviembre Tijuana, Mexico	FOR USA SUPPORT: ViewSonic Corporation 381 Brea Canyon Road, Walnut, CA. 91789 USA Tel: 800-688-6688 (English); 866-323-8056 (Spanish); Fax: 1-800-685-7276 E-Mail: http://www.viewsonic.com

Network Set-up and Operation



Safety instructions



CAUTION IN USING THE PROJECTOR VIA NETWORKS

- ☛ When you find a problem with the projector, remove the power cable immediately and inspect the unit. Using the projector with failure may cause fire or other accidents.
- ☛ If you remotely use the projector via networks, carry out a safety check regularly and take particular care to its environment. Incorrect installation may cause fire or other accidents.



CAUTION IN USING NETWORK FUNCTION

- ☛ We assume no responsibility for the loss or damage of data, or damage of the computer caused by using this projector. Making back-up copies of valuable data in your computer is recommended.

Table of contents

Safety instructions.....	3
Table of contents.....	4
Chapter 1 Preparation	5
Features.....	6
Required operating environment for computers.....	7
Network specifications of the projector.....	7
Flow of installation.....	9
Notice about installing Software CD-ROM.....	9
Chapter 2 Setup Procedures.....	11
Connecting to the LAN line.....	12
Network configuration.....	12
Network PIN code.....	14
Network information.....	14
Network factory default.....	15
Wired LAN factory default settings.....	16
Chapter 3 Basic Setting and Operation	17
Login the setting page of the projector.....	18
[1] Enter the IP address.....	18
[2] Login.....	18
[3] Display of main setting page.....	19
How to use the setting page.....	20
Initial setting.....	22
Network PIN code setting.....	23
PJLink and password setting.....	23
Network configuration.....	24
E-mail setting.....	25
Examples: Type and contents of alert mail.....	28
SNMP setting.....	29
Chapter 4 Controlling the Projector	31
Power control and status check.....	32
Control.....	34
Input.....	34
System.....	35
Sound.....	36
Image adjustment.....	37
PC adjustment.....	38
Setting up the projector.....	39
Screen setting.....	39
Setting 1.....	40
Setting 2.....	40
Setting 3.....	41
Information.....	42
Chapter 5 Appendix	45
Examples of connection.....	46
Use of telnet.....	48
Web browser setting.....	50
Examples: OS/Browsers.....	51
Q&A.....	55

Chapter 1

Preparation

Describes features and operating environment of this projector.

1

Features

Web Management function (p.31)

With this function, you can monitor projector functions such as power status, lamp status, input mode, signal condition, lamp-use time, etc. through the network by using the web browser installed on your computer.

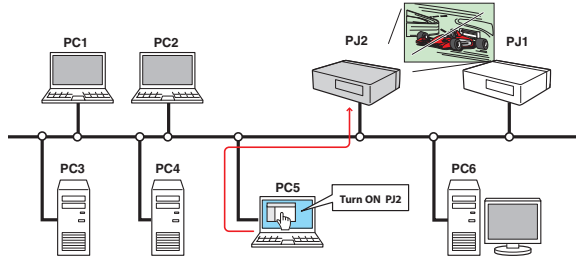

E-Mail Alert function (p.25)

The projector sends messages to the registered e-mail addresses when a lamp abnormality or power failure occurs with the projector. This message describes how to solve the cause of the problems. You can take efficient action for quick recovery.

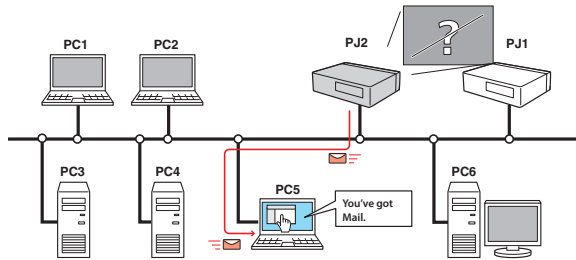

SNMP Agent function (p.29)

To send the information of the projector to the SNMP manager. Enables you to manage the projector condition with the supplied SNMP manager software.

SNMP Manager function

A function to manage the condition of projectors in the network by using the SNMP protocol. The managing computer needs to provide an SNMP managing software. Refer to the owner's manual of the "PJ Network Manager" supplied separately for further details.

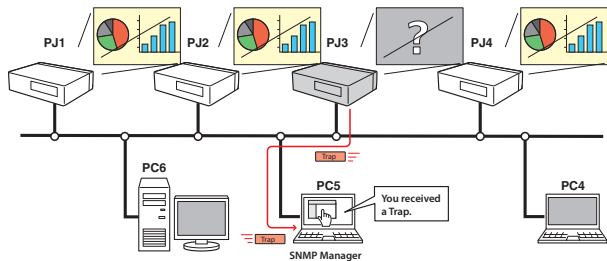

Required operating environment for computers

When operating the projector via networks, computers should meet the operating environment below.

Operating System		Windows 2000, Windows XP (32bit version), Windows Vista (32bit version), Windows 7 (32bit version) Mac OS X v 10.4 or 10.5
Computer environment	Recommended CPU	Windows: Pentium III 900MHz or more Macintosh : 800 MHz PowerPC G4 or faster, or 1.8 GHz Intel Core Processor or faster
	Memory	Windows : 64MB (Minimum)/ 128MB or more (Recommended) 128MB or more for Windows XP 1GB or more for Windows Vista or Windows 7 Macintosh : 256MB or more (512MB is recommended)
	Free disk space	100MB or more
	Drive equipment	CD-ROM drive
	Display settings	Support one of following resolutions; VGA (640 x 480), SVGA(800 x 600), XGA(1,024 x 768) Number of colors: Either of 16 bit (65,536 color 24/32 bit (16.77 million colors))
	Network card	The computer must provide a 10Base-T or 100Base-TX network card.
Web Browser*		Internet Explorer version 6.0, 7.0 or 8.0 Netscape Navigator version 7.1 or 9.0 Safari 3.1 * Used to control and set up the projector. The layout of pages in the browser may slightly differ from each type of application or operating system you use.
Recommended Internet Mailer*		- Microsoft Outlook - Microsoft Outlook Express - Netscape Mail * Required the internet e-mail application software to receive an e-mail alert sent from this projector. If you do not use the function E-mail Alert, this application is not required.

Network specifications of the projector

LAN Terminal

Data communication standards	10Base-T (10Mbps) / 100Base-TX compatible
Protocol	TCP/IP

Cabling Between the Projector and a Hub or computer*1

Use an appropriate cable when connecting the projector and a hub or computer.

Connection	Ethernet cable type	Max. cable length
Projector - Hub	STP straight-through category 5 *2 cable	100m (328feet)
Projector - Computer	STP crossover category 5*2 cable	100m (328feet)

*1 There may be other limitations depending on your network environment or LAN specification. Please consult your network administrator for further details.

*2 Cable category indicates cable quality.

Notice

Expression/Abbreviation

The OS of the computer and the Web browser described in this manual are Windows XP Professional and Internet Explorer 6.0. In case of another OS or Web browser, some instruction procedures may differ from the actual operation depending on your computer environment.

Use of this manual

This manual does not provide the detailed description of basic operation and functions for computer, web browser, projector and network. For instructions about each piece of equipment or application software, please refer to the respective manual.

Trademarks

Ethernet is a registered trademark of Xerox Corporation. Microsoft, Windows, Windows 2000, Windows XP, Windows Vista and Windows 7 are registered trademarks of Microsoft Corporation in the United States and other countries. Internet Explorer is a registered trademark of Microsoft Corporation. Netscape Navigator and Netscape Communicator are trademarks or registered trademarks of Netscape Communications Corporation. JavaScript is a registered trademark of Sun Microsystems, Inc.

Macintosh is a registered trademark of Apple, Inc. in the USA and other countries. PowerPC is a registered trademark of IBM Corporation. Intel Core is a registered trademark of Intel Corporation in the USA and other countries.

Other product or brand names in this manual are registered trademarks or trademarks of their respective owners.

* Unauthorized use of a part or whole of the contents in this manual is prohibited.

* The contents of this manual are subject to change without notice.

Flow of installation

To use the projector via the networks, follow the setup procedures below.

STEP 1

Connect the LAN and set the configuration.



Decide depending on the LAN environment.

☛ "2. Setup Procedures" (pp.11–16).

Detailed LAN configurations need to be done with a browser later.

First, complete the Wired LAN connection between computers and projectors, then start browser configurations.

☛ "3. Basic setting and operation" (pp.17–30).

STEP 2

Network Configuration has completed.



Follow each chapter to operate the projector.

Operate and manage the projector ☛ "4. Controlling the projector" (pp.31-43)

☛ "Power Control and status check" (p.32)

☛ "Control" (p.34)

☛ "PC adjustment" (p.38)

☛ "Setting up the projector" (p.39)

☛ "Projector information" (p.42)

STEP 3

Install the Software on computers.

Install the software recorded in CD-ROM on each computer which will be operated. Refer to the owner's manual of PJ Network Manager.

Notice about installing Software CD-ROM

It is available for controlling and setting of the projector by using the web browser without installing any software. So it is not required to install the software into your computer.

For PJ Network Manager function, it is required to install the software. Please see the owner's manual of "PJ Network Manager Function".

Chapter 2

Setup Procedures

Describes how to configure the network.

2

Setting procedures and contents differ depending on the LAN installation location. When installing, consult your system administrator to set up the LAN appropriately.

Connecting to the LAN line

Connect the LAN cable to the LAN connection terminal of the projector.

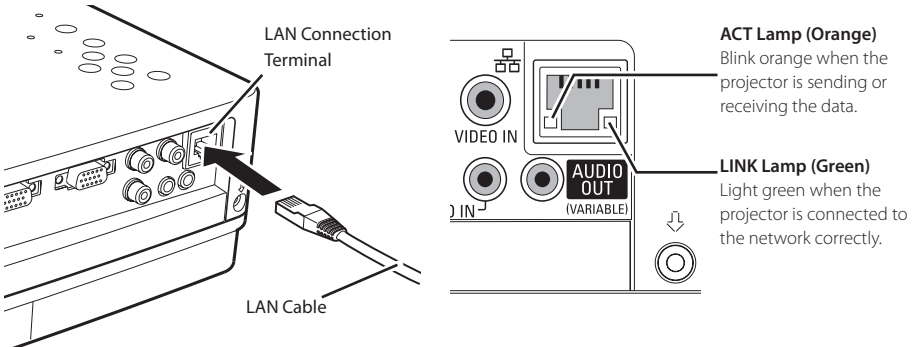

* Please use a shielded LAN cable.

Network configuration

Set the Wired LAN network through the projector menu. Detailed network settings will be made with browser. Refer to “3. Basic setting and operation” (p.17-30). First, complete the settings described in this chapter before performing steps in “3. Basic setting and operation.”

Setting Procedure

1. Select “LAN mode select” in the Network menu, and press Point **8** or **SELECT** button.
2. Select similar LAN environment among LAN1, LAN2 and LAN3 with the Point **ed** buttons, and press **SELECT** button. Then the Menu will disappear, the “Please wait...” message will appear, and switching operation will start. Switching will take a while and the projector’s LINK/ACT Lamp will be on or blink, and after completing the operation, the “Please wait...” message will disappear.

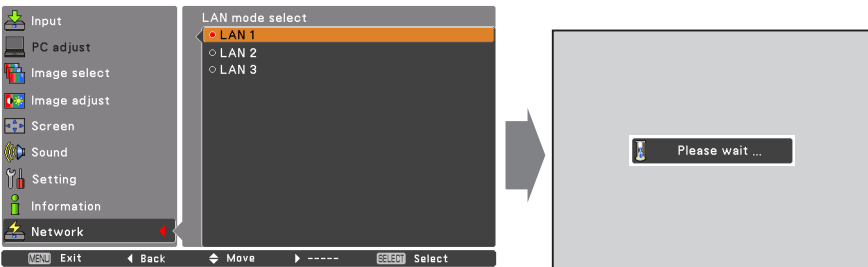

3. Select "Network setting" in the Network menu and press **SELECT** button, and then the LAN setting screen will appear and selected LAN settings will be displayed. Adjust each item to the setting environment. Consult your system administrator about the detailed settings.

Press **SELECT** button in a row where you want to adjust, and adjust the figures with the Point **ed** buttons and move among the items with the Point **7 8** buttons, and then press **SELECT** button to fix. Move to the next row with the Point **ed** buttons to adjust.

4. After completing all the settings, select "Set" and press **SELECT** button. Now, all procedures have been done. To cancel the adjusted settings, select "Cancel" and press **SELECT** button.

You can confirm the LAN settings you have made from "Network information" (p.14). In such cases that the LAN cannot be connected, see this screen.

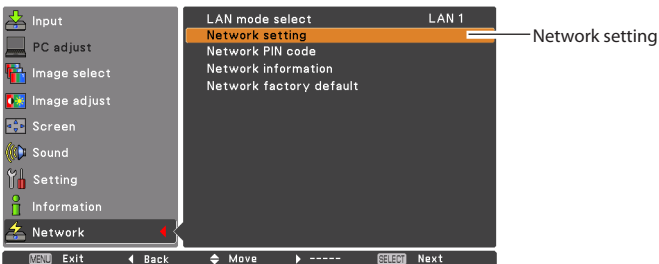

DHCP: On

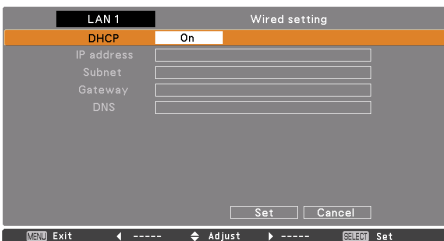

DHCP: Off

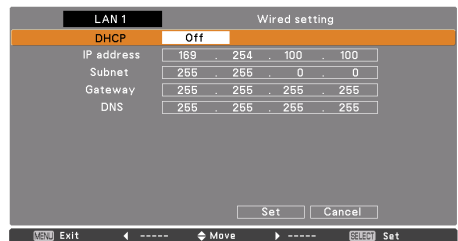

* The numerical value is a setting example.

Item	Description
DHCP	Sets DHCP function On or Off. When you setup the network setting manually, select "Off". When it is set On, IP address, Subnet, Gateway and DNS are automatically set according to your network environment*1.
IP address	Sets IP address of the projector
Subnet	Sets Subnet mask according to your network environment.
Gateway*2	Sets IP address of the default gateway (Router)
DNS*3	Sets IP address of the DNS server.

*1 Set "On" only when the DHCP server is available on your network environment.

*2 Set [255.255.255.255] if the network does not provide the gateway (router).

*3 Set [255.255.255.255] if you do not use the function E-mail alert.

Network PIN code

The Network PIN code is to restrict the access to the projector through the network. After setting the Network PIN code, you need to enter it to operate the projector via the networks.

1. Select "Network PIN code" in the Network menu, and press **SELECT** button.
The Network PIN code screen will appear.
2. Set the Network PIN code.

Set the figures with the Point **ed** buttons and move to the next items with the Point **7 8** buttons. Select "Set" and press **SELECT** button to set. To cancel the preset Network PIN code, select "Cancel". When you do not want to set the Network PIN code, set "0000".

It is recommended to set the Network PIN code if you use the projector via the networks. The Network PIN code can be set also through the networks. See "3. Basic setting and operation" ➤ "Initial setting" ➤ "Network PIN code setting" (p.23).

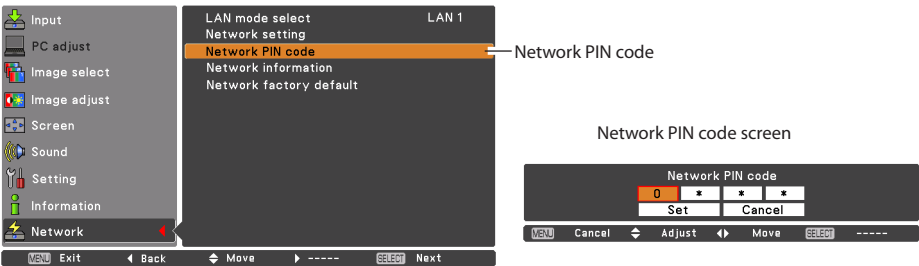

Network information

Select "Network information" in the Network menu and press Point **8** or **SELECT** button to show LAN setting environment of the currently selected projector. (The description below is an example and different from what will be shown.)

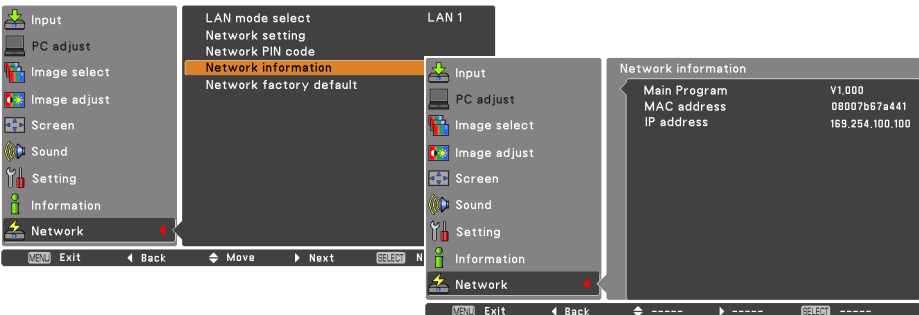

* The numerical value is a setting example.

Network factory default

1. Select "Network factory default" in the Network menu and press **SELECT** button.
2. A confirmation box appears and select "Yes" and then press **SELECT** button.
3. Another confirmation box appears and select "Yes" and then press **SELECT** button.
4. All the wired LAN settings will go back to the factory default settings. For details, refer to "Wired LAN factory default settings" (p.16).

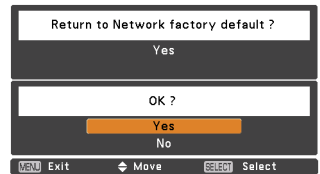
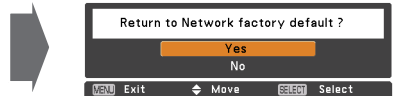
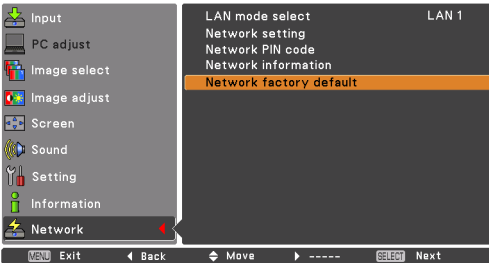

Wired LAN factory default settings

.....

Parameter	SELECTED LAN		
	LAN 1	LAN 2	LAN 3
DHCP	OFF	ON	OFF
IP ADDRESS	169.254.100.100	192.168.100.100	192.168.100.100
SUBNET MASK	255.255.0.0	255.255.255.0	255.255.255.0
GATEWAY ADDRESS	255.255.255.255	255.255.255.255	255.255.255.255
DNS ADDRESS	255.255.255.255	255.255.255.255	255.255.255.255

3

Chapter 3 ***Basic Setting and Operation***

Describes basic operations and settings for controlling the projector by using the web browser. It is required that computer and projector is connected to the network and the network address is properly configured.

Login the setting page of the projector

[1] Enter the IP address

Launch the web browser installed in your computer, enter the IP address into the "Address" on the browser and then press "Enter" key.

Enter the address that you configured in item "Network configuration" (p.12).

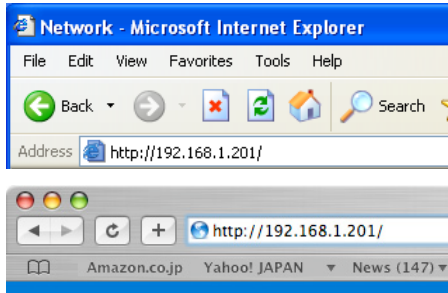

* The numerical value is a setting example.

[2] Login

If the setting page has set the password, the authentication window will appear. In this case type "user" onto the **User Name** text area and the login Network PIN code onto the **Password** text area and then click **OK (Log in)** button.

* The entering User Name must be "user" and it can not be changed.

[Note]

When accessing the projector for the first time or the Network PIN code "0000" is set, the auto-login will be performed and the next main setting page is displayed.

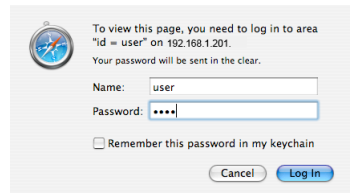

[3] Display of main setting page

The following main setting page will be displayed according to your display mode selection. Perform various kinds of settings through this page. Click on the menus to display the control and setting pages.

Main setting page in the display

The screenshot shows the projector's main setting page. On the left is a vertical 'Main menu' with options: Initial setting, Power & Status, PC Adj., Control, Setting, E-mail setting, Network, Information, and SNMP setting. The 'Setting' option is selected. The main area displays the 'Control' sub menu, which includes settings for Contrast, Brightness, Color, Tint, Iris, Color temp., White balance (Red, Green, Blue), Sharpness, Gamma, Noise reduction, Progressive, Reset, Store, and Load image mode. Each setting has a numerical value, a dropdown menu, and a 'Set' button. A 'Sub menu tab' is located at the top right of the main area, with a callout box stating it 'Switches the sub menu tab.' Below the main area, a 'Setting page' callout box explains that it 'Displays the control and setting items according to the selected menu.'

Main menu
For selection of control and setting items of the projector.

Setting page
Displays the control and setting items according to the selected menu.

Sub menu tab
Switches the sub menu tab.

How to use the setting page

To control and set up the projector, use the setting menus on the web browser. Describes the basic operation and procedures commonly used on this manual.

Example of the setting page

The setting menu appears when clicking the sub menu tab.

* Each item has a valid setting range respectively.

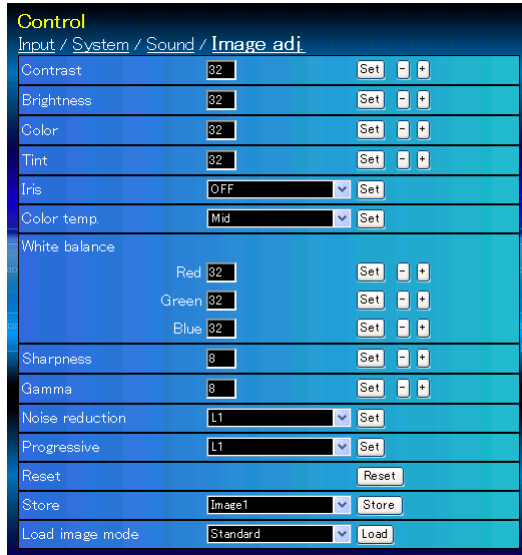

Types of setting

Text box setting

Enter a number or text and then click **Set** button.

or

Change a value with - or + button.

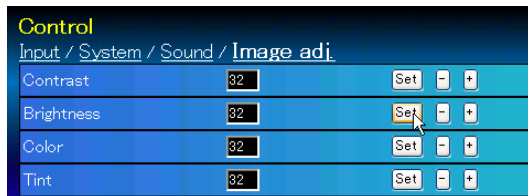

Pull-down menu setting

Select an item with pull-down menu button and then click **Set** button.



- The value in the text box indicates current value.
- Each item has a valid setting range. The setting value exceeding this becomes invalid. Some control items can not be used depending on the selecting input mode or functions of the projector you use. In this case, the values of those items are indicated with "----".

Radio button setting

Select an item by selecting a radio button.

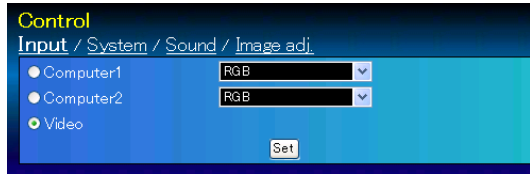

Check box setting

Select items by ticking on check boxes.

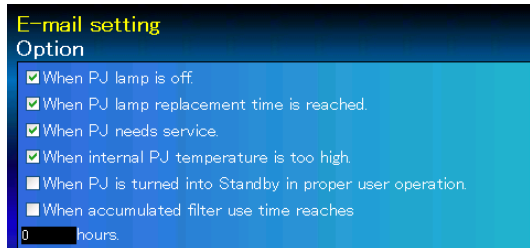



Initial setting

After installing the projector, perform the following basic initial setting. Click **Initial Setting** on the main menu to display the initial setting page.



Item	Description
------	-------------

- | | |
|------------------------|--|
| Language..... | Switches display language on the setting page. (Japanese, English) |
| Model name | Indicates the model name of the projector |
| Network PIN code | Sets the Network PIN code to login the setting page (p.23) |
| PJLink..... | Switches PJLink password authentication. (ON, OFF) (p.23) |
| Password..... | Password for PJLink function (p.23) |

Network PIN code setting

This is to set the Network PIN code to restrict the access from an unauthorized person through the network.

Enter a 4-digit number as the Network PIN code onto the text box and click **Set** button.

The projector begins restarting and it takes about 10 seconds. Close (Quit) the web browser and access to the login page again in 10 seconds. This is to perform the login authentication firmly.

The default Network PIN code [0000] means no Network PIN code is set.

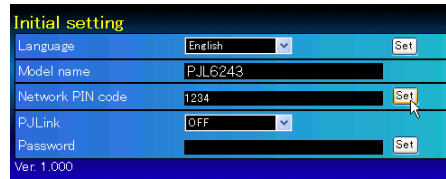

- When you connect the projector to the network, it is recommended to set a new Network PIN code. Only a four-digit number is valid for the Network PIN code.

PJLink and password setting

This is to set the PJLink password authentication on or off. If set "ON" with the PJLink pull-down menu, the password must be required. Enter a **password*** onto the text box and click **Set** button.

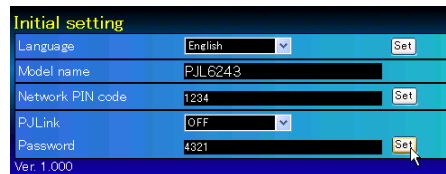

- 1 to 32 alphanumeric characters can be used for the password.

What's PJLink?

The projectors equipped with PJLink function can be used together on the same network, regardless of model or brand, for centralized control and monitoring. This standard was established by the Japan Business Machine and Information System Industries Association (JBMIA). Please visit the Website at <http://pjlink.jbmia.or.jp/english/>.

PJLink Notice

The projector is compliant with PJLink Standard Class 1 of JBMIA, and it supports all commands defined by PJLink Class 1 and is verified conformance with PJLink Standard Class 1.

Projector Input		PJLink Input	Parameter
Computer 2	RGB	RGB 1	11
Computer 1	RGB	RGB 2	12
	Component	RGB 3	13
	S-video	RGB 4	14
	RGB (Scart)	RGB 5	15
Video	Video	VIDEO 2	22



Network configuration

Click **Network** on the main menu. The following setting page is displayed. The IP Address, Subnet Mask, Default Gateway, DNS (Domain Name Server) and projector name are set up on this menu.

The IP address and Subnet Mask have been configured already in chapter "Installation". If you want to change them or configure default gateway or DNS, perform them in this page. If you change them, the projector begins restarting and it takes about 10 seconds. Close (Quit) the web browser and access to the login page again in 10 seconds.



Item	Description
LAN mode	Displays the selected LAN mode
DHCP	Sets DHCP configuration (ON/OFF).
IP address	Sets IP address of the projector
Subnet mask	Sets Subnet mask according to your network environment.
Default gateway*1	Sets IP address of the default gateway (Router)
DNS*2	Sets IP address of the DNS server. Must be set when using the e-mail function
Projector name*3.	Sets name of the projector. (64 characters maximum)

☛ You must use the number specified by your administrator. The address must be entered as a group with four numbers split by a dot like [192.168.001.101].

*1 Set [0.0.0.0] if the network does not provide the gateway (router).
 *2 Set [0.0.0.0] if you do not use the function E-Mail alert.
 *3 If you use the DNS server, register the host name registered to the DNS server as a projector name. You can access with this projector name from any computers in your network. If you do not use the DNS server, access with the assigned IP address to the projector.
 * All the network setting will reset to the default when setting [0.0.0.0] of the IP Address.
 * If you make incorrect settings, you cannot find out the new network settings. Be careful to set up them correctly, otherwise you cannot connect to the projector. It is recommended to make a note of them.



E-mail setting

This projector has an E-mail function which can send an alert message to users or an administrator if it detects an abnormality on the projector or run out of the life span of the lamp. Click **E-mail Setting** on the main menu and follow the below steps.

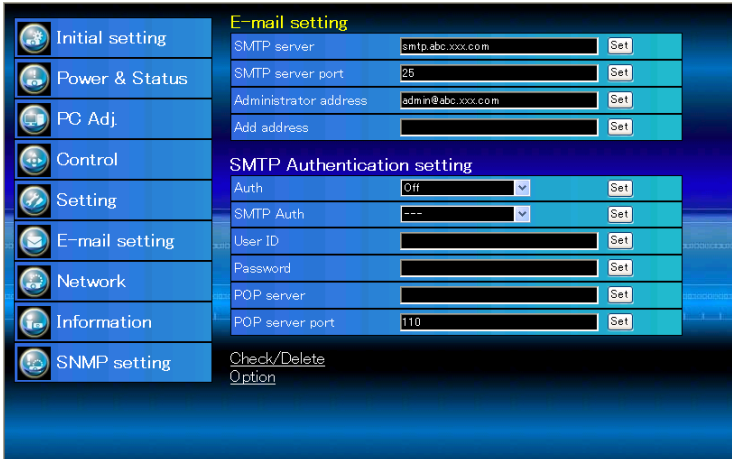

Item Description

SMTP server Enter server name or IP address of the SMTP server. (up to 60 characters)
 SMTP server port Enter Port number of the SMTP server. (from 1 to 65535)
 Administrator address..... Enter e-mail address of administrator.
 Add address..... Enter e-mail address of the user to send mail when the projector has an abnormality.

SMTP Authentication setting

Auth Sets authentication setting option. (Off, SMTP Auth, POP before SMTP)
 SMTP Auth Sets user authentication setting option when selecting "SMTP Auth" in above column. (CRAM-MD5, LOGIN, PLAIN)
 User ID Enter SMTP user ID. (up to 63 characters)
 Password Enter SMTP password. (up to 63 characters)
 POP server..... Enter server name or IP address of the POP server. (up to 60 characters)
 POP server port Enter Port number of the POP server. (from 1 to 65535)

1 Setting SMTP server and administrator address

Enter the server name or IP address of the SMTP server*, the port number of the SMTP server and administrator address and click **Set** button. The administrator address is set to "Reply-To" address of the message sent from the projector.

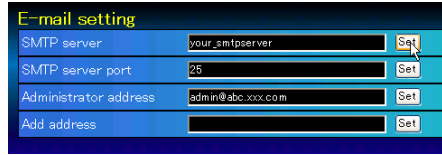

*1 The SMTP server is a server for sending e-mail. Please contact your network administrator to have this SMTP server address.

2 Registering and deleting E-mail addresses

Enter the e-mail address onto "Add e-mail address" and click **Set** button.

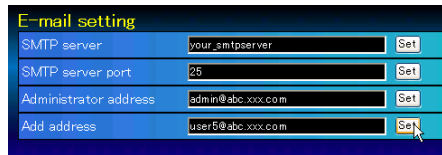

Check / Delete

To check the registered addresses, click **Check/Delete** sub menu tab. The addresses are listed as the figure on the right.



☛ Up to 10 E-mail addresses can be registered.

To delete the registered addresses, check the address you want to delete and click **Delete** button.

3 Setting SMTP authentication

Set the SMTP authentication concerned and click **Set** button. Please contact your network administrator in details.

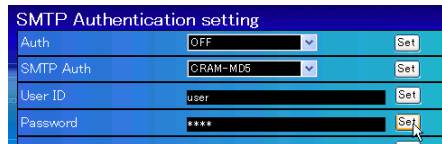

- ☛ If the projector sends an alert message due to the abnormality on the projector but the SMTP server is down in some other reason, the message will not be sent. In this case, the message "Unable to connect to server." will be displayed on the setting page. To clear this message, set up SMTP server address again.
- ☛ To use the E-Mail function, it must be set the DNS address on the Network setting page correctly.
- ☛ You cannot use this E-mail function if the DNS server and SMTP server cannot be used in your network environment.
- ☛ The projector does not send message to the address set in "Administrator address" text box. If you want to send e-mails to the administrator address, enter the administrator address into "Add address" text box.

4 Setting POP server

When "POP before SMTP" is selected at "Auth" of "SMTP Authentication setting", enter "POP server*2" and "POP server port" and click **Set** button.



*2 The POP server is a server for receiving e-mail.
Please contact your network administrator to have this POP server address.

Error message for sending alert mail

When the projector has an abnormality, an alert message will be sent to the registered E-mail address.

If the SMTP server is missing or the authentication is not completed because of input error in E-mail address setting or SMTP authentication setting when sending alert e-mail, the error message will be displayed. Please check the respective settings.

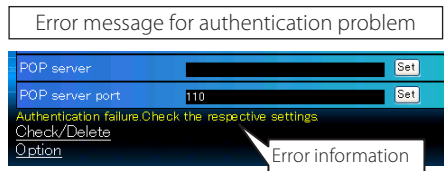
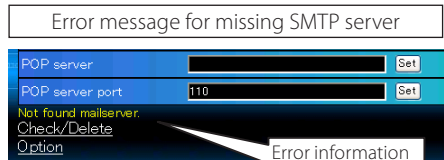

5 Option selection for sending alert mail

Click **Option** sub menu tab. Check the condition items under which alert mail will be sent and click **Set** button.

Please refer to item "Examples :Type and contents of alert mail" described on the next page.

Option

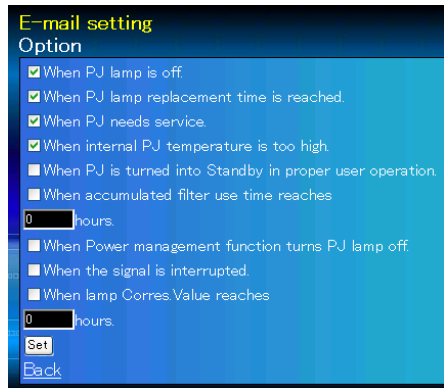

- "When PJ lamp is off" signifies the lamp goes out without user operation. "When PJ is turned into Standby in proper user operation" signifies that the projector is turned on by using the web browser and then it is turned into standby with ON/STANDBY button on the top control or the remote control.
- Up to 99,999 hours can be set for use time.

Examples: Type and contents of alert mail

When the projector has an abnormality, the following alert messages are sent to the registered E-mail address according to your selected condition. Administrator or user can take an efficient action quickly by receiving this message. This is very useful to maintain and service the projector.

The following are examples of received messages.

☛ **When internal PJ temperature is too high:**

TITLE: Message from projector
Projector Model Name: *model name*
TCP/IP: 192.168.1.201 Projector Name: Proj05

It sends you following message.

*The Projector lamp is turned off, because internal temperature goes over the safety limit. Wait for the completion of the cooling process and make sure the projector has been turned into Standby. Then turn the projector on again.
If the Indicator continues flashing, check the air filter for dust accumulation.

☛ **When PJ needs service:**

TITLE: Message from projector
Projector Model Name: *model name*
TCP/IP: 192.168.1.201 Projector Name: Proj05

It sends you following message.

*Maintenance requirement from Projector is detected.
Check up LED status of projector and consult with the dealer.

MCI	3.3V	OK	Error information
MAIN	ALL	NG	

- ☛ The projector lamp was turned off, because the projector power circuit failed. Unplug the AC power cord and plug it, and then turn on the projector once again to verify operation. If the problem still persists, unplug the AC power cord and ask servicing to a qualified service personnel with the error information.

☛ **When PJ lamp replacement time is reached:**

TITLE: Message from projector
Projector Model Name: *model name*
TCP/IP: 192.168.1.201 Projector Name: Proj05

It sends you following message.

*The projector lamp has reached replacement time.
Lamp ON 3000 h

- ☛ Replace it with a new lamp immediately and reset the lamp counter. If the projector is used without resetting the lamp counter, the alert mail is sent to users in every power-on of the projector. This alert mail will not be sent when unchecking the mail sending condition "When PJ lamp replacement time is reached".



SNMP setting

This projector provides a SNMP (Simple Network Management Protocol) agent function. The SNMP consists of a manager and agents. The group which communicates information each other with SNMP is called "Community". There are two access modes in a community, Refer (read only) and Set (read-write). This projector allows to use Refer (read only) only. The SNMP message informs the projector status called "Trap" to an administrator. Click **SNMP Setting** on the main menu and set up each item.

PJ information

Item	Description
Contact	Enter user name of the projector etc. (optional)
Place	Enter place of the projector (optional)
Community name(refer)	Enter community name (read only). Default name is "public".

Trap

Item	Description
Community name	Enter community name to send "Trap". Default name is "public".
Trap address	Enter IP address of the SNMP manager computer to receive "Trap".

Trap check/delete

Check and delete the trap address

Checking the registered trap address and deleting the address.

To delete the address, tick check box in front of the IP address and click **Delete** button.

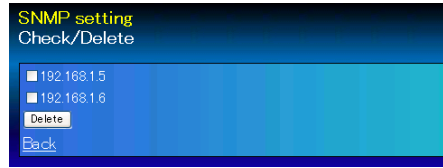

☞ Up to 10 trap addresses can be registered.

Trap option

Trap option setting

Tick check boxes in front of the condition item to send the trap.

☞ Click **Set** button if you tick or un-tick the check box on a page.

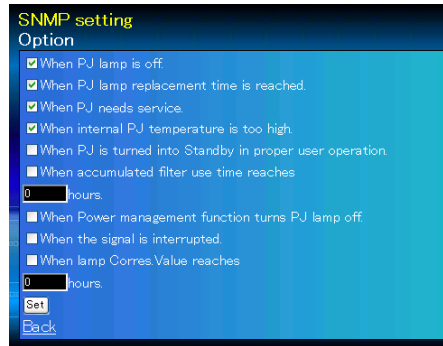

☞ "When PJ lamp is off" signifies the lamp goes out without user operation. "When PJ is turned into Standby in proper user operation" signifies that the projector is turned on by using the web browser and then it is turned into standby with ON/STANDBY button on the top control or the remote control.

☞ Up to 99,999 hours can be set for the time setting.

4

Chapter 4 *Controlling the Projector*

Describes controlling and setting of the projector by using the web browser.



Power control and status check

Click **Power & Status** on the main menu. The control page will be displayed.

By clicking **ON** or **Standby** button on the page, the power of the projector can be controlled.

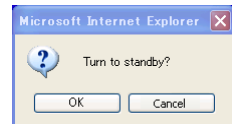
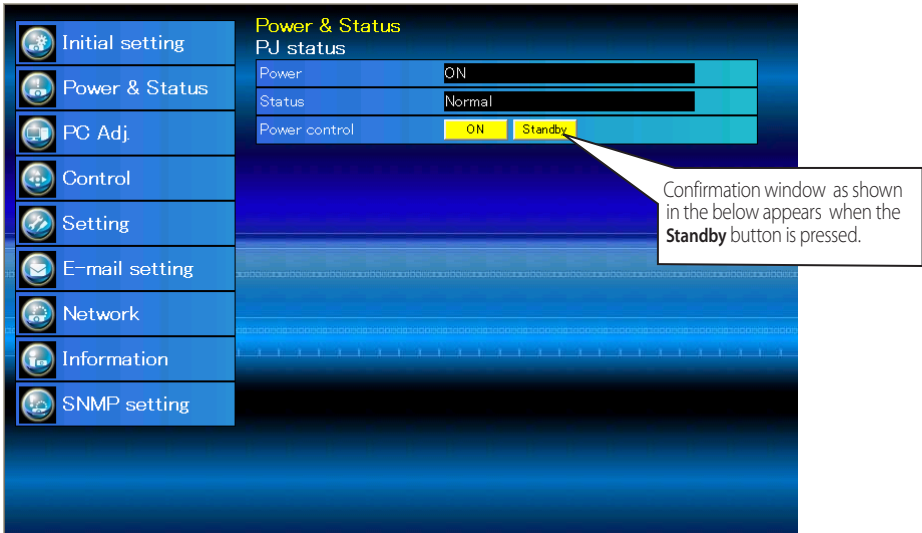

Popup confirmation window

Item	Description
------	-------------

PJ status

PowerDisplays the status of the lamp. (ON, OFF, On starting up, On cooling down, Service in need)

StatusDisplays the status of the projector's power. (Refer to next page.)

Power controlControls the projector power by clicking the "ON" or "Standby" button.

- ☛ The projector cannot be turned on while the projector is on cooling down.
- ☛ The web browser checks and updates the projector's condition every 30 seconds automatically.

About projector condition

Status	Description
Normal.....	Projector is operating normally.
Power management in operation.....	Power management is operating
Lamp failure.....	Lamp failure is occurring
Abnormal Temperature.....	The temperature of the projector became too high
Standby after Abnormal Temp.....	Projector detects abnormal temp. and sets into standby mode.
Power failure	Power failure has occurred inside the projector. Projector is turned off. Unplug the AC cord and ask servicing to a qualified service personnel.

When a security (PIN code lock) has been set on the projector, you also cannot control it through the network. To control the projector through the network, unlock the security on the projector using with the projector's menu control.

Caution about turning on/off the projector via the networks

When turning on/off the projector via the networks, preset the projector as follows:

1. Select "Setting" from the Projector menu.
2. Select "Standby mode" from the Setting menu and set it as "Network".

If you set this function as "Network", the network part of the projector is constantly provided with power even if the projector is turned off. If you set this as Eco, then the network part will be turned off when you turn off the projector. Consequently, you cannot turn on/off the projector via the networks.



Control

Click **Control** on the main menu. The setting method differs depending on the contents of the page. Click on the page number to change pages and select desired setting items.

☛ **Please see the owner's manual of the projector to have the further information of each control item.**



Input

This function is to select the input mode and source mode of the projector. Click **Set** button after selecting the input and source mode.

Item	Description
Input.....	Selects input mode of the projector.
Source.....	Selects signal source of the input.
	Computer1 : RGB Component RGB(Scart) S-video
	Computer2 : RGB
	Video

☛ The control page displays valid control items depending on the selected input mode, signal or functions of the projector you use, therefore, there may be different controls between the described items and actual control items on the page display. For further information , refer to the projector's owner's manual.

☛ When the projector is in standby, all the controlling items are inactive.

System

This function is to select the system of signal input to the projector. The available system mode are listed on the pull-down menu button according to the input signal. Select a system and then click **Set** button.

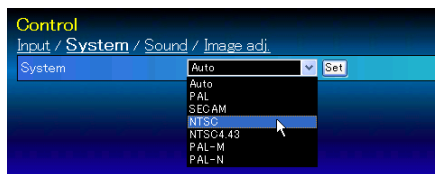

Available selection at the RGB input

Item	Description
XGA1	It automatically switches to the proper computer system of the input signal. * The computer system modes (VGA, SVGA, XGA, SXGA, UXGA, WXGA...) which meet the input signal are listed.

Available selection at the Video/S-video/Scart input

Item	Description
AUTO.....	It automatically switches to the proper color system of the input signal. * The selectable color systems are PAL, SECAM, NTSC, NTSC4.43, PAL-M and PAL-N. * AUTO is fixed at the Scart input.

Available selection at the Component input

Item	Description
AUTO.....	It automatically switches to the proper scanning system of the input signal. * The selectable scanning systems are 480i, 576i, 480p, 576p, 720p, 1035i and 1080i.

☛ If the mode (Mode1 to Mode10) which is stored in the item "PC Adjustment" (☛ p.38) is available, they are also listed together with the above mode.

Sound

This function is to adjust the sound of the projector. The values in the text box represent the current control value or status.

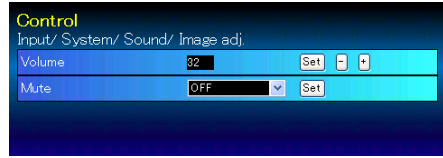

Item	Description
Volume	Adjusts the sound volume from the speaker. (0 ~ 63)
Mute	Suppresses the sound. (ON, OFF)

☛ The MIC functions **MIC**, **MIC gain**, **Standby MIC out** cannot be selected through the network. When using the MIC functions, please set by using the On Screen Menu of the projector.

Image adjustment

This function is to adjust the projected picture image and save the image mode. To store the adjusted value, click **Store** button, and to load the adjusted value, click **Load** button.

Item	Description
Contrast	Adjusts picture contrast (0~ 63)
Brightness	Adjusts picture brightness (0~ 63)
Color	Adjusts picture color saturation (0~ 63)
Tint	Adjusts picture hue (0~ 63)
Iris	Switches iris mode. (ON, OFF)
Color temp.	Sets a color temperature mode. (High, Mid, Low, XLow, User)
White balance	
Red, Green, Blue	Adjusts each white balance respectively. (0~ 63)
	* When changing the value of the white balance, the color temp. indicates "User".
Sharpness	Adjusts picture sharpness. (0~ 15)
Gamma	Adjusts brightness of darker part of the picture. (0~ 15)
Noise reduction	Switches noise reduction mode (OFF, L1, L2)
Progressive	Switches progressive mode (OFF, L1, L2, Film)
Reset	Resets the Image adjustment to previous levels.
Store	Stores the Image adjustment values. Select an item [Image1 - Image4] from the pull-down menu and click Store button.
Load image mode	Loads the Image mode. Select an image mode from the pull-down menu and click Load button. {Dynamic, Standard, Real, Cinema, Blackboard(Green), Colorboard, Image1 - Image4}





PC adjustment

Click **PC Adj.** on the main menu. This function is to adjust the signal from the computer connected to the projector to obtain the proper picture image on the screen.



Item	Description
Current mode.....	Displays a current mode like VGA, SVGA, XGA, SXGA, UXGA, WXGA, etc. or Mode1 - Mode10 which are the customized mode created by using the "Mode Store" function described below.
Auto PC adj.....	Performs automatic adjustment.
Fine sync	Performs Fine Sync adjustment. (0 ~ 31)
Total dots	Adjust the number of total dots in the horizontal period.
Clamp.....	Adjusts the phase of the clamp.
Display area	
Horizontal.....	Adjusts the image area horizontally.
Vertical.....	Adjusts the image area vertically.
Position	
Horizontal.....	Adjusts the horizontal position of the screen.
Vertical.....	Adjusts the vertical position of the screen.
Reset.....	Resets the PC adjustments to the previous levels.
Mode Store.....	Stores the PC adjustment values. Select a mode no. [Mode1 - Mode10] from the pull-down menu.
Mode Free	Clear the PC adjustment values. Select a mode no. [Mode1 - Mode10] from the pull-down menu.



Setting up the projector

Click **Setting** on the main menu. This function is to set up the projector. Select the sub menu [Screen setting] or [Setting] and then set up each setting.



Screen setting

This function is to adjust the screen mode of the projector. The values in the text box represent the current screen status.

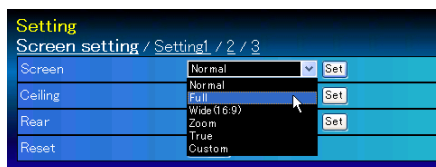

Item	Description
Screen	Switches the screen mode. (Normal, Full, Wide(16:9), Zoom, True, Custom) There may not be available mode depending on the input mode as shown in the table below.
Ceiling	Sets the image top/bottom and left/right reversed. (ON, OFF)
Rear	Sets the image left/right reversed. (ON, OFF)
Reset	Resets the Screen settings.

Input source	Screen mode	
	Video	Computer
Normal	✓	✓
Full	✓	✓
Wide(16:9)	✓	✓
Zoom	✓	✓
True	*	✓
Custom	✓	✓

☞ The mark "✓" means that the available screen mode in the selected input source system. The error message appears when selecting the disabled screen mode indicated with "*".

Setting 1

Item	Description
Language.....	Sets the language display of projector's on-screen display menu.
Auto setup.....	Executes the Auto PC Adj, Input Search and Auto keystone function below according to the each setting after clicking Start button.
Auto PC Adj.....	Sets Auto PC Adjustment mode. (ON, OFF)
Input search.....	Sets the auto-input signal detection mode. (ON1, ON2, OFF)
Auto keystone.....	Sets Auto Keystone mode. (Auto, Manual, OFF)
Background.....	Sets the screen background when no signal input. (Blue, User, Black)
Display.....	Switches on or off the on-screen menu display on the screen. (ON, OFF)
Logo.....	Sets on or off the logo display on the screen during the startup. (OFF, Default, User)

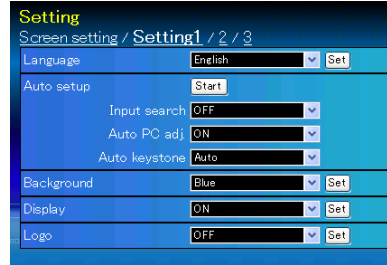

Setting 2

Item	Description
Terminal.....	Sets the COMPUTER IN 2/MONITOR OUT terminal. (Computer2, Monitor out)
Power management.....	Sets into the selected power management mode (Ready, Shutdown, OFF) if the input signal is interrupted and no control key is pressed for the specified period of time. *The specified time can be set 1 to 30 min.
Direct on.....	Sets the power-on mode when the AC cord is connected to the outlet. (ON, OFF)
Lamp control.....	Selects lamp control mode. (High, Normal, Eco)
Key lock.....	Sets the prohibition of controls either Projector or Remote control. (OFF, Projector keys, Remote control)
Fan control.....	Sets the fan control speed. OFF Normal mode ON1 Highland mode 1 ON2 Highland mode 2
Lamp Corres. Value(h).....	Displays the lamp use time (Corresponding value) . Reset the time after lamp replacement. Click "Reset", a confirmation display appears, and then click "OK", the time will be reset.



Setting 3

Item	Description
Filter counter	Displays the filter counter. Reset the time after filter replacement. Click "Reset", a confirmation display appears, and then click "OK", the time will be reset.
Filter warning	Sets the time to indicate the filter warning message on the screen. (OFF, 2000H, 3000H, 4000H)
Factory default	Sets all of the projector control items to the factory default setting except the following items. User Logo, Logo PIN code lock, PIN code lock, Lamp Corres. Value, Filter counter, PJ time * This function is effective for all the Network settings.
No show	Sets the black out image temporarily. (ON, OFF)
Freeze	Sets the image to freeze mode. (ON, OFF)
Closed caption ...	Sets the closed caption function.
Closed caption....	Sets the closed caption mode. (OFF, CC1, CC2, CC3, CC4)
Color	Sets the color of the contents. (Color, White)

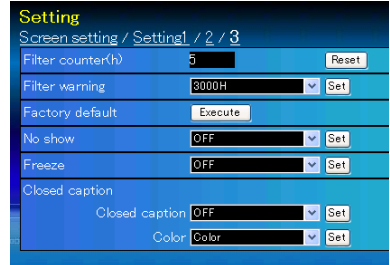



Information

This page is to display the basic information of the projector status. Click **Information** on the main menu.

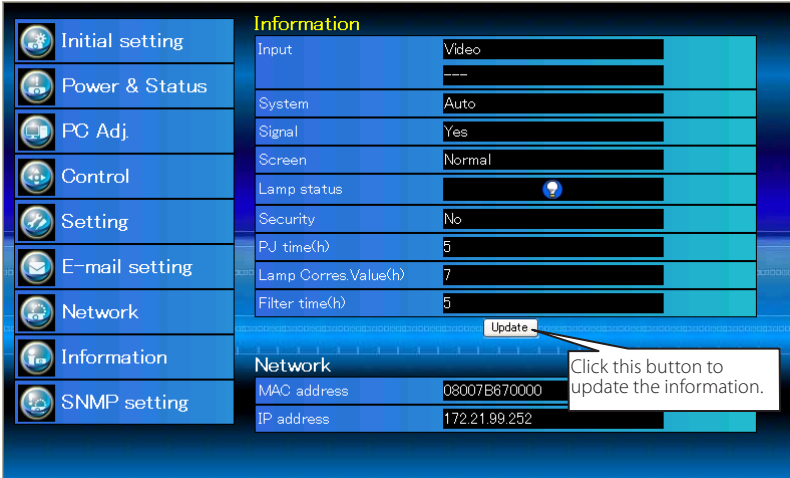







Information

Items	Description
Input	Displays selected input and source.
System	Displays selected signal system.
Signal	Input signal status (Yes, No)
Screen	Displays screen mode.
Lamp status	Displays lamp status with an icon. Refer to the table on the next page.
Security	Displays the security (PIN code lock) status (Yes, No)
PJ time(h)	Displays the accumulated use time of the projector.
Lamp Corres. Value(h)	Displays the use time (Corresponding value) of the lamp.
Filter time(h)	Displays the accumulated use time of the filter.

Network

Items	Description
MAC address	Displays MAC address of the projector.
IP address	Displays the IP address of the projector.

Indication of the lamp status

Icon display/background	Status
 White/Blue	Lamp on (Normal)
 White/Red	Lamp on (Lamp is being used over a specified use time, replace lamp immediately)
 Gray/Blue	Lamp off (Normal)
 Gray/Red	Lamp off (Lamp is being used over a specified use time, replace lamp immediately)
 Red/Blue with X	Lamp failure (Lamp failure, check lamp condition)
 Red/Red with X	Lamp failure (Lamp failure and lamp is being used over a specified use time, replace lamp immediately)

5

Chapter 5 *Appendix*

Connection examples

Use of telnet

Web browser setting

Q & A

Examples of connection

Peer-To-Peer connection

Connecting the projector (PJ01) to the control computer (PC05) directly.

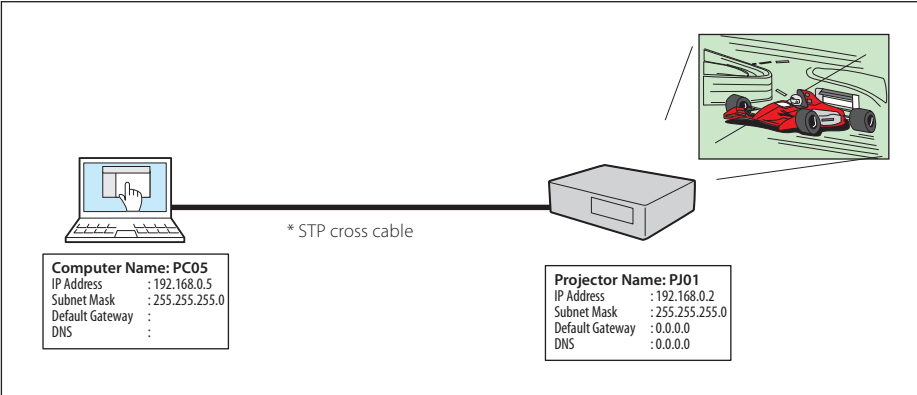

Connecting the projector (PJ01) to the control computer (PC05) via the hub.

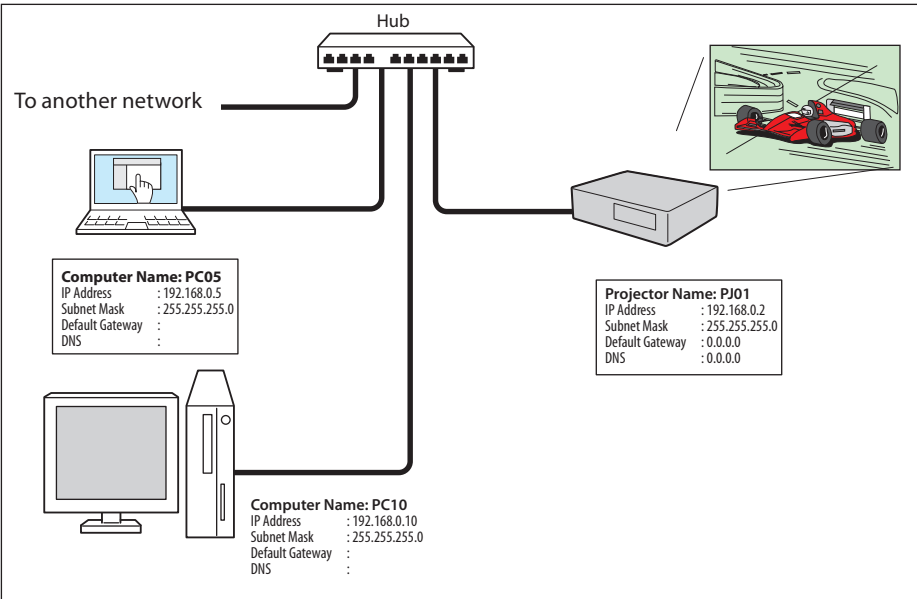

When the projector is connected to the computer directly without hub, the STP cross cable should be used.

The gateway (Router) installed in the network

Connecting the projector (PJ01) to the control computer (PC05) via the gateway.

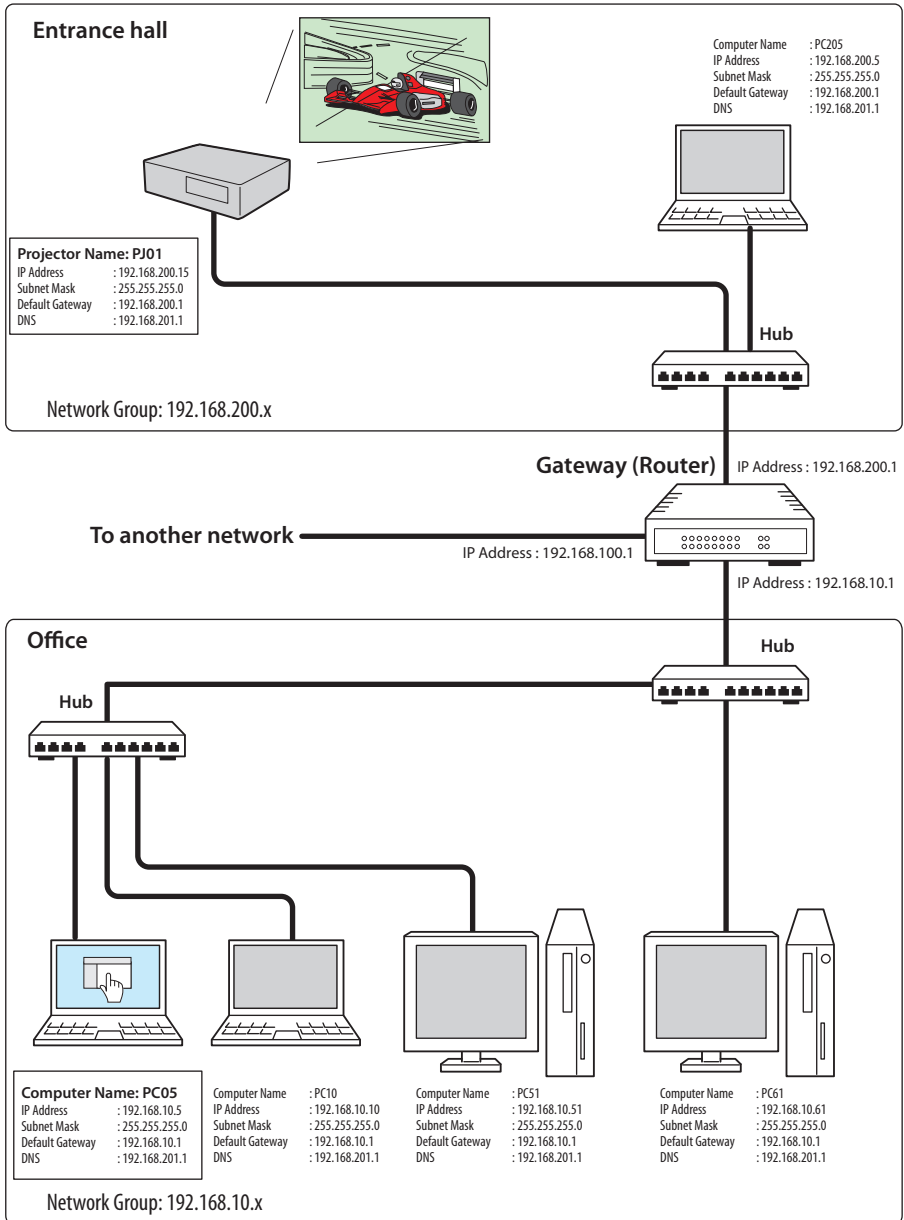

Use of telnet

You can control the projector by using the telnet application¹ installed on your computer. Normally, the telnet application is available on your computer.

* The telnet 10000 port is used to control the projector.

Control

(For example, in case of using the telnet application of **Windows XP Professional**.)

1. Select **Run...** submenu from **Start** menu on the computer. Type "telnet" onto the **Open** text area on the displayed window and press **OK** button.

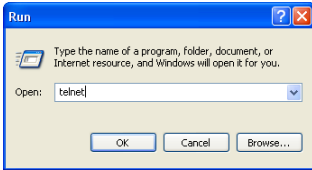

(For example, in case of using the telnet application of **Mac OS X v 10.4**)

1. Select **Terminal** from **Applications** --> **Utilities**.

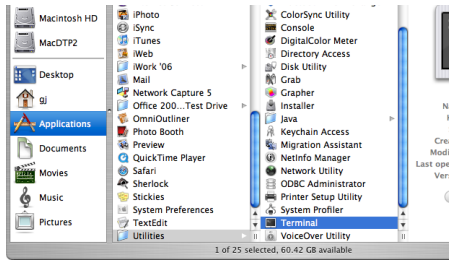

Type as below on the displayed window.
> telnet [return]

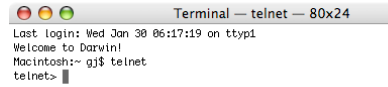

2. The telnet application will start and the following window will be displayed. Type as below to connect the projector.

> open 192.168.1.201 10000 [return]

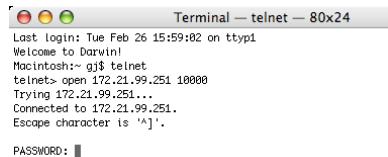
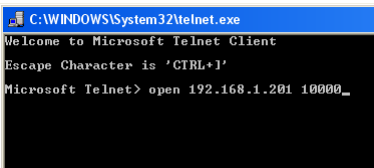

* Use the IP address assigned to the projector.

3. When communication is established correctly, the word "PASSWORD:" appears on the window. Type the login password (Network PIN code²) for the projector and then press "Enter" key on the keyboard. If you do not set up the Network PIN code, just press "Enter" key.

When the word "Hello" is replied, login has been succeeded.

* The password "1234" is used for the example.

```
Telnet 192.168.1.201
PASSWORD: 1*2*3*4*
Hello
```

```
Terminal — telnet — 80x24
Last login: Tue Feb 26 16:03:39 on ttty1
Welcome to Darwin!
Macintosh:~ gjs$ telnet
telnet> open 172.21.99.251 10000
Trying 172.21.99.251...
Connected to 172.21.99.251.
Escape character is '^\''.

PASSWORD: 1234

Hello
```

4. Type the commands, refer to below table, to control the projector and then press "Enter" key for termination. For example, type "C00" which is a command to turn on the projector, and press "Enter" key. Confirm the projector is turning on.
- * Enter with ASCII 64-byte capital characters and one-byte characters.

To disconnect the communication, press "Ctrl" key and "]" key at the same time, type "close" and then press "Enter" key on the Keyboard.

> close [return]

The table below shows the typical command lists for controlling this projector and please consult your local dealer for further information of another commands.

Command list table

Command	Function
C00	Turns the projector on
C01	Shut downs the projector directly
C02	Turns the projector off
C09	Volume up
C0A	Volume down
C0B	Audio Mute on
C0C	Audio Mute off
C1C	Menu display on
C1D	Menu display off

*1 Further instructions about the telnet application, please see the on-line guide on your computer.

*2 The password is a Network PIN code decided item "Network PIN code setting" (pp.14, 23). If the authentication of the entered password is failed 4 times continuously, the communication will be disconnected automatically. Please try again for the connection.

• If the password or any command is not entered for more than 30 seconds, the communication will be disconnected automatically. Please try again for the connection.

Web browser setting

This projector is designed to be set up and controlled from an Internet web browser. Depending on the preference settings of the web browser, some control functions may not be available. Please make sure that the following functions are set up properly in the web browser.

Active Script/JavaScript enable

There are some control items used with the JavaScript function in the setting pages. If the web browser is set not to use this JavaScript function, it may not control the projector properly. In this case, the warning message "Make sure JavaScript is ON." will be displayed on the top of the page. To enable the JavaScript, please see further instructions on the next page.

Proxy setting

In some cases, your web browser is set up to use the proxy server for the internet or intranet connection. In this case, when you install this projector into the local network, you should set up the proxy setting of web browser preference correctly. Especially when connecting the projector and computer with a STP cross cable directly, or when the network does not provide the proxy server, make sure that "not use proxy server" is set up in your web browser preference. Please see item "Examples: OS/Browsers" in the next page for further setting up procedure.

☛ There are various ways to change your browser preferences depending on the version or applications. Please see the setting instructions on next page for example and also refer to on-line help of your web browser.

Examples: OS/Browsers

Windows XP Professional

Internet Explorer v.6.0

ActiveScript setting

Select **Internet Options** from **Tools** menu on the web browser and then select **Security** tab and click **Customize Level...** button. On the security setting window, scroll down and find the **Scripting** item, make sure that "Enable" is selected in item **Active Scripting**.

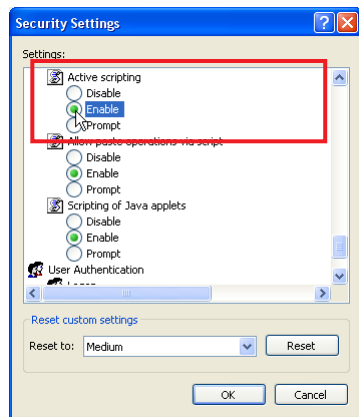
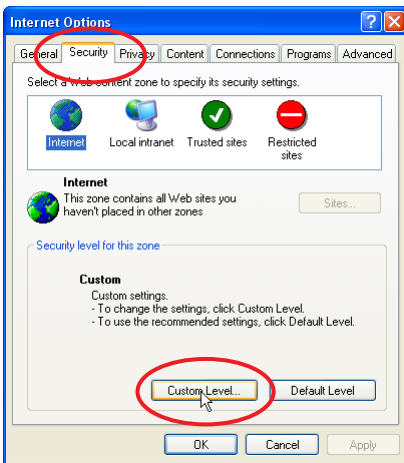

Proxy setting

Select **Internet Options** from **Tools** menu on the web browser and then select **Connection** tab and click **LAN Settings** button. Properly set up your web browser's the proxy server settings according to the local area network environment to which the projector is connected.

- Using proxy server

To use an external internet connection from the local area network, check the item **Use a proxy server** and enter the proxy server address and port correctly in the proxy settings window. For further instruction please consult your network administrator.

- Not using proxy server

Uncheck the item **Use a proxy server**.

If you connect the projector to the computer directly with STP cross cable, this must be unchecked.

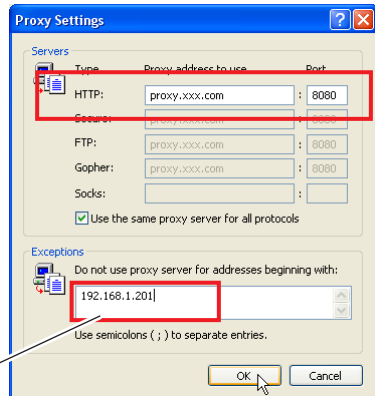
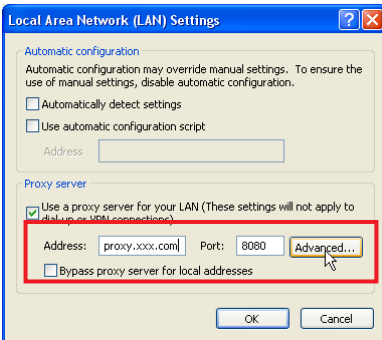

To designate proxy settings that will not use the proxy server when accessing the projector installed in the local area network, enter the IP address or domain name here.

Netscape Navigator v.7.1

JavaScript Setting

Select **Preference** from **Edit** menu on the web browser and then select the item **Advanced/Scripts & Plugins** in the **Category** column. Make sure that the **Enable JavaScript for Navigator** is checked.

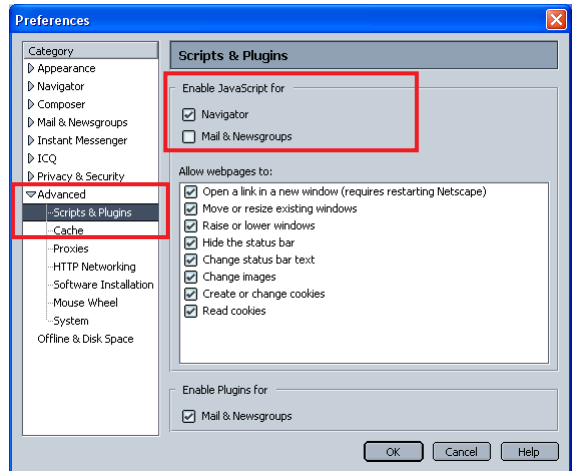

Proxy setting

Select **Preference** from **Edit** menu on the web browser and then select the item **Advanced/Proxies** in the **Category** column. Properly set up your web browser's the proxy server settings according to the local area network environment to which the projector is connected.

- Using proxy server

When you use an external internet connection from the local area network, select the item **Manual proxy configuration**. Enter the proxy server address and port number correctly on **HTTP Proxy** item. For further instruction please consult your network administrator.

- Not using proxy server

Select the item **Direct connection to the Internet** in the proxy setting window. If you connect the projector to the computer directly with STP cross cable, this must be selected.

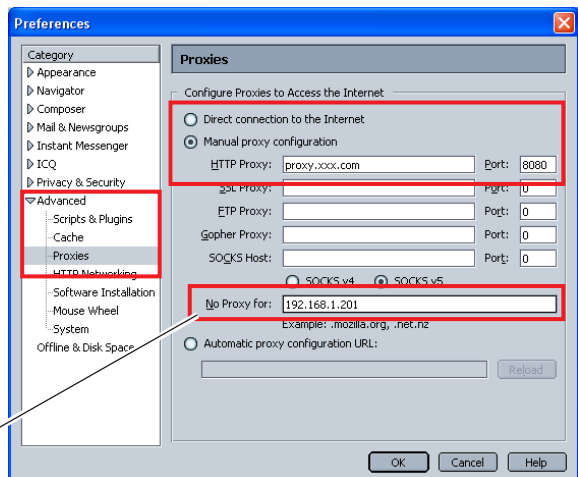

To designate proxy settings that will not use the proxy server when accessing the projector installed in the local area network, enter the IP address or domain name here.

MAC OS X v 10.4

Safari v.3.2.1

JavaScript enable setting

Select **Preferences...** from **Safari** on the web browser and then select **Security** tab and check **Enable JavaScript**.

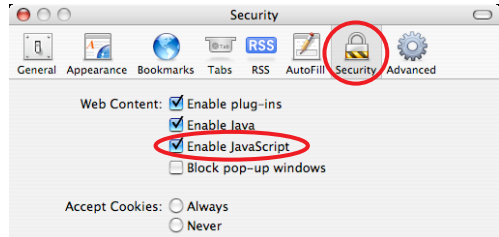

Proxy setting

1 Open **Preferences...** from **Safari** menu on the web browser **Safari**. The preference menu appears.

2 Select **Advanced** icon and then click **Proxies: Change Settings ...**

3 Select **Proxies** tab and properly set up your web browser **Safari**'s the proxy server settings according to the local area network environment to which the projector is connected.

- Using proxy server

To use an external internet connection from the local area network, check the items **Web Proxy (HTTP)** and **Secure Web Proxy (HTTPS)** of **Select a proxy server to configure** window and enter the proxy server address and port correctly in **Web Proxy Server** window. For further instruction please consult your network administrator.

- Not using proxy server

Uncheck the items **Web Proxy (HTTP)** and **Secure Web Proxy (HTTPS)** of **Select a proxy server to configure**.

If you connect the projector to the computer directly with STP cross cable, they must be unchecked.

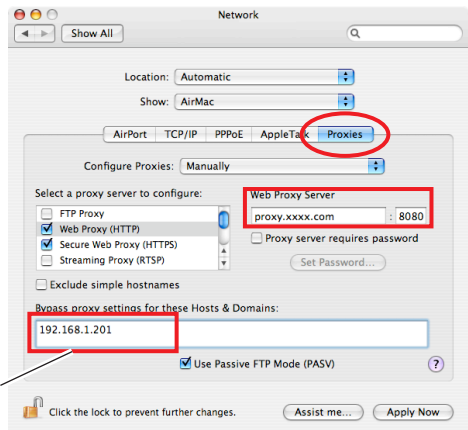
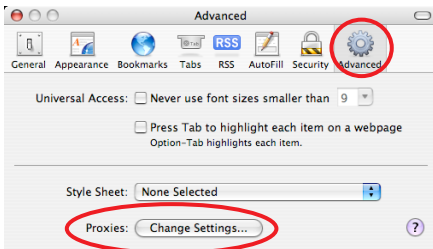

To designate proxy settings that will not use the proxy server when accessing the projector installed in the local area network, enter the IP address or domain name here.

Q&A

Installation/Access

Q *Why doesn't the setting page appear in my web browser?*

A Following causes are possible. Please check them.

1. The projector does not connect to the network.
Check LED indicators status (☛ p.12).
 - Check the connection of LAN cable if the LINK Lamp does not light green.
 - Check the network configuration of the projector if the ACT Lamp does not blink orange.
2. Wrong network configuration of the computer.
Check the network configuration of the computer.
3. The proxy setting of the web browser is not set correctly (☛ p.52).
4. The computer does not provide TCP/IP protocol.

Q *How can I restrict access from the computer.*

- A**
1. Please use the password authentication function on the login page (☛ p.23).
 2. Please use the IP filtering function provided with the gateway (router) to restrict the accessing from the computer. For further information please consult your network administrator.

Q *Can I access the projector installed on the company's local area network from a remote location?*

A There are some ways to access to the projector in the LAN, but you must consult your network administrator for security reason.

- ☛ Use of modem
(Connect to the company's network from your home or some other places by using modem.)
- ☛ Use of private line
(Connect to the company's network from the branch office or maintenance office by using private line.)
- ☛ Use of internet
(Connect to the company's network from your home, branch office or some other places by using the internet.)

Q *We use the DHCP/BOOTP server to assign the IP address. Is it possible to use the projector in this network environment?*

A Possible. This projector supports the DHCP/BOOTP server. To use this projector in this network environment, set it up so that the DHCP/BOOTP server does not assign the IP address configured to this projector for another device on the network. Please consult your network administrator (☞ pp.13, 24).

Q *How can I install several projectors?*

A Install and configure network one by one to avoid the IP address collision each other. To configure the IP address please see item "Network configuration" (☞ pp.12-13, 24).

Password/Login

Q *What should I do when I forget the IP address of the projector?*

A You can check the IP address in the "Network information" menu.

Q *What should I do when I forget the password (Network PIN code)?*

A Please set the new network PIN code in the "Network PIN code" menu.

Q *Can I register the setting page as a web browser "Favorites" or "Bookmarks"?*

A Please add "Login" page to your "Favorites" or "Bookmarks". Do not add the specified setting page because it will not be able to perform the password authentication correctly.

Operation

Q *Why can't be turned on/off with web browser?*

A Please make sure the settings of the projector are correct to use the projector. Please set the **Standby mode** of the projector's **Setting menu** to "**Network**". Refer to "4. Controlling the Projector" ➤ "Power control and status check" (➤ pp.32 - 33).

Q *Why can't I change the controls in the setting page with web browser?*

A Please make sure the projector is turned on. If it is in the standby mode, the setting is not effective to the projector. To control the projector with a web browser, the projector must be in the powered-on condition.

Q *Why does it sometimes take a lot of time to complete the page display?*

A The display speed of the page depends on the network environment in which both the projector and computer are placed. It may take much time to complete the page display if network traffic is heavy. Please consult your network administrator.

Q *How many numbers of the E-mail address can I register in the E-mail setting page.*

A You can register up to 10 addresses.

Q *Why am I not receiving E-mail alert messages?*

A Make sure that the registered E-mail address and SMTP server address are correct. If the SMTP server is located in your LAN (Local Area Network), the address should be set to the SMTP server in your LAN. The SMTP server located outside of your LAN may not be available for security reason. For further information please contact your network administrator (➤ p.25).

Others

Q *What are the rules for IP address assignment?*

A If the network is constructed with TCP/IP protocol, a unique IP address is required for each piece of network equipment. The following are basic rules of the assignment.

Rule1

Do not configure the same IP address to the network equipment in the same network group. Each piece of equipment must be assigned a unique IP address.

If the IP address is set [192.168.x.x], the Subnet Mask should be set [255.255.255.0] for example.

Rule2

The start address [xxx.xxx.xxx.0] and the last address [xxx.xxx.xxx.255] of the IP address must not be assigned to any other equipment. These address numbers are reserved.

Rule3

The IP address must correlate to a network number. If network numbers are different between the equipment, they cannot establish communications each other. In this case, the router is placed in the networks to make the routing.

Q *Can I control the projector by using the telnet application?*

A Possible. Please refer to the item "Use of telnet" (☞ p.48 - 49).

Q *What is the MAC address assigned to the projector?*

A The MAC address is displayed in "Network information" menu of the projector (☞ p.14) and in "Information" menu through the web browser (☞ p.42).

Q *Can I update the firmware of the projector.*

A It is possible to update the firmware through the network. It is required to have a special tool for the updating. For further information please consult your local dealer. The version number of the firmware is indicated on the lower part of the "Initial setting" page.

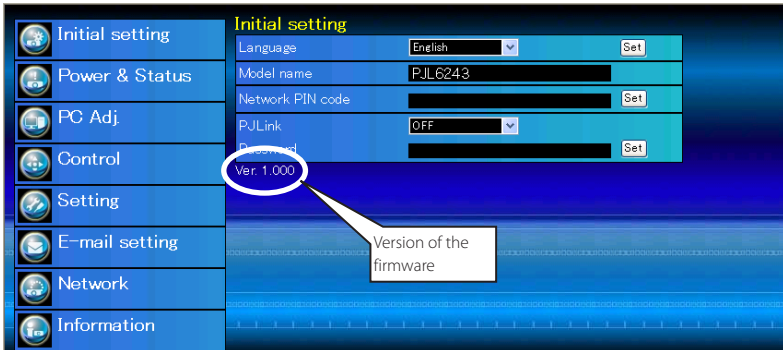

PJ Network Manager for Windows

Contents

Contents	2
Chapter 1 Introducing	3
Introducing.....	3
SNMP	3
Trademarks.....	3
Operating Environment.....	4
Chapter 2 Set up	5
PJ Network Manager installation.....	6
PJ Network Manager un-installation.....	6
Chapter 3 Basic Operation	7
Launching and quitting PJ Network Manager.....	8
Name of status window.....	8
Quitting PJ Network Manager.....	9
Menu tree	9
What's Target.....	9
Name of the button on the tool bar.....	10
Icon display for the target.....	10
Addition of the target	11
Editing the target.....	11
Deletion of the target.....	11
Setting up the warning value	12
Starting target monitoring.....	12
When happens the alert on the target.....	13
When happens the trap event on the target.....	13
What's Trap.....	13
Stopping monitoring the target.....	14
Displaying all the status information of the target.....	14
Setting the target group	14
Setting up the password of Telnet.....	15
Setting commands batch processing for multiple targets.....	15
Setting timer for targets.....	16
Setting up default setting.....	17
Customizing the status list.....	19
Viewing the alert information.....	22
Viewing the event log.....	23
Description of Event, Type, Warning column, Warning value	24
About event treatment.....	26
Viewing the command history.....	27
Storing the management file.....	28
Information saved to the registry	28
Registering the target information from the defined file at once.....	29
Format of the defined file.....	30
Example of the defined file.....	30
Login to the target equipment	31

Chapter 1 Introducing

Introducing

This PJ Network Manager is a SNMP manager software for the network equipment which supports the private MIB (Management Information Base).

By installing the PJ Network Manager to the computer, you can monitor the equipment simply such as the projector, the projection monitor and the flat display monitor connected to the network.

* The PJ Network Manager can handle our products which has a SNMP agent function.

SNMP

SNMP is an abbreviation for Simple Network Management Protocol.

On the TCP/IP network, it is the protocol to monitor and control the equipment connected to the network.

SNMP realizes the management function by reading and changing the management information called MIB with SNMP protocol between the manager (management equipment) and agent (controlled equipment) which are connected with TCP/IP network.

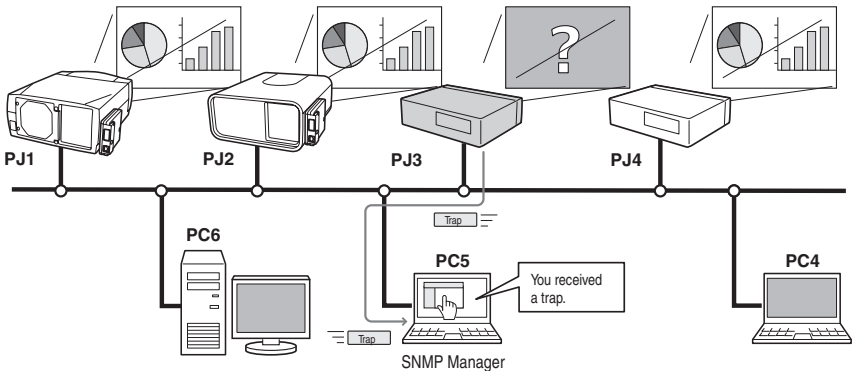

Trademarks

Microsoft, Windows, Windows 2000, Windows XP, Windows Vista, and Windows 7 are registered trademarks of Microsoft Corporation. Macintosh is a registered trademark of Apple, Inc. in the USA and other countries. Other products or brand names in this manual are registered trademarks or trademarks of their respective owners.

* Unauthorized use of a part or whole of the contents in this manual is prohibited.

* The contents of this manual are subject to change without notice.

Operating Environment

Item	Minimum	Recommended
CPU	Pentium III 400MHz or higher	Pentium 4 2.0GHz or higher for Windows XP Pentium 4 3.0GHz or higher for Windows Vista and Windows 7
Memory	128MB or higher	256MB or higher for Windows XP 1GB or higher for Windows Vista and Windows 7
HDD	More than 20MB of free disk space	
Screen resolution	SVGA (16 colors or more)	XGA True color or more
LAN	10Mbps or more	100Mbps or more
OS	Windows 2000 Windows XP Windows Vista Windows 7	Windows XP Professional Windows Vista (32bit version) Windows 7 (32bit version)

Limited condition

The number of agents monitored is up to 200.

Expression/Abbreviation

The OS of the computer and the Web browser described in this manual is Windows XP Professional and Internet Explorer 6.0. In case of another OS or Web browser, some instruction procedures may differ from the actual operation depending on your computer environment.

Use of this manual

This manual does not provide the description of basic operation and functions for computer, web browser, projector and network. For instructions about each piece of equipment or application software, please refer to the respective manual.

Chapter 2
Set up

2

PJ Network Manager installation

- 1 Set the supplied CD-ROM into the CD-ROM drive of your computer. Double click **SetupTool.exe** icon in the "PJ Network Manager" folder in the CD-ROM.
- 2 Select "[English [United States]]" from the pull-down menu on the "Choose Setup Language" window and click **OK** button to start installing and then follow the installation wizards.

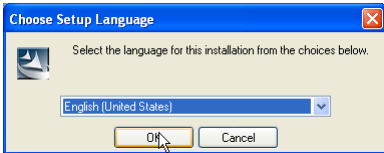
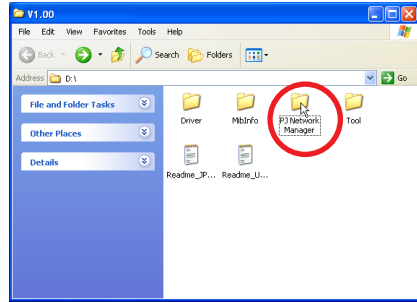

As the "Software License Agreement" will appear, read contents carefully and click **Yes** button if you agree with the license agreement to proceed with installing.

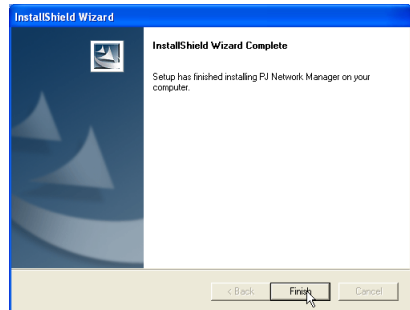
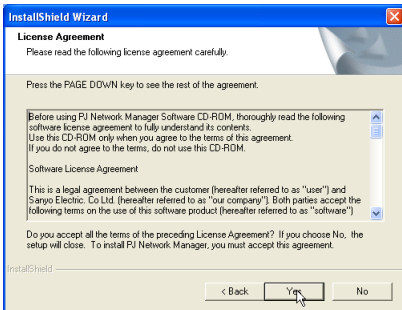
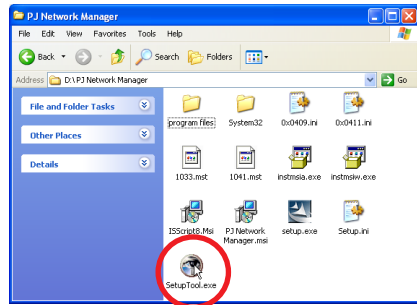

Note:

To install the software into the computer with Windows 2000, Windows XP, Windows Vista, or Windows 7 you should login as administrator. Before installation, make sure that the other applications are closed, otherwise proper installation cannot be made.

PJ Network Manager un-installation

To remove the PJ Network Manager software from your computer, perform it with "Add & Remove Programs" on the control panel. (In case of Windows Vista or Windows 7, use "Programs and Features" from the control panel.)

Chapter 3
Basic Operation

3

Launching and quitting PJ Network Manager

To launch PJ Network Manager, take one of the following.

- Select "PJ Network Manager" from the menu "Start" - "All programs".
- Double click a management file*1.

Name of status window

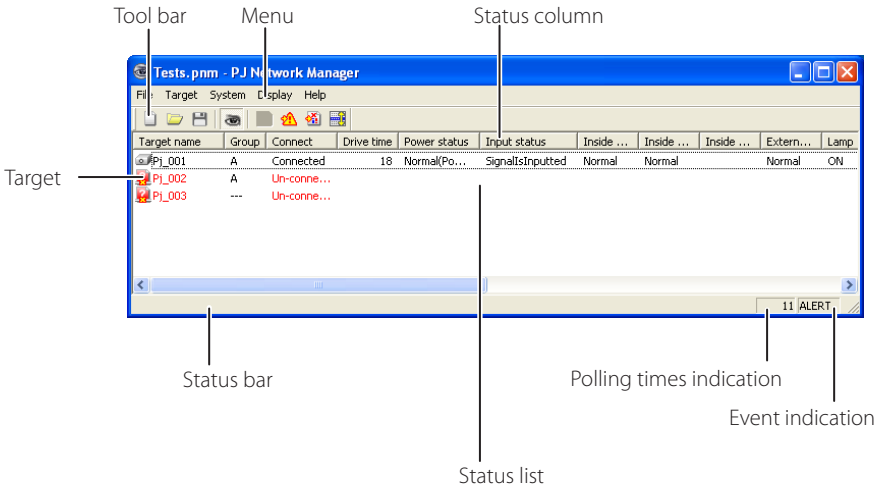

* With double clicking the target name, the web browser is launching and displays login window of the target.(+p.31)

Items	Description
Menu.....	Executes a command with menu selection
Tool bar	Executes a command assigned to a button.
Target	Network equipment for monitoring.
Status bar.....	Indicates the status of PJ Network Manager and explaining the command selected with cursor.
Status list.....	Indicates the status of targets monitoring. When some errors are detected, the target name, icon and error items are indicated with red.
Status column	Column of status list.
Polling times indication	Indicates the times of polling during the monitoring.
Event indication	Indicates the event (ALERT, TRAP, SYSERR) when the event happened.

*1 The file in which the Monitor target information and event log information are stored. Refer to item "Storing the management file" (+p.28) for further details.

[Note]

*** The PJ Network Manager cannot open multiple status windows at the same time.**

Quitting PJ Network Manager

To quit the PJ Network Manager, click the close box on top right of the status window, or select "Exit" from the "File" menu

Menu tree

Menu	Sub menu	Operation
File	New	Creates a new management file.
	Open	Opens an existing management file.
	Save	Saves the active management file.
	Save As	Saves the active management file with a new file name.
	Exit	Quits the application.
Target	Target monitoring	Starts or stops target monitoring.
	Target addition	Adds a new target. Target information window will appear.
	Target editing	Edits selected target information.
	Target deletion	Deletes the selected target.
	Group setting	Groups the selected targets.
	Warning value setting	Sets up the warning value of the selected target.
	Telnet setting	Sets up the password of telnet.
	Commands batch processing	Sets commands batch processing for multiple selected targets.
Timer setting	Sets up the timer for the selected target.	
System	Target batch registration	Imports target information defined with the external file.
	System default setting	Sets up the default setting (monitoring information, e-mail information).
	Column selection	Selects display items on the status list.
	Font setting	Sets up display font type and size on the status list.
Display	Update	Updates the information on the status list display.
	Target display	Displays selected target information.
	Alert display	Displays all of alert information on the status list.
	Event log display	Displays all the event logs.
	Command history display	Displays all of command history.
	Tool bar	Switches tool bar on or off.
Help	Version information	Displays version of software.

What's Target

Target indicates the network equipment which provides an SNMP agent function .

Name of the button on the tool bar

The following commands are assigned to the buttons on the tool bar.

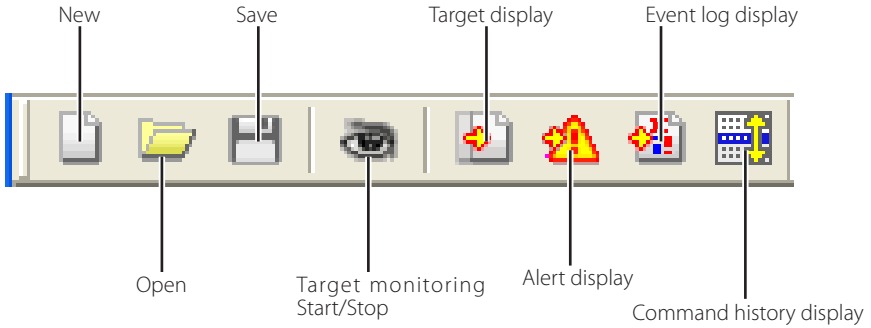

Button	Operation
New.....	Creates a new management file.
Open.....	Opens an existing management file.
Save.....	Saves the active management file.
Target monitoring.....	Starts or stops target monitoring.
Target display.....	Displays selected target information.
Alert display.....	Displays all of alert information on the status list.
Event log display.....	Displays all the event logs.
Command history display..	Displays all of the command history.

0 To switch the tool bar display on or off, select "Tool bar" from "Display" menu.

Icon display for the target

Displays icon according to the target condition.

Icon		Condition
Flat display type	Projector type	
Proj_05	Proj_05	Normal
Proj_01	Proj_05	Abnormal condition (One of the abnormalities, Alert, Trap or System error is happening on the target.)
Proj_01	Proj_100	Connection error (Target has been disconnected from the network)
Proj_100		Acquisition error (Target has been disconnected from the network, or does not provide SNMP function.)
Proj_100		Unknown (Target monitoring is not operating)

Addition of the target

1 Select **Target Addition** from **Target** menu. The target information registering window appears.

Items	Description
Name	Enter a management name of the target equipment.
IP address	Enter IP address of the target equipment.
Community	Enter a community name in the network. Default name is "public".
System information	Displays information set on the network equipment

2 Enter target setup information and click **Update** button. The information set on the target equipment are displayed on the system information items.

0 When the target equipment is not operating, or it is not the monitoring equipment, the error dialog "Cannot obtain information" will appear.

3 Click **OK** to close the window. Repeat the above steps to register for other equipment which is to be managed.

Editing the target

1 Select a target name to edit on the status list with right click.

2 Select **Target editing** on the popup menu. The target information window will appear and edit the contents, then click **OK** button.

0 The system information cannot be edited.

0 Target editing can be executed by selecting **Target editing** from **Target** menu.

Deletion of the target

1 Select a target name to delete on the status list with right click.

2 Select **Target deletion** on the popup menu. The confirmation dialog will appear and click **Yes** button to execute deleting.

0 Target deletion can be executed by selecting **Target deletion** from **Target** menu.

0 It cannot perform the target addition, editing and deletion during the target monitoring.

0 Up to 200 targets can be registered.

0 Up to 255 characters can be used for target name and community.

Setting up the warning value

PJ Network Manager provides a function to display the alert when the use time of the setting item reaches a specified setting time. The available setting items (use time) are depending on the target equipment.

- 1 Select a target on the status list with right click.
 - 0 When setting multiple targets together, select targets with pressing "Shift" or "Control" key.
- 2 Select **Warning value setting** on the popup menu. The setting window will appear as the right figure.
- 3 Check **Warning time** check box. The setting items are activated. Select a setting item and click **Edit** button. Another setting window appears.
- 4 Enter the threshold value of selected item and then click **OK** button. The setting window will disappear.
- 5 Set up warning value for remaining items if available and then click **OK** button. The setting window will disappear.
 - 0 To disable the warning value, clear **Warning time** check box.

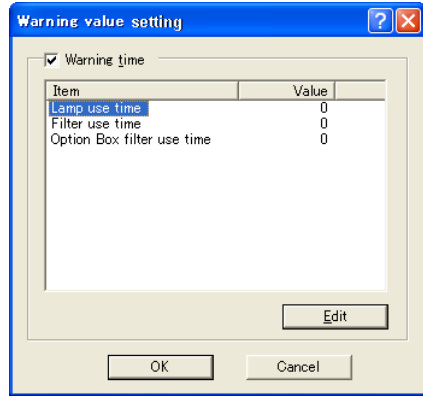

(Example of the set up window)

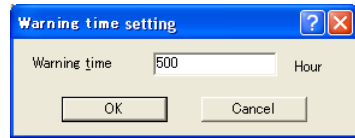

0 When selecting multiple targets, the value set to the lowest target on the status list is displayed as the current setting time. Up to 99,999 hours can be set for the use time. The warning value is stored in the management file.

Starting target monitoring

- 1 Click  button on the tool bar to start monitoring the target.
- 2 PJ Network Manager starts polling the target in a sequential from the top of the status list and displays the results on the status list.

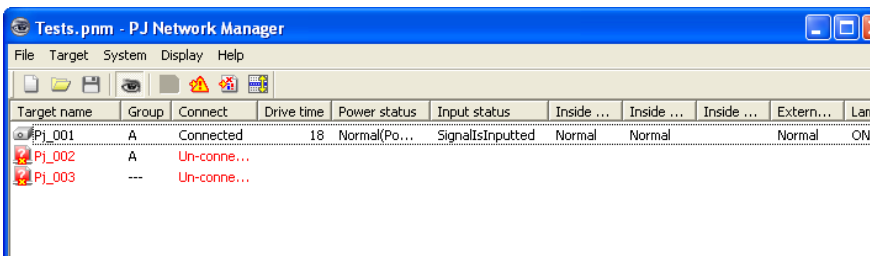

When happens the alert on the target

If the abnormality or connection error happens on the target, PJ Network Manager indicates target name, icon and status column item with red color to let you know the abnormality.

- 0 When PJ Network Manager cannot acquire the MIB information of the target equipment, it indicates as Connection Error.
- 0 The interval of target monitoring is according to the setting of **Monitoring interval** on **System default setting** from **System** menu. (+p.17)
- 0 For the way to give notice of the alert information, refer to **Event reception process** on **System default setting** from **System** menu. (+p.17)

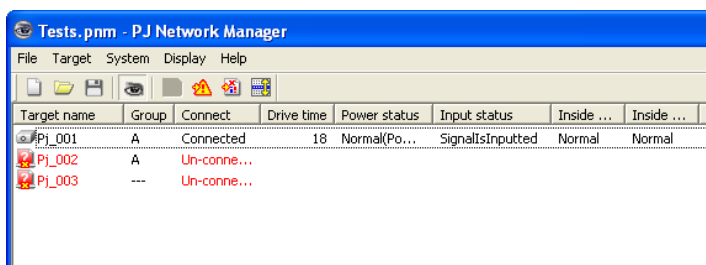

When happens the trap event on the target

During the target monitoring, if the predefined event (trap) happens on the target equipment, the target sends the trap information to PJ Network Manager. This trap information is displayed on the status list.

The trap information is set up in the SNMP setting items of the target equipment. Projector has items such as "When PJ lamp is off", "When the life span of lamp is reached", "When internal PJ power circuit is failed" etc. For further trap information, refer to "SNMP setting" in the separated network owner's manual.

- 0 For the way to give notice of the trap information, refer to **Event reception process** on **System default setting** from **System** menu. (+p.17)

What's Trap

Trap is the event predefined by the SNMP agent. If the predefined event ("When PJ lamp is off", "When internal PJ power circuit is failed" etc.) happens, target sends trap information to the SNMP manager.

Stopping monitoring the target

To stop monitoring the target, click  button again on the tool bar.

Displaying all the status information of the target

Select a target and click  button on the tool bar. The following status window appears and displays all the available status information of the target.

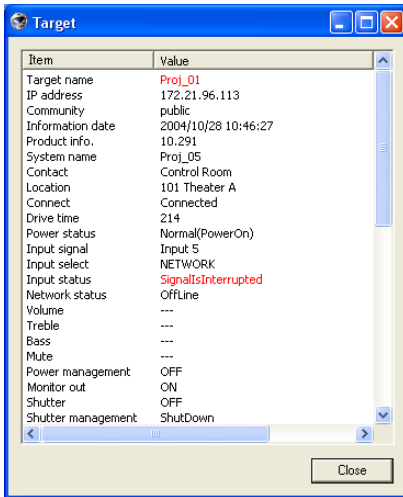

0 The target name and item which have an abnormality or connection error happening are indicated with red.

0 When PJ Network Manager cannot acquire the value of column information, "---" is displayed.

0 The above procedure can perform by selecting **Target display** from **Display** menu.

Setting the target group

The target group can be set up by the procedure below. When you set a command in the same group, you set it.

1 Select targets which you want to set from the status list. Select **Group setting** from **Target** menu, the dialog box will appear as the below figure.

2 Select a group, and then click **OK** button.

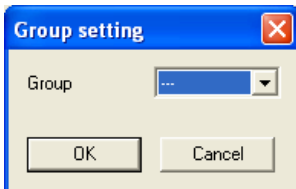

0 "---" will not set the group.

0 The projectors setting different network passwords cannot be set to the same group. It is necessary for the projectors in the same group to set to the same password.

Setting up the password of Telnet

The password of telnet can be set up by the procedure below. It is necessary to make a password, same as the network password.

- 1 Select a target which you want to set up the password of telnet from the status list. You can select multiple targets.
- 2 Select **Telnet setting** from **Target** menu, **Telnet setting** dialog box will appear as the below figure. Set a password and click **OK** button. When multiple targets are selected, all the selected targets are set as the same password.

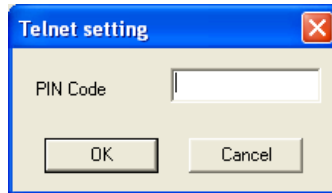

0 The initial setting is "0000".

Setting commands batch processing for multiple targets

The commands batch processing for multiple targets can be set up by the procedure below.

- 1 Select a target belonging to the batch processing group which you want to set, and select **Commands batch processing** from **Target** menu. **Commands batch processing** dialog box will appear as the below figure.
- 2 Select a command which you want to set, click **Edit** button. **Parameter editing** dialog box will appear. Select a parameter, and then click **OK** button. The check box of **Commands batch processing** dialog box will be checked.
- 3 Click **OK** button. The commands are carried out to all the targets of the same group.

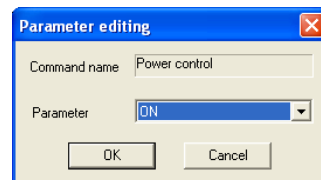
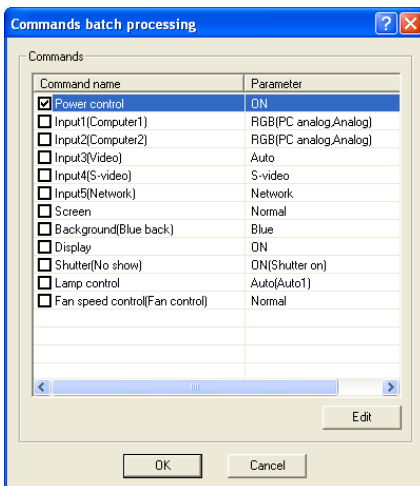

0 The commands also work for the target which is not set to a group.

Commands batch processing : Available Command

Items	Description
Power ON/OFF	Sets up the Power ON or Power OFF.
Input,Source.....	Sets up the Input and Source. Selects Input and Source.
Screen.....	Sets up the screen size. Resizes the picture screen.
Background	Sets up the background. Selects the background screen for when no input signal is detected.
Display.....	Sets up the Display. Decides whether to display On-Screen Displays or not.
Shutter(No show)	Sets up the Shutter (No show). Sets black out the image.
Lamp control.....	Sets up the Lamp control. Changes brightness of the screen.
Fan control.....	Sets up the Fan control. Chooses the running speed of cooling fans.

Setting timer for targets

The timer information for targets can be set up by the procedure below.

- 1** Choose a target which you want to set the timer.
- 2** Select **Timer setting** from **Target** menu. **Timer selection** dialog box will appear as the below figure. Check in a check box of an event to carry out.
- 3** When you want to add events, click **Add** button. Input timer informations in **Timer setting** dialog box, and click **OK** button.
- 4** Click **OK** button of **Timer selection** dialog box, timers are set to the selected target. When selecting multiple targets, timers are set to all the selected targets.

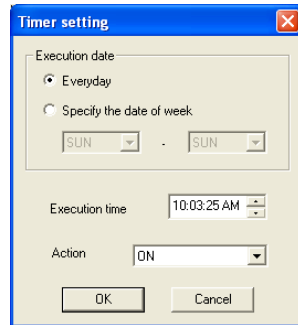
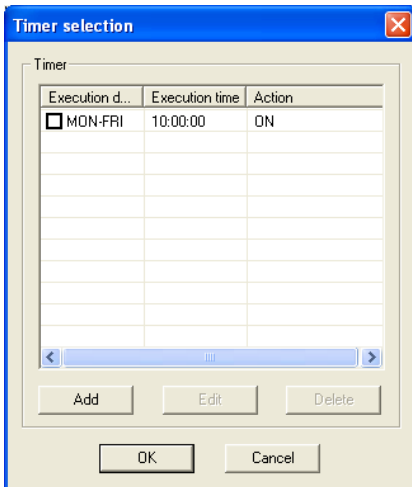

Timer

Items	Description
Execution date.....	Sets up the Timer execution date. (everyday or a day)
Execution time.....	Sets up the Timer execution time. (hh:mm:ss)
Action	Sets up the events.

Setting up default setting

The monitoring information and e-mail information can be set up by the procedure below.

- 1 Select **System default setting** from **System** menu. The setting window will appear.
- 2 Switch by clicking **Monitoring information** or **E-mail information** tab for each setting.

Monitoring information

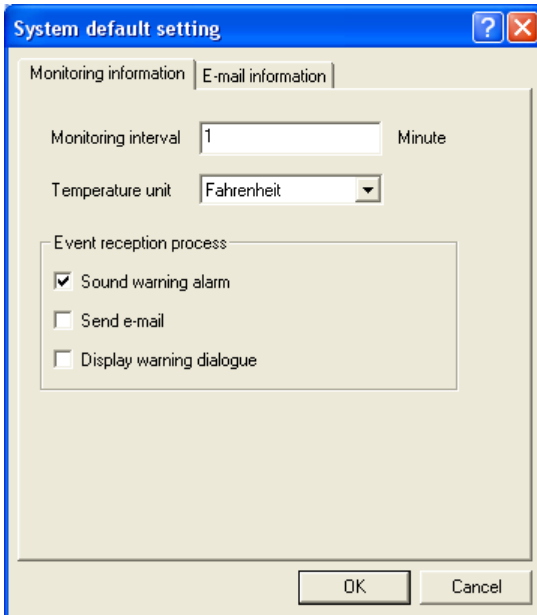

Monitoring information

Items	Description
-------	-------------

Monitoring interval	Sets up the interval of the polling in minute unit. (1 to 99 minutes can be set)
Temperature unit	Sets up the display temperature unit Centigrade or Fahrenheit.
Event reception process.....	Sets up the treatment when the event (ALERT, TRAP, SYSERR) happens on the target. For further information, refer to the item "About event treatment" (+p.26).
	p Sound warning alarm
	p Send e-mail
	p Display warning dialogue

E-mail information

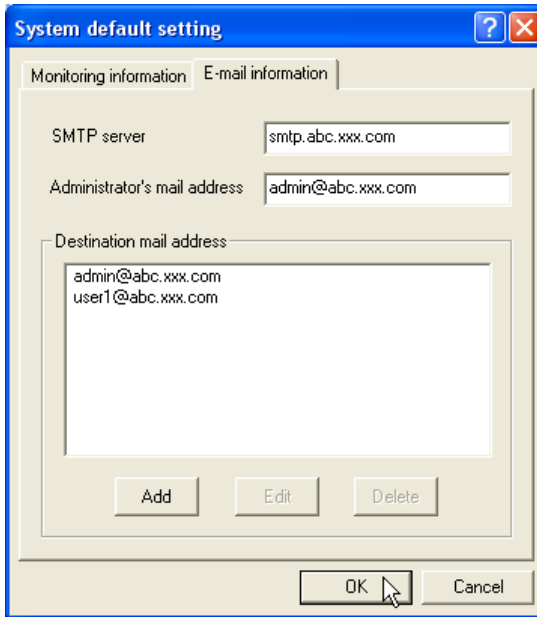

E-mail information

Items	Description
SMTP server	Sets up the IP address of SMTP mail server or server host name.
Administrator's mail address.....	Sets up the e-mail address of administrator
Destination mail address.....	Sets up the destination mail address when the event (ALERT, TRAP, SYSERR) happens on the target. The mail address entering window appears when clicking Add button.

- 0 If **Send e-mail** check box of **Event reception process** on **Monitoring information** is un-checked, the alert e-mail will not be sent even if you set up the e-mail address.
- 0 Up to 10 addresses can be set up for the destination mail address.
- 0 For the contents of the mail, refer to item "About event treatment" (+p.26).

Customizing the status list

Changing the status column indication

- 1 Select **Column selection** from **System** menu. The column selection window will appear.
- 2 On the window, check the column name to be indicated on the status list.
 - 0 The mark [*] next to the column name indicates alert item.
- 3 To change the order of the display column on the status list, select a column you intend to change the order and click **To up** or **To down** button.
- 4 Click **OK** to close setting.

0 When specifying the column width by numeric value, enter number (0 to 9999) onto "Column width" text box.

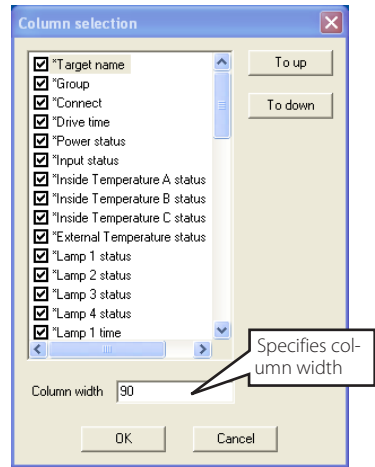

Column	Description
*Target name.....	Name of the network equipment
*Group.....	Group name
*Connect.....	Status of connection to the network (Connected, Un-connected)
*Drive time.....	Accumulated use time of the equipment
*Power status.....	Power status of the equipment (Normal(Power-on), Normal(Standby), Power Management, Power failure, lamp failure, etc.)
*Input status.....	Input signal status (Signal, No signal, Signal interrupted)
*Inside Temperature	
A status.....	Status of inside temperature A (Normal, Warning, Error)
*Inside Temperature	
B status.....	Status of inside temperature B (Normal, Warning, Error)
*Inside Temperature	
C status.....	Status of inside temperature C (Normal, Error)
*External Temperature	
status.....	Status of external temperature (Normal, Warning, Error)
*Lamp1 status.....	Status of Lamp1 (Off, On, Error, Replace)
*Lamp2 status.....	Status of Lamp2 (Off, On, Error, Replace)
*Lamp3 status.....	Status of Lamp3 (Off, On, Error, Replace)
*Lamp4 status.....	Status of Lamp4 (Off, On, Error, Replace)
*Lamp1 time.....	Used time of Lamp1
*Lamp2 time.....	Used time of Lamp2
*Lamp3 time.....	Used time of Lamp3
*Lamp4 time.....	Used time of Lamp4
*Filter status.....	Status of airfilter (Normal, Clogged)
*Option Box	
filter status.....	Status of option box filter (Normal, Error, Clogged)
*Filter time.....	Use time of airfilter
*Option Box	
filter time.....	Use time of option box filter

0 The values in parentheses are typical value and they differ depending on the connected equipment.

0 The [*] next to the column name indicates alert items.

Column	Description
*Error info.....	Error information (Not available for the projector)
IP address.....	IP address of the network equipment
Community.....	Community name of the network equipment (public)
Introduction date*1.....	Date of the network equipment installed
Timer.....	Timer information
Product info.....	Name of the network equipment
System name.....	System name of the network equipment (Proj_05)
Contact.....	Contact information of the network equipment
Location.....	Installed location of the network equipment
Input signal.....	Information of the input mode (Input1, Input2, etc.)
Input select.....	Information of the input source (RGB, VIDEO, S-VIDEO, NETWORK, etc.)
Network status.....	Condition of the network mode (Off line, Network Viewer, Network Capture)
Audio system.....	Displays audio system mode (NORMAL, PERSONAL, MUSIC, TALK)
Volume.....	Sound Volume of the network equipment
Treble.....	Sound treble of the network equipment
Bass.....	Sound bass of the network equipment
Balance.....	Sound balance of the network equipment
Mute.....	Sound mute status of the network equipment (ON, OFF)
Power management.....	Power management status of the network equipment (OFF, READY, SHUTDOWN)
Monitor out.....	Monitor out status of the network equipment (ON, OFF)
Shutter (No show).....	Shutter status of the network equipment (OFF, High-Contrast, Normal)
Shutter management.....	Shutter management status of the network equipment (Shutdown)
Fan control.....	Fan control status of the network equipment (Normal, Maximum, OFF, On1, etc.)
Inside Temperature A.....	Displays inside temperature A of the equipment (in Centigrade or Fahrenheit)
Inside Temperature B.....	Displays inside temperature B of the equipment (in Centigrade or Fahrenheit)
Inside Temperature C.....	Displays inside temperature C of the equipment (in Centigrade or Fahrenheit)
External Temperature.....	Displays external temperature of the equipment (in Centigrade or Fahrenheit)
Lamp mode.....	Displays lamp mode (1: 1-lamp mode, 2: 2-lamp mode, 4: 4-lamp mode, etc.)
Lamp control.....	Displays lamp control mode (Auto, Normal, Eco, etc.)
Model name.....	Model name of the network equipment

*1 Set up the installed date when the PJ Network Manager is newly introduced.

0 There are some un-available columns depending on the products. The value of un-available column is displayed in blank or with "---".

To change order or width of the column

Drag the status column name you want to change the order and move it on a new place and drop it. To change column width, set a mouse cursor onto the right edge of the column to change, drag the mouse on it and adjust the column width.

Sorting the status list

The order of the targets on the status list can be changed by clicking the column name which you want to sort. It switches ascending or descending order by clicking the column name each time.

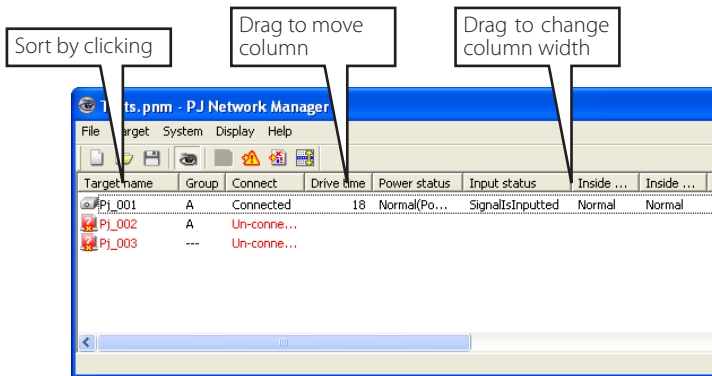

Changing font

Select **Font setting** from **System** menu. The font setup window will appear. Select your desired type face, style and size on the window.

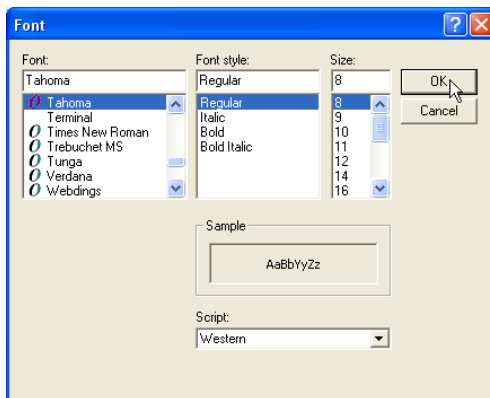

0 Customized font property is applied to all the windows of the setting.

Viewing the alert information

1 Click  button on the tool bar. The alert display window appears and the alert information of all the targets which are having an alert is listed on this window as the below.

2 To export the alert information as text file (CSV file), click **Export** button.

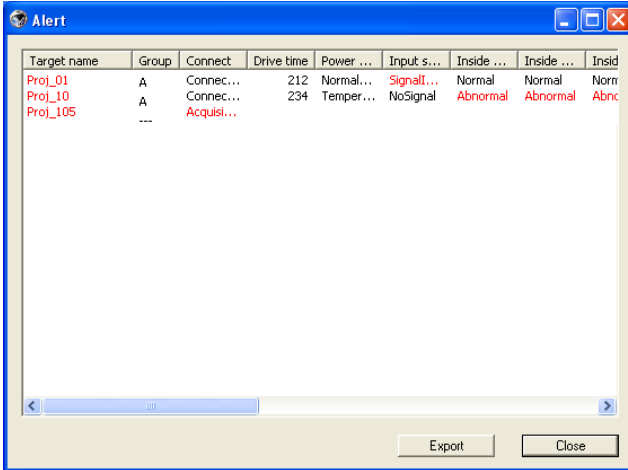

0 Column width can be changed with dragging the right edge of the column. The column order can be changed with drag and drop the column. Column can not be deleted.

Viewing the event log

- 1 Click  button on the tool bar. The event log display window appears and the events which have been happened on the targets are listed on this window as the below.
- 2 To export these events as text file (CSV file), click **Export** button.
- 3 To delete the event log, select the accrual date item you intend to delete by clicking and then click **Delete** button. On the confirmation dialog, click **Yes** to execute deletion.

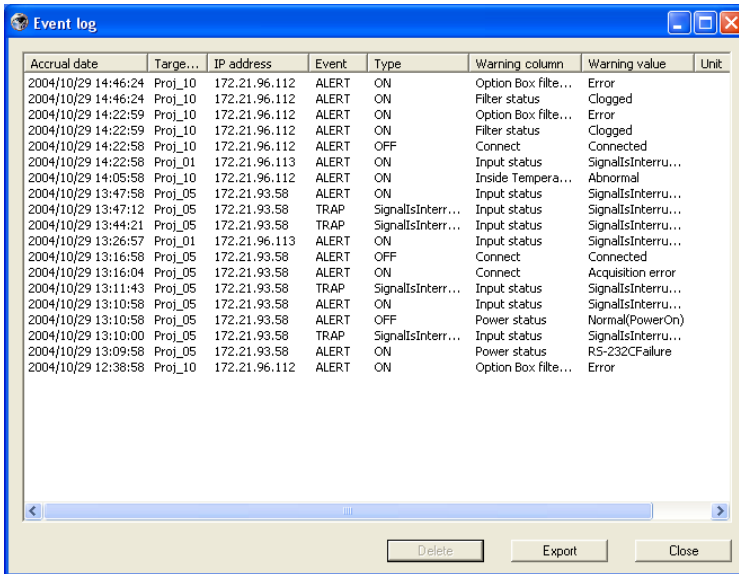

Accrual date	Target	IP address	Event	Type	Warning column	Warning value	Unit
2004/10/29 14:46:24	Proj_10	172.21.96.112	ALERT	ON	Option Box file...	Error	
2004/10/29 14:46:24	Proj_10	172.21.96.112	ALERT	ON	Filter status	Clogged	
2004/10/29 14:22:59	Proj_10	172.21.96.112	ALERT	ON	Option Box file...	Error	
2004/10/29 14:22:59	Proj_10	172.21.96.112	ALERT	ON	Filter status	Clogged	
2004/10/29 14:22:58	Proj_10	172.21.96.112	ALERT	OFF	Connect	Connected	
2004/10/29 14:22:58	Proj_01	172.21.96.113	ALERT	ON	Input status	SignalInterrupt...	
2004/10/29 14:05:58	Proj_10	172.21.96.112	ALERT	ON	Inside Tempera...	Abnormal	
2004/10/29 13:47:58	Proj_05	172.21.93.58	ALERT	ON	Input status	SignalInterrupt...	
2004/10/29 13:47:12	Proj_05	172.21.93.58	TRAP	SignalInterrupt...	Input status	SignalInterrupt...	
2004/10/29 13:44:21	Proj_05	172.21.93.58	TRAP	SignalInterrupt...	Input status	SignalInterrupt...	
2004/10/29 13:26:57	Proj_01	172.21.96.113	ALERT	ON	Input status	SignalInterrupt...	
2004/10/29 13:16:58	Proj_05	172.21.93.58	ALERT	OFF	Connect	Connected	
2004/10/29 13:16:04	Proj_05	172.21.93.58	ALERT	ON	Connect	Acquisition error	
2004/10/29 13:11:43	Proj_05	172.21.93.58	TRAP	SignalInterrupt...	Input status	SignalInterrupt...	
2004/10/29 13:10:58	Proj_05	172.21.93.58	ALERT	ON	Input status	SignalInterrupt...	
2004/10/29 13:10:58	Proj_05	172.21.93.58	ALERT	OFF	Power status	Normal(PowerOn)	
2004/10/29 13:10:00	Proj_05	172.21.93.58	TRAP	SignalInterrupt...	Input status	SignalInterrupt...	
2004/10/29 13:09:58	Proj_05	172.21.93.58	ALERT	ON	Power status	R5-232CFailure	
2004/10/29 12:38:58	Proj_10	172.21.96.112	ALERT	ON	Option Box file...	Error	

Event log information items

Items	Description
-------	-------------

- | | |
|----------------------|--|
| Accrual date | Accrual date of the event |
| Target name | Name of the network equipment |
| IP address | IP address of the network equipment |
| Event | Type of the Event (ALERT, TRAP, SYSERR) (See table on the next page) |
| Type | Type of the Event (See table on the next page) |
| Warning column | Warning column of the Event (See table on the next page) |
| Warning value ... | Warning value of the Event (See table on the next page) |
| Unit | Displays unit of the warning value. |

- 0 The listed items are fixed.
- 0 The order of the event log list can be changed temporarily by clicking the column name which you want to sort. It switches ascending or descending order by clicking the column name each time.
- 0 Column width can be changed by dragging the right edge of the column. The column order can be changed with drag and drop the column. Column cannot be deleted.

Description of Event, Type, Warning column, Warning value

Event	Type	Warning Column	Warning Value	Description
ALERT	ON : Abnormality has happened OFF : Abnormality has been cleared	Connect	Un-connected Connected Acquisition error	* Refer to the next page
		Power status	PowerFailure TemperatureError Normal (AfterTempError) RS232CFailure Power management Shutter management LampFailure Normal(Standby) Normal(OnStartingUp) Normal(OnCoolingDown) Normal(PowerOn) TemperatureError(OnCoolingDown) Power management(OnCoolingDown) Shutter management(OnCoolingDown) LampFailure(OnCoolingDown)	
		Input status	SignalsInterrupted SignalsInputted	
		Inside Temperature status (A to C) External Temperature status	Abnormal	
		Lamp status (1 to 4)	Failure Replace	
		Lamp time (1 to 4)	(setting time)	
		Filter status	Clogged Warning	
		Filter time	(setting time)	
		TRAP	LampFailure	
LampReplace	Replace			
PowerOFF PowerFailure PowerManagement ShutterManagement	Power status		Normal(Standby) Normal(OnCoolingDown) PowerFailure Power management Power management(OnCoolingDown) ShutterManagement ShutterManagement(OnCoolingDown)	
TemperatureError	Inside Temperature status (A to C) External Temperature status		Abnormal	
SignalsInterrupted	Input status		SignalsInterrupted	
LampReplacementTime	Lamp time (1-4)		(lamp time)	
FilterReplacementTime	Filter time		(filter time)	
CloggedFilterWarning	Filter status		Clogged Warning	
AutoPlayError	n/a		Error	
WarningOnConstantModeForBrightness	n/a	n/a		
SYSERR	*Mail Transfer *MemoryError	n/a * ¹	n/a * ¹	

*1 When PJ Network Manager could not send mail or acquire the memory, no message is displayed in "Warning column" and "Warning value".

0 For further details of each warning column and value, refer to the next page.

Description of warning value

Warning Column	Warning Value	Description
Connect	Un-connected Connected * Acquisition error	Projector has been disconnected from the network Projector has been connected to the network PJ Network Manager could not acquire the MIB information from the equipment
Power status	Power failure	Projector turned off due to the power failure of the projector
	TemperatureError	The projector turned off due to temperature error occurred
	Normal (AfterTempError)	Normal after temperature error occurred
	RS232CFailure	The RS-232C communication error occurred
	Power management	The power management function turned projector lamp off
	Shutter management	The shutter management function turned projector lamp off
	LampFailure	The lamp failure occurred
	Normal(Standby) * Normal(OnCoolingDown) *	Projector turned into standby normally On cooling down normally due to projector turned off
Input signal status	SignalsInterrupted SignalsInputted *	The signal was interrupted The signal was inputted again
Inside Temperature status (A to C) External Temperature status	Abnormal	The projector turned off when the temperature was abnormally high
Lamp status	ON * Failure Replace	When the lamp is on When the lamp failed to ignite. It reached lamp replacing time.
Lamp time	(lamp time)	It reached user setting lamp replacing time
Filter status	Clogged Warning	Filter has been clogged Filter is close to clogging
Filter time	(filter time)	It reached user setting filter time
(Auto play error)	n/a	The error occurred during the auto image display
(WarningOnConstantModeFor Brightness)	n/a	The brightness (Current value) continuously goes down a certain rate from the value in Constant mode.

0 The warning value with "*" in the above table shows the event when the alert has cleared, alert type is "OFF".

0 The column order and width of the event log window are saved to the registry of the computer.

0 Up to 1000 of events can be stored. If it exceeds 1000 events, the oldest event is deleted and the latest event is added. The event log can be saved to the management file.

0 This Warning column is not available for some projector's model types.

About event treatment

If the PJ Network Manager receives an event, it executes following event treatment items which are selected in the system default setting.

- p Sound warning alarm
- p Send e-mail
- p Display warning dialog

Sound warning alarm

If the PJ Network Manager receives an event, the computer beeps an alarm sound. The alarm sound is depending on your computer sound setting.

0 The alarm sound is not made when your computer does not provide any speaker or the sound volume is muted.

Send e-mail

Following example message is sent to the e-mail address you set up as the destination mail address.

From: Test1<admin@abc.xxx.com> (management file name)
Date : 2004/10/29 21:30
To : user@abc.xxx.com
Subject : Alert message

Alert has occurred
* Accrual date : 2004/10/29 21:13:42
* Target name : Proj_10
* IP address : 192.168.1.101
* Event : ALERT
* Type : ON
* Warning column : Power status
* Warning value : Power failure

0 For the further information of event, type, warning column and warning value, see the item "Viewing the event log" (+p.23).

0 The setting of event treatment, refer to item "Setting up default setting" (+p.17).

Notes on using Windows XP / Windows Vista / Windows 7

Windows Firewall is turned on by default in Windows XP, Windows Vista, and Windows 7. Due to this Windows Firewall, the send e-mail function is not available. When using this mail function, you need to cancel the block for PJ Network Manager application. For the further details of Windows Firewall, see Windows help on your computer.

Display warning dialog

Following dialog window appears on the screen if event occurs.

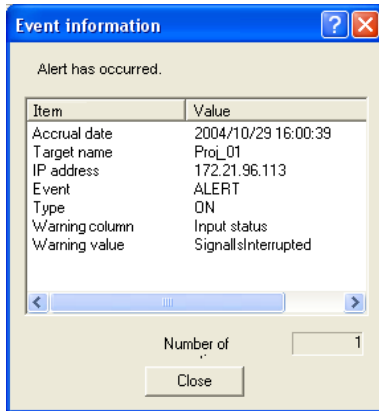

Viewing the command history

- 1 Click  button on the tool bar. **Command history** window appears and the command history is listed on the window as shown below.
- 2 To export the command history as text file (CSV file), click **Export** button.
- 3 To delete the command history, select the item of **Executed date/time** which you want to delete, and then click **Delete** button. On the confirmation dialog box, click **Yes** button to execute deletion.

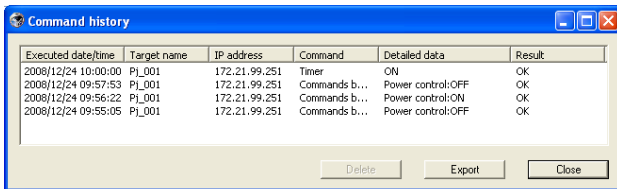

Command history

Items	Description
-------	-------------

Executed date/time Executed date and time of the command

Target name Name of the network equipment

IP address IP address of the network equipment

Command Type of the Command

Detailed data Contents of the Command

Result Results of the Command

0 The listed items are fixed.

0 Column width can be changed by dragging the right edge of the column. The column order can be changed with drag and drop the column. Column cannot be deleted.

0 Up to 1000 of events can be stored. If it exceeds 1000 events, the oldest event is deleted and the latest event is added.

Storing the management file

When you monitor the network equipment with the PJ Network Manager, you can save the registered target information, system setting and event log information into the management file with a free file name. It is useful if you manage multiple equipment in the network.

Click  button on the tool bar and save it with free file name. The extension is ".pnm".

The management file contains following information.

Items	Description
Header	Management file section, file version
System default setting	Default value of the system setting - Monitoring interval - Event reception process - Temperature unit - E-mail information
Target information	Information of the registered target - Target information (target name, IP address, Community, Introduction date) - target MIB information - Warning value set up
Event log information.....	Event log information (ALERT, TRAP, SYSERR)

0 The maximum volume of a management file is required about 1MB. (Number of registrable targets is 200, number of events is 1000)

Information saved to the registry

Following application setting information is saved to the registry of your computer. So the setting condition is memorized even after quitting the application.

Items	Description
Status window information.....	Display position and size of the status list window
Status list information	Display status column, column width and column order
Event log list information.....	Column width and order of the event log list
Font set up	Font setting value (Type face, size and style)

Registering the target information from the defined file at once

The PJ Network Manager provides a function to import the target information from the defined file at once. Prepare the defined file (CSV data format) in which the target information is written along the format shown below.

- 1 Select **Target batch registration** from **System** menu. The target batch registration window appears.
- 2 Click **Reference** button and select a defined file to import the target information. The imported target information will be listed on the target batch registration window.

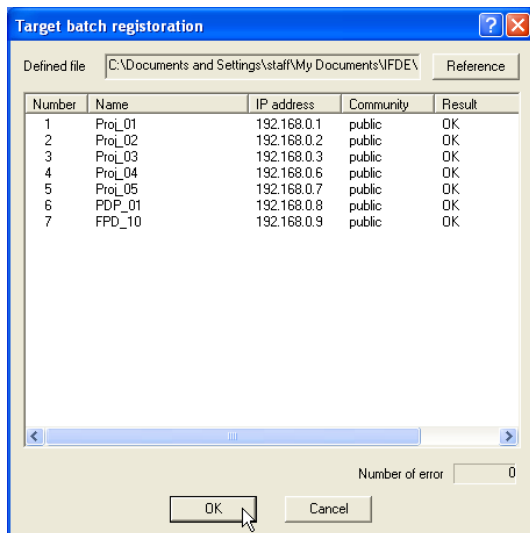

* If there is an error in the imported defined file, the error information will be indicated on the Result column. Retry importing after correcting the defined file.

- 3 Click **OK** button to execute the registration.

Format of the defined file

The defined file is a CSV data file created by the spreadsheet application and is defined as follows;

Column	Description (example)
Target name.....	Name of target equipment (Proj_01, Proj_03, PDP_01, etc.)
IP address	IP address (192.168.0.1, etc.)
Community	Name of SNMP community. Default value of our network products is "public"

Example of the defined file

The table below shows the example of the defined file provided with the target information. Save this file as the CSV file.

Target name	IP address	Community
Proj_01	192.168.0.1	public
Proj_02	192.168.0.2	public
Proj_03	192.168.0.3	public
Proj_04	192.168.0.6	public
Proj_05	192.168.0.7	public
PDP_01	192.168.0.8	public
FPD_10	192.168.0.9	public

Login to the target equipment

After double clicking the target name on the status list, the computer launches web browser and displays the login window of the target equipment.

You can control and set up the projector remotely by using the web browser. For the further information of instruction, see the separated network owner's manual.

Login by double clicking

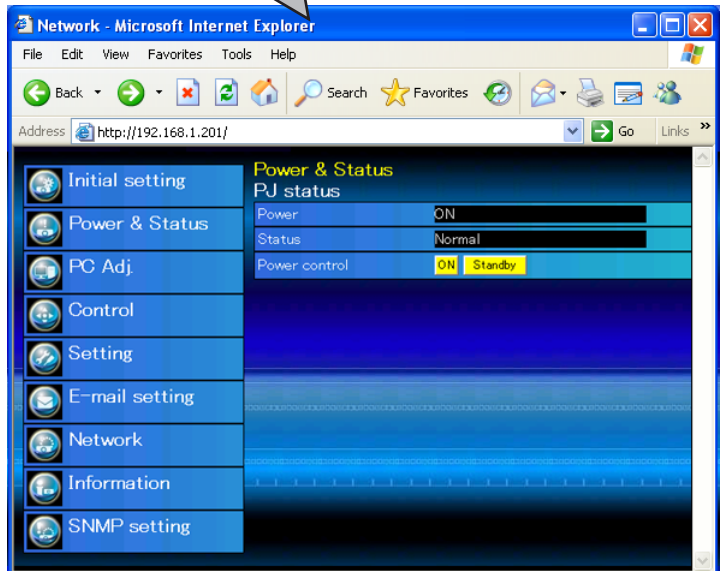
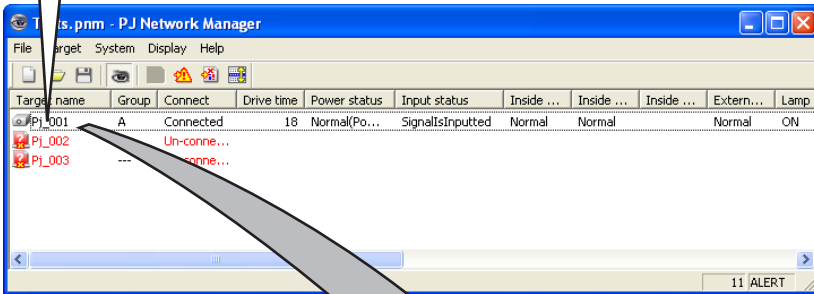

0 An example of the login page.



ViewSonic®