

DATA PROJECTOR

XJ-M140/XJ-M145*

XJ-M150/XJ-M155*

XJ-M240/XJ-M245*

XJ-M250/XJ-M255*

* USB Port Models

User's Guide

- Be sure to read the precautions in the separate Setup Guide. For details about setting up the projector, see the Setup Guide.
- Be sure to keep all user documentation handy for future reference.

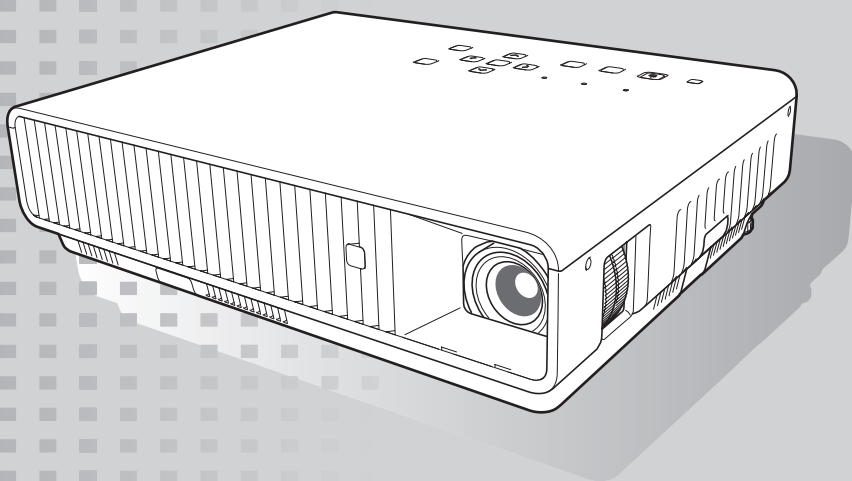

CASIO®

- DLP is a registered trademark of Texas Instruments of the United States.
- Microsoft, Windows, and Windows Vista are registered trademarks or trademarks of Microsoft Corporation in the United States and other countries.
- HDMI, the HDMI Logo and High-Definition Multimedia Interface are trademarks or registered trademarks of HDMI Licensing LLC.
- XGA is a registered trademark of IBM Corporation of the United States.
- PJLink is a trademark applied for registration or is already registered in Japan, the United States of America and other countries and areas.
- Other company and product names may be registered product names or trademarks of their respective owners.
- Portions of this product are based in part on the work of the Independent JPEG Group.

- The contents of this User's Guide are subject to change without notice.
- Copying of this manual, either in part or its entirety is forbidden. You are allowed to use this manual for your own personal use. Any other use is forbidden without the permission of CASIO COMPUTER CO., LTD.
- CASIO COMPUTER CO., LTD. shall not be held liable for any lost profits or claims from third parties arising out of the use of this product or this manual.
- CASIO COMPUTER CO., LTD. shall not be held liable for any loss or lost profits due to loss of data due to malfunction or maintenance of this product, or any other reason.
- The sample screens shown in this manual are for illustrative purposes only, and may not be exactly the same as the screens actually produced by the product.

Contents

About this manual...	5
Projector Overview	6
Projector Features and Main Functions	6
Remote Controller and Projector Keys	8
Back Terminals	9
Operation During Projection	10
Selecting the Input Source	10
To select a different input source	10
3D Input Mode	10
Horizontal Flipping in the 3D Input Mode	11
Image Operations During Projection	12
Adjusting Image Brightness	12
Selecting the Color Mode	13
Zooming an Image	13
Momentarily Cutting Off the Input Source Image	14
Freezing an Image	14
Displaying a Pointer in the Projected Image	15
Changing the aspect ratio of the projected image	16
Adjusting the Volume Level	17
To adjust the volume level	17
To mute the audio	17
Eco Mode (Power Saving, Low Noise)	18
To select the Eco Mode	18
Using the [FUNC] Key	19

Configuring Advanced Projector Settings 20

Basic Setup Menu Operations	20
Displaying the Setup Menu.....	20
Configuring Setup Menu Settings.....	20
Basic Setup Menu Example.....	21
Direct Power On.....	22
Password Protecting the Projector	23
Inputting a Password	23
Using the Password Feature.....	23
Entering the Password when Turning On the Projector	25
Restoring Projector Settings to Their Initial Factory Defaults	26
Setup Menu Contents	28
Image Adjustment 1 Main Menu.....	28
Image Adjustment 2 Main Menu.....	30
Volume Adjustment Main Menu.....	30
Screen Settings Main Menu.....	31
Input Settings Main Menu.....	33
Option Settings 1 Main Menu	34
Option Settings 2 Main Menu	35
Wired LAN Settings Main Menu (USB Port Models Only)	37
USB Settings Main Menu (USB Port Models Only)	37
Operational Info Main Menu	38
Restore All Defaults Main Menu.....	38

Cleaning the Projector..... 39

Cleaning the Projector Exterior	39
Cleaning the Lens.....	39
Cleaning Intake, Exhaust and Airflow Vents.....	39

Error Indicators and Warning Messages 40

Appendix	43
Connecting to a Video Device	43
Connection to a composite video output or S-video output	43
Connection to a component video output	44
Connecting the HDMI Output of a Video Device or Computer to the Projector.....	45
Remote Controller Signal Range	46
Projection Distance and Screen Size	47
Aspect Ratio Setting and Projection Image	48
Supported Signals.....	52
Using Wired LAN to Control the Projector (XJ-M145, XJ-M155, XJ-M245, XJ-M255)	55
Supported External Devices	55
Controlling the Projector from a Computer	55
Projector RS-232C Control	60
Connecting the Projector to a Computer.....	60
Specifications	62

About this manual...

All of the operations in this manual are explained using the remote controller that comes with the projector.

Projector Overview

This section describes the features of the projector, and explains the functions of the projector and remote controller keys.

Projector Features and Main Functions

XJ-M140/XJ-M145/XJ-M150/XJ-M155/XJ-M240/XJ-M245/XJ-M250/XJ-M255

- A laser and LED hybrid light source provides high brightness of 2,500 to 3,000 lumens along with low power consumption and low heat generation.
- **A wide selection of input sources:**
Analog RGB, composite video, S-video, component video (Y·Cb·Cr, Y·Pb·Pr), and HDMI input sources are supported.
- **Intelligent Brightness Control function (Eco Mode):**
The projector senses surrounding light levels and adjusts projection brightness automatically as required for efficient low-power operation. (Requires “Eco Mode” setting to be set to “On (Auto)”.)
- **3D image projection support:**
Projection of a 3D image signal (60Hz/120Hz field sequential protocol) via one of three input sources (analog RGB, composite video, S-video) is supported.
* Separately available 3D glasses (YA-G30) are required in order to view a projected 3D image in 3D. Also, separately available special software (CASIO 3D Converter) is required to project a 3D image with the projector when a computer (analog RGB) is the input source.
- **Pointer:**
The remote controller can be used to select one of a variety of different pointers for use during projection.
- **Direct Power On:**
The projector can be configured to turn on automatically and start projecting as soon as it is plugged into a power outlet.

XJ-M240/XJ-M245/XJ-M250/XJ-M255

- **WXGA Resolution:**
The XJ-M240/XJ-M245/XJ-M250/XJ-M255 models support WXGA (1280 × 800) resolution for optimal viewing of content formatted for today’s widescreen displays. This makes it perfect for projecting images from widescreen notebook PCs and HD video input sources.

XJ-M145/XJ-M155/XJ-M245/XJ-M255

- **Projection of Data from USB Memory or a Memory Card without a Computer:**

USB memory or a memory card (using a commercially available USB card reader) can be connected directly to the projector's USB port. The projector comes with special software for converting PowerPoint presentation data to a format that can be stored to USB memory or a memory card and projected without using a computer. Images and movies also can be projected directly from USB memory or a memory card.

- **Multi Projection Camera (YC-400, YC-430) Connection:**

A CASIO Multi Projection Camera can be connected directly to the projector's USB port for fine resolution projection of documents and other images. Document camera capabilities allow projection of data without going through a computer.

- **Graphic Scientific Function Calculator Connection:**

Certain CASIO graphic scientific calculator models can be connected directly to the projector's USB port for projection of the calculator screen contents.

- **Projection of Computer Screen Contents via Wireless LAN:**

The projector comes with a wireless LAN adapter. After a wireless LAN connection is established, the contents of the computer screen can be sent to the projector for projection.

- **Support for Wireless projection from MobiShow:**

You can install AWIND's MobiShow (client software for wireless connection to a projector) on a smartphone or mobile terminal, and then use the projector to project photographs and presentation files stored in the smartphone or terminal memory.

* Note that the type of terminal and the MobiShow version can limit certain functions or can even make projection impossible.

- **Projector operation via wired or wireless LAN:**

Remote control of the projector is supported via a wired connection to the LAN port on the back or the projector or via wireless LAN.

Remote Controller and Projector Keys

Operations in this manual are presented based on the remote controller that comes with the projector. Major operation keys are also provided on the projector unit, so the most of the same procedures can also be performed directly on the projector.

Remote Controller Keys

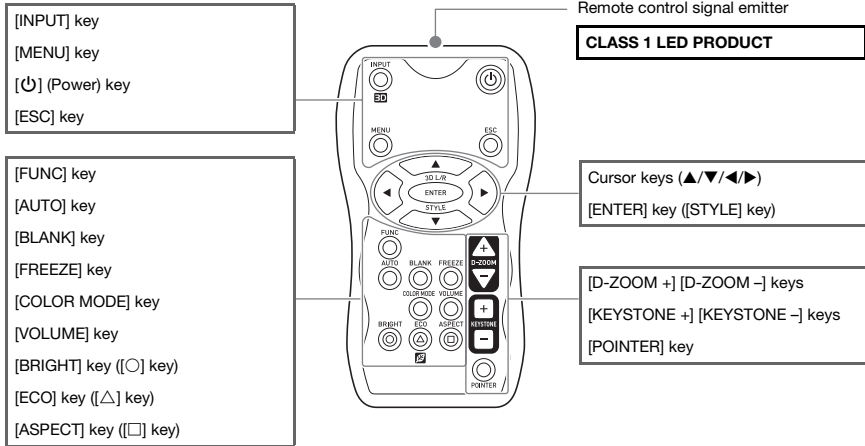

The remote controller does not come with batteries loaded. You need to load the two supplied batteries before use.



Important!

To avoid running down the batteries, store the remote control unit so its keys are not pressed inadvertently.

Projector Keys and Indicators

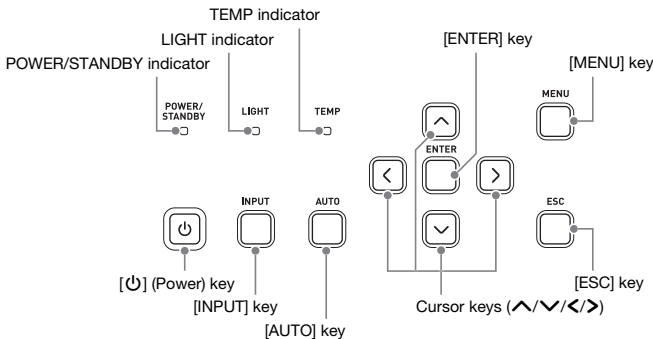

Back Terminals

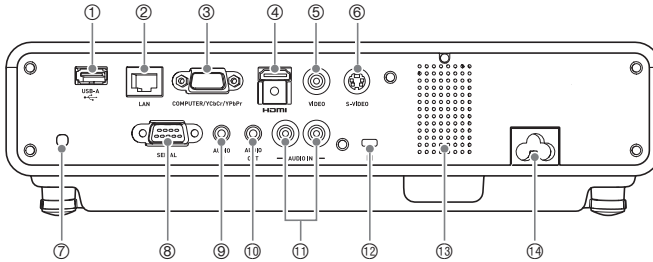

- ① USB port (XJ-M145, XJ-M155, XJ-M245, XJ-M255 only)
- ② LAN port
- ③ COMPUTER IN terminal
- ④ HDMI port
- ⑤ VIDEO terminal
- ⑥ S-VIDEO terminal
- ⑦ Remote control signal receiver
- ⑧ SERIAL port*
- ⑨ AUDIO IN terminal
- ⑩ AUDIO OUT terminal
- ⑪ AUDIO IN L/R terminals
- ⑫ Anti-theft lock hole
- ⑬ Speaker
- ⑭ Power connector

* This terminal is for controlling the projector from an external device. It normally is not used. For information about using control commands and other details, See “Projector RS-232C Control” (page 60).

Operation During Projection

Selecting the Input Source

Turning on the projector initially causes the same input source that was selected the last time it was turned off to be selected.

To select a different input source

- 1. Press the [INPUT] key.**
 - This displays the input source selection screen.
- 2. Select either the Normal Input Mode or 3D Input Mode depending on the type of image you want to project.**
 - For details about the 3D Input Mode, see the explanation in the following section.
- 3. Use the [▼] and [▲] keys to select the name of the input source you want to select and then press the [ENTER] key.**
 - The name of the input source you select appears in the upper right corner of the projection screen for a few seconds.
 - The message “No signal input.” will appear if no input signal can be selected.

3D Input Mode

Your projector supports projection of 3D images. To project a 3D image, first enter the projector’s 3D input mode, and then select the input source.



Important!

- Separately available 3D glasses (YA-G30) are required in order to view a projected 3D image in 3D.
- Separately available special software (CASIO 3D Converter) is required to project a 3D image with the projector when a computer (analog RGB) is the input source.

The input sources described below can be selected for projection in the 3D Input Mode.

Input Source	Projection Conditions
Computer (Analog RGB)	<ul style="list-style-type: none">● Any of the following types of 3D image data played back using separately available special software (CASIO 3D Converter).<ul style="list-style-type: none">– 2D image file converted to a 3D image file using CASIO 3D Converter– Side-by-side 3D format files● Signal with 60Hz/120Hz vertical scan frequency
Composite Video, S-video	<ul style="list-style-type: none">● Field sequential 3D format files recorded with field sequential DVD software, etc.● Signal with 60Hz vertical scan frequency



Note

See “3D Signals (3D Input Mode)” (page 54) for a list of 3D image signals supported by this projector.

Entering the 3D Input Mode

1. Press the [INPUT] key to display the input source selection screen.
2. Select Computer (RGB), S-video, or Video as the input source.
3. Use the [▼] and [▲] keys to move the highlighting to “To 3D input mode” and then press the [ENTER] key.
 - This enters the 3D input mode and closes the input source selection screen.



Important!

- You cannot select HDMI or USB as the input source in the 3D input mode. To use either of these input sources, change the input source setting back to normal input mode.
- When Computer is selected as the input source in the 3D input mode, a component video signal input through the projector’s COMPUTER IN terminal is treated as an RGB signal resulting in abnormal image projection.
- Except when using the projector for 3D image projection, you should normally leave it in the normal input mode.

Returning to the Normal Input Mode from the 3D Input Mode

1. Press the [INPUT] key to display the input source selection screen.
2. Use the [▼] and [▲] keys to move the highlighting to “To normal input mode” and then press the [ENTER] key.
 - This enters the normal input mode and closes the input source selection screen.

Horizontal Flipping in the 3D Input Mode

In side-by-side 3D, a full frame consists of two halves on the left and right for each eye. In rare cases, the left and right images may be reversed, which causes a loss of 3D depth. If this happens, try using the following procedure to swap the left and right images with each other.

To swap the left and right images

In the 3D input mode, press the [ENTER] key.

Image Operations During Projection

You can perform the following operations while projecting an image.

- Image brightness adjustment
- Color mode selection
- Image zooming
- Momentary cut off of the input source image and projection of a black or blue screen, or a logo
- Image freeze
- Pointer display in the projected image
- Aspect ratio switching

Adjusting Image Brightness



Note

(for USB port model users)

Use the setup menu (page 20) to adjust image brightness when the input source is an external device connected to the USB port.

To adjust image brightness

1. Press the [BRIGHT] key.

- This displays the brightness adjustment window.



2. Use the [◀] and [▶] keys to adjust image brightness.

3. To hide the window, press the [ESC] key.

Selecting the Color Mode

You can select from among various different color mode settings in accordance with image contents and projection conditions.



Important!

The color mode cannot be selected in the following cases.

- When “Off” is selected for the Eco Mode setting (page 18)
- When the projector is in the 3D input mode. See “3D Input Mode” (page 10).

To change the color mode

1. Press the [COLOR MODE] key.

- This displays the color mode selection window. The currently selected color mode is the one whose button is selected (filled in).

2. Use the [▼] and [▲] keys to move the highlighting to the color mode you want to select, and then press the [ENTER] key.

- This will select the button next to the highlighted color mode name.
- For details on what each color mode does, see “Color Mode” under “Image Adjustment 1 Main Menu” on page 29.

3. To hide the window, press the [ESC] key.

Zooming an Image

1. Press the [D-ZOOM +] key.

- This will enlarge the center of the projected image one step.

2. To zoom in on the center of the projected image more, press the [D-ZOOM +] key again. To zoom out, press the [D-ZOOM -] key.

- Each press of [D-ZOOM +] zooms in (increases the zoom factor), while [D-ZOOM -] zooms out. Holding down either key continuously scrolls the zoom factor.

3. While an image is zoomed, use the [▲], [▼], [◀], and [▶] keys to scroll the view to other parts of the image.

4. To exit the zoom operation, press the [ESC] key.

Momentarily Cutting Off the Input Source Image

1. Press the [BLANK] key.

- This temporarily cuts off the image from the input source and projects a black screen in its place.

2. To resume projection of the image from the input source, press the [BLANK] key (or [ESC] key).



Note

You can specify projection of a black screen or blue screen, or a logo. For details, see “Blank Screen” under “Screen Settings Main Menu” on page 32.

Freezing an Image

Pressing the [FREEZE] key freezes the projected image.

To freeze the projected image

1. While an image is being projected from an input source, press the [FREEZE] key.

- This will capture the image that is on the screen at the moment you press [FREEZE] and stores it in projector memory. That image remains projected on the screen.

2. To restore projection of the image from an input source, press the [ESC] key.

Displaying a Pointer in the Projected Image

You can select from among different pointer styles, including various arrow styles, for display in the projected image. Pointers can be used during a presentation to indicate or highlight a specific part of the image.



Note

Depending on the pointer style you are using, the pointer may not display properly when you are using keystone correction. If this happens, use the [KEystone +] and [KEystone -] keys to change the keystone correction value to zero.

To display a pointer in the image

1. Press the [POINTER] key.

- This will cause a pointer to appear in the image.
- You also can use the setup menu to specify the pointer type that appears first when you press the [POINTER] key. For details, see “Pointer” under “Option Settings 2 Main Menu” on page 35.

2. Use the cursor keys to move the pointer to the location you want.

- Holding down a cursor key moves the cursor at high speed.

3. To modify the pointer as described below, press the [STYLE] key.

For this pointer type:	Pressing [STYLE] will change it like this:
	→ → →
	→ → →
	→ → →
	→ → →
	Toggle between flashing and not flashing

To select the pointer type

1. Press the [POINTER] key to display the pointer.

2. Keep pressing the [POINTER] key until the pointer you want is displayed.

- Each press of the [POINTER] key cycles through the available pointer types.

To clear the pointer from the image

Press the [ESC] key.

Changing the aspect ratio of the projected image

Press the [ASPECT] key to cycle through the aspect ratio settings for the projected image.

Available settings depend on your projector model as shown below. For details about the meaning of each setting, see the “Aspect Ratio” setting under “Screen Settings Main Menu” on page 31.

XJ-M240/XJ-M245/XJ-M250/XJ-M255

Pressing the [ASPECT] key will cycle through settings in accordance with the current input source as shown below.

Input Source	Pressing [ASPECT] will cycle through these settings:
Video, S-video, Component, HDMI (DTV)	Normal → 16:9 → Letter Box
RGB, HDMI (PC)	Normal → Full → True

XJ-M140/XJ-M145/XJ-M150/XJ-M155

Pressing the [ASPECT] key will toggle between settings in accordance with the current input source as shown below.

Input Source	Pressing [ASPECT] will toggle between these settings:
Video, S-video, Component, HDMI (DTV)	Normal ↔ 16:9
RGB, HDMI (PC)	Normal ↔ Full



Note

- When the input source is a component or an HDMI (DTV) signal with an aspect ratio of 16:9, the aspect ratio is fixed at 16:9. In this case, pressing the [ASPECT] key will not change the aspect ratio setting.
- For details about how the aspect ratio setting affects the projected image, see “Aspect Ratio Setting and Projection Image” (page 48).
- You also can change the aspect ratio setting using the setup menu. For details, see “Aspect Ratio” under “Screen Settings Main Menu” on page 31.



Important!

Note that enlarging or reducing the size of an image using the [ASPECT] key for commercial purposes or public presentation may infringe on the legally protected copyright of the copyright holder of the original material.

Adjusting the Volume Level

You can use the remote controller keys to adjust the volume level of the audio that is output from the projector's speaker.

To adjust the volume level

1. Press the [VOLUME] key.

- This causes the [Volume] screen to appear on the projected image.



2. Press the [▶] key to increase the volume, or the [◀] key to lower the volume.

3. After the setting is the way you want, press the [ESC] key.

- This causes the [Volume] screen to disappear.



Note

You also can use the setup menu to adjust the volume level. For details, see “Volume Adjustment Main Menu” on page 30.

To mute the audio

1. Press the [VOLUME] key.

2. Press the [ENTER] key.

- This stops output from the speaker.

3. To restore the audio, press the [VOLUME] key again.

Eco Mode (Power Saving, Low Noise)

The following three Eco Mode settings are available to specify whether priority should be given to low-power, low-noise operation or to projection brightness.

- On (Auto)** : A brightness sensor on the top of the projector senses surrounding light, and automatically adjusts projection brightness and color accordingly. Brightness is reduced for darker surroundings, which saves power and reduces operation noise.
- On (Manual)**: Enables manual adjustment to balance the needs of low-power, quiet operation and projection brightness.
- Off** : Give top priority to projection brightness.



Important!

- While “On (Auto)” is selected as the Eco Mode setting, make sure that the brightness sensor on the top of the projector is not blocked by anything.
- The local environment and setup conditions affect the brightness sensor, so operation when “On (Auto)” is selected for the Eco Mode depends on these factors.

To select the Eco Mode

1. Press the [ECO] key.

- This causes “Eco Mode” window to appear on the projection screen.

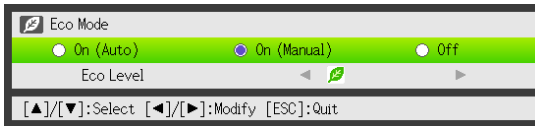

2. Use the [◀] and [▶] keys to select the setting you want.

- If you select “On (Manual)” here, go to step 3. If you select another setting, jump to step 4.

3. Perform the following steps to adjust the “Eco Level” (the balance between low-power, quiet operation and projection brightness).

- ① Press the [▼] key to move the highlighting to the Eco Level.
- ② Use the [◀] and [▶] keys to adjust the Eco Level to the setting you want.
Fewer 🌿 marks gives higher priority to projection brightness. A greater number gives high priority to low-power, quiet operation.

4. To hide the window, press the [ESC] key.



Important!

- The Eco Mode setting automatically changes to “Off” whenever the projector is in the 3D input mode. See “3D Input Mode” (page 10).
- The “On (Auto)” setting cannot be selected for the Eco Mode while “On” is selected for “Screen Settings → Ceiling Mount” on the setup menu. If the “Ceiling Mount” setting is changed to “On” while “On (Auto)” is selected for the Eco Mode setting, the Eco Mode setting will automatically change to “On (Manual)”.
- The “On (Auto)” setting cannot be selected for the Eco Mode while “Rear” is selected for “Screen Settings → Projection Mode” on the setup menu. If the “Projection Mode” setting is changed to “Rear” while “On (Auto)” is selected for the Eco Mode setting, the Eco Mode setting will automatically change to “On (Manual)”.



Note

- While “Off” is selected for the Eco Mode setting, you also can specify whether brightness or color should be given emphasis. For details, see “Eco Off Mode” under “Image Adjustment 1 Main Menu” (page 29).
- **(for USB port model users)**
Use the setup menu (page 20) to select the Eco Mode when the input source is an external device connected to the USB port.

Using the [FUNC] Key

Pressing the [FUNC] key displays the menu shown below.

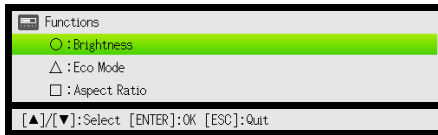

You can use this menu to perform the operations described below.

- **Adjust image brightness**

Highlight “Brightness” and then press the [ENTER] key.

→ This performs the same operation as pressing the [BRIGHT] key (○ key) described on page 12.

- **Turn the Eco Mode on or off**

Highlight “Eco Mode” and then press the [ENTER] key.

→ This performs the same operation as pressing the [ECO] key (△ key) described on page 18.

- **Select the aspect ratio of the projected image**

Highlight “Aspect Ratio” and then press the [ENTER] key.

→ This performs the same operation as pressing the [ASPECT] key (□ key) described on page 16.



Note

- **(for USB port model users)**

When the input source is an external device connected to the USB port, use the [FUNC], [○], [△], and [□] keys to control the connected device. For details, see the “USB Function Guide” and “Wireless Function Guide” on the bundled CD-ROM.

Configuring Advanced Projector Settings

Your projector has a setup menu that you can use to configure advanced settings.

Basic Setup Menu Operations

Displaying the Setup Menu

Pressing the [MENU] key displays the menu shown below in the center of the projection screen.

Main menu
Pressing the [MENU] key displays the main menu. The currently selected menu item is the one that is highlighted.

Sub-menu
The sub-menu shows each individual setting under each main menu item, and its current setting.

Guidance text
Guidance text provides a brief description of the main key operations available for the operation you are currently performing.

KEY
Q01 3,000
Q02 5,000
Q04 8,000
Q03 6,500
Q02 5,000
Q03 16,000
Q04 19,000

To exit the setup menu

Press the [MENU] key.

Configuring Setup Menu Settings

1. Press the [MENU] key to display the setup menu.
2. Use the [▼] and [▲] keys to select the main menu item you want by highlighting it.
3. Press the [ENTER] key.
4. Use the [▼] and [▲] keys to select the sub-menu item you want by highlighting it.
5. Perform the required operation on the selected sub-menu item screen.
 - The guidance text explains the operations you need to perform to configure each setting.
6. To return to the main menu from the sub-menu, press the [ESC] key.
7. To exit the setup menu, press the [MENU] key.

Basic Setup Menu Example

The procedure below shows how to configure the following three settings:

- Image Adjustment 1 → Contrast
- Image Adjustment 1 → Color Mode
- Input Settings → Signal Name Indicator



Note

- The setup menu items that you can change depend on whether or not an image signal is being input to the projector, and on the currently selected input source. Perform the procedure below after starting projection of an image from an input source in the normal input mode. See “3D Input Mode” on page 10 for information about how to do this.
- This example covers basic steps only. For more detailed information, see “Setup Menu Contents” on page 28.

To configure the “Image Adjustment 1 → Contrast” setting

1. Press the [MENU] key to display the setup menu.
2. “Image Adjustment 1” is initially selected on the main menu, so simply press the [ENTER] key.
3. Use the [▼] key to select “Contrast”.

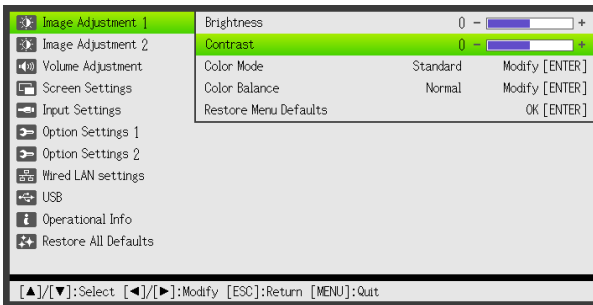

4. Use the [◀] (lighter) and [▶] (darker) keys to adjust contrast.

To configure the “Image Adjustment 1 → Color Mode” setting

5. Use the [▼] key to select “Color Mode”.
6. Press the [ENTER] key.
 - This displays the color mode menu.
7. Use the [▼] and [▲] keys to select the color mode you want, and then press the [ENTER] key.
8. After selecting the color mode you want, press the [ESC] key.

To configure the “Input Settings → Signal Name Indicator” setting

9. Press the [ESC] key.
10. Use the [▼] key to select “Input Settings”.
11. Press the [ENTER] key.
12. Use the [▼] key to select “Signal Name Indicator”.
13. Use the [◀] and [▶] keys to select “On” or “Off”.
14. After you are finished, press the [MENU] key to exit the setup menu.

Direct Power On

You can configure the projector so it powers up automatically as soon as you plug it into a power source. With this “Direct Power On” feature, you do not even need to press the [⏻] (Power) key. To enable Direct Power On, display the setup menu, and then change the “Direct Power On” setting to “On”.



Important!

When you have Direct Power On enabled, do not leave the projector plugged into an electrical outlet while it is turned off. If you do, there is the chance that it (and the light source unit) might turn on automatically when power is restored after being cut off by a power outage, tripping of a breaker, etc.



Note

- Direct Power On causes the projector to turn on automatically as soon as it is plugged into a power outlet. This greatly reduces the amount of time it takes until you are ready to start projecting. Note, however, that the actual startup sequence (Standby State → Power On → Projection Starts) that the projector performs is the same, regardless of whether Direct Power On is enabled or disabled. The only difference is what triggers the sequence (plugging in or pressing the [⏻] (Power) key).
- For details about configuring the Direct Power On setting, see “Direct Power On” under “Option Settings 1 Main Menu” on page 34.

Password Protecting the Projector

The password feature lets you keep unauthorized individuals from using the projector. You can specify whether password input is required whenever you turn on the projector, and you can specify and change the password as required. Use the setup menu "Option Settings 1 → Power On Password" setting to configure power on password settings.

Inputting a Password

The password of your projector is not really a "word" made up of letters, but rather a sequence of remote controller key inputs. The following is the 8-key sequence that represents the initial factory default password.

[INPUT] [AUTO] [BLANK] [FREEZE] [▲] [▼] [◀] [▶]

Using the Password Feature

Note the following precautions whenever you use the password feature.

- The password feature protects against unauthorized use of the projector. Note that it is not an anti-theft measure.
- You will need to enter the initial factory default password the first time you use the projector after turning on the password feature. Change the initial factory default password to a different one of your choice as soon as possible after turning on the password feature.
- Remember that password operations are always performed using the remote controller, so you should take care not to lose or misplace the remote controller.
- Also note that you will not be able to input the password if the remote controller batteries are dead. Replace the remote control batteries as soon as possible after it starts to go low.

If you forget your password...

You will not be able to use the projector if you forget the password for some reason. If you forget the password, you will need to bring the following two items to your CASIO distributor to have the password cleared. Note that you will be charged to have the password cleared.

1. Personal identification (original or copy of your driver's license, employee I.D., etc.)
2. Projector unit

Note that your CASIO distributor will not be able to clear the password of your projector unless you bring both of the items listed above.

Also, keep the projector's warranty in a safe place.



Important!

Having your password cleared using the procedure described above will return all of the settings of your projector, except for the Light Time, to their initial factory defaults.

Keep a written record of your password!

You will not be able to use the projector if you forget its password. We strongly suggest that you keep a written or other type of record of the password so you can look it up when necessary.

To change the password

1. Press the [MENU] key to display the setup menu.
2. Use the [▼] key to select “Option Settings 1”, and then press the [ENTER] key.
3. Use the [▼] key to select “Power On Password”, and then press the [ENTER] key.

- This will display a dialog box prompting you to enter the current password.

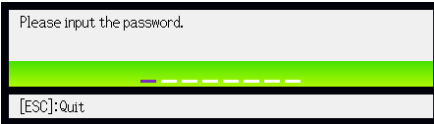

4. Enter the current password.

- If the projector is still protected by the factory default password, perform the key operation shown below to enter it.

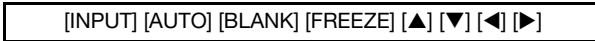

5. After entering the current password, press the [ENTER] key.

- This displays the Power On Password setting screen.

6. Use the [▼] key to select “Change Password”, and then press the [ENTER] key.

- This will display a dialog box prompting you to enter the new password.

7. Enter a key sequence up to eight key operations long.

- You can use any of the following keys as part of your password key sequence.
[INPUT], [AUTO], [BLANK], [FREEZE], [VOLUME], [COLOR MODE], [D-ZOOM +], [D-ZOOM -], [KEYSTONE +], [KEYSTONE -], [MENU], [POINTER], [○], [△], [□], [▲], [▼], [◀], [▶], [FUNC]

8. After entering the new password, press the [ENTER] key.

- This will display a dialog box prompting you to enter the same password again.

9. Re-enter the same password key sequence you entered in step 7 and then press the [ENTER] key.

- The message “Your new password has been registered.” indicates that the password has been changed. Press the [ESC] key.
- If the password you entered in this step is different from the one you entered in step 7, the message “The password you input is wrong.” appears. Press the [ESC] key to return to step 7.

To turn password protection on and off

- 1. Display the Power On Password setting screen by performing steps 1 through 5 of the procedure under “To change the password” on page 24.**
 - At this time, make sure that “Power On Password” is selected on the Power On Password setting screen.
- 2. Use the [◀] and [▶] keys to select “On” or “Off”.**
 - Changing the power on password setting from “Off” to “On” causes the confirmation dialog box shown below to appear.

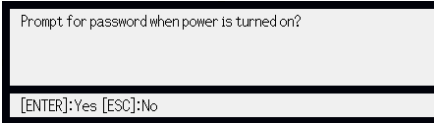

Press the [ENTER] key to confirm that you want to turn on power on password protection, or [ESC] to exit the dialog box without doing anything.

- 3. After you are finished, press the [MENU] key to exit the setup menu.**

Entering the Password when Turning On the Projector

When you turn on the projector while password protection is turned on will cause a password input dialog box to appear on the projection screen. All projector operations will be accessible to you after you input the correct password and press the [ENTER] key.

Restoring Projector Settings to Their Initial Factory Defaults

You can use the procedures in this section to restore all of the settings on a particular main menu or all of the settings on the setup menu to their initial factory defaults.

To restore all settings on a particular main menu to their initial factory defaults

1. Press the [MENU] key to display the setup menu.
2. Use the [▼] and [▲] keys to select the main menu whose settings you want to restore to their initial factory defaults.
 - You can select Image Adjustment 1, Image Adjustment 2, Volume Adjustment, Screen Settings, Input Settings, Option Settings 1, or Option Settings 2.
3. Press the [ENTER] key.
4. Use the [▼] key to select “Restore Menu Defaults”.
5. Press the [ENTER] key.
 - This will display a confirmation screen like the screen shown below.

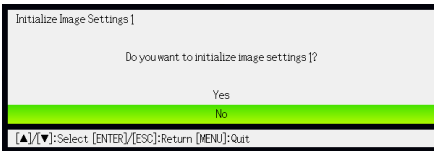

6. Use the [▲] key to select “Yes”.
7. To restore the settings of the main menu to their initial defaults, press the [ENTER] key.
 - To exit the operation without doing anything, press [ESC] instead of [ENTER].
8. After you are finished, press the [MENU] key to exit the setup menu.



Note

- The language setting and the password are not returned to their initial factory defaults if you select Option Settings 1 in step 2.
- For details about how the above procedure initializes settings, see the explanations of the settings under “Setup Menu Contents” on page 28.

To restore all settings on the setup menu to their initial factory defaults

1. Press the [MENU] key to display the setup menu.
2. Use the [▼] key to select “Restore All Defaults” and then press the [ENTER] key.
3. After confirming that “Restore All Defaults” sub-menu is selected, press the [ENTER] key.
 - This displays a confirmation message asking if you want to initialize all settings.
4. Use the [▲] key to select “Yes”.
5. To restore all settings on the setup menu to their initial defaults, press the [ENTER] key.
 - This will restore all of the settings to their initial factory defaults, except for the Language, Light Time, Unit Operating Time and password settings.
 - To exit the operation without doing anything, press [ESC] instead of [ENTER].
6. After you are finished, press the [MENU] key to exit the setup menu.

Setup Menu Contents

This section contains tables that provide detailed explanations of all of the items included on the setup menu. The following describes the type of information that appears in each of the columns of the tables.

Setting Name: This column shows the names of the settings as they appear on the sub-menu.

Input: This column shows the input source for which each setting is supported.

Input source names are abbreviated as follows:

R : RGB input

C : Component video input

V : Video or S-video input

H : HDMI (PC) input

D : HDMI (DTV) input

U : USB input (USB port models only)

The letter N indicates that the setting can be configured while there is no input signal.

Setting Unit: The setting unit indicates how a setting is stored.

“Source Specific” in this column indicates that separate settings can be stored for each individual input source.

“Single” in this column indicates that a single setting is stored and applied, regardless of the input source.

Description: This column provides details about the setting item and how to select it. The initial default setting is indicated by an asterisk (*).

Image Adjustment 1 Main Menu

Setting Name	Input	Setting Unit	Description
Brightness	R C V H D U	Source Specific	Use this sub-menu to adjust the brightness of the projected image. A larger value produces a brighter image.
Contrast	R C V H D U	Source Specific	Use this sub-menu to adjust the contrast of the projected image. A larger value produces a stronger contrast.
Sharpness	V	Source Specific	Use this sub-menu to adjust the sharpness of the outlines in the projected image. A larger value makes the image sharper, while a smaller value makes it softer.
Saturation	V	Source Specific	Use this sub-menu to adjust the color saturation of the projected image. A larger value increases color saturation.
Tint	V	Source Specific	Use this sub-menu to adjust the tint of the projected image. A larger value makes the overall image more bluish, while a smaller value makes the overall image more reddish. This setting is supported only when the signal is NTSC or NTSC4.43.

Setting Name	Input	Setting Unit	Description
Color Mode	R C V H D U	Source Specific	<p>You can select from among various different color mode settings in accordance with image contents and projection conditions.</p> <p>Standard: Use this setting when you want to highlight the colors of your presentation.</p> <p>Graphics: Use this setting when you want photographs and graphics to appear natural.</p> <p>Theater: Use this setting to bring out the dark portions of your images.</p> <p>Blackboard: Use this setting for easy viewing when projecting onto a blackboard.</p> <p>Game: Use this setting to optimize hue and brightness.</p>
Color Balance	R C V H D U	Source Specific	<p>This sub-menu lets you adjust the color balance of the projected image.</p> <p>Preset: You can select from among three preset color balance settings: Warm, Normal,* Cold.</p> <p>Color: You can adjust the intensity of red, green, and blue within the range of -50 to +50. The intensity of a color increases along with the setting value. Color settings can be adjusted individually only when "Normal" is selected as the "Preset" setting.</p>
Eco Off Mode	R C V H D U	Single	<p>When "Off" is selected for "Option Settings 1 → Eco Mode", you can select either of the following projection image modes.</p> <p>Bright: Gives priority to brightness.</p> <p>Normal: Suppresses brightness slightly and gives priority to color balance.</p>
Restore Menu Defaults	R C V H D U	Source Specific	<p>Use this sub-menu to return all of the sub-menu items on the Image Adjustment 1 main menu to their initial default settings.</p> <ul style="list-style-type: none"> ● Restoring menu defaults when there is no input signal will restore defaults for the currently selected input source.

Image Adjustment 2 Main Menu

Setting Name	Input	Setting Unit	Description
Vertical Position	R C V	Signal Specific	Use this sub-menu to adjust the vertical position of the input source image within the projection area.
Horizontal Position	R C V	Signal Specific	Use this sub-menu to adjust the horizontal position of the input source image within the projection area.
Frequency	R	Signal Specific	When vertical bands appear in the projected image while RGB is selected as the input source, it means that the frequency setting is not correct. When this happens, use this setting to adjust the frequency manually.  Important! _____ If, for some reason, your manual frequency settings cause the image input from the computer to disappear from the projection, you can press the [AUTO] key to perform an auto adjust operation, which should cause the image to appear.
Phase	R	Signal Specific	When there is flickering in the projected image while RGB is selected as the input source, it means that the phase setting is not correct. When this happens, use this setting to adjust the phase manually.
Restore Menu Defaults	R C V	Source Specific	Use this sub-menu to return all of the sub-menu items on the Image Adjustment 2 main menu to their initial default settings. <ul style="list-style-type: none"> Restoring menu defaults will restore defaults for the current signal type (XGA/60Hz, SXGA/60Hz, etc.) only.



About the “Signal Specific” Setting Unit

For the items that have “Signal Specific” in the “Setting Unit” column of the above table, the setting is saved for the specific type of signal (XGA/60Hz, SXGA/60Hz, etc.) that is being input when the setting is performed, and not for a specific input source.

Volume Adjustment Main Menu

Setting Name	Input	Setting Unit	Description
Volume	R C V H D U N	Source Specific	Use this sub-menu to adjust the volume level of the projector’s speaker. <ul style="list-style-type: none"> Changing this setting when there is no input signal changes the volume setting of the currently selected signal source.
Restore Menu Defaults	R C V H D U N	Source Specific	Use this sub-menu to return Volume to its initial default setting. <ul style="list-style-type: none"> Restoring menu defaults when there is no input signal will restore defaults for the currently selected input source.

Screen Settings Main Menu

Setting Name	Input	Setting Unit	Description
Keystone Correction	R C V H D U N	Single	Use this sub-menu to correct vertical keystone of the projected image.
Aspect Ratio	R C V H D	Source Specific	<p>Use this sub-menu to select an aspect ratio setting for the projected image.</p> <p>Input Source: RGB or HDMI (PC)</p> <p>Normal*: Projects at the projector's maximum possible size while maintaining the input signal aspect ratio.</p> <p>Full: Projects at the projector's maximum possible size by enlarging or reducing the input signal.</p> <p>True (XJ-M240/XJ-M245/XJ-M250/XJ-M255 only): Projects the input signal at its actual size (1 input source dot equal to one projector output pixel dot) in the center of the projector's projection screen. If the input signal resolution exceeds the projector's output resolution, the excess is cut off.</p> <p>Input Source: Video, S-video, Component or HDMI (DTV)</p> <p>Normal*: Projects at the projector's maximum possible size while maintaining the input signal aspect ratio.</p> <p>16:9 : This setting specifies a 16:9 aspect ratio, which is the same as a movie screen, high-definition TV, etc. Using this setting when the input signal is a 16:9 image that has been squeezed to a 4:3 image causes the image to be displayed with its normal 16:9 aspect ratio.</p> <p>Letter Box (XJ-M240/XJ-M245/XJ-M250/XJ-M255 only): This will resize the image horizontally to 1280 dots and project 800 vertical dots of the center of the image, maintaining the aspect ratio of the input signal.</p> <p> Note</p> <ul style="list-style-type: none"> • When the input source is a component or an HDMI (DTV) signal with an aspect ratio of 16:9, the aspect ratio is fixed at 16:9. The aspect ratio setting cannot be changed in this case. • When projecting while "True" is selected as the aspect ratio setting for an RGB signal with a resolution that is less than SVGA, the image is enlarged to SVGA and projected. • For details about projection screen display conditions for different aspect ratio settings, see "Aspect Ratio Setting and Projection Image" (page 48). <p> Important!</p> <p>Note that enlarging or reducing the size of an image for commercial purposes or public presentation may infringe on the legally protected copyright of the copyright holder of the original material.</p>
Projection Mode	R C V H D U N	Single	<p>Use this sub-menu to specify whether projection will be from the front of the screen or the back of the screen.</p> <p>Front*: Select this option to project from the front of the screen.</p> <p>Rear: Select this option to project from the back of the screen. This setting flips the front projected image horizontally.</p>

Setting Name	Input	Setting Unit	Description
Ceiling Mount	R C V H D U N	Single	Use this sub-menu to configure the projector for use in an installation in which it is positioned upside down. On: Flips the projected image horizontally and vertically. Off*: Projects a normal image.
Startup Screen	R C V H D U N	Single	Use this sub-menu to specify whether or not a startup screen should be projected whenever the projector is turned on. Logo: Select this option to project the projector's built-in logo screen at startup. None*: Select this option when you do not want to project a startup screen.
No Signal Screen	R C V H D U N	Single	Use this sub-menu to specify what should be projected when there is no input signal to the projector. Blue*: Select this option to project a blue screen. Black: Select this option to project a black screen. Logo: Select this option to project the projector's built-in logo screen.
Blank Screen	R C V H D U N	Single	Use this sub-menu to specify what should be projected after the [BLANK] key is pressed. Blue: Select this option to project a blue screen. Black*: Select this option to project a black screen. Logo: Select this option to project the projector's built-in logo screen.
Restore Menu Defaults	R C V H D U N	Source Specific	Use this sub-menu to return all of the sub-menu items on the Screen Settings main menu to their initial default settings. <ul style="list-style-type: none"> Restoring menu defaults when there is no input signal will restore defaults for the currently selected input source. Note that the "Keystone Correction", "Projection Mode", "Ceiling Mount", "Startup Screen", "No Signal Screen", and "Blank Screen" settings are always returned to their initial defaults, regardless of the currently selected input source.

Input Settings Main Menu

Setting Name	Input	Setting Unit	Description
COMPUTER Terminal	R C N	Single	<p>Use this sub-menu to specify manually the type of signal being input from the projector's COMPUTER IN terminal.</p> <p>Auto*: Automatically detects the signal being input from the COMPUTER IN terminal and configures the appropriate input protocol.</p> <p>RGB: Select this option when a computer is connected to the COMPUTER IN terminal. For details about connecting a computer, see "Connecting a Computer to the Projector" in the "Setup Guide".</p> <p>Component: Select this setting when the projector's COMPUTER IN terminal is connected to the component video output terminal of a video device using a commercially available component video cable. For information about connection, see "Connecting to a Video Device" (page 43).</p> <p> Note The setting of this item cannot be changed while the projector is in the 3D input mode. See "3D Input Mode" on page 10 for information.</p>
Video Signal / S-Video Signal	V N	Single	<p>Use this sub-menu to specify manually the type of signal being input from the projector's VIDEO terminal or S-VIDEO terminal.</p> <p>Auto*: Select this setting to have the projector switch the video signal system automatically in accordance with the input signal from the video device that is connected to the VIDEO terminal or S-VIDEO terminal.</p> <p>NTSC / NTSC4.43 / PAL / PAL-M / PAL-N / PAL60 / SECAM: Each setting selects the applicable video system. Use these settings when you want to specify only one specific video signal for the VIDEO terminal or S-VIDEO terminal.</p>
Signal Name Indicator	R C V H D U N	Single	<p>Use this sub-menu to specify whether or not the name of the currently selected signal source should be displayed in the projected image.</p> <p>On*: Select this option to turn on display of the name of the currently selected signal source in the projected image.</p> <p>Off: Select this option to turn off display of the signal source name.</p>
Restore Menu Defaults	R C V H D U N	Source Specific	<p>Use this sub-menu to return all of the sub-menu items on the Input Settings main menu to their initial default settings.</p> <ul style="list-style-type: none"> Restoring menu defaults when there is no input signal will restore defaults for the currently selected input source. Note that the "Signal Name Indicator" setting is always returned to its initial default, regardless of the currently selected input source.

Option Settings 1 Main Menu

Setting Name	Input	Setting Unit	Description
Auto Keystone Correction	R C V H D U N	Single	Use this sub-menu to turn auto keystone correction on or off. On*: Select this option to turn on auto keystone correction. Off: Select this option to turn off auto keystone correction.
Auto Adjust	R C V H D U N	Source Specific	Use this sub-menu to select whether the projector should detect the RGB input signal type (resolution, frequency) and adjust the projection image accordingly (auto adjust). 1*: Select this option to turn on auto adjust. 2: Select this option to turn on auto adjust when a 1360 × 768 or 1400 × 1050 signal is not projected correctly. 3: Select this option to turn on auto adjust when a 1366 × 768 signal is not projected correctly. Off: Select this option to turn off auto adjust.
Eco Mode	R C V H D U N	Single	See “Eco Mode (Power Saving, Low Noise)” (page 18).
Auto Power Off	R C V H D U N	Single	Auto Power Off lets you specify the amount of time of projector operation and input signal inactivity to be allowed before Auto Power Off is triggered to turn off projector power automatically. Auto Power Off can be disabled, if you want. 5 min, 10 min*, 15 min, 20 min, 30 min: Time until Auto Power off is triggered. Off: Disables Auto Power Off.
Power On Password	R C V H D U N	Single	You can configure the projector to require input of a password before operation is enabled. For details, see “Password Protecting the Projector” on page 23.
Direct Power On	R C V H D U N	Single	Use this sub-menu to turn Direct Power On on or off. See “Direct Power On” on page 22. On: Select this option to turn on Direct Power On. Off*: Select this option to turn off Direct Power On.

Setting Name	Input	Setting Unit	Description
Language	R C V H D U N	Single	<p>Use this sub-menu to specify the language to use for messages, setup menus, etc.</p> <p>English / French / German / Italian / Spanish / Swedish / Portuguese / Turkish / Russian / Chinese (Simplified) / Chinese (Traditional) / Korean / Japanese</p> <p> Note</p> <p>(for USB port model users)</p> <p>If you have Portuguese, Turkish, or Russian selected as the projector's language, selecting an external device connected to the projector's USB port as the input source will cause some menus and messages to be displayed in English.</p>
Restore Menu Defaults	R C V H D U N	Single	<p>This sub-menu returns all of the sub-menu items on the Option Settings 1 main menu to their initial default settings.</p> <ul style="list-style-type: none"> ● The language setting and the password are not returned to their initial factory defaults. ● The "Auto Adjust" item is returned to its initial default only when RGB input is selected for the input source. All of the other items are returned to their initial defaults regardless of the currently selected input source.

Option Settings 2 Main Menu

Setting Name	Input	Setting Unit	Description
Pointer	R C V H D U N	Single	<p>Use this sub-menu to specify the type of pointer that appears first when you press the [POINTER] key.</p>
Plug and Play (USB port models only)	R C V H D U N	Single	<p>Use this sub-menu to turn plug-and-play**1 on or off.</p> <p>On*:</p> <p>Select this option to turn on plug-and-play. This will allow the projector detect when an external USB device is connected and make that device the input source automatically.</p> <p>Off:</p> <p>Select this option to turn off plug-and-play.</p> <p> Note</p> <p>Regardless of the setting of this item, plug-and-play is disabled while the projector is in the 3D input mode. See "3D Input Mode" on page 10 for information.</p>
Audio Out	R C V H D U N	Single	<p>Specifies whether the input audio signal should be output from the projector's built-in speaker or to the line output.</p> <p>Speaker*:</p> <p>Outputs the audio signal being input to the projector from the speaker.</p> <p>Line:</p> <p>Outputs the audio signal being input to the projector from the AUDIO OUT terminal.</p>

Setting Name	Input	Setting Unit	Description
High Altitude	R C V H D U N	Single	<p>Use this sub-menu to turn the high-altitude fan speed setting on or off in accordance with the altitude of the area where you are using the projector.</p> <p>On: Select this setting when using the projector in a high altitude (1,500 to 3,000 meters above sea level) area where air is thin. This setting increases cooling efficiency.</p> <p>Off*: Select this setting at normal altitudes (up to 1,500 meters).</p> <p> Important! _____ Do not use this projector at altitudes greater than 3,000 meters above sea level.</p>
Restore Menu Defaults	R C V H D U N	Single	This sub-menu returns all of the sub-menu items on the Option Settings 2 main menu to their initial default settings.

*1 When plug-and-play is turned on, the projector will make that device the input source automatically. For details about plug-and-play, see “USB Function Guide” on the bundled CD-ROM.

Wired LAN Settings Main Menu (USB Port Models Only)

Setting Name	Input	Setting Unit	Description
Remote on	R C V H D U N	Single	<p>Specifies whether the projector can be turned on via wired LAN while the projector is in standby (projector off with power being supplied).</p> <p>Enable: Power on enabled.</p> <p>Disable*: Power on disabled.</p> <p> Important! _____ Initializing wired LAN settings or performing a “Restore All Defaults” operation with the setup menu will cause this setting to change to “Disable”. If you are operating the projector using a wired LAN setting, be sure to change this setting back to “Enable” after initialization.</p>
PJLink authentication	R C V H D U N	Single	<p>Enables and disables PJLink connection authentication.</p> <p>Enable*: PJLink connection authentication enabled.</p> <p>Disable: PJLink connection authentication disabled.</p>
Wired LAN info	R C V H D U N	Single	<p>Displays the following information.</p> <p>Projector name: Name currently assigned to the projector.</p> <p>MAC Address: Fixed MAC address assigned to each individual projector.</p> <p>IP Address: Projector’s current IP address.</p> <p>DHCP: Projector’s current DHCP setting status (“Auto” or “Disable”).</p> <p>The projector name, IP address, and DHCP settings can be configured using the projector System Admin page, which can be accessed on a computer connected by LAN to the projector. For details, see the “Wireless Function Guide” on the CD-ROM that comes with the projector.</p>
Initialize wired LAN settings	R C V H D U N	Single	<p>Use this sub-menu to return all of the sub-menu items on the wired LAN main menu to their initial default settings.</p>

USB Settings Main Menu (USB Port Models Only)

The USB Settings main menu is available only when there is an external device connected to the USB port of the projector. For details, see “USB Function Guide” and “Wireless Function Guide” on the bundled CD-ROM.

Operational Info Main Menu

Setting Name	Input	Setting Unit	Description
Input Signal	R C V H D U N	Source Specific	This sub-menu item shows the currently selected input signal (RGB, Component, Video, S-video, HDMI (PC), or HDMI (DTV)). “- - - -” is indicated here when there is no input signal.
Signal Name	R C V H D U	Source Specific	This sub-menu item shows the signal name of the signal being input to the projector. For details about signal names, see “Signal Name” under “Supported Signals” on page 52.
Resolution	R H	Source Specific	This sub-menu item appears only when RGB is the input signal. It shows the number of vertical and horizontal pixels of resolution of the RGB or HDMI (PC) input signal.
Horizontal Frequency	R C V H D	Source Specific	This sub-menu item shows the horizontal frequency of the input signal.
Vertical Frequency	R C V H D	Source Specific	This sub-menu item shows the vertical frequency of the input signal.
Scan System	R C H D	Source Specific	This sub-menu item appears only when RGB, Component, HDMI (PC), or HDMI (DTV) is the input signal, and shows the scan system of the input signal. The scan system is interlace or non-interlace for an RGB or HDMI (PC) signal input, and interlace or progressive for a component or HDMI (DTV) signal input.
Light Time	R C V H D U N	Single	This sub-menu item shows the cumulative number of hours the current light source unit has been used to date.

Restore All Defaults Main Menu

Setting Name	Input	Setting Unit	Description
Unit Operating Time	R C V H D U N	Single	This sub-menu item shows the cumulative operating time of this unit. This time cannot be initialized.
Restore All Defaults	R C V H D U N	Single	This sub-menu returns all sub-menu items on all main menus to their initial default settings. This operation can be performed regardless of the currently selected input source and regardless of whether or not a signal is currently being input. For details about this procedure, see “To restore all settings on the setup menu to their initial factory defaults” on page 27.

Cleaning the Projector

Periodically clean the projector exterior, lens, intake vents, exhaust vents, and airflow vents on a regular basis.



Important!

Before cleaning the projector, be sure to unplug it from the power outlet and make sure it is cooled down completely.

Cleaning the Projector Exterior

Wipe the exterior of the projector with a soft cloth that has been moistened in a weak solution of water and a mild neutral detergent. Be sure to wring all excess moisture from the cloth before wiping. Never use benzene, alcohol, thinner, or any other volatile agent for cleaning.

Cleaning the Lens

Carefully wipe the lens with a commercially available lens cloth or optical lens paper, like those for eyeglasses or camera lenses. When cleaning the lens, do not apply undue force and take care to avoid damaging the lens.

Cleaning Intake, Exhaust and Airflow Vents

Dust and dirt tend to collect around the intake vents. Because of this, you should use a vacuum cleaner to clean away accumulated dust and dirt periodically as shown below.

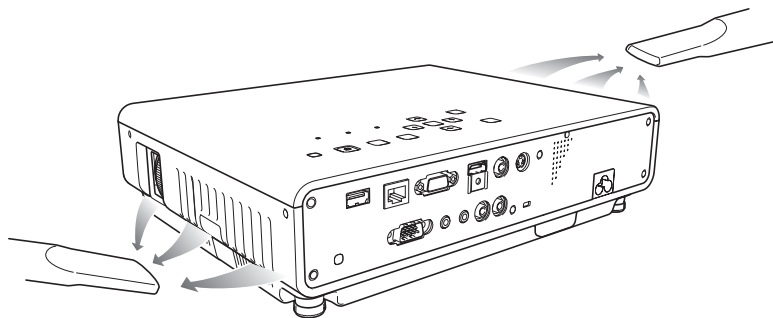

Important!

- Continued use of the projector after dust has accumulated around the intake vents can cause overheating of internal components and lead to malfunction.
- Certain operating conditions also can cause dirt and dust to accumulate around the projector's exhaust vents and airflow vents. If this happens, use the same procedure as that described above to clean the exhaust vents and airflow vents.

Error Indicators and Warning Messages

Warning messages and indicators let you know what the problem is when a projector error occurs. When an error occurs, wait until the fan stops before unplugging the AC power cord. If you unplug the AC power cord while the fan is still operating, an error may occur when you plug the AC power cord back in.

Indicator/Error Message	Description and Required Action
<p>POWER : Green steady</p> <p>LIGHT : –</p> <p>TEMP : –</p> <p>Message : Internal temperature is too high. Check projector air vents for blockage.</p>	<p>The projector's internal temperature is very high. Press the [ESC] key to clear the warning message and perform the following steps.</p> <p>① Check for any blocking of the projector's intake vents, exhaust vents and airflow vents, and make sure that there is sufficient space around the projector. See "Setup Precautions" in the "Setup Guide".</p> <p>② If there is dust accumulated around the intake vents, exhaust vents and/or airflow vents, turn off the projector and remove it. See "Cleaning the Projector" (page 39).</p>
<p>POWER : Amber flashing → Amber steady</p> <p>LIGHT : –</p> <p>TEMP : –</p> <p>Message : Internal temperature is too high. The projector will turn off.</p>	<p>Power has turned off automatically due to internal overheating. Perform the following steps.</p> <p>① Check for any blocking of the projector's intake vents, exhaust vents and airflow vents, and make sure that there is sufficient space around the projector. See "Setup Precautions" in the "Setup Guide".</p> <p>② If there is dust accumulated around the intake vents, exhaust vents and/or airflow vents, remove it. See "Cleaning the Projector" (page 39). If there is no problem with the projector's vents, confirm that the POWER/STANDBY indicator is lit amber (without flashing), and then turn power back on again. If the error occurs again when you turn power back on, contact your retailer or nearest authorized CASIO Service Center.</p>
<p>POWER : Amber flashing → Red steady</p> <p>LIGHT : Red steady</p> <p>TEMP : Red steady</p> <p>Message : There is a problem with the fan. The projector will turn off.</p>	<p>Power has turned off automatically due to a fan problem. Confirm that the POWER/STANDBY indicator is lit red (without flashing) and that the fan has stopped. After checking the POWER/STANDBY indicator, disconnect the power cord from the projector and wait for all of the projector's indicators to go out. Next, reconnect the power cord and turn projector power back on.</p> <p>If the error occurs again when you turn power back on, contact your retailer or nearest authorized CASIO Service Center.</p>
<p>POWER : Amber flashing → Red steady</p> <p>LIGHT : –</p> <p>TEMP : Red steady</p> <p>Message : A system problem has occurred. The projector will turn off.</p>	<p>Power has turned off automatically due to a system problem. After confirming that the POWER/STANDBY indicator is lit red (without flashing), disconnect the power cord from the projector and wait for all of the projector's indicators to go out. Next, reconnect the power cord and turn the projector back on.</p> <p>If the error occurs again when you turn power back on, contact your retailer or nearest authorized CASIO Service Center.</p>

Indicator/Error Message	Description and Required Action
POWER : Green steady LIGHT : – TEMP : – Message : A system problem has occurred. Normal projection is not possible.	A system problem has occurred, which may cause problems with some functions. Turn off the projector, disconnect the power cord from the projector and wait for all of the projector's indicators to go out. Next, reconnect the power cord and turn the projector back on. If the error occurs again when you turn power back on, contact your retailer or nearest authorized CASIO Service Center. Press the [ESC] key to clear the warning message.
POWER : Green steady LIGHT : – TEMP : – Message : There is some problem with the system. The audio function may not operate correctly.	
POWER : Green steady LIGHT : – TEMP : – Message : Some problem occurred with the USB port or LAN terminal.	The USB or LAN connection was terminated because of a problem with the USB port or LAN port. To use the USB or LAN function, turn off the projector and then turn it back on again. If the error occurs again when you turn power back on, contact your retailer or nearest authorized CASIO Service Center. Press the [ESC] key to clear the warning message.
POWER : Amber flashing → Red steady LIGHT : – TEMP : Red steady Message : –	The projector was turned off automatically due to some problem that was probably caused by external digital noise or some other reason. Confirm that the POWER/STANDBY indicator is lit red (without flashing). After checking the POWER/STANDBY indicator, disconnect the power cord from the projector and wait for all of the projector's indicators to go out. Next, reconnect the power cord and turn projector power back on. If the error occurs again when you turn power back on, contact your retailer or nearest authorized CASIO Service Center.
POWER : Amber flashing → Red steady LIGHT : Red flashing (0.5-second interval) TEMP : Red flashing (0.5-second interval) Message : –	The projector was turned off automatically because the light source unit turned off or did not turn on. After confirming that the POWER/STANDBY indicator is lit red (without flashing), unplug the power cord. Wait for a short while and then plug it back in and turn on the projector again. If the error occurs again when you turn power back on, contact your retailer or nearest authorized CASIO Service Center.
POWER : Amber flashing → Red steady LIGHT : Not lit or red flashing TEMP : Red flashing (2-second interval) Message : –	Power has turned off automatically due to a projector memory error. Confirm that the POWER/STANDBY indicator is lit red (without flashing). After checking the POWER/STANDBY indicator, disconnect the power cord from the projector and wait for all of the projector's indicators to go out. Next, reconnect the power cord and turn projector power back on. If the error occurs again when you turn power back on, contact your retailer or nearest authorized CASIO Service Center.

Indicator/Error Message	Description and Required Action
POWER : Amber flashing → Red steady LIGHT : – TEMP : Amber flashing (1-second interval) Message : –	Power has turned off automatically because the light source unit cover is open. Perform the following steps. ① After confirming that the POWER/STANDBY indicator is lit red (without flashing), disconnect the power cord from the projector. ② Check to make sure that the light source unit cover is closed. ③ Plug the power cord back in and turn the projector back on again. If the error occurs again when you turn power back on, contact your retailer or nearest authorized CASIO Service Center.

Connecting to a Video Device

The projector is able to project images from the composite video output, S-video output, or component video output of a connected video device.



Important!

Always turn off the projector and the video device before connecting them.

Connection to a composite video output or S-video output

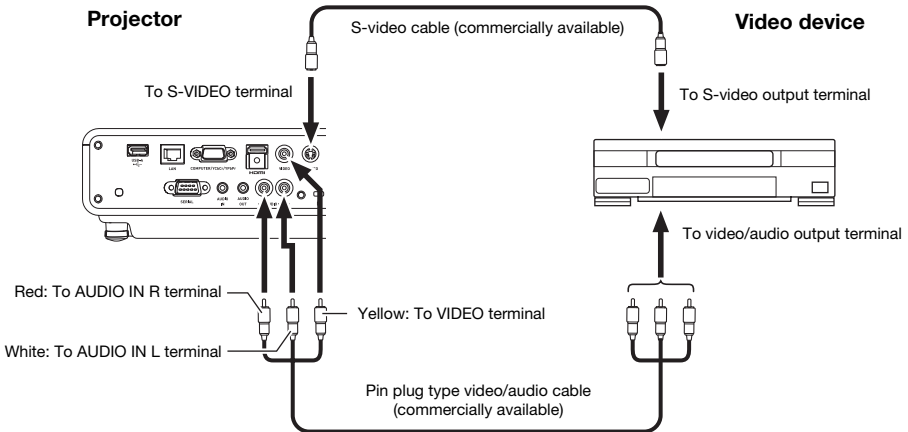

Note

Note that regardless of whether the image being projected is being input via the projector's S-VIDEO terminal or VIDEO terminal, the projector outputs audio that is input via the projector's AUDIO IN L/R terminals.

Connection to a component video output

Projector

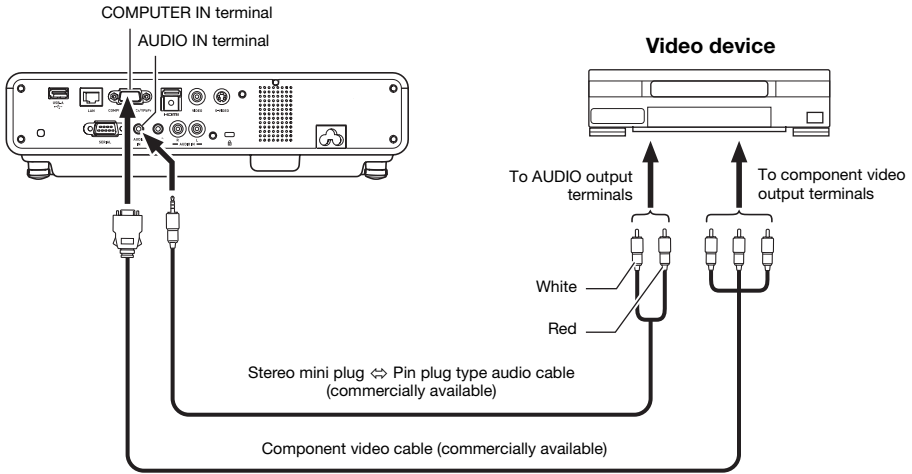

- Component video output terminals come in 3-terminal sets: Y-Cb-Cr or Y-Pb-Pr. Be sure to match the colors of the plugs on a component video cable with the colors of the terminals (Green: Y; Blue: Cb/Pb; Red: Cr/Pr).
- Note that connection only to an analog component video output terminal is supported. Connection to a digital output terminal is not supported.

Connecting the HDMI Output of a Video Device or Computer to the Projector

The projector supports projection and output of HDMI video and audio output from a computer or video device.



Important!

Turn off the projector and the computer or video device before connecting them.

Projector

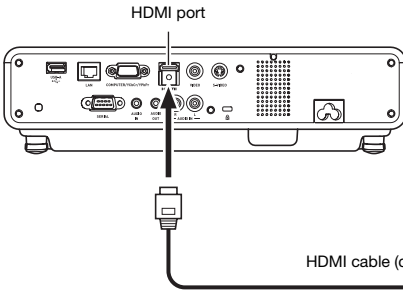

Computer or video device

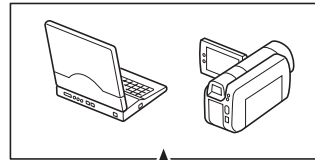

To HDMI output terminal

HDMI cable (commercially available)

- You will need to obtain a commercially available HDMI cable with a connector that matches the terminal of the output device on one end and a connector that matches the projector's HDMI port (HDMI Type A Socket) on the other end.
- For information about HDMI video signal supported by the projector, see page 54.
- The projector supports L-PCM 32kHz, 44.1kHz, and 48kHz HDMI audio signals.

Remote Controller Signal Range

When performing an operation on the remote controller, point it at the remote control signal receiver on the back or front of the projector. The following illustration shows the range of the remote controller signal.

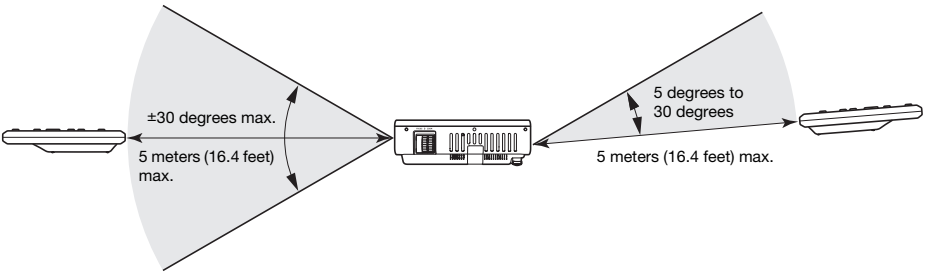
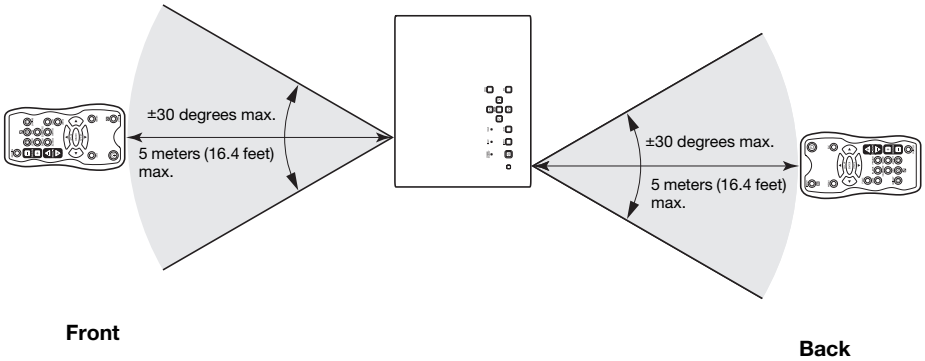

Remote Controller Range

The allowable distance between the remote controller and the projector is less when there is a sharp angle between the remote controller and the remote control signal receiver.



Important!

To avoid running down the batteries, store the remote control unit so its keys are not pressed inadvertently.

Projection Distance and Screen Size

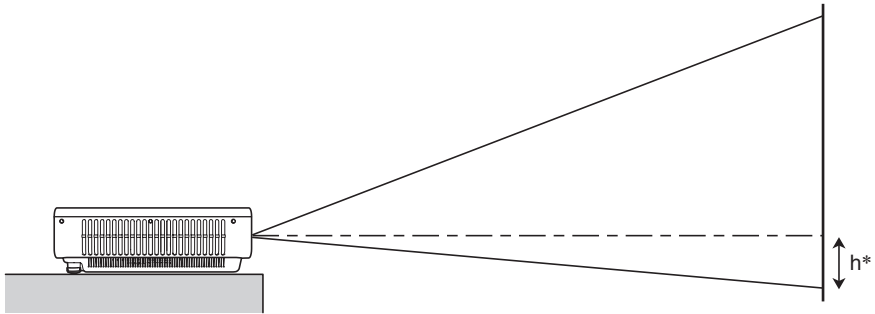

The following table shows the relationship between the distance and projected image size.

Projection Size		Approximate Projection Distance					
		XJ-M140/XJ-M145/ XJ-M150/XJ-M155			XJ-M240/XJ-M245/ XJ-M250/XJ-M255		
Screen Size	Diagonal (cm)	Minimum Distance (m / feet)	Maximum Distance (m / feet)	h*	Minimum Distance (m / feet)	Maximum Distance (m / feet)	h* (cm / inch)
30	76	1.0 / 3.28	1.5 / 4.92	0	-	-	-
35	89	-	-	-	1.0 / 3.28	1.5 / 4.92	8 / 3.15
40	102	1.3 / 4.27	2.0 / 6.56	0	1.1 / 3.61	1.7 / 5.58	9 / 3.54
60	152	2.0 / 6.56	3.0 / 9.84	0	1.7 / 5.58	2.5 / 8.2	13 / 5.12
80	203	2.7 / 8.86	4.0 / 13.12	0	2.3 / 7.55	3.4 / 11.15	18 / 7.09
100	254	3.4 / 11.15	5.0 / 16.4	0	2.9 / 9.51	4.2 / 13.78	23 / 9.06
150	381	5.0 / 16.4	7.4 / 24.28	0	4.3 / 14.11	6.3 / 20.67	34 / 13.39
200	508	6.8 / 22.31	9.9 / 32.48	0	5.8 / 19.03	8.4 / 27.56	45 / 17.72
300	762	10.2 / 33.46	14.9 / 48.88	0	8.7 / 28.54	12.6 / 41.34	67 / 26.38

* h = Height from the center of the lens to the bottom edge of the projection screen.



Important!

Note that the distances provided above are for reference only.

Aspect Ratio Setting and Projection Image

The following shows how images are projected in accordance with the type of the input signal and the aspect ratio setting of the projector.

XJ-M240/XJ-M245/XJ-M250/XJ-M255

Input source: RGB or HDMI (PC)

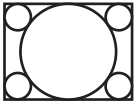
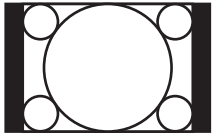
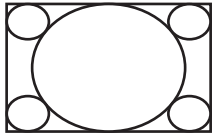
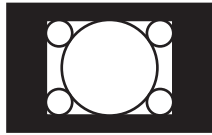
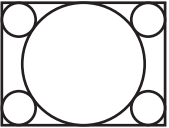
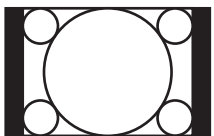
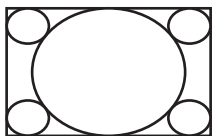
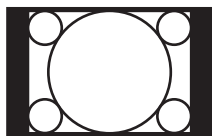
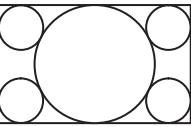
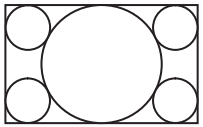
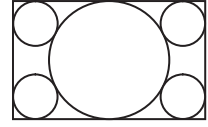
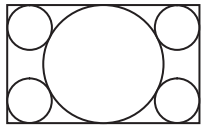
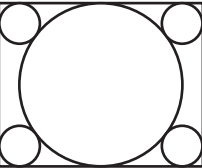
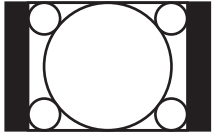
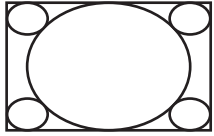
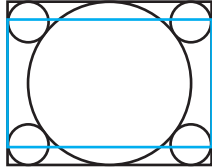
Input Signal	Normal	Full	True
SVGA (800 × 600) 			
XGA (1024 × 768) 			
WXGA (1280 × 800) 			
SXGA (1280 × 1024) 			 *

* The blue boundary indicates the projection area.

Input source: Video, S-video, component or HDMI (DTV)

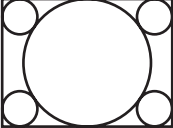
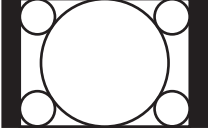
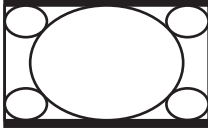
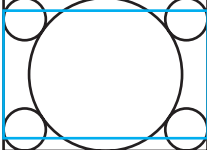
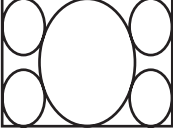
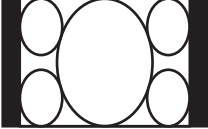
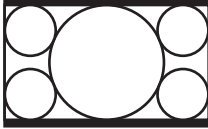
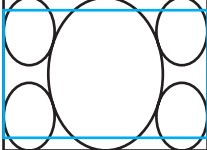
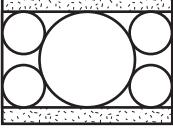
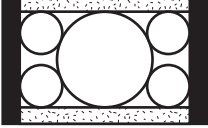
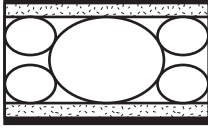
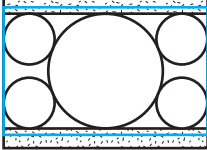
Input Signal	Normal	16:9	Letter Box
<p>4:3 Aspect Image</p> 			 <p style="text-align: right;">*</p>
<p>Squeezed Image</p> 			 <p style="text-align: right;">*</p>
<p>Letter Box Image</p> 			 <p style="text-align: right;">*</p>

* The blue boundary indicates the projection area.

XJ-M140/XJ-M145/XJ-M150/XJ-M155

Input source: RGB or HDMI (PC)

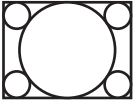
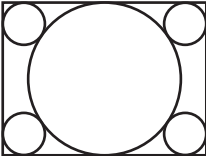
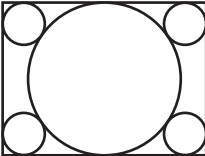
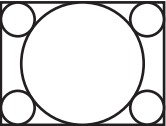
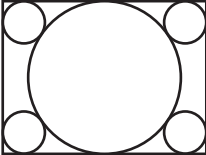
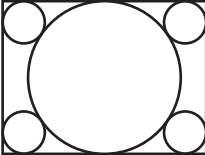
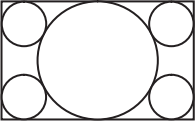
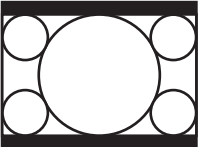
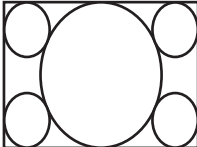
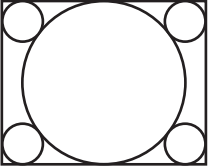
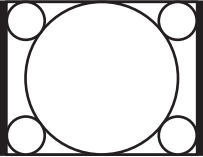
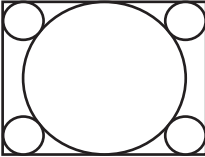
Input Signal	Normal	Full
SVGA (800 × 600) 		
XGA (1024 × 768) 		
WXGA (1280 × 800) 		
SXGA (1280 × 1024) 		

Input source: Video, S-video, component or HDMI (DTV)

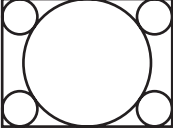
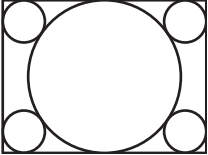
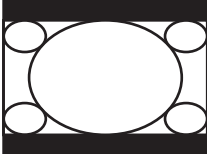
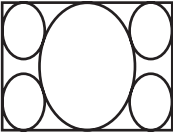
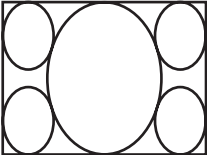
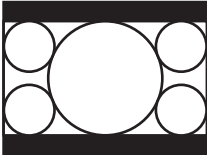
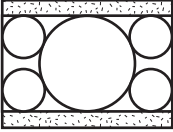
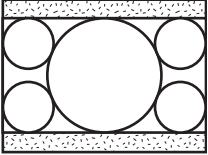
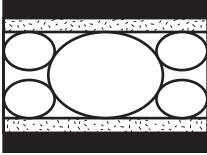
Input Signal	Normal	16:9
<p>4:3 Aspect Image</p> 		
<p>Squeezed Image</p> 		
<p>Letter Box Image</p> 		

Supported Signals



Important!

Even if a signal is listed in the table below, it does not guarantee that you will be able to display its images correctly.

RGB Signal

	Signal Name	Resolution	Horizontal Frequency (kHz)	Vertical Frequency (Hz)
VESA	640 × 480/60	640 × 480	31.5	60
	640 × 480/72	640 × 480	37.9	73
	640 × 480/75	640 × 480	37.5	75
	640 × 480/85	640 × 480	43.3	85
	800 × 600/56	800 × 600	35.2	56
	800 × 600/60	800 × 600	37.9	60
	800 × 600/72	800 × 600	48.1	72
	800 × 600/75	800 × 600	46.9	75
	800 × 600/85	800 × 600	53.7	85
	1024 × 768/60	1024 × 768	48.4	60
	1024 × 768/70	1024 × 768	56.5	70
	1024 × 768/75	1024 × 768	60.0	75
	1024 × 768/85	1024 × 768	68.7	85
	1152 × 864/75	1152 × 864	67.5	75
	1280 × 768/60	1280 × 768	47.8	60
	1280 × 800/60	1280 × 800	49.7	60
	1280 × 960/60	1280 × 960	60.0	60
	1280 × 960/85	1280 × 960	85.9	85
	1280 × 1024/60	1280 × 1024	64.0	60
	1280 × 1024/75	1280 × 1024	80.0	75
	1280 × 1024/85	1280 × 1024	91.1	85
	1360 × 768/60*1	1360 × 768	47.7	60
	1366 × 768/60*2	1366 × 768	47.7	60
1400 × 1050/A*1	1400 × 1050	65.3	60	
1440 × 900/60	1440 × 900	55.9	60	
1600 × 1200/60	1600 × 1200	75.0	60	
1680 × 1050/60	1680 × 1050	65.3	60	
Other	1152 × 864/70	1152 × 864	64.0	70
	1400 × 1050/B*1	1400 × 1050	64.0	60

*1 If these signals do not project correctly, change the “Option Settings 1 → Auto Adjust” setting to “2” (page 34).

*2 If this signal does not project correctly, change the “Option Settings 1 → Auto Adjust” setting to “3” (page 34).

Component Signal

	Signal Name	Horizontal Frequency (kHz)	Vertical Frequency (Hz)
HDTV	1080p/50	56.3	50
	1080p/60	67.5	60
	720p/50	37.5	50
	720p/60	45.0	60
	1080i/50	28.1	50
	1080i/60	33.7	60
SDTV	576p/50	31.3	50
	576i/50	16.6	50
	480p/60	31.5	60
	480i/60	15.7	60

Video Signal, S-video Signal

Signal Name	Horizontal Frequency (kHz)	Vertical Frequency (Hz)
NTSC	15.7	60
NTSC4.43	15.7	60
PAL	15.6	50
PAL-M	15.7	60
PAL-N	15.6	50
PAL60	15.7	60
SECAM	15.6	50

HDMI Signal

Signal Name	Horizontal Frequency (kHz)	Vertical Frequency (Hz)
640 × 480/60	31.5	60
800 × 600/60	37.9	60
1024 × 768/60	48.4	60
1280 × 768/60	47.8	60
1280 × 800/60	49.7	60
1280 × 960/60	60	60
1280 × 1024/60	64	60
1400 × 1050/60	65.3	60
SDTV (480p)	31.5	60
SDTV (576p)	31.25	50
HDTV (720p) (50)	37.5	50
HDTV (720p) (60)	45	60
HDTV (1080i) (50)	28.13	50
HDTV (1080i) (60)	33.75	60
HDTV (1080p) (50)	56.25	50
HDTV (1080p) (60)	67.5	60

3D Signals (3D Input Mode)

	Signal Name	Horizontal Frequency (kHz)	Vertical Frequency (Hz)
RGB Signal	640 × 480/60	31.5	60
	640 × 480/120	31.5	120
	800 × 600/60	37.9	60
	800 × 600/120	37.9	120
	1024 × 768/60	48.4	60
	1024 × 768/120	48.4	120
	1280 × 768/60	47.8	60
	1280 × 768/120	47.8	120
	1280 × 800/60	49.7	60
	1280 × 800/120	49.7	120
Video Signal	NTSC	15.7	60

Using Wired LAN to Control the Projector

(XJ-M145, XJ-M155, XJ-M245, XJ-M255)

The projector can be controlled by a computer or other external device by connecting the device to the projector's LAN port.

Supported External Devices

This projector supports all commands of PJLink Class1 (Version 1.00).

<http://pjlink.jbmia.or.jp/english/>

Information about the types of external devices that can be connected to the LAN port and control the projector, as well as the control commands supported for each external device will be published on the CASIO website below as such information becomes available.

<http://www.casio.com/support/>

Controlling the Projector from a Computer

When the projector is linked to a computer over a wired or wireless LAN connection, you can use the computer's Web browser to access a Wireless Presentation System control panel to control the projector.

To establish a wired LAN connection between the projector and a computer

1. Connect the LAN port of the projector to the LAN hub or other network devices to which the computer is connected.

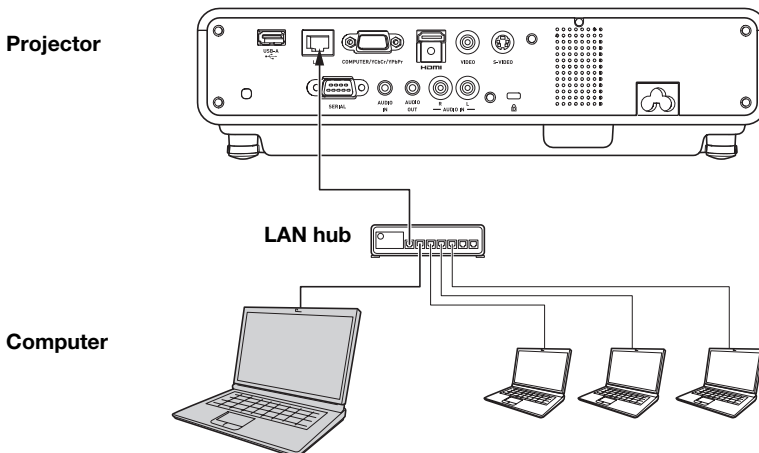

- In a configuration like the one in the illustration above, you should normally use straight type LAN cables. If you are connecting the projector's LAN port directly to the LAN port of a computer, use a cross type LAN cable.

2. Look up the projector's IP address.

- Perform the following steps to look up the projector's current IP address.
 1. Press the [MENU] key to display the setup menu.
 2. Use the [▼] and [▲] keys to select "Wired LAN settings" and then press the [ENTER] key.
 3. Use the [▼] and [▲] keys to select "Wired LAN info" and then press the [ENTER] key.

3. On the computer, start up a Web browser.

4. In the Web browser address bar, input the projector's IP address and then press the [Enter] key.

- If the projector's current IP address is 192.168.100.10, for example, you would input: "http://192.168.100.10".
- This displays the top page of the projector's System Admin page.

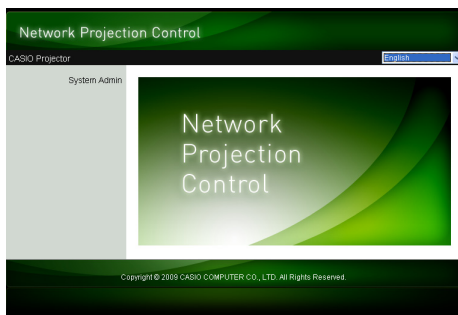

- For information about what you should do next, see "To control the projector using the Wireless Presentation System control panel" (page 57).



Important!

Under initial default settings, the projector is configured to obtain its IP address automatically from the DHCP server. This means that an IP address will be assigned automatically whenever the projector is connected to a DHCP environment network.

Depending on the network environment being connected to, there may be cases where you will need to assign a projector's IP address manually. In such cases, you will need to configure projector's network settings.

If you are unable to display the projector's System Admin page with your browser using the above procedure, it may mean that there is some problem with your network settings. Refer to the Wireless Function Guide on the CD-ROM that comes with the projector and establish a wireless LAN connection between the projector and your computer. After configuring the projector's network settings, try performing the above procedure again. For details about the projector's network settings, see "To configure projector's network settings and wireless LAN connection settings" in the Wireless Function Guide.

To control the projector using the Wireless Presentation System control panel

1. Depending on the type of LAN connection you are using, perform either of the following operations to display the top page of the projector's System Admin page.

Wired LAN Connection : "To establish a wired LAN connection between the projector and a computer" (page 55)

Wireless LAN Connection : Steps 1 and 2 under "To log in to the projector's System Admin page" of the Wireless Function Guide on the CD-ROM that comes with the projector

2. Click "System Admin". On the password input screen that appears, enter the password.

- The initial default password is "admin".

3. Click the [Login] button.

- This logs in to the System Admin page and displays the Status screen.

4. Click "Control panel" on the left side of the screen.

- This will display a control panel screen like the one shown below.

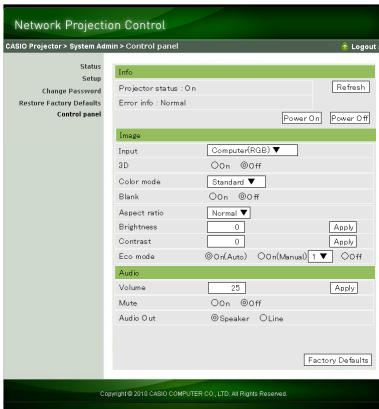

- The table below explains the status information and the projector operations included on the control panel screen.

Group	Item	Description
Refresh (Button)		Click to refresh the screen with the latest information.
Status	Projector status	Shows the projector's current status as either "On" or "Standby".
	Error info	Shows one of the following. Normal: Operating normally. Temperature error: Temperature error occurred. Fan error: Fan error occurred. Light error: Light source unit error occurred. Other error: Error other than above occurred.
	Power On/Power Off (Buttons)	Turn the projector on/off. [Power On] button operation is supported only when the projector is connected to a computer of a wired LAN connection, and "Enable" is selected for the "Remote on" setting (page 37).

Group	Item	Description																
Image	Input	Specifies the input source. The following are the available input source options. <table border="1" data-bbox="434 137 1025 395"> <thead> <tr> <th>3D On</th> <th>3D Off</th> </tr> </thead> <tbody> <tr> <td>Computer (Auto)</td> <td>Computer (RGB)</td> </tr> <tr> <td>Computer (RGB)</td> <td>Video</td> </tr> <tr> <td>Computer (Component)</td> <td>S-video</td> </tr> <tr> <td>Video</td> <td></td> </tr> <tr> <td>S-video</td> <td></td> </tr> <tr> <td>HDMI</td> <td></td> </tr> <tr> <td>USB</td> <td></td> </tr> </tbody> </table>	3D On	3D Off	Computer (Auto)	Computer (RGB)	Computer (RGB)	Video	Computer (Component)	S-video	Video		S-video		HDMI		USB	
		3D On	3D Off															
		Computer (Auto)	Computer (RGB)															
		Computer (RGB)	Video															
		Computer (Component)	S-video															
		Video																
		S-video																
		HDMI																
USB																		
3D	Puts the projector into the 3D input mode or normal input mode. On: 3D input mode Off: Normal input mode <ul style="list-style-type: none"> Note that this setting cannot be change while the currently selected input source is “Computer (Component)”, “HDMI”, or “USB”. 																	
Color mode	Specifies the color mode. <ul style="list-style-type: none"> For details about this setting, see “Selecting the Color Mode” (page 13). This setting cannot be changed when “On” is selected for the “3D” setting and when “Off” is selected for the “Eco Mode” setting. 																	
Blank	Selecting “On” for this setting temporarily blocks the image from the input source. “Off” causes the image from the input source to be projected. <ul style="list-style-type: none"> The operation of this item is identical to that of the remote controller’s [BLANK] key. For details, see “Momentarily Cutting Off the Input Source Image” (page 14). 																	
Aspect ratio	Changes the aspect ratio of the projected image. <ul style="list-style-type: none"> For details about this setting, see “Changing the aspect ratio of the projected image” (page 16). 																	
Brightness	This corresponds to the “Image Adjustment 1 → Brightness” setting of the setup menu. Input a value into the box and then click the [Apply] button. This will change the projector’s “Brightness” setting accordingly.																	
Contrast	This corresponds to the “Image Adjustment 1 → Contrast” setting of the setup menu. Input a value into the box and then click the [Apply] button. This will change the projector’s “Contrast” setting accordingly.																	
Eco Mode	Switches the Eco mode. <ul style="list-style-type: none"> For details about this setting, see “Eco Mode (Power Saving, Low Noise)” (page 18). This setting cannot be changed while “On” is selected for the “3D” setting. “On (Auto)” cannot be selected for the Eco Mode setting while “Rear” is selected for the “Screen Settings → Projection Mode” setting on the setup menu. 																	
Audio	Volume	Input a value into the box and then click the [Apply] button. This will change the volume setting accordingly.																
	Mute	Specifies the mute setting. Audio is output while “Off” is selected for this setting, and muted when “On” is selected.																
	Audio Out	Specifies either output from the projector’s speaker output or AUDIO OUT terminal for audio. Speaker: Audio output from the speaker Line: Audio output from the AUDIO OUT terminal																

Group	Item	Description
Factory Defaults (Button)		Clicking to return all control panel items, except for the “Projector status” item, to their initial factory defaults.

5. After all of the settings are the way you want, click “Logout”.



Note

The “Status”, “Setup”, “Change Password”, and “Restore Factory Defaults” items along the left side of the screen are mainly for accessing information and configuring settings related to projector wireless LAN connection. You can access these items when connected over a wired LAN as well. For details, see “System Admin Page Operations and Settings” in the “Wireless Function Guide” on the CD-ROM that comes with the projector.

Projector RS-232C Control

You can use a commercially available serial cable (cross) to connect the projector to a computer and control the projector from the computer.

Connecting the Projector to a Computer

Connect the projector to the computer as shown in the illustration below.

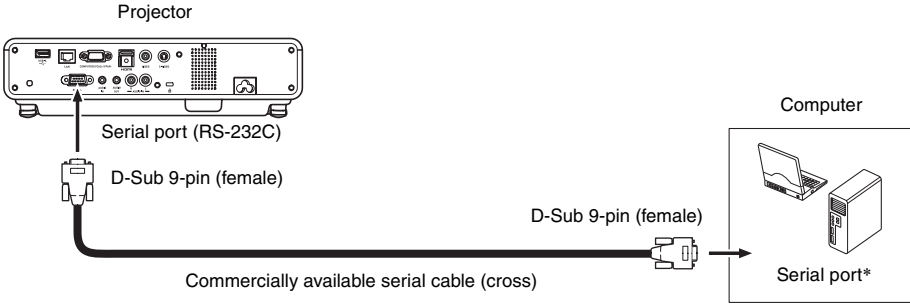

* A D-Sub 9-pin (male) type connector is standard for computer serial ports, but there may be cases where the shape of a particular computer's connector is different. For details about connecting a commercially available serial cable to your computer, see the user documentation that comes with it.

Using Control Commands

This section explains the commands that are used to control the projector from a computer.

Command Send Format

Communication Protocol	Configure your computer's serial port with the following settings.	
	Data Rate	19200bps
	Data Bit	8bit
	Parity	None
	Stop Bit	1bit
	Flow Control	None
Read Command	Send this command when you want information about the current setup of the data projector.	
	Send Format	(<command name>?)
	Receive Format	(<applicable command setting range>, <current setting>)
	Command Send Example	<pre>[[V][L]?] sent from the computer to the projector. ↓ [[0]-[5][,][3][5]] returned from the projector to the computer.</pre>
Write Command	Send this command to control the data projector (power on/off, etc.) and to write data to it.	
	Send Format	(<command name><setting value>)
	Command Send Example	<pre>[[V][L][0]] sent from the computer to the projector. ↓ Projector volume setting becomes 0 (mute).</pre>

- See the “Command List” for details about command names and settings.
- All commands use ASCII characters and decimal format integers.
- The projector will return a question mark (?) when it is sent a command it cannot recognize. Also, any command that attempts to set a value that is outside the applicable allowable range will be ignored.
- If the projector is performing a process initiated by a previously sent command, a projector key operation, or a remote controller key operation, send of the next command must wait until the projector completes the previous process.

Command List

- Only the following functions are supported while the projector is turned off. Do not try to send any other command to the projector.
 - Power on/off: Read
 - Power on: Write
 - Get light time: Read
- Input of a valid signal must be in progress in order to use a command to turn on blank screen or change the aspect ratio.

R: Read enabled W: Write enabled

Function	Command Name	RW	Setting Range
Power On/Off:	PWR	RW	0: Off, 1: On
Input Switching: 0: Switches the input source to the COMPUTER terminal and changes the COMPUTER terminal setting to RGB. 1: Switches the input source to COMPUTER terminal and changes the COMPUTER terminal setting to component. 2: Switches the input source to Video. 5: Switches the input source to USB. This setting is supported only when the projector is equipped with a USB function and the USB application is running. 6: Switches the input source to COMPUTER terminal and changes the COMPUTER terminal setting to Auto. 7: Switches the input source to HDMI. 9: Switches the input source to S-video.	SRC	RW	0: RGB, 1: Component, 2: Video, 5: USB, 6: Auto (RGB/Component), 7: HDMI, 9: S-video
Blank Screen: Switches the blank screen on or off.	BLK	RW	0: Off, 1: On
Volume: Specifies a value to adjust the volume level. This setting is applied to the input source signal that is currently being projected by the projector.	VOL	RW	0-30
Color Mode: Selects the color mode.	PST	RW	1: Graphics, 2: Theater, 3: Standard, 4: Blackboard, 5: Game
Aspect Ratio: Specifies the aspect ratio.	ARZ	RW	0: Normal*1, 1: 16:9, 2: Normal*2, 3: Letter Box, 4: Full, 5: True
Get Light Time: Gets the light time from the projector.	LMP	R	0- Unit: Hours

*1 Input source: RGB or HDMI (PC)

*2 Input source: Video, S-video, component or HDMI (DTV)

Specifications

Model Name	XJ-M140/XJ-M145	XJ-M240/XJ-M245	XJ-M150/XJ-M155	XJ-M250/XJ-M255
Brightness (ANSI Lumens)	2500		3000	
Projection System	DLP			
DLP chip	Size: 0.55 inch, Number of Pixels: XGA (1024 × 768)	Size: 0.65 inch, Number of Pixels: WXGA (1280 × 800)	Size: 0.55 inch, Number of Pixels: XGA (1024 × 768)	Size: 0.65 inch, Number of Pixels: WXGA (1280 × 800)
Projection Lens	1.5X manual optical zoom, manual focus			
Light Source	Laser and LED			
Terminals	COMPUTER IN: RGB 15-pin mini D-Sub × 1 (Also used as component signal input terminal.) VIDEO: RCA pin jack × 1 S-video: 4-pin mini DIN × 1 HDMI: HDMI type A terminal × 1 AUDIO IN: 3.5 φ stereo mini jack × 1, RCA pin jack × 2 AUDIO OUT: 3.5 φ stereo mini jack × 1 SERIAL: 9-pin D-Sub × 1 USB*: TYPE A terminal × 1 LAN*: RJ-45 terminal × 1			
Display Languages	English, French, German, Italian, Spanish, Swedish, Portuguese, Turkish, Russian, Chinese (Simplified), Chinese (Traditional), Korean, Japanese			

* XJ-M145, XJ-M245, XJ-M155, XJ-M255 only

- CASIO COMPUTER CO., LTD. makes no guarantees concerning the operation or suitability of any USB device that you connect to the projector's USB port.
- Specifications are subject to change without notice.

CASIO®

CASIO COMPUTER CO.,LTD.
6-2, Hon-machi 1-chome
Shibuya-ku, Tokyo 151-8543, Japan