

HITACHI

Inspire the Next



The projectors designed for education AND business.

LCD Projectors

CP-X253
CP-X254
CP-X264

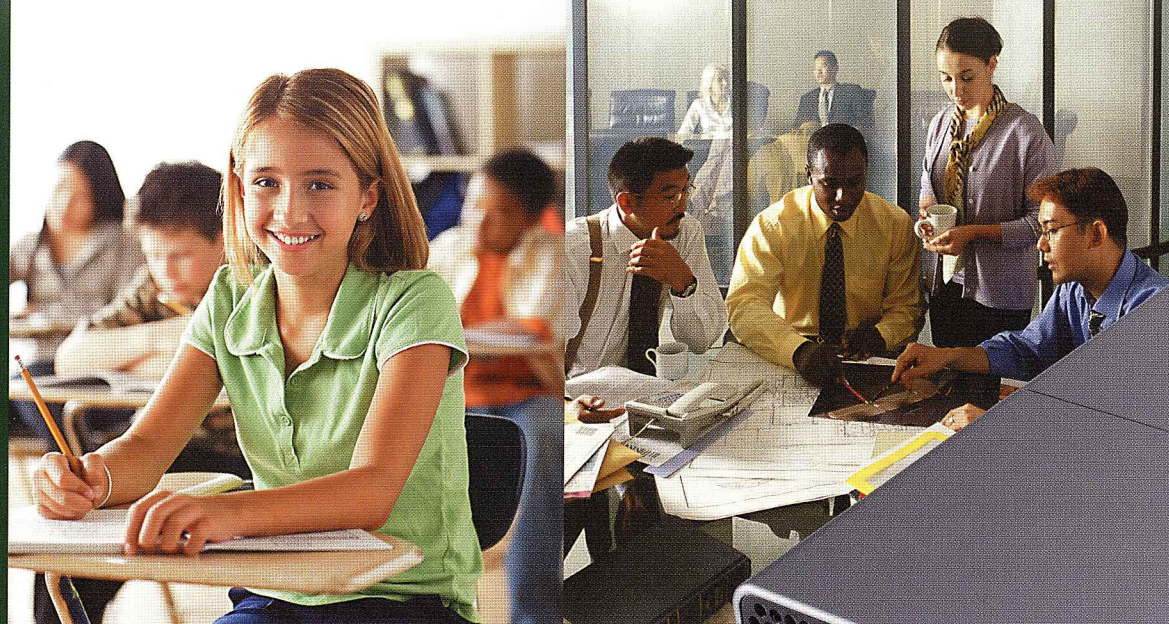

• The screen image is simulated.

HITACHI LCD Projectors CP-X253 / CP-X254 / CP-X264

Four outstanding features make these projectors ideal for both education and business.

- Project onto a large screen!
- Powerful images!

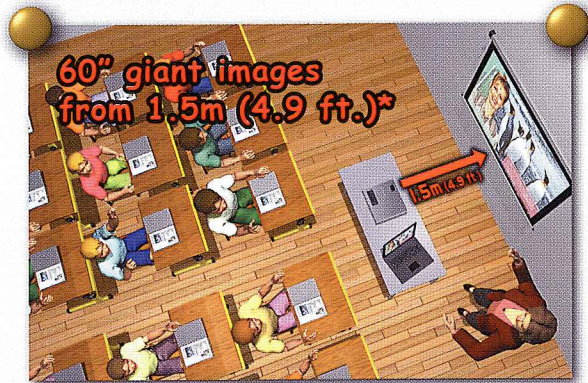

*CP-X253: 1.5m (4.9ft.), CP-X254/CP-X264: 1.8m (5.9ft.)

- Very quiet!
- Better concentration during classes and meetings!

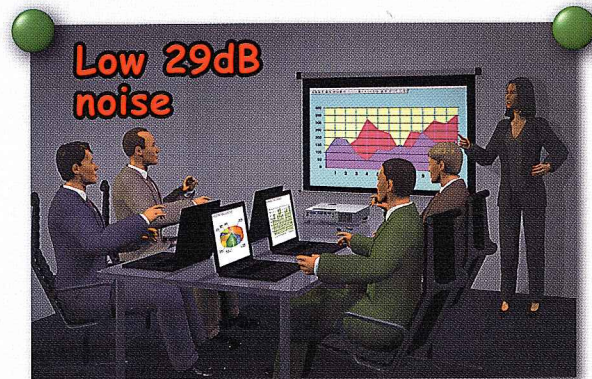

- Wide selection of input/output terminals!
- Diverse images!



- Lightweight, compact and easy to carry!
- High brightness!



*CP-X264: 2,500 ANSI Lumens, CP-X253/CP-X254: 2,000 ANSI Lumens

LCD Projectors

CP-X253
CP-X254
CP-X264



● Huge images, even in limited spaces.



Projects huge 60" images at a distance of 1.5m (4.9 ft)*, making it ideal for classrooms or meeting rooms with limited space. Text, charts and videos are all easier to see. And it's perfect for cart-top use because it can be placed near the screen.

*CP-X253: 1.5m (4.9ft.), CP-X254/CP-X264: 1.8m (5.9ft.)

● Low noise does not disturb audience concentration.

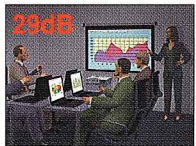

The projectors have a quiet design, with noise of only 29dB. You can use them in small classrooms or meeting rooms without being bothered by fan noise. Your audience will be able to hear you clearly and concentrate fully on the subject matter.

● Projects a variety of sources thanks to a wide range of terminals.



The projectors are ready for all types of use with two Computer In, two Audio In and a variety of video terminals. They also have Monitor out, so you can see the projected images on your own computer, letting you face the audience without having to watch the screen.

● Light weight and compact size, plus high brightness.



1.8kg (4.0 lbs.) light weight and 274 x 205mm (10.79" x 8.07") compact size make it easy to carry. And because it provides 2,500 ANSI Lumens*, lectures or presentations can be given even in a bright room so the audience can take notes.

*CP-X264: 2,500 ANSI Lumens, CP-X253/CP-X254: 2,000 ANSI Lumens

■ Diverse security functions.

Security functions include PIN lock, My Screen PIN Lock, status observation and Kensington lock. The anti-theft measures are particularly welcome when the projector is suspended from the ceiling.



PIN Lock

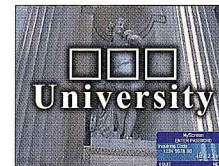

My Screen PIN Lock

■ You can project on a blackboard or whiteboard.

In rooms with no screen, the projectors can project on a blackboard or whiteboard. The blackboard mode is compatible with both blank and green blackboards. In whiteboard mode, the white signal is only half as bright, ensuring optimum visibility.

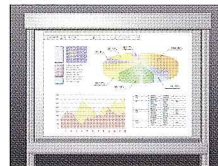

Normal mode

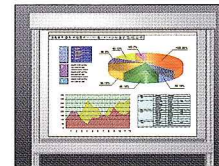

Whiteboard mode

■ Auto Vertical Keystone Correction eliminates screen distortion.

Keystone distortion occurs when the projectors are inclined. This is automatically detected by a gravity sensor inside the projectors and corrected for.



■ Begin projection right away with 4-Second Quick Start.

The projectors feature a quick start of only four seconds* from turning on the power to projection. You can quickly start without keeping your audience waiting.

* Time until start of projection. Depending on power restart time and setting, start time may be longer.

■ Easy to put away, since no cooldown is required.

The Direct Power On/Off function* eliminates the need for cooldown after using the projector. After tuning the power off, you can put the projectors away immediately. * The Direct Power On function must be selected from the menu.

■ Resolution Preset and Custom Modes

When projecting from a widescreen computer, many projectors are unable to correctly display the aspect ratio. Resolution Preset and Custom modes achieve the correct display, providing vivid, easy to watch wide images.



■ Input Source Naming

The input source name can be changed to the name of a device you often use (notebook computer, DVD, etc.) or changed to a name that is easier for users to understand.



■ Other Features

- Motion Adaptive Progress Scan • 3:2 Pull Down • Noise Reduction
- Hitachi Equalizing Gamma Function • My Button • My Screen
- Security Label Included • Serial # Label on Side • Lamp Door on Top

SPECIFICATIONS

Model name	CP-X253/CP-X254	CP-X264
Liquid crystal panel structure	0.63" polysilicon active-matrix TFT x 3	0.63" polysilicon active-matrix TFT x 3
Number of pixels	786,432 pixels (V768 x H1,024)	786,432 pixels (V768 x H1,024)
Resolution	1,024 x 768 color pixels	1,024 x 768 color pixels
Lens	Optical zoom (F=1.8-1.9) 1:1.2	Optical zoom (F=1.8-1.9) 1:1.2
Lamp	160W UHB	160W UHB
Brightness	2,000 ANSI Lumens	2,500 ANSI Lumens
Contrast ratio	500:1	500:1
Speakers	1W x 1	1W x 1
Keystone correction	Auto Vertical keystone	Auto Vertical keystone
Power supply	AC100-120V/AC220-240V	AC100-120V/AC220-240V
Operating temperature	5-35°C (41-95°F)	5-35°C (41-95°F)
Input signals	Computer input	VGA, SVGA, XGA, SXGA, SXGA+, UXGA, MAC16"
	Video input	NTSC, NTSC4.43, PAL, SECAM, M-PAL, N-PAL HDTV: 750p (720p), 1125i (1080i) SDTV: 525i (480i), 525p (480p), 625i (575i)
Input/output terminals	Video input	S-Video: Jack x 1, Composite video: RCA jack x 1, Component video: via D-sub
	Audio input	Stereo Mini jack x 2
	Computer input	Analog RGB: 15-pin Mini-Dsub x 2
	Audio output	Stereo Mini jack x 1
	Monitor output	Analog RGB: 15-pin Mini -Dsub x 1
	Control and mouse	9-pin Dsub x 1 for RS232C, USB type B x 1 for mouse control
Agency certifications	UL/cUL, FCC Part15 class B, CE, EN61000-3-2, EN61000-3-3, EN55022, EN55024, EN60950-1	UL/cUL, FCC Part15 class B, CE, EN61000-3-2, EN61000-3-3, EN55022, EN55024, EN60950-1
Dimensions (WxHxD)	274 x 59 x 205mm (10.79" x 2.32" x 8.07") [excl. protruding part]	274 x 59 x 205mm (10.79" x 2.32" x 8.07") [excl. protruding part]
Weight	1.8kg (4.0 lbs.)	1.8kg (4.0 lbs.)
Standard accessories	RGB cable, Remote Control, Batteries, Lens cap, Strap, Soft case, Filter cover (for ceiling mounting), Power cord, 14-language user's manuals, Video cable, Stereo mini-RCA audio adaptor, Security label	RGB cable, Remote Control, Batteries, Lens cap, Strap, Soft case, Filter cover (for ceiling mounting), Power cord, 14-language user's manuals, Video cable, Stereo mini-RCA audio adaptor, Security label

DIMENSIONS

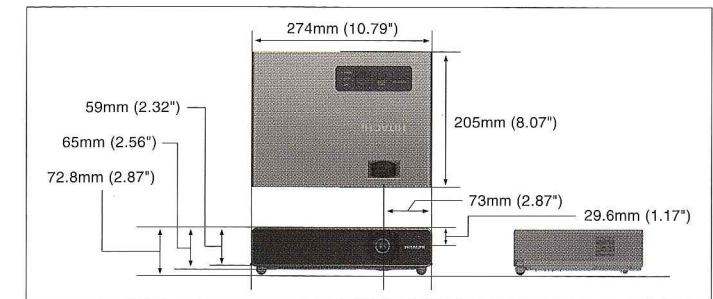

TERMINALS

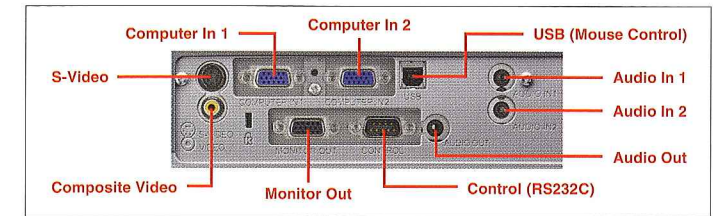

PROJECTION DISTANCE

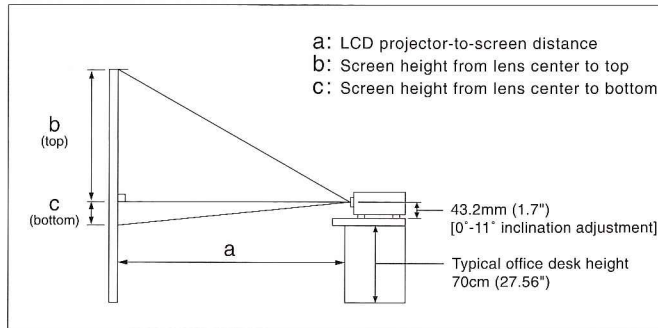

CP-X253

Screen Size (inch)	a Min	a Max	b (top)	c (bottom)
30	0.8m (30")	0.9m (36")	39cm (15")	7cm (3")
40	1.0m (40")	1.2m (48")	52cm (21")	9cm (3")
50	1.3m (50")	1.5m (61")	65cm (26")	11cm (4")
60	1.5m (61")	1.9m (73")	78cm (31")	13cm (5")
70	1.8m (71")	2.2m (85")	91cm (36")	15cm (6")
80	2.1m (81")	2.5m (97")	105cm (41")	17cm (7")
90	2.3m (91")	2.8m (110")	118cm (46")	20cm (8")
100	2.6m (102")	3.1m (122")	131cm (51")	22cm (9")
120	3.1m (122")	3.7m (147")	157cm (62")	26cm (10")
150	3.9m (153")	4.7m (183")	196cm (77")	33cm (13")
200	5.2m (204")	6.2m (245")	261cm (103")	44cm (17")
250	6.5m (255")	7.8m (306")	327cm (129")	54cm (21")
300	7.8m (306")	9.3m (368")	392cm (154")	65cm (26")

CP-X254/CP-X264

Screen Size (inch)	a Min	a Max	b (top)	c (bottom)
30	0.9m (35")	1.1m (42")	39cm (15")	7cm (3")
40	1.2m (47")	1.4m (57")	52cm (21")	9cm (3")
50	1.5m (59")	1.8m (71")	65cm (26")	11cm (4")
60	1.8m (71")	2.2m (85")	78cm (31")	13cm (5")
70	2.1m (83")	2.5m (100")	91cm (36")	15cm (6")
80	2.4m (95")	2.9m (114")	105cm (41")	17cm (7")
90	2.7m (107")	3.3m (128")	118cm (46")	20cm (8")
100	3.0m (119")	3.6m (143")	131cm (51")	22cm (9")
120	3.6m (143")	4.4m (171")	157cm (62")	26cm (10")
150	4.5m (179")	5.4m (215")	196cm (77")	33cm (13")
200	6.1m (238")	7.3m (286")	261cm (103")	44cm (17")
250	7.6m (298")	9.1m (358")	327cm (129")	54cm (21")
300	9.1m (358")	10.9m (430")	392cm (154")	65cm (26")

• Final specifications may vary slightly.

• Design and specifications are subject to change without notice.

- The screen and monitor images and comparison photos in this catalog are simulations.
- LCD panels, polarizers and other optical components and cooling fans may need replacement after prolonged usage. For more details, please consult a Hitachi sales representative.
- Do not use in places where there is a lot of water, dampness, steam, dust, soot or tobacco smoke. This may result in fire or malfunction.
- Optical components (lamp, LCD panel, polarizing plate, PBS [polarizer beam splitter], contrast-up film) have limited service lives. They must be repaired or replaced if they are used for a long period of time.
- These projectors use a mercury lamp with high internal pressure. Because of its properties, this lamp may burst with a loud noise or burn out if struck or after it has been used for a period of time. The time until it bursts or burns out varies greatly according to differences between lamps and usage conditions. Turning the lamp's power on and off frequently shortens its service life.
- Optical components other than the lamp: If the projector is used for six hours or more per day, they may need to be replaced in less than a year.
- LCD panel: If the projector is used continuously for six hours or more, its replacement cycle may be shortened.
- Do not turn projector on again for ten minutes after shutdown. Neglect can shorten the lifetime of the lamp. During use and immediately after use, do not touch anywhere near the lamp and the vents as these parts are extremely hot.

HITACHI

Hitachi Home Electronics (America), Inc., Business Group 900 Hitachi Way, Chula Vista, CA91914-3556, U.S.A. and Canada Tel: +1-800-HITACHI Fax: +1-619-591-5418 www.hitachi.us/digitalmedia
Hitachi Home Electronics Asia (S) Pte. Ltd. 438A Alexandra Road #01-01/02/03, Alexandra Technopark, Singapore 119967 Tel: +65-6536-2520 Fax: +65-6536-2521 www.hitachiconsumer.com.sg
Hitachi Sales (Malaysia) Sdn. Berhad (11543-V) Lot 12, Jalan Kemajuan, Bangi Industrial Estate, 43650 Bandar Baru Bangi, Selangor Darul Ehsan, Malaysia. Tel: +60-3-8926-4168 Fax: +60-3-8926-3013 www.hitachiconsumer.com.my
Hitachi Sales (Thailand), Ltd. 994 Soi Thonglor, Sukhumvit 55 Road, Klongtonnua, Vadhana Bangkok 10110, Thailand Tel: +66-2381-8381-98 Fax: +66-2381-0210/2381-0021 www.hitachi-th.com
Hitachi (Hong Kong), Ltd. 18th Floor, Ever Gain Centre, 28 On Muk Street, Shatin, N.T., Hong Kong Tel: +852-2113-8883 Fax: +852-2783-4178 www.hitachi-hk.com.hk
Hitachi Sales Corp. of Taiwan 2nd Floor, No.65, Nanking East Road, Section 3, Taipei 104, Taiwan Tel: +886-2-2516-0500 Fax: +886-2-2516-1501 www.hsct.com.tw
Hitachi Australia Pty Ltd. Level 3, 82 Waterloo Road, North Ryde, NSW 2113, Australia Tel: +61-2-9888-4100 Fax: +61-2-9888-4188 www.hitachi.com.au
Hitachi Europe Ltd. Whitebrook Park, Lower Cookham Road, Maidenhead, Berkshire, SL6 8YA, UK Tel: +44-1628-643000 Fax: +44-1628-643404 www.hitachidigitalmedia.com

