



LG DLP Projector

USER'S MANUAL

**MODEL: RD-JT20 XGA
RD-JT21 SVGA**

**Please read this manual carefully before
operating your set. Retain it for future reference.**

DLP PROJECTOR

USER'S GUIDE

Thank you for purchasing the DLP Projector.

Please read this user's guide to ensure correct use of the device. Save this user's guide for future reference.

OUTLINE

This DLP Projector can display various computer signals and NTSC/PAL/SECAM video signals.

FEATURES

- 1. High Brightness**
- 2. High Resolution**
- 3. Compact Size, Feather Weight for Portability**
- 4. Durable Magnesium Alloy Body**
- 5. RGB input Terminal**
- 6. One Touch Auto-Adjustment Function**
- 7. Easy Keystone Adjustment**

Copyright

Copyright © 2002. All rights reserved. No part of this publication may be reproduced, transmitted, transcribed, stored in a retrieval system or translated into any language or computer language, in any form or by any means, electronic, mechanical, magnetic, optical, chemical, manual or otherwise, without the prior written permission of the company.

Disclaimer

The company makes no representations or warranties, either expressed or implied, with respect to the contents hereof and specifically disclaims any warranties, merchantability or fitness for any particular purpose. Furthermore, the company reserves the right to revise this publication and to make changes from time to time in the contents hereof without obligation of the company to notify any person of such revision or changes.

Table of Contents

Introduction	1
Safety Instructions	1
FCC Statement	2
Shipping Contents	3
Optional Accessories	3
Projector Description	4
Projector	4
External Control Panel	5
Adjuster	6
Projector Features	6
Remote Control Description	7
Remote Control Features	7
Installing or Replacing Batteries	9
Installation	10
Screen Size	10
Connecting to Various Equipment	10
Operation	11
Start Up	11
Digital Keystone Correction	12
Auto Adjustment	12
Source Selection	13
Menu System	13
1. Display Menu	14
2. Image Menu	15
3. Source Menu	16
4. Control Menu	17
5. PIP Menu	17
Shutdown	18
Maintenance	19
Lamp Information	19
Use and Replacement of Lamp	19
LED Status Indicators	19
Lamp Replacement	19
Troubleshooting	20
Status Messages	21
Specifications	22
Projector Specifications	22
Timing Chart	23
Dimensions	24

INTRODUCTION

Caution

TO PREVENT SHOCK, DO NOT OPEN THE CABINET. NO USER –SERVICE-ABLE PARTS INSIDE. REFER SERVICING TO QUALIFIED SERVICE PERSONNEL. PLEASE READ THIS USER’S GUIDE BEFORE YOU OPERATE YOUR PROJECTOR. SAVE THIS USER’S GUIDE FOR FUTURE REFERENCE .

Safety Instructions

1. Read this user’s guide before you operate your projector and save it for future reference.
2. The lamp becomes extremely hot during operation. Allow the projector to cool for approximately 45 minutes prior to removing the lamp assembly for replacement. Do not operate lamps beyond the rated lamp life. Excessive operation of lamps beyond the rated life could cause them to explode on rare occasions.
3. Never replace lamp assembly or any electronic components unless the projector is unplugged.
4. To reduce the risk of electric shock, do not disassemble this appliance. Take it to a qualified technician when service or repair is required. Incorrect reassembly can cause electric shock when the appliance is subsequently used.
5. Do not place this product on an unstable cart, stand, or table. The product may fall, causing serious damage to the product. This product is capable of displaying inverted images for ceiling mount installation. Please use suitable equipment for mounting the unit and ensure it is securely installed.
6. To prevent lamps from bursting, change the lamp after changing the mounting position of projectors (desktop to ceiling mount or ceiling mount to desktop mount).

Caution

- **Always open the lens shutter or remove the lens cap when the projector lamp is on.**
 - **Do not look straight at the projector lens during operation. The intense light beam may damage your eyesight.**
 - **In some countries, the line voltage is NOT stable. This projector is designed to operate safely within a bandwidth of 100 to 240 volts, but could fail if power cuts or surges of ± 10 volts occur. In these high-risk areas, it is recommended to install a power stabilizer unit.**
 - **Do not place this projector on the top of cloth or carpet.**
 - **Do not touch the ventilation grill when the projector is under operation.**
-

FCC Statement

CLASS B

This equipment generates, uses and can radiate radio frequency energy and, if not installed and used in accordance with the instructions, may cause harmful interference to radio communications. However, there is no guarantee that interference will not occur in a particular installation. If this equipment does cause harmful interference to radio or television reception, which can be determined by turning the equipment off and on, the user is encouraged to try to correct the interference by one or more of the following measures:

- Reorient or relocate the receiving antenna.
- Increase the distance between the equipment and receiver.
- Connect the equipment into an outlet on a circuit different from that to which the receiver is connected.
- Consult the dealer or an experienced radio/TV technician for help.

Save this user's guide: The information contained in this manual will assist you in operating and maintaining your Personal Projector.

Shipping Contents

The Projector is shipped with the necessary cables required for standard PC, Macintosh or laptop computer connections. Carefully unpack and verify that you have all the items shown below. If any of these items are missing, please contact your place of purchase.

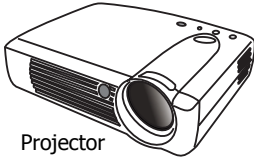

Projector



User's Manual



Remote Control



Batteries



3-2 Converter

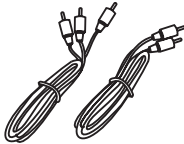

Audio Cable

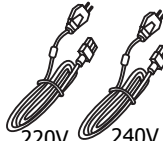

220V

240V

Power Cord

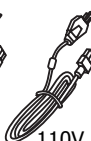

110V

HDTV Cable



VGA Cable



S-Video Cable

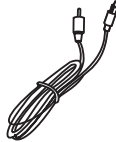

Video Cable

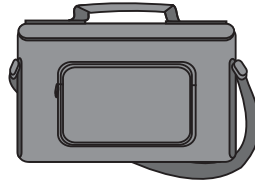

Deluxe Soft Carry Case

Optional Accessories

1. Spare lamp kit
2. Mac Adapter

Projector Description

Projector

1. External control panel (see next page)	9. Video connector
2. Projection lens	10. D-sub connector (for computer/ input)
3. Front adjustment feet	11. Audio input
4. IR remote sensor	12. Rear adjustment feet
5. Ventilation grill	13. Lamp access door (underneath unit)
6. Kensington lock	
7. AC power cord input	
8. S-video connector	

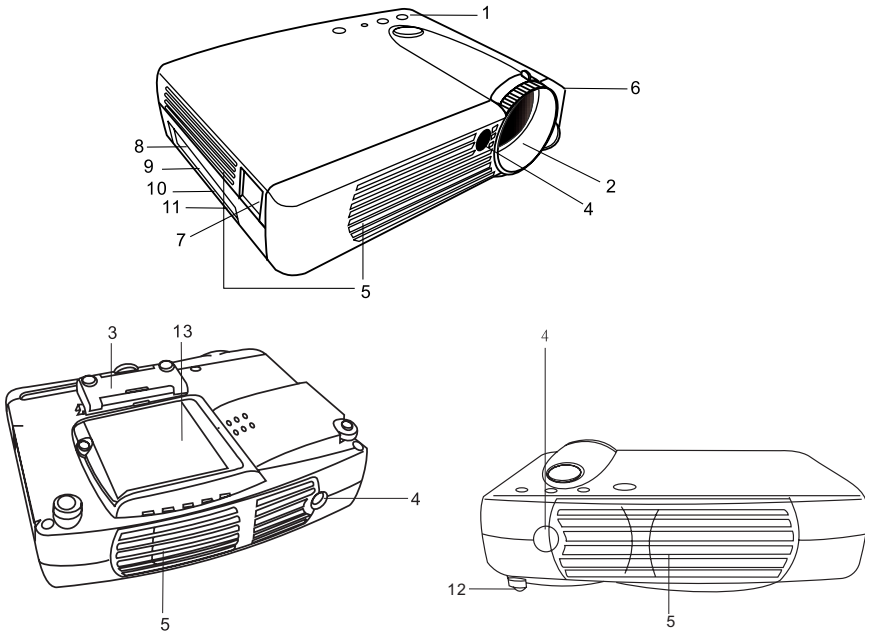

External Control Panel

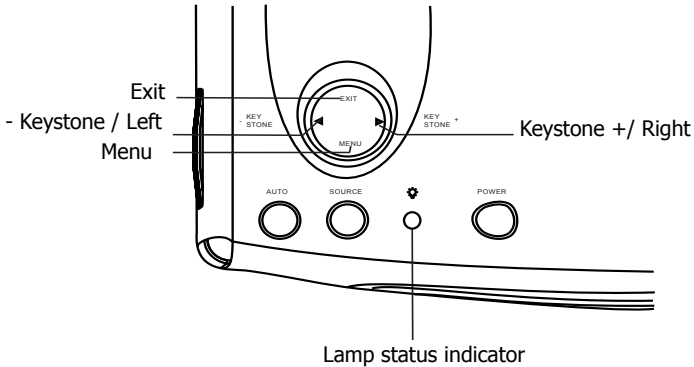

- The **Infrared Remote Receiver (Front and Rear)** allows the projector to accept signals from the remote control. For best results, be sure to aim the control toward the sensor without any obstructions between the two, and at a distance no greater than 6 meters.
- **Menu** will display the menu system on screen. Press **Menu** again to access the sub-menus. **Left** and **Right** help you navigate among choices and settings in the menus and sub-menus. However, when the onscreen menu is not activated, the **Left** and **Right** buttons will function as **Keystone +/-** hot keys.
- Press the **Exit** button to go back to the main menu. Press **Exit** again to leave the menu system.
- The **Status Indicator** will blink or light up when the lamp needs service, cooling or replacement. See "Lamp Information" on page 19. for more detailed information.
- When the projector is on, **back-lit Power** will blink during warm-up and turn to solid green to indicate the projector is ready for use.
- Press **Power** for 1 second to turn the projector on or off.
- **Auto** key: Automatically sense the best picture quality for current received signals.
- **Source** key: Select signal sources, PC, Video, S-video and YPbPr.

Adjuster

The projector is equipped with a quick-release adjuster foot and button for adjusting its tilt angle.

1. Lift the projector up and press the adjuster button to release the adjuster.
2. The adjuster will drop into position and be locked.

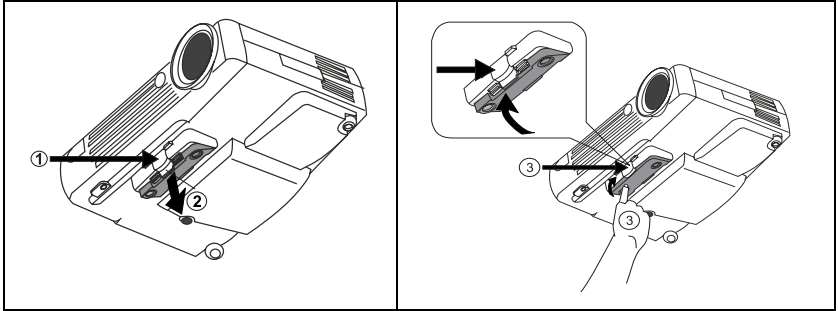

Projector Features

The Projector integrates high performance optical engine projection and user-friendly design to deliver high reliability and ease of use experience.

The Projector offers the following features:

- Compact and portable unit
- Full-function remote control
- Manual zoom lens
- One key auto-adjustment to display the best picture quality
- Easy digital keystone correction through hot keys to correct tilted pictures
- Adjustable color balance control for data/video
- Ultra-high brightness projection lamp
- Ability to display high quality 16.7 million colors
- On screen menus in 8 languages: English, French, German, Italian, Spanish, Japanese, Korean and Simplified Chinese.
- Powerful AV function to provide high AV picture results.
- HDTV compatibility (YPbPr)

Note: The brightness of your machine will vary depending on the ambient room conditions and contrast/brightness settings.

Remote Control Description

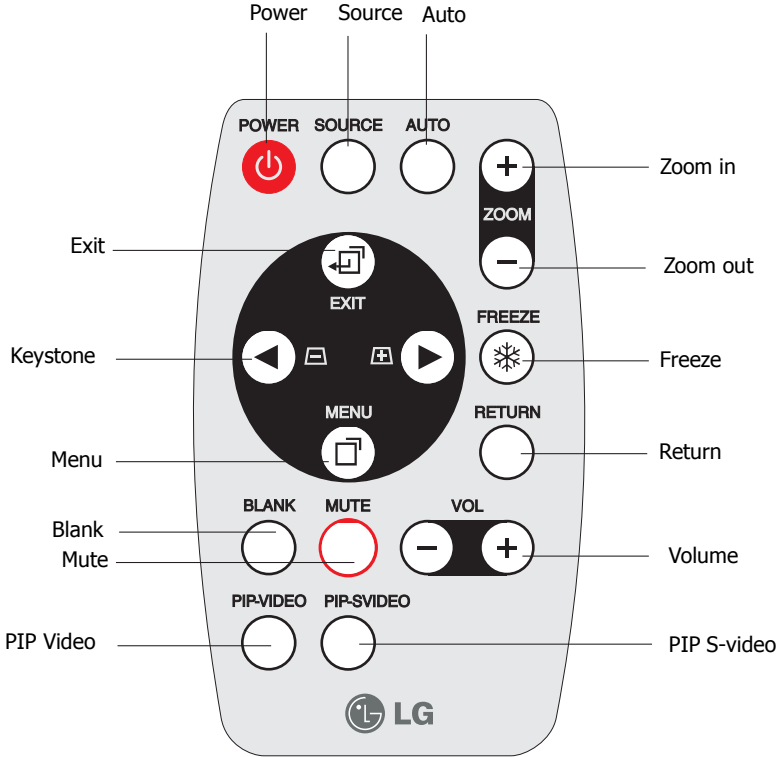

Remote Control Features

The remote control sensors are located in the front/ back of the projector. The distance between the sensor and the remote control should not exceed 6 meters.

FREEZE

The image can be frozen when FREEZE is pressed. A “Pause” icon will appear in the lower right corner of the screen for three seconds. To release the freeze function, again press the FREEZE button, RETURN button or SOURCE button (when the input source is switched over during display). A “Play” icon will appear in the lower right corner of the screen for three seconds when the freeze function is released.

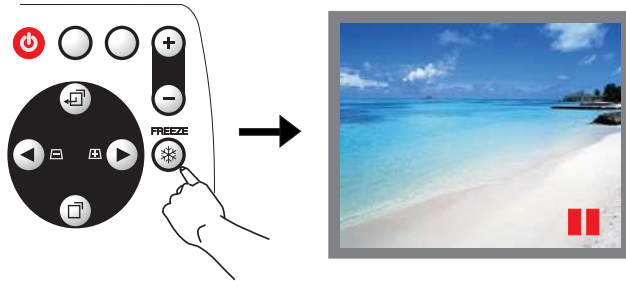

BLANK

The image can be blank when BLANK is pressed. To release the blank function, press BLANK again.

ZOOM +/-

By pressing ZOOM +, the center of the picture will be magnified. When the + button is pressed again, the picture is further magnified, up to four times the original size. By pressing ZOOM -, the size of the image is reduced. When the - button is pressed again, the picture is further reduced until it is restored to its original size. To return to the normal display mode, press the RETURN button. (This function can be used in combination with FREEZE.)

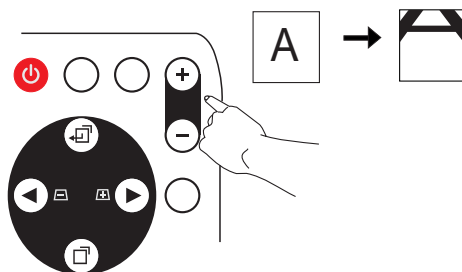

After activating the zoom in function, you can pan the screen with the following buttons.

Menu	Move downward to the bottom.
Exit	Move upward to the top.
Left (Keystone -)	Move toward to the left side.
Right (Keystone +)	Move toward to the right side.

Installing or Replacing Batteries

- Push and slide the battery compartment lid in the direction shown.
- Install battery as indicated by the diagram inside the compartment.
- Position the lid over the compartment and snap it back into place.

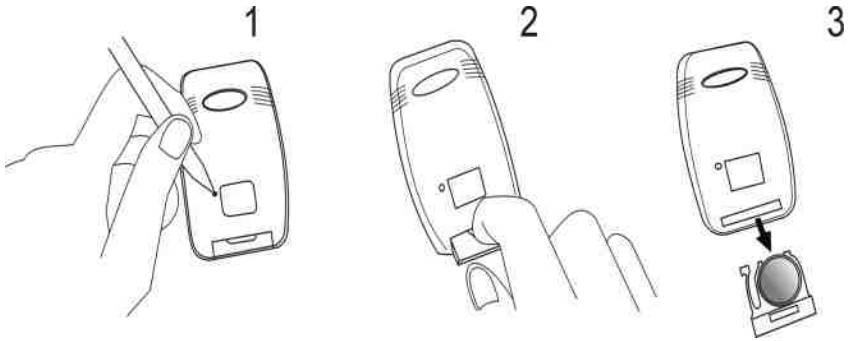

Caution

Avoid excessive heat and humidity. Danger of explosion may happen if battery is incorrectly replaced. Replace only with the same or equivalent type recommended by the manufacturer. Dispose of used batteries according to the manufacturer's instructions.

INSTALLATION

Screen Size

Place the projector at the required distance from the screen according to the desired picture size (see the table below).

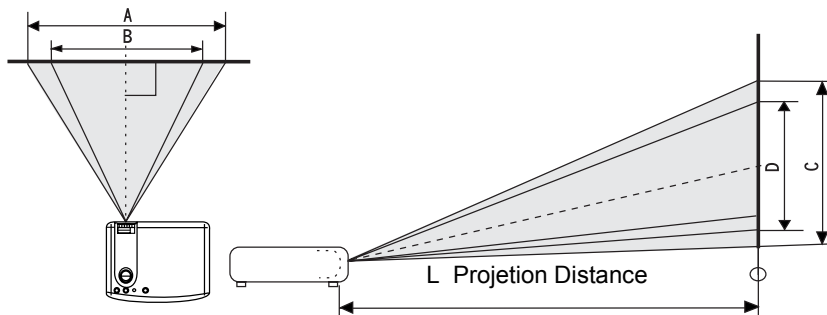

Screen Size (Max.)			L. Projection distance (cm)	Screen Size (Min.)		
Diagonal (in)	A. Width (cm)	C. Height (cm)		Diagonal (in)	B. Width (cm)	D. Height (cm)
30.4	61.8	46.3	100	24.9	50.7	38.0
60.8	123.7	92.7	200	49.9	101.3	76.0
91.2	185.3	138.9	300	74.7	151.9	113.9
121.5	247.0	185.2	400	99.7	202.5	151.9
151.9	308.7	231.6	500	124.6	253.2	189.9
182.3	370.5	277.9	600	149.5	303.8	227.9
212.8	432.2	324.2	700	174.6	354.4	266.2
243.1	494.0	370.5	800	199.4	405.1	303.8
273.5	555.7	416.7	900	224.3	455.7	341.8
303.9	617.5	463.1	1000	249.2	506.3	379.8

Connecting to Various Equipment

It only takes a few seconds to connect your projector to your computer/notebook, VCR or other systems. However, a Mac adapter (an optional accessory) is needed for connection for Macintosh users.

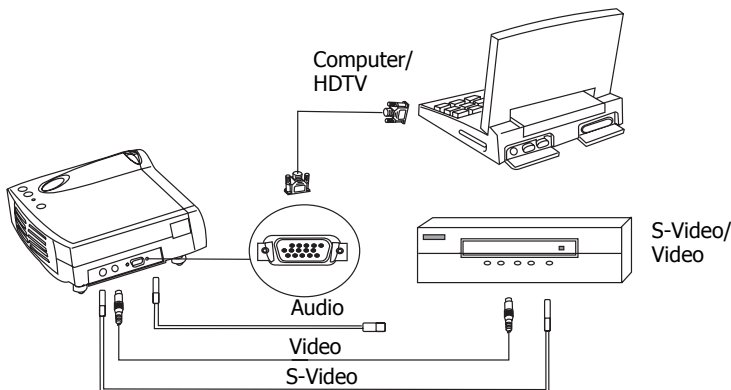

OPERATION

Start Up

1. Plug the power cord into a wall socket.
2. Press POWER for 1 second.

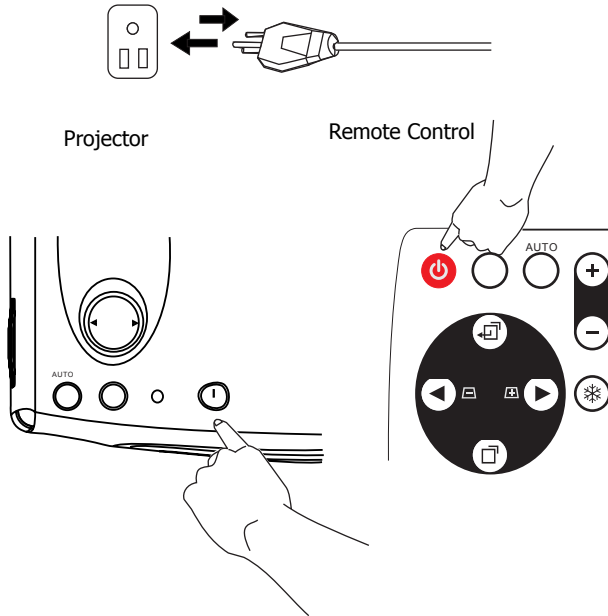

- The back-lit POWER key blinks green and stays green when the power is turned on.
(When the power is turned off, there is a 60-second cooling period before the projector can be re-started.)
3. Switch on all connected equipment.

Digital Keystone Correction

Keystoning is when the projected image is noticeably wider on either the top or bottom. To correct this, press KEYSTONE +/- (hot key) on the control panel of the projector or on the remote control, then adjust the sliding bar labeled Keystone, as needed. Press + to correct keystoning at the top of the image. Press - to correct keystoning at the bottom of the image.

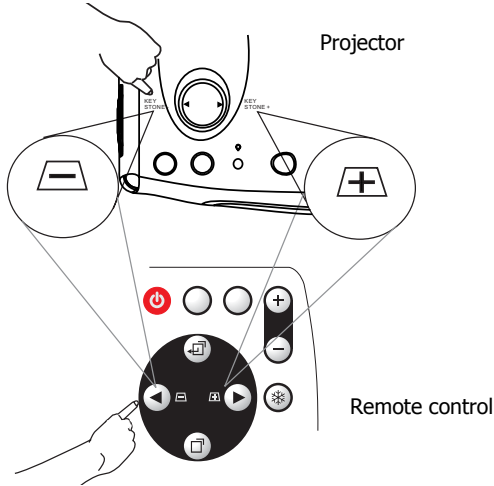

Auto Adjustment

In some cases, you may have to optimize the picture quality manually. To do this, press the AUTO key on the control panel of the projector or on the remote control. Within 3 seconds, the built-in Intelligent Auto Adjustment function will re-adjust to the best picture quality.

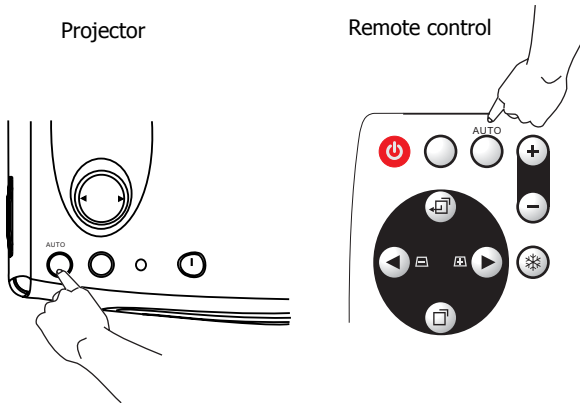

Source Selection

When several input sources are available, press the SOURCE key to make a selection from the control panel of the projector or the remote control.

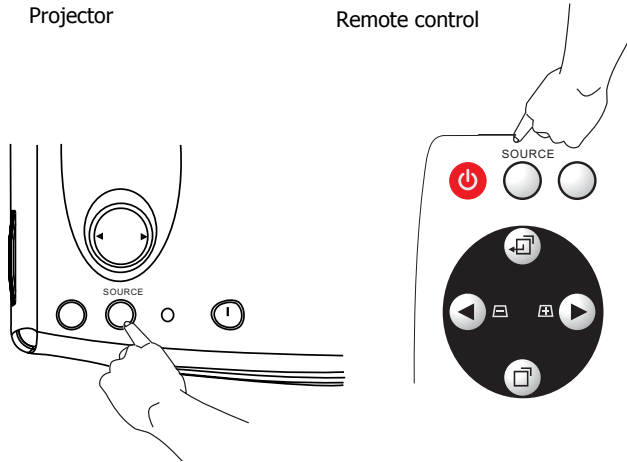



Menu System

Press **Menu** for the main menu and press ◀ or ▶ to select a sub-menu. Press **Menu** again to select items in the sub-menu.

Menu Bar					
Sub-menu	Display	Image	Source	Control	PIP
PC	Keystone Brightness Contrast Phase H.Size	Auto resize H-position V-position Color Temp Information	Mirror Source Volume Treble Bass Mute	Language OSD OSD Time Auto Off Reset Lamp hour	Main page: PIP Source PIP size PIP Pos. H. Position V.Position More Options
Y/Pb/Pr		Auto resize H-position V-position Color Tint Color Temp			
Video		Ratio System Sharpness Color temp Information			

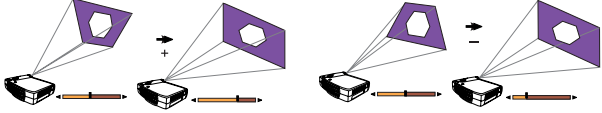
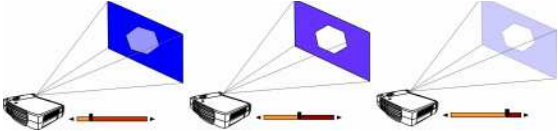
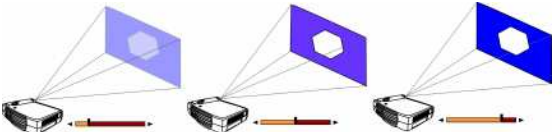

1. Display Menu

<p>Keystone</p>	<p>Corrects the keystone of the image.</p> 
<p>Brightness</p>	<p>Adjusts the brightness of image.</p> 
<p>Contrast</p>	<p>Adjusts the degree of difference between darkness and lightness of image.</p> 
<p>Phase</p>	<p>Adjusts to fit in the desired image size.</p>  <p><i>*This function is not available when the input mode are Video, S-video.</i></p>
<p>H.Size</p>	<p>Adjusts to avoid the occurrence of flicker.</p> <p><i>*This function is not available when the input modes are Video, S-video.</i></p>
<p>Color</p>	<p>Adjusts to increase or decrease the colors (R, G, B) of image.</p> <p><i>*This function is not available when the input mode is PC.</i></p>
<p>Tint</p>	<p>Adjusts to make the image look more red or blue.</p> <p><i>*This function is not available when the input mode is PC.</i></p>

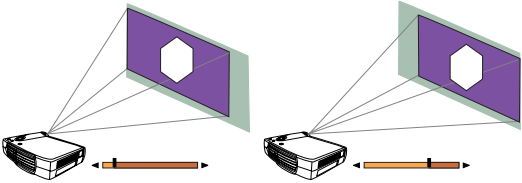
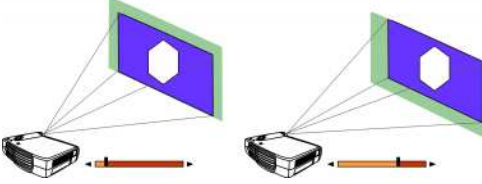
2. Image Menu

<p>Auto resize</p>	<p>Makes the best fit of the image to the screen,</p> <p style="text-align: center;">OFF ON</p>
<p>H-position</p>	<p>Adjusts the horizontal position of image.</p> 
<p>V-position</p>	<p>Adjusts the vertical position of image.</p> 
<p>Color Temp.</p>	<p>Adjusts the color temperature to fit your preference.</p>
<p>Information</p>	<p>Shows the current resolution.</p>
<p>Ratio</p>	<p>Users have 2 options for the image ratio. 1. 4:3 (Normal) 2. 16:9 (Wide) <i>*This function is not available when the input modes are PC, YPbPr.</i></p>
<p>System</p>	<p>4 modes can be selected. 1. Auto 2. PAL-M 3. PAL-N 4. SECAM <i>*The default setting of System is Auto.</i> <i>*This function is not available when the input modes are PC, YPbPr.</i></p>
<p>Sharpness</p>	<p>Adjusts to make the image look sharper or softer. <i>*This function is not available when the input mode are PC, YPbPr.</i></p>
<p>Color</p>	<p>Adjusts to increase or decrease the colors (R, G, B) of image. <i>*This function is not available when the input mode is PC.</i></p>
<p>Tint</p>	<p>Adjusts to make the image look more red or blue. <i>*This function is not available when the input mode is PC.</i></p>

3. Source Menu

<p>Mirror</p> <ol style="list-style-type: none"> 1. Default 2. Ceiling - mounted projection 3. Rear screen projection 4. Ceiling - mounted and rear screen projection 	
<p>Source</p>	<p>Selects sources between PC, Video, S-Video, and YPbPr.</p>
<p>Volume</p>	<p>Adjusts the volume level.</p>
<p>Treble</p>	<p>Adjusts the treble level.</p>
<p>Bass</p>	<p>Adjusts the bass level.</p>
<p>Mute</p>	<p>Off  On </p>

4. Control Menu

Language	Language sets the OSD to display in one of 8 languages. Use ◀ / ▶ key to select the languages: English, French, German, Italian, Spanish, Japanese, Korean and Simplified Chinese.
OSD	Selects a desired OSD position.
OSD Time	Sets the length of time the OSD will remain active after the last time you pressed a button. The range is from 5 to 60 seconds in 5-second increments.
Auto Off	Sets the length of time to shut off the system when no input is detected. The range is from 0 to 60 minutes in 1- minute increments.
Reset	Returns all settings to those set at the time of manufacturing.
Lamp hour	Shows lamp used time.

5. PIP Menu

These functions are valid only when the input mode is PC and the PIP source is Video or S-video.

PIP Source	Selects the source from which the PIP picture comes.
PIP Size	Uses ◀ / ▶ key to scroll through the 4 alternatives: Off, Small, Medium, Large.
PIP Position	Selects a desired PIP position.
H Position	Adjusts the horizontal position of PIP image.
V Position	Adjusts the vertical position of PIP image.
More Options	Uses ◀ / ▶ key to select more PIP functions including Brightness, Contrast, Color, Tint, Sharpness and System.
Brightness	Adjusts the brightness of PIP image.
Contrast	Adjusts the degree of difference between darkness and lightness of PIP image.
Color	Adjusts to increase or decrease the colors (R, G, B) of image.
Tint	Adjusts to make the image look more red or blue.
Sharpness	Adjusts to make the image look sharper or softer
System	Selects PIP image systems: Auto, NTSC, PAL, SECAM

Shutdown

1. Press **POWER** and a warning message will prompt up. To turn off the projector, press **POWER** again.
2. The fan will continue to run for approximately 60 seconds.

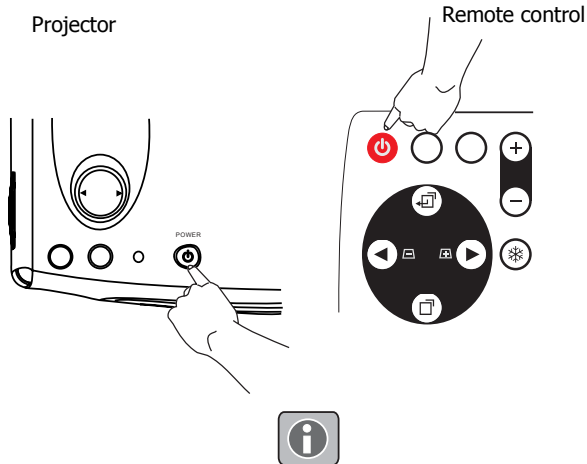

Are you sure to Power Off?
Press "Power" Again to Power Off.

3. Disconnect the power cord from the wall socket.

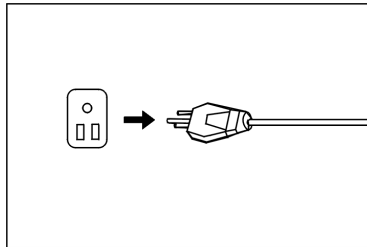

Caution

Please do not unplug the power cord before **POWER** is shut down or during the 60-second cooling process.

MAINTENANCE

Lamp Information

Use and Replacement of Lamp

When the Lamp Indicator lights up red or a message displays to suggest the time of lamp replacement, please change a new lamp or consult your dealer. An old lamp could cause a malfunction to the projector and may explode.

LED Status Indicators

Lamp Life Indicators	When this LED shows red continuously, it is warning you that the lamp life has exceeded 1500 hours. Replace the projection lamp with a new one immediately.
CHANGE THE LAMP, AND RESET THE LAMP TIMER	The lamp has been in operation for 1400 hours. Change a new lamp for optimal performance.
CHANGE THE LAMP. THE POWER WILL TURN OFF AFTER 20 HOURS	The lamp has been in operation for 1480 hours, and the power will turn off after 20 hours.
CHANGE THE LAMP!	The lamp has been in operation for over 1500 hours. The warning message will display for 30 seconds every 5 minutes after you turn on the projector and the power will turn off automatically in 10 minutes
Lamp is not properly attached	LED blinks rapidly.
Temperature is too high	When the projector's internal temperature is too hot to operate safely, the LED blinks slowly for one minute and the lamp turns off automatically. If the LED light is off, the projector's lamp and temperature are operating under normal conditions.



Caution

The LAMP indicator will light up if the lamp becomes too hot. Turn off the power and let the projector cool for 45 minutes. If the LAMP indicator is still red when turning the power on, please contact your dealer.

Lamp Replacement

Please check with LG service center for the information of lamp replacement.

TROUBLESHOOTING

Common Problems & Solutions

PROBLEMS	TRY THESE SOLUTIONS
NO POWER	<ul style="list-style-type: none">• Plug the power cord into the AC inlet.• Plug the power cord into the power inlet.• Wait two minutes after the projector is turned off before turning the projector back on.
NO PICTURE	<ul style="list-style-type: none">• Check for the proper input source.• Ensure all cables are connected properly.• Adjust the brightness and contrast.• Remove the lens cap.
TRAPEZOID IMAGE ON THE SCREEN	<ul style="list-style-type: none">• Reposition the unit to improve its angle on the screen.• Use the Keystone correction key on the control panel of the projector or the remote control unit.
POOR COLOR	<ul style="list-style-type: none">• Select the correct video system.• Adjust brightness, contrast, or saturation.
BLURRED IMAGE	<ul style="list-style-type: none">• Press Auto on the control panel of the projector or the remote control unit to get better picture quality.• Adjust the focus.• Reposition the unit to improve its screen angle.• Ensure the distance between the unit and screen is within the adjustment range of the lens.
REMOTE CONTROL DOES NOT WORK	<ul style="list-style-type: none">• Replace the batteries with new ones.• Make sure there is no obstacle between the remote control and the unit.• Stand within 4 meters (13 feet) of the unit.• Make sure nothing blocking the front and rear receivers.

Status Messages

On Screen Messages	Description
SEARCHING	Projector is searching for input.
INPUT SIGNAL DETECTED, ACTIVATING AUTO IMAGE	Projector has identified the input signal and is running the auto image adjustment function.
SYNC IS OUT OF RANGE	Input signal frequency exceeds the projector's.
CHANGE THE LAMP, AND RESET THE LAMP TIMER	The lamp has been in operation for 1400 hours. Lamp replacement is recommended.
CHANGE THE LAMP, THE POWER WILL TURN OFF AFTER 20 HOURS	The lamp has been in operation for 1480 hours, and the power will turn off after 20 more hours. Replace the lamp as soon as possible.
CHANGE THE LAMP!	The lamp has been in operation for over 1500 hours, and the power will turn off automatically in 10 minutes. Replace the lamp immediately.

SPECIFICATIONS

Projector Specifications

Technical Specifications

Note: All specifications are subject to change without notice.

General

Product name Personal Projector

Optical

Display system 1-CHIP DMD
Lens F/Number F/2.6
Lamp 120W VIP lamp

Electrical

Power supply AC100 ~ 240V, 2.3A, 50/60 Hz (Automatic)
Power consumption 185 W (Max)

Mechanical

Dimensions 220 mm (W) x 52 mm (H) x 175 mm (D)
Operating
temperature range 0°C ~ 40°C
Weight 3.85 lbs (1.69 Kg)

Input terminal

Computer Input
 RGB/HDTV input D-sub 15-pin (female)
Video Signal Input
 S VIDEO Mini DIN 4-pin terminal
 VIDEO RCA Jack terminal
Audio Signal Input
 Audio Mini Jack Stereo Terminal

Output

 speaker 1 Watt x 1

Timing Chart

Resolution	H Sync (kHz)	V Sync (Hz)	Remark
640x350	31.5	70.1	
640x400	37.9	85.1	VESA
720x400	31.5	70.0	
720x400	37.9	85.1	VESA
640x480	31.5	60.0	VESA
640x480	37.9	72.8	VESA
640x480	35	66.7	Macintosh
640x480	43.3	85.0	VESA
800x600	35.2	56.3	VESA
800x600	37.9	60.3	VESA
800x600	46.9	75.0	VESA
800x600	48.1	72.2	VESA
800x600	53.7	85.1	VESA
832x624	49.7	74.5	Macintosh
1024x768	48.4	60.0	VESA
1024x768	56.5	70.1	VESA
1024x768	60.0	75.0	VESA
1024x768	68.7	85.0	VESA
1280x1024	64.0	60.0	VESA

DIMENSIONS

