

JVC[®]
PROFESSIONAL

D-ILA™ PROJECTOR
DLA-M20/L20

The Power To Project Your Best Image

2000
ANSI Lumens

SXGA

ProSelecta

View :: Compare :: Select - www.ProSelecta.com

Tomorrow's Standard In Projection Performance

Breakthrough D-ILA™ technology takes projection performance to new levels of quality and convenience

JVC's powerful new duo of D-ILA™ projectors boast the superior picture performance you demand and the high-performance multimedia capability you need. Combining true S-XGA resolution with 2000 ANSI lumens of brightness and a super-crisp 350:1 contrast ratio, these compact, easy-to-install projectors are ideal for boardrooms, training centers, or conference facilities.



D-ILA™ — A Breakthrough In Projection Technology

The core of D-ILA™ (Direct Drive Image Light Amplifier) projector device is a high-density reflective type LCD able to project high-resolution images. With a homeotropic structure in which the LCD elements are aligned vertically, the D-ILA™ device produces extra-bright, high-contrast images ideal for big-screen projection applications.

The key to more affordable home and general presentation projectors, the new 0.7" S-XGA+ (1,400 x 1,050) device is

able to take advantage of higher yield, allowing it to lower cost while offering a higher resolution.

Also coming soon is the industry leading Q-XGA (2,048 x 1,536) device. Offering full HDTV (1080i) compatibility without compression, as well as D-ILA™'s hallmark crystal clear picture quality, Q-XGA is destined to become the premier display technology for digital cinema and other high-end applications.

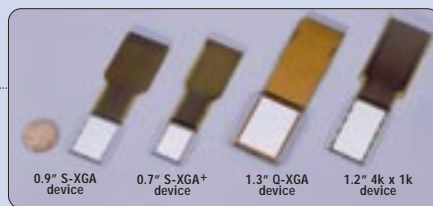

High-Brightness 2000 ANSI Lumens & Extra-High 350:1 Contrast Ratio

The D-ILA™'s high light efficiency is supported by a powerful Xenon lamp that makes it possible for the DLA-M20/L20 to generate an amazing 2000 ANSI lumens of brightness. In combination with the extra-high contrast of 350:1, this ensures that projected images are clear, bright, highly visible images even in a bright room.

2000
ANSI Lumens

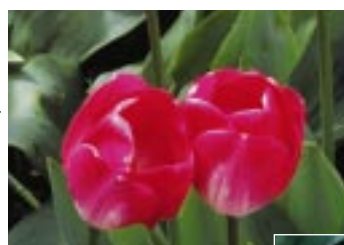

D-ILA™ projector image (simulated)



Conventional projector image (simulated)

True S-XGA Resolution

When projected onto a large-size screen, the DLA-M20/L20's high-density LCD panels provide true S-XGA resolution without scaling or loss of quality. With resolution of up to 1,365 x 1,024 pixels, even the small characters and icons typical of computer displays can be reproduced clearly. This makes the DLA-M20/L20 the perfect choice for projection of high-resolution 3D graphics or detailed CAD images.

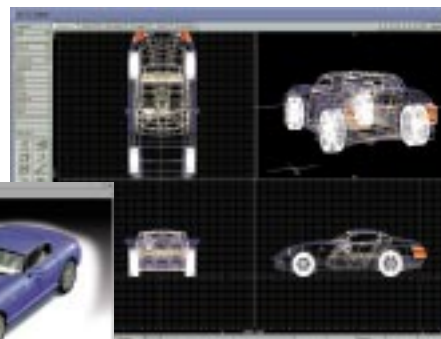

SXGA

Adjustable Lens for Flexible Configuration

Stack-mounted image



For more flexible installation, both models feature lens shift capability. The projection lens can be manually offset between 30% and 55% in the vertical direction.

• DLA-L20: 2.9:1—5.6:1 Zoom lens

With its long-focus 2.9:1–5.6:1 zoom lens, the DLA-L20 can be installed in a broad room, still maintaining easy adjustment of the screen position even when projected from a distance. So you can install the projector virtually anywhere in a room.

• DLA-M20: 1.5:1 Fixed lens

With adjustable 1.5:1 lens, you can quickly obtain an optimum projection image even when using two units of DLA-M20 in a stacked configuration, allowing you to achieve even higher levels of brightness than is possible with a single projector.

DLA-M20/L20 Screen shift

Normal Projection (0% shifted)

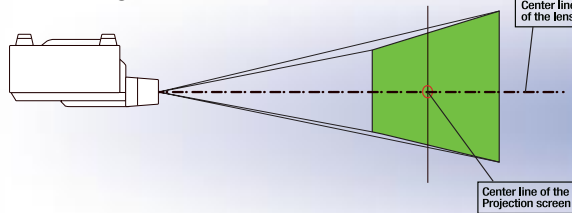

Offset Projection (30% — 55% shifted)

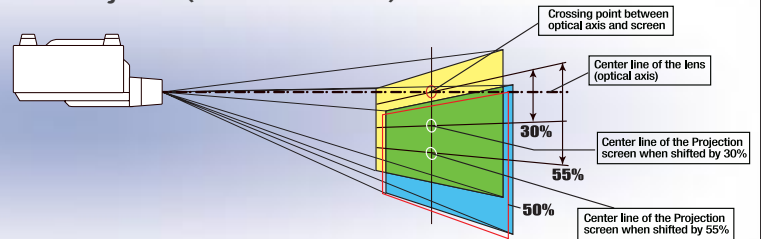

* Screen shift percentage is based on screen height = 100

Advanced Picture Improvement Technologies

The Adaptive DPC (Digital Pixel Conversion) circuitry optimizes picture quality regardless of the input signal resolution to ensure smooth, clear images. The 10-Bit Digital Gamma Correction circuitry facilitates accurate gray scale and color reproduction. In combination with the natural emission spectrum of the Xenon lamp, this further enhances the natural characteristics of the projected color.

Designed for Professional Use

Specifically designed to satisfy the demanding requirements of professional applications, the DLA-M20/L20 is equipped with two PC inputs for seamless integration into pre-installed cabling setups. Input channel settings can be set independently for each of the computer inputs (up to 10 user-preset channel settings available) and a wide range of scanning frequencies are provided to enable these high-performance projectors to accommodate most standard input devices.

Full signal input capability



DLA-L20

Screen size	(Diagonally)	(inches)	40	80	160	200	270	400
	(Width)	(m)	0.81	1.63	3.25	4.06	5.49	8.12
	(ft)	2.66	5.33	10.66	13.32	18.00	26.64	

Throw distance	Tele	(m)	4.52	8.93	17.74	22.15	29.87	—
		(ft)	14.83	29.30	58.20	72.67	98.00	—
	Wide	(m)	—	4.74	9.38	11.70	15.75	23.29
		(ft)	—	15.55	30.77	38.39	51.67	76.38

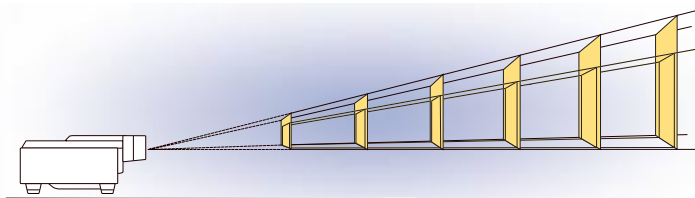

Throw Distance vs. Screen Size (Offset projection angle: 50%)

DLA-M20

Screen size	(Diagonally)	(inches)	60	80	100	120	150
	(Width)	(m)	1.22	1.63	2.03	2.44	3.05
	(ft)	4.00	5.33	6.66	8.00	10.00	

Throw distance	(m)	1.76	2.37	2.98	3.59	4.50
	(ft)	5.77	7.77	9.77	11.76	14.76

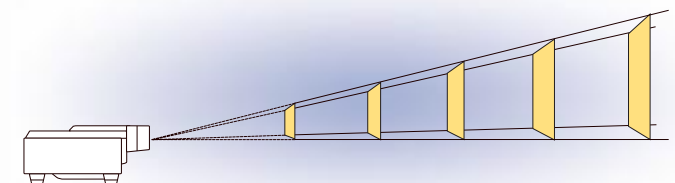

The Ideal Replacement for CRT Projectors

With a lens that has the same projection ratio as that used in many CRT projectors, the DLA-M20 can be installed in practically the same position, providing an easy replacement option. And thanks to the lens shift capability, you won't have to reposition the projection screen either.

Clear, crisp projection images available even in bright, spacious sites such as event halls, auditoriums, or large conference rooms.



JVC D-ILA™ Projector "20 Series"



DLA-G20

- ❑ High-brightness 2000 ANSI lumens
- ❑ High-contrast ratio of 350:1
- ❑ 2:1 — 3:1 Zoom lens
- ❑ True S-XGA (1,365 x 1,024) resolution
- ❑ Adaptive DPC & 10-bit digital gamma correction for superior image quality

DLA-M20/L20/G20 Other Features

- Auto-alignment function for automatic adjustment of tracking, phase and position
- Up-down/left-right inversion
- Selectable colour temperature (High/Mid/Low)
- Selectable background color (when no signal is input)
- On-screen menu (6-language selectable)
- Resizing function for full-screen projection of XGA/S-VGA/VGA images
- 1000 hours of lamp life
- Lamp life "warning" indicator
- Lamp "sleep" function — in the absence of any signal for a preset time (10 min., 20 min., 30 min., selectable), the lamp is automatically shut off for safety and power saving
- Wired remote control (optional)



Wired remote control (optional)

Specifications

D L A - M 2 0 / L 2 0

Image Device:	3 D-ILA™ (0.9 inches diagonal)	Output:	PC Monitor: D-sub (female) Audio: Stereo
Projection Lens:	DLA-M20: 1.5:1 fixed focus lens DLA-L20: 2.9:1 — 5.6:1 zoom lens	Throw Distance:	DLA-M20: 5.77ft — 14.76ft (1.76m — 4.50m) DLA-L20: 14.83ft — 98.00ft (4.52m — 29.87m)
Brightness:	2,000 ANSI lumens	Screen Size:	DLA-M20: 60" — 150" (1.22m — 3.05m) DLA-L20: Wide: 80" — 510" (1.63m — 10.36m) Tele: 40" — 270" (0.81m — 5.49m)
Resolution:	1,365 x 1,024 pixels Full coverage of S-XGA (1,280 x 1,024) graphics	Lamp:	550 watts, Xenon
Contrast Ratio:	More than 350:1	Audio:	Built-in stereo speakers (1W + 1W stereo)
Colour Reproduction:	16.7 million colours	Input Power:	100 — 120V, 50/60 Hz AC
Scan Frequency:	Horizontal: 15 — 82 kHz Vertical: 50 — 78 Hz	Power Consumption:	850 W
Input:	Analogue RGB x 2 (D-Sub (female) x 1, R, G, B, H, V x 1) Y/C-Separated x 1 Composite x 1 Component x 1 (Y/R-Y/B-Y, Y/Pb/Pk for HDTV)	Dimensions (WxHxD):	19.9"x10.4"x17.2" (505mm x 264mm x 437mm)
		Weight:	DLA-M20: 39.5lbs. (17.9kg) DLA-L20: 40.3lbs (18.3kg)
		Provided Accessories:	AC cable, Wireless (infrared) remote control, PC connection cable (D-sub 15-pin male-D-sub 15-pin male), Adapter for Macintosh, AV cable, Audio cable, BNC-RCA adapter, Lens cap, Operation manual, Battery for remote control unit x 2

Dimensions

D L A - M 2 0 / L 2 0

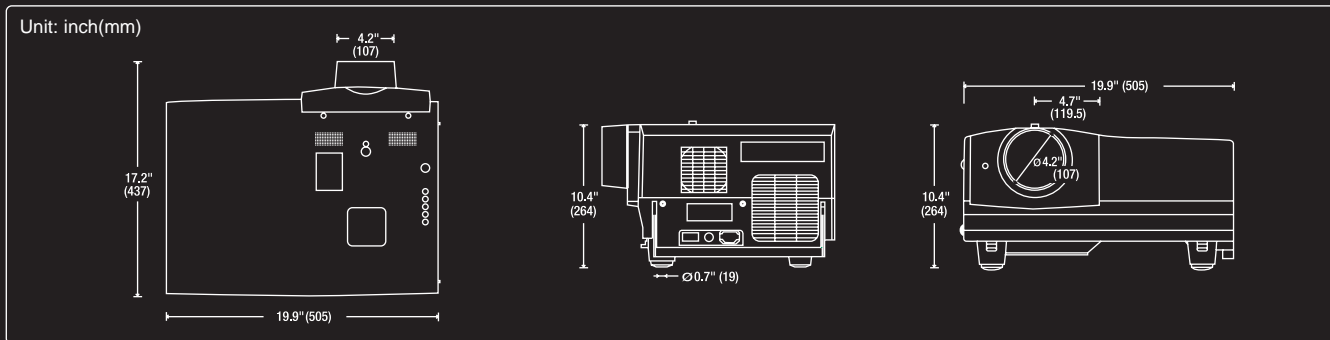

D-ILA is a trademark of Victor Company of Japan, Limited.

E. & O.E. Design and specifications are subject to change without notice.

All brand names and product names are trademarks, registered trademarks, or trade names of their respective holders.

All photographs and screenshots in this catalogue are simulated.

Copyright © 2000, Victor Company of Japan, Limited (JVC). All rights reserved

JVC®

JVC PROFESSIONAL PRODUCTS COMPANY
DIVISION OF JVC AMERICAS CORP
1700 Valley Road, Wayne N.J. 07470
TEL: 973-315-5000, 1-800-526-5308 FAX: 973-315-5030
<http://www.jvc.com/pro>

JVC CANADA INC.
21 Finchdene Square, Scarborough Ontario M1X 1A7
TEL: 416-293-1311 FAX: 416-293-8208
<http://www.jvcpro.com>

DISTRIBUTED BY