

User's Guide

Multimedia Projector

EB-G5950

EB-G5900

EB-G5800

EB-G5650W



EB-G5600

EB-G5500





Notations Used in This Guide

- **Safety indications**

The documentation and the projector use graphical symbols to show how to use the projector safely. Please understand and respect these caution symbols in order to avoid injury to persons or property.

 Warning	This symbol indicates information that, if ignored, could possibly result in personal injury or even death due to incorrect handling.
 Caution	This symbol indicates information that, if ignored, could possibly result in personal injury or physical damage due to incorrect handling.

- **General information indications**

Attention	Indicates procedures which may result in damage or injury if sufficient care is not taken.
	Indicates additional information and points which may be useful to know regarding a topic.
	Indicates a page where detailed information regarding a topic can be found.
	Indicates that an explanation of the underlined word or words in front of this symbol appears in the glossary of terms. See the "Glossary" section of the "Appendix".  p.159
<div style="border: 1px solid black; padding: 2px; display: inline-block;">Procedure</div>	Indicates operating methods and the order of operations. The procedure indicated should be carried out in the order of the numbered steps.
[(Name)]	Indicates the name of the buttons on the Remote Control or the Control panel. Example: [Esc] button
"(Menu Name)" Brightness (Boldface)	Indicates the configuration menu items. Example: Select "Brightness" from the Image menu. Image menu - Brightness

Notations Used in This Guide 2

Introduction

Projector Features 8

- Ease of Use when Installed on a Ceiling Mount 8
- Reliability You can Depend on 8
- Meets a Wide Range of Needs 8
- Enhanced Security Functions 8
- Easy to Handle 9
- Monitoring and Control Functions 9
- Taking Full Advantage of a Network Connection (EB-G5950/G5650W only) 9

Part Names and Functions 10

- Front/Top 10
- Base 11
- Rear 12
- Interface 12
 - EB-G5950/G5650W 12
 - EB-G5900/G5600 13
 - EB-G5800/G5500 14
- Control Panel 15
- Remote Control 16
 - Installing the batteries 18
 - Operating range of remote control 19

Useful Functions

Adjusting the Projected Image 21

- Displaying a Test Pattern 21
- Adjusting the Position of the Projected Image (Lens Shift) 22
- Correcting Distortion in the Projected Image 22
 - Quick Corner 23
 - H/V-Keystone 25

Changing the Projected Image 27

- Automatically Detect Input Signal and Change the Projected Image (Source Search) 27
- Switch to the Target Image by Remote Control 28

Changing the Aspect Ratio of the Projected Image 29

- Changing the Aspect Mode (EB-G5950/G5900/G5800/G5600/G5500) 30
 - Projecting images from video equipment 30
 - Projecting images from the HDMI input port (EB-G5950/G5900/G5600 only) 30
 - Projecting images from a computer 30
- Changing the Aspect Mode (EB-G5650W) 31
 - Projecting images from video equipment or from the HDMI input port 31
 - Projecting images from a computer 31

Selecting the Projection Quality (Selecting Color Mode) 33

Projecting Two Images Simultaneously (Split Screen) (EB-G5950/G5900/G5650W/G5600 only) 34

- Input Sources for Split Screen Projection 34
- Operating Procedures 34
 - Projecting on a split screen 34
 - Switching the left and right screens 35
 - Switching the left and right image sizes 35
 - Ending the split screen 36
- Restrictions during Split Screen Projection 36
 - Operating restrictions 36
 - Restriction relating to images 37

Functions for Enhancing Projection 38

- Hiding the Image and Sound Temporarily (A/V Mute) 38
- Freezing the Image (Freeze) 38
- Pointer Function (Pointer) 39
- Enlarging Part of the Image (E-Zoom) 40

Limitation of the Number of the Target Projectors when Using Multiple Projectors 42

- Setting the Projector ID 42
- Checking the Projector ID 42

Setting the Remote Control ID	43
Color Correction when Projecting from Multiple Projectors (Multi-screen Color Adjustment)	45
Summary of Correction Procedure	45
Correction Method	45
Saving a User's Logo	47
Security Functions	49
Managing Users (Password Protect)	49
Type of Password Protect	49
Setting Password Protect	49
Entering the Password	50
Restricting Operation (Control Panel Lock)	51
Anti-Theft Lock	52
Installing the wire lock	52
Anti-theft projection lens	52
Configuration Menu	
<hr/>	
Using the Configuration Menu	54
Image Menu	55
Signal Menu	57
Settings Menu	59
Extended Menu	61
Network Menu (EB-G5900/G5800/G5600/G5500)	64
Network Menu (EB-G5950/G5650W)	67
Notes on Operating the Network Menu	68
Soft Keyboard Operations	68
Basic Menu	69
Wireless LAN Menu	70
Security Menu (Only available when the Wireless LAN unit is installed)	72

When WEP is selected	73
When WPA-PSK(TKIP/AES) or WPA2-PSK(TKIP/AES) is selected	75
When EAP-TLS is selected	76
EAP-TTLS/MD5, EAP-TTLS/MS-CHAPv2, PEAP/MS-CHAPv2, PEAP/GTC, LEAP, EAP-Fast/MS-CHAPv2, EAP-Fast/GTC is selected	77
Wired LAN Menu	78
Mail Menu	79
Others Menu	80
Reset Menu	81

Info Menu (Display Only) 82

Reset Menu 83

Troubleshooting

Using the Help 85

Problem Solving 87

Reading the Indicators	87
⏻ Indicator is lit or flashing red	88
☞ Indicator is flashing or lit	89
When the Indicators Provide No Help	91
Problems relating to images	92
Problems when projection starts	96
Other problems	97
Interpreting Event IDs (EB-G5950/G5650W only)	99

Maintenance

Cleaning 101

Cleaning the Projector's Surface	101
Cleaning the Lens	101
Cleaning the Air Filter	101

Replacing Consumables 104

Replacing the Lamp	104
--------------------------	-----

Lamp replacement period	104
How to replace the lamp	104
Resetting the Lamp Hours	107
Replacing the Air Filter	107
Air filter replacement period	107
How to replace the air filter	107

Notes on Transportation 109

Moving Nearby	109
When Transporting	109
Preparing packaging	109
Notes when packing and transporting	109

Monitoring and Controls

EasyMP Monitor 111

Changing Settings Using a Web Browser (Web Control) 112

Displaying Web Control	112
Displaying Web Remote	112

Using the Mail Notification Function to Report Problems 114

Reading Problem Mail Notification Function	114
--	-----

Management Using SNMP 115

ESC/VP21 Commands 116

Serial Connection	116
Communications protocol	116
Command List	116

About PJLink 118

About Crestron RoomView® (EB-G5950/G5650W only) 119

Operating a Projector from a Computer Window	119
Displaying the operation window	119
Using the operation window	120
Using the tools window	121

Network Functions (EB-G5950/G5650W Only)

Projecting with "Connect to a Network Projector" (EB-G5950/G5650W Only) 124

Making a WPS (Wi-Fi Protected Setup) Connection with a Wireless LAN Access Point (EB-G5950/G5650W only) 125

Connection Setup Method	125
Making a connection using the push button method	126
Making a connection using the PIN Code Method	127

Installation and Connections

Installation Methods 131

Switching the Projection Mode	131
-------------------------------------	-----

Connecting to Video Equipment 133

Connecting to a Computer	133
Changing the video output from a laptop computer.	135
Connecting to Video Equipment	135

Connecting to External Equipment 139

Connecting a LAN Cable	139
Connecting to an external monitor (EB-G5950/G5900/G5650W/G5600 only)	139
Connecting to External Speakers (EB-G5950/G5900/G5650W/G5600 only)	139

Installing Optional and Supplied Accessories 141

Removing and Attaching the Projector Lens Unit	141
Removing	141
Attaching	142
Installing the Wireless LAN Unit (ELPAP03) (EB-G5950/G5650W only)	143
Attaching	143
Reading the wireless LAN indicators	143
Attaching and Removing the Cable Cover	144
Attaching	144
Removing	145

Appendix

Optional Accessories and Consumables	147
Optional accessories	147
Consumables	148
Screen Size and Projection Distance	149
Projection Distance of EB-G5950/G5900/G5800/G5600/G5500	149
Projection Distance of EB-G5650W	150
Supported Monitor Displays	151
Supported Monitor Displays for EB-G5950/G5900/G5800/G5600/G5500	151
Computer signals (analog RGB)	151
Component Video	151
Composite Video/S-Video	151
Input signals from HDMI input port (EB-G5950/G5900/G5600 only)	151
Supported Monitor Displays for EB-G5650W	152
Computer signals (analog RGB)	152
Component Video	152
Composite Video/S-Video	152
Input signals from HDMI input port	153
Specifications	154
Projector General Specifications	154
Appearance	158
Glossary	159
General Notes	161
About Notations	161
General Notice	161
Index	178



Introduction

This chapter explains the projector's features and the part names.

Ease of Use when Installed on a Ceiling Mount

Centered lens

The lens is positioned in the center of the projector so it is well balanced and is easy to mount on a ceiling. This also makes it easy to line up the screen and the projector.

Equipped with a horizontal and vertical lens shift

Using the lens shift function that allows you to adjust the position of the projected image along the horizontal and vertical axis opens up a wide variety of installation locations.

☞ p.22

Five optional lenses are provided

You can select the best lens according to the projection distance and purpose. The bayonet type allows you to simply and easily exchange and install the optional lenses.

☞ p.141, p.147

A design that harmonizes with the surrounding environment, and makes the installation easy

The projector's sophisticated design has a cable cover in which cables are hidden for a clean exterior appearance.

Easy maintenance

You can replace the lamp by opening the cover on the side of the projector and pulling it out horizontally.

You can also replace the air filter by simply sliding it out of or into the front of the projector.

Reliability You can Depend on

A large static electricity filter is used in the air intake system. This reduces the amount of dust that enters the projector to prevent shutdown caused by temperature increases even when the projector is permanently mounted to a ceiling.

Meets a Wide Range of Needs

Project two images simultaneously (Split Screen)

You can simultaneously project the images from two video sources lined up on the screen. This increases the range of applications, such as when holding a video conference while projecting presentation materials. ☞ p.34

The split screen function is supported by EB-G5950/G5900/G5650W/G5600.



Clearly reproduce medical images

A color mode called "DICOM SIM" is provided to project medical images, such as X-ray photographs. This mode produces image quality that approaches the DICOM standard.

(The projector is not a medical device and cannot be used for medical diagnosis.)

☞ p.33

Precise color adjustments

As well as Color Mode, you can also adjust the image's absolute color temperature and the strength of each RGB color. Also, because you can adjust the hue, saturation, and brightness of each RGB, the image can be projected with depth and a color matching in superior detail.

Enhanced Security Functions

Password Protect to restrict and manage users

By setting a password you can restrict who can use the projector.  [p.49](#)

Control Panel lock restricts button operation on the control panel.

You can use this to prevent people changing projector settings without permission at events, in schools, and so on.  [p.51](#)

Equipped with various anti-theft devices

The projector is equipped with the following types of anti-theft security devices.  [p.52](#)

- Security slot
- Security cable installation point
- Screw to fix the lens unit removal button

Easy to Handle

Direct power On/Off

In places where power is managed centrally, such as in a conference room, the projector can be set to power on and off automatically when the power source to which the projector is connected is switched on or off.

No cool down delay

After turning the projector's power off, you can disconnect the projector's power cable without having to wait for the projector to cool down.

Monitoring and Control Functions

A selection of monitoring and control protocols is supported, such as the Epson EasyMP Monitor application software. This allows you to use the projector according to your system environment.  "Monitoring and Controls" [p.110](#)

Taking Full Advantage of a Network Connection (EB-G5950/G5650W only)

Simultaneously project four images for dynamic conferences

By using the supplied EasyMP Multi PC Projection applications software, the images from up to four computers that are connected to the network can be simultaneously displayed. Anyone can freely and easily project images from connected computers to make conferences and meetings more lively.  [EasyMP MultiPC Projection Operation Guide](#)

Transferring images and audio using the network

The supplied EasyMP Network Projection applications software can be used to connect to network computers and transfer video, audio, and movies. Using a variety of transfer functions increases presentation possibilities.  [EasyMP Network Projection Operation Guide](#)

Project using "Connect to a Network Projector"

By connecting the projector to a network and using the Network Projector function in Windows Vista or Windows 7, multiple users on the network can share the projector.  [p.124](#)

Quick wireless connections to easily connect to the network

Network computers can be easily connected to the projector simply by connecting an optional Quick Wireless Connection USB Key. (This function is supported only for Windows computers.)  [p.147](#)

Front/Top

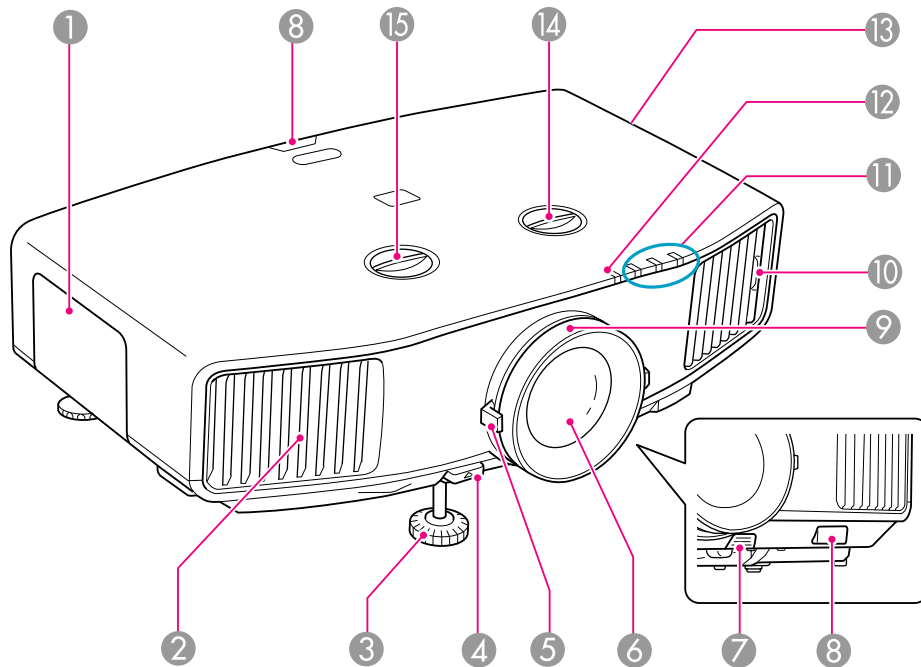

EB-G5950/G5650W with the standard lens is shown in the illustration.

From here on, all features will be explained using illustrations of EB-G5950/G5650W with a standard lens unless otherwise specified.





Name	Function
① Lamp cover	Open this cover when replacing the projector's lamp. ☛ p.104



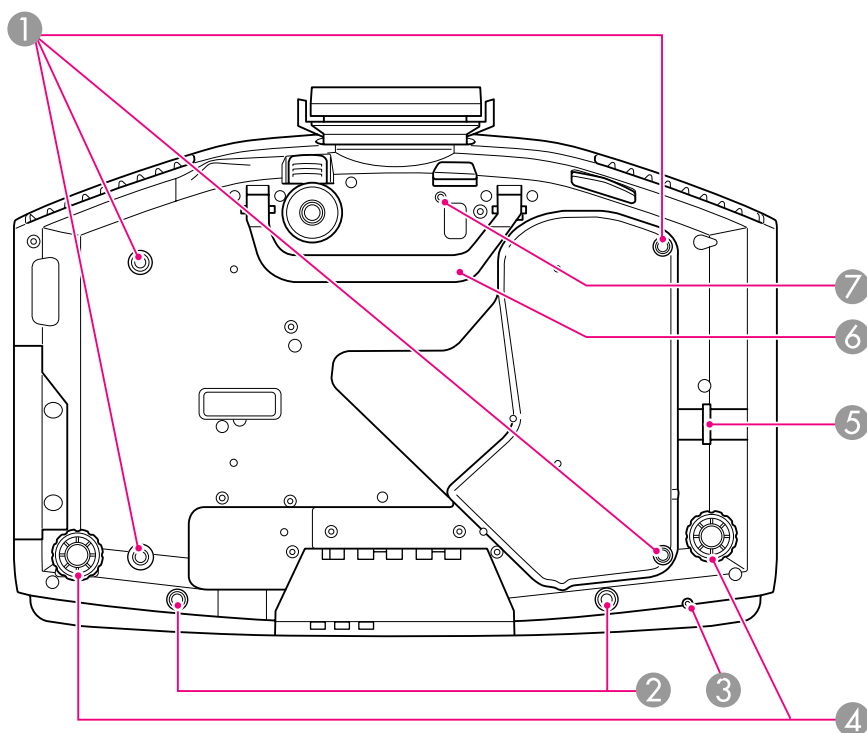

Name	Function
② Air exhaust vent	Exhaust vent for air used to cool the projector internally. <div style="border: 1px solid black; padding: 5px; background-color: #e0f2f1;"> <p>⚠ Caution Do not place objects that may become warped or otherwise affected by heat near the Air exhaust vent and do not put your face or hands near the vent while projection is in progress.</p> </div>
③ Front adjustable foot	Extend and adjust the position of the projected image when the projector is placed on a surface such as a desk. ☛ Quick Start Guide
④ Foot adjust lever	Pull out the foot lever to extend and retract the front foot. ☛ Quick Start Guide
⑤ Zoom ring	Adjusts the image size. ☛ Quick Start Guide
⑥ Projection lens	Images are projected through here.
⑦ Lens unit removal button	Press this button to remove the lens unit when replacing lens units. ☛ p.141
⑧ Remote receiver	Receives signals from the remote control. ☛ p.19
⑨ Focus ring	Adjusts the image focus. ☛ Quick Start Guide
⑩ Air filter tab	When cleaning or replacing the air filter, use this tab to pull out the air filter. ☛ p.101, p.107
⑪ Status indicators	The color of the indicators and whether they are flashing or lit indicate the status of the projector. ☛ p.87
⑫ Wireless LAN indicator (EB-G5950/G5650W only)	This indicator shows the status of network access when the Wireless LAN unit is installed. ☛ p.143
⑬ Air intake vent (Air filter)	Takes in air to cool the projector internally. If dust collects here it can cause the internal temperature to rise, and this can lead to problems with operation and shorten the optical engine's service life. Be sure to clean the air filter regularly. ☛ p.101

Name	Function
⑭ Vertical lens shift dial	Turn the dial to move the position of the projected image up or down.  p.22
⑮ Horizontal lens shift dial	Turn the dial to move the position of the projected image left or right.  p.22

Base





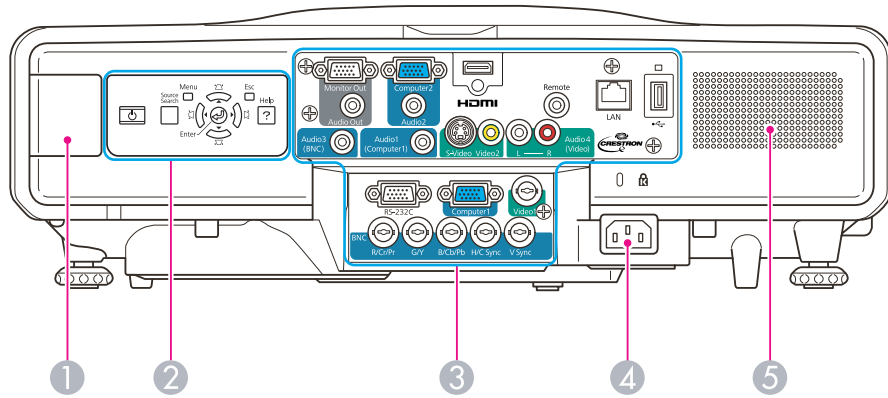

Name	Function
① Ceiling mount fixing points (4 points)	Attach the optional ceiling mount here when suspending the projector from a ceiling.  p.147 , p.131

Name	Function
② Screw holes to fix the cable cover	Holes for screws to fix the cable cover in place.  p.144
③ Screw hole to fix Wireless LAN unit (EB-G5950/G5650W only)	When installing the Wireless LAN unit, use this screw hole to fix the unit in place to avoid loss and so on.  p.143
④ Rear foot	When setup on a desk, turn to extend and retract to adjust the horizontal tilt.  Quick Start Guide
⑤ Security cable installation point	Pass a commercially available anti-theft wire lock through here when you want to secure the projector to a fixed object.  p.52
⑥ Handle	Use these handles when carrying the projector.
⑦ Screw hole for the screw to fix the lens unit removal button	When installing a lens unit, use this screw hole to fix the lens unit removal button using the screw supplied.  p.52

Rear



Name	Function
1 Wireless LAN unit installation section (EB-G5950/G5650W only)	Install the Wireless LAN unit here. Remove the cover when installing.  "Installing the Wireless LAN Unit (ELPAP03) (EB-G5950/G5650W only)" p.143
2 Control Panel	 "Control Panel" p.15
3 Interface	 "Interface" p.12
4 Power inlet	Connects to the power cable.  <i>Quick Start Guide</i>
5 Speaker (EB-G5950/G5900/G5650W/G5600 only)	

Interface

EB-G5950/G5650W

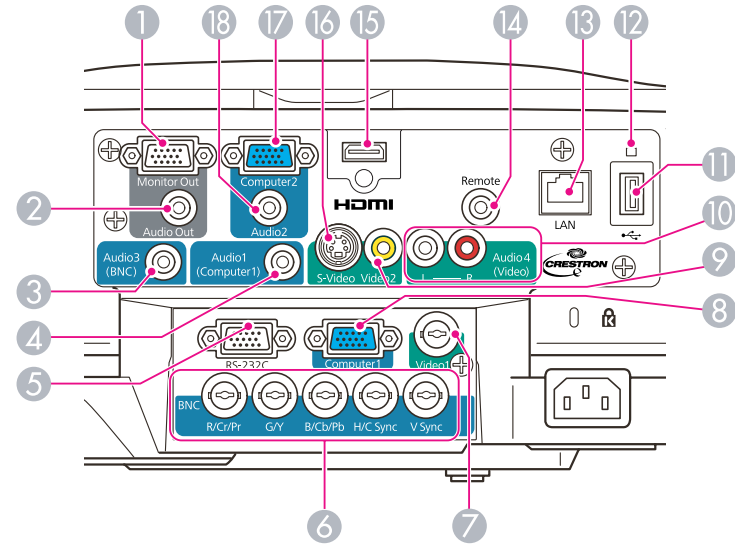

Name	Function
1 Monitor Out port	Outputs to an external monitor the analog RGB signal from the computer connected to the Computer1 input port, Computer2 input port, or BNC input port. The signals that are input from other ports and component video signals cannot be output.
2 Audio Out port	Outputs the sound of the image currently being projected to external speakers.
3 Audio3 input port	Connects to the audio out port of the device that is connected to the BNC input port.
4 Audio1 input port	Connects to the audio out port of the device that is connected to the Computer1 input port.

Name	Function
5 RS-232C port	When controlling the projector from a computer, connect it to the computer with an RS-232C cable. This port is for control use and should not normally be used. ☛ "ESC/VP21 Commands" p.116
6 BNC input port	For analog RGB signals from a computer and component video signals from other video sources.
7 Video1 input port	For composite video signals from video sources.
8 Computer1 input port	For analog RGB signals from a computer and component video signals from other video sources.
9 Video2 input port	For composite video signals from video sources.
10 Audio4 input port	Connects to the audio out port when you want to output audio from the projector from equipment connected to the S-Video input port, Video1 input port, or Video2 input port.
11 USB(TypeA) port	Connects a USB storage device or a digital camera, and projects image/movie files and scenarios. ☛ PC Free Operation Guide
12 USB indicator	The following explains the status of USB devices connected to USB(TypeA) port. OFF: USB device is not connected Orange Light ON: USB device is connected Green Light ON: USB device is operating Red Light ON: Error
13 LAN port	Connects a LAN cable to connect to a network.
14 Remote port	Connects the optional remote control cable set and inputs signals from the remote control. When the remote control cable is plugged into this remote port, the remote receiver on the projector is disabled.
15 HDMI input port	Inputs video signals from HDMI™ compatible video equipment and computers. This projector is compatible with HDCP signals.
16 S-Video input port	For S-video signals from video sources.

Name	Function
17 Computer2 input port	For analog RGB signals from a computer and component video signals from other video sources.
18 Audio2 input port	Connects to the audio out port of the device that is connected to the Computer2 input port.

EB-G5900/G5600

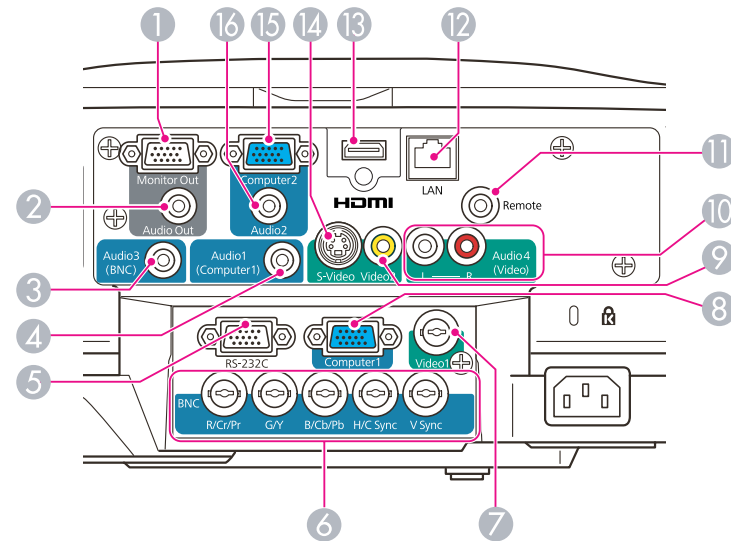

Name	Function
1 Monitor Out port	Outputs to an external monitor the analog RGB signal from the computer connected to the Computer1 input port, Computer2 input port, or BNC input port. The signals that are input from other ports and component video signals cannot be output.
2 Audio Out port	Outputs the sound of the image currently being projected to external speakers.

Name	Function
③ Audio3 input port	Connects to the audio out port of the device that is connected to the BNC input port.
④ Audio1 input port	Connects to the audio out port of the device that is connected to the Computer1 input port.
⑤ RS-232C port	When controlling the projector from a computer, connect it to the computer with an RS-232C cable. This port is for control use and should not normally be used. ☛ "ESC/VP21 Commands" p.116
⑥ BNC input port	For analog RGB signals from a computer and component video signals from other video sources.
⑦ Video1 input port	For composite video signals from video sources.
⑧ Computer1 input port	For analog RGB signals from a computer and component video signals from other video sources.
⑨ Video2 input port	For composite video signals from video sources.
⑩ Audio4 input port	Connects to the audio out port when you want to output audio from the projector from equipment connected to the S-Video input port, Video1 input port, or Video2 input port.
⑪ Remote port	Connects the optional remote control cable set and inputs signals from the remote control. When the remote control cable is plugged into this remote port, the remote receiver on the projector is disabled.
⑫ LAN port	Connects a LAN cable to connect to a network.
⑬ HDMI input port	Inputs video signals from HDMI™ compatible video equipment and computers. This projector is compatible with <u>HDCP</u> signals.
⑭ S-Video input port	For S-video signals from video sources.
⑮ Computer2 input port	For analog RGB signals from a computer and component video signals from other video sources.
⑯ Audio2 input port	Connects to the audio out port of the device that is connected to the Computer2 input port.

EB-G5800/G5500

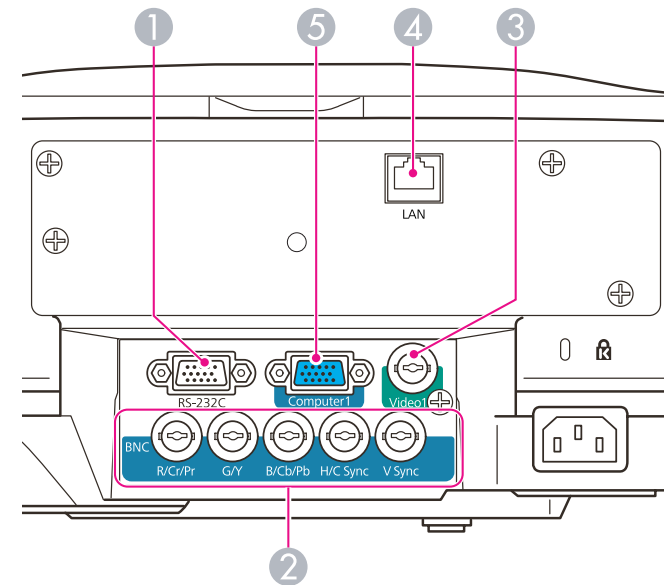

Name	Function
① RS-232C port	When controlling the projector from a computer, connect it to the computer with an RS-232C cable. This port is for control use and should not normally be used. ☛ "ESC/VP21 Commands" p.116
② BNC input port	For analog RGB signals from a computer and component video signals from other video sources.
③ Video1 input port	For composite video signals from video sources.
④ LAN port	Connects a LAN cable to connect to a network.
⑤ Computer1 input port	For analog RGB signals from a computer and component video signals from other video sources.

Control Panel

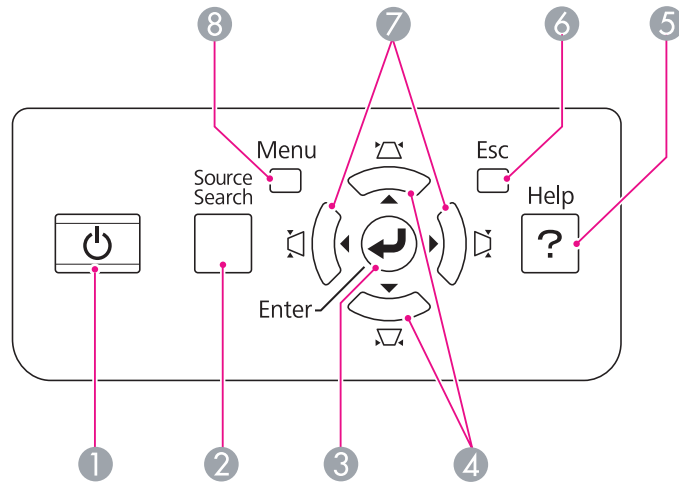





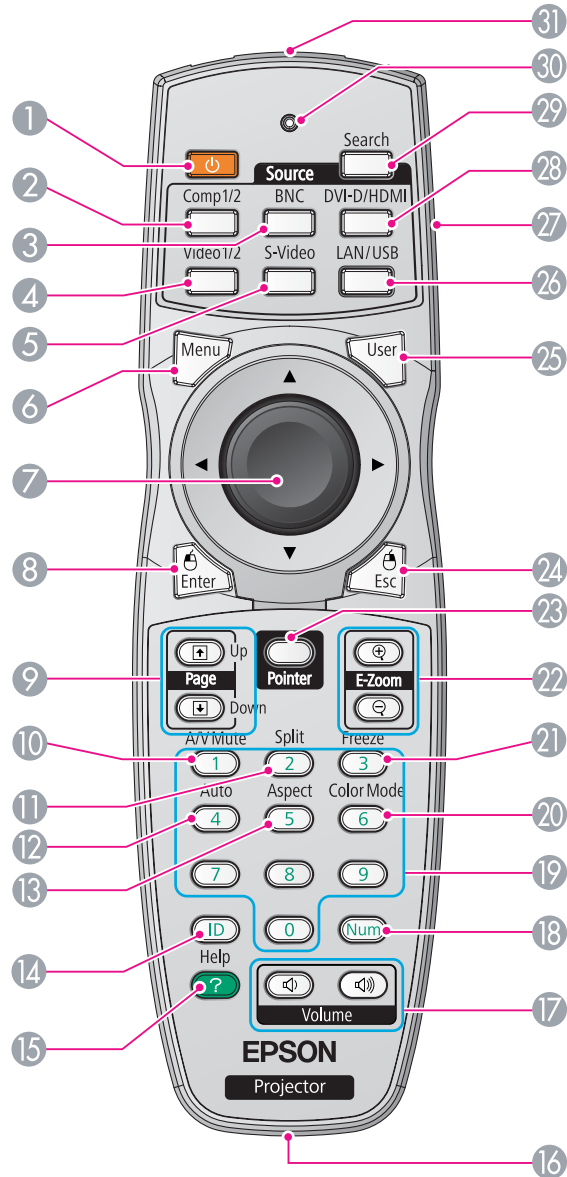

Name	Function
① [Power] button	Turns the projector power On or Off. 🖱️ Quick Start Guide
② [Source Search] button	Changes to the next input source that is connected to the projector and is sending an image. 🖱️ p.27
③ [Enter] button	If pressed during projection of computer analog RGB signals, it automatically adjusts the Tracking, Sync., and Position to project the optimum image. When the configuration menu or a Help screen is displayed, it accepts and enters the current selection and moves to the next level. 🖱️ p.54











Name	Function
④ [Up/Down] button	Corrects vertical keystone distortion. 🖱️ p.25 If pressed while the configuration menu or a Help screen is displayed, these buttons only have the [▲] and [▼] functions which select menu items and setting values. 🖱️ p.54 When projecting using PC Free or Connect to a Network Projector, these buttons function only as [▲] and [▼] buttons. (EB-G5950/G5650W)
⑤ [Help] button	Displays and closes the Help screen which shows you how to deal with problems if they occur. 🖱️ p.85
⑥ [Esc] button	Stops the current function. If pressed when the configuration menu is displayed, it moves to the previous menu level. 🖱️ p.54
⑦ [Left/Right] button	Corrects horizontal keystone distortion. 🖱️ p.25 If pressed while the configuration menu or a Help screen is displayed, these buttons only have the [◀] and [▶] functions which select menu items and setting values. 🖱️ p.54 When projecting using PC Free or Connect to a Network Projector, these buttons function only as [◀] and [▶] buttons. (EB-G5950/G5650W)
⑧ [Menu] button	Displays and closes the configuration menu. 🖱️ p.53

Remote Control



	Name	Function
①	[Power] button	Turns the projector power On or Off. Quick Start Guide
②	[Comp1/2] button	Each time the button is pressed, the image displayed changes between the Computer1 input port and Computer2 input port. (EB-G5950/G5900/G5650W/G5600) Changes to images from the Computer1 input port. (EB-G5800/G5500)
③	[BNC] button	Changes to images from the BNC input port.
④	[Video1/2] button	Each time the button is pressed, the image displayed changes between Video1 input port and Video2 input port. (EB-G5950/G5900/G5650W/G5600) Changes to images from the Video1 input port. (EB-G5800/G5500)
⑤	[S-Video] button	Changes to images from the S-video input port.(EB-G5950/G5900/G5650W/G5600 only) This button does not function when using EB-G5800/G5500.
⑥	[Menu] button	Displays and closes the configuration menu. p.53
⑦	[Enter] button	When the configuration menu or Help screen is displayed, it selects menu items and setting values. p.54 , p.85 When using the optional wireless mouse receiver, the pointer moves in the direction (eight possible directions) that the button is pressed.
⑧	[Enter] button	When the configuration menu or a Help screen is displayed, it accepts and enters the current selection and moves to the next level. p.54 , p.85 Acts as a mouse's left button when using the optional wireless mouse receiver.

Name	Function
9 [Page] buttons [↑][↓]	These buttons can be used to page up and down when projecting an image from a computer that is connected to the projector through the network. These buttons can be used to switch the screen when projecting with PC Free. (EB-G5950/G5650W only) These buttons can be used to page up and down when using the optional wireless mouse receiver.
10 [A/V Mute] button	Turns the video and audio on or off. (EB-G5950/G5900/G5650W/G5600) Turns the video on or off. (EB-G5800/G5500)  p.38
11 [Split] button	Press this button to split the screen in two and project two images simultaneously.  p.34 This button does not function when using EB-G5800/G5500.
12 [Auto] button	If pressed during projection of computer analog RGB signals, it automatically adjusts the Tracking, Sync., and Position to project the optimum image.
13 [Aspect] button	The <u>Aspect Ratio</u>  changes each time the button is pressed.  p.29
14 [ID] button	Press to set the remote control ID.  p.43
15 [Help] button	Displays and closes the Help screen which shows you how to deal with problems if they occur.  p.85
16 Remote port	Connects the optional remote control cable set and outputs signals from the remote control. (EB-G5950/G5900/G5650W/G5600 only) When the remote control cable is plugged into this remote port, the remote receiver is disabled.

Name	Function
17 [Volume] button  	 Decreases the volume.  Increases the volume.  <i>Quick Start Guide</i> This button does not function when using EB-G5800/G5500. <div style="border: 1px solid black; padding: 5px; margin-top: 10px;"> Caution <i>Do not start when the volume is set too high. Loud sounds may cause loss of hearing. Always lower the volume before turning off the projector. Gradually increase the volume after turning on the projector.</i></div>
18 [Num] button	Use this button to enter passwords, IP Address from the Network, and so on.
19 Numeric buttons	Use this button to enter passwords, remote control ID settings, IP Address from the Network, and so on.
20 [Color Mode] button	Each time the button is pressed, the Color Mode changes.  p.33
21 [Freeze] button	Images are paused or unpaused.  p.38
22 [E-Zoom] buttons [⊕][⊖]	The [⊕] button enlarges the image without changing the projection size. The [⊖] button reduces the parts of images that have been enlarged using the [⊕] button.  p.40
23 [Pointer] button	Press to activate the on screen pointer.  p.39
24 [Esc] button	Stops the current function. If pressed when the configuration menu is displayed, it moves to the previous menu level.  p.54 Acts as a mouse's right button when using the optional wireless mouse receiver.

Name	Function
25 [User] button	Press to assign a frequently used item from the six available configuration menu items. By pressing the button the assigned menu item selection/adjustment screen is displayed, allowing you to make one-touch settings/adjustments. p.59 Test Pattern is assigned as the default setting.
26 [LAN/USB] button	Each time you press this button, the image is switched between the image from a computer that is connected to the projector through the network and the image from the USB device that is connected to the USB(TypeA) port. (EB-G5950/G5650W only) This button does not function when using EB-G5900/G5800/G5600/G5500.
27 ID switch	Use this switch to enable (On)/disable (Off) ID settings for the remote control. p.42
28 [DVI-D/HDMI] button	Changes to images from the HDMI input port. (EB-G5950/G5900/G5650W/G5600 only) This button does not function when using EB-G5800/G5500.
29 [Source Search] button	Changes to the next input source that is connected to the projector and is sending an image. p.27
30 Indicators	A light is emitted when outputting remote control signals.
31 Remote control light-emitting area	Outputs remote control signals.

Installing the batteries

The batteries are not set in the remote control when it is sold. Set the supplied batteries (two, AA alkaline batteries) to use the remote control.

Attention

Make sure you read the Safety Instructions before handling the batteries.
[Safety Instructions](#)

Procedure

1 Remove the battery cover.

While pushing the battery compartment cover catch, lift the cover up.

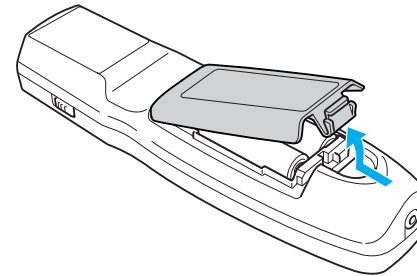

2 Insert the batteries in the correct direction.

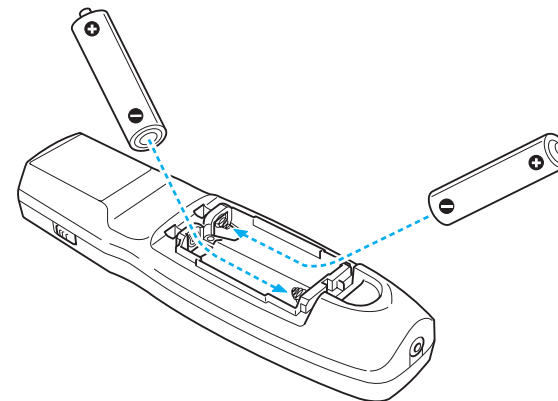



Caution

Check the positions of the (+) and (-) marks inside the battery holder to ensure the batteries are inserted the correct way.

3

Replace the battery cover.

Press the battery compartment cover until it clicks into place.

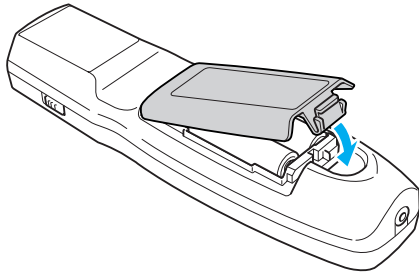

If delays in the responsiveness of the remote control occur or if it does not operate after it has been used for some time, it probably means that the batteries are becoming flat. When this happens, replace them with new batteries. Have two AA size alkaline batteries ready. You cannot use other batteries except for the AA size alkaline.

Operating range of remote control

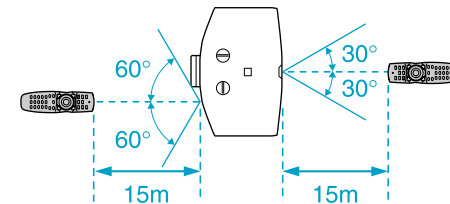

When using the remote control, point the remote control light-emitting area at the remote receiver on the projector. The operating range of the remote control that is provided with the projector is shown below.

Horizontal operating range

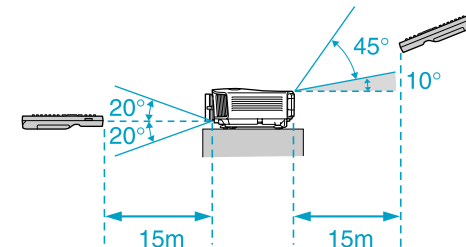

Vertical operating range



- To restrict reception of the operation signals from the remote control, set the **Remote Receiver** on the **Set** menu.  p.59
- When using a remote control provided with other Epson projectors, set the **Remote Control Type** on the **Extended** menu.  p.61
The operating range will depend on the remote control that you use.



Useful Functions

This chapter explains useful tips for giving presentations, and the security functions.

Displaying a Test Pattern

A test pattern can be displayed to adjust the projection status without connecting video equipment. This is useful when installing a projector.



If the [User] button on the remote control is set to **Test Pattern**, the test pattern will be displayed when the [User] button is pressed. (The default setting is Test Pattern.)

Procedure

- 1 Press the [Menu] button while the projector is projecting. Select Settings - "Test Pattern", then press the [Enter] button.

Using the Remote Control

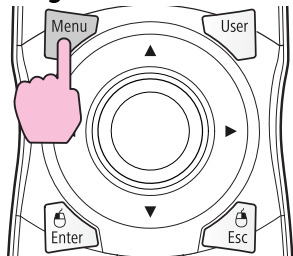

Using the Control panel

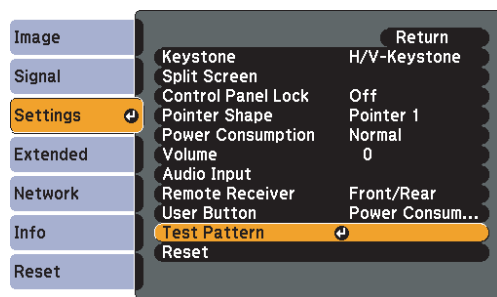
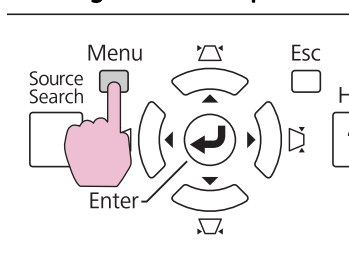

[Esc]:Return [◄]:Select [Enter]:Enter [Menu]:Exit

2

Press the [◄] button on the remote control in the [▶] direction or press the [Enter] button on the control panel to switch the test pattern.

To display the previous image, press the [◄] button on the remote control in the [◀] direction.

Using the Remote Control

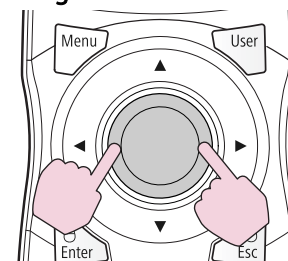

Using the Control panel

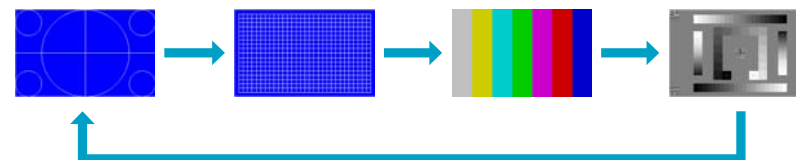
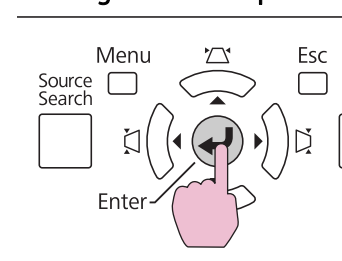

The following adjustments can be made while the test pattern is being displayed.

- Zoom and focus adjustment [Quick Start Guide](#)
- Projected image position adjustment [p.22](#)
- Projected image keystone correction [p.22](#)
- Selecting the projection quality (Selecting Color Mode) [p.33](#)
- Brightness adjustment Image menu - Brightness [p.55](#)
- Sharpness adjustment (Standard only) Image menu - Sharpness [p.55](#)
- Color temperature adjustment Image menu - Abs. Color Temp. [p.55](#)
- Color adjustment Image menu - Color Adjustment [p.55](#)



To set menu items that cannot be set while the test pattern is being displayed or to fine-tune the projected image, project an image from the connected device.

3

Press the [Esc] button to end the test pattern.

Adjusting the Position of the Projected Image (Lens Shift)

The lens can be shifted to adjust the position of the projected image, for example, when the projector cannot be installed directly in front of the screen.

Procedure

Turn the vertical lens shift dial or horizontal lens shift dial on the projector to adjust the location of the projected image.

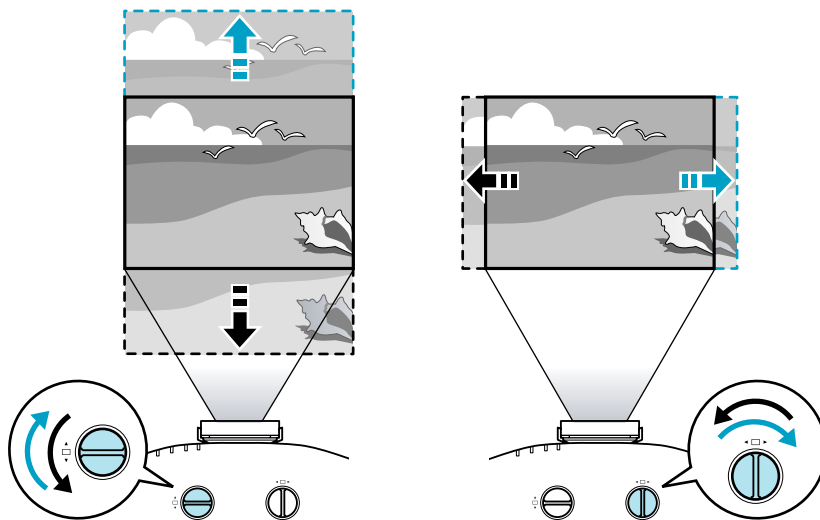

The image will be clearest when both the vertical and horizontal lens shift dials are set in the center.

The ranges within which the image can be moved using the lens shift dials are shown below.

EB-G5950/G5900/G5800/G5600/
G5500

EB-G5650W

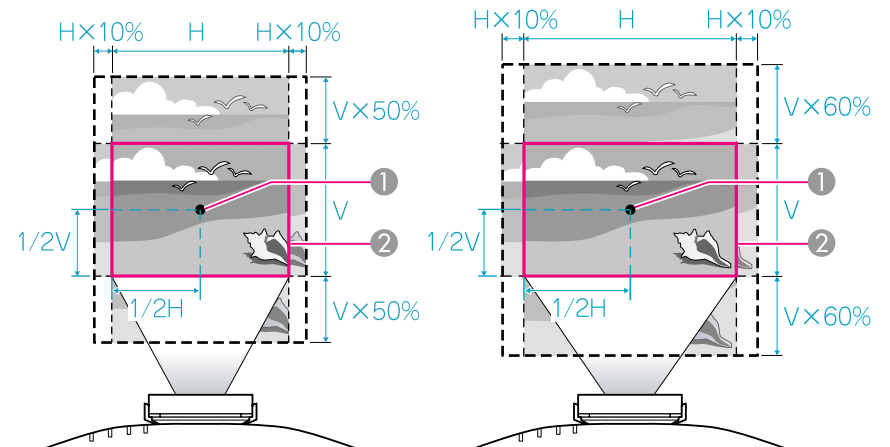

- ① Center of lens
- ② Projected image when lens shift dials are set in the center

Correcting Distortion in the Projected Image

There are two methods of correcting distortion in projected images as below.

- Quick Corner

This allows you to manually correct each of the four corners of the projected image separately. ➡ "Quick Corner" p.23
 We recommend using Quick Corner to accurately adjust keystone distortion.

- H/V-Keystone

This allows you to manually correct distortion in the horizontal and vertical directions independently. You can perform easy H/V-Keystone corrections by using the [↖/↗], [↘/↙], [↵/↶] and [↷/↸] buttons on the projector's control panel. ➡ "H/V-Keystone" p.25

Quick Corner and horizontal and vertical keystone cannot be performed at the same time. When the **Keystone** correction method is selected from the Configuration menu, the correction method you choose is assigned to the control panel [↖/↗], [↘/↙], [↵/↶] and [↷/↸] buttons. The default setting for **Keystone** is set to **H/V-Keystone**, so when [↖/↗], [↘/↙], [↵/↶] and [↷/↸] buttons are pressed, H/V-Keystone correction is carried out.

Because Quick Corner and H/V-Keystone correction can be carried out while projecting a test pattern, you do not need to make preparations by connecting a computer or other equipment.

Quick Corner

Procedure

1

Press the [Menu] button while the projector is projecting. Select Settings menu - "Keystone" and then press the [Enter] button. ➡ "Using the Configuration Menu" p.54

Using the Remote Control

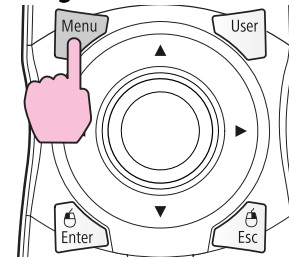

Using the Control panel

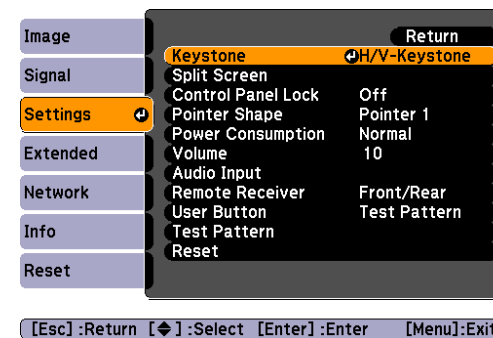
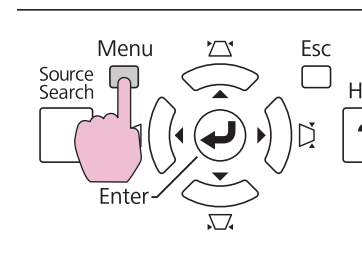

2

Select "Quick Corner", and then press the [Enter] button.

Press the [Enter] button again to display the selection screen from which you can select one of four corners.

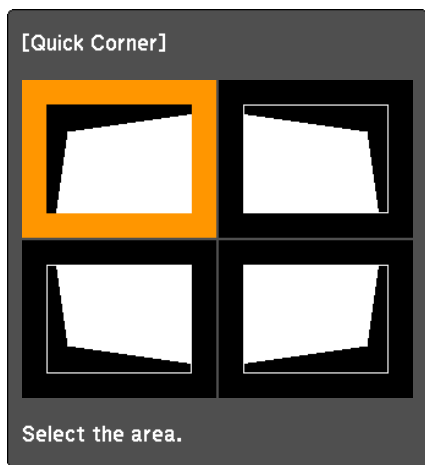

[◀ / ▶] : Select
 [Enter] : Enter
 [Esc] : Return (press for 2 seconds to reset/switch)

3 Use the [⊙] button on the remote control or the [↖/↗], [↘/↙], [↵/↶] and [↷/↸] buttons on the control panel to select the corner you want to adjust, and then press the [Enter] button.

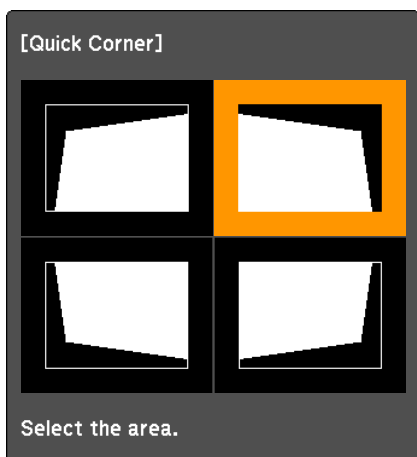

4 Correct the position of the corner using the [⊙] button on the remote control, or the [↖/↗], [↘/↙], [↵/↶] and [↷/↸] buttons on the control panel.

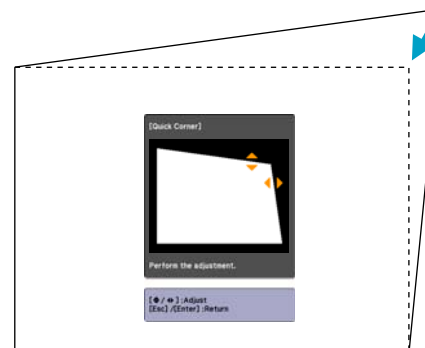

If the triangle in the direction you are adjusting the shape turns gray, as shown in the screenshot below, you cannot adjust the shape any further in that direction.

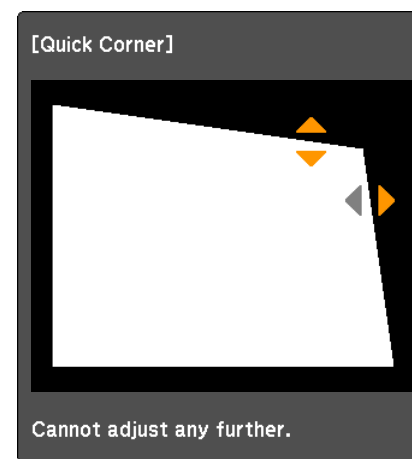

5 Repeat procedures 3 and 4 as needed to adjust any remaining corners.

6 When you are done, press the [Esc] button to exit the correction menu.

Because the correction method was changed to **Quick Corner** from **Keystone** in the configuration menu, when [↖/↗], [↘/↙], [↵/↔] and [↲/↳] buttons are pressed later, the screen for selecting the corner in procedure 2 is displayed. Change **Keystone** from the configuration menu to **H/V-Keystone** if you want to correct H/V-Keystone when pressing the [↖/↗], [↘/↙], [↵/↔] and [↲/↳] buttons on the control panel.  p.59



If the [Esc] button is held down for about two seconds while correcting with Quick Corner, the following screen is displayed.

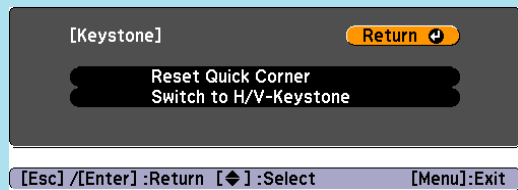

Reset Quick Corner: Resets the result of **Quick Corner** corrections.
Switch to H/V-Keystone: Switches the correction method to **H/V-Keystone**.  "H/V-Keystone" p.25



This adjustment can also be made from **H/V-Keystone** on the **Settings** menu.  p.59

• **Correcting vertical keystone**

Vertical keystone can be corrected to a vertical projector tilt of up to 40° against the screen. If you use the projector tilted at an angle of more than 30° it could be damaged and cause an accident.

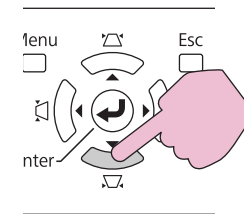
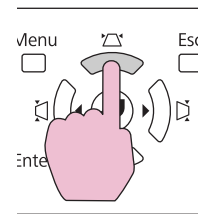
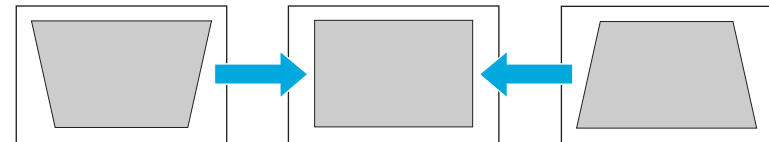

If the [↖/↗] and [↘/↙] buttons are pressed simultaneously for at least 1 second, the value of vertical keystone will return to the original status.

H/V-Keystone

Procedure

Press the [↖/↗], [↘/↙], [↵/↔] and [↲/↳] buttons on the control panel to adjust keystone settings in the horizontal and vertical directions independently.

- Correcting horizontal keystone
Horizontal keystone can be corrected to a horizontal projector tilt of up to 20°.

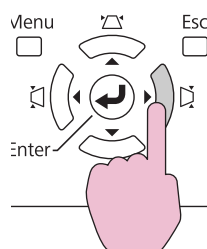
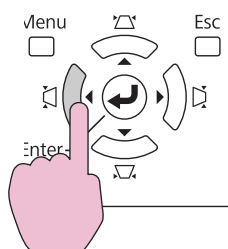
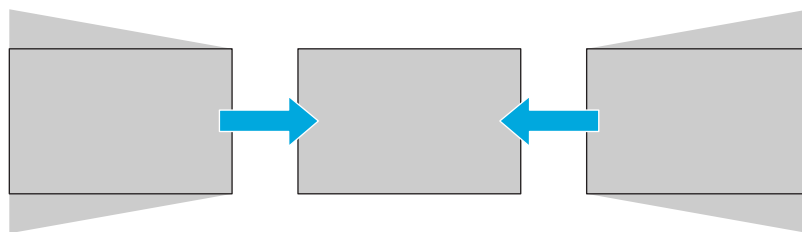
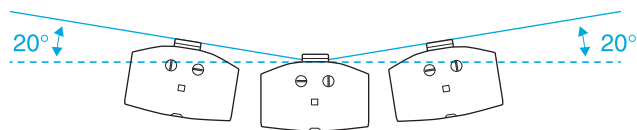

If the [←/→] and [↶/↷] buttons are pressed simultaneously for at least 1 second, the value of horizontal keystone will return to the original status.



Shift the lens to the position shown below when performing horizontal and vertical keystone. When the lens shift is not positioned as below, the distortion is not corrected accurately. ➡ "Adjusting the Position of the Projected Image (Lens Shift)" p.22

- The horizontal lens shift is set to the center.
- The vertical lens shift is set to the top or bottom.

The correction may not be properly performed according to the zoom adjustment value. And, the projected screen size may become smaller after performing the correction. Be careful about the projection distance when installing the projector.

Correct the image using Quick Corner to precisely align the projected image with the screen or to fine-tune the image. ➡ "Quick Corner" p.23

You can change the projected image in the following two ways.

- Changing by Source Search
The projector automatically detects signals being input from connected equipment, and the image being input from the input port is projected.
- Changing directly to the target image
You can use the remote control buttons to change to the target input port.

Automatically Detect Input Signal and Change the Projected Image (Source Search)

You can project the target images quickly by pressing the [Source Search] button because it will switch only to images from input ports to which image signals are being input.

Procedure

When your video equipment is connected, start playback before beginning this operation. When two or more pieces of equipment are connected, press the [Source Search] button until the target image is projected.

Using the Remote Control

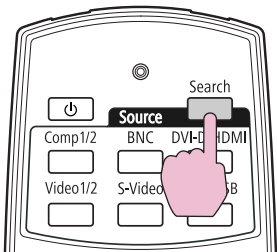

Using the Control panel

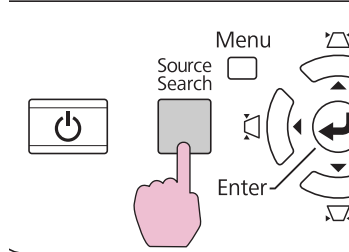

When the [Source Search] button is pressed, a search is made for input ports to which video signals are being input in the following order. (The input port where no image signal is being input is skipped.)

EB-G5950/G5650W

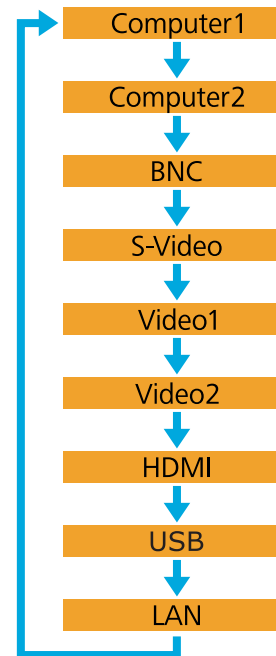

EB-G5900/G5600

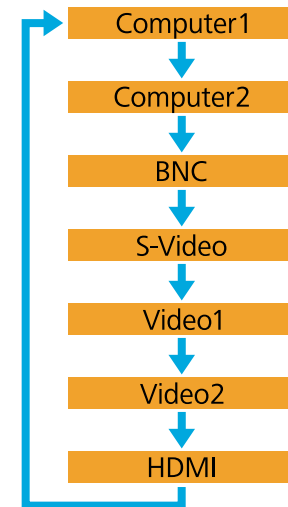

EB-G5800/G5500

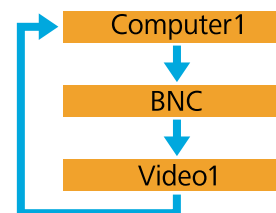

When switching to **LAN**, images from computers connected through the network are projected. (EB-G5950/G5650W only)



The following screen showing the status of image signals remains displayed when only the image that the projector is currently displaying is available, or when no image signal can be found. You can select the input port where the equipment you want to use is connected. If no operation is performed after about 10 seconds, the screen closes.

Example: EB-G5950/G5650W

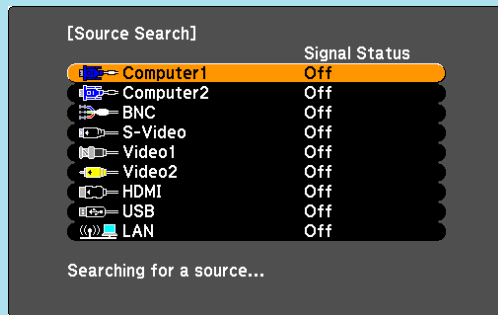

EB-G5950/G5900/G5650W/G5600

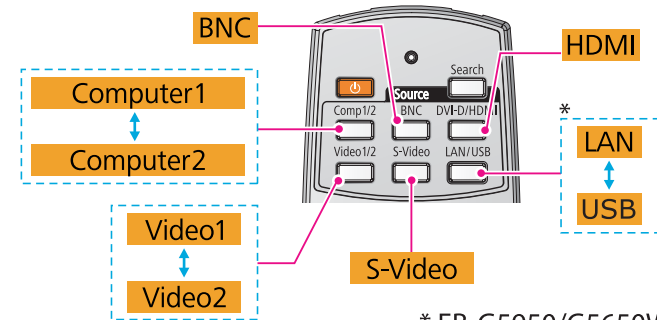

EB-G5800/G5500

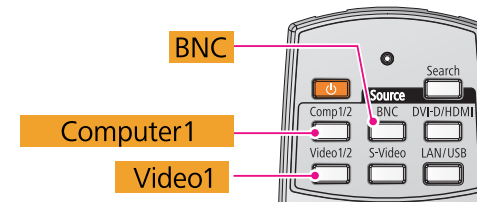

Switch to the Target Image by Remote Control

You can change directly to the image from the target input port by pressing the following buttons on the remote control. 🖱️ "Remote Control" [p.16](#)

When switching to **LAN**, images from computers connected through the network are projected. (EB-G5950/G5650W only)

You can select the aspect mode according to the type of input signal, ratio of height and width, and resolution to switch the Aspect Ratio of the projected image. The aspect modes are listed below. The aspect modes that can be set depend on the type of image that is being projected.

EB-G5950/G5900/G5800/G5600/G5500

Aspect mode	Explanation
Normal	Projects to the full projection size retaining the aspect ratio of the input image.
Auto	Projects in an appropriate aspect ratio based on information from the signal being input.
4:3	Projects to the full projection size at an Aspect of 4:3. This is ideal for when you want to project images at an aspect of 5:4 (1280 x 1024) to the full projection size.
16:9	Projects at a 16:9 aspect ratio. This is ideal for projecting at full screen size when using a 16:9 screen.
Native	Projects at the resolution of the input image size to the center of the screen. This is ideal for projecting clear images. If the image resolution exceeds the panel resolution (1024 x 768) of the projector, the edges of the image are not projected.

EB-G5650W

Aspect mode	Explanation
Normal	Projects to the full projection size retaining the aspect ratio of the input image.
Auto	Projects in an appropriate aspect ratio based on information from the signal being input.
16:9	Projects to the full projection size at an aspect ratio of 16:9.
Full	Project at full size.

Aspect mode	Explanation
Zoom	Projects the input image enlarged to the full lateral direction size as the aspect ratio remains. Parts that extend beyond the projection size are not projected.
Native	Projects at the resolution of the input image size to the center of the screen. This is ideal for projecting clear images. If the image resolution exceeds the panel resolution (1200 x 800) of the projector, the edges of the image are not projected.

Procedure

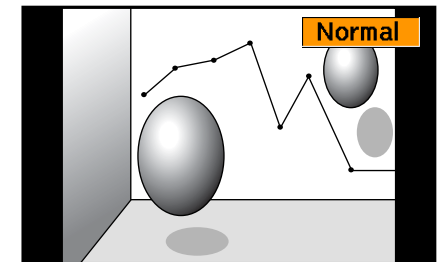
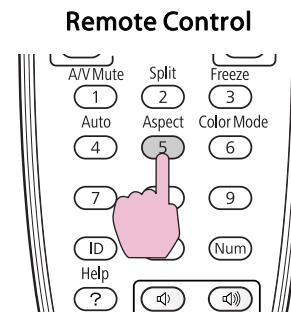

The aspect mode name is displayed on the screen by pressing the button. If you press the button while the aspect mode name is displayed on the screen, it changes to the next aspect mode.



The aspect mode can also be set using **Aspect** in the **Signal** menu from the configuration menu.  [p.57](#)

Changing the Aspect Mode (EB-G5950/G5900/G5800/G5600/G5500)

Projecting images from video equipment

Each time the [Aspect] button on the remote control is pressed, the aspect mode changes in the order **Auto**, **4:3** and **16:9**. p.29

When inputting a 720p/1080i signal and the aspect mode is set to **4:3**, a 4:3 zoom will be applied (the right and left sides of the image will be cut off).

Example: 720p signal input (resolution: 1280x720, aspect ratio: 16:9)

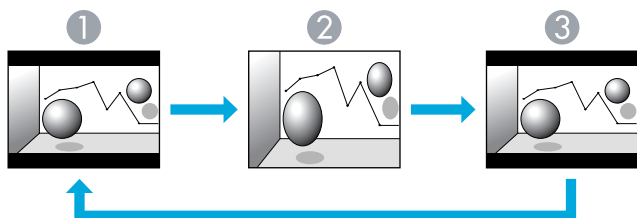

- ① Auto
- ② 4:3
- ③ 16:9

Projecting images from the HDMI input port (EB-G5950/G5900/G5600 only)

Each time the [Aspect] button on the remote control is pressed, the aspect mode changes in the order **Auto**, **4:3**, **16:9**, and **Native**. p.29

Example: 1080p signal input (resolution: 1920x1080, aspect ratio: 16:9)

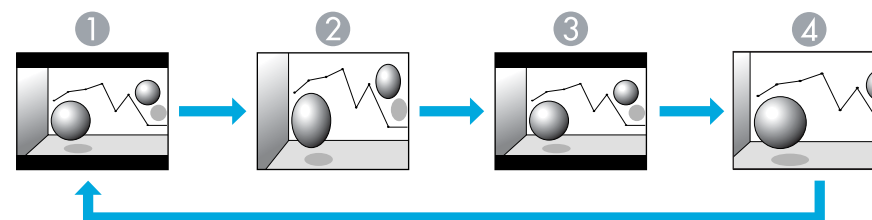

- ① Auto
- ② 4:3
- ③ 16:9
- ④ Native

Projecting images from a computer

Each time the [Aspect] button on the remote control is pressed, the aspect mode changes in the order **Normal**, **4:3**, **16:9**, and **Native**. p.29

Projection examples for each aspect mode are shown below.

Aspect mode	Input Signal		
	XGA 1024X768(4:3)	WXGA 1280X800(16:10)	SXGA 1280X1024(5:4)
Normal			
4:3			

Aspect mode	Input Signal		
	XGA 1024X768(4:3)	WXGA 1280X800(16:10)	SXGA 1280X1024(5:4)
16:9			
Native			

If parts of the image are missing or it cannot project everything, set **Wide** or **Normal** in **Resolution** from the configuration menu depending on the size of the computer panel. [p.57](#)

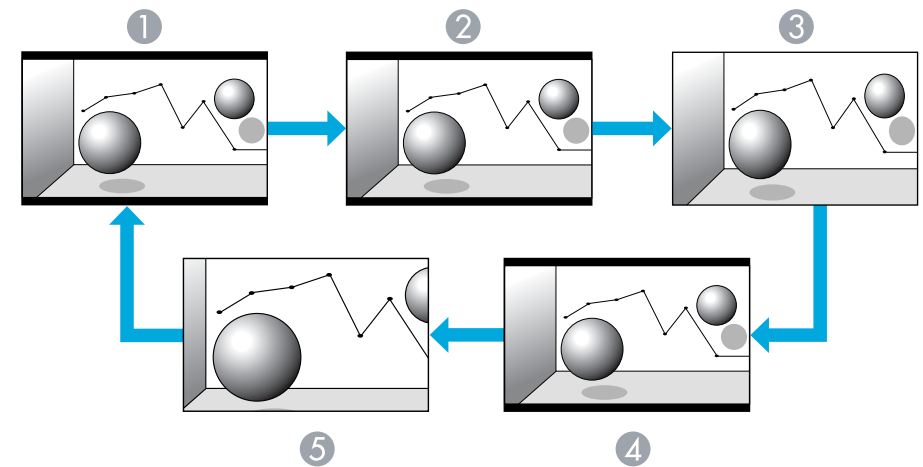

- ① Auto
- ② 16:9
- ③ Full
- ④ Zoom
- ⑤ Native

Changing the Aspect Mode (EB-G5650W)

Projecting images from video equipment or from the HDMI input port

Each time the [Aspect] button on the remote control is pressed, the aspect mode changes in the order **Auto**, **16:9**, **Full**, **Zoom**, and **Native**.

[p.29](#)

Example: 1080p signal input (resolution: 1920x1080, aspect ratio: 16:9)

Projecting images from a computer

Each time the [Aspect] button on the remote control is pressed, the aspect mode changes in the order **Normal**, **16:9**, **Full**, **Zoom**, and **Native**.

[p.29](#)

Projection examples for each aspect mode are shown below.

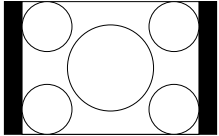
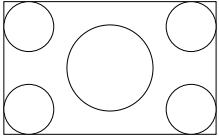
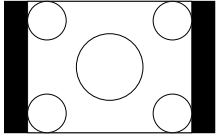
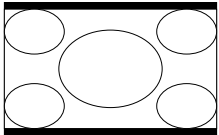
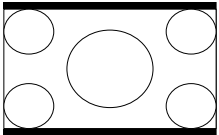
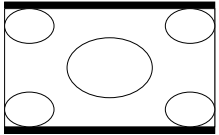
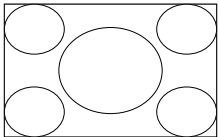
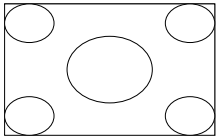
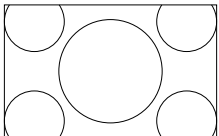
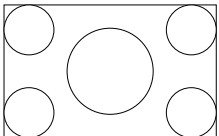
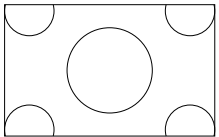
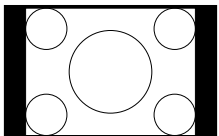
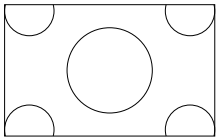
Aspect mode	Input Signal		
	XGA 1024X768(4:3)	WXGA 1280X800(16:10)	SXGA 1280X1024(5:4)
Normal			
16:9			
Full			
Zoom			
Native			



If parts of the image are missing or it cannot project everything, set **Wide** or **Normal** in **Resolution** from the configuration menu depending on the size of the computer panel.  [p.57](#)

You can easily obtain the optimum image quality simply by selecting the setting that best corresponds to your surroundings when projecting. The brightness of the image varies depending on the mode selected.

Mode	Application
Dynamic	Ideal for use in a bright room. This is the brightest mode.
Presentation	Ideal for making presentations using color materials in a bright room.
Theatre	Ideal for watching films in a dark room. Gives images a natural tone almost like an original source.
Photo*1	Ideal for projecting still pictures, such as photos, in a bright room. The images are vivid and brought into contrast.
Sports*2	Ideal for watching TV programmes in a bright room. The images are vivid and brought to life.
sRGB	Ideal for images that conform to the <u>sRGB</u> color standard.
Customized	Select Customized to adjust R,G,B,C,M,Y from Color Adjustment in the configuration menu.
DICOM SIM*1	Ideal for projecting X-ray photographs and other medical images. This produces images with clear shadows. The projector is not a medical device and cannot be used for medical diagnosis.

*1 This can be selected when inputting RGB signals. When using EB-G5950/G5650W, this can be selected when inputting RGB signals, or when USB or LAN is selected as the input source.

*2 This can be selected when inputting component video signals, S-video signals, or composite video signals.

Procedure

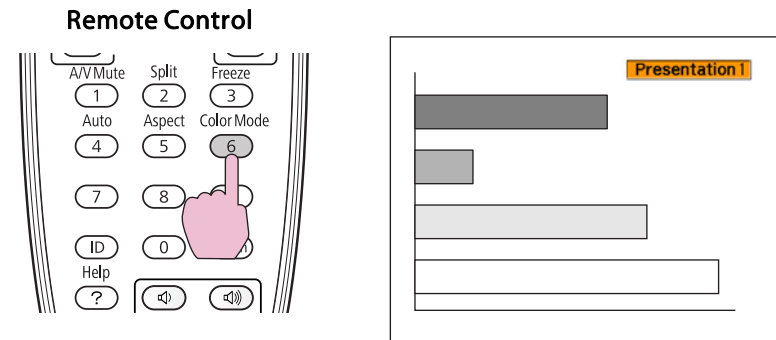

The Color Mode name is displayed on the screen by pressing the button. If you press the button while the Color Mode name is displayed on the screen, it changes to the next Color Mode.



The color mode can also be set using **Color Mode** in the **Image** menu from the configuration menu. [p.55](#)

A split screen can be used to divide the screen into a left screen (A) and a right screen (B) and simultaneously project two images.

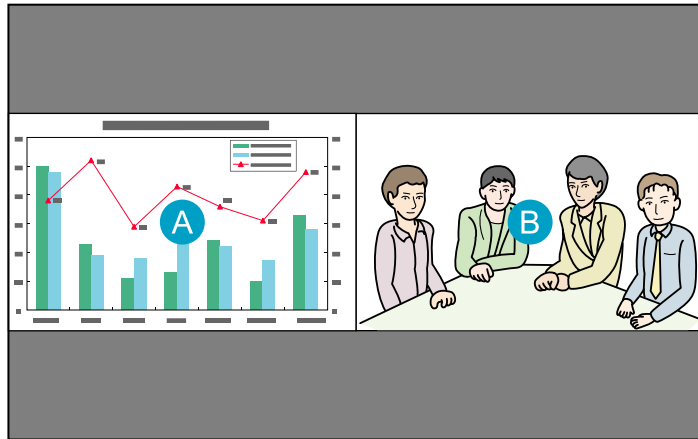

Input Sources for Split Screen Projection

The combinations of input sources that can be projected on a split screen are listed below. The image from the HDMI input port must be displayed on either the left or right screen.

Images from computers connected through the network or images from the USB(TypeA) port cannot be projected. (EB-G5950/G5650W)

Left or right screen	Other screen
HDMI	Computer1 Computer2 BNC S-Video Video1 Video2

Operating Procedures

Projecting on a split screen

Procedure

- 1 Press the [Split] button on the remote control while the projector is projecting.

The currently selected input source will be displayed on the left screen.

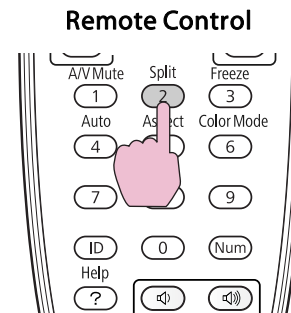

The split screen can also be started from **Split Screen** on the Configuration menu. [p.59](#)

- 2 Press the [Menu] button on the remote control or the control panel.

The **Split Screen Setup** will be displayed.

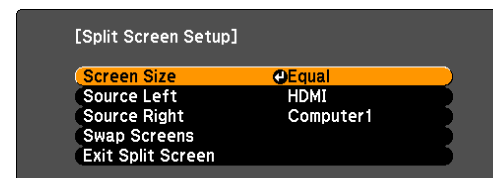

[↵]:Select [Enter]:Enter [Menu]:Exit



The **Split Screen Setup** will also be displayed when the [Source Search] button is pressed on the remote control or control panel or when a Source button is pressed on the remote control.

3

To switch the image projected on the left screen, select "Source Left" and press the [Enter] button. To switch the image projected on right screen, select "Source Right" and press the [Enter] button.

4

Select the input source to project and press the [Enter] button.

Only the input sources that can be combined can be selected.

☛ "Input Sources for Split Screen Projection" p.34

To switch the projected image during split screen projection, start the procedure from step 2.



- The audio from the input source that is selected for the left screen will be output.
- If **Computer1**, **Computer2**, or **BNC** is selected for the left screen, the image for the left screen can be displayed on an external monitor. (This is possible only when RGB signals are input.)
☛ p.139

Switching the left and right screens

Use the following procedure to switch the images displayed on the left and right screens.

Procedure

1

Press the [Menu] button on the remote control or the control panel during split screen projection.

2

Select "Swap Screens" and then press the [Enter] button.

The images on the left and right screens will be swapped.

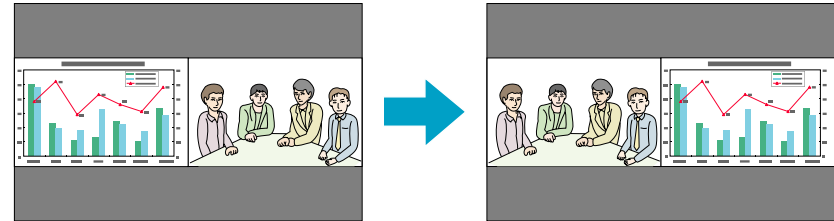

Switching the left and right image sizes

Procedure

1

Press the [Menu] button on the remote control or the control panel during split screen projection.

2

Select "Screen Size" and then press the [Enter] button.

3

Select the image size to display and then press the [Enter] button.

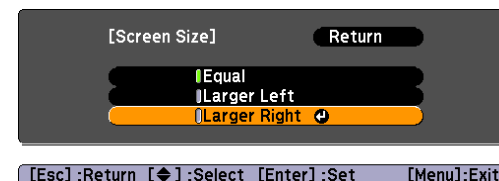

4

Press the [Menu] button to end the setting procedure.

The projected images will appear as shown below after setting the screen size.

Equal



Larger Left

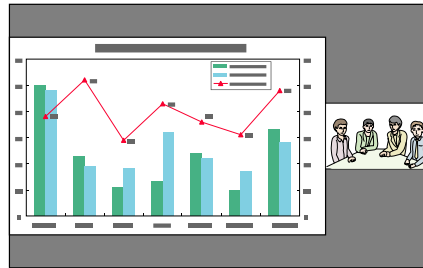

Larger Right

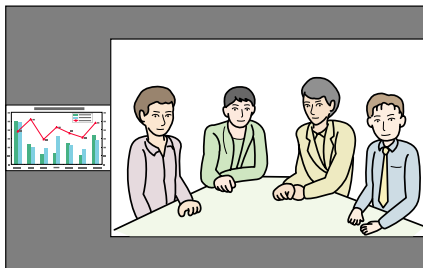

- You cannot enlarge both the left screen and right screen images at the same time.
- When one image is enlarged, the other image is reduced.
- Depending on the video signals that are input, the images on the left and right may not appear to be the same size even if **Equal** is set.

Ending the split screen

Procedure

To end the split screen, press the [Esc] button on the remote control or control panel.

The following steps can also be used to end the split screen.

- Press the [Split] button on the remote control.
- Select **Exit Split Screen** in the **Split Screen Setup** and then press the [Enter] button.

Restrictions during Split Screen Projection

Operating restrictions

The following operations cannot be performed during split screen projection.

- Setting the Configuration Menu
- E-zoom
- Switching the aspect mode (The aspect mode will be set to **Normal**.)
☞ [p.29](#)
- Operations using the [User] button on the remote control

Help can be displayed only when image signals are not input or when an error or warning notification is displayed.



Restriction relating to images

- The default values for the **Image** menu are applied to the image on the right screen. However, the settings for the image projected on the left screen are applied to the image on the right screen for the **Color Mode**, **Abs. Color Temp.**, and **Color Adjustment**. Also, the **Advanced** settings for **Sharpness** are set to **Off** for the images on both screens.
☛ [p.55](#)
- The settings for **Progressive** and **Noise Reduction** are set to **Off**.
☛ Signal menu - Progressive and Noise Reduction [p.57](#)
- The default setting for the **Overscan** is applied. ☛ Signal menu - Overscan [p.57](#)
- The display screen will be **Blue** when there is no image signal input.
- When the A/V Mute operation is performed, the display screen will be **Black**.

Hiding the Image and Sound Temporarily (A/V Mute)

You can use this when you want to focus the audience's attention on what you are saying, or if you do not want to show details such as when you are changing between files during presentations from a computer.

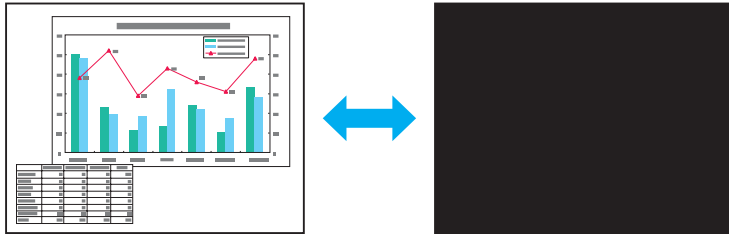

Procedure

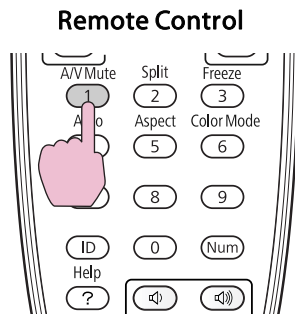

Each time you press the button, A/V Mute turns on or off.



- If you use this function when projecting moving images, the images and sound continue to be played back by the source, and you cannot return to the point where A/V Mute was activated.
- You can set the A/V Mute display status to **Black**, **Blue**, or **Logo** from **Extended** menu - **A/V Mute**.  p.61
- The lamp is still lit during A/V Mute, so the lamp time continues to accumulate.

Freezing the Image (Freeze)

When the freeze function is activated on moving images, the frozen image continues to be projected on the screen, so you can project a moving image one frame at a time like a still photo. Also, you can perform operations such as changing between files during presentations from a computer without projecting any images if the freeze function is activated beforehand.

Procedure

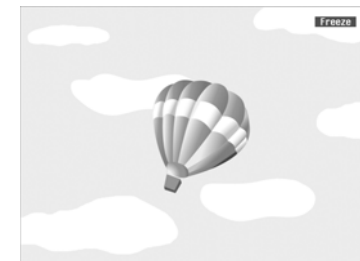
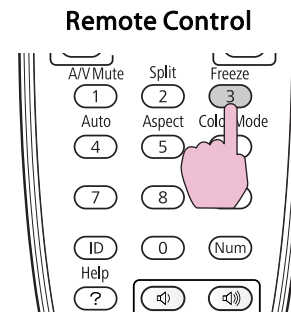

Each time you press the button, Freeze turns on or off.



- Audio does not stop.
- The image source continues to play back the moving images even while Freeze is on, and so it is not possible to resume projection from the point where it was paused.
- If the [Freeze] button is pressed while the configuration menu or a Help screen is displayed, the menu or Help screen being displayed is cleared.
- Freeze still works while E-Zoom is being used.

Pointer Function (Pointer)

This allows you to move a Pointer icon on the projected image, and helps you draw attention to the area you are talking about.

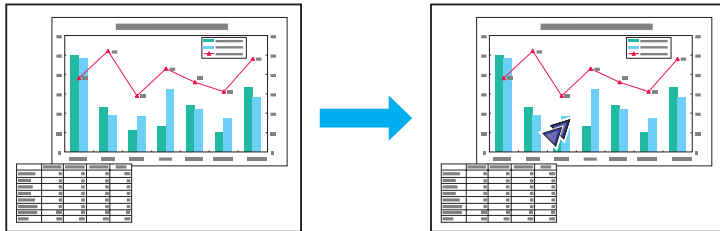

Procedure

1

Display the Pointer.

Remote Control

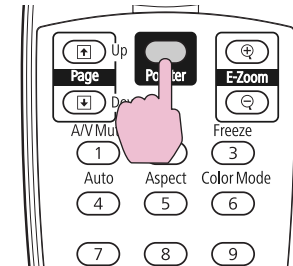

Each time you press the button, the pointer appears or disappears.

2 Move the Pointer icon (↖↗).

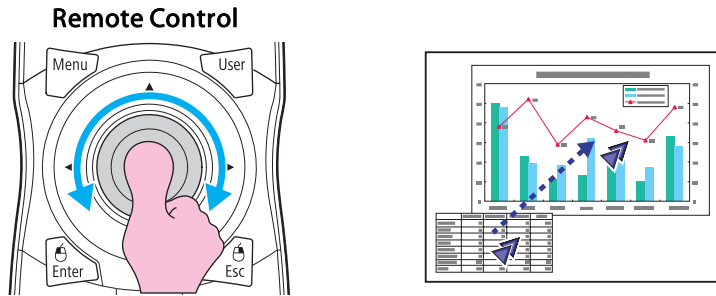

You can choose from three different kinds of Pointer icon (↖↗, ✕, or ↘) in **Settings - Pointer Shape** from the configuration menu.
 🖱️ p.59

Procedure

1 Start E-Zoom.

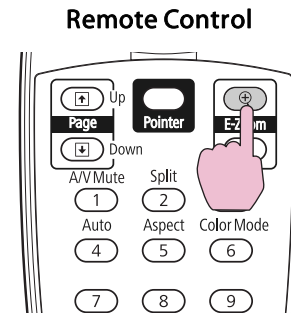

2 Move the (⊞) to the area of the image that you want to enlarge.

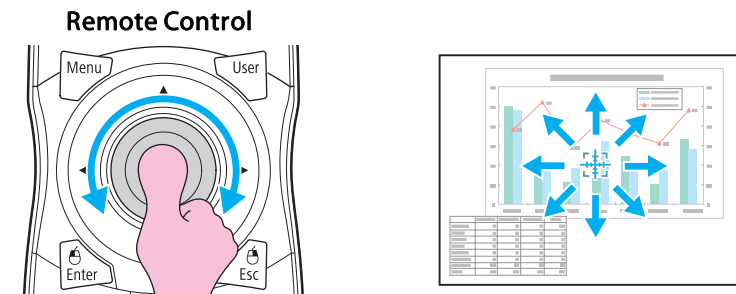

Enlarging Part of the Image (E-Zoom)

This is useful when you want to expand images to see them in greater detail, such as graphs and tables.

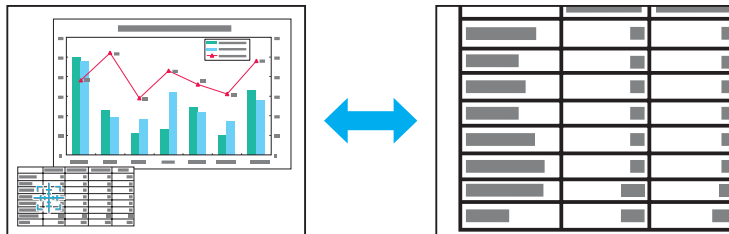

3 Enlarge.

Remote Control

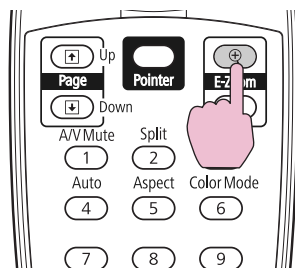

Each time the button is pressed, the area is expanded. You can expand quickly by holding the button down.

You can reduce the enlarged image by pressing the [⊖] button.

Press the [Esc] button to cancel.



- The enlargement ratio appears on the screen. The selected area can be enlarged to between 1 to 4 times in 25 incremental steps.
- After the image is enlarged, it can be scrolled with the [⊙] button.
- If E-Zoom is selected, Progressive and Noise Reduction are cancelled.
- E-Zoom is canceled when performing some functions such as Keystone or Auto Setup.

When an ID is set for the projector and the remote control, you can use the remote control to operate only the projector with a matching ID. This is very useful when managing multiple projectors.

When operating all of the projectors from the remote control, set the ID switch on the side of the remote control to Off.



- Operation using the remote control is possible only for projectors that are within the operating range of the remote control.
 - ☛ "Operating range of remote control" p.19
- When **Remote Control Type** is set to **Simple** from **Operation** in the configuration menu, you cannot set the remote control ID. p.61
- IDs are ignored when the projector ID is set to **Off** or the remote control ID is set to **0**.

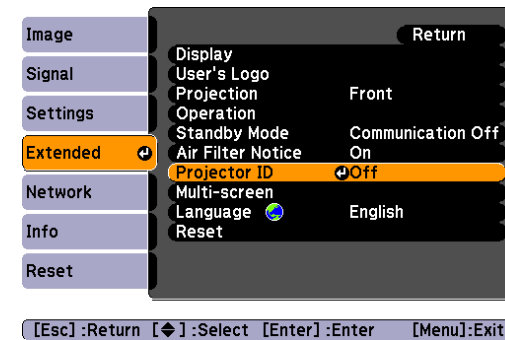

2

Select of one of the numbers from 1 to 9 to use as the ID and then press the [Enter] button.

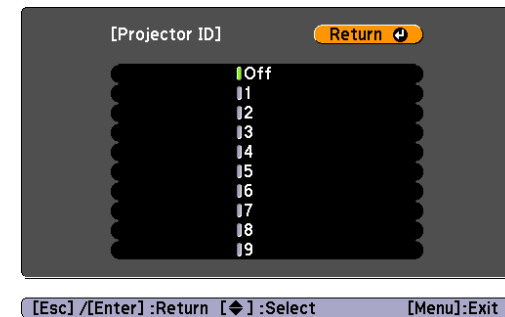

3

Press the [Menu] button to close the configuration menu.

Setting the Projector ID

Procedure

- 1 During projection, press the [Menu] button and select Extended - "Projector ID" from the configuration menu.
 - ☛ "Using the Configuration Menu" p.54

Using the Remote Control

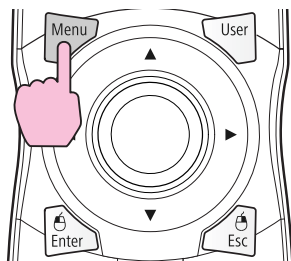

Using the Control panel

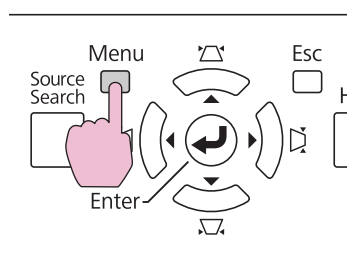

Checking the Projector ID

Use the following procedure to check the projector ID.

Procedure

- 1 Set the remote control ID switch to On.

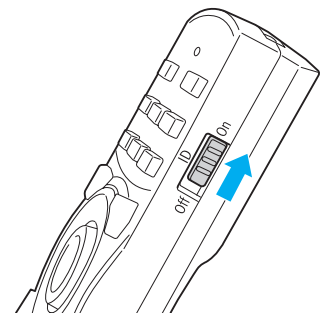

- 2 During projection, while holding the [ID] button, press the [Help] button.

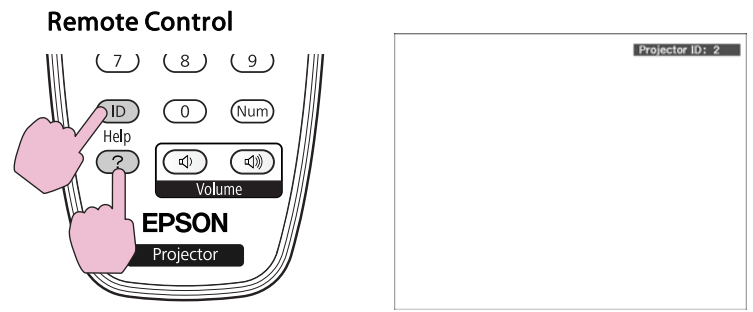

When you press the buttons, the current Projector ID is displayed on the projection screen. It disappears in about three seconds.

Setting the Remote Control ID

Procedure

- 1 Set the remote control ID switch to On.

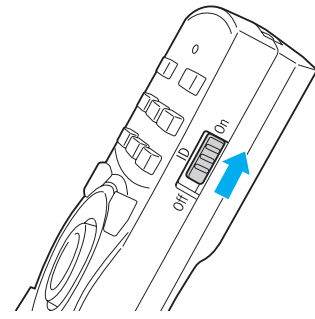

- 2 While holding the [ID] button, press a number button to select a number to match the ID of the projector you want to operate. ➡ "Checking the Projector ID" p.42

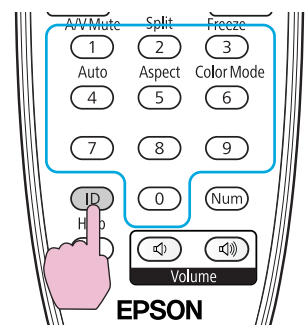

Once this setting has been made, the projector that can be operated by the remote control is limited.



The remote control ID setting is saved in the remote control. Even if the remote control batteries are removed to replace them and so on, the stored ID setting is retained. However, if the batteries are left out for a long time, it is reset to the default value (ID0).

When multiple projectors are lined up and projecting images, you can manually correct the brightness and color tone of each projector's image so that the colors projected from each projector match closely.

Use the multi-screen color adjustment function when the Color Mode of each projector is set to the same item.

In some cases the brightness and color tone may not match completely even after correction.

Summary of Correction Procedure

When multiple projectors are set up and you need to make corrections, use the following procedure to correct one projector at a time.

1. Set the projector ID and the remote control ID.
To limit operation to one target projector, set a Projector ID for the target projector, and set the same ID for the remote control. [p.42](#)
2. Correct the color difference.
You can carry out color correction when projecting from multiple projectors. You can adjust from black to white in five stages called levels 1 to 5, and in each of these 5 levels you can adjust the following two points.
 - Correcting brightness
You can correct the image brightness to make them all equal.
 - Correcting color
You can adjust the image color to make them match more closely by using **Color Correct. (G/R)** and **Color Correct. (B/Y)**.

Correction Method

After setting up the projectors, correct the brightness and tone for each projector to reduce the differences.

Procedure

- 1 Press the [Menu] button and select Extended - "Multi-screen" from the configuration menu. ["Using the Configuration Menu" p.54](#)

Using the Remote Control

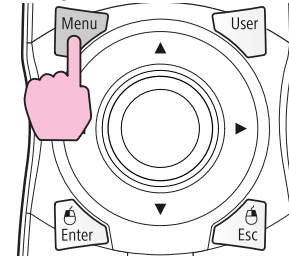

Using the Control panel

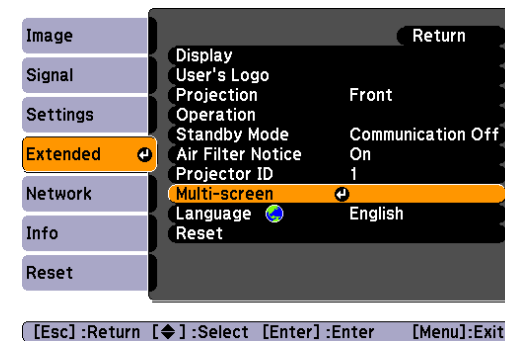
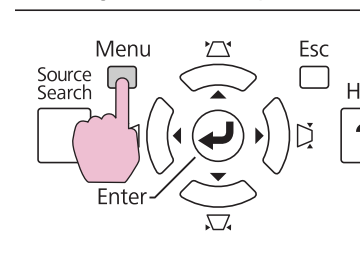

- 2 Select "Lv." to be corrected in Adjustment Level.

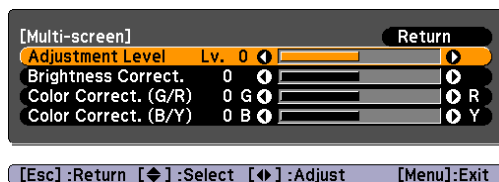

- Each time a level is selected, the pattern of the level selected is displayed.
- You can start correcting from any level, usually you can make it darker or lighter by correcting 1 to 5 or 5 to 1.

3 Correct the brightness with "Brightness Correct."

- When you select Lv. 5, all the images are adjusted to the darkest image from multiple projectors.
- When you select Lv. 1, all the images are adjusted to the brightest image from multiple projectors.
- When you select Lv. 2 to 4, all the images are adjusted to the mid-range brightness image from multiple projectors.
- Because each time the [Enter] button is pressed the image displayed changes between the pattern display and the actual image, you can check the correction results and make corrections in the actual image.

4 Correcting "Color Correct. (G/R)" and "Color Correct. (B/Y)".

Because each time the [Enter] button is pressed the image displayed changes between the pattern display and the actual image, you can check the correction results and make corrections in the actual image.

5 Repeat procedures 3 to 5 until corrections are finished.

6 When all corrections are finished, press the [Menu] button to close the configuration menu.

You can save the image that is currently being projected as a User's Logo. The saved user's logo can be used as the display image when there is no video signal input or during the A/V Mute operation.

 Once a User's Logo has been saved, the logo cannot be returned to the factory default.

Procedure

1 Project the image you want to use as the user's logo, and then press the [Menu] button.

Using the Remote Control

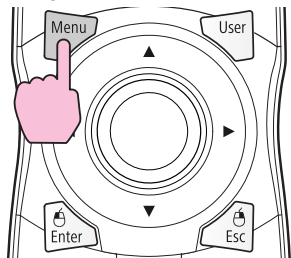

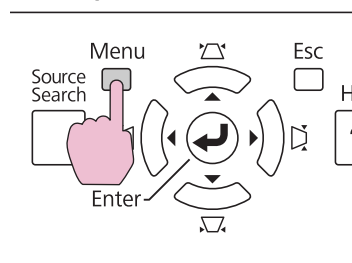

Using the Control panel

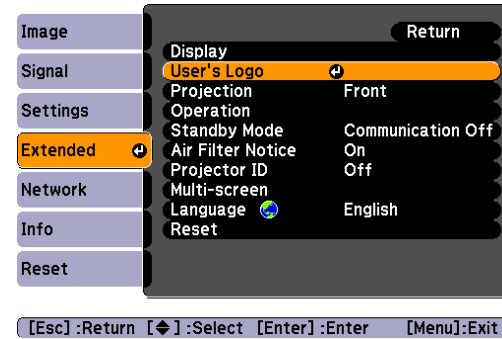

2 Select Extended - "User's Logo" from the configuration menu.  "Using the Configuration Menu" p.54

Check the buttons you can use and the operations they perform in the guide under the menu.



 • If User's Logo Protect from Password Protect is set to On, a message is displayed and the user's logo cannot be changed. You can make changes after setting User's Logo Protect to Off.  p.49

• If User's Logo is selected when Keystone, E-Zoom, Aspect, or Progressive are being performed, the function currently being performed is cancelled.

3 When "Choose this image as the User's Logo?" is displayed, select "Yes".

 When you press the [Enter] button on the remote control or the control panel, the screen size may change according to the signal as it changes to the resolution of the image signal.

- 4 Move the box to select the part of the image to use as the User's Logo.

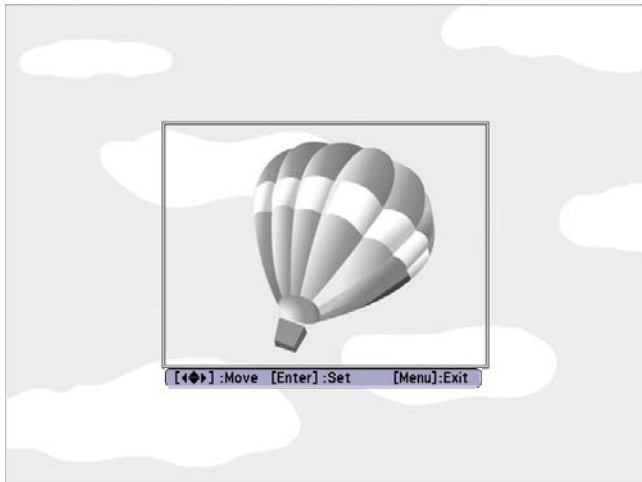

Using the Remote Control

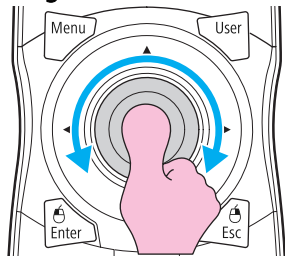

Using the Control panel

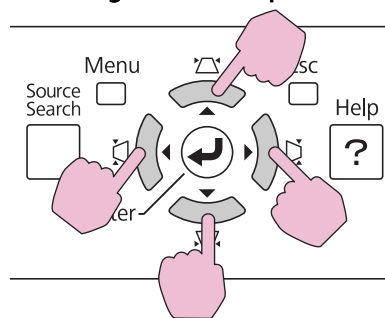

You can save at up to 400 × 300 dots in size.

- 5 When "Select this image?" is displayed, select "Yes".
- 6 Select the zoom factor from the zoom setting screen.

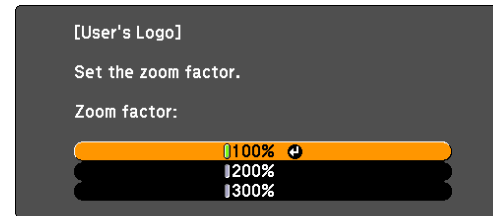

[Esc]:Return [Down Arrow]:Select [Enter]:Set [Menu]:Exit



- 7 When the message "Save this image as the User's Logo?" is displayed, select "Yes".

The image is saved. After the image has been saved, the message "Completed." is displayed.



- To use the saved user's logo as the screen image, set it in the **Display** settings under the **Extended** menu. [p.61](#)
- When a User's Logo is saved, the previous User's Logo is erased.
- Saving the user's logo may take approximately 15 seconds. Do not use the projector or any connected equipment while it is saving, otherwise malfunctions may occur.

The projector has the following enhanced security functions.

- **Password Protect**
You can limit who can use the projector.
- **Control Panel Lock**
You can prevent people changing the settings on the projector without permission.  [p.51](#)
- **Anti-Theft Lock**
The projector is equipped with various types of anti-theft security devices.  [p.52](#)

2. User's Logo Protect

Even if someone tries to change the User's Logo set by the owner of the projector, it cannot be changed. When **User's Logo Protect** is set to **On**, the following setting changes for the User's Logo are prohibited.

- Capturing a User's Logo
- Settings for **Display Background**, **Startup Screen**, and **A/V Mute** from **Display** in the configuration menu

3. Network Protect

When **Network Protect** is set to **On**, setting changes for **Network** menu in the configuration menu are prohibited.

Managing Users (Password Protect)

When Password Protect is activated, people who do not know the Password cannot use the projector to project images even if the projector power is on. Furthermore, the user's logo that is displayed when you turn on the projector cannot be changed. This acts as an anti-theft device as the projector cannot be used even if it is stolen. At the time of purchase, Password Protect is not activated.

Type of Password Protect

The following three kinds of Password Protect settings can be made according to how the projector is being used.

1. Power On Protect

When **Power On Protect** is **On**, you need to enter a preset Password after the projector is plugged in and turned on (this also applies to Direct Power On). If the correct Password is not entered, projection does not start.

Setting Password Protect

Use the following procedure to set Password Protect.

Procedure



During projection, hold down the [Freeze] button for about five seconds.

The Password Protect setting menu is displayed.

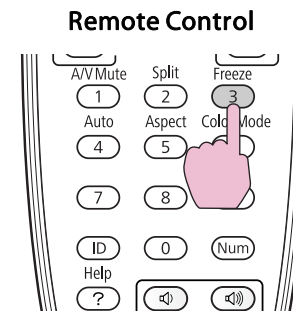



- If Password Protect is already activated, you must enter the Password.
If the Password is entered correctly, the Password Protect setting menu is displayed. ➡ "Entering the Password" p.50
- When the Password is set, stick the Password protect sticker in a visible position on the projector as a further theft deterrent.

2 Turn on "Power On Protect".

- (1) Select **Power On Protect**, and then press the [Enter] button.
- (2) Select **On**, and then press the [Enter] button.
- (3) Press the [Esc] button.

3 Turn on "User's Logo Protect".

- (1) Select **User's Logo Protect**, and then press the [Enter] button.
- (2) Select **On**, and then press the [Enter] button.
- (3) Press the [Esc] button.

4 Turn on "Network Protect".

- (1) Select **Network Protect**, and then press the [Enter] button.
- (2) Select **On**, and then press the [Enter] button.
- (3) Press the [Esc] button.

5 Set the Password.

- (1) Select **Password**, and then press the [Enter] button.
- (2) The message "Change the password?" is displayed, select **Yes** and then press the [Enter] button. The default setting for the Password is "0000". Change this to your own desired password. If you select **No**, the screen shown in step 1 is displayed again.
- (3) While holding down the [Num] button, enter a four digit number using the numeric buttons. The number entered is displayed as "* * * *". When you enter the fourth digit, the confirmation screen is displayed.

Remote Control

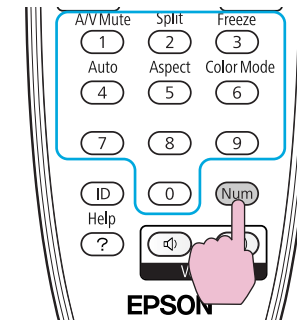

- (4) Re-enter the Password.
The message "Password accepted." is displayed.
If you enter the Password incorrectly, a message is displayed prompting you to re-enter the password.

Entering the Password

When the Password entry screen is displayed, enter the Password using the numeric buttons on the remote control.

Procedure

While holding down the [Num] button, enter the Password by pressing the numeric buttons.

When you enter the correct Password, projection begins.

Attention

- If an incorrect password is entered three times in succession, the message "The projector's operation will be locked." is displayed for about five minutes, and then the projector switches to standby mode. If this happens, disconnect the power plug from the electrical outlet and then reinsert it and turn the projector's power back on. The projector displays the Password entry screen again so that you can enter the correct Password.
- If you have forgotten the password, make a note of the "Request Code: xxxxx" number that appears on the screen and contact the nearest address provided in the Support and Service Guide. [Epson Projector Contact List](#)
- If you continue to repeat the above operation and input the wrong Password thirty times in succession, the following message is displayed and the projector does not accept any more Password entries. "The projector's operation will be locked." Contact Epson as described in your documentation. [Epson Projector Contact List](#)

Restricting Operation (Control Panel Lock)

Perform one of the following to lock the operation buttons on the control panel. Even if the control panel is locked, you can still use the remote control as usual.

- **Full Lock**
All of the buttons on the control panel are locked. You cannot perform any operations from the control panel, including turning the power on or off.
- **Partial Lock**
All of the buttons on the control panel, except for the [⏻] button, are locked.

1

During projection, press the [Menu] button and select Settings - Control Panel Lock from the configuration menu. ["Using the Configuration Menu" p.54](#)

Using the Remote Control

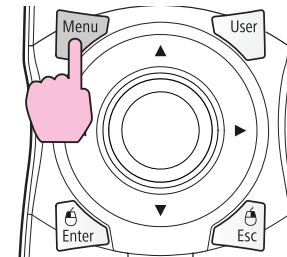

Using the Control panel

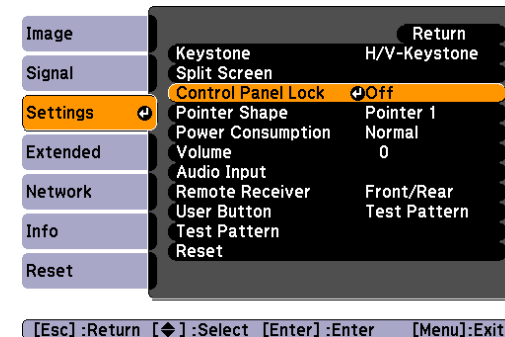
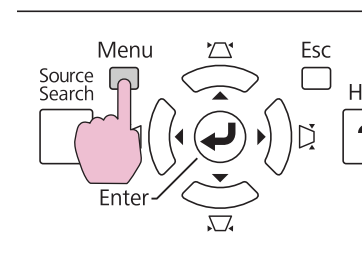

2

Select either **Full Lock** or **Partial Lock** according to your purpose.

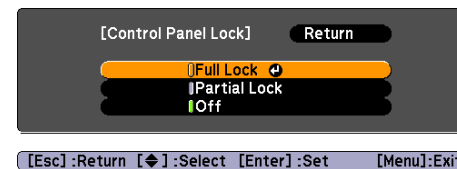

3

Select **Yes** when the confirmation message is displayed.

The control panel buttons are locked according to the setting you chose.



You can release the control panel lock by one of the following two methods.

- From the remote control, select **Off** in **Settings - Control Panel Lock** from the configuration menu.  [p.59](#)
- Hold down the [Enter] button on the Control panel for about seven seconds, a message is displayed and the lock is released.

Anti-Theft Lock

As the projector is often setup on ceiling mounts and left in rooms unattended, the projector includes the following security devices to prevent someone from taking the projector.

- Security slot
The Security slot is compatible with the Microsaver Security System manufactured by Kensington. You can find details about the Microsaver Security System on the Kensington homepage <http://www.kensington.com/>.
- Security cable installation point
A commercially available anti-theft wire lock can be passed through the security cable installation point to secure the projector to a desk or pillar.
- Screw to fix the lens unit removal button
The lens removal button can be locked with the screw supplied so that the projection lens cannot be removed immediately.

Installing the wire lock

Pass an anti-theft wire lock through the security cable installation point. See the documentation supplied with the wire lock for locking instructions.

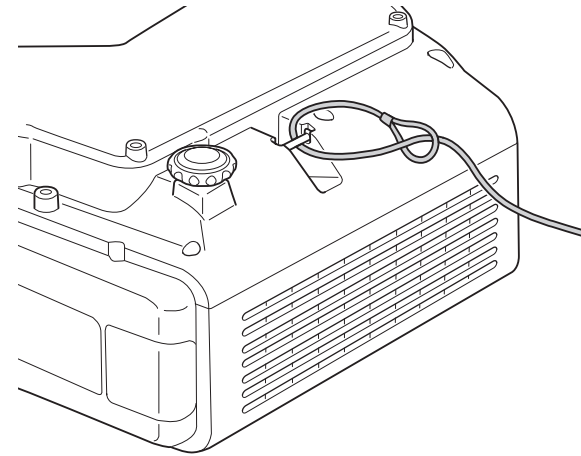

Anti-theft projection lens

The bayonet type allows you to simply and easily exchange the projector's lens. If you are concerned about security, this is a useful anti-theft device as, once it is locked with the screw supplied, it cannot be quickly removed.

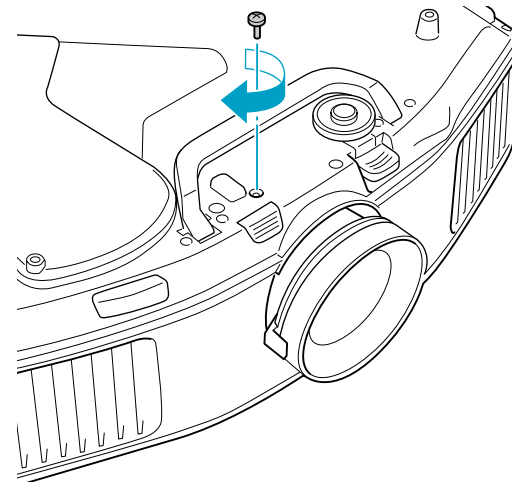



Configuration Menu

This chapter explains how to use the configuration menu and its functions.

1 Selecting from the top menu

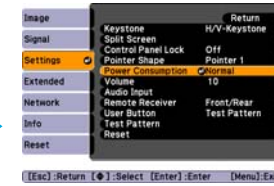
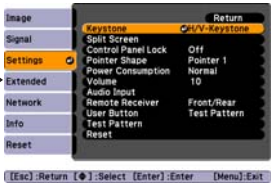
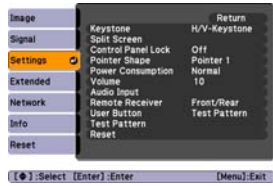
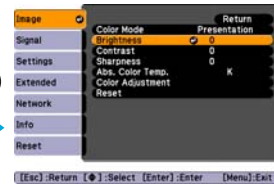
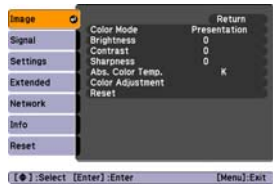

2 Selecting from the sub menu

3 Setting Each Item

4 Exit

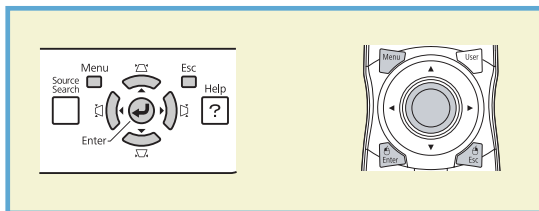
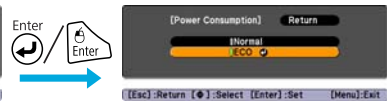
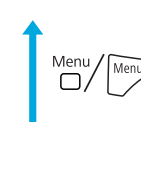
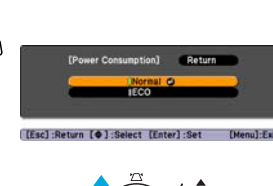
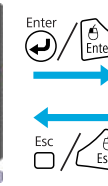
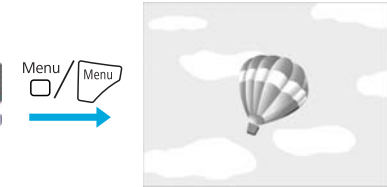
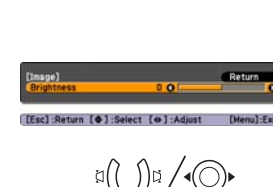

Items that can be set vary depending on the image signal or input source currently being projected as shown in the following screen shots. Setting details are saved for each image signal.

RGB Signal/USB */LAN*

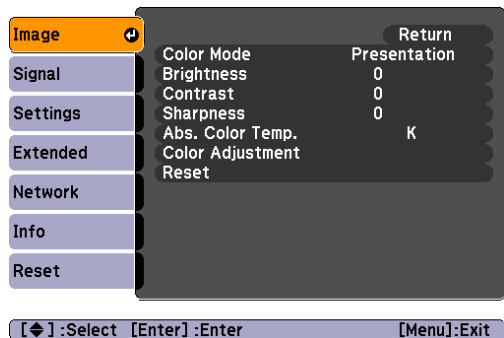

Component Video Signal▶▶/ Composite video Signal▶▶/S-Video Signal▶▶

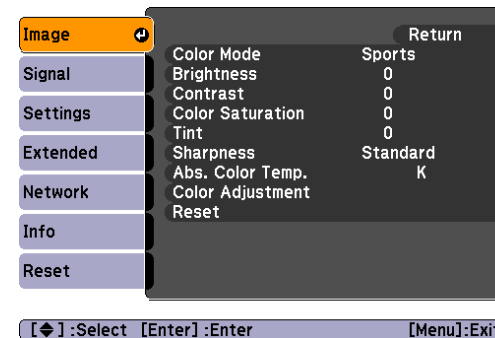

*EB-G5950/G5650W only

Sub Menu	Function
Color Mode	You can select the quality of the image to suit your surroundings.  p.33
Brightness	You can adjust the image Brightness.
Contrast▶▶	You can adjust the difference between light and shade in the images.
Color Saturation	You can adjust the Color Saturation for the images.
Tint*1	You can adjust the image Tint.
Sharpness	<p>Standard: You can adjust the image sharpness. To make more-detailed settings, select Advanced.</p> <p>Advanced*2: The following four items can be set.</p> <p>Thin Line Enhancement: If this parameter is set to a positive value, details such as hair or fabric patterns will be enhanced.</p> <p>Thick Line Enhancement: If this parameter is set to a positive value, the outline, background, and the other main parts of the objects in the image will be enhanced to show them clearly.</p> <p>H-Sharpness: If this parameter is set to a positive value, the image is enhanced in the horizontal direction. If it is set to a negative value, the image is softened.</p> <p>V-Sharpness: If this parameter is set to a positive value, the image is enhanced in the vertical direction. If it is set to a negative value, the image is softened.</p>

Sub Menu	Function
Abs. Color Temp.*3	You can adjust the overall tint of the image in 10 stages from 5000 K to 10000 K. When a high value is selected the image becomes tinged with blue, when a low value is selected the image becomes tinged with red.
Color Adjustment	<p>You can make adjustments by choosing one of the following.</p> <p>Red, Green, Blue*4: You can adjust the saturation of each color individually.</p> <p>R, G, B, C, M, Y: You can adjust the hue, saturation, and brightness of each color R (red), G (green), B (blue), C (cyan), M (magenta), Y (yellow) individually.</p> <p>(This item can be set simply by setting the Color Mode to Customized.)</p>
Reset	You can reset all adjustment values for the Image menu functions to their default settings. To return all menu items to their default settings, see  p.83

*1 This parameter can be set for composite video signal input or S-video signal input only when inputting a NTSC-system signal.

*2 This parameter cannot be set for RGB signal input or when the input source is set to **USB** or **LAN**.

*3 This parameter cannot be set when the Color Mode is set to **sRGB**.

*4 This parameter cannot be set when the Color Mode is set to **sRGB** or **Customized**.

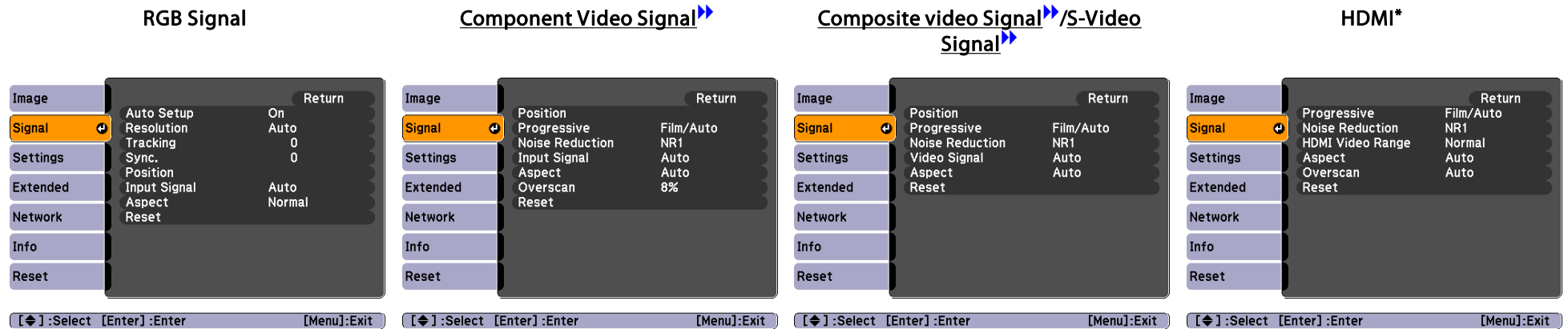

Items that can be set vary depending on the image signal or input source currently being projected as shown in the following screen shots. Setting details are saved for each image signal.

You cannot make settings in the Signal menu when the input source is USB or LAN. (EB-G5950/G5650W)



* EB-G5950/G5900/G5650W/G5600 only

Sub Menu	Function
Auto Setup	You can select whether or not (On/Off) Auto Setup automatically adjusts the image to the optimum state when the Input Signal changes.
Resolution	Auto: The resolution of the input signal is automatically identified. Wide, Normal: If the images cannot be projected correctly when Auto is set, set this menu. Set to Wide depending on the connected computer for wide screens, or set to Normal for 4:3 or 5:4 screens. Manual: You can specify the resolution. This is ideal when connected computer is fixed.
Tracking	You can adjust computer images when vertical stripes appear in the images.
Sync.	You can adjust computer images when flickering, fuzziness, or interference appear in the images.
Position	You can adjust the display Position up, down, left, and right when a part of the image is missing so that the whole image is projected.
Progressive*1*2	Off: IP conversion is carried out for each field in the screen. This is ideal for viewing images with a large amount of movement. Video: This is ideal for viewing general video images. Film/Auto: By automatically converting movie films, CG, animated images, and so on recorded in 24/30 frames to the optimum progressive signal via 2-3 pull-down, it is possible to recreate the natural feel of the original image.
Noise Reduction*2	Smooths out rough images. There are two modes. Select your favorite setting. It is recommended that this is set to Off when viewing image sources in which noise is very low, such as for DVDs.

Sub Menu	Function
HDMI Video Range	If the range is set to Auto ^{*3} , the video level of the input signal will be automatically determined, for example, when the HDMI input port is connected to a DVD player. If the range is set to Auto and the image shows whiteout or blackout, set the video level according to the video level setting of the DVD player. The video level of the DVD player may be set to Normal or Expanded.
Input Signal	You can select the input signal from the Computer1 input port, Computer2 input port, or BNC input port. If Auto is set, the input signal is identified automatically according to the connected equipment. If colors do not appear correctly when this is set to Auto , select the appropriate signal according to the connected equipment.
Video Signal	You can select the input signal from the Video1 input port, Video2 input port, and S-Video input port. If set to Auto , video signals are recognized automatically. If interference appears in the image or a problem occurs such as no image is being projected when set to Auto , select the appropriate signal according to the connected equipment.
Aspect	You can set the <u>Aspect Ratio</u>  for projected images.  p.29
Overscan ^{*2}	You can change the Output Scaling (the range of projected image). The range of trimming screen can be set to Off , 4% , or 8% . You can select Auto ^{*3} only when the input source is HDMI . When Auto is selected, the range is automatically switched to Off or 8% according to the input signal.
Reset	You can reset all adjustment values on the Signal menu to their default settings, except for Input Signal . To return all menu items to their default settings, see  p.83

*1 When a component video or RGB video signals are input, this setting can be set only when 480i, 576i, or 1080i signals are being input.

*2 This cannot be set when a digital RGB signal is input.





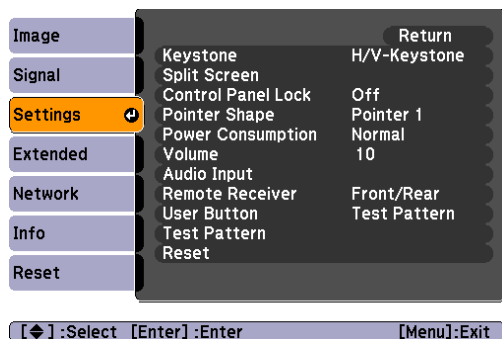



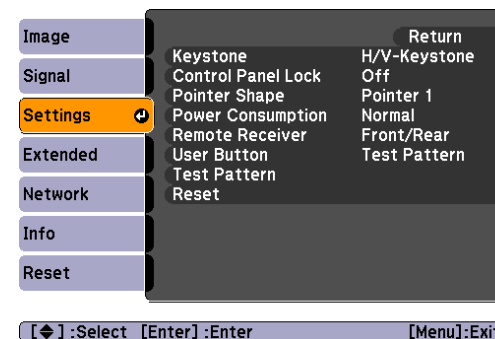







*3 This can be set only when the HDMI output on the connected equipment is connected to the HDMI input port on the projector.



EB-G5950/G5900/G5650W/G5600



EB-G5800/G5500



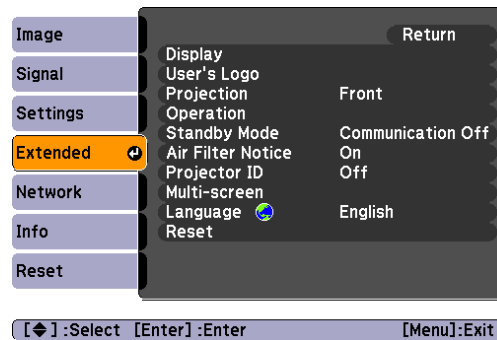

Sub Menu	Function
Keystone	<p>You can correct keystone distortion.</p> <p>H/V-Keystone: Corrects horizontal and vertical keystone distortion. Select one of V-Keystone or H-Keystone.  p.25</p> <p>Use the [ / ], [ / ], [ / ] and [ / ] buttons on the control panel to perform similar corrections to V-Keystone and H-Keystone.</p> <p>Quick Corner: Selects and corrects the four corners of the projected image.  p.23</p>
Split Screen	You can split the screen into two screens.  p.34
Control Panel Lock	You can use this to restrict operation of the projector's control panel.  p.51
Pointer Shape	<p>You can select the shape of the pointer.  p.39</p> <p>Pointer 1:  Pointer 2:  Pointer 3: </p>
Power Consumption	<p>You can set the lamp brightness to Normal or ECO.</p> <p>Select ECO if the images being projected are too bright such as when projecting images in a dark room or onto a small screen. When ECO is selected, the amount of electricity consumed and the lamp's operating life are changed as follows, and the fan rotation noise during projection is reduced. Electrical consumption: about 16% decrease, lamp life: about 1.5 times longer</p>
Volume	You can adjust the volume. Setting details are saved for each source and each image signal.
Audio Input	<p>HDMI Audio Input: When the input source is HDMI, audio is output from the projector using the port that is set here.</p> <p>LAN Audio Input (EB-G5950/G5650W only): When the image from a computer that is connected through the network is being projected, audio is output from the projector using the port that is set here. When transferring audio from the computer to the projector to output it, select LAN.</p>

Sub Menu	Function
Remote Receiver	You can limit the reception of the operation signal from the remote control. When you want to prohibit operation by remote control, or if the remote receiver has a fluorescent light too close to it, you can make settings to deactivate the remote receiver you do not want to use or that is experiencing interference. If the [Menu] button on the remote control or control panel is pressed for 15 seconds, this parameter will return to the default setting.
User Button	You can select the item assigned from the configuration menu with the remote control's [User] button. By pressing the [User] button the assigned menu item selection/adjustment screen is displayed, allowing you to make one-touch settings/adjustments. You can assign one of the following six items to the [User] button. Power Consumption, Info, Progressive, Test Pattern, Multi-screen, and Resolution
Test Pattern	When the projector is setup, a Test Pattern is displayed so that you can adjust the projection without connecting other equipment.  p.21
Reset	You can reset all adjustment values on the Settings menu to their default settings, except for User Button . To return all menu items to their default settings, see  p.83



Sub Menu	Function
Display	<p>You can make settings related to the projector's display.</p> <p>Messages: The following messages are not displayed on the screen when this item is set to Off. Overheating and other warnings, messages such as when there is no video input, and when Freeze is On or when changing Source, Color Mode or Aspect.</p> <p>Display Background*1: You can set the screen status for when no image signal is available to Black, Blue, or Logo.</p> <p>Startup Screen*1: Set this parameter to On to display the user's logo when projection is started.</p> <p>A/V Mute*1: You can set the screen displayed during A/V Mute as Black, Blue, or Logo.</p>
User's Logo*1	<p>You can change the User's Logo that is displayed as a background during Display Background or Startup Screen. 🖱️ p.47</p>
Projection	<p>Set this parameter according to the installation status of the projector. 🖱️ p.131</p>

Sub Menu	Function
Operation	<p>Direct Power On: You can set whether or not (On/Off) to enable Direct Power On. Be careful when this item is set to On because this unit turns on at the time of power recovery with this unit plugged-in to an outlet.</p> <p>Sleep Mode: When set to On, this automatically stops projection when no image signal is being input and no operations are carried out.</p> <p>Sleep Mode Timer: When Sleep Mode is set to On, you can set the time before the projector automatically turns off within a range of 1 to 30 minutes.</p> <p>High Altitude Mode: Set to On when using the projector above an altitude of 1500 m.</p> <p>BNC Sync Termination: Set the termination for the signal from the BNC input port. This should usually be set to Off. Set to On when analog (75Ω) termination such as for switchers is necessary.</p> <p>Remote Control Type: You can select Normal or Simple depending on the type of remote control. Set this item to Normal to use the remote control provided with the projector. When Simple is selected, you can use the remote control provided with other Epson projectors to operate this projector. This is useful if you want to use a remote control that you are already familiar with to operate the projector. (When using the remote control that is supplied with an EB-G50xx to EB-G53xx-series or EB-Z80xx-series projector, select Normal.) However, you cannot use the remote control provided with this projector if this is set to Simple. Make sure that the setting is correct because, if the projector is mounted on the ceiling or somewhere hard to reach, changing it back to Normal may be difficult. Additionally, you cannot use the functions that are not equipped with this projector or the remote control which you use.</p> <p>Inv Direction Button: Set this to On when suspending the projector from the ceiling.  p.131</p>
Standby Mode	You can use the functions that monitor and control the status of the projector over the network even when the projector is in standby mode if this is set to Communication On .
Air Filter Notice	You can set whether or not (On/Off) to enable Air Filter Notice. When this is set to On and a clog in the air filter is detected, the message is displayed on the screen.
Projector ID	Set the ID within a range of 1 to 9. Off indicates that no ID is set.  p.42
Multi-screen	<p>You can adjust the hue and brightness of each projected image when two or more projectors are lined up and projecting.  p.45</p> <p>Adjustment Level: You can adjust from black to white in five stages called Level 1 to 5, and in each of these 5 levels you can adjust Brightness Correct. and Color Correct.</p> <p>Brightness Correct.: Corrects the difference in the brightness of each projector.</p> <p>Color Correct. (G/R) / Color Correct. (B/Y): You can correct the difference in the color of each projector.</p>
Language	You can set the Language for message displays.

Sub Menu	Function
Reset	You can reset Display ^{*2} , Operation ^{*3} , and Air Filter Notice from the Extended menu to their default settings. To return all menu items to their default settings, see  p.83



*1 When **User's Logo Protect** is set to **On** in Password Protect, settings relating to the user's logo cannot be changed. You can make changes after setting **User's Logo Protect** to **Off**.  [p.47](#)

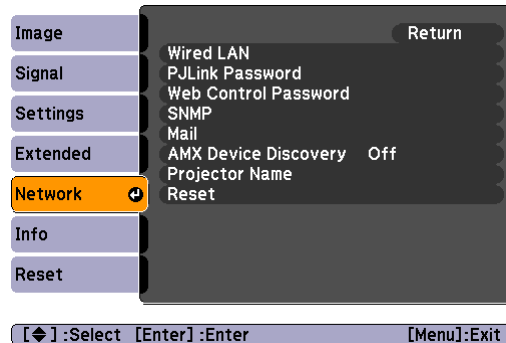

*2 Except for parameters related to the user's logo.

*3 Except for the **Inv Direction Button**, **High Altitude Mode**, and **Remote Control Type** parameters.

When **Network Protect** is set to **On** in **Password Protect**, a message is displayed and the settings cannot be changed. You can make changes after setting **Network Protect** to **Off**.  [p.49](#)



Sub Menu	Function
Wired LAN	<p>You can make network settings.</p> <p>DHCP: You can set whether or not (On/Off) to use DHCP. If this is set to On you cannot set any more addresses.</p> <p>IP Address: You can input the IP address assigned to the projector.* You can enter a number from 0 to 255 in each field of the address. However, the following IP Addresses cannot be used. 0.0.0.0, 0.x.x.x, 127.x.x.x, 224.0.0.0 to 255.255.255.255 (where x is a number from 0 to 255)</p> <p>Subnet Mask: You can input the subnet mask for the projector.* You can enter a number from 0 to 255 in each field of the address. However, the following subnet masks cannot be used. 0.0.0.0, 255.255.255.255</p> <p>Gateway Address: You can input the IP address for the gateway for the projector.* You can enter a number from 0 to 255 in each field of the address. However, the following Gateway Addresses cannot be used. 0.0.0.0, 127.x.x.x, 224.0.0.0 to 255.255.255.255 (where x is a number from 0 to 255)</p> <p>MAC Address: You can display the MAC address for the projector.</p>
PJLink Password	<p>Enter a password to use when you access the projector using compatible PJLink software.*  p.118</p> <p>You can enter up to 32 single-byte alphanumeric characters.</p>
Web Control Password	<p>Set a password to use when making settings and controlling the projector using Web Control.* You can enter up to 8 single-byte alphanumeric characters.  p.112</p>

Sub Menu	Function
SNMP	<p>Set this parameter to On when using SNMP to monitor the projector.</p> <p>To use SNMP to monitor the projector, you need to install the SNMP manager program on your computer. SNMP should be managed by a network expert.  p.115</p> <p>Trap IP Address 1 or Trap IP Address 2: When SNMP is set to On, you can register up to two IP addresses as SNMP trap notification destinations.*</p>
Mail	<p>When this is set, you receive an e-mail notification if a problem or warning occurs in the projector. For information on the contents of the sent email,  "Reading Problem Mail Notification Function" p.114</p> <p>Mail Notification: You can set whether or not (On/Off) to be notified by e-mail. If this is set to Off you cannot set any more addresses.</p> <p>SMTP Server: You can input the IP address for the SMTP server for the projector.*</p> <p>You can enter a number from 0 to 255 in each field of the address. However, the following IP Addresses cannot be used. 127.x.x.x, 224.0.0.0 to 255.255.255.255 (where x is a number from 0 to 255)</p> <p>Port Number: You can display the SMTP server's port number.</p> <p>The default value is 25. When editing settings from Web Control, you can change Port Number by entering a valid number from 1 to 65535.</p> <p>Address 1 Setting/Address 2 Setting/Address 3 Setting: You can enter the e-mail address* and the contents of the message to receive notification when a problem or warning occurs. You can register up to three destinations. You can enter up to 64 single-byte alphanumeric characters for the e-mail addresses.</p>
AMX Device Discovery	<p>When the projector is connected to a network, set this to On to allow the projector to be detected by AMX Device Discovery. Set this to Off if the projector is not connected to an environment controlled with a controller from AMX or AMX Device Discovery.</p>
Projector Name	<p>Displays the projector name used to identify the projector when connected to a network.</p>
Reset	<p>You can reset all adjustment values for the Network menu to their default settings.</p> <p>To return all menu items to their default settings, see  p.83</p>

* When inputting numbers and passwords, the following software keyboards are displayed. Use the [] button on the remote control to move the cursor to the desired key, and then press the [Enter] button to enter the character. Enter figures by holding down the [Num] button on the remote control, and pressing the numeric buttons. After inputting, press [Finish] on the keyboard to confirm your input. Press [Cancel] on the keyboard to cancel your input.

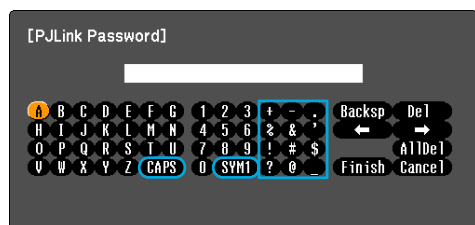

[Esc]:Return [↔]:Select [Enter]:Set [Menu]:Exit

Each time the [CAPS] key is selected and the [Enter] button is pressed, it switches between uppercase and lowercase letters. Each time the [SYM1/2] key is selected and the [Enter] button is pressed, it switches the symbol keys in the section enclosed in the box.

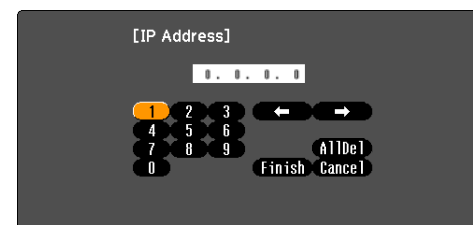

[Esc]:Return [↔]:Select [Enter]:Set [Menu]:Exit

When **Network Protect** is set to **On** in **Password Protect**, a message is displayed and the settings cannot be changed. You can make changes after setting **Network Protect** to **Off**.  [p.49](#)

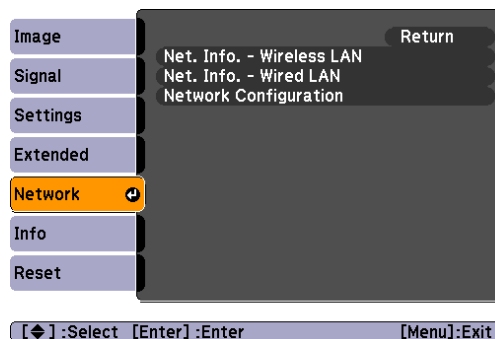

Sub Menu	Function
Net. Info. - Wireless LAN Net. Info. - Wired LAN	Displays the network settings.
Network Configuration	Displays the screen to set the network.  p.68



By using the Web browser of a computer connected to the projector on a network, you can set the projector's functions and control the projector. This function is called "Web Control". You can easily enter text using a keyboard to make settings for "Web Control" such as security settings.  [p.112](#)

Notes on Operating the Network Menu

Selecting from the top menu and sub menus, and changing of selected items are the same as operations in the configuration menu.

When done, make sure you go to the **Setup complete**, and select one of **Yes**, **No**, or **Cancel**. When you select **Yes** or **No**, you return to the configuration menu.



- Yes:** Saves the settings and exits the **Network** menu.
- No:** Exits to the **Network** menu without saving the settings.
- Cancel:** Continues displaying the **Network** menu.





- Each time the [CAPS] key is selected and the [Enter] button is pressed, it switches between uppercase and lowercase letters.
- Each time the [SYM1/2] key is selected and the [Enter] button is pressed, it switches the symbol keys in the section enclosed in the box.

Soft Keyboard Operations

The **Network** menu contains items that require input of alphanumerics during setup. In this case, the following software keyboard is displayed. Use the [◊] button on the remote control or [△/▲], [▽/▼], [◂/◄] and [▸/►] buttons on the control panel to move the cursor to the desired key, and then press the [Enter] button to enter the alphanumeric. Enter figures by holding down the [Num] button on the remote control, and pressing the numeric buttons. After inputting, press [Finish] on the keyboard to confirm your input. Press [Cancel] on the keyboard to cancel your input.

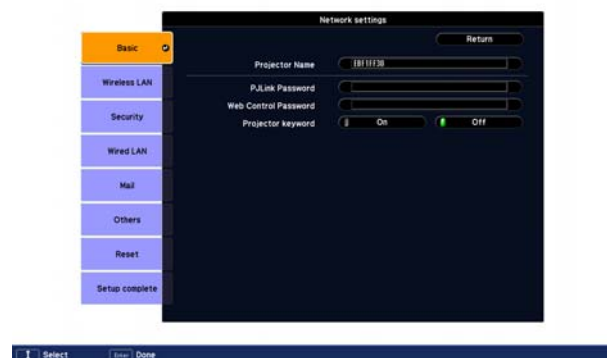
Basic Menu



Sub Menu	Function
Projector Name	Displays the projector name used to identify the projector when connected to a network. When editing, you can enter up to 16 single-byte alphanumeric characters.
PJLink Password	Set a password to use when you access the projector using compatible PJLink software.  p.118 You can enter up to 32 single-byte alphanumeric characters.
Web Control Password	Set a password to use when making settings and controlling the projector using Web Control. You can enter up to 8 single-byte alphanumeric characters. Web Control is a computer function that allows you to set up and control the projector by using the Web browser on a computer connected on a network.  p.112
Projector Keyword	When set to On , you have to enter the keyword when you try to connect the projector to a computer on a network. As a result, you can prevent presentations from being interrupted by unscheduled connections from the computer. Normally this should be set to On .

Wireless LAN Menu

To connect the projector to a computer using a wireless LAN, install the Wireless LAN unit (ELPAP03).  [p.143](#)



Sub Menu	Function
Wireless LAN Power	Set this parameter to On when connecting the projector and a computer via a wireless LAN. If you do not want to connect via a wireless LAN, set this parameter to Off to prevent unauthorized access by others.
Connection Mode	Set the connection mode to use when connecting the projector and a computer via a wireless LAN. When using an AdHoc connection, the connection mode is set to Quick . When using Infrastructure Mode , the connection mode is set to Advanced . When connecting the computer to the projector using EasyMP Multi PC Projection, set the connection mode to Advanced .
Wi-Fi Protected Setup	When using a WPS (Wi-Fi Protected Setup) compatible access point via a wireless LAN, you can easily connect the projector to the access point and make security settings.  p.125
Channel	When connecting in Quick mode, you can select a channel that uses 802.11b/g. If interference from other signals occurs, use a different channel.
Wireless LAN system	Sets the wireless LAN system. When connecting in Advanced mode, Auto can be set to automatically select a method that is suitable to the application environment. In an area that does not support 802.11a, only 802.11b/g is displayed.
SSID Auto Setting	When connecting in Quick mode, SSID Auto Setting can be set to On to enable finding this projector faster from among multiple projectors to make connection more stable. The SSID will be created automatically, so the following address cannot be set. Set this parameter to Off when connecting from one computer to multiple projectors.
SSID	Enter an SSID. When an SSID is provided for the wireless LAN system in which the projector participates, enter the SSID. You can enter up to 32 single-byte alphanumeric characters.



Sub Menu	Function
DHCP	You can set whether or not (On/Off) to use DHCP . If this is set to On you cannot set any more addresses.
IP Address	You can input the IP address assigned to the projector. You can input a number from 0 to 255 in each field of the address. However, the following IP addresses cannot be used. 0.0.0.0, 127.x.x.x, 224.0.0.0 to 255.255.255.255 (where x is a number from 0 to 255)
Subnet Mask	You can input the Subnet Mask for the projector. You can input a number from 0 to 255 in each field of the address. However, the following subnet masks cannot be used. 0.0.0.0, 255.255.255.255
Gateway Address	You can input the IP address for the gateway for the projector. You can input a number from 0 to 255 in each field of the address. However, the following Gateway addresses cannot be used. 0.0.0.0, 127.x.x.x, 224.0.0.0 to 255.255.255.255 (where x is a number from 0 to 255)
MAC Address	Displays the MAC address.
SSID Display	To prevent the SSID from being displayed on the LAN Standby screen, set this to Off .
IP Address Display	To prevent the IP address from being displayed on the LAN Standby screen, set this to Off .

Security Menu (Only available when the Wireless LAN unit is installed)

When the Wireless LAN unit is installed and being used in Advanced mode, it is strongly recommended that you set security.

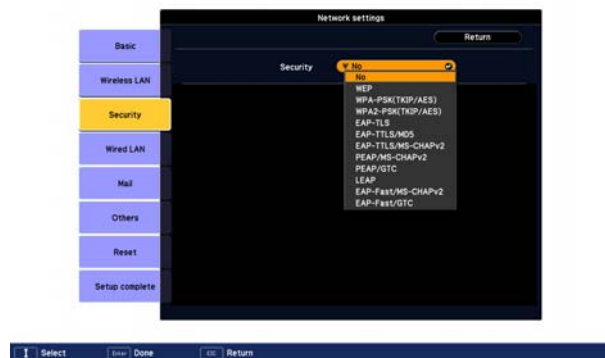

Sub Menu	Function
Security	<p>You can select one type of security.</p> <p>When setting up security, follow the instructions from the administrator of the network system you are about to access.</p> <p>The following types of security are provided by the projector.</p> <p>WEP: Data is encrypted with a code key (WEP key)</p> <p>This mechanism prevents communication unless the encrypted keys for the access point and the projector match.</p> <p>WPA/WPA2: This is an encryption standard that improves security which is a weak point of WEP. Although there are multiple kinds of WPA encryption methods, this projector uses "TKIP" and "AES".</p> <p>WPA also includes user authentication functions. WPA authentication provides two methods: using an authentication server, or authenticating between a computer and an access point without a server. This projector supports the latter method, without a server.</p> <p>EAP: EAP is a protocol used for communication between clients and authentication servers. These are multiple protocols, such as EAP-TLS which uses electronic certification for user authentication, LEAP which uses user name and password, and EAP-TTLS.</p>



If using EAP, you need to make settings at the projector that match the authentication server settings. Check with your network administrator for details on RADIUS settings.

When WEP is selected





Sub Menu	Function
WEP Encryption	You can set the encryption for WEP encoding. 128 Bit: Uses 128 (104) bit encoding 64 Bit: Uses 64 (40) bit encoding
Format	You can set the input method for the WEP encrypted key. ASCII: Input text. The method of inputting the encrypted WEP with text differs depending on the access point. Check with the network administrator for the network in which the projector participates, and then set to "ASCII". HEX: Input in hexadecimal.
Key ID	Selects the WEP encryption ID key.
Encryption Key 1/Encryption Key 2/Encryption Key 3/Encryption Key 4	You can enter the key used for WEP encryption. Enter the key in single-byte characters following instructions from the network administrator for the network in which the projector participates. The type of character and the number that can be entered differ according to the WEP Encryption and Format settings. If the number of characters you enter is shorter than the required character length, no character is encrypted. If the number of characters you enter is longer than the required character length, characters that exceed the permitted number are not encrypted. 128 Bit - ASCII: Single-byte alphanumerics, 13 characters. 64 Bit - ASCII: Single-byte alphanumerics, 5 characters. 128 Bit - HEX: 0 to 9 and A to F, 26 characters 64 Bit - HEX: 0 to 9 and A to F, 10 characters

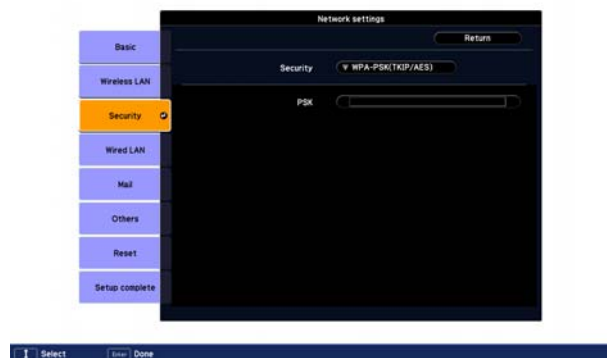

Sub Menu	Function
Authentication Type	You can set Authentication Type for WEP encoding. Open: Method to connect access point with no authentication. Shared: Authentication Type using WEP key.

When WPA-PSK(TKIP/AES) or WPA2-PSK(TKIP/AES) is selected



Sub Menu	Function
<p>PSK (Encryption key)</p>	<p>You can enter a Pre-Shared Key (encrypted key) in single-byte alphanumeric characters. Enter at least 8 and up to 63 characters. When the Pre-Shared Key is entered and the [Enter] button is pressed, the value is set and displayed as an asterisk (*). You cannot enter more than 32 characters on the configuration menu. When setting from Web Control, you can enter more than 32 characters.</p> <p> p.112</p>

When EAP-TLS is selected



Refer to the following information to register a digital certificate to the projector for authentication. [PC Free Operation Guide "Registering a Digital Certificate to the Projector"](#)

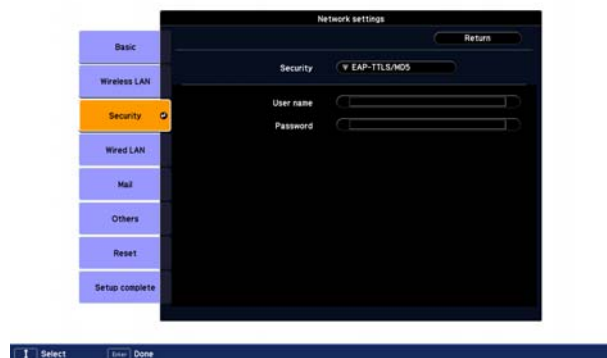

Sub Menu	Function
Issued to/Issued by/Validity period	Information in the certificate is displayed. You cannot enter.

EAP-TTLS/MD5, EAP-TTLS/MS-CHAPv2, PEAP/MS-CHAPv2, PEAP/GTC, LEAP, EAP-Fast/MS-CHAPv2, EAP-Fast/GTC is selected



Sub Menu	Function
User name	You can enter a user name to be used for authentication in single-byte alphanumeric characters (no spaces). You can enter up to 64 characters. You cannot enter more than 32 characters on the configuration menu. When setting from Web Control, you can enter more than 32 characters.  p.112
Password	You can enter an authentication password in single-byte alphanumeric characters. You can enter up to 64 characters. When the password is entered and the [Enter] button is pressed, the value is set and displayed as an asterisk (*). You cannot enter more than 32 characters on the configuration menu. When setting from Web Control, you can enter more than 32 characters.  p.112

Wired LAN Menu



Sub Menu	Function
DHCP	You can set whether or not (On/Off) to use <u>DHCP</u> . If this is set to On you cannot set any more addresses.
IP Address	You can input the <u>IP address</u> assigned to the projector. You can input a number from 0 to 255 in each field of the address. However, the following IP addresses cannot be used. 0.0.0.0, 127.x.x.x, 224.0.0.0 to 255.255.255.255 (where x is a number from 0 to 255)
Subnet Mask	You can input the <u>Subnet Mask</u> for the projector. You can input a number from 0 to 255 in each field of the address. However, the following subnet masks cannot be used. 0.0.0.0, 255.255.255.255
Gateway Address	You can input the IP address for the gateway for the projector. You can input a number from 0 to 255 in each field of the address. However, the following <u>Gateway addresses</u> cannot be used. 0.0.0.0, 127.x.x.x, 224.0.0.0 to 255.255.255.255 (where x is a number from 0 to 255)
MAC Address	Displays the MAC address.
IP Address Display	To prevent the IP address from being displayed on the LAN Standby screen, set this to Off .

Mail Menu

When this is set, you receive an e-mail notification if a problem or warning occurs in the projector. 🖱️ "Reading Problem Mail Notification Function" p.114



Sub Menu	Function
Mail Notification	You can set whether or not (On/Off) to be notified by e-mail.
SMTP Server	You can input the <u>IP address</u> for the SMTP server for the projector. You can input a number from 0 to 255 in each field of the address. However, the following IP addresses cannot be used. 127.x.x.x, 224.0.0.0 to 255.255.255.255 (where x is a number from 0 to 255)
Port Number	You can input the port number for the SMTP server. The default value is 25. You can input numbers between 1 to 65535.
Email Address 1/Email Address 2/Email Address 3	You can input the e-mail address of the destination to send the notification e-mail to. You can register up to three destinations. You can enter up to 64 single-byte alphanumeric characters for the e-mail addresses. You cannot enter more than 32 characters on the configuration menu. When setting from Web Control, you can enter more than 32 characters. 🖱️ p.112
Setting a Notification Event	You can select the problems or warnings to be notified about by e-mail. When the selected problem or warning occurs in the projector, an e-mail is sent to the specified Email Address notifying that a problem or warning has occurred. You can select multiple items from the displayed items.

Others Menu



Sub Menu	Function
SNMP	Set this parameter to On when using SNMP to monitor the projector. To use SNMP to monitor the projector, you need to install the SNMP manager program on your computer. SNMP should be managed by a network administrator.
Trap IP Address 1/Trap IP Address 2	When SNMP is set to On , you can set up to two IP addresses as SNMP trap notification destinations. You can input a number from 0 to 255 in each field of the address. However, the following IP addresses cannot be used. 127.x.x.x, 224.0.0.0 to 255.255.255.255 (where x is a number from 0 to 255)
Priority Gateway	For the priority gateway, select either Wired or Wireless .
AMX Device Discovery	When the projector is connected to a network, set this to On to allow the projector to be detected by AMX Device Discovery . Set this to Off if you are not connected to an environment controlled with a controller from AMX or AMX Device Discovery.
RoomView	Set this parameter to On only when using Crestron RoomView® to monitor and control the projector over a network. Normally, leave this parameter set to Off .  "About Crestron RoomView® (EB-G5950/G5650W only)" p.119 Changes in projector settings take effect upon restarting. The following functions cannot be used when it is set to On . <ul style="list-style-type: none"> • Web Control • Message Broadcasting (EasyMP Monitor plugin)

Reset Menu

Resets all of the network settings.

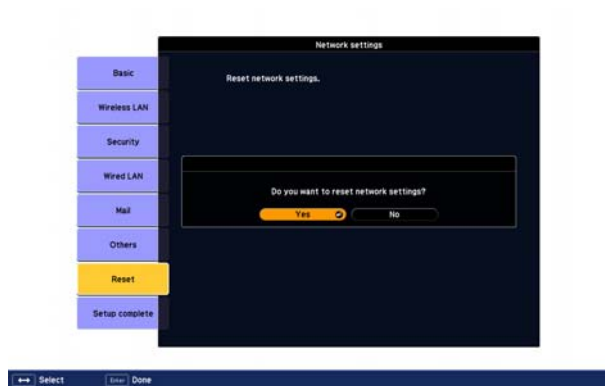

Sub Menu	Function
Reset network settings.	To reset all of the network settings, select Yes . After you reset all the settings, the Basic menu appears.

Lets you check the status of the image signals being projected and the status of the projector. Items that can be displayed vary depending on the image signal or input source being projected as shown in the following screen shots.

RGB Signal/Component Video▶▶ Signal

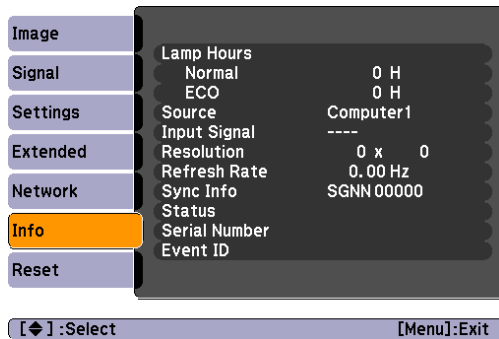

Composite video▶▶ Signal/S-Video▶▶ Signal

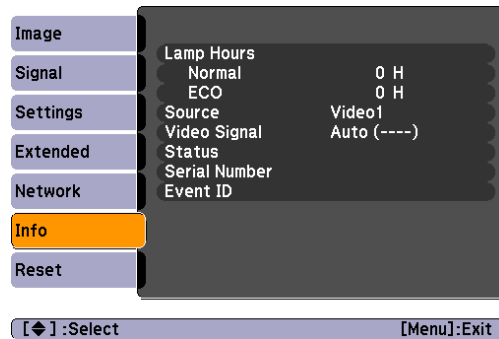

USB*/LAN*

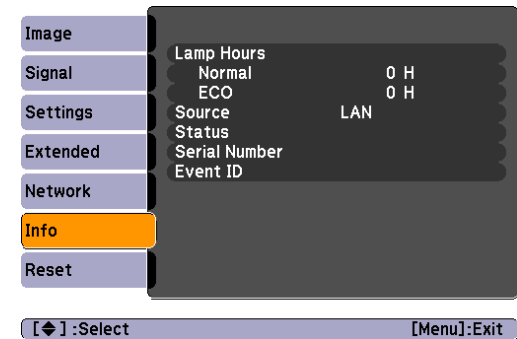

*EB-G5950/G5650W only

Sub Menu	Function
Lamp Hours	You can display the cumulative lamp operating time*1. When it reaches the lamp warning time, the characters are displayed in yellow.
Source	You can display the Source name for the connected equipment currently being projected.
Input Signal	You can display the content of Input Signal set in the Signal menu according to the Source.
Resolution	You can display the Resolution.
Video Signal	You can display the content of Video Signal set in the Signal menu.
Refresh Rate	You can display the <u>Refresh Rate</u> ▶▶.
Sync Info	You can display the image signal information. This information may be needed if service is required.
Status	This is information about errors that have occurred on the projector. This information may be needed if service is required.
Serial Number	Displays the projector's serial number.
Event ID (EB-G5950/G5650W only)	When problems occur when the projector and computer are connected through the network, information on the problem is displayed using an Event ID. Refer to the following page for information on interpreting the Event ID.  p.99

*1 The cumulative use time is displayed as "0H" for the first 10 hours. 10 hours and above is displayed as "10H", "11H", and so on.

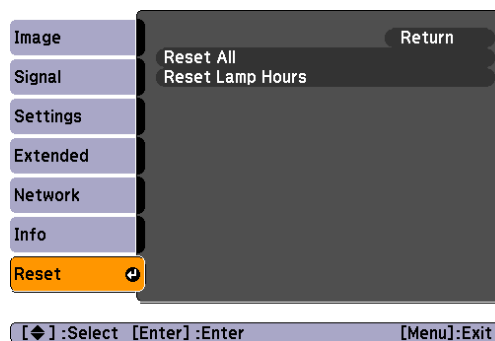

Sub Menu	Function
Reset All	You can reset all items in the configuration menu to their default settings. The following items are not reset to their defaults: Items for Password, Input Signal , User's Logo , Multi-screen , all items for Network menus, Lamp Hours , and Language .
Reset Lamp Hours	You can clear the cumulative lamp hours use time, and return it to "0H". Reset when you replace the lamp.



Troubleshooting

This chapter explains how to identify problems and what to do if a problem is found.

If a problem occurs with the projector, the Help screen is displayed to assist you by pressing the [Help] button. You can solve problems by answering the questions.

Procedure

- 1 Press the [Help] button.**

The Help screen is displayed.

Using the Remote Control

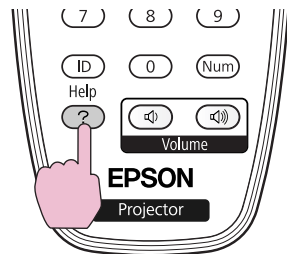

Using the Control panel

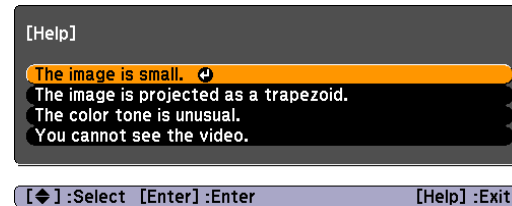
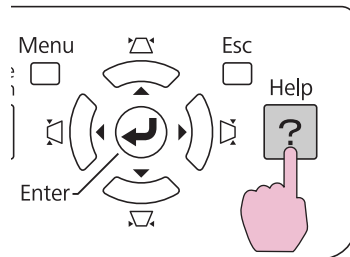

Using the Remote Control

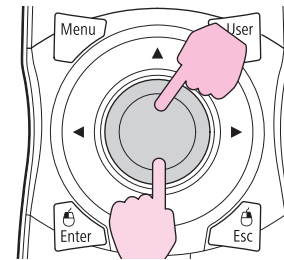

Using the Control panel

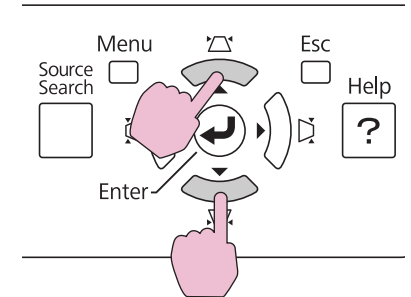

- 2 Select a menu item.**

3

Confirm the selection.

Using the Remote Control

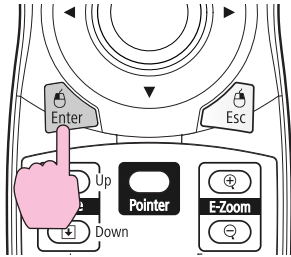

Using the Control panel

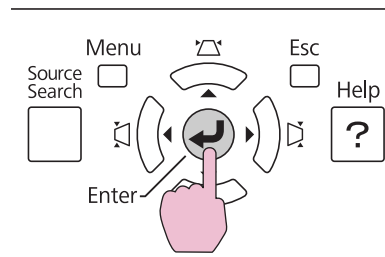

Questions and solutions are displayed as shown on the screen below.
Press the [Help] button to exit Help.

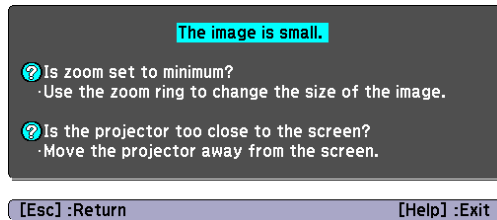

If the Help screen does not provide a solution to the problem, refer to "Problem Solving" p.87.

If you are having a problem with the projector, first check the projector's indicators and refer to "Reading the Indicators" below.

If the indicators do not show clearly what the problem might be, refer to "When the Indicators Provide No Help".  [p.91](#)

Reading the Indicators

These indicators indicate the operating status of the projector.

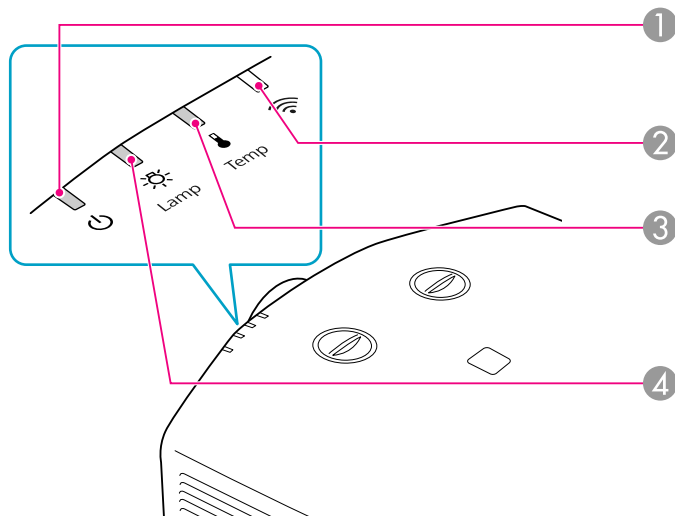

① Indicates the operating status.



Standby condition

When the [⏻] button is pressed in this condition, projection starts.



Preparing network monitoring (maximum approx. 20 minutes) or cool down in progress

Buttons are disabled while the indicator is flashing.



Warming up

Warm-up time is about 30 seconds. After warm-up is complete, the indicator stops flashing.

[⏻] button does not function during warm-up.



Projecting

























② Indicates the operating status of wireless LAN when the Wireless LAN unit is installed. (EB-G5950/G5650W only)  "Reading the wireless LAN indicators" [p.143](#)

- ③ Indicates the internal temperature status.
- ④ Indicates the projection lamp status.

Refer to the following table to see what the indicators mean and how to remedy problems that they indicate. If all indicators are off, check that the power cable is connected correctly and that the power is being supplied normally. Sometimes, when the power cable is unplugged, the ⏻ indicator remains lit for a short period, but this is not a fault.

⏻ Indicator is lit or flashing red

 : Lit
  : Flashing:
  : Off

















Status	Cause	Remedy or Status
     	Internal Error	Stop using the projector, disconnect the power cable from the electrical outlet, and contact your local dealer or the nearest address provided in the Support and Service Guide.  Epson Projector Contact List
     	Fan Error Sensor Error	Stop using the projector, disconnect the power cable from the electrical outlet, and contact your local dealer or the nearest address provided in the Support and Service Guide.  Epson Projector Contact List
     	High Temp Error (overheating)	The lamp turns off automatically and projection stops. Wait for about five minutes. After about five minutes the projector switches to standby mode, so check the following two points. <ul style="list-style-type: none"> • Check that the air filter and air exhaust vent are clear, and that the projector is not positioned against a wall. • If the air filter is clogged, clean or replace it.  p.101, p.107 If the error continues after checking the points above, stop using the projector, disconnect the power cable from the electrical outlet, and contact your local dealer or the nearest address provided in the Support and Service Guide.  Epson Projector Contact List
	Filter Airflow Error	Check the following two points. <ul style="list-style-type: none"> • Check that the air filter and air exhaust vent are clear, and that the projector is not positioned against a wall. • If the air filter is clogged, clean or replace it.  p.101, p.107 If the error continues after checking the points above, stop using the projector, disconnect the power cable from the electrical outlet, and contact your local dealer or the nearest address provided in the Support and Service Guide.  Epson Projector Contact List

Status	Cause	Remedy or Status
 	Lamp Error Lamp Failure Lamp Cover Open	Check the following two points. <ul style="list-style-type: none"> • Take out the lamp and check whether it is cracked. p.104 • Clean the air filter. p.101 <p>If it is not cracked: Re-fit the lamp and turn on the power.</p> <p>If the error continues: Replace the lamp with a new lamp and turn on the power.</p> <p>If the error continues: Stop using the projector, disconnect the power cable from the electrical outlet, and contact your local dealer or the nearest address provided in the Support and Service Guide. Epson Projector Contact List</p> <p>If it is cracked: Replace it with a new lamp, or contact your local dealer for further advice. If replacing the lamp yourself, be careful to avoid pieces of broken glass (you cannot continue projecting until the lamp is replaced). Epson Projector Contact List</p> <p>When using at an altitude of 1500 m or more, set High Altitude Mode to On. p.61</p> <p>Check that the lamp cover and the lamp are securely installed. p.104 If the lamp cover or the lamp is not securely installed, the lamp does not switch on.</p>
 	Power Err. (Ballast)	Stop using the projector, disconnect the power cable from the electrical outlet, and contact your local dealer or the nearest address provided in the Support and Service Guide. Epson Projector Contact List



Indicator is flashing or lit

: Lit
 : Flashing
 : Off
 : Varies according to the projector status

Status	Cause	Remedy or Status
 	High Temp Warning	(This is not an abnormality. However, if the temperature rises too high again, projection stops automatically.) <ul style="list-style-type: none"> • Check that the air filter and air exhaust vent are clear, and that the projector is not positioned against a wall. • If the air filter is clogged, clean or replace it. p.101, p.107
 	Replace Lamp	Replace it with a new lamp. p.104 If you continue to use the lamp after the replacement period has passed, the possibility that the lamp may explode increases. Replace it with a new lamp as soon as possible.

Status	Cause	Remedy or Status
     	Low Air Flow	<p>(This is not an abnormality. However, projection stops automatically if the airflow falls any further.)</p> <p>The message "The air filter is clogged. Clean or replace the air filter." is displayed. Check the following two points.</p> <ul style="list-style-type: none"> • Check that the air filter and air exhaust vent are clear, and that the projector is not positioned against a wall. • If the air filter is clogged, clean or replace it.  p.101, p.107 <p>If the Low Air Flow status continues after cleaning the air filter, replace the air filter with a new one.  p.107</p> <p>If the error continues after checking the points above, stop using the projector, disconnect the power cable from the electrical outlet, and contact your local dealer or the nearest address provided in the Support and Service Guide.  Epson Projector Contact List</p>
     	Air Filter Notice	<p>The following message may also be displayed: "Time to clean the air filter. Clean or replace the air filter." Clean the air filter.  p.101</p> <p>If the air filter is stained yellow with tobacco smoke and cannot be cleaned, replace it with a new one.</p> <p>The indicators or messages regarding "Air Filter Notice" are displayed only when Air Filter Notice is set to On, on the configuration menu's Extended menu.  p.61</p>













- If the projector is not operating properly, even though the indicators are all showing normal, refer to "When the Indicators Provide No Help".  [p.91](#)
- If the error is not indicated in this table, stop using the projector, disconnect the power cable from the electrical outlet, and contact your local dealer or the nearest address provided in the Support and Service Guide.  [Epson Projector Contact List](#)

When the Indicators Provide No Help

If any of the following problems occur and the indicators do not offer a solution, refer to the pages given for each problem.





Problems relating to images

- "No images appear"  p.92
Projection does not start, the projection area is completely black, the projection area is completely blue, and so on.
- "Moving images are not displayed (only the moving image portion turns black)."  p.92
Moving images being projected from a computer appear black and nothing is projected.
- "Projection stops automatically"  p.92
- "The message "Not supported" is displayed."  p.93
- ""No Signal" is displayed."  p.93
- "Images are fuzzy or out of focus"  p.93
- "Interference or distortion appear in images"  p.94
Problems such as interference, distortion, or black & white checked patterns appear.
- "The image is truncated (large) or small, or the aspect is not suitable"  p.94
Only part of the image is displayed, or the height and width ratios of the image are not correct, and so on.
- "Image colors are not right"  p.95
The whole image appears purplish or greenish, images are black & white, colors appear dull, and so on... (Computer monitors and LCD screens have different color reproduction performance, so that the colors projected by the projector and the colors appearing on the monitor may not necessarily match, but this is not a sign of a problem.)
- "Images appear dark"  p.95

Problems when projection starts

- "No power supplied"  p.96

Other problems

- "No sound can be heard or the sound is faint (EB-G5950/G5900/G5650W/G5600 only)"  p.97
- "The remote control does not work"  p.97
- "Nothing appears on the external monitor (EB-G5950/G5900/G5650W/G5600 only)"  p.98
- "I want to change the language for messages and menus"  p.98
- "Mail is not received even if a problem occurs in the projector"  p.98

Interpreting event IDs (EB-G5950/G5650W only)

-  p.99

Problems relating to images

No images appear

Check	Remedy
Did you press the [⏻] button?	Press the [⏻] button to turn the power on.
Are the indicators switched off?	The power cable is not connected correctly or power is not being supplied normally. Connect the projector's power cable correctly. 🖱 Quick Start Guide Check that your electrical outlet or power source is functioning correctly.
Is A/V Mute active?	Press the [A/V Mute] button on the remote control to cancel A/V Mute. 🖱 p.38
Are the configuration menu settings correct?	Reset All of the settings. 🖱 Reset Menu - Reset All p.83
Is the projected image completely black? Only when projecting computer images	Some input images, such as screen savers, may be completely black.
Is the image signal format setting correct? Only when projecting images from a video source	Change the setting according to the signal for the connected equipment. 🖱 Signal Menu - Video Signal p.57

Moving images are not displayed (only the moving image portion turns black).

Check	Remedy
Is the computer's image signal being output to the LCD and the monitor? Only when projecting images from a laptop computer or a computer with a built-in LCD screen	Change the image signal to external output only. 🖱 Check your computer's documentation.

Projection stops automatically

Check	Remedy
Is Sleep Mode set to On ?	Press the [⏻] button to turn the power on. If you do not want to use Sleep Mode, change the setting to Off . 🖱 Extended Menu - Operation - Sleep Mode p.61

The message "Not supported" is displayed.

Check	Remedy
Is the image signal format setting correct? Only when projecting images from a video source	Change the setting according to the signal for the connected equipment. 🖱️ Signal Menu - Video Signal p.57
Do the image signal Resolution and the Refresh Rate correspond to the mode? Only when projecting computer images	Refer to the computer's documentation for how to change the image signal Resolution and the Refresh Rate output from the computer. 🖱️ "Supported Monitor Displays" p.151

"No Signal" is displayed.







Check	Remedy
Are the cables connected correctly?	Check that all the cables required for projection are securely connected. 🖱️ p.133, p.139
Is the correct input port selected?	Change the image by pressing the [Source Search] button on the remote control or the control panel. 🖱️ p.27
Is the power for the computer or video source turned on?	Turn the power on for the equipment.
Are the image signals being output to the projector? Only when projecting images from a laptop computer or a computer with a built-in LCD screen	If the image signals are only being output to the computer's LCD monitor or to the accessory monitor, you need to change the output to an external destination as well as the computer's own monitor. For some computer models, when the image signals are output externally, they no longer appear on the LCD monitor or accessory monitor. 🖱️ p.135 If the connection is made while the power of the projector or computer is already turned on, the function [Fn] key that changes the computer's image signal to external output may not work. Turn the power for the computer and the projector off and then back on again.

Images are fuzzy or out of focus



Check	Remedy
Is the focus adjusted correctly?	Turn the focus ring to adjust the focus. 🖱️ <i>Quick Start Guide</i>
Is the projector at the correct distance?	Is it projecting outside of the recommended projection distance range? Setup within the recommended range. 🖱️ p.149
Is the Keystone adjustment value too large?	Lower the projection angle to reduce the amount of keystone correction. 🖱️ p.25

Check	Remedy
Has condensation formed on the lens?	If the projector is suddenly taken from a cold environment to a warm environment, or if sudden ambient temperature changes occur, condensation may form on the surface of the lens, and this may cause the images to appear fuzzy. Set the projector up in the room about one hour before it is used. If condensation forms on the lens, turn the projector off and wait for the condensation to disappear.

Interference or distortion appear in images

Check	Remedy
Is the image signal format setting correct? Only when projecting images from a video source	Change the setting according to the signal for the connected equipment.  Signal Menu - Video Signal p.57
Are the cables connected correctly?	Check that all the cables required for projection are securely connected.  p.133, p.135
Is an extension cable being used?	If an extension cable is used, electrical interference may affect the signals. Use the cables supplied with the projector to check if the cables you are using may be causing the problem.
Is the correct resolution selected? Only when projecting computer images	Set the computer so that the signals being output are compatible with the projector.  "Supported Monitor Displays" p.151  Computer documentation
Are the "Sync.▶▶" and "Tracking▶▶" settings adjusted correctly? Only when projecting computer analog RGB signals	Press the [Auto] button on the remote control or the [Enter] button on the control panel to perform automatic adjustment. If the images are not adjusted correctly after using automatic adjustment, you can make the adjustments using Sync. and Tracking from the configuration menu.  Signal Menu - Tracking, Sync. p.57
Is the Resolution set to Manual ? Only when projecting on a split screen	The image may be collapsed if the Resolution on the configuration menu and the resolution of the projected image are not the same. If the image is collapsed, set the Resolution to Auto .  Signal Menu - Resolution p.57

The image is truncated (large) or small, or the aspect is not suitable

Check	Remedy
Is the aspect adjusted correctly?	Press the [Aspect] button on the remote control to select an aspect suitable for the input source.  p.29
Is a wide panel computer image being projected? Only when projecting computer images	Change the setting according to the signal for the connected equipment.  Signal Menu - Resolution p.57
Is the image still being enlarged by E-Zoom?	Press the [Esc] button on the remote control to cancel E-Zoom.  p.40

















Check	Remedy
Is Position adjusted correctly?	Press the [Auto] button on the remote control or the [Enter] button on the control panel to perform automatic adjustment when projecting the computer analog RGB signals. If the images are not adjusted correctly after using automatic adjustment, you can make the adjustments using Position from the configuration menu. Apart from computer analog RGB signals, you can adjust other signals while projecting by adjusting Position from the configuration menu.  Signal Menu - Menu Position p.57
Is the computer set for dual display? Only when projecting computer images	If dual display is activated in the "Display Properties" of the computer's Control panel, only about half of the image on the computer screen is projected. To display the entire image on the computer screen, turn off the dual display setting.  Computer video driver documentation
Is the correct resolution selected? Only when projecting computer images	Set the computer so that the signals being output are compatible with the projector.  "Supported Monitor Displays" p.151  Computer documentation

Image colors are not right

Check	Remedy
Do the input signal settings match the signals from the connected device?	Change the setting according to the signal for the connected equipment.  Signal Menu - Input Signal, Video Signal p.57
Is the image Brightness set correctly?	Adjust the Brightness setting from the configuration menu.  Image Menu - Brightness p.55
Are the cables connected correctly?	Check that all the cables required for projection are securely connected.  p.133, p.135
Is Contrast  adjusted correctly?	Adjust the Contrast setting from the configuration menu.  Image Menu - Contrast p.55
Is the Color Adjustment correctly?	Adjust the Color Adjustment setting from the configuration menu.  Image Menu - Color Adjustment p.55
Are the Color Saturation and Tint adjusted correctly? Only when projecting images from a video source	Adjust the Color Saturation and Tint settings from the configuration menu.  Image Menu - Color Saturation, Tint p.55





Images appear dark

Check	Remedy
Is the image Brightness set correctly?	Adjust the Brightness and Power Consumption settings from the configuration menu.  Image Menu - Brightness p.55  Settings Menu - Power Consumption p.59
Is Contrast  adjusted correctly?	Adjust the Contrast setting from the configuration menu.  Image Menu - Contrast p.55

Check	Remedy
Is the lamp due for replacement?	When the lamp is nearly ready for replacement, the images become darker and the color quality becomes poorer. When this happens, replace the lamp with a new lamp.  p.104

Problems when projection starts

No power supplied

Check	Remedy
Did you press the [⏻] button?	Press the [⏻] button to turn the power on.
Are the indicators switched off?	The power cable is not connected correctly or power is not being supplied normally. Disconnect and then reconnect the power cable.  Quick Start Guide Check that your electrical outlet or power source is functioning correctly.
Do the indicators turn on and off when the power cable is touched?	There is probably a poor contact in the power cable, or the power cable may be defective. Reinsert the power cable. If this does not solve the problem, stop using the projector, disconnect the power cable from the electrical outlet, and contact your local dealer or the nearest address provided in the Support and Service Guide.  Epson Projector Contact List
Is the Control Panel Lock set to Full Lock ?	Press the [⏻] button on the remote control. If you do not want to use Control Panel Lock, change the setting to Off .  Settings Menu - Control Panel Lock p.59
Is the correct setting for the remote receiver selected?	Check the Remote Receiver from the configuration menu.  Settings Menu - Remote Receiver p.59
Was the power cable plugged back in or was the breaker turned on immediately after Direct Power Off?	When the operation to the left is performed when Direct Power On is set to On , the power may not turn back on. Press the [⏻] button to turn the power back on.
Is the ID switch on the side of the remote control set to On?	When the switch is set to On, you can use the remote control to operate only a projector with a matching ID. Set ID switch to Off.  p.43

Other problems

No sound can be heard or the sound is faint (EB-G5950/G5900/G5650W/G5600 only)

Check	Remedy
Is the audio source connected correctly?	Disconnect the cable from the audio input port, and then reconnect the cable.
Is the volume adjusted to the minimum setting?	Adjust the volume so that sound can be heard. 🖱️ Quick Start Guide
Is A/V Mute active?	Press the [A/V Mute] button on the remote control to cancel A/V Mute. 🖱️ p.38
Is the audio cable's specification "No resistance"?	When using a commercially available audio cable, make sure it is labeled "No resistance".
Is it connected with an HDMI cable?	If no audio is output when connecting via an HDMI cable, set the connected equipment to PCM output.
Is the correct setting for the HDMI Audio Input selected? Only when the input source is HDMI	Check the HDMI Audio Input from the configuration menu. 🖱️ Settings Menu - Audio Input - HDMI Audio Input p.59
Is the correct setting for the LAN Audio Input selected? Only when the input source is LAN	If the audio from a computer that is connected through a network is not output, check the setting of the LAN Audio Input on the configuration menu. 🖱️ Settings Menu - Audio Input - LAN Audio Input p.59

The remote control does not work

Check	Remedy
Is the remote control light-emitting area pointing towards the remote receiver on the projector when it is operated?	Point the remote control towards the Remote Receiver. 🖱️ p.19
Is the remote control too far from the projector?	The operating range for the remote control is about 15 m. 🖱️ p.19
Is direct sunlight or strong light from fluorescent lamps shining onto the Remote Receiver?	Set the projector up in a location where strong light does not shine onto the remote receiver. Or set the remote receiver to Off from Remote Receiver in the configuration menu. 🖱️ Settings Menu - Remote Receiver p.59
Is the correct setting for the remote receiver selected?	Check the Remote Receiver from the configuration menu. 🖱️ Settings Menu - Remote Receiver p.59
Are the batteries dead or have the batteries been inserted correctly?	Make sure the Batteries are inserted correctly or replace the batteries with new ones if necessary. 🖱️ p.18
Are the remote control ID and the projector ID matched?	Make sure the ID for the projector you want to operate and the ID for the remote control match. To operate all projectors by remote control regardless of the ID setting, set the ID switch on the side of the remote control to Off. 🖱️ p.42
Does Remote Control Type match the remote control that you are using?	Check the Remote Control Type on the configuration menu. 🖱️ Extended Menu - Operation - Remote Control Type p.61
Is the optional remote control cable connected to the remote control or to the projector's remote port?	When the remote control cable is connected, the remote control light-emitting area or the projector's remote receiver are disabled. When not using the remote control cable set, disconnect it from the remote control and the remote port.



Nothing appears on the external monitor (EB-G5950/G5900/G5650W/G5600 only)

Check	Remedy
Are you trying to display an image from an input port other than one of the following input ports: Computer1 input port, Computer2 input port, or BNC input port?	Only RGB signals from one of the following input ports can be displayed on an external monitor: Computer1 input port, Computer2 input port, and BNC input port
Are you projecting a split screen?	Only RGB signals projected on the left screen from one of the following input ports can be displayed on an external monitor: Computer1 input port, Computer2 input port, and BNC input port  p.34

I want to change the language for messages and menus



Check	Remedy
Change the Language setting.	Adjust the Language setting from the configuration menu.  Extended Menu - Language p.61

Mail is not received even if a problem occurs in the projector

Check	Remedy
Is Standby Mode set to Communication On ?	To use the Mail Notification function when the projector is in standby, set Communication On in Standby Mode from the configuration menu.  Extended Menu - Standby Mode p.61
Did a fatal abnormality occur and the projector come to a sudden stop?	When the projector comes to a sudden stop, e-mail cannot be sent. If the abnormal state continues, contact your local dealer or the nearest address provided in the Support and Service Guide.  Epson Projector Contact List
Is power being supplied to the projector?	Check that your electrical outlet or power source is functioning correctly.
Is Mail function set correctly in the configuration menu?	Mail notification of problems is sent according to the Mail settings in the configuration menu. Check if it is set correctly.  Network menu - Mail EB-G5900/G5800/G5600/G5500 p.64 , EB-G5950/G5650W p.79

Interpreting Event IDs (EB-G5950/G5650W only)

Check the event ID and perform the remedy given below. If the problem cannot be solved, contact the network administrator or one of the following contact addresses.  [Epson Projector Contact List](#)

Event ID	Cause	Remedy
0432 0435	Failed to startup EasyMP Network Projection.	Restart the projector.
0434 0481 0482 0485	Network communication is unstable.	Check the status of network communications. Wait for a while and then try connecting again.
0433	An image that was transferred cannot be reproduced.	Restart EasyMP Network Projection.
0484	Communications was cut off from the computer.	
04FE	EasyMP Network Projection ended unexpectedly.	Check the status of network communications. Restart the projector.
04FF	A system error occurred in the projector.	Restart the projector.
0891	The same SSID access point cannot be found.	Set the computer, the access point, and the projector to the same SSID.
0892	The WPA and WPA2 authentication methods are not the same.	Check the setting of wireless LAN security to see if it is correct.  Network Menu - Security Menu p.67
0893	The WEP, TKIP, and AES encoding methods are not the same.	
0894	Communications was cut off because a connection was made to the wrong access point.	Check with the network administrator and follow their instructions.
0898	Failed to obtain the DHCP.	Check the DHCP server to see if it is operating correctly and check the LAN cable to see if it is connected correctly. Turn off DHCP if it is not being used.  Network Menu - Wireless LAN Menu p.70 , Wired LAN Menu p.78
0899	Other connection errors	If the problem cannot be solved by restarting the projector or EasyMP Network Projection, contact one of the following contact addresses.  Epson Projector Contact List



Maintenance

This chapter explains the maintenance methods that are required to ensure a long projector service life.

You should clean the projector if it becomes dirty or if the quality of projected images starts to deteriorate.

Warning

Do not use sprays containing a flammable gas to remove dirt or dust which is adhering to parts such as the lens or filter of the projector. This could be a cause of the fire for the high temperature of the lamp inside the unit.

Cleaning the Projector's Surface

Clean the projector's surface by wiping it gently with a soft cloth.

If the projector is particularly dirty, moisten the cloth with water containing a small amount of neutral detergent, and then firmly wring the cloth dry before using it to wipe the projector's surface.

Attention

Do not use volatile substances such as wax, alcohol, or thinner to clean the projector's surface. The quality of the case may change or become discolored.

Cleaning the Lens

Use a commercially available cloth for cleaning glasses to gently wipe the lens.

Attention

Do not rub the lens with harsh materials or subject the lens to shocks, as it can easily become damaged.

Cleaning the Air Filter

If one of the following messages is displayed or the temperature indicator flashes green, clean the air filter.

Time to clean the air filter.

Clean or replace the air filter.

Attention

- If dust collects on the air filter it can cause the internal temperature of the projector to rise, and this can lead to problems with operation and shorten the optical engine's service life. Clean the air filter immediately when the message is displayed.
- If the air filter is stained yellow with tobacco smoke, it cannot be cleaned. In this case, replace it with a new air filter.  p.107
- Do not rinse the air filter in water. Do not use detergents or solvents.
- When using a brush for cleaning, use one with long soft bristles, and brush it lightly. If it is brushed too strongly, dust will be ground into the air filter and cannot be removed.

Procedure

1

After you turn off the projector's power and the confirmation buzzer beeps twice, disconnect the power cable.

2

Remove the air filter cover.

Grip the air filter cover tab between your fingers and pull it straight out.

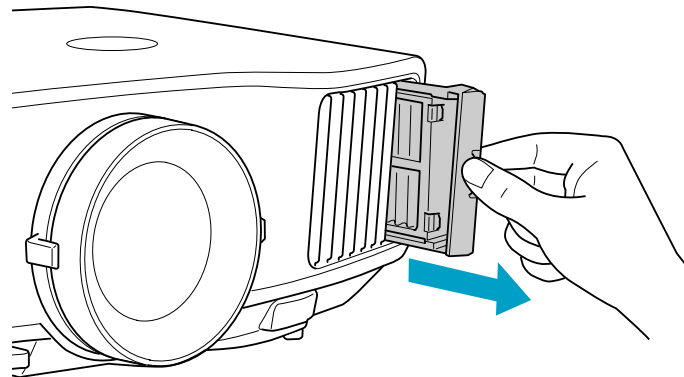

3 Remove the air filter.

Remove the air filter by placing your finger into the groove as shown in the following illustration.

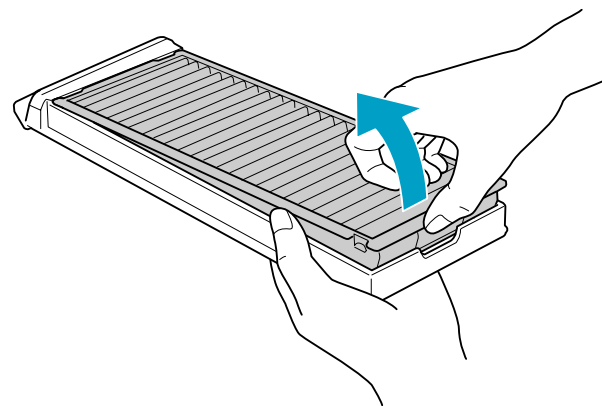

4 With the front (the side with tabs) of the air filter facing down, tap the air filter four or five times to shake off the dust.

Turn it over and tap the other side in the same way.

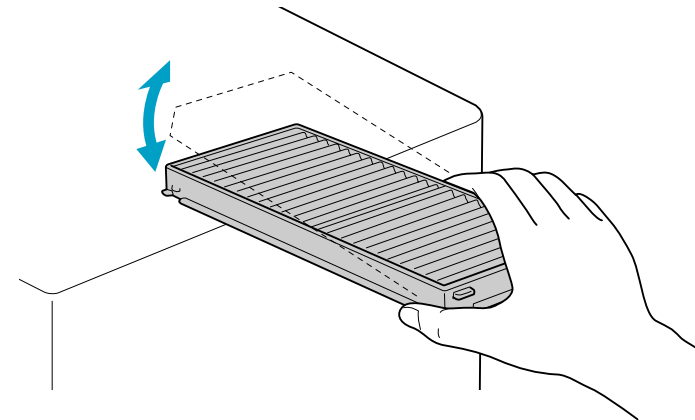

Attention
If the air filter is hit too hard, it may become unusable due to deformities and cracks.

5 Remove any dust remaining on the air filter by using a vacuum cleaner from the front side.

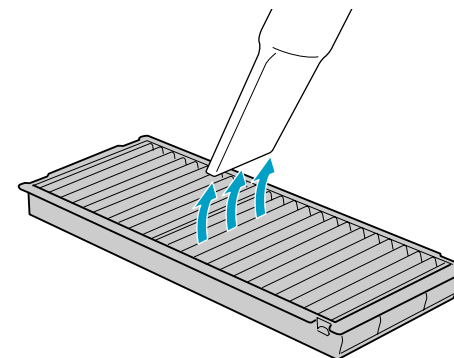

6 Insert the air filter back into the air filter cover.

Insert the tabs on the air filter into the holes in the cover, and press the air filter firmly into place.

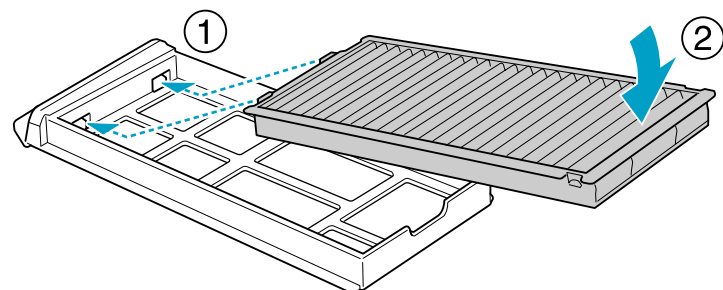

7 Replace the air filter cover.

Press until it clicks into place.

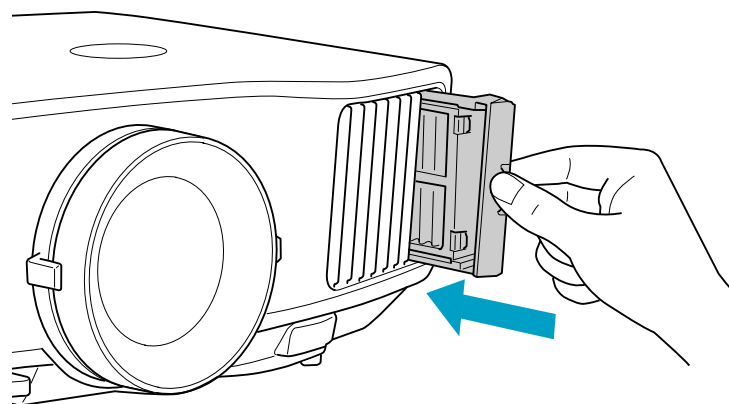

If a message is frequently displayed, even after cleaning, it is time to replace the air filter. Replace it with a new air filter.  [p.107](#)

Replacing the Lamp

Lamp replacement period

It is time to replace the lamp when:

- The message "Replace the lamp." is displayed at the lower left of the projection screen when you start projecting.

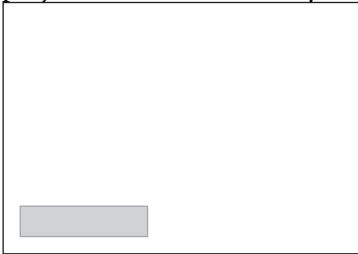

- The lamp indicator flashes orange.

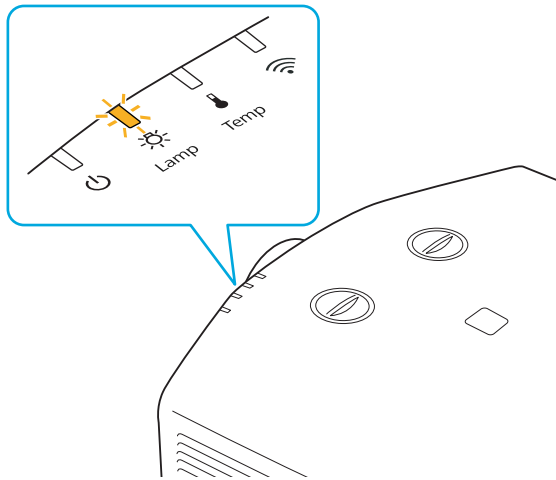



- The projected image gets darker or starts to deteriorate.

Attention

- The lamp replacement message is set to appear after the following time periods in order to maintain the initial brightness and quality of the projected images.
When using **Power Consumption** continually at Normal: About 1900 hours
When using **Power Consumption** continually at ECO: About 2900 hours
- Do not turn the projector on immediately after turning it off. Turning the projector on and off frequently may shorten the life of the lamp.
- If you continue to use the lamp after the replacement period has passed, the possibility that the lamp may explode increases. When the lamp replacement message appears, replace the lamp with a new one as soon as possible, even if it is still working.
- Depending on the characteristics of the lamp and the way it has been used, the lamp may become darker or stop working before the lamp warning message appears. We recommend that you keep a replacement lamp on hand at all times.



We recommend that you clean the air filter whenever you replace the lamp.  [p.101](#)

Replace the air filter if it is discolored or if a message appears even after cleaning the air filter.  [p.107](#)

How to replace the lamp

The lamp can be replaced even when the projector is suspended from a ceiling.

Warning

- When replacing the lamp because they have stopped illuminating, there is a possibility that the lamp may be broken. If replacing the lamp of a projector which has been installed on the ceiling, you should always assume that the lamp is broken, and you should stand to the side of the lamp cover, not underneath it. Remove the lamp cover gently.
- Never disassemble or remodel the lamp. If a remodeled or reassembled lamp is installed into the projector and used, it could cause a fire, electric shock, or an accident.

Caution

Wait until the lamp has cooled down sufficiently before removing the lamp cover. If the lamp is still hot, burns or other injuries may result. It takes about one hour after the power has been turned off for the lamp to be cool enough.

Procedure

1 After you turn off the projector's power and the confirmation buzzer beeps twice, disconnect the power cable.

2 Wait until the lamp has cooled down, then remove the projector's lamp cover.

Loosen the lamp cover fixing screws with the screwdriver supplied with the new lamp or a + head screwdriver, and then remove the lamp cover. Because there is a string attached to the lamp cover to prevent it from falling, it should never fall even when replacing the lamp in a projector installed on the ceiling.

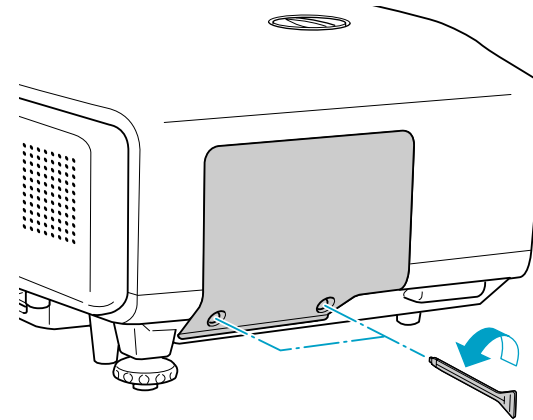

3 Loosen the two lamp fixing screws.

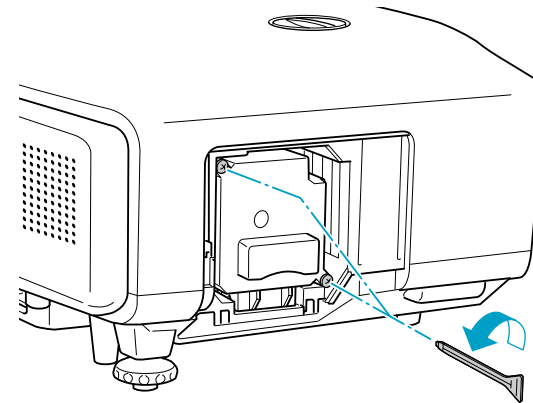

4 Take out the old lamp.

If the lamp is cracked, replace it with a new lamp, or contact your local dealer for further advice.  [Epson Projector Contact List](#)

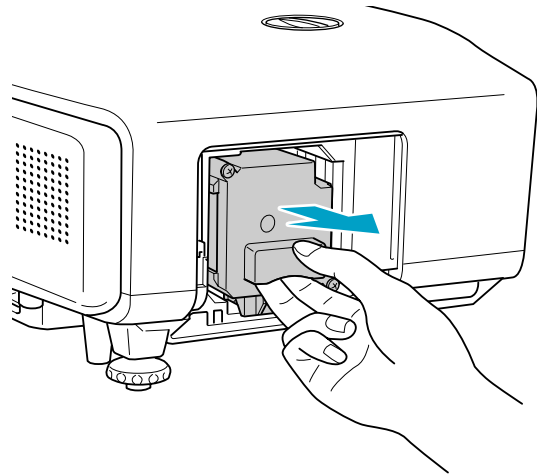

5 Install the new lamp.

Insert the lamp along the guide rail in the correct direction so that it fits in place and press it firmly to the back.

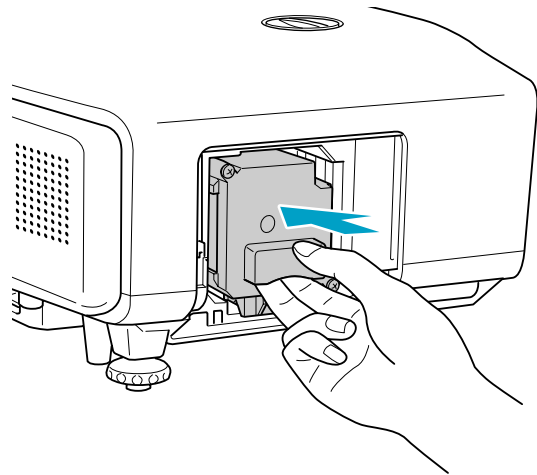

6 Tighten the two lamp fixing screws.

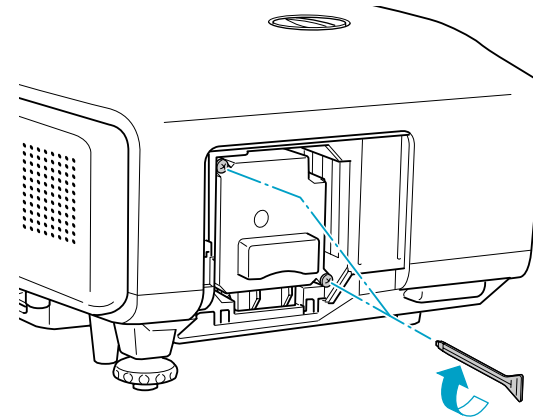

7 Replace the lamp cover.

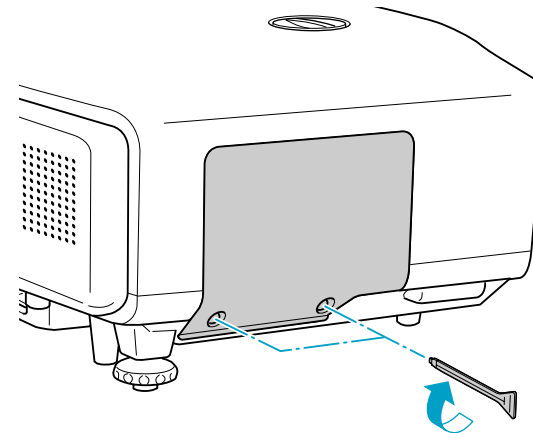

Attention

- Make sure you install the lamp securely. If the lamp cover is removed, the lamp turns off automatically as a safety precaution. If the lamp or the lamp cover is not installed correctly, the lamp will not turn on.
- This product includes a lamp component that contains mercury (Hg). Please consult your local regulations regarding disposal or recycling. Do not dispose of it with normal waste.

Resetting the Lamp Hours

The projector records how long the lamp is turned on and a message and indicator notify you when it is time to replace the lamp. After replacing the lamp, make sure you reset the lamp hours from the Reset Menu.

☛ p.83



Only reset the lamp operating time after the lamp has been replaced. Otherwise, the lamp replacement period will not be indicated correctly.

Replacing the Air Filter

Air filter replacement period

It is time to replace the air filter when:

- The air filter is discolored.
- The message is displayed even though the air filter has been cleaned.

How to replace the air filter

The air filter can be replaced even when the projector is suspended from a ceiling.

Procedure

1 After you turn off the projector's power and the confirmation buzzer beeps twice, disconnect the power cable.

2 Remove the air filter cover.

Grip the air filter cover tab between your fingers and pull it straight out.

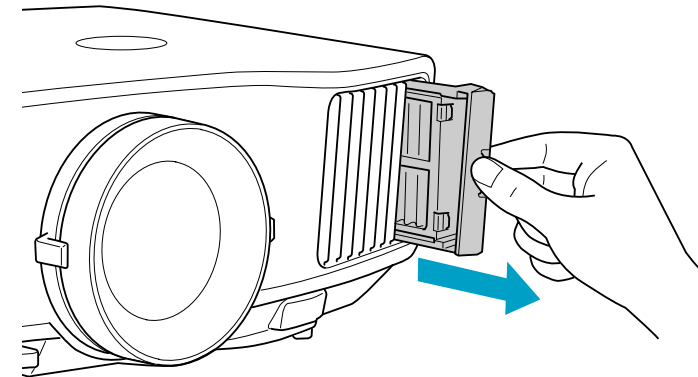

3 Remove the air filter.

Remove the air filter by placing your finger into the groove as shown in the following illustration.

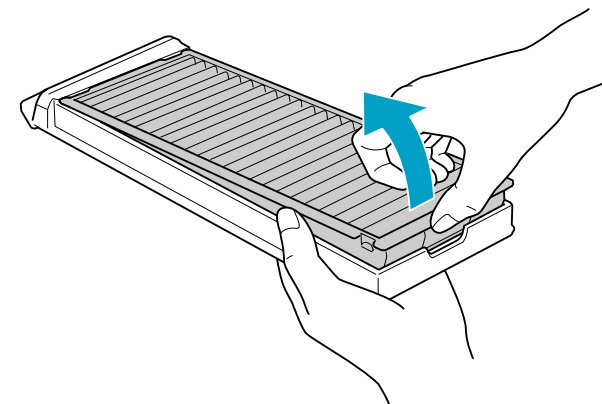

4 Insert the new air filter into the air filter cover.

Insert the tabs on the air filter into the holes in the cover, and press the air filter firmly into place.

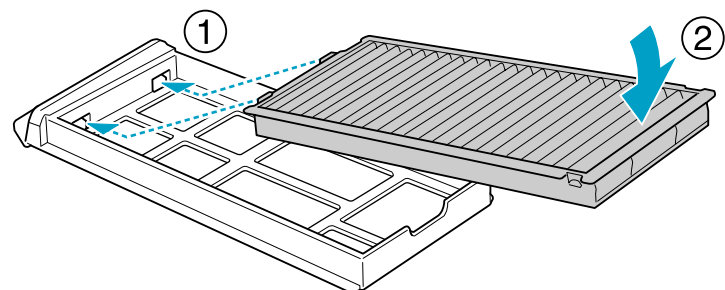

5 Press until it clicks into place.

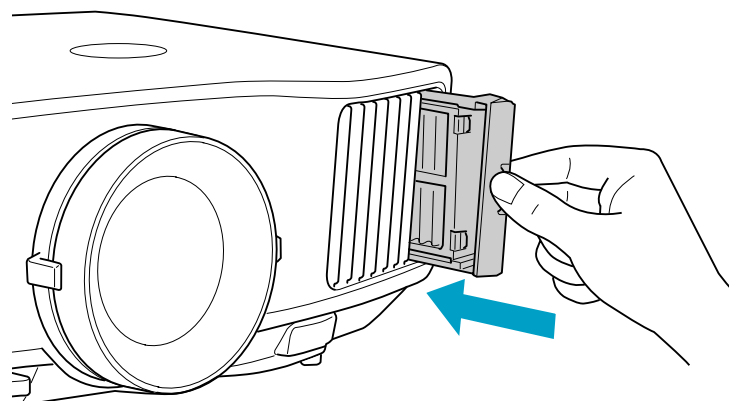

Dispose of used air filters properly in accordance with your local regulations.

Material quality of the frame section: Polypropylene

Material quality of the filter section: Polypropylene

There are many glass parts and precision components inside the projector. To prevent damage due to impacts when transporting, handle the projector as follows.

Moving Nearby

Checking the following points, and then carry carefully by the handles.

- Turn off the power to the projector and disconnect all cables.
- Attach the lens cover to the lens.
- Store the foot.

When Transporting

Preparing packaging

After checking the points in "Moving Nearby", prepare the following and then pack up the projector.

- Set the vertical lens shift to the lowest position.  [p.22](#)
- Fit the protective lens pad that was used at the time of purchase.

Notes when packing and transporting

Enclose the projector securely in buffer material to protect it from shock, and place it into a strong cardboard container. Be sure to notify the carrier company that the contents are fragile.



Monitoring and Controls

This chapter explains the functions that can be used to monitor and control the projector.

EasyMP Monitor lets you carry out operations such as checking the statuses of multiple Epson projectors that are connected to a network at a computer monitor, and controlling the projectors from the computer.

Download the EasyMP Monitor software from the following website.

<http://www.epson.com>

Following are brief descriptions of the monitoring and control functions that can be carried out using EasyMP Monitor.

- **Registering projectors for monitoring and control**

Projectors on the network can be searched for automatically, and you can then select projectors to be registered from the projectors that are detected.

You can enter the IP addresses for target projectors to register them.

- **Registered projectors can also be assigned to groups so that they can be monitored and controlled in groups.**

- **Monitoring the statuses of registered projectors**

The power status (ON/OFF) for projectors and problems or warnings requiring attention can be checked visually by means of icons.

You can select groups of projectors or a single projector that you are interested in, and then check the cumulative lamp operating time or the details of information such as input sources, problems, and warnings for these projectors.

- **Controlling registered projectors**

Projectors can be selected in groups or as single projectors, and you can then carry out operations for the selected projectors such as turning the power on and off and switching their input sources.

Web Control functions can be used to change the settings in the projector's configuration menu.

If there are certain control actions which are carried out regularly at particular times or on particular days, you can use Timer Settings to register timer settings.

- **Mail Notification settings**

You can set e-mail addresses to which notifications are sent if a status requiring attention, such as a problem, occurs with a projector that has been registered.

- **Sending messages to registered projectors**



The Message Broadcasting plugin for EasyMP Monitor can be used to send JPEG files to registered projectors.

Download the Message Broadcasting plugin from the website given at the beginning of this chapter.

You can make Configuration menu settings and control the projector by using the Web browser of a computer that is connected to the projector via a network. Setup and control operations can be performed remotely if this function is used. In addition, since you can use the computer's keyboard, entering characters required for the setup is easier.

Use Microsoft Internet Explorer 6.0 or later as the Web browser. If using a Mac OS, use Safari or Firefox.



- Use the Advanced mode when connecting with a wireless LAN. (EB-G5950/G5650W)  [p.70](#)
- Setup and control with a Web browser are possible if **Standby Mode** is set to **Communication On** from the **Extended** menu of the projector's Configuration menu, even if the projector is in standby state (when the power is off).  [p.61](#)

Some items cannot be set with a Web browser (but can be set from the Configuration Menu) and some items can be set only with a Web browser.

Items in the Configuration menu that cannot be set by the web browser

- Items related to password settings
- All items on the Reset menu
- The following items on the Settings menu
Quick Corner, Pointer Shape, User Button, and Test Pattern
- The following items on the Extended menu
User's Logo, High Altitude Mode, BNC Sync Termination, Remote Control Type, and Language

Items that can only be set in the Web browser

- Community Name
- Monitor Password

Displaying Web Control

Use the following procedure to display Web Control.



If your Web browser is set up to connect via a proxy server, Web Control cannot be displayed. To use Web Control, you need to make network connection settings with a device other than a proxy server.

Procedure

1

Start the Web browser on the computer.

2

Enter the IP address of the projector in the address input box of the Web browser, and press the [Enter] key on the computer's keyboard.

Web Control is displayed.

When Web Control Password is set in the Network menu from the projector's Configuration Menu, enter the Password. Enter **EPSONWEB** as the user name. Enter the characters set for the web control password as the password.

Displaying Web Remote

The Web Remote function allows you to perform projector remote control operations from a Web browser.

Procedure

1

Display Web Control.  ["Displaying Web Control" p.112](#)

2

Click Web Remote.



3 The Web Remote screen appears.

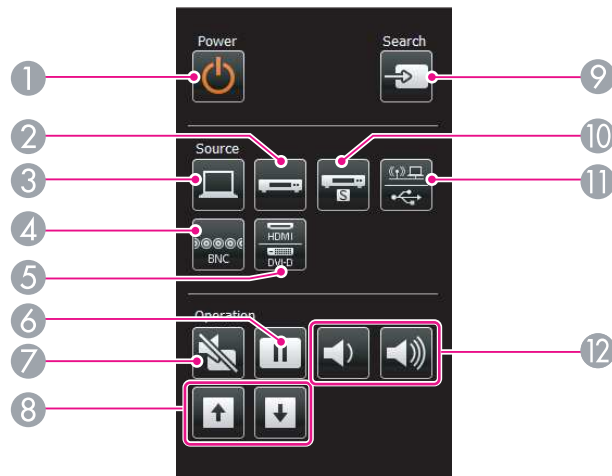

Name	Function
1 [⏻] button	Turns the projector power On or Off.
2 [Video1/2] button	The input source alternates between Video1 and Video2 each time you click. (EB-G5950/G5900/G5650W/G5600) The input source will change to Video1 . (EB-G5800/G5500)
3 [Comp1/2] button	The input source alternates between Computer1 and Computer2 each time you click. (EB-G5950/G5900/G5650W/G5600) The input source will change to Computer1 . (EB-G5800/G5500)

Name	Function
4 [BNC] button	The input source will change to BNC .
5 [DVI-D/HDMI] button	The input source will change to HDMI . (EB-G5950/G5900/G5650W/G5600 only)
6 [Freeze] button	Images are paused or unpaused. 🖱️ p.38
7 [A/V Mute] button	Temporarily turns the audio and video on or off. 🖱️ p.38
8 [Page] buttons [⏪][⏩]	These buttons can be used to page up and down when projecting an image from a computer that is connected to the projector through the network. These buttons can be used to switch the screen when projecting with PC Free. (EB-G5950/G5650W only)
9 [Search] button	Changes to the next input source that is connected to the projector and is sending an image. 🖱️ p.27
10 [S-Video] button	The input source will change to S-Video . (EB-G5950/G5900/G5650W/G5600 only)
11 [LAN/USB] button	The input source alternates between LAN and USB each time you click. (EB-G5950/G5650W only)
12 [Volume] buttons (🔊) (🔊)*	(🔊) Decreases the volume. (🔊) Increases the volume.

*Not displayed for the EB-G5800/G5500.

By setting the **Mail Notification** function from the projector's Configuration Menu, notification messages will be sent to the preset email addresses when a problem or warning occurs with a projector. This will enable the operator to be notified of problems with projectors even at locations away from the projectors.

EB-G5900/G5800/G5600/G5500

☛ Network Menu - Mail [p.64](#)

EB-G5950/G5650W

☛ Network Menu - Mail Menu [p.79](#)



- Up to a maximum of three notification destinations (Addresses) can be recorded, and notification messages can be sent to all three destinations at once.
- If a projector develops a critical problem and suddenly stops working, it may not be able to send a message notifying an operator of the problem.
- Monitoring is possible if **Standby Mode** is set to **Communication On** from the **Extended** menu of the projector's Configuration Menu, even if the projector is in standby state (when the power is off).
☛ [p.61](#)

Reading Problem Mail Notification Function

When the **Mail Notification** function is set to **On** and a problem/warning occurs in the projector, the following e-mail is sent.

Subject: EPSON Projector

Line 1: The name of the projector where the problem has occurred

Line 2: The IP address set for the projector where the problem has occurred.

Line 3 and on: Details of the problem

The details of the problem are listed line by line. The following table shows the details that are given in the message for each item. To deal with problems/warnings, see "Reading the Indicators" ☛ [p.87](#)

Message	Cause (Problems/Warnings)
Clean Air Filter	Air Filter Notice
Fan related error	Fan Error
High-speed cooling in progress	High Temp Warning
Internal error	Internal Error
Internal temperature error	High Temp Error (Overheating)
Lamp cover is open.	Lamp Cover Open
Lamp out	Lamp Error
Lamp replacement notification	Replace Lamp
Lamp timer failure	Lamp Failure
Low Air Flow	Low Air Flow
Low Air Flow Error	Filter Airflow Error
No-signal	No Signal No Signal is input to the projector. Check the connection status or check that the power for the signal source is turned on.
Power Err. (Ballast)	Power Err. (Ballast)
Sensor error	Sensor Error

A (+) or (-) appears at the start of the message.

(+): A projector problem has occurred

(-): A projector problem has been dealt with

By setting **SNMP** from the projector's configuration menu, notification messages are sent to preset e-mail addresses when a problem or warning occurs with a projector. This is useful when controlling projectors centrally at a point distant from them.

EB-G5950/G5900/G5650W/G5600  [p.64](#)

EB-G5950/G5650W  [p.80](#)



- SNMP should be managed by a network administrator or someone who is familiar with the network.
- To use the SNMP function to monitor the projector, you need to install the SNMP manager program on your computer.
- The managing function using SNMP cannot be used via Wireless LAN in Quick Connection Mode. (EB-G5950/G5650W)
- Up to two destination IP addresses can be saved.

Serial Connection

- Connector shape: D-Sub 9-pin (male)
- Projector input port name: RS-232C

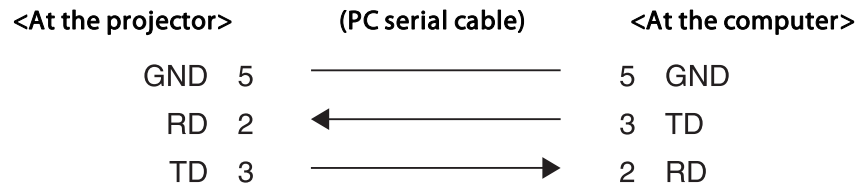
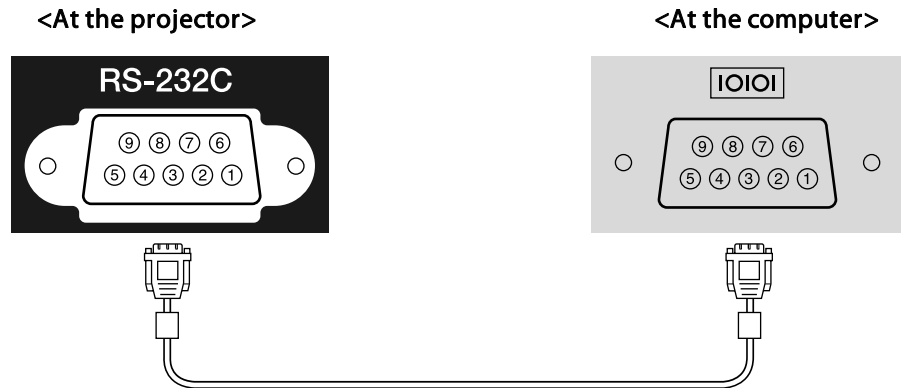

Signal Name	Function
GND	Signal wire ground
TD	Transmit data
RD	Receive data

Communications protocol

- Default baud rate setting: 9600 bps
- Data length: 8 bit

- Parity: None
- Stop-bit: 1 bit
- Flow control: None

Command List

When the power ON command is transmitted to the projector, the power turns on and it enters warm-up mode. When the projector's power has turned on, a colon ":" (3Ah) is returned.

When a command is input, the projector executes the command and returns a ":", and then accepts the next command.

If the command being processed terminates abnormally, an error message is output and a ":" is returned.

Item		Command	
Power ON/OFF	On	PWR ON	
	Off	PWR OFF	
Signal selection	Computer1	Auto	SOURCE 1F
		RGB	SOURCE 11
		Component	SOURCE 14
	Computer2*1	Auto	SOURCE 2F
		RGB	SOURCE 21
		Component	SOURCE 24
	BNC	Auto	SOURCE BF
		RGB	SOURCE B1
		Component	SOURCE B4
HDMI*1		SOURCE 30	
Video1		SOURCE 45	
Video2*1		SOURCE 41	

	Item	Command
	S-Video*1	SOURCE 42
	USB*2	SOURCE 52
	LAN*2	SOURCE 53
A/V Mute On/Off	On	MUTE ON
	Off	MUTE OFF
A/V Mute selection	Black	MSEL 00
	Blue	MSEL 01
	User's Logo	MSEL 02

*1 EB-G5950/G5900/G5650W/G5600 only

*2 EB-G5950/G5650W only

Add a Carriage Return (CR) code (0Dh) to the end of each command and transmit.

PJLink Class1 was established by the JBMIA (Japan Business Machine and Information System Industries Association) as a standard protocol for controlling network-compatible projector's as part of their efforts to standardize projector control protocols.

The projector complies with the PJLink Class1 standard established by the JBMIA.

It complies with all commands except for the following commands defined by PJLink Class1, and agreement was confirmed by the PJLink standard adaptability verification.

URL:<http://pjlink.jbmia.or.jp/english/>

• **Non-compatible commands**

Function	PJLink Command
Image muting set	AVMT 11
Audio muting set	AVMT 21

• **Input names defined by PJLink and corresponding projector sources**

Source	PJLink Command
Computer1	INPT 11
Computer2*1	INPT 12
BNC	INPT 13
Video1	INPT 23
Video2*1	INPT 21
S-Video*1	INPT 22
HDMI*1	INPT 32
USB*2	INPT 41
LAN*2	INPT 52

*1 EB-G5950/G5900/G5650W/G5600 only

*2 EB-G5950/G5650W only

- Manufacturer name displayed for "Manufacture name information query"
EPSON
- Model name displayed for "Product name information query"
EB-G5950
EB-G5900
EB-G5800
EB-G5650W
EB-G5600
EB-G5500

Crestron RoomView® is an integrated control system provided by Crestron®. It can be used to monitor and control multiple devices connected on a network.

The Projector supports the control protocol, and can therefore be used in a system built with Crestron RoomView®.

Refer to the Crestron® website for details on Crestron RoomView®. (Only English-language displays are supported.)

<http://www.crestron.com>

An overview of Crestron RoomView® is provided below.

- **Remote operation using a Web browser**

A Projector can be operated from a computer window just like using a remote control.



- **Monitoring and control with application software**

Crestron RoomView® Express or Crestron RoomView® Server Edition provided by Crestron® can be used to monitor devices in the system, to communicate with the help desk, and to send emergency messages. Refer to the following website for details.

<http://www.crestron.com/getroomview>

This manual describes operating procedures in the computer window using a Web browser.





- Only single-byte alphanumeric characters and symbols can be entered.
- The following functions cannot be used while using the Crestron RoomView®.
 - Web Control  [p.112](#)
 - Message Broadcasting (EasyMP Monitor plugin)
- Controlling is possible if **Standby Mode** is set to **Communication On** from the **Extended** menu of the projector's configuration menu, even if the projector is in standby state (when the power is off).
 -  [p.61](#)

Operating a Projector from a Computer Window

Displaying the operation window

Confirm the following before performing the procedure.

- Make sure the computer and projector are connected to the network. When communicating with a wireless LAN, connect in Advanced mode.
 -  [p.70](#)
- Set **RoomView** to **On** on the **Others** menu under the **Network** menu.
 -  [p.80](#)

Procedure

1

Start the Web browser on the computer.

2

Enter the IP address of the projector in the address field of the Web browser, and press the [Enter] key on the keyboard.

The operation window will be displayed.

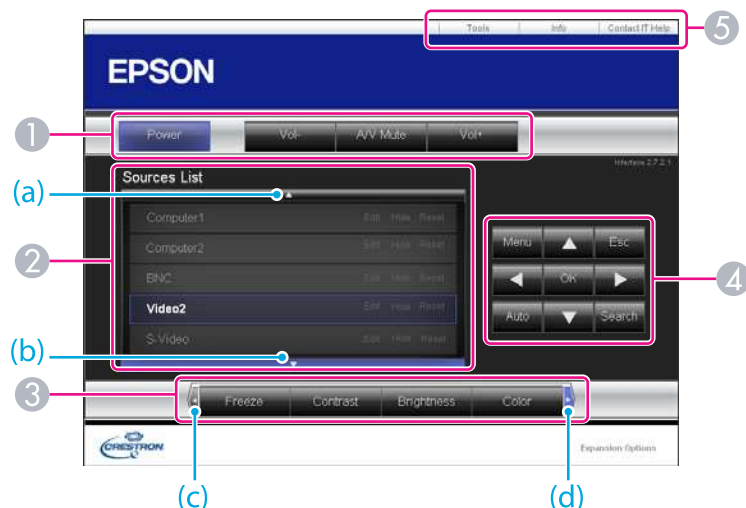

Using the operation window





- 1 The following operations will be performed when the buttons are clicked.

Button	Function
Power	Turns the projector power on or off.
Vol-/Vol+	Adjust the volume.
A/V Mute	Turns the video and audio on or off.  p.38

- 2 Switch to the image from the selected input source. To display input sources that are not shown in the window, click (a) or (b) to scroll up or down. The current video signal input source is displayed in blue.
- 3 The following operations will be performed when the buttons are clicked. To display buttons that are not shown in the window, click (c) or (d) to scroll left or right.

Button	Function
Freeze	Images are paused or unpaused.  p.38
Contrast	Adjusts the difference between light and shade in the images.
Brightness	Adjusts the image brightness.
Color	Adjusts the color saturation for the images.
Sharpness	Adjusts the image sharpness.
Zoom	Click the [⊕] button to enlarge the image without changing the projection size. Click the [⊖] button to reduce an image that was enlarged with the [⊕] button. Click the [▲], [▼], [◀], or [▶] button to change the position of an enlarged image.  p.40

- 4 Clicking the [▲], [▼], [◀], or [▶] button performs the same operation as the [⊕] button on the remote control. The following operations will be performed when the other buttons are clicked.

Button	Function
OK	Performs the same operation as the [Enter] button on the remote control.  p.16
Menu	Displays and closes the configuration menu.
Auto	If clicked when the computer analog RGB signals are being projected, automatically optimizes the image by adjusting the Tracking, Sync., and Zoom Position.
Search	Switches to the image from the input port where video signals are being input.  p.27
Esc	Performs the same operation as the [Esc] button on the remote control.  p.16

- 5 The following operations will be performed when the tabs are clicked.

Tab	Function
Contact IT Help	Displays the Help Desk window. Used to send and receive messages to the administrator using Crestron RoomView® Express.
Info	Displays information on the projector that is currently connected.
Tools	Changes the settings in the projector that is currently connected. Refer to the next section.

Using the tools window

The following window will be displayed if the **Tools** tab is clicked in the operation window. This window is used to change the settings in the projector that is currently connected.

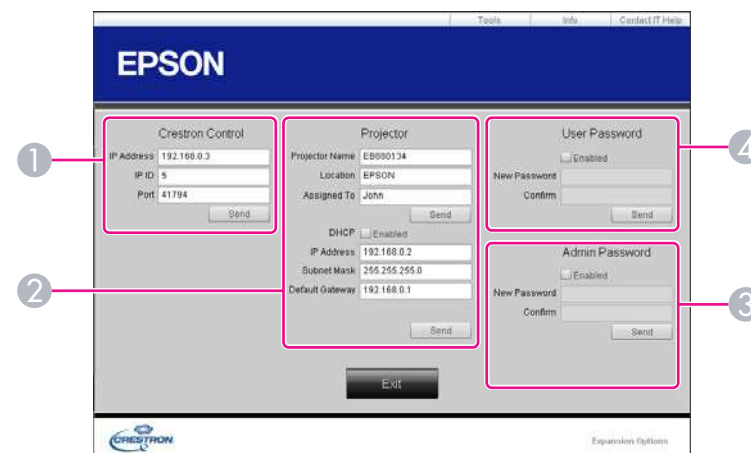

- ① **Crestron Control**
Makes settings for Crestron® central controllers.
- ② **Projector**
The following items can be set.
- ③ **Admin Password**
New Password
Confirm
- ④ **User Password**
New Password
Confirm

Item	Function
Projector Name	Enter a name to differentiate the projector that is currently connected from other projectors on the network. (The name can contain up to 15 single-byte alphanumeric characters.)
Location	Enter an installation location name for the projector that is currently connected on the network. (The name can contain up to 32 single-byte alphanumeric characters and symbols.)
Assigned To	Enter a user name for the projector. (The name can contain up to 32 single-byte alphanumeric characters and symbols.)



Item	Function
DHCP	Select the Enabled check box to use DHCP. The following address cannot be set if DHCP is enabled.
IP Address	Enter the IP address to assign to the currently connected projector.
Subnet Mask	Enter a subnet mask for the projector that is currently connected on the network.
Default Gateway	Enter the gateway address for the currently connected projector.
Send	Click this button to commit changes made to the Projector .

Item	Function
New Password	Enter the new password when changing the password to open the operation window. (The password can contain up to 26 single-byte alphanumeric characters.)
Confirm	Enter the same password as you entered in New Password . If the passwords are not the same, an error will be displayed.
Send	Click this button to commit changes made to the User Password .

3 Admin Password

Select the **Enabled** check box to require a password to open the Tools window. The following items can be set.

Item	Function
New Password	Enter the new password when changing the password to open the Tools window. (The password can contain up to 26 single-byte alphanumeric characters.)
Confirm	Enter the same password as you entered in New Password . If the passwords are not the same, an error will be displayed.
Send	Click this button to commit changes made to the Admin Password .

4 User Password

Select the **Enabled** check box to require a password to open the operation window on the computer. The following items can be set.



Network Functions (EB-G5950/G5650W Only)

This chapter explains the additional functions for networks.

"Connect to a Network Projector" is a standard function in Windows Vista and Windows 7. You can project images from the computer by detecting the projector on the network only by using a function of the OS without having to install any special software.

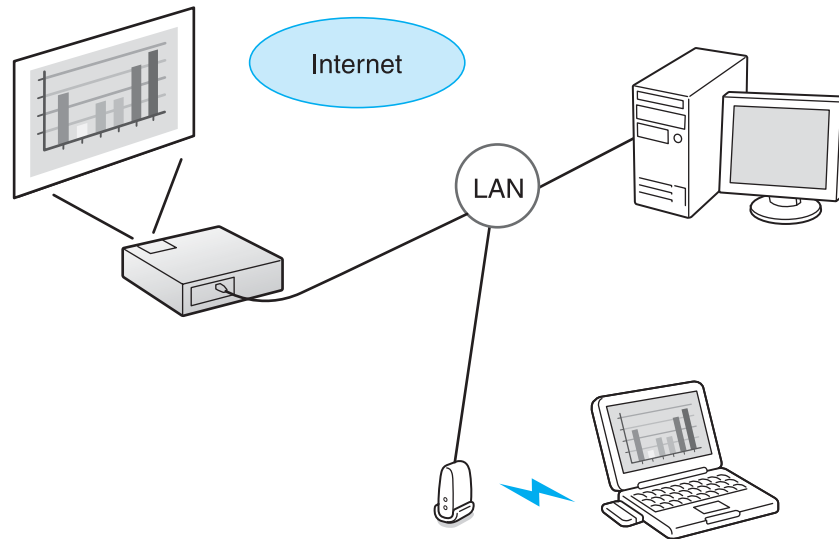

Compatible OS

Windows Vista:Home Premium/Business/Enterprise/Ultimate
Windows 7:Professional/Ultimate

This section provides an easy explanation of "Connect to a Network Projector".

Check that the projector and computer are connected to the network, and carry out the following operations.

Procedure

- 1 Turn the projector on and switch the input source to LAN.
☛ "Changing the Projected Image" p.27

- 2 On the computer, start Windows, and then click "Start" - "All programs" - "Accessories" - "Connect to a Network Projector".

The connection setting screen is displayed.

The projector is identified by inputting its IP address, or by allowing the OS to automatically identify all of the connected projectors.

- 3 Once the OS has identified all of the connected projectors, select the one that you want to use and click "Connect".

When the projector password screen is displayed, enter the keyword shown at the bottom of the LAN standby screen.



- You can connect only one projector to a computer.
- Audio is not transmitted. When outputting computer audio from the projector, connect the computer's audio output port to the Audio1 input port, Audio2 input port, or Audio3 input port on the projector using a commercially available audio cable. Set the LAN **Audio Input** setting on the **Settings** menu to the port to which the audio cable is connected. ☛ p.59
- When using Network Projector from Options in Windows Meeting Space, set the colors for the computer screen you are using to the highest level (32bit). If it is not capable of a 32bit display, a message is displayed and you cannot connect.

There are two methods for setting WPS▶▶.

- Push Button Method
 SSID and security are set automatically when the [Enter] button is pressed on the projector's control panel and the dedicated button on the access point equipment. This method is recommended when the projector and access point are close together.
- PIN Code Method
 SSID and security are set automatically by inputting an 8-digit code that was assigned to the projector from the computer to the access point in advance. Make connection settings between the computer and the access point in advance. For details on how to make this connection, refer to the manual provided with the access point. This method is recommended when the projector is mounted on the ceiling.

 Refer to the documentation for the access point device and to the following section when using any connection method other than WPS.
 🖱️ "Wireless LAN Menu" p.70

Connection Setup Method

Procedure

- 1 During projection, press the [Menu] button and select "Network" - "Network Configuration" from the configuration menu.

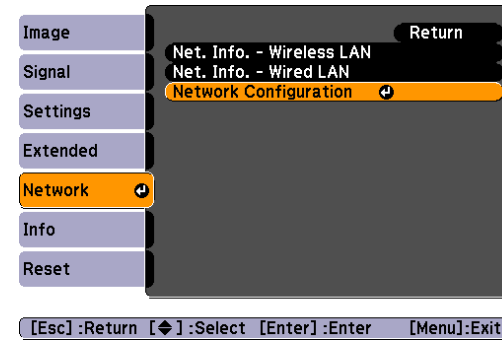

The Network Configuration screen is displayed.

2

From "Wireless LAN" select "To Setup Wizard".



The following screen is displayed.

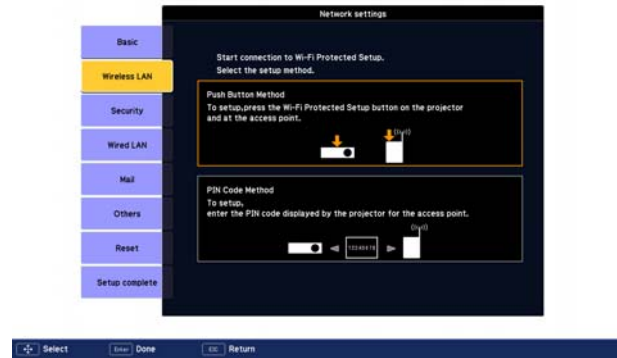

When connecting using the Push Button Method, follow the steps given below.

Go to "Making a connection using the PIN Code Method" when connecting using the "PIN Code Method". [p.127](#)

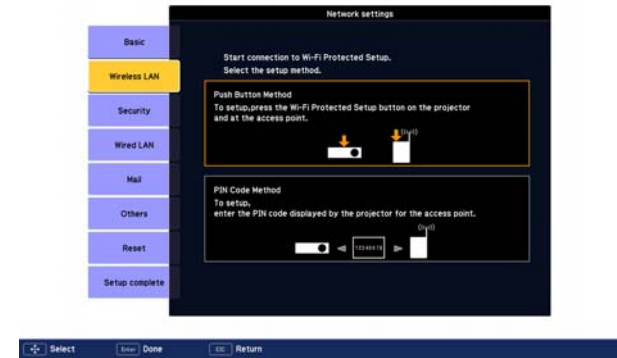

The Push Button Method screen is displayed.

2

Press the [Enter] button on the projector's control panel when prompted by the screen.

Making a connection using the push button method

Procedure

1

Select "Push Button Method".



Then, the Push Button Method screen is displayed.

3

Press the button on the access point when prompted by the screen.

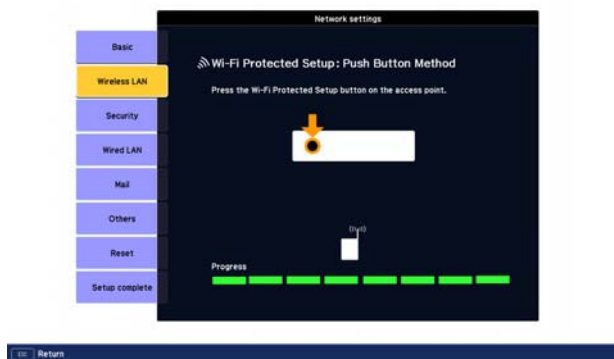

This completes the setup.

- 4 Press the [Enter] button or the [Esc] button.

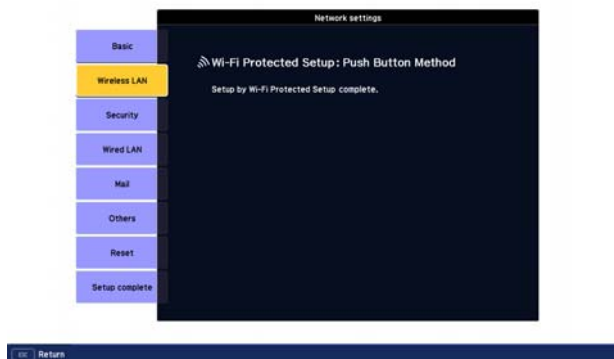

It returns to the Wireless LAN menu screen.

- 5 Select "Setup complete" - "Yes."



This completes the setup of the connection between the projector and the access point. Press the [Menu] button to close the configuration menu.

Making a connection using the PIN Code Method



Before you can make a connection using the "PIN Code Method", a connection must have already been setup between the computer and the access point.

Procedure



- 1 Select "PIN Code Method".

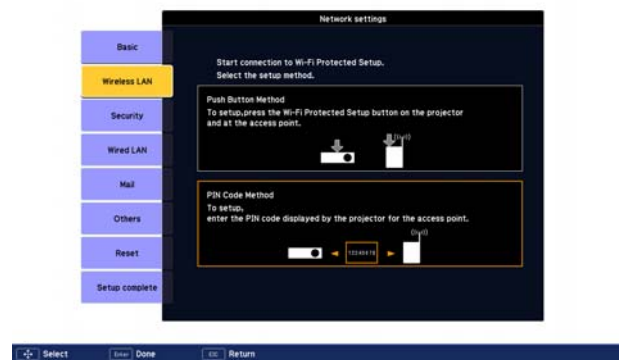

The PIN Code Method screen is displayed.

2

Enter the PIN code displayed on the "PIN Code Method" screen from the computer to the access point, and then select "Start Setup".



The progress is displayed.



3

The message "Setup by Wi-Fi Protected Setup complete." is displayed. Press the [Enter] button or the [Esc] button.



It returns to the Wireless LAN menu screen.

4

Select "Setup complete" - "Yes."



This completes the setup of the connection between the projector and the access point. Press the [Menu] button to close the configuration menu.



Installation and Connections

This chapter explains the projection installation methods and methods to connect to other equipment.

The projector can be mounted on a ceiling or placed on a desk as shown below.

Warning

- A special method of installation is required when suspending the projector from a ceiling (ceiling mount). If installation work is not carried out correctly, the projector could fall down. This may result in injury or accidents. Contact your dealer or the nearest address provided in the Support and Service Guide if you want to use this installation method.  [Epson Projector Contact List](#)
- If you use adhesives on the Ceiling mount fixing points to prevent the screws from loosening, or if you use things such as lubricants or oils on the projector, the projector case may crack causing it to fall from its ceiling mount. This could cause serious injury to anyone under the ceiling mount and could damage the projector. When installing or adjusting the ceiling mount, do not use adhesives to prevent the screws from loosening and do not use oils or lubricants and so on.

Attention

- Do not use the projector on its side. This may cause malfunctions to occur.

- Suspend the projector from the ceiling and project images from in front of a screen. (Front/Ceiling projection)

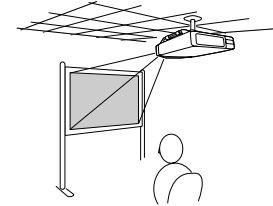

- Suspend the projector from the ceiling and project images from behind a translucent screen. (Rear/Ceiling projection)

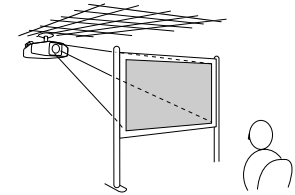

- Project images from in front of the screen. (Front projection)

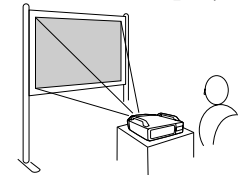

- Project images from behind a translucent screen. (Rear projection)

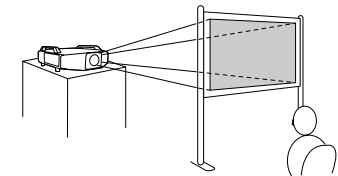

- An optional ceiling mount is required when suspending the projector from a ceiling.  "Optional Accessories and Consumables" p.147

Switching the Projection Mode

Switch the **Projection** mode according to the installation condition so that a suitable projected image is obtained.

Procedure

During projection, hold down the [A/V Mute] button on the remote control for about five seconds.

Each time this button is pressed for at least 5 seconds, the **Projection** setting will switch between **Front** and **Front/Ceiling**. The orientation of the projected image will change accordingly.

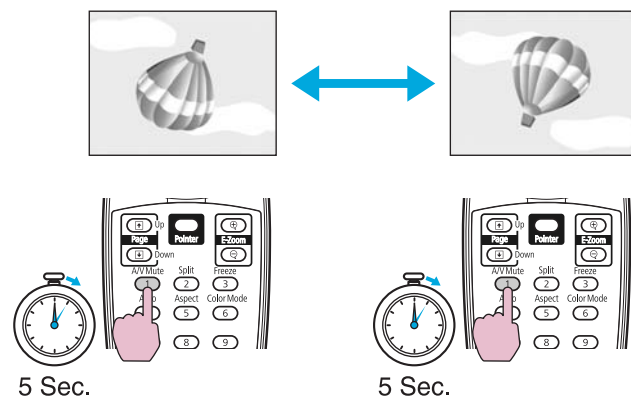

To set **Rear** or **Rear/Ceiling**, use the **Projection** setting on the **Configuration** menu. [p.61](#)



When suspending the projector from a ceiling, set the **Inv Direction Button** on the **Configuration** menu to **On** so that the [▲], [▼], [◀], and [▶] buttons on the control panel operate in the correct directions. **Extended Menu - Operation - Inv Direction Button**
[p.61](#)

Observe the following precautions when connecting the projector to external equipment. Be sure to also read the documentation for the external equipment.

Attention

- Turn off the projector and the external equipment. The projector or external equipment may fail if they are connected while the power is on.
- Check the shapes of the cable connector and port before connecting them. If connecting them is attempted in the wrong direction or when they do not match, failure or equipment damage may occur.

Connecting to a Computer

This section provides examples of connecting the projector to a computer. Depending on the model, the interfaces may differ. 🖱️ "Interface" [p.12](#)
 The computer port and cable names may also be different from those given. The EB-G5800/G5500 does not support inputting or outputting audio.





Refer to the following when projecting images from a computer that is connected through a network. (EB-G5950/G5650W only)





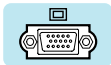
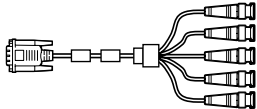
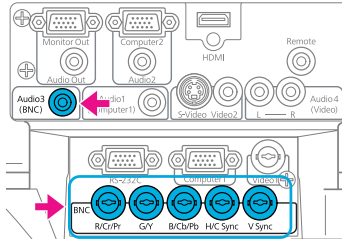

Projecting with the EasyMP Network Projection application software (provided with the projector) 🖱️ [EasyMP Network Projection Operation Guide](#)



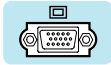
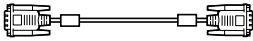
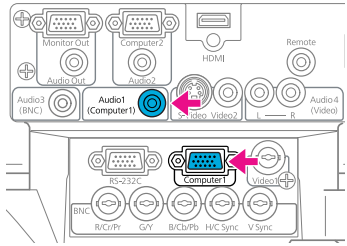

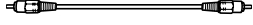
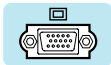
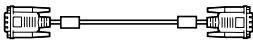
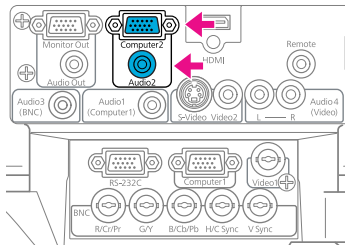
Projecting with the EasyMP Multi PC Projection application software (provided with the projector) 🖱️ [EasyMP MultiPC Projection Operation Guide](#)

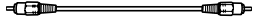
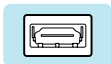
Projecting with the "Connect to a Network Projector" function provided with Windows Vista or Windows 7 🖱️ [p.124](#)

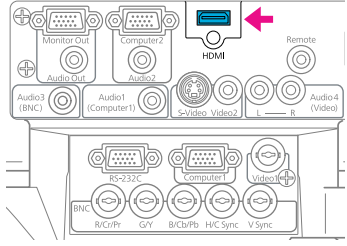
Projecting with Quick Wireless Connection using the optional Quick Wireless Connection USB Key 🖱️ [User's Guide for the optional product](#)

	Computer port	Connecting cable	Projector port
Connection 1	Monitor Out port 	5BNC display cable (commercially available) 	
	Audio Out port 	Audio cable (commercially available) 	

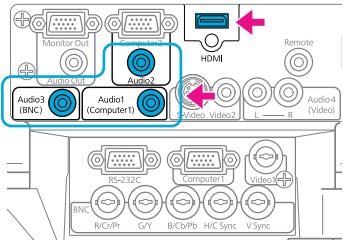
	Computer port	Connecting cable	Projector port
Connection 2	Monitor Out port 	Computer cable (supplied) 	Computer1 input port Audio1 input port 
	Audio Out port 	Audio cable (commercially available) 	
Connection 3	Monitor Out port 	Computer cable (supplied) 	Computer2 input port Audio2 input port 
	Audio Out port 	Audio cable (commercially available) 	
Connection 4	HDMI output 	HDMI cable (commercially available) 	HDMI input port 

	Computer port	Connecting cable	Projector port
Connection 5	DVI-D output 	DVI/HDMI conversion cable (commercially available) 	HDMI input port Audio1 input port/Audio2 input port/Audio3 input port* 
	Audio Out port 	Audio cable (commercially available) 	

* It does not matter if you connect to the Audio1 input port, Audio2 input port, or Audio3 input port. Set the **HDMI Audio Input** setting on the **Settings** menu to the port to which the audio cable is connected.  [p.59](#)



- Use a cable that complies with the HDMI standard for the HDMI cable.
- A commercially available adapter may be required to connect to a Macintosh computer.

Changing the video output from a laptop computer.

When projecting images from a laptop computer connected to the projector with a computer cable, the output for the video signal must sometimes be changed at the computer. Refer to the documentation for your computer for the method to change the video output.









• Example of changing the output (Windows computers)

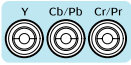
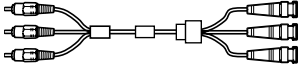
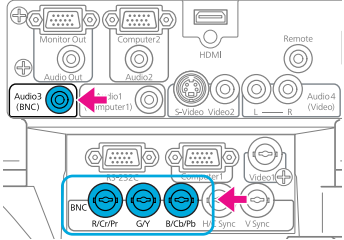
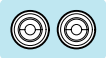
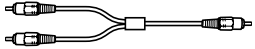

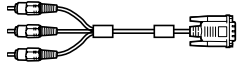
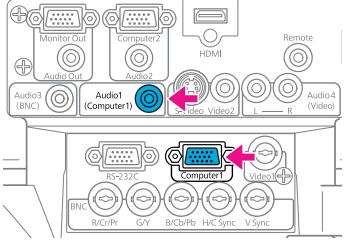

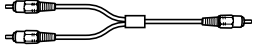

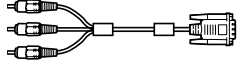
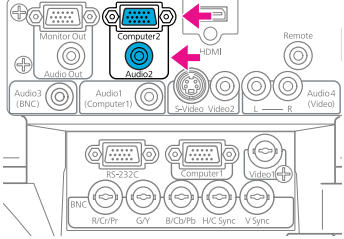

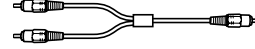

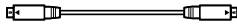
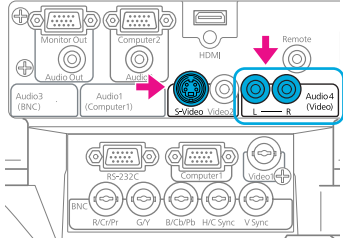
Hold down the [Fn] key on your computer and press the function key labeled CRT/LCD, , and so on. If the image is not displayed on your computer monitor, press the same keys again.

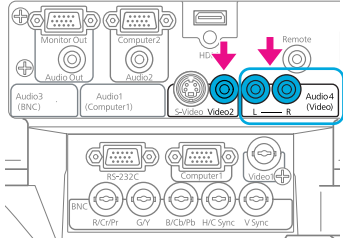

Connecting to Video Equipment

This section provides examples of connecting the projector to video equipment. Depending on the model, the interfaces may differ.  "Interface" [p.12](#)

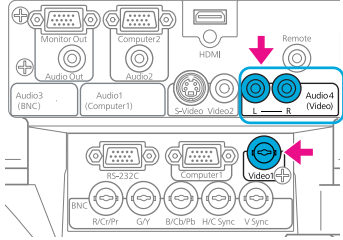
The video equipment port and cable names may also be different from those given. The EB-G5800/G5500 does not support inputting or outputting audio.

	Port on the video equipment	Connecting cable	Projector port
Connection 1	Component outputs 	RCA component video cable (commercially available) + BNC/RCA adapter (commercially available) 	BNC input port (R/Cr/Pr, G/Y, B/Cb/Pb) Audio3 input port 
	Audio Out port 	Audio cable (commercially available) 	
Connection 2	Component outputs 	Component cable (D-sub/component conversion) (optional accessory) 	Computer1 input port Audio1 input port 
	Audio Out port 	Audio cable (commercially available) 	
Connection 3	Component outputs 	Component cable (D-sub/component conversion) (optional accessory) 	Computer2 input port Audio2 input port 
	Audio Out port 	Audio cable (commercially available) 	

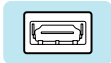
	Port on the video equipment	Connecting cable	Projector port
Connection 4	S-Video output 	S-Video cable (commercially available) 	S-Video input port Audio4 input port 
	Audio Out port 	Audio cable (commercially available) 	
Connection 5	Video output 	Video cable (commercially available) 	Video2 input port Audio4 input port 
	Audio Out port 	Audio cable (commercially available) 	
Connection 6	Video output 	BNC video cable (commercially available) 	Video1 input port Audio4 input port 
	Audio Out port 	Audio cable (commercially available) 	

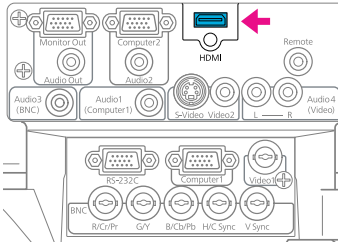
	Port on the video equipment	Connecting cable	Projector port
Connection 7	HDMI output 	HDMI cable (commercially available) 	HDMI input port 



- Set the input signal and video signal on the Signal menu according to the signal from the connected equipment. [p.57](#)
- Use a cable that complies with the HDMI standard for the HDMI cable.
- When using a commercially available 2RCA(L/R)/stereo mini-pin audio cable, make sure it is labeled "No resistance".

Connecting a LAN Cable

Connect with a commercially available 100BASE-TX or 10BASE-T LAN cable.

Connected equipment	Connecting cable	Projector port
LAN port on network hub	LAN cable (commercially available)	LAN port  LAN

Attention

To prevent malfunctions, use a category 5 shielded LAN cable.

Connecting to an external monitor (EB-G5950/G5900/G5650W/G5600 only)

You can display computer images input from a computer on an external monitor connected to the projector and the screen at the same time. This means that you can check projected images on an external monitor when giving presentations even if you cannot see the screen. Connect using the cable supplied with the external monitor.



Only RGB signals from a computer connected to one of the following input ports can be displayed on an external monitor: Computer1 input port, Computer2 input port, and BNC input port. Images from equipment connected to other ports and component video signals cannot be displayed.

Connected equipment	Connecting cable	Projector port
Monitor	Cable supplied with monitor	Monitor Out port  Monitor Out



- Setting gauges such as Keystone, the configuration menu, or Help screens are not output to the external monitor.
- The image is not displayed on the external monitor when the projector is on standby.

Connecting to External Speakers (EB-G5950/G5900/G5650W/G5600 only)

You can connect speakers with built-in amplifiers to the projector's Audio Out port to enjoy a fuller quality of sound. Connect with a commercially

available audio cable (pin plug ↔ 3.5 mm stereo mini plug and so on). Use an audio cable compatible with the connector on the external speakers.

Connected equipment	Connecting cable	Projector port
Audio device	Audio cable (commercially available)	Audio Out port 



- When an audio cable plug is inserted in the Audio Out port, the audio changes to the external destination, and audio is no longer emitted from the projector's built-in speaker.
- When using a commercially available 2RCA(L/R)/stereo mini-pin audio cable, make sure it is labeled "No resistance".

Removing and Attaching the Projector Lens Unit

Removing

Attention

- Only remove the lens unit when necessary. If dust or dirt enter the projector, projection quality deteriorates and it could cause a malfunction.
- Try not to touch the lens section with your hand or fingers. If fingerprints or oils are left on the surface of the lens, projection quality deteriorates.
- If the lens shift has been done, set the lens shift to the center before replacing the lens unit.  [p.22](#)

Procedure

- 1 If the lens unit removal button is held in place with a screw, remove the screw.

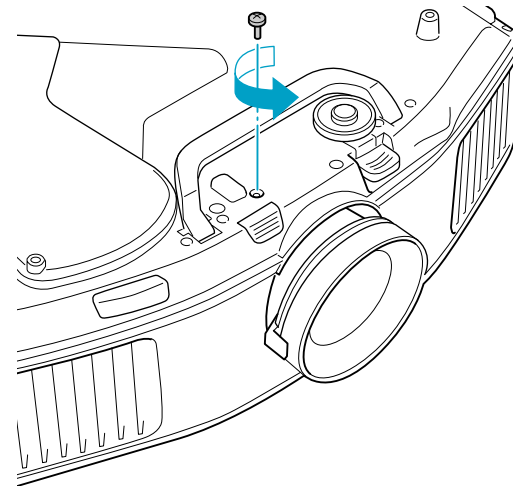

- 2 Hold down the lens unit removal button and turn the lens anti-clockwise until you hear it click.

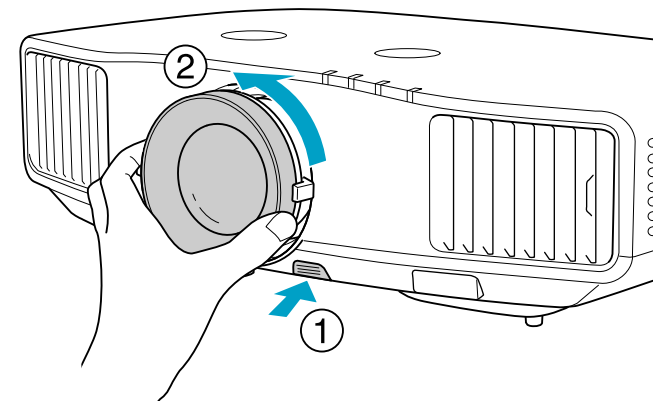

- 3 Pull the lens unit straight out as it is released.

Attaching

Attention
Do not attach the lens unit when the projector's lens insertion section is facing up. Dust or dirt could enter the projector.

Procedure

- 1 Turn clockwise until the focus ring stops moving.

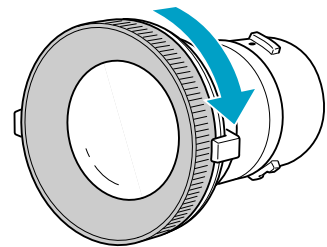

- 2 Insert the lens unit straight into the lens insertion section with the white circle on the lens on top, and then turn clockwise until you hear it click into place.

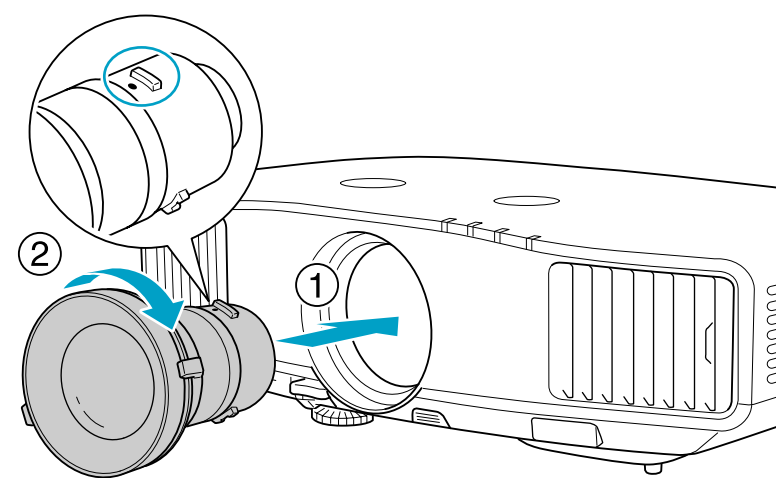

- 3 Check that the lens cannot be detached by turning it anti-clockwise.

Attention
Store the projector with the lens unit installed.
If the projector is stored without the lens unit, dust and dirt may get inside the projector and cause malfunctions or lower the quality of projection.

Installing the Wireless LAN Unit (ELPAP03) (EB-G5950/G5650W only)

Attaching

Procedure

- 1 Remove the cover from the Wireless LAN unit installation section on the projector. Store the cover so that it is not lost.

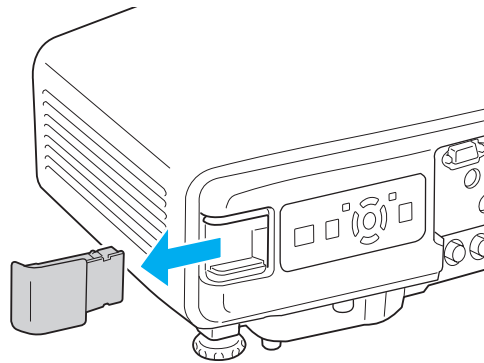

- 2 Install the Wireless LAN unit.

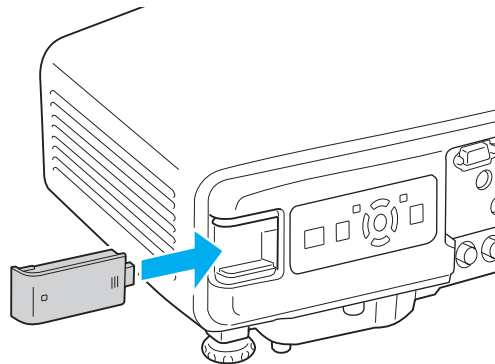

- 3 Secure the Wireless LAN unit using the supplied screw to avoid losing the unit.

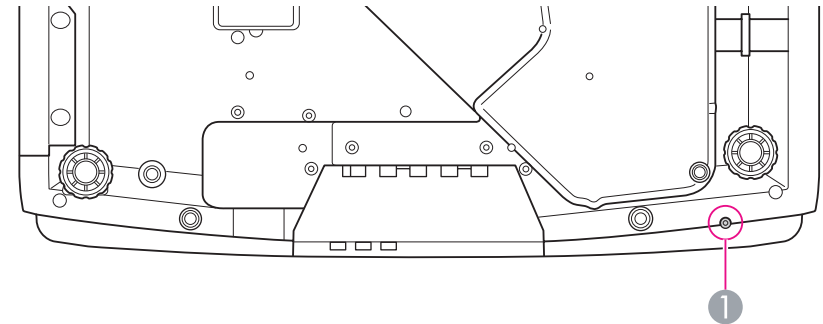

- 1 Screw hole to fix Wireless LAN unit

When connecting a projector to which the Wireless LAN unit is mounted to a computer using a wireless LAN, set the **Wireless LAN Power** setting on the **Wireless LAN** menu to **On**. (The default setting is **On**.)





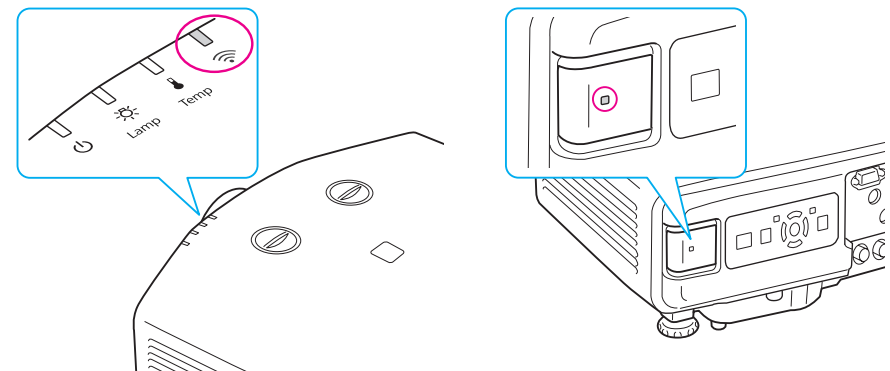

☞ p.70

Reading the wireless LAN indicators

There are two Wireless LAN indicators, one on the projector and one on the Wireless LAN unit.



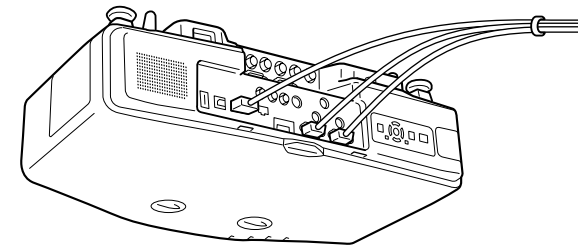

 : Flashing
  : Lit
  : Off

Status	Indicator on projector	Indicator on Wireless LAN unit
The Wireless LAN unit not mounted or the Wireless LAN Power setting on the Wireless LAN menu is Off		
The Wireless LAN unit mounted to the projector but not connected to the network		
The Wireless LAN unit mounted to the projector and connected to the network		
The Wireless LAN unit mounted to the projector, connected to the network, and communicating		

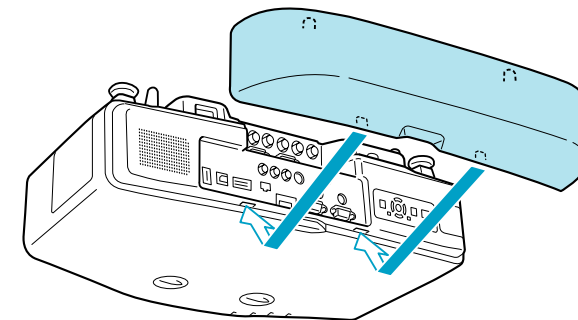

-  **Insert the tabs on the cable cover into the two holes on the back of the projector.**



-  **Tighten the two cable cover screws. (You can tighten the screws with your fingers.)**

Attaching and Removing the Cable Cover

Mounting the cable cover, disordered cables can be tidied away. (The illustration shows a projector suspended from the ceiling.)

Attaching

Procedure

-  **Bundle the cables with a commercially available band.**

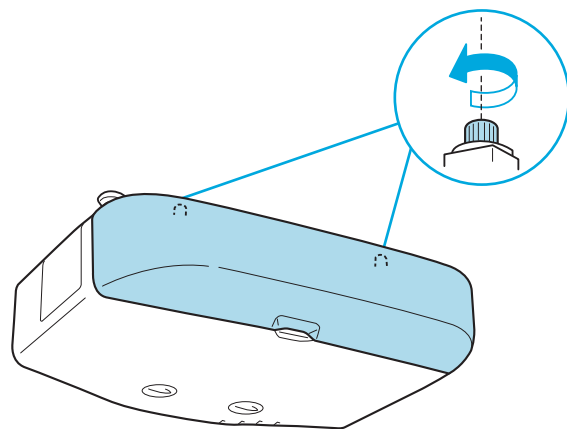

Removing

Procedure

Loosen the two cable cover screws and then remove the cable cover.

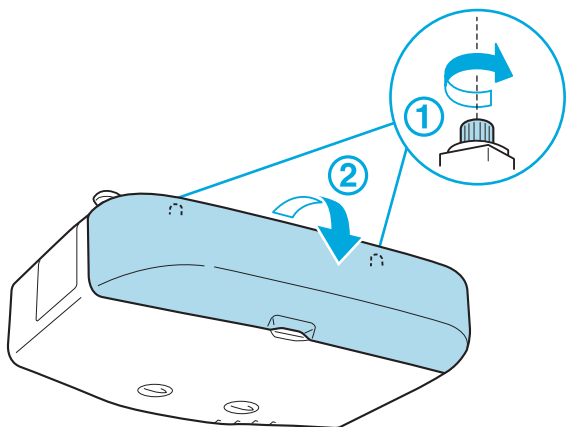



Appendix

The following optional accessories and consumables are available. Please purchase these products as and when needed. The following list of optional accessories and consumables is current as of: 2010.07. Details of accessories are subject to change without notice and availability may vary depending on the country of purchase.

Optional accessories

60" portable screen ELPSC27

80" portable screen ELPSC28

100" screen ELPSC29

Portable roll-type screens (Aspect ratio 4:3)

Computer cable ELPKC02

(1.8 m - for mini D-Sub15-pin/mini D-Sub 15pin)

This is the same as the computer cable supplied with the projector.

Computer cable ELPKC09

(3 m - for mini D-Sub15-pin/mini D-Sub 15pin)

Computer cable ELPKC10

(20 m - for mini D-Sub15-pin/mini D-Sub 15pin)

Use one of these longer cables if the computer cable supplied with the projector is too short.

Component video cable ELPKC19

(3 m - for mini D-Sub 15-pin/RCA male×3)

Use to connect a [Component Video](#) source.

Remote control cable set ELPKC28

(10 m 2 piece set)

Use this to guarantee operation from the remote control from a distance.

Wireless mouse receiver ELPST16

Use this to use the projector's remote control to control the mouse pointer on the computer or to page up and down.

Wireless LAN unit ELPAP03 (EB-G5950/G5650W)

Use this to project images from a computer via a wireless LAN.

Quick Wireless Connection USB Key ELPAP08 (for the EB-G5950/G5650W)

Use this key to connect to a Windows computer and project images from the computer. However, the projector needs to be connected to a network before it can be used.

Long focus zoom lens ELPLL06

(Projection distance ratio: a. Approx. 5.3 to 7.2 b. Approx. 5.2 to 7.1)

Medium focus zoom lens ELPLM04

(Projection distance ratio: a. Approx. 2.4 to 3.6 b. Approx. 2.3 to 3.5)

Medium focus zoom lens ELPLM05

(Projection distance ratio: a. Approx. 3.5 to 5.4 b. Approx. 3.5 to 5.3)

Standard focus zoom lens ELPLS05

(Projection distance ratio: a. Approx. 1.3 to 2.4 b. Approx. 1.3 to 2.3)

Wide lens for rear projection ELPLR03

(Projection distance ratio: a. Approx. 0.78 b. Approx. 0.77)

a: For the EB-G5950/G5900/G5800/G5600/G5500, b: For the EB-G5650W

Projection distance ratio = projection distance/projection screen width

The values are installation standards. They are subject to change depending on projection conditions.

Ceiling mount* ELPMB22

Use when installing the projector on a ceiling.

Ceiling pipe (450mm)* ELPFP13

Ceiling pipe (700mm)* ELPFP14

Use when installing the projector on a ceiling.

* A special method of installation is required to suspend the projector from a ceiling. Contact your dealer or the nearest address provided in the Support

and Service Guide if you want to use this installation method.  [Epson Projector Contact List](#)

Consumables

Lamp unit (EB-G5600/G5500) ELPLP62

Lamp unit (EB-G5950/G5900/G5800/G5650W) ELPLP63

Use as a replacement for used lamps.

Air filter ELPAF17

Use as a replacement for used air filters.

The following table shows the projection distance when a standard lens is attached. When an optional lens is attached, check the projection distances using the Lens Projection Distance Table supplied with this projector. To find the appropriate screen size, see the following table to set up the projector. Values are just reference.

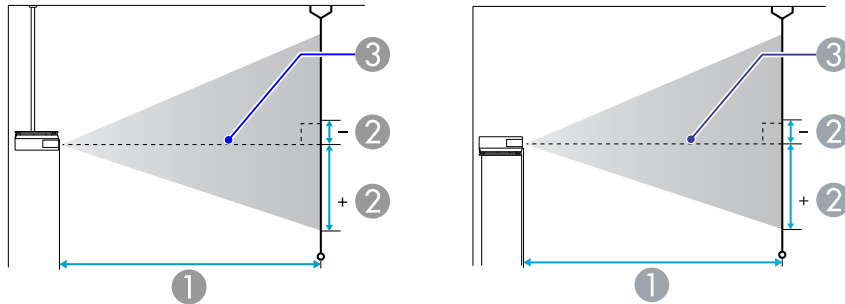

- ① Projection distance
- ② is the distance from the center of the lens to the base of the screen. This changes depending on the setting for vertical lens shift.
- ③ Center of lens

Projection Distance of EB-G5950/G5900/G5800/ G5600/G5500

Units: cm

4:3 Screen size		①	②
		Minimum (Wide) to Maximum (Tele)	Vertical lens shift Maximum to Minimum
30"	61x46	77 - 142	0 - +46
40"	81x61	104 - 190	0 - +61
50"	100x76	131 - 239	0 - +76
60"	120x90	158 - 287	0 - +91

4:3 Screen size		①	②
		Minimum (Wide) to Maximum (Tele)	Vertical lens shift Maximum to Minimum
80"	160x120	213 - 385	0 - +122
100"	200x150	267 - 482	0 - +152
120"	240x180	321 - 579	0 - +183
150"	300x230	403 - 725	0 - +229
200"	410x300	539 - 968	0 - +305
250"	510x380	675 - 1211	0 - +381
300"	610x460	811 - 1454	0 - +457

Units: cm

16:9 Screen size		①	②
		Minimum (Wide) to Maximum (Tele)	Vertical lens shift Maximum to Minimum
30"	66x37	84 - 155	-6 - +44
40"	89x50	114 - 208	-8 - +58
50"	110x62	143 - 261	-10 - +73
60"	130x75	173 - 313	-12 - +87
80"	180x100	232 - 419	-17 - +116
100"	220x120	291 - 525	-21 - +145
120"	270x150	351 - 631	-25 - +174
150"	330x190	439 - 790	-31 - +218
200"	440x250	588 - 1055	-42 - +291
250"	550x310	736 - 1320	-52 - +363
275"	610x340	810 - 1452	-57 - +400

Projection Distance of EB-G5650W

Units: cm

4:3 Screen size		①	②
		Minimum (Wide) to Maximum (Tele)	Vertical lens shift Maximum to Minimum
30"	61x46	92 - 169	-4 - +50
40"	81x61	125 - 227	-6 - +67
50"	100x76	157 - 285	-7 - +83
60"	120x90	189 - 343	-9 - +100
80"	160x120	254 - 459	-12 - +134
100"	200x150	319 - 574	-15 - +167
120"	240x180	384 - 690	-17 - +200
150"	300x230	481 - 864	-22 - +250
200"	410x300	643 - 1153	-29 - +334
250"	510x380	804 - 1442	-36 - +417
265"	540x400	853 - 1529	-38 - +442

Units: cm

16:9 Screen size		①	②
		Minimum (Wide) to Maximum (Tele)	Vertical lens shift Maximum to Minimum
30"	66x37	83 - 153	-6 - +43
40"	89x50	113 - 206	-8 - +58
50"	110x62	142 - 258	-10 - +72
60"	130x75	171 - 311	-12 - +87

16:9 Screen size		①	②
		Minimum (Wide) to Maximum (Tele)	Vertical lens shift Maximum to Minimum
80"	180x100	230 - 416	-16 - +116
100"	220x120	289 - 521	-20 - +145
120"	270x150	348 - 626	-24 - +174
150"	330x190	436 - 784	-30 - +217
200"	440x250	583 - 1046	-40 - +289
250"	550x310	730 - 1309	-50 - +362
290"	640x360	847 - 1519	-58 - +419

Units: cm

16:10 Screen size		①	②
		Minimum (Wide) to Maximum (Tele)	Vertical lens shift Maximum to Minimum
30"	65x40	81 - 149	-4 - +44
40"	86x54	109 - 200	-5 - +59
50"	110x67	138 - 251	-6 - +74
60"	130x81	167 - 302	-8 - +88
80"	170x110	224 - 405	-10 - +118
100"	220x130	281 - 507	-13 - +147
120"	260x160	338 - 609	-15 - +177
150"	320x200	424 - 762	-19 - +221
200"	430x270	567 - 1018	-26 - +295
250"	540x340	710 - 1273	-32 - +369
300"	640x400	853 - 1529	-38 - +442

Supported Monitor Displays for EB-G5950/G5900/ G5800/G5600/G5500

Computer signals (analog RGB)

Signal	Refresh Rate (Hz)	Resolution (dots)
VGA	60/72/75/85	640x480
SVGA	56/60/72/75/85	800x600
XGA	60/70/75/85	1024x768
WXGA	60/75/85	1280x768
	60	1360x768
	60/75/85	1280x800
WXGA+	60/75/85	1440x900
SXGA	70/75/85	1152x864
	60/75/85	1280x1024
	60/75/85	1280x960
SXGA+	60/75	1400x1050
UXGA	60	1600x1200
MAC13"	67	640x480
MAC16"	75	832x624
MAC19"	75	1024x768
	59	1024x768
MAC21"	75	1152x870

Even when signals other than those mentioned above are input, it is likely that the image can be projected. However, not all functions may be supported.

Component Video

Signal	Refresh Rate (Hz)	Resolution (dots)
SDTV(480i)	60	720x480
SDTV(576i)	50	720x576
SDTV(480p)	60	720x480
SDTV(576p)	50	720x576
HDTV(720p)	50/60	1280x720
HDTV(1080i)	50/60	1920x1080

Composite Video/S-Video

Signal	Refresh Rate (Hz)	Resolution (dots)
TV(NTSC)	60	720x480
TV(PAL,SECAM)	50/60	720x576

Input signals from HDMI input port (EB-G5950/G5900/G5600 only)

Signal	Refresh Rate (Hz)	Resolution (dots)
VGA	60	640x480
SVGA	60	800x600
XGA	60	1024x768
WXGA	60	1280x800
SXGA	60	1280x960
	60	1280x1024
SXGA+	60	1400x1050
UXGA	60	1600x1200
SDTV(480i)	60	720x480

Signal	Refresh Rate (Hz)	Resolution (dots)
SDTV(480p)	60	720x480
SDTV(576i)	50	720x576
SDTV(576p)	50	720x576
HDTV(720p)	50/60	1280x720
HDTV(1080i)	50/60	1920x1080
HDTV(1080p)	24/30/50/60	1920x1080

Supported Monitor Displays for EB-G5650W

Computer signals (analog RGB)

Signal	Refresh Rate (Hz)	Resolution (dots)
VGA	60/72/75/85	640x480
SVGA	56/60/72/75/85	800x600
XGA	60/70/75/85	1024x768
WXGA	60/75/85	1280x768
	60	1360x768
	60/75/85	1280x800
WXGA+	60/75/85	1440x900
WSXGA+*	60	1680x1050
SXGA	70/75/85	1152x864
	60/75/85	1280x1024
	60/75/85	1280x960
SXGA+	60/75	1400x1050
UXGA	60	1600x1200
MAC13"	67	640x480

Signal	Refresh Rate (Hz)	Resolution (dots)
MAC16"	75	832x624
MAC19"	75	1024x768
	59	1024x768
MAC21"	75	1152x870

* Only compatible when Wide is selected as the Resolution from the configuration menu.

Even when signals other than those mentioned above are input, it is likely that the image can be projected. However, not all functions may be supported.

Component Video

Signal	Refresh Rate (Hz)	Resolution (dots)
SDTV(480i)	60	720x480
SDTV(576i)	50	720x576
SDTV(480p)	60	720x480
SDTV(576p)	50	720x576
HDTV(720p)	50/60	1280x720
HDTV(1080i)	50/60	1920x1080

Composite Video/S-Video

Signal	Refresh Rate (Hz)	Resolution (dots)
TV(NTSC)	60	720x480
TV(PAL,SECAM)	50/60	720x576

Input signals from HDMI input port

Signal	Refresh Rate (Hz)	Resolution (dots)
VGA	60	640x480
SVGA	60	800x600
XGA	60	1024x768
WXGA	60	1280x800
SXGA	60	1280x960
	60	1280x1024
SXGA+	60	1400x1050
UXGA	60	1600x1200
SDTV(480i)	60	720x480
SDTV(480p)	60	720x480
SDTV(576i)	50	720x576
SDTV(576p)	50	720x576
HDTV(720p)	50/60	1280x720
HDTV(1080i)	50/60	1920x1080
HDTV(1080p)	24/30/50/60	1920x1080

Projector General Specifications

Product name	EB-G5950	EB-G5900	EB-G5800	EB-G5650W	EB-G5600	EB-G5500	
Dimensions	470 (W) × 135 (H) × 311.5 (D) mm (not including foot and projection lens)						
Panel size	0.8"			0.74" wide	0.8"		
Display method	Polysilicon TFT active matrix						
Resolution	786,432 pixels XGA (1024 (W) × 768 (H) dots) × 3			1,024,000 pixels WXGA (1280 (W) × 800 (H) dots) × 3	786,432 pixels XGA (1024 (W) × 768 (H) dots) × 3		
Focus adjustment	Manual						
Zoom adjustment*1	Manual (1 to 1.8)						
Lens shift*1	Manual (vertical: approx. 50% max., horizontal: approx. 10% max.)			Manual (vertical: approx. 60% max., horizontal: approx. 10% max.)	Manual (vertical: approx. 50% max., horizontal: approx. 10% max.)		
Lamp	UHE lamp, 330 W Model No.: ELPLP63				UHE lamp, 275 W Model No.: ELPLP62		
Max. audio output	7 W monaural		–	7 W monaural		–	
Speaker	1		–	1		–	
Power supply	100 to 240 V AC ±10%, 50/60 Hz 4.7 to 2.0 A	100 to 240 V AC ±10%, 50/60 Hz 4.7 to 2.0 A	100 to 240 V AC ±10%, 50/60 Hz 4.7 to 2.0 A	100 to 240 V AC ±10%, 50/60 Hz 4.7 to 2.0 A	100 to 240 V AC ±10%, 50/60 Hz 3.9 to 1.7 A	100 to 240 V AC ±10%, 50/60 Hz 3.9 to 1.7 A	
Power consumption	100 to 120 V area	Operating: 464 W Standby power consumption (Communication On): 10 W Standby power consumption (Communication Off): 0.38 W	Operating: 464 W Standby power consumption (Communication On): 10 W Standby power consumption (Communication Off): 0.38 W	Operating: 464 W Standby power consumption (Communication On): 10 W Standby power consumption (Communication Off): 0.38 W	Operating: 464 W Standby power consumption (Communication On): 10 W Standby power consumption (Communication Off): 0.38 W	Operating: 390 W Standby power consumption (Communication On): 10 W Standby power consumption (Communication Off): 0.38 W	Operating: 390 W Standby power consumption (Communication On): 10 W Standby power consumption (Communication Off): 0.38 W

	220 to 240 V area	Operating: 442 W Standby power consumption (Communication On): 11 W Standby power consumption (Communication Off): 0.47 W	Operating: 442 W Standby power consumption (Communication On): 11 W Standby power consumption (Communication Off): 0.47 W	Operating: 442 W Standby power consumption (Communication On): 11 W Standby power consumption (Communication Off): 0.47 W	Operating: 442 W Standby power consumption (Communication On): 11 W Standby power consumption (Communication Off): 0.47 W	Operating: 373 W Standby power consumption (Communication On): 11 W Standby power consumption (Communication Off): 0.47 W	Operating: 373 W Standby power consumption (Communication On): 11 W Standby power consumption (Communication Off): 0.47 W
Operating altitude		Altitude 0 to 3000 m					
Operating temperature		0 to +40°C*2 (No condensation)					
Storage temperature		-10 to +60°C (No condensation)					
Volume*1		Approx. 6.8kg					

*1 The specifications are when a standard lens is attached. When an optional lens is attached, check the Optional User's Guide supplied with the optional lenses.

*2 The operating temperature is 0 to +35°C when "Power Consumption" is set to Normal at an altitude of 1500 to 3000m.

Product name			EB-G5950	EB-G5900	EB-G5800	EB-G5650W	EB-G5600	EB-G5500
Connectors	Computer1 input port	1	Mini D-Sub15-pin (female) blue					
	Audio1 input port	1	Stereo mini jack	–		Stereo mini jack	–	
	Computer2 input port	1	Mini D-Sub15-pin (female) blue	–		Mini D-Sub15-pin (female) blue	–	
	Audio2 input port	1	Stereo mini jack	–		Stereo mini jack	–	
	BNC input port	1	5BNC (female)					
	Audio3 input port	1	Stereo mini jack	–		Stereo mini jack	–	
	Video1 input port	1	1BNC (female)					
	Video2 input port	1	RCA pin jack	–		RCA pin jack	–	
	S-Video input port	1	Mini DIN 4-pin	–		Mini DIN 4-pin	–	
	Audio4 input port	1	RCA pin jack × 2 (L, R)	–		RCA pin jack × 2 (L, R)	–	
	HDMI input port	1	HDMI HDCP (Audio is supported only for PCM.)	–		HDMI HDCP (Audio is supported only for PCM.)	–	
	Monitor Out port	1	Mini D-Sub15-pin (female) black	–		Mini D-Sub15-pin (female) black	–	

Audio Out port	1	Stereo mini jack		–	Stereo mini jack		–
USB (Type A) port*	1	USB connector (Type A)	–	USB connector (Type A)		–	–
USB port (Only for Wireless LAN unit)	1	USB connector (Type A)	–	USB connector (Type A)		–	–
LAN Port	1	RJ-45					–
RS-232C Port	1	Mini D-Sub 9-pin (male)					
Remote port	1	Stereo mini jack		–	Stereo mini jack		–

* USB 2.0 is supported. However, the operation of all USB compatible devices is not guaranteed.

This product is also designed for IT power distribution system with phase-to-phase voltage 230V.



Pixelworks DNX™ ICs are used in this projector.

Angle of tilt

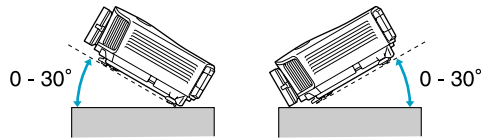

Using the projector at angles not shown in the illustrations above may damage it or cause an accident.

DECLARATION of CONFORMITY

According to 47CFR, Part 2 and 15
Class B Personal Computers and Peripherals; and/or
CPU Boards and Power Supplies used with Class B
Personal Computers

We: Epson America, Inc.
Located at: 3840 Kilroy Airport Way
MS: 3-13
Long Beach, CA 90806
Tel: 562-290-5254

Declare under sole responsibility that the product identified herein, complies with 47CFR Part 2 and 15 of the FCC rules as a Class B digital device. Each product marketed, is identical to the representative unit tested and found to be compliant with the standards. Records maintained continue to reflect the equipment being produced can be expected to be within the variation accepted, due to quantity production and testing on a statistical basis as required by 47CFR 2.909. Operation is subject to the following two conditions : (1) this device may not cause harmful interference, and (2) this device must accept any interference received, including interference that may cause undesired operation.

Trade Name: EPSON
Type of Product: LCD Projector
Model: H347C/H349C/H350C/H352C/H379C/H380C

**FCC Compliance Statement
For United States Users**

This equipment has been tested and found to comply with the limits for a Class B digital device, pursuant to Part 15 of the FCC Rules. These limits are designed to provide reasonable protection against harmful interference in a residential installation. This equipment generates, uses, and can radiate radio frequency energy and, if not installed and used in accordance with the instructions, may cause harmful interference to radio communications. However, there is no guarantee that interference will not occur in a particular installation. If this equipment does cause harmful interference to radio or television reception, which can be determined by turning the equipment off and on, the user is encouraged to try to correct the interference by one or more of the following measures.

- Reorient or relocate the receiving antenna.
- Increase the separation between the equipment and receiver.
- Connect the equipment into an outlet on a circuit different from that to which the receiver is connected.
- Consult the dealer or an experienced radio/TV technician for help.

WARNING

The connection of a non-shielded equipment interface cable to this equipment will invalidate the FCC Certification or Declaration of this device and may cause interference levels which exceed the limits established by the FCC for this equipment. It is the responsibility of the user to obtain and use a shielded equipment interface cable with this device. If this equipment has more than one interface connector, do not leave cables connected to unused interfaces. Changes or modifications not expressly approved by the manufacturer could void the user's authority to operate the equipment.

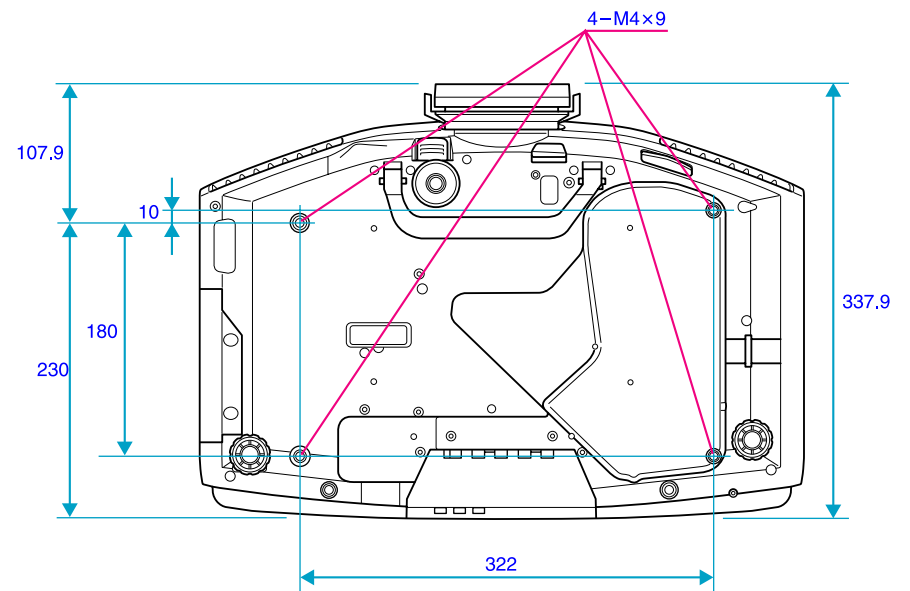
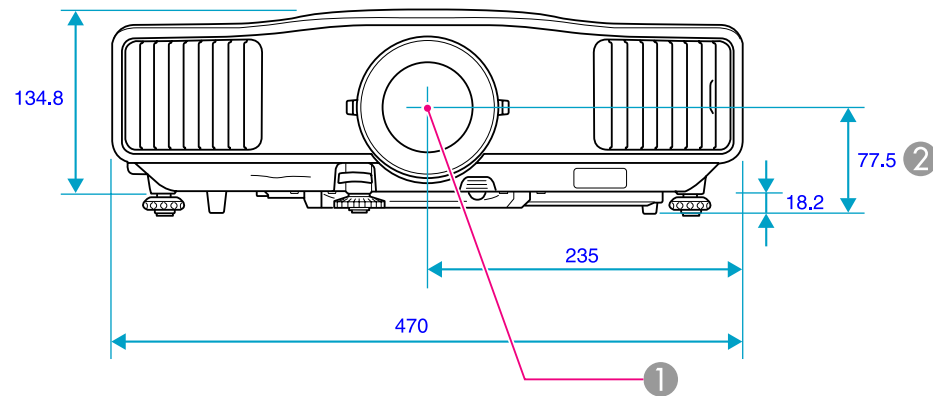



Units: mm

- ① Center of lens
- ② Distance from center of lens to suspension bracket fixing point

This section explains easily terms that are used with the projector and difficult terms that are not explained in the text of this guide. For details, refer to other commercially available publications.

Ad hoc mode	A method of wireless LAN connection that communicates with wireless LAN clients without using an access point. It is not possible to communicate with two or more devices simultaneously.
AMX Device Discovery	AMX Device Discovery is a technology developed by AMX to facilitate AMX control systems for easy operation of the target equipment. Epson have implemented this protocol technology, and have provided a setting to enable the protocol function (ON). See the AMX Web site for more details. URL http://www.amx.com/
Aspect Ratio (Aspect Ratio)	The ratio between an image's length and its height. HDTV images have an aspect ratio of 16:9 and appear elongated. The aspect ratio for standard images is 4:3.
Component Video	A Video signal which has the luminance component and color component separated to provide better image quality. Refers to images that consist of three independent signals: Y (luminance signal), Pb and Pr (color difference signals).
Composite video	Video signals that have the video brightness signals and color signals mixed together. The type of signals commonly used by household video equipment (NTSC, PAL, and SECAM formats). The carrier signal Y (luminance signal) and chroma (color) signal that are contained in the color bar are overlapped to form a single signal.
Contrast	The relative brightness of the light and dark areas of an image can be increased or decreased to make text and graphics stand out more clearly, or to make them appear softer. Adjusting this particular property of an image is called Contrast adjustment.
DHCP	An abbreviation of Dynamic Host Configuration Protocol, this protocol automatically assigns an IP Address to equipment connected to a Network.
DICOM	An acronym for Digital Imaging and Communications in Medicine. An international standard that defines image standards and a communications protocol for medical images.
Gateway address (Gateway Address)	This is a server (router) for communicating across a network (subnet) divided according to subnet masks .
HDCP	HDCP is an abbreviation for High-bandwidth Digital Content Protection. It is used to prevent illegal copying and protect copyrights by encrypting digital signals sent over DVI and HDMI input ports. Digital images protected by HDCP technology can be projected with this projector because the projector's HDMI input ports are compatible with HDCP. However, the projector may not be able to project images protected with updated or revised versions of HDCP encryption.
HDTV	An abbreviation for High-Definition Television that refers to high-definition systems which satisfy the following conditions. <ul style="list-style-type: none"> • Vertical resolution of 720p or 1080i or greater (p = Progressive, i = Interlace) • Screen Aspect Ratio of 16:9
Infrastructure mode	A method for wireless LAN connection in which devices communicate through access points.

Interlace	A method of image scanning whereby the image data is divided into fine horizontal lines that are displayed in sequence starting from left to right and then from top to bottom. The even-numbered lines and odd-numbered lines are displayed alternately.
IP Address	A number to identify a computer connected to a Network.
Progressive	A method of image scanning whereby the image data from a single image is scanned sequentially from top to bottom to create a single image.
Refresh Rate	The light-emitting element of a display maintains the same luminosity and color for an extremely short time. Because of this, the image must be scanned many times per second to refresh the light-emitting element. The number of refresh operations per second is called the Refresh Rate and is expressed in hertz (Hz).
SDTV	An abbreviation for Standard Definition Television that refers to standard television systems which do not satisfy the conditions for HDTV  High-Definition Television.
SNMP	An abbreviation for Simple Network Management Protocol, which is the protocol for monitoring and controlling devices such as routers and computers connected to a TCP/IP Network.
sRGB	An international standard for color intervals that was formulated so that colors that are reproduced by video equipment can be handled easily by computer operating systems (OS) and the Internet. If the connected source has an sRGB mode, set both the projector and the connected signal source to sRGB.
Subnet mask (Subnet Mask)	This is a numerical value that defines the number of bits used for the network address on a divided network (subnet) from the IP Address  .
SVGA	A type of video signal with a resolution of 800 (horizontal) × 600 (vertical) dots that is used by IBM PC/AT-compatible computers.
S-Video	A Video signal which has the luminance component and color component separated to provide better image quality. Refers to images that consist of two independent signals: Y (luminance signal) and C (color signal).
SXGA	A type of video signal with a resolution of 1,280 (horizontal) × 1,024 (vertical) dots that is used by IBM PC/AT-compatible computers.
Sync.	The signals output from computers have a specific frequency. If the projector frequency does not match this frequency, the resulting images are not of a good quality. The process of matching the phases of these signals (the relative position of the crests and the troughs in the signal) is called Synchronization. If the signals are not synchronized, flickering, blurriness, and horizontal interference occur.
Tracking	The signals output from computers have a specific frequency. If the projector frequency does not match this frequency, the resulting images are not of a good quality. The process of matching the frequency of these signals (the number of crests in the signal) is called Tracking. If Tracking is not carried out correctly, wide vertical stripes appear in the signal.
Trap IP Address	This is the IP Address  for the destination computer used for error notification in SNMP.
VGA	A type of video signal with a resolution of 640 (horizontal) × 480 (vertical) dots that is used by IBM PC/AT-compatible computers.
WPS (Wi-Fi Protected Setup)	Wi-Fi Protected Setup has been devised by the Wi-Fi Alliance as a means of easily setting up and securing a Wireless LAN.
XGA	A type of video signal with a resolution of 1,024 (horizontal) × 768 (vertical) dots that is used by IBM PC/AT-compatible computers.