



# Table of Contents

Table of Contents .....	1	OPTIONS.....	36
Usage Notice .....	2	OPTIONS   <i>Advanced</i> .....	37
Safety Information.....	2	OPTIONS   <i>Lamp Settings</i> .....	38
Precautions.....	3	Appendices.....	39
Eye Safety Warnings .....	5	Troubleshooting .....	39
Product Features .....	5	Replacing the lamp .....	44
Introduction.....	6	Compatibility Modes .....	46
Package Overview.....	6	Computer Compatibility .....	46
Product Overview .....	7	Video Compatibility.....	47
Main Unit.....	7	RS232 Commands and Protocol	
Control Panel.....	8	Function List .....	48
Input/Output Connections .....	9	RS232 Pin Assignments.....	48
Remote Control.....	10	RS232 Protocol Function List .....	49
Installation .....	11	Ceiling Mount Installation.....	52
Connecting the Projector .....	11	Optoma Global Offices .....	53
Connect to Computer/Notebook .....	11	Regulation & Safety Notices .....	55
Connect to Video Sources .....	12		
Powering On/Off the Projector.....	13		
Powering On the Projector.....	13		
Powering Off the Projector.....	14		
Warning Indicator.....	14		
Adjusting the Projected Image.....	15		
Adjusting the Projector's Height .....	15		
Adjusting the Projector's Focus.....	16		
Adjusting Projection Image Size.....	16		
User Controls .....	18		
Control Panel & Remote Control .....	18		
Control Panel.....	18		
Remote Control.....	19		
On-screen Display Menus .....	21		
How to operate .....	21		
Menu Tree.....	22		
IMAGE.....	24		
IMAGE   <i>Advanced</i> .....	26		
DISPLAY.....	28		
DISPLAY   <i>3D</i> .....	30		
SETUP.....	31		
SETUP   <i>Security</i> .....	33		
SETUP   <i>Signal</i> .....	35		

## Safety Information

	The lightning flash with arrow head within an equilateral triangle is intended to alert the user to the presence of uninsulated "dangerous voltage" within the product's enclosure that may be of sufficient magnitude to constitute a risk of electric shock to persons.
	The exclamation point within an equilateral triangle is intended to alert the user to the presence of important operating and maintenance (servicing) instructions in the literature accompanying the appliance.

**WARNING:** TO REDUCE THE RISK OF FIRE OR ELECTRIC SHOCK, DO NOT EXPOSE THIS APPLIANCE TO RAIN OR MOISTURE. DANGEROUS HIGH VOLTAGES ARE PRESENT INSIDE THE ENCLOSURE. DO NOT OPEN THE CABINET. REFER SERVICING TO QUALIFIED PERSONNEL ONLY.

### Class B emissions limits

This Class B digital apparatus meets all requirements of the Canadian Interference-Causing Equipment Regulations.

### Important Safety Instruction

1. Do not block any ventilation openings. To ensure reliable operation of the projector and to protect from over heating, it is recommended to install the projector in a location that does not block ventilation. As an example, do not place the projector on a crowded coffee table, sofa, bed, etc. Do not put the projector in an enclosure such as a book case or a cabinet that restricts air flow.
2. Do not use the projector near water or moisture. To reduce the risk of fire and/or electric shock, do not expose the projector to rain or moisture.
3. Do not install near heat sources such as radiators, heaters, stoves or any other apparatus such as amplifiers that emits heat.
4. Clean only with dry cloth.
5. Only use attachments/accessories specified by the manufacturer.
6. Do not use the unit if it has been physically damaged or abused.  
Physical damage/abuse would be (but not limited to):
  - Unit has been dropped.
  - Power supply cord or plug has been damaged.
  - Liquid has been spilled on to the projector.
  - Projector has been exposed to rain or moisture.
  - Something has fallen in the projector or something is loose inside.Do not attempt to service the unit yourself. Opening or removing covers may expose you to dangerous voltages or other hazards. Please call Optoma before you send the unit for repair.
7. Do not let objects or liquids enter the projector. They may touch dangerous voltage points and short out parts that could result in fire or electric shock.
8. See projector enclosure for safety related markings.
9. The unit should only be repaired by appropriate service personnel.

## Precautions



*Please follow all warnings, precautions and maintenance as recommended in this user's guide.*

- Warning- Do not look into the projector's lens when the lamp is on. The bright light may hurt and damage your eyes.
- Warning- To reduce the risk of fire or electric shock, do not expose this projector to rain or moisture.
- Warning- Please do not open or disassemble the projector as this may cause electric shock.
- Warning- When replacing the lamp, please allow the unit to cool down. Follow instructions as described on pages 44-45.
- Warning- This projector will detect the life of the lamp itself. Please be sure to change the lamp when it shows warning messages.
- Warning- Reset the "Lamp Reset" function from the on-screen display "OPTIONS | Lamp Settings" menu after replacing the lamp module (refer to page 38).
- Warning- When switching the projector off, please ensure the cooling cycle has been completed before disconnecting power. Allow 90 seconds for the projector to cool down.
- Warning- Do not use lens cap when projector is in operation.
- Warning- When the lamp is approaching the end of its lifetime, the message "Lamp Warning: Lamp life exceeded." will show on the screen. Please contact your local reseller or service center to change the lamp as soon as possible.
- Warning- Do not look into or point the laser pointer on your remote control into your or someone's eyes. Laser pointer can cause permanent damage to eyesight.



- ❖ When the lamp reaches the end of its life, the projector will not turn back on until the lamp module has been replaced. To replace the lamp, follow the procedures listed under "Replacing the Lamp" section on pages 44-45.

# Usage Notice

## **Do:**

- ❖ Turn off and unplug the power plug from the AC outlet before cleaning the product.
- ❖ Use a soft dry cloth with mild detergent to clean the display housing.
- ❖ Disconnect the power plug from AC outlet if the product is not being used for a long period of time.

## **Do not:**

- ❖ Block the slots and openings on the unit provided for ventilation.
- ❖ Use abrasive cleaners, waxes or solvents to clean the unit.
- ❖ Use under the following conditions:
  - In extremely hot, cold or humid environments.
    - ▶ Ensure that the ambient room temperature is within 5 - 35°C.
    - ▶ Relative Humidity is 5 - 35°C, 80% (Max.), non-condensing.
  - In areas susceptible to excessive dust and dirt.
  - Near any appliance generating a strong magnetic field.
  - In direct sunlight.

## Eye Safety Warnings



- Avoid staring/facing directly into the projector beam at all times. Keep your back to the beam as much as possible.
- When projector is used in a classroom, adequately supervise students when they are asked to point out something on the screen.
- In order to minimize the lamp power, use room blinds to reduce ambient light levels.

## Product Features

- SVGA (800x600) Native resolution / WXGA (1280x800) Native resolution
- HD compatible – 1080p supported
- BrilliantColor™ Technology
- Security Bar and Kensington Lock
- RS232 control
- Rapid shutdown
- Built-in speaker

**projectisle**  
.com.au

*Where Projectors Roam Free*

# Introduction

## Package Overview

*Unpack and inspect the box contents to ensure all parts listed below are in the box. If something is missing, please contact your nearest customer service center.*

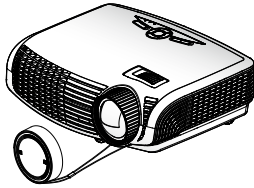

Projector with lens cap

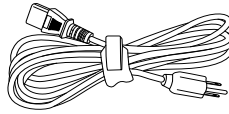

Power Cord 1.8m

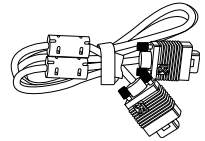

VGA Cable 1.8m

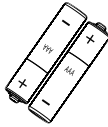

2 × AAA Batteries



IR Remote Control



❖ Due to different applications in each Country, some regions may have different accessories.

### Documentation :

- User's Manual
- Warranty Card
- Quick Start Card
- WEEE Card  
(for EMEA only)

# Introduction

## Product Overview

### Main Unit

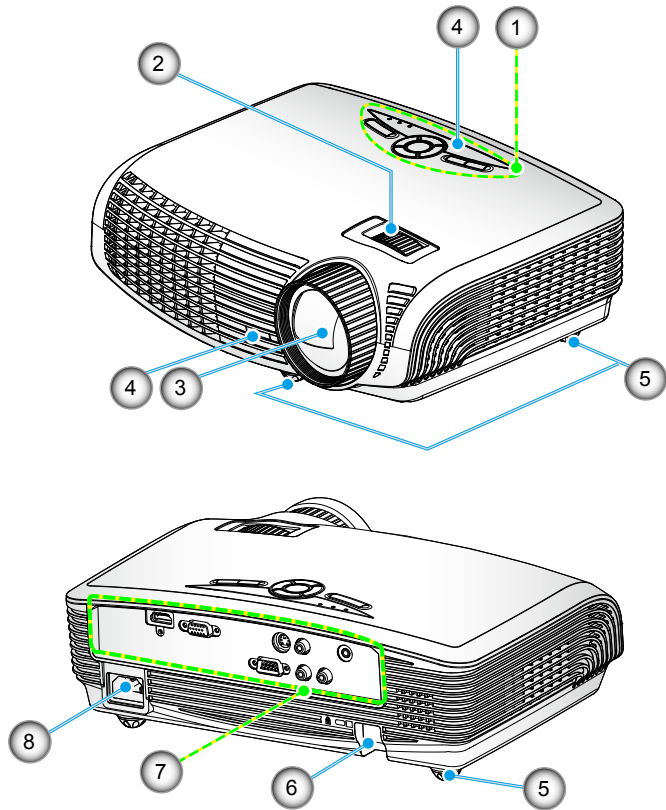

- |                         |                               |
|-------------------------|-------------------------------|
| 1. Control Panel        | 6. Security Bar               |
| 2. Focus Ring           | 7. Input / Output Connections |
| 3. Lens                 | 8. Power Socket               |
| 4. IR Receivers         |                               |
| 5. Tilt-Adjustment Feet |                               |

# Introduction

## Control Panel

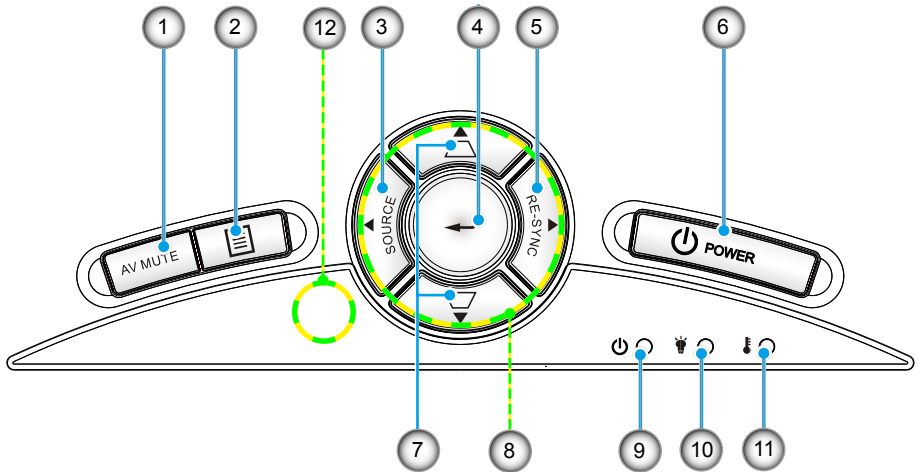

1. AV Mute
2. Menu
3. Source
4. Enter
5. Re-Sync
6. Power
7. Keystone Correction
8. Four Directional Select Keys
9. On/Standby LED
10. Lamp LED
11. Temp LED
12. IR Receiver



# Introduction

## Input/Output Connections

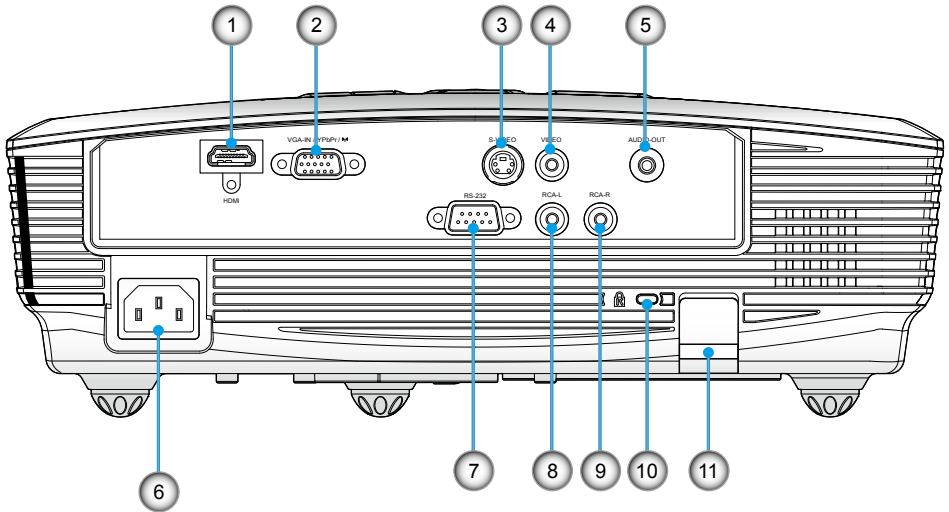

1. HDMI Connector (For WXGA only)
2. VGA-In/YPbPr/ (P) Connector  
(PC Analog Signal/Component Video Input/HDTV/YPbPr/  
Wireless Dongle)
3. S-Video Input Connector
4. Composite Video Input Connector
5. Audio Output Connector (3.5mm Mini Jack)
6. Power Socket
7. RS-232 Connector (9-pin)
8. Left RCA Audio Input Connector
9. Right RCA Audio Input Connector
10. Kensington™ Lock Port
11. Security Bar

# Introduction

## Remote Control

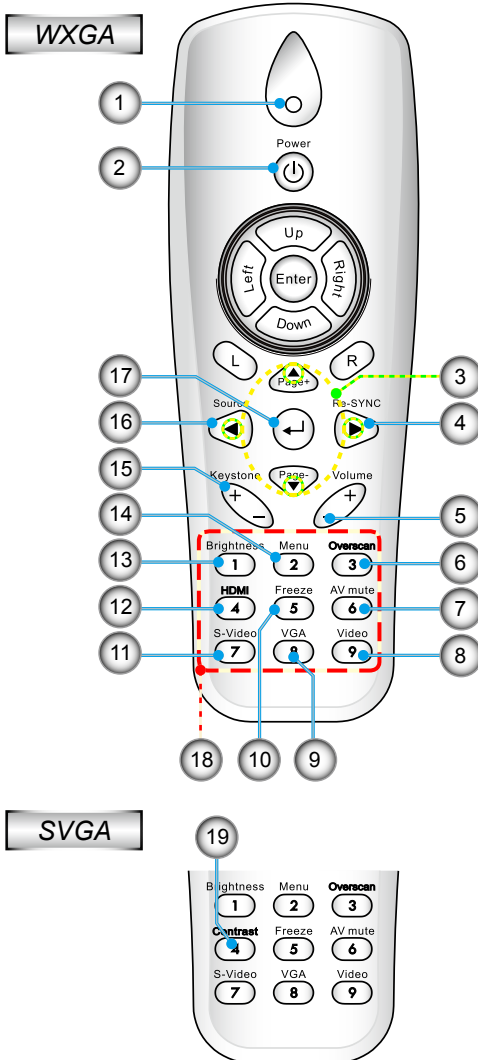

1. LED Indicator
2. Power On/Off
3. Four Directional Select Keys
4. Re-Sync
5. Volume +/-
6. Overscan
7. AV mute
8. Video
9. VGA
10. Freeze
11. S-Video
12. HDMI (For WXGA only)
13. Brightness
14. Menu
15. Keystone +/-
16. Source
17. Enter
18. Numbered keypad (for password input)
19. Contrast (For SVGA only)

# Installation

## Connecting the Projector

### Connect to Computer/Notebook

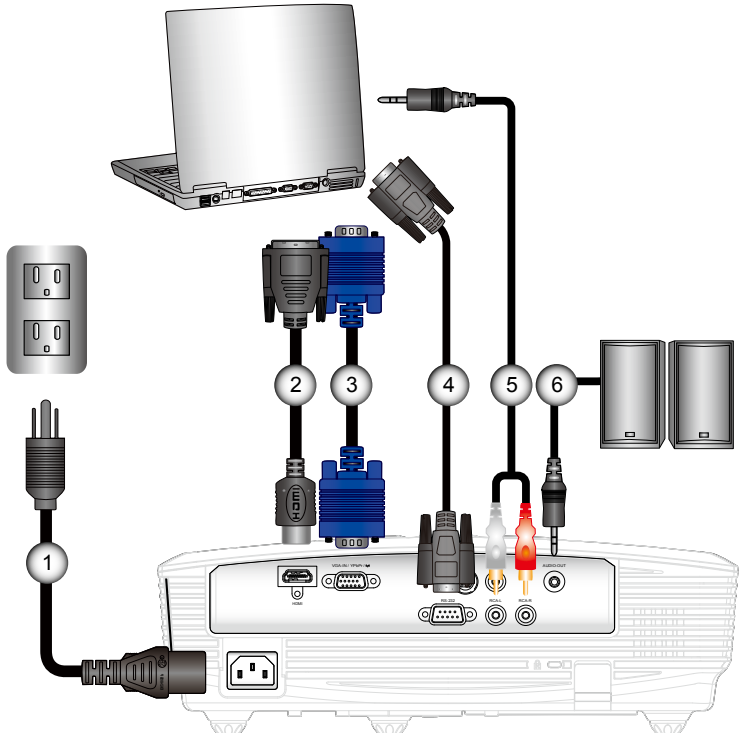

- ❖ Due to the difference in applications for each country, some regions may have different accessories.
- ❖ (\*) Optional accessory

1.....	Power Cord
2.....	*DVI/HDMI Cable
3.....	VGA Cable
4.....	*RS232 Cable
5.....	*Audio Input Cable
6.....	*Audio Output Cable

# Installation

## Connect to Video Sources

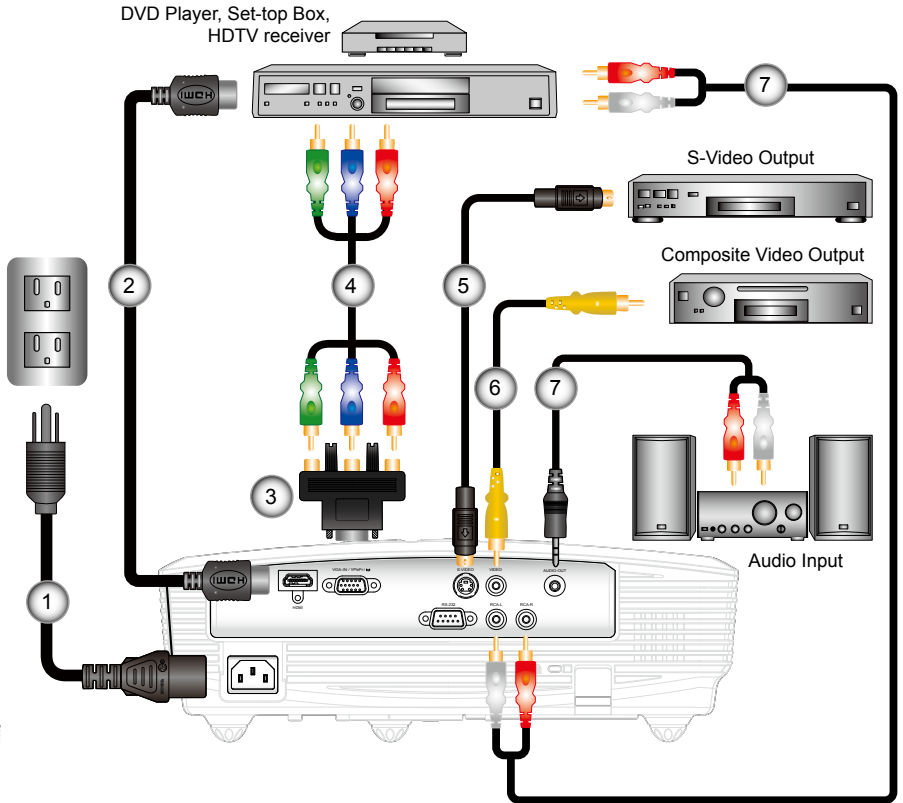

- ❖ Due to the difference in applications for each country, some regions may have different accessories.
- ❖ (\*) Optional accessory

1.....	Power Cord
2.....	*HDMI Cable
3.....	*15-Pin to 3 RCA Component/HDTV Adaptor
4.....	*3 RCA Component Cable
5.....	*S-Video Cable
6.....	*Composite Video Cable
7.....	*Audio Cable Jack/RCA

## Powering On/Off the Projector

### Powering On the Projector

1. Remove the lens cap. ❶
2. Securely connect the power cord and signal cable. When connected, the ON/STANDBY LED will turn Amber.
3. Turn on the lamp by pressing “” button either on the top of the projector or on the remote. The ON/STANDBY LED will now turn Green. ❷

The startup screen will display in approximately 10 seconds. The first time you use the projector, you will be asked to select the preferred language and power saving mode.

4. Turn on and connect the source that you want to display on the screen (computer, notebook, video player, etc). The projector will detect the source automatically. If not, push menu button and go to “OPTIONS”. Make sure that the “Source Lock” has been set to “Off”.
- ❖ If you connect multiple sources at the same time, press the “SOURCE” button on the control panel or direct source keys on the remote control to switch between inputs.

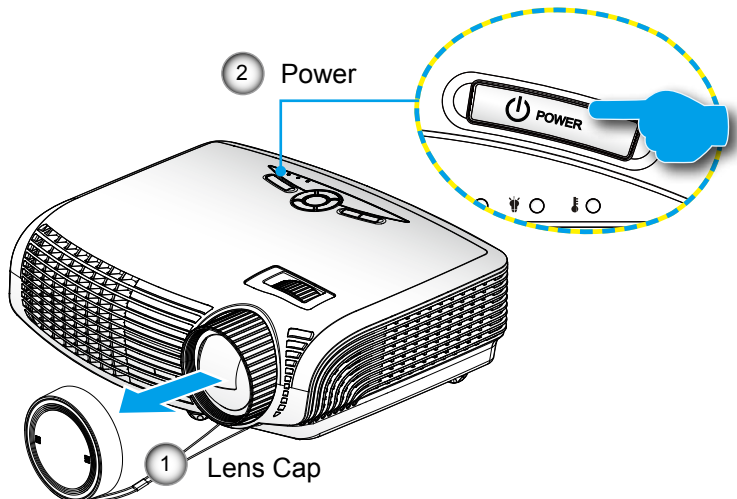

- ❖ Turn on the projector first and then select the signal sources.

## Powering Off the Projector

1. Press the “**⏻**” button on the remote control or on the control panel to turn off the projector. The following message will be displayed on the screen.

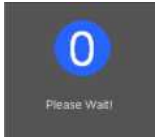

Press the “**⏻**” button again to confirm otherwise the message will disappear after 15 seconds. When you press the “**⏻**” button for the second time, the projector will display countdown timer and will shut down.

2. The cooling fans continue to operate for about 10 seconds for cooling cycle and the ON/STANDBY LED will Flash Green. When the ON/STANDBY LED lights solid Amber, the projector has entered standby mode.

If you wish to turn the projector back on, you must wait until the projector has completed the cooling cycle and has entered standby mode. Once in standby mode, simply press “**⏻**” button to restart the projector.

3. Disconnect the power cord from the electrical outlet and the projector.
4. Do not turn on the projector immediately following a power off procedure.

## Warning Indicator

When the warning indicators (see below) come on, the projector will automatically shutdown:



- ❖ Contact the nearest service center if the projector displays these symptoms. See pages 53-54 for more information.
- ❖ “LAMP” LED indicator is lit red and if “On/Standby” indicator flashes amber.
- ❖ “TEMP” LED indicator is lit red and if “On/Standby” indicator flashes amber. This indicates the projector has overheated. Under normal conditions, the projector can be switched back on.
- ❖ “TEMP” LED indicator flashes red and if “On/Standby” indicator flashes amber.

Unplug the power cord from the projector, wait for 30 seconds and try again. If the warning indicator light up again, please contact your nearest service center for assistance.

## Adjusting the Projected Image

### Adjusting the Projector's Height

*The projector is equipped with elevator feet for adjusting the image height.*

1. Locate the adjustable foot you wish to modify on the underside of the projector.
2. Rotate the adjustable rings clockwise/anticlockwise to lower or raise the projector. Repeat with the remaining feet as needed.

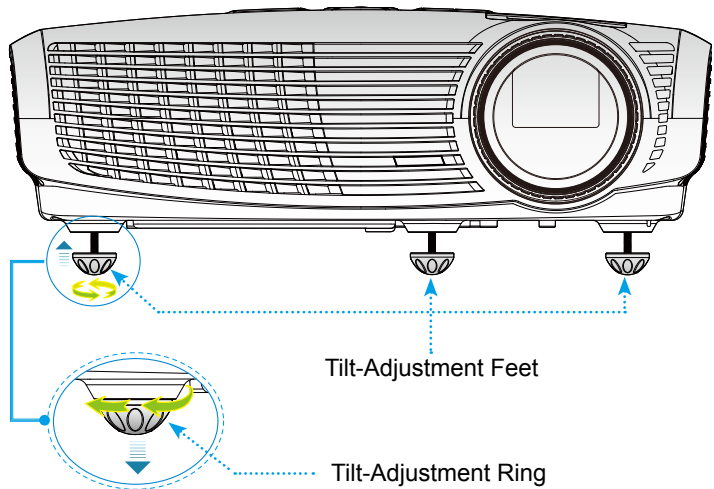

# Installation

## Adjusting the Projector's Focus

To focus the image, rotate the focus ring until the image is clear.

- ▶ SVGA series: The projector will focus at distances from 1.64 to 18.05 feet (0.5 to 5.5 meters).
- ▶ WXGA series: The projector will focus at distances from 1.64 to 16.40 feet (0.5 to 5.0 meters).

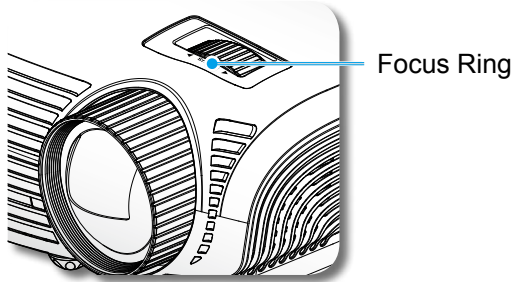

## Adjusting Projection Image Size

- ▶ SVGA series: Projection Image Size from 27.3" to 300.0" (0.7 to 7.6 meters).
- ▶ WXGA series: Projection Image Size from 34.0" to 322.0" (0.8 to 8.2 meters).

SVGA

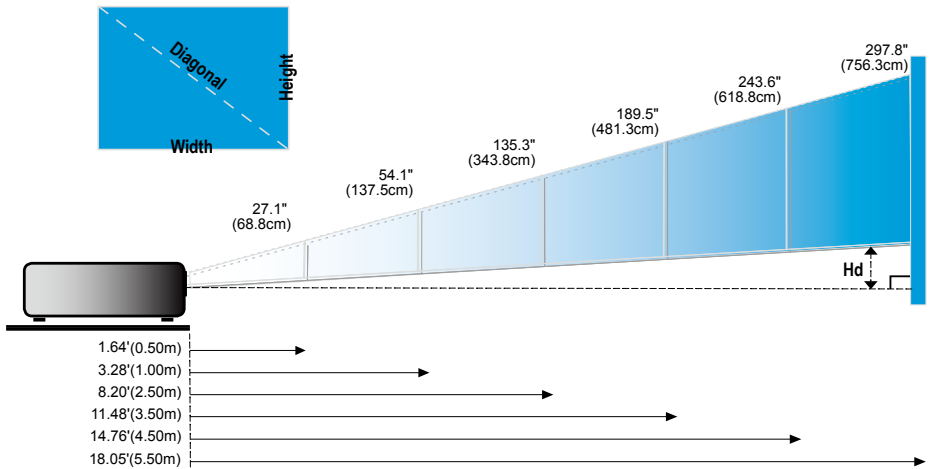



# Installation

Screen (Diagonal)	27.1" (68.8cm)	54.1" (137.5cm)	135.3" (343.8cm)	189.5" (481.3cm)	243.6" (618.8cm)	297.8" (756.3cm)
Screen Size (WxH)	21.7" x 16.3" 55.0 x 41.3cm	43.3" x 32.5" 110.0 x 82.5cm	108.2" x 81.2" 275.0 x 206.3cm	151.6" x 113.7" 385.0 x 288.8cm	194.9" x 146.2" 495.0 x 371.3cm	238.2" x 178.7" 605.0 x 453.8cm
Hd	2.44" (6.2cm)	4.87" (12.4cm)	12.18" (30.9cm)	17.06" (43.3cm)	21.92" (55.7cm)	26.80" (68.1cm)
Distance	1.64' (0.50m)	3.28' (1.00m)	8.20' (2.50m)	11.48' (3.50m)	14.76' (4.50m)	18.05' (5.5m)

❖ This table is for user's reference only.

WXGA

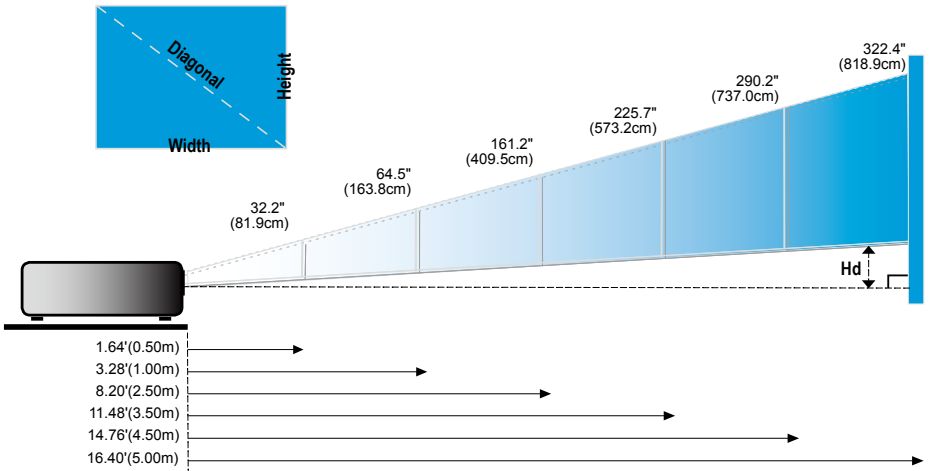

Screen (Diagonal)	32.2" (81.9cm)	64.5" (163.8cm)	161.2" (409.5cm)	225.7" (573.2cm)	290.2" (737.0cm)	322.4" (818.9cm)
Screen Size (WxH)	27.3" x 17.1" 69.5 x 43.4cm	54.7" x 34.2" 138.9 x 86.8cm	136.7" x 85.4" 347.3 x 217.0cm	191.4" x 119.6" 486.1 x 303.8cm	246.1" x 153.8" 625.0 x 390.6cm	273.4" x 170.9" 694.4 x 434.0cm
Hd	2.12" (5.4cm)	4.24" (10.8cm)	10.59" (26.9cm)	14.83" (37.7cm)	19.07" (48.4cm)	21.19" (53.8cm)
Distance	1.64' (0.50m)	3.28' (1.00m)	8.20' (2.50m)	11.48' (3.50m)	14.76' (4.50m)	16.40' (5.00m)

❖ This table is for user's reference only.

## Control Panel & Remote Control

### Control Panel

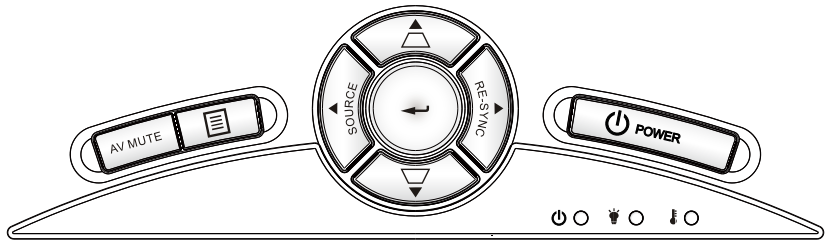

#### Using the Control Panel





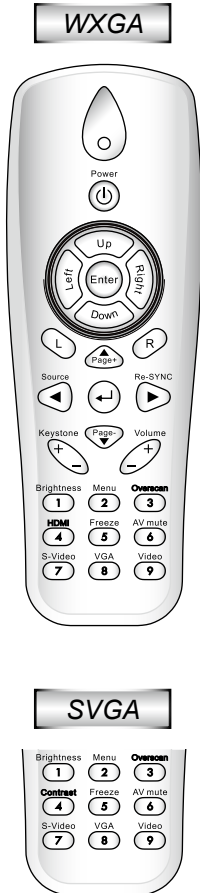

POWER		Refer to the "Power On/Off the Projector" section on pages 13-14.
RE-SYNC		Automatically synchronize the projector to the input source.
Enter		Confirm your item selection.
SOURCE		Press "SOURCE" to select an input signal.
Menu		Press "Menu" to launch the on-screen display (OSD) menu. To exit OSD, Press "Menu" again.
AV MUTE		Momentarily turns off/on the audio and video.
Four Directional Select Keys		Use     to select items or make adjustments to your selection.
Keystone		Use   to adjust image distortion caused by tilting the projector. ( $\pm 40$ degrees)
Lamp LED		Indicate the projector's lamp status.
Temp LED		Indicate the projector's temperature status.
ON/STAND-BY LED		Indicate the projector's status.

# User Controls

## Remote Control

### Using the Remote Control



Power 	Refer to the “Power On/Off the Projector” section on pages 13-14.
Contrast	Adjust the contrast of the image. (For SVGA only)
L Button	No function.
R Button	No function.
Page +	No function.
Page -	No function.
Enter 	Confirm your item selection.
Source	Press “Source” to select an input signal.
Re-SYNC	Automatically synchronizes the projector to the input source.
Four Directional Select Keys	Use     to select items or make adjustments to your selection.
Keystone +/-	Adjust image distortion caused by tilting the projector.
Volume +/-	Adjust to increase / decrease the volume.
Brightness	Adjust the brightness of the image.
Menu	Press “Menu” to launch the on-screen display (OSD) menu. To exit OSD, press “Menu” again.
Overscan	Mask off a few pixels on each edge of the image to be displayed. Use the function to adjust if image source happens to have noise near any edge of the display image.

# User Controls

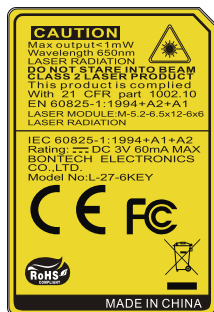

## Using the Remote Control

HDMI	Press “HDMI” to choose HDMI source. (For WXGA only)
Freeze	Press “Freeze” to pause the screen image. Press this button again to unlock.
AV mute	Momentarily turns off/on the audio and video.
S-Video	Press “S-Video” to choose S-Video source.
VGA	Press “VGA” to choose VGA sources.
Video	Press “Video” to choose Composite video source.

## On-screen Display Menus

*The Projector has multilingual On-screen Display menus that allow you to make image adjustments and change a variety of settings. The projector will automatically detect the source.*

### How to operate

1. To open the OSD menu, press “Menu” on the Remote Control or Projector Keypad.
2. When OSD is displayed, use ◀▶ keys to select any item in the main menu. While making a selection on a particular page, press ▼ or “Enter” key to enter sub menu.
3. Use ▲▼ keys to select the desired item and adjust the settings using ◀▶ key.
4. Select the next item to be adjusted in the sub menu and adjust as described above.
5. Press “Enter” to confirm, and the screen will return to the main menu.
6. To exit, press “MENU” again. The OSD menu will close and the projector will automatically save the new settings.

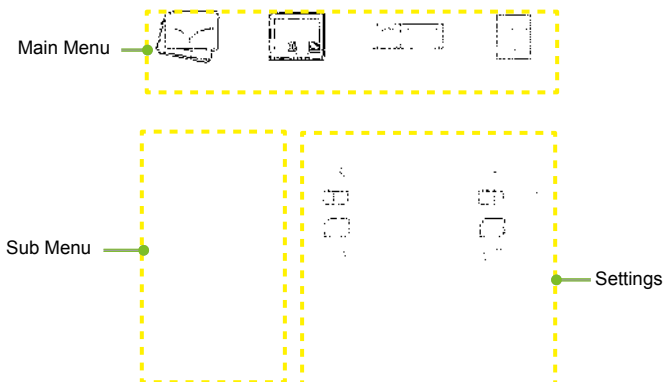

# User Controls

## Menu Tree

Main Menu	Sub Menu	Settings
<b>IMAGE</b>	Display Mode	Cinema / Bright / Presentation / Game / Blackboard / Classroom / User / 3D
	Contrast	
	Brightness	
	#1 Color	
	#1 Tint	
	Sharpness	
	Advanced	BrilliantColor™ 0-10
		Gamma Film / Video / Graphics / Standard
		Color Temp. Warm / Medium / Cold
		Color Settings Red Gain / Green Gain / Blue Gain / Red Bias / Green Bias / Blue Bias / Reset / Exit
		Color Space AUTO / RGB / YCbCr
	Input Source VGA / Video / S-Video / HDMI	
	Exit	
<b>DISPLAY</b>	Format	#2 4:3 / 16:9-I / 16:9-II / Native / AUTO
		#3 4:3 / 16:9 / 16:10 / Native / AUTO
	Overscan	-10 ~ +40
	Edge Mask	0~10
	V Image Shift	-50 ~ +50
	V Keystone	-40 ~ +40
	3D	3D Mode Off / DLP-Link / IR
	#4 3D Sync. Invert On / Off	
<b>SETUP</b>	Language	English / Deutsch / Français / Italiano / Español / Português / Svenska / Nederlands / Norsk/Dansk / Polski / Русский / ελληνικά / Magyar / Čeština / العربية / 繁體中文 / 简体中文 / 日本語 / 한국어 / Türkçe
	Projection	
	Menu Location	
	Security	Security On / Off
		Timer-Month 0-12
		Timer-Day 0-30
		Timer-Hour 0-24
		Change Password
		Exit
	#5 Signal	Automatic Enable / Disable
	Phase (VGA)	
	Frequency (VGA)	
	H. Position (VGA)	
	V. Position (VGA)	
	Exit	
	Projector ID 00~99	
	Mute On / Off	
	Volume 0~10	
	Wireless On / Off	

# User Controls

Main Menu	Sub Menu	Settings	
<b>OPTIONS</b>	Source Lock	On / Off	
	High Altitude	On / Off	
	Information Hide	On / Off	
	Keypad Lock	On / Off	
	Background Color	Black / Red / Blue / Green / White	
	Test Pattern	None / Grid / White Pattern	
	Advanced	Direct Power On	On / Off
		Auto Power Off (min)	0-180
		Sleep Timer (min)	0-995
		Exit	
		Lamp Settings	
	Lamp Settings	Lamp Hours	
		Lamp Reminder	On / Off
		Brightness Mode	STD / BRIGHT
		Lamp Reset	Yes/No
		Exit	
	Reset		



- ❖ Please note that the on-screen display (OSD) menus vary according to the signal type selected and the projector model you are using.
- ❖ (#1) "Color" and "Tint" are only supported in Video mode.
- ❖ (#2) For SVGA only.
- ❖ (#3) For WXGA only
- ❖ (#4) "3D Sync Invert" is only available when using DLP Link mode.
- ❖ (#5) "Signal" is only supported in Analog VGA (RGB) signal.



## IMAGE

### Display Mode

There are many factory presets optimized for various types of images.

- ▶ Presentation: Good color and brightness from PC input.
- ▶ Bright: Maximum brightness from PC input.
- ▶ Cinema: For home theater.
- ▶ Game: For game mode.
- ▶ Blackboard: This mode should be selected to achieve optimum color settings when projecting onto a blackboard (green).
- ▶ Classroom: This mode is recommended for projecting in a classroom.
- ▶ User: User's settings.
- ▶ 3D: The initial default setting of this mode is DLP-Link. Any further adjustments by the user in 3D will be saved in this mode for further use.

### Contrast

The contrast controls the degree of difference between the lightest and darkest parts of the picture.

- ▶ Press the ◀ to decrease the contrast.
- ▶ Press the ▶ to increase the contrast.

### Brightness

Adjust the brightness of the image.

- ▶ Press the ◀ to darken image.
- ▶ Press the ▶ to lighten the image.





- ❖ “Color” and “Tint” functions are only supported under Video mode.

## Color

Adjust a video image from black and white to fully saturated color.

- ▶ Press the ◀ to decrease the amount of saturation in the image.
- ▶ Press the ▶ to increase the amount of saturation in the image.

## Tint

Adjust the color balance of red and green.

- ▶ Press the ◀ to increase the amount of green in the image.
- ▶ Press the ▶ to increase the amount of red in the image.

## Sharpness

Adjust the sharpness of the image.

- ▶ Press the ◀ to decrease the sharpness.
- ▶ Press the ▶ to increase the sharpness.



## IMAGE | Advanced

### BrilliantColor™

This adjustable item utilizes a new color-processing algorithm and system level enhancements to enable higher brightness while providing true, more vibrant colors in picture. The range is from "0" to "10". If you prefer a stronger enhanced image, adjust toward the maximum setting. For a smoother, more natural image, adjust toward the minimum setting.

### Degamma

This allows you to choose a degamma table that has been fine-tuned to bring out the best image quality for the input.





- ▶ Film: for home theater.
- ▶ Video: for video or TV source.
- ▶ Graphics: for image source.
- ▶ Standard: for PC or computer source.

### Color Temp

Adjust the color temperature. With cold temperature, the screen looks colder; with warm temperature, the screen looks warmer.

# User Controls

## Color Setting

Press  into the next menu as below and then use  or  to select item. Use  or  to select Red, Green, or Blue for brightness (Gain) and contrast (Bias).

Red	0.0
Green	0.0
Blue	0.0
Red	0.0
Green	0.0
Blue	0.0
Red	0.0
Green	0.0
Blue	0.0

## Color Space

Select an appropriate color matrix type from AUTO, RGB or YUV.

## Input Source

Use this option to enable / disable input sources. Press  to enter the sub menu and select which sources you require. Press "Enter" to finalize the selection. The projector will not search for inputs that are not selected.



## DISPLAY

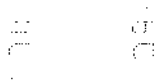

### Format

Use this function to choose your desired aspect ratio.

#### SVGA

- ▶ 4:3: This format is for 4×3 input sources.
- ▶ 16:9-I: This format is for 16×9 input sources, like HDTV and DVD enhanced for Wide screen TV. (576i/p)
- ▶ 16:9-II: This format is for 16×9 input sources, like HDTV and DVD enhanced for Wide screen TV. (480i/p)
- ▶ Native: This format displays the original image without any scaling.
- ▶ AUTO: Automatically selects the appropriate display format.

Aspect ratio (source detected)	Resize image
	SVGA model
4:3	800 x 600 center
16:9-I	800 x 450 center
16:9-II	854 x 480 center, only display 800 x 480
Native	Resize image of native change to above description not pixels resolution.

## WXGA

- ▶ 4:3: This format is for 4×3 input sources.
- ▶ 16:9: This format is for 16×9 input sources, like HDTV and DVD enhanced for Wide screen TV.
- ▶ 16:10: This format is for 16×10 input sources, like widescreen laptops.
- ▶ Native: This format displays the original image without any scaling.
- ▶ AUTO: Automatically selects the appropriate display format.

Aspect ratio (source detected)	Resize image WXGA model
4:3	1067 x 800 center
16:9	1280 x 720 center
16:10	1280 x 800 center
Native	Resize image of native change to above description not pixels resolution.



- ❖ Each I/O has different setting of “Overscan”.
- ❖ “Overscan” and “Edge Mask” can’t work at same time.

## Overscan

Overscan function removes the noise in a video image. Overscan the image to remove video encoding noise on the edge of video source.

## Edge Mask

- ▶ Press the ◀ to reduce the size of an image.
- ▶ Press the ▶ to magnify an image on the projection screen.

## V Image Shift

Shift the projected image position vertically.

## V Keystone

Press the ◀ or ▶ to adjust image distortion vertically. If the image looks trapezoidal, this option can help make the image rectangular.

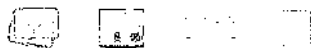

## DISPLAY | 3D



- ❖ “IR” options may vary according to model.
- ❖ “3D Sync Invert” is only available when using DLP Link mode.

### 3D Mode

- ▶ Off: Select “Off” to turn 3D settings off for 3D images.
- ▶ DLP Link: Select “DLP Link” to use optimized settings for DLP Link 3D images.
- ▶ IR: Select “IR” to use optimized settings for IR-based 3D glasses.

### 3D Sync. Invert

- ▶ Press the “On” to invert left and right frame contents.
- ▶ Press the “Off” for default frame contents.

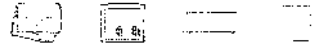

## SETUP

### Language

Choose the multilingual OSD menu. Press ◀ or ▶ into the sub menu and then use the ▲ or ▼ key to select your preferred language. Press “Enter” to finalize the selection.



- ❖ Rear-Desktop and Rear-Ceiling are to be used with a translucent screen.

### Projection

- ▶  Front-Desktop

This is the default selection. The image is projected straight on the screen.

- ▶  Rear-Desktop

When selected, the image will appear reversed.

- ▶  Front-Ceiling

When selected, the image will turn upside down.

# User Controls



- ❖ “Wireless” is only functional with VGA connector

**⚠ Warning:** Wired VGA will not function and projector may shut down if it is connected when Wireless is turned on.

- ❖ Optional wireless dongle is needed to use the wireless function on the projector.

- ▶  Rear-Ceiling

When selected, the image will appear reversed in upside down position.

## Menu Location

Choose the menu location on the display screen.

## Projector ID

ID definition can be set up by menu (range 0~99), and allow user control an individual projector by RS232. Refer to page 48 for the complete list of RS232 commands.

## Mute

- ▶ Choose the “On” to turn mute on.
- ▶ Choose the “Off” to turn mute off.

## Volume

- ▶ Press the ◀ to decrease the volume.
- ▶ Press the ▶ to increase the volume.

## Wireless

Choose the “On” to turn on the Wireless.





## SETUP | Security

### Security

- ▶ On: Choose “On” to use security verification when the turning on the projector.
- ▶ Off: Choose “Off” to be able to switch on the projector without password verification.









- ❖ Pass-code default value is “1234” (first time).

### Security Timer

Can be select the time (Month/Day/Hour) function to set the number of hours the projector can be used. Once this time has elapsed you will be requested to enter your password again.

### Change Password

- ▶ First time:
  1. Press “” to set the password.
  2. The password has to be 4 digits.
  3. Use number button on the remote to enter your new password and then press “” key to confirm your password.
- ▶ Change Password:
  1. Press “” to input old password.
  2. Use number button to enter current password and then press “” to confirm.
  3. Enter new password (4 digits in length) using the number buttons on the remote, then press “” to confirm.
  4. Enter new password again and press “” to confirm.

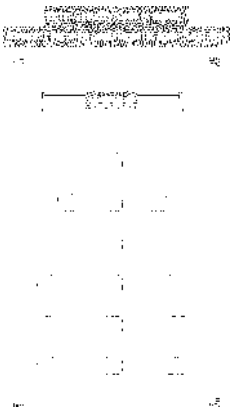

# User Controls

- ▶ If the incorrect password is entered 3 times, the projector will automatically shut down.
- ▶ If you have forgotten your password, please contact your local office for support.



## SETUP | Signal



- ❖ “Signal” is only supported in Analog VGA (RGB) signal.

### Automatic

Automatically selects the signal. If you use this function, the Phase, frequency items are grayed out, and if Signal is not automatic, the phase, frequency items will appear for user to manually tune and saved in settings after that for next time projector turns off and on again.

### Phase

Synchronize the signal timing of the display with the graphic card. If the image appears to be unstable or flickers, use this function to correct it.

### Frequency

Change the display data frequency to match the frequency of your computer's graphic card. Use this function only if the image appears to flicker vertically.

### H. Position

- ▶ Press the ◀ to move the image left.
- ▶ Press the ▶ to move the image right.

### V. Position

- ▶ Press the ◀ to move the image down.
- ▶ Press the ▶ to move the image up.



## OPTIONS

### Source Lock

- ▶ On: The projector will only search current input connection.
- ▶ Off: The projector will search for other signals if the current input signal is lost.

### High Altitude

When “On” is selected, the fans will spin faster. This feature is useful in high altitude areas where the air is thin.

### Information Hide

- ▶ On: Choose “On” to hide the info message.
- ▶ Off: Choose “Off” to show the “searching” message.



- ❖ To turn off the keypad lock, press and hold “Enter” key on top of the projector for 5 seconds.

### Keypad Lock

When the keypad lock function is “On”, the control panel will be locked however, the projector can be operated by the remote control. By selecting “Off”, you will be able to reuse the control panel.

### Background Color

Use this feature to display a “Black”, “Red”, “Blue”, “Green” or “White”, screen when no signal is available.

### Test Pattern

Display a test pattern. There are Grid, White pattern and None.

### Reset

Choose “Yes” to return the display parameters on all menus to the factory default settings.



## **OPTIONS | Advanced**

### Direct Power On

Choose “On” to activate Direct Power mode. The projector will automatically power on when AC power is supplied, without pressing the “” key on the projector control panel or on the remote control.

### Auto Power Off (min)

Sets the countdown timer interval. The countdown timer will start, when there is no signal being sent to the projector. The projector will automatically power off when the countdown has finished (in minutes).

### Sleep Timer (min)

Sets the countdown timer interval. The countdown timer will start, with or without a signal being sent to the projector. The projector will automatically power off when the countdown has finished (in minutes).



## OPTIONS | Lamp Settings

### Lamp Hours

Display the projection time.

### Lamp Reminder

Choose this function to show or to hide the warning message when the changing lamp message is displayed.

The message will appear 30 hours before suggested replacement of lamp.



❖ When ambient temperature is over 35°C in operating, the projector will switch to STD automatically.

### Brightness Mode

- ▶ STD: Choose “STD” to dim the projector lamp which will lower power consumption and extend the lamp life.
- ▶ BRIGHT: Choose “BRIGHT” to increase the brightness.

### Lamp Reset

Reset the lamp hour counter after replacing the lamp.

## Troubleshooting

*If you experience a problem with your projector, please refer to the following information. If a problem persists, please contact your local reseller or service center.*

### **?** No image appears on-screen

- ▶ Ensure all the cables and power connections are correctly and securely connected as described in the “Installation” section.
- ▶ Ensure all the pins of connectors are not bent or broken.
- ▶ Check if the projection lamp has been securely installed. Please refer to the “Replacing the lamp” section.
- ▶ Make sure you have removed the lens cap and the projector is switched on.
- ▶ Ensure that the “AV mute” feature is not turned on.

### **?** Partial, scrolling or incorrectly displayed image

- ▶ Press “Re-SYNC” on the remote.
- ▶ If you are using a PC:

For Windows 95, 98, 2000, XP, Windows 7:

1. Open the “My Computer” icon, the “Control Panel” folder, and then double click on the “Display” icon.
2. Select the “Settings” tab.
3. Verify that your display resolution setting is lower than or equal to UXGA (1600 × 1200).
4. Click on the “Advanced Properties” button.

If the projector is still not projecting the whole image, you will also need to change the monitor display you are using. Refer to the following steps.

5. Verify the resolution setting is lower than or equal to UXGA (1600 × 1200).
6. Select the “Change” button under the “Monitor” tab.

# Appendices

7. Click on “Show all devices”. Next, select “Standard monitor types” under the SP box; choose the resolution mode you need under the “Models” box.
  8. Verify that the resolution setting of the monitor display is lower than or equal to UXGA (1600 × 1200).
- ▶ If you are using a Notebook:
1. First, follow the steps above to adjust resolution of the computer.
  2. Press the appropriate keys listed below for your notebook manufacturer to send signal out from notebook to projector.  
Example: [Fn]+[F4]

Acer ⇨	[Fn]+[F5]	IBM/Lenovo ⇨	[Fn]+[F7]
Asus ⇨	[Fn]+[F8]	HP/Compaq ⇨	[Fn]+[F4]
Dell ⇨	[Fn]+[F8]	NEC ⇨	[Fn]+[F3]
Gateway ⇨	[Fn]+[F4]	Toshiba ⇨	[Fn]+[F5]

Mac Apple:  
System Preference ⇨ Display ⇨ Arrangement ⇨ Mirror display

- ▶ If you experience difficulty changing resolutions or your monitor freezes, restart all equipment including the projector.

**[?]** The screen of the Notebook or PowerBook computer is not displaying your presentation

- ▶ If you are using a Notebook PC  
Some Notebook PCs may deactivate their own screens when a second display device is in use. Each has a different way to be reactivated. Refer to your computer’s manual for detailed information.

**[?]** Image is unstable or flickering

- ▶ Use “Phase” to correct it. See page 35 for more information.  
▶ Change the monitor color setting on your computer.

**[?]** Image has vertical flickering bar

- ▶ Use “Frequency” to make an adjustment. See page 35 for more information.  
▶ Check and reconfigure the display mode of your graphic card to make it compatible with the projector.



## **[?] Image is out of focus**

- ▶ Make sure the lens cap is removed.
- ▶ Adjust the Focus Ring on the projector lens.
- ▶ Make sure the projection screen is between the required distance. See page 16.

## **[?] The image is stretched when displaying 16:9 DVD title**

- ▶ When you play anamorphic DVD or 16:9 DVD, the projector will show the best image when the projector display mode is set to 16:9 in the OSD.
- ▶ If you play 4:3 format DVD titles, please change the format to 4:3 in the projector OSD.
- ▶ If the image is still stretched, you will also need to adjust the aspect ratio by referring to the following:
- ▶ Please setup the display format as 16:9 (wide) aspect ratio type on your DVD player.



## **[?] Image is too small or too large**

- ▶ Move the projector closer to or further from the screen.
- ▶ Press “Menu” button on the remote control or projector panel, go to “DISPLAY → Format” and try the different settings.



❖ Use of Keystone is not recommended.

## **[?] Image has slanted sides**

- ▶ If possible, reposition the projector so that it is horizontally centered on the screen and below the bottom of the screen.
- ▶ Press “Keystone +/-” button on the remote control or press “ / ” on the projector panel, until the sides are vertical.

## **[?] Image is reversed**

- ▶ Select “SETUP → Projection” from the OSD and adjust the projection direction.

# Appendices



















## **[?]** The projector stops responding to all controls

- ▶ If possible, turn off the projector, then unplug the power cord and wait at least 60 seconds before reconnecting power.
- ▶ Check that “Keypad Lock” is not activated by trying to control the projector with the remote control.



## **[?]** Lamp burns out or makes a popping sound

- ▶ When the lamp reaches its end of life, it will burn out and may make a loud popping sound. If this happens, the projector will not turn on until the lamp module has been replaced. To replace the lamp, follow the procedures in the “Replacing the Lamp” section on pages 44-45.

## **[?]** LED lighting message

Message	  ON/STANDBY LED (Green/Amber)	  Temp-LED (Red)	  Lamp-LED (Red)
	Standby State (Input power cord)	Amber	
Power on (Warming)	Flashing Green		
Lamp lighting	Green		
Power off (Cooling)	Flashing Green		
Error (Over Temp.)	Flashing Amber		
Error (Fan fail)	Flashing Amber	Flashing	
Error (Lamp fail)	Flashing Amber		



Steady light ⇒   
 No light ⇒ 

\* ON/STANDBY LED be ON when OSD appears, be OFF when OSD disappears.

## **[?]** On Screen Messages

- ▶ Temperature warning:

- ▶ Fan failed:

- ▶ Lamp warning:



- ▶ Out of display range:



## **[?]** If the remote control does not work

- ▶ Check the operating angle of the remote control is within  $\pm 15^\circ$  both horizontally and vertically of one of the IR receivers on the projector.
- ▶ Make sure there are not any obstructions between the remote control and the projector. Move to within 7 m ( $\pm 0^\circ$ ) of the projector.
- ▶ Make sure the batteries are inserted correctly.
- ▶ Replace batteries if they are exhausted.

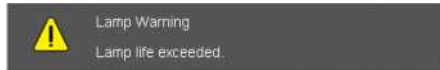

## Replacing the lamp

The projector automatically detects the lamp life. When the lamp life is nearing the end of use, you will receive a warning message.

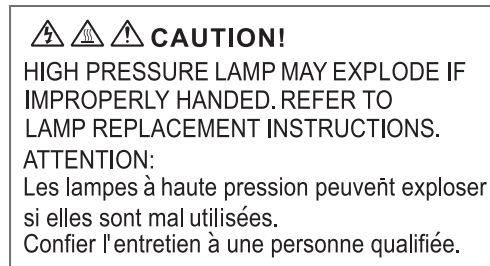

When you see this message, please contact your local reseller or service center to change the lamp as soon as possible. Make sure the projector has been cooled down for at least 30 minutes before changing the lamp.



-  Warning: If ceiling mounted, please use caution when opening the lamp access panel. It is recommended to wear safety glasses if changing the bulb when ceiling mounted. "Caution must be used to prevent any loose parts from falling out of projector."
-  Warning: Lamp compartment may be hot! Allow it to cool down before changing the lamp!
-  Warning: To reduce the risk of personal injury, do not drop the lamp module or touch the lamp bulb. The bulb may shatter and cause injury if it is dropped.



- ❖ The screws on the lamp cover and the lamp cannot be removed.
- ❖ The projector cannot be turned on if the lamp cover has not been placed back on the projector.
- ❖ Do not touch the glass area of the lamp. Hand oil can cause the lamp to shatter. Use a dry cloth to clean the lamp module if it was accidentally touched.

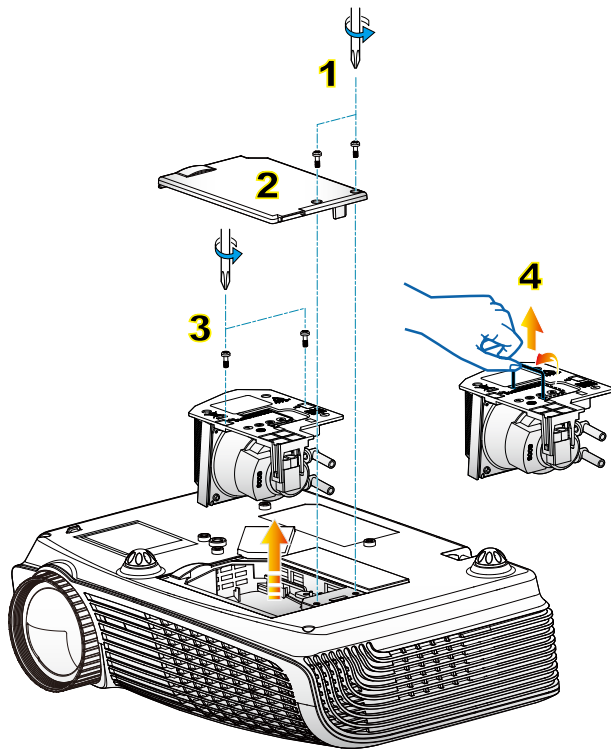

## Lamp Replacement Procedure:

1. Switch off the power to the projector by pressing the “” button.
  2. Allow the projector to cool down for at least 30 minutes.
  3. Disconnect the power cord.
  4. Unscrew the two screws on the cover. **1**
  5. Lift up and remove the cover. **2**
  6. Unscrew the two screws on the lamp module. **3**
  7. Lift up the lamp handle and remove the lamp module slowly and carefully. **4**
- To replace the lamp module, reverse the previous steps.
8. Turn on the projector and use “Lamp Reset” after the lamp module is replaced.

Lamp Reset: (i) Press “Menu” → (ii) Select “OPTIONS” → (iii) Select “Lamp Settings” → (iv) Select “Lamp Reset” → (v) Select “Yes”.

## Compatibility Modes

### ► Computer Compatibility

Mode	Resolution	V-Sync (Hz)		H-Sync (KHz)	
		Anglog	Digital	Anglog	Digital
VGA	640 × 350	70	70	31.50	31.50
VGA	640 × 350	85	85	37.90	37.90
VGA	640 × 400	85	85	37.90	37.90
VGA	640 × 480	60	60	31.50	31.50
VGA	640 × 480	67	67	-	-
VGA	640 × 480	72	72	37.90	37.90
VGA	640 × 480	75	75	37.50	37.50
VGA	720 × 400	70	70	31.50	31.50
VGA	720 × 400	85	85	37.90	37.90
SVGA	800 × 600	56	56	35.20	35.20
SVGA	800 × 600	60	60	37.90	37.90
SVGA	800 × 600	72	72	48.10	48.10
SVGA	800 × 600	75	75	46.90	46.90
SVGA	800 × 600	120	120	-	-
XGA	1024 × 768	60	60	48.40	48.40
XGA	1024 × 768	70	70	56.50	56.50
XGA	1024 × 768	75	75	60.00	60.00
XGA	1024 × 768	120	120	-	-
WXGA	1280 × 800	60	60	49.68	49.64
SXGA	1280 × 1024	60	60	63.98	63.98
SXGA+	1400 × 1050	60	60	63.98	63.98
UXGA	1600 × 1200	60	60	75.00	75.00
WSXGA+ (*)	1680 × 1050	60	60	65.00	65.00
HD	1280 × 720	60	60	45.00	45.00
HD	1280 × 720	120	120	-	-
HD	1920 × 1080	60	60	-	-



- ❖ For widescreen resolution (WXGA), the compatibility support is dependent on Notebook/PC models.
- ❖ 120Hz input signals may be dependent on graphics cards support.
- ❖ (\*) For WXGA only.

# Appendices

## ▶ Computer Compatibility

Mode	Resolution	V-Sync (Hz)	H-Sync (KHz)
MAC LC 13"	640 × 480	66.66	34.98
MAC II 13"	640 × 480	66.68	35.00
MAC 16"	832 × 624	74.55	49.73
MAC 19"	1024 × 768	75	60.24
MAC	1152 × 870	75.06	68.68
MAC G4	640 × 480	60	31.35
i MAC DV	1024 × 768	75	60.00
i MAC DV	1152 × 870	75	68.49

## ▶ Video Compatibility

NTSC	M (3.58MHz), 4.43 MHz
PAL	B, D, G, H, I, M, N
SECAM	B, D, G, K, K1, L
SDTV/HDTV	480i/p, 576i/p, 720p@50Hz/60Hz, 1080i/p@50Hz/60Hz

## RS232 Commands and Protocol Function List

### RS232 Pin Assignments

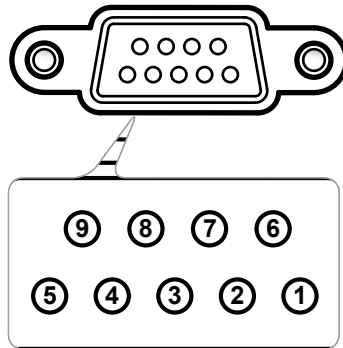

Pin no.	Spec. (from projector side)
1	N/A
2	RXD
3	TXD
4	N/A
5	GND
6	N/A
7	N/A
8	N/A
9	N/A



# Appendices

## RS232 Protocol Function List



1. There is a <CR> after all ASCII commands.
2. 0D is the HEX code for <CR> in ASCII code.

Baud Rate : 9600  
 Data Bits: 8  
 Parity: None  
 Stop Bits: 1  
 Flow Control : None  
 UART16550 FIFO: Disable  
 Projector Return (Pass): P  
 Projector Return (Fail): F

XX=00-99, projector's ID,  
 XX=00 is for all projectors

### SEND to projector

132 ASCII Code	HEX Code	Function	Description
--XX00 1	7E 30 30 30 30 20 31 0D	Power ON	
--XX00 0	7E 30 30 30 30 20 30 0D	Power OFF	(0/2 for backward compatible)
--XX00 1 ~nmnn	7E 30 30 30 30 20 31 20 a 0D	Power ON with Password	-nmnn = -0000 (a=7E 30 30 30 30) - -9999(a=7E 39 39 39 39)
--XX01 1	7E 30 30 30 31 20 31 0D	Resync	
--XX02 1	7E 30 30 30 32 20 31 0D	AV Mute	On
--XX02 0	7E 30 30 30 32 20 30 0D		Off(0/2 for backward compatible)
--XX03 1	7E 30 30 30 33 20 31 0D	Mute	On
--XX03 0	7E 30 30 30 33 20 30 0D		Off(0/2 for backward compatible)
--XX04 1	7E 30 30 30 34 20 31 0D	Freeze	
--XX04 0	7E 30 30 30 34 20 30 0D	Unfreeze	(0/2 for backward compatible)
--XX05 1	7E 30 30 30 35 20 31 0D	Zoom Plus	
--XX06 1	7E 30 30 30 36 20 31 0D	Zoom Minus	
--XX12 5	7E 30 30 31 32 20 35 0D	Direct Source Commands	VGA
--XX12 8	7E 30 30 31 32 20 38 0D		VGA Component
--XX12 9	7E 30 30 31 32 20 39 0D		S-Video
--XX12 10	7E 30 30 31 32 20 31 30 0D		Video
--XX20 1	7E 30 30 32 30 20 31 0D	Display Mode	Presentation
--XX20 2	7E 30 30 32 30 20 32 0D		Bright
--XX20 5	7E 30 30 32 30 20 35 0D		User
--XX20 7	7E 30 30 32 30 20 37 0D		Blackboard
--XX20 8	7E 30 30 32 30 20 38 0D		Classroom
--XX20 11	7E 30 30 32 30 20 31 31 0D		Cinema
--XX20 5	7E 30 30 32 30 20 35 0D		User
--XX20 9	7E 30 30 32 30 20 39 0D		3D
--XX21 n	7E 30 30 32 31 20 a 0D	Brightness	n = 0 (a=30) ~ 100 (a=31 30 30)
--XX22 n	7E 30 30 32 32 20 a 0D	Contrast	n = 0 (a=30) ~ 100 (a=31 30 30)
--XX23 n	7E 30 30 32 33 20 a 0D	Sharpness	n = 0 (a=30) ~ 31 (a=33 31)
--XX24 n	7E 30 30 32 34 20 a 0D	Color Settings	Red Gain n = -50 (a=2D 35 30) ~ 50 (a=35 30)
--XX25 n	7E 30 30 32 35 20 a 0D		Green Gain n = -50 (a=2D 35 30) ~ 50 (a=35 30)
--XX26 n	7E 30 30 32 36 20 a 0D		Blue Gain n = -50 (a=2D 35 30) ~ 50 (a=35 30)
--XX27 n	7E 30 30 32 37 20 a 0D		Red Bias n = -50 (a=2D 35 30) ~ 50 (a=35 30)
--XX28 n	7E 30 30 32 38 20 a 0D		Green Bias n = -50 (a=2D 35 30) ~ 50 (a=35 30)
--XX29 n	7E 30 30 32 39 20 a 0D		Blue Bias n = -50 (a=2D 35 30) ~ 50 (a=35 30)
--XX33 1	7E 30 30 33 33 20 31 0D		Reset
--XX34 n	7E 30 30 33 34 20 a 0D	BrilliantColor™	n = 0 (a=30) ~ 10 (a=31 30)
--XX35 1	7E 30 30 33 35 20 31 0D	Degamma	Film
--XX35 2	7E 30 30 33 35 20 32 0D		Video
--XX35 3	7E 30 30 33 35 20 33 0D		Graphics
--XX35 4	7E 30 30 33 35 20 34 0D		Standard
--XX36 1	7E 30 30 33 36 20 31 0D	Color Temp.	Warm
--XX36 2	7E 30 30 33 36 20 32 0D		Medium
--XX36 3	7E 30 30 33 36 20 33 0D		Cold
--XX37 1	7E 30 30 33 37 20 31 0D	Color Space	Auto
--XX37 2	7E 30 30 33 37 20 32 0D		RGB
--XX37 3	7E 30 30 33 37 20 33 0D		YUV
--XX44 n	7E 30 30 34 34 20 a 0D	Color (Saturation)	n = 0 (a=30) ~ 100 (a=31 30 30)
--XX45 n	7E 30 30 34 35 20 a 0D	Tint (Hue)	n = 0 (a=30) ~ 100 (a=31 30 30)

# Appendices

~XX60 1	7E 30 30 36 30 20 31 0D	Format	4:3
~XX60 2	7E 30 30 36 30 20 32 0D		16:9-I (for ESS23ST) / 16:9 (for EW533ST)
~XX60 3	7E 30 30 36 30 20 33 0D		16:9-II (for ESS23ST) / 16:10 (for EW533ST)
~XX60 6	7E 30 30 36 30 20 36 0D		Native
~XX60 7	7E 30 30 36 30 20 37 0D		Auto
~XX61 n	7E 30 30 36 31 20 a 0D	EdgeMask	n = 0 (a=30) ~ 5 (a=31 30)
~XX62 n	7E 30 30 36 32 20 a 0D	OverScan	n = -10 (a=2D 31 30) ~ 40 (a=34 30)
~XX64 n	7E 30 30 36 34 20 a 0D	V Image Shift	n = -50 (a=2D 35 30) ~ +50 (a=35 30)
~XX66 n	7E 30 30 36 36 20 a 0D	V Keystone	n = -40 (a=2D 34 30) ~ 40 (a=34 30)
~XX230 3	7E 30 30 32 33 30 20 31 0D	3D Mode	Nvidia 3D Vision
~XX230 1	7E 30 30 32 33 30 20 31 0D	3D Mode	DLP-Link
~XX230 0	7E 30 30 32 33 30 20 30 0D	3D Mode	Off
~XX231 1	7E 30 30 32 33 31 20 31 0D	3D Sync Invert	On
~XX231 0	7E 30 30 32 33 31 20 30 0D	3D Sync Invert	Off
~XX70 1	7E 30 30 37 30 20 31 0D	Language	English
~XX70 2	7E 30 30 37 30 20 32 0D		German
~XX70 3	7E 30 30 37 30 20 33 0D		French
~XX70 4	7E 30 30 37 30 20 34 0D		Italian
~XX70 5	7E 30 30 37 30 20 35 0D		Spanish
~XX70 6	7E 30 30 37 30 20 36 0D		Portuguese
~XX70 7	7E 30 30 37 30 20 37 0D		Polish
~XX70 8	7E 30 30 37 30 20 38 0D		Dutch
~XX70 9	7E 30 30 37 30 20 39 0D		Swedish
~XX70 10	7E 30 30 37 30 20 31 30 0D		Norwegian/Danish
~XX70 12	7E 30 30 37 30 20 31 32 0D		Greek
~XX70 13	7E 30 30 37 30 20 31 33 0D		Traditional Chinese
~XX70 14	7E 30 30 37 30 20 31 34 0D		Simplified Chinese
~XX70 15	7E 30 30 37 30 20 31 35 0D		Japanese
~XX70 16	7E 30 30 37 30 20 31 36 0D		Korean
~XX70 17	7E 30 30 37 30 20 31 37 0D		Russian
~XX70 18	7E 30 30 37 30 20 31 38 0D		Hungarian
~XX70 19	7E 30 30 37 30 20 31 39 0D		Czechoslovak
~XX70 20	7E 30 30 37 30 20 32 30 0D		Arabic
~XX70 22	7E 30 30 37 30 20 32 32 0D		Turkish
~XX71 1	7E 30 30 37 31 20 31 0D	Projection	Front-Desktop
~XX71 2	7E 30 30 37 31 20 32 0D		Rear-Desktop
~XX71 3	7E 30 30 37 31 20 33 0D		Front-Ceiling
~XX71 4	7E 30 30 37 31 20 34 0D		Rear-Ceiling
~XX72 1	7E 30 30 37 32 20 31 0D	Menu Location	Top Left
~XX72 2	7E 30 30 37 32 20 32 0D		Top Right
~XX72 3	7E 30 30 37 32 20 33 0D		Centre
~XX72 4	7E 30 30 37 32 20 34 0D		Bottom Left
~XX72 5	7E 30 30 37 32 20 35 0D		Bottom Right
~XX91 n	7E 30 30 39 31 20 a 0D	Signal	Automatic n=0 disable; n=1 enable
~XX73 n	7E 30 30 37 33 20 a 0D	Frequency	n = -5 (a=2D 35) ~ 5 (a=35) By signal
~XX74 n	7E 30 30 37 34 20 a 0D	Phase	n = 0 (a=30) ~ 31 (a=33 31) By signal
~XX75 n	7E 30 30 37 35 20 a 0D	H. Position	n = -5 (a=2D 35) ~ 5 (a=35) By timing
~XX76 n	7E 30 30 37 36 20 a 0D	V. Position	n = -5 (a=2D 35) ~ 5 (a=35) By timing
~XX77 n	7E 30 30 37 37 20 aabbcc 0D	Security	Security Timer n = mm/dd/hh mm = 00 (aa=30 30) ~ 12 (aa=31 32) dd = 00 (bb=30 30) ~ 30 (bb=33 30) hh = 00 (cc=30 30) ~ 24 (cc=32 34)
~XX78 1	7E 30 30 37 38 20 31 0D	Security Settings	Enable
~XX78 2	7E 30 30 37 38 20 32 0D		Disable
~XX79 n	7E 30 30 37 39 20 a 0D	Projector ID	n = 0 (a=30 30) ~ 99 (a=39 39)
~XX80 1	7E 30 30 38 30 20 31 0D	Mute	On
~XX80 0	7E 30 30 38 30 20 30 0D		Off (0/2 for backward compatible)
~XX81 n	7E 30 30 38 31 20 a 0D	Volume	n = 0 (a=30) ~ 10 (a=31 30)
~XX100 1	7E 30 30 31 30 30 20 31 0D	Source Lock	On
~XX100 0	7E 30 30 31 30 30 20 30 0D		Off (0/2 for backward compatible)
~XX100 3	7E 30 30 31 30 30 20 33 0D	Next Source	On
~XX101 1	7E 30 30 31 30 31 20 31 0D	High Altitude	On
~XX101 0	7E 30 30 31 30 31 20 30 0D		Off (0/2 for backward compatible)
~XX102 1	7E 30 30 31 30 32 20 31 0D	Information Hide	On
~XX102 0	7E 30 30 31 30 32 20 30 0D		Off (0/2 for backward compatible)
~XX103 1	7E 30 30 31 30 33 20 31 0D	Keypad Lock	On
~XX103 0	7E 30 30 31 30 33 20 30 0D		Off (0/2 for backward compatible)
~XX104 1	7E 30 30 31 30 34 20 31 0D	Background Color	Blue
~XX104 2	7E 30 30 31 30 34 20 32 0D		Black
~XX104 3	7E 30 30 31 30 34 20 33 0D		Red
~XX104 4	7E 30 30 31 30 34 20 34 0D		Green
~XX104 5	7E 30 30 31 30 34 20 35 0D		White

# Appendices

-XX105 1	7E 30 30 31 30 35 20 31 0D	Advanced	Direct Power On	On
-XX105 0	7E 30 30 31 30 35 20 30 0D			Off (0/2 for backward compatible)
-XX106 n	7E 30 30 31 30 36 20 A 0D		Auto Power Off (min)	n = 0 (a=30) ~ 180 (a=31 38 30) step:5
-XX107 n	7E 30 30 31 30 37 20 A 0D		Sleep Timer (min)	n = 0 (a=30) ~ 995 (a=39 39 39) step:5
-XX114 1	7E 30 30 31 31 34 20 31 0D		Power Mode(Standby)	Eco (<=1W)
-XX114 0	7E 30 30 31 31 34 20 30 0D			Active (0/2 for backward compatible)
-XX109 1	7E 30 30 31 30 39 20 31 0D		Lamp Reminder	On
-XX109 0	7E 30 30 31 30 39 20 30 0D			Off (0/2 for backward compatible)
-XX110 1	7E 30 30 31 31 30 20 31 0D		Brightness Mode	Bright
-XX110 0	7E 30 30 31 31 30 20 30 0D			STD (0/2 for backward compatible)
-XX111 1	7E 30 30 31 31 20 31 0D		Lamp Reset	Yes
-XX111 0	7E 30 30 31 31 20 30 0D			No (0/2 for backward compatible)
-XX112 1	7E 30 30 31 31 32 20 31 0D	Reset		Yes
-XX99 1	7E 30 30 39 39 20 31 0D	RS232 Alert Reset	Reset System Alert	
-XX210 n	7E 30 30 32 30 30 20 n 0D	Display message on the OSD		n: 1-30 characters

## SEND to emulate Remote

-XX140 1	7E 30 30 31 34 30 20 31 0D		Power	
-XX140 10	7E 30 30 31 34 30 20 31 30 0D		Up/Page +	
-XX140 11	7E 30 30 31 34 30 20 31 0D		Left/Source	
-XX140 12	7E 30 30 31 34 30 20 31 32 0D		Enter (for projection MENU)	
-XX140 13	7E 30 30 31 34 30 20 31 33 0D		Right/Re-SYNC	
-XX140 14	7E 30 30 31 34 30 20 31 34 0D		Down/Page -	
-XX140 15	7E 30 30 31 34 30 20 31 35 0D		Keystone +	
-XX140 16	7E 30 30 31 34 30 20 31 36 0D		Keystone -	
-XX140 17	7E 30 30 31 34 30 20 31 37 0D		Volume -	
-XX140 18	7E 30 30 31 34 30 20 31 38 0D		Volume +	
-XX140 19	7E 30 30 31 34 30 20 31 39 0D		Brightness (1)	
-XX140 20	7E 30 30 31 34 30 20 32 30 0D		Menu (2)	
-XX140 21	7E 30 30 31 34 30 20 32 31 0D		Overscan(3)	
-XX140 22	7E 30 30 31 34 30 20 32 32 0D		Contrast(4) (for ESS23ST) / HDMI(4) (for EW533ST)	
-XX140 23	7E 30 30 31 34 30 20 32 33 0D		Freeze (5)	
-XX140 24	7E 30 30 31 34 30 20 32 34 0D		AV Mute (6)	
-XX140 25	7E 30 30 31 34 30 20 32 35 0D		S-Video (7)	
-XX140 26	7E 30 30 31 34 30 20 32 36 0D		VGA (8)	
-XX140 27	7E 30 30 31 34 30 20 32 37 0D		Video (9)	

## SEND from projector automatically

232 ASCII Code	HEX Code	Function	Projector Return	Description
when Standby/Warming/Cooling/Out of Range/Lamp fail/ Fan Lock/Over Temperature/Lamp Hours Running Out/Cover Open			INFOn	n : 0/1/2/3/4/6/7/8/9 = Standby/Warming/Cooling/Out of Range/Lamp fail/ Fan Lock/Over Temperature/Lamp Hours Running Out/Cover Open

## READ from projector

232 ASCII Code	HEX Code	Function	Projector Return	Description
-XX121 1	7E 30 30 31 32 31 20 31 0D	Input Source Commands	OKn	n : 0/1/2/3 = None/VGA /S-Video/Video (for ESS23ST) n : 0/1/2/3/4 = None/VGA /S-Video/Video/HDMI (for EW533ST)
-XX122 1	7E 30 30 31 32 32 20 31 0D	Software Version	OKdddd	dddd: FW version
-XX123 1	7E 30 30 31 32 33 20 31 0D	Display Mode	OKn	n : 0/1/2/3/4/5/6/7/8 = None/Presentation/Bright/Game/Blackboard/Classroom/Cinema/User/3D n : 0/1 = Off/On
-XX124 1	7E 30 30 31 32 34 20 31 0D	Power State	OKn	
-XX125 1	7E 30 30 31 32 35 20 31 0D	Brightness	OKn	
-XX126 1	7E 30 30 31 32 36 20 31 0D	Contrast	OKn	
-XX127 1	7E 30 30 31 32 37 20 31 0D	Aspect Ratio	OKn	n : 0/1/2/3/4 = 4:3/16:9/1/16:9-1/1/16:9-1/1/Native/AUTO (for ESS23ST) n : 0/1/2/3/4 = 4:3/16:9/16:10/Native/AUTO (for EW533ST)
-XX128 1	7E 30 30 31 32 38 20 31 0D	Color Temperature	OKn	n : 0/1/2 = Warm/Medium/Cold
-XX129 1	7E 30 30 31 32 39 20 31 0D	Projection Mode	OKn	n : 0/1/2/3 = Front-Desktop/ Rear-Desktop/ Front-Ceiling/ Rear-Ceiling
-XX150 1	7E 30 30 31 35 30 20 31 0D	Information	OKabbbbedddd	a : 0/1 = Off/On bbbb: LampHour cc: source 00/01/02/03 = None/VGA/S-Video/Video (for ESS23ST) cc: source 00/01/02/03/04 = None/VGA/S-Video/Video/HDMI (for EW533ST) dddd: FW version e : Display mode 0/1/2/3/4/5/6/7/8 None/Presentation/Bright/Game/ Blackboard/Classroom/User/3D
-XX151 1	7E 30 30 31 35 31 20 31 0D	Model name	OKn	n:1/2=ESS23ST/EW533ST
-XX108 1	7E 30 30 31 30 38 20 31 0D	Lamp Hours	OKbbbb	bbbb: LampHour
-XX108 2	7E 30 30 31 30 38 20 31 0D	Cumulative Lamp Hours	OKbbbb	bbbb: (5 digits) Total Lamp Hours

## Ceiling Mount Installation

1. To prevent damage to your projector, please use the Optoma ceiling mount.
2. If you wish to use a third party ceiling mount kit, please ensure the screws used to attach a mount to the projector meet the following specifications:

- ▶ Screw type: M3\*3
- ▶ Maximum screw length: 10mm
- ▶ Minimum screw length: 7.5mm



❖ Please note that damage resulting from incorrect installation will void the warranty.



### ⚠ Warning:

1. If you buy a ceiling mount from another company, please be sure to use the correct screw size. Screw size will vary depending on the thickness of the mounting plate.
2. Be sure to keep at least 10 cm gap between the ceiling and the bottom of the projector.
3. Avoid installing the projector near a heat source.

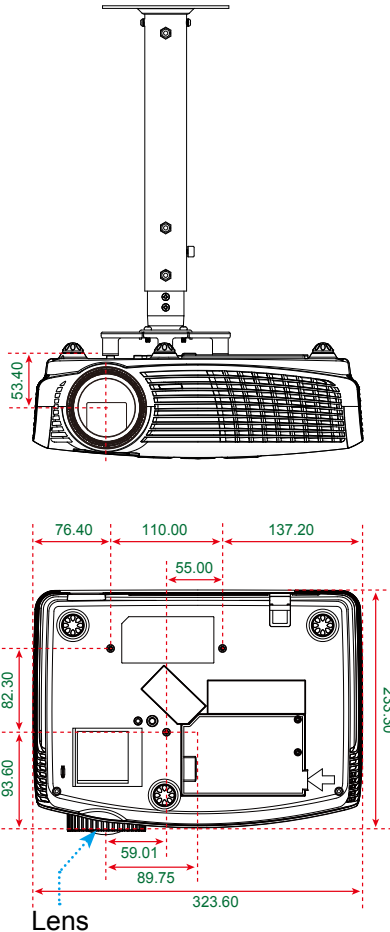



Unit: mm

## Optoma Global Offices

*For service or support please contact your local office.*



### USA

715 Sycamore Drive  
Milpitas, CA 95035, USA  
[www.optomausa.com](http://www.optomausa.com)

 408-383-3700  
 408-383-3702  
 [services@optoma.com](mailto:services@optoma.com)

### Canada

5630 Kennedy Road, Mississauga,  
ON, L4Z 2A9, Canada  
[www.optoma.ca](http://www.optoma.ca)

 905-361-2582  
 905-361-2581  
 [canadacsragent@optoma.com](mailto:canadacsragent@optoma.com)



### Europe

42 Caxton Way, The Watford Business Park  
Watford, Hertfordshire,  
WD18 8QZ, UK  
[www.optoma.eu](http://www.optoma.eu)  
Service Tel : +44 (0)1923 691865

 +44 (0) 1923 691 800  
 +44 (0) 1923 691 888  
 [service@tsc-europe.com](mailto:service@tsc-europe.com)



### France

Bâtiment E  
81-83 avenue Edouard Vaillant  
92100 Boulogne Billancourt, France

 +33 1 41 46 12 20  
 +33 1 41 46 94 35  
 [savoptoma@optoma.fr](mailto:savoptoma@optoma.fr)



### Spain

C/ José Hierro, 36 Of. 1C  
28522 Rivas VaciaMadrid,  
Spain

 +34 91 499 06 06  
 +34 91 670 08 32



### Deutschland

Wertstrasse 25  
D40549 Düsseldorf,  
Germany

 +49 (0) 211 506 6670  
 +49 (0) 211 506 66799  
 [info@optoma.de](mailto:info@optoma.de)

### Scandinavia

Lerpeveien 25  
3040 Drammen  
Norway



 +47 32 98 89 90  
 +47 32 98 89 99  
 [info@optoma.no](mailto:info@optoma.no)

PO.BOX 9515  
3038 Drammen  
Norway

# Appendices



## Latin America

715 Sycamore Drive  
Milpitas, CA 95035, USA  
[www.optoma.com.br](http://www.optoma.com.br)

 408-383-3700  
 408-383-3702  
[www.optoma.com.mx](http://www.optoma.com.mx)

## Korea

WOOMI TECH.CO.,LTD.  
4F,Minu Bldg.33-14, Kangnam-Ku,  
seoul,135-815, KOREA

 +82+2+34430004  
 +82+2+34430005

## Japan

東京都足立区綾瀬3-25-18  
株式会社オーエスエム  
サポートセンター:0120-46-5040

 [info@osscreen.com](mailto:info@osscreen.com)  
[www.os-worldwide.com](http://www.os-worldwide.com)



## Taiwan

5F., No. 108, Minchiuan Rd.  
Shindian City,  
Taipei Taiwan 231, R.O.C.  
[www.optoma.com.tw](http://www.optoma.com.tw)

 +886-2-2218-2360  
 +886-2-2218-2313  
 [services@optoma.com.tw](mailto:services@optoma.com.tw)  
[asia.optoma.com](http://asia.optoma.com)



## Hong Kong

Unit A, 27/F Dragon Centre,  
79 Wing Hong Street,  
Cheung Sha Wan,  
Kowloon, Hong Kong

 +852-2396-8968  
 +852-2370-1222  
[www.optoma.com.hk](http://www.optoma.com.hk)

## China

5F, No. 1205, Kaixuan Rd.,  
Changning District  
Shanghai, 200052, China

 +86-21-62947376  
 +86-21-62947375  
[www.optoma.com.cn](http://www.optoma.com.cn)

## Regulation & Safety Notices

*This appendix lists the general notices of your projector.*

### **FCC notice**

This device has been tested and found to comply with the limits for a Class B digital device pursuant to Part 15 of the FCC rules. These limits are designed to provide reasonable protection against harmful interference in a residential installation. This device generates, uses and can radiate radio frequency energy and, if not installed and used in accordance with the instructions, may cause harmful interference to radio communications.

However, there is no guarantee that interference will not occur in a particular installation. If this device does cause harmful interference to radio or television reception, which can be determined by turning the device off and on, the user is encouraged to try to correct the interference by one or more of the following measures:

- Reorient or relocate the receiving antenna.
- Increase the separation between the device and receiver.
- Connect the device into an outlet on a circuit different from that to which the receiver is connected.
- Consult the dealer or an experienced radio/television technician for help.

### **Notice: Shielded cables**

All connections to other computing devices must be made using shielded cables to maintain compliance with FCC regulations.

### **Caution**

Changes or modifications not expressly approved by the manufacturer could void the user's authority, which is granted by the Federal Communications Commission, to operate this projector.

# Appendices

## **Operation conditions**

This device complies with Part 15 of the FCC Rules. Operation is subject to the following two conditions:

1. This device may not cause harmful interference and
2. This device must accept any interference received, including interference that may cause undesired operation.

## **Notice: Canadian users**

This Class B digital apparatus complies with Canadian ICES-003.

## **Remarque à l'intention des utilisateurs canadiens**

Cet appareil numérique de la classe B est conforme à la norme NMB-003 du Canada.

## **Declaration of Conformity for EU countries**

- EMC Directive 2004/108/EC (including amendments)
- Low Voltage Directive 2006/95/EC
- R & TTE Directive 1999/5/EC (if product has RF function)

### **Disposal instructions**



**Do not throw this electronic device into the trash when discarding. To minimize pollution and ensure utmost protection of the global environment, please recycle it.**