

Home Cinema
EH-R4000
EH-R2000

User's Guide



About the Manuals and Notations Used

Types of Manual

The documentation for your EPSON projector is divided into the following two manuals. Refer to the manuals in the order given below.

① Safety Instructions/Support and Service Guide

This manual contains information on using the projector safely, and also includes a guide for warranty service, and a troubleshooting check sheet.

Be sure to read this manual thoroughly before using the projector.

② User's Guide (this manual)



This User's Guide contains information on installing the projector, basic operations, using the configuration menus, troubleshooting and maintenance.

Notations used in this User's Guide







Safety indications

So that you can use the product safely and correctly, symbols are applied in the User's Guide and on the product to indicate possible harm to the user or to others and the risk of damage to property.

The indications and their meaning are as follows. Make sure you understand them properly before reading the guide.

 Warning	This symbol indicates information that, if ignored, could possibly result in death or personal injury due to incorrect handling.
 Caution	This symbol indicates information that, if ignored, could possibly result in personal injury or physical damage due to incorrect handling.

General information

	Indicates procedures where personal injury or damage to the projector may occur if the procedures are not followed correctly.
	Indicates additional information and points which may be useful to know regarding a topic.
	Indicates a page where useful information regarding a topic can be found.
	Indicates that an explanation of the underlined word or words in front of this symbol appears in the glossary of terms. Refer to the "Glossary" in the "Appendix".  p.80
  etc.	Indicates buttons on the remote control or projector's control panel.
"Menu Name"	Indicates configuration menu items. Example: "Image"- "Color Mode"
[Name]	Indicates the port name of the projector. Example: [Video]

Meaning of "unit" and "projector"

When "unit" or "projector" appears in the text of this *User's Guide*, they may refer to items which are accessories or optional equipment in addition to the main projector unit itself.

Checking the Components

When you unpack the projector, make sure that you have all these components.

If any of the components are missing or incorrect, please contact the place of purchase.

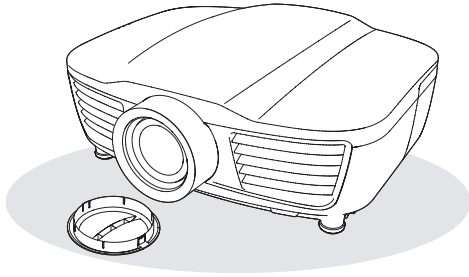

- Projector (with lens cover)**

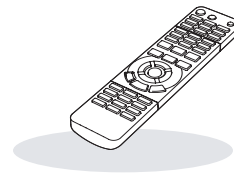

- Remote control**

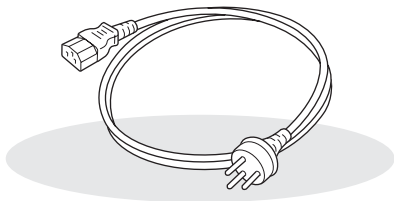

- Power cable (3.0m)**
Connect to the projector and to a wall outlet.

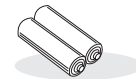

- AA-size alkali batteries (2 pcs.)**
Insert into the remote control.

Documentation

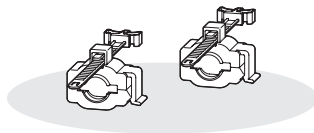

- HDMI cable clamps (2 pcs.)**
Secure the HDMI cable.

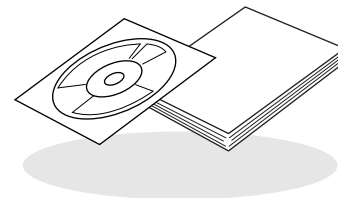

- Document CD-ROM**
(Safety Instructions/Support and Service Guide, User's Guide)
- Quick Start Guide**

■ Features of the Projector	4	Remote control	7
■ Part Names and Functions	6	Rear	8
Front / Top	6	Base	8
Control panel.....	6	■ Appearance	9

Installing the Projector

■ Setting up	10	■ Preparing the Remote Control	13
Adjusting the projection size.....	10	Inserting batteries into the remote control.....	13
Projection methods.....	11	Using the remote control	13
■ Connecting Image Sources	12		

Basic Operations

■ Starting and Stopping Projection	14	■ Adjusting the Projection Screen	16
Turning the power on and projecting images	14	Focus adjustment	16
When the expected images are not projected.....	15	Projection size adjustment (Zoom adjustment)	16
Turning the power off	15	Projection image position adjustment (Lens shift).....	16
		Adjusting the tilt of the projector	17
		Displaying a test pattern	17

Image Quality Adjustments

■ Basic Image Quality Adjustments	18	■ Examining Image Quality Further	24
Selecting the color mode.....	18	Sharpness (Advanced) adjustment.....	24
Selecting the aspect.....	19	Auto Iris (automatic aperture) setting.....	24
■ Advanced Color Adjustments	21	Super-resolution.....	25
Hue, saturation, and brightness adjustment	21	Lens Iris	25
Gamma adjustment	22	■ Viewing Images at a Preset Image Quality (Memory Function)	26
RGB adjustment (Offset, Gain)	23	Saving, Loading, Erasing and Renaming Memory	26
Selecting the color gamut.....	23	■ Projecting Images at a Preset Lens Position	28
		Saving, Loading, Deleting and Renaming lens position	28



Configuration Menu

■ Configuration Menu Functions	30	"Signal" menu	39
Using the configuration menus	30	"Settings" menu	42
List of configuration menus (EH-R2000).....	32	"Memory" menu.....	44
List of configuration menus (EH-R4000).....	35	"Network" menu (EH-R4000 only)	45
"Image" menu.....	38	•Soft keyboard operations	47
		"Reset" menu	47

Advanced Functions

■ Using the HDMI Link	48	•Connecting a LAN Cable.....	51
Setting the HDMI link.....	48	•Displaying Web Control	51
List of connected devices	50	•Projector Setup.....	52
■ Operating from a Computer (EH-R4000 Only)	51	Using the Mail Notification Function to Report Problems	53
Changing Settings Using a Web Browser (Web Control).....	51		

Troubleshooting

■ Problem Solving	54	•Problems when projection starts	61
Reading the indicators	54	•Problems with the remote control.....	62
•When the ⚠ (warning) indicator is lit or flashing	54	•Other problems	62
•Indicator statuses in normal operation.....	55	•Network problems (EH-R4000 only)	62
When the indicators provide no help.....	56	•HDMI link problems.....	63
•Problems relating to images	57	Reading Problem Mail Notification Function	64

Appendix

■ Maintenance	65	■ Optional Accessories/Consumables	72
Cleaning	65	Installing and removing the cable cover	72
•Cleaning the air filter	65	■ About PjLink	73
•Cleaning the projector case	67	■ List of Supported Monitor Displays	74
•Cleaning the lens	67	•Component Video	74
Consumable replacement periods.....	68	•Composite Video/S-Video.....	74
•Air filter replacement period	68	•Input signal from the [HDMI1] / [HDMI2] input port.....	75
•Lamp replacement period	68	•Computer image (analog RGB)	75
Replacing consumables	69	■ Specifications	76
•Replacing the air filter	69	■ Glossary	80
•Replacing the lamp	70	■ Index	82
•Resetting the lamp operating time	71		

▶ Image appearance can be selected to match the projection environment (Color Mode)

The optimum images for the location can be projected simply by selecting the desired color mode from the following five preset modes. [☞ p.18](#)

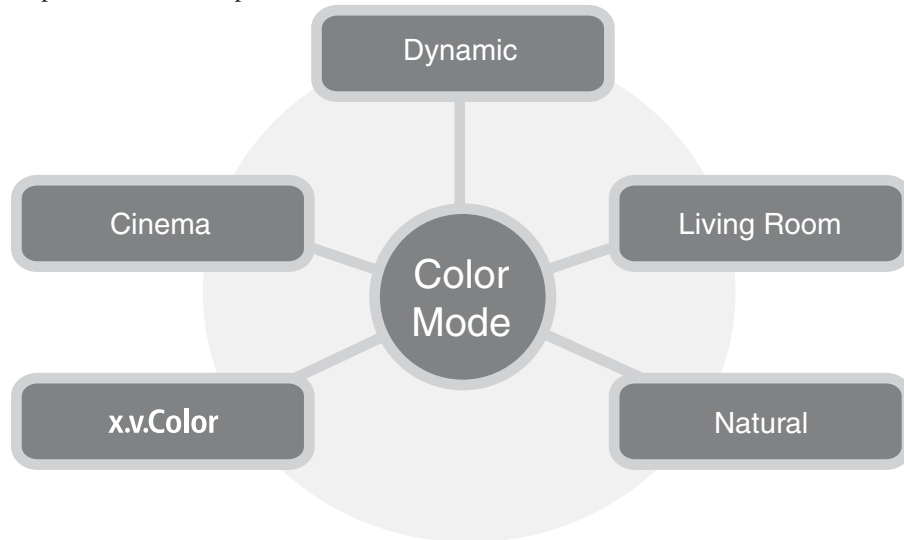

▶ Electric lens shift, zoom and focus

The lens shift function allows you to adjust the projection position in horizontal and vertical directions, giving a much greater degree of freedom on installation.

The zoom, focus and lens shift functions can be operated using the remote control, and once completed, the projection position can be locked. [☞ p.16](#)

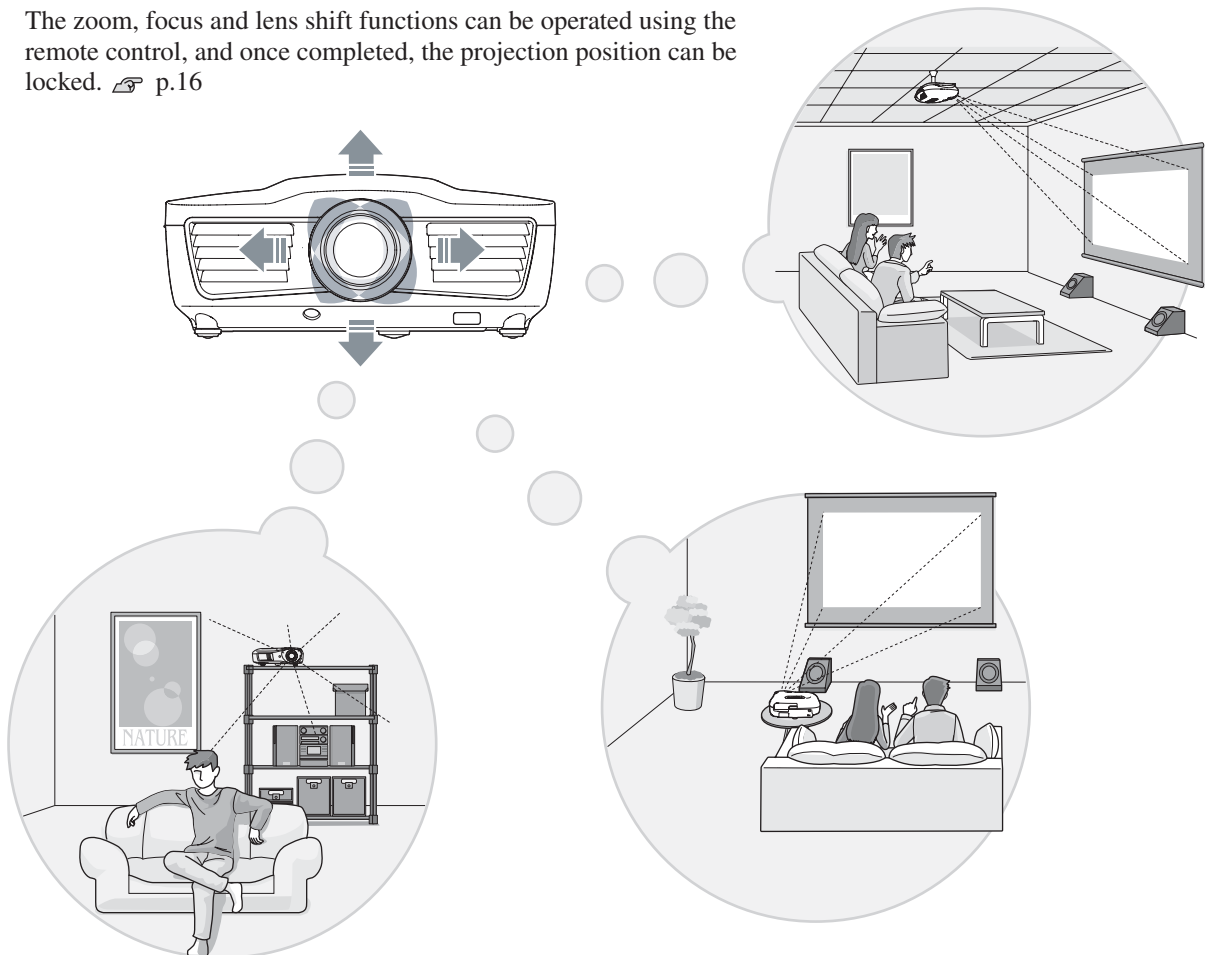

Advanced image quality adjustment functions

In addition to the preset color modes, you can easily adjust absolute color temperature and skin tones. Further, you can adjust gamma, the offset and gain for RGB colors, and the hue, saturation, and brightness of RGBCMY colors, to create colors that match the image.

Super-resolution

The super-resolution function allows you to enjoy DVD images at similar high resolutions to full high-definition images, and can also make areas of full high-definition images with low resolution (or which are out of focus) appear much more smooth and fresh.

Frame interpolation

The frame interpolation function compares each two successive images of a movie and generates intermediate images, so that you can enjoy viewing smooth, attractive moving images without the sense of image lag and blurriness of motion.

Other functions to enjoy images more

Some of the other many functions are available as follows.

- HDMI link allows you to use the remote control to turn on the power for the projector and connected HDMI-CEC compatible audio and video devices at a time, or to control the devices. [↗ p.48](#)
- The memory function makes it easy to store your preferred color tone settings for projected images into memory, and to load them again. [↗ p.26](#)
- Remote control with backlight provides greater visibility and ease of operation in dark rooms. [↗ p.7](#)
- Auto iris function automatically recognizes changes in the brightness of images to produce natural feelings of depth and stereoscopic effect. [↗ p.24](#)

Front / Top

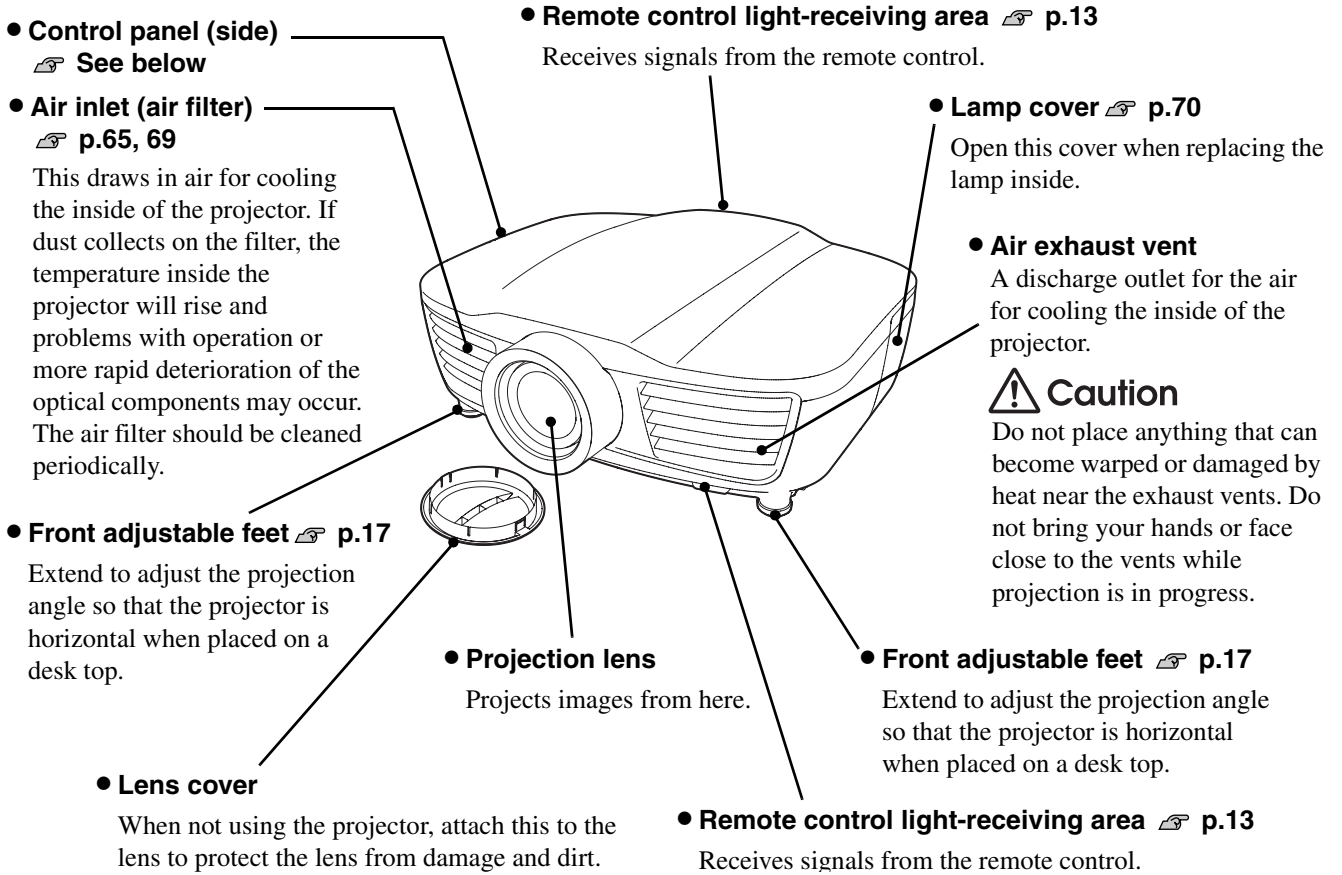





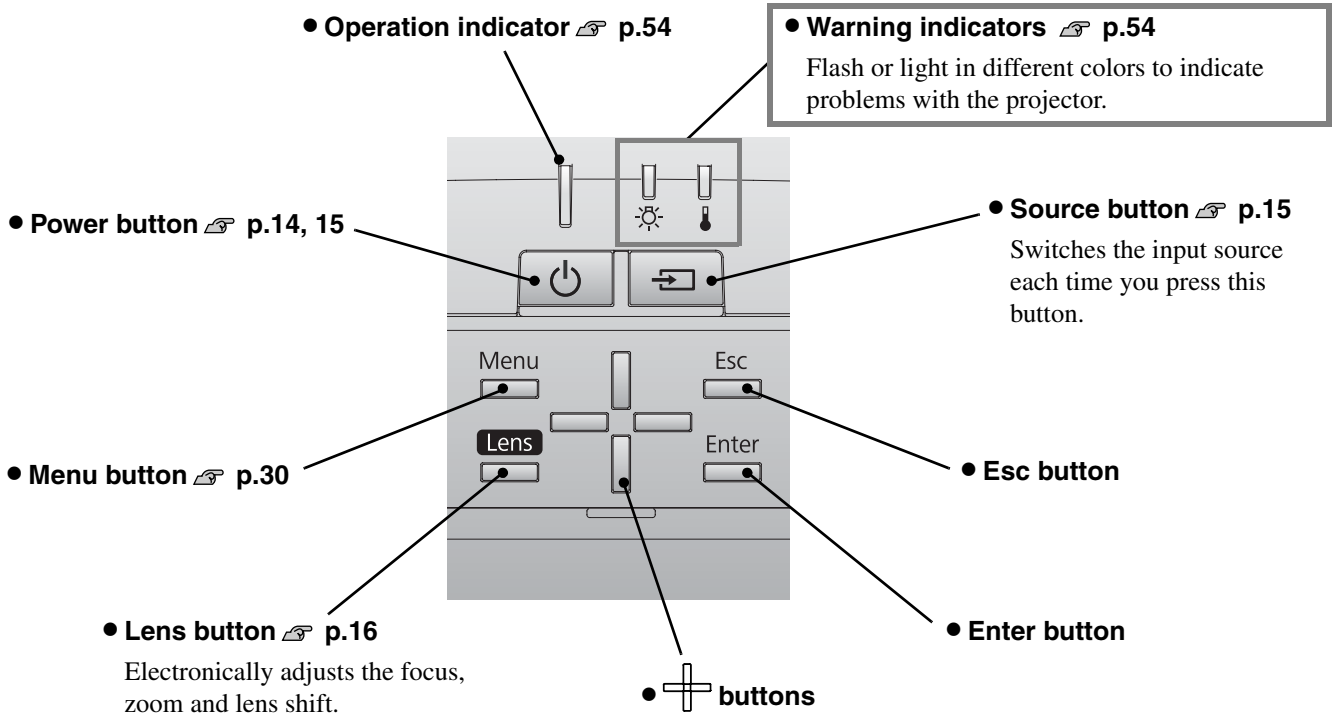













Control panel

Buttons with no explanation function in the same way as the corresponding buttons on the remote control. Refer to "Remote control" for further details on these buttons.













Remote control

- **Remote control light-emitting area**  p.13
Outputs remote control signals.
- **Power buttons**  p.14, 15
Turns the projector power on/off.
- **Source buttons**  p.15
Switch between equipment connected to the projector.
- **Lens buttons**  p.16
Lens Shift button:
Moves the images horizontally and vertically.
Zoom button:
Adjusts the image size.
Focus button:
Adjusts the image focus.
- **Menu button**  p.30
Displays/closes the configuration menu.
- **Default button**
Restores default settings when menu is displayed.
- **RGBCMY button**  p.21
Adjusts the hue, saturation and brightness for each RGBCMY color.
- **Memory button**  p.26
Saves, loads, and erases memory contents.
- **Lens Iris button**  p.25
Adjusts the brightness by changing the luminance of the light through the lens.
- **Aspect**  **button**  p.19
Changes the aspect ratio to match the input signal.
- **Super-resolution button**  p.25
Uses super-resolution processing to adjust the images so that out-of-focus areas such as the edges can become sharper.
- **Illumination button**
Illuminates all of the buttons on the remote control for 15 seconds so that they can be seen in dark places.
- **HDMI Link buttons**  p.48
Used for operations such as playback, stop and volume adjustment for connected HDMI-CEC compatible devices.
- **Enter button**  p.18, 26, 30
While viewing a menu, press this button to select the menu item and proceed to the next display.
- **Navigation buttons**  p.18, 21, 23, 30
Press to select menu items and adjustment values.
- **Esc button**  p.18, 21, 30
Returns to the previous menu when pressed while displaying the menu.
- **Color Mode button**  p.18
Changes the color mode to suit the projection environment.
- **Frame Interpolation button**  p.40
To make the moving images smoother and sharper, reduces image lags caused by quick movements.
- **Blank button**
Turns off and on the projected images temporarily. When pressed while the configuration menu is displayed, or while a menu is displayed by pressing **Memory** or **RGBCMY**, the menu screen disappears and appears.
- **Pattern button**  p.17
Displays and clears the test pattern.

Rear

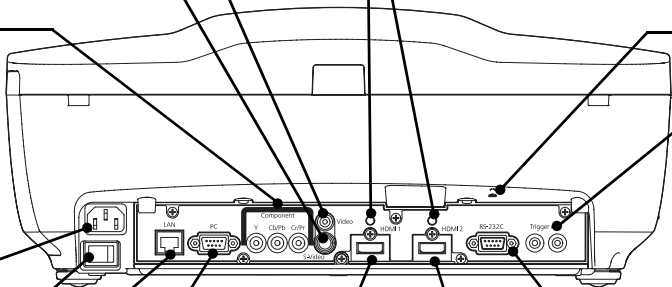
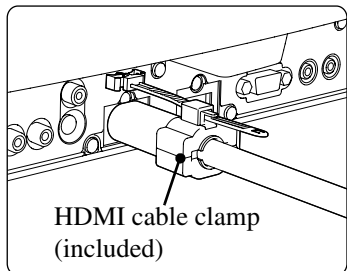

The illustrations used here are of EH-R4000.

- **[Video] input port**  p.12
Connects to the Composite Video™ output port of the video equipment.
- **[S-Video] input port**  p.12
Connects to the S-Video out ports of the video equipment.
- **[Component] input port**  p.12
Connects to the component (YCbCr™ or YPbPr™) out port of the video equipment.
- **Power inlet**  p.14
Connects the power cable.
- **Main power switch**  p.14
- **[LAN] port (EH-R4000 only)**  p.51
Connects a LAN cable.
- **[PC] input port**  p.12
Connects to the RGB out port of the computer.
- **Cable holders**
Attach the HDMI cable clamps to secure HDMI cables to prevent the thick and heavy cables from being disconnected from the ports due to their own weight.
- **[HDMI1] input port***  p.12
Connects to an HDMI™-compatible video source or to a computer.
- **[HDMI2] input port***  p.12
Connects to an HDMI™-compatible video source or to a computer.
- **Security lock**™   p.81
- **[Trigger out] port**
Outputs a 12-volt DC signal when the projector is turned on. It is used to transmit the power status (on/off) or the aspect ratio (Anamorphic Wide/Horizontal Squeeze) of this projector to external equipment such as a motorized screen.
- **[RS-232C] port**
Connects to a computer using an RS-232C cable to control the projector from the computer. This is not used in normal use.



* Compatible with HDCP™

Base

- **Filter cover opening switch**  p.68
Press this switch to replace the internal air filter.
- **Cable cover stays (2 places)**
Attach the optional cable cover here.
- **Suspension bracket fixing points (4 points)**  p.72
Install the optional ceiling mount here when suspending the projector from a ceiling.

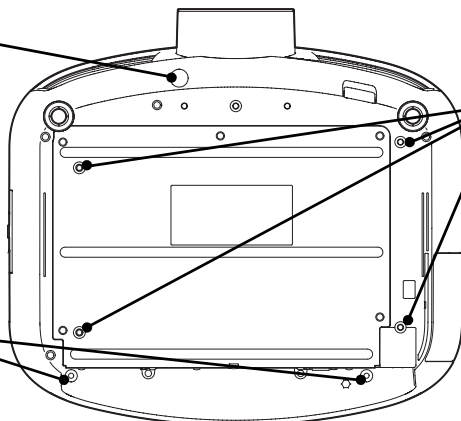

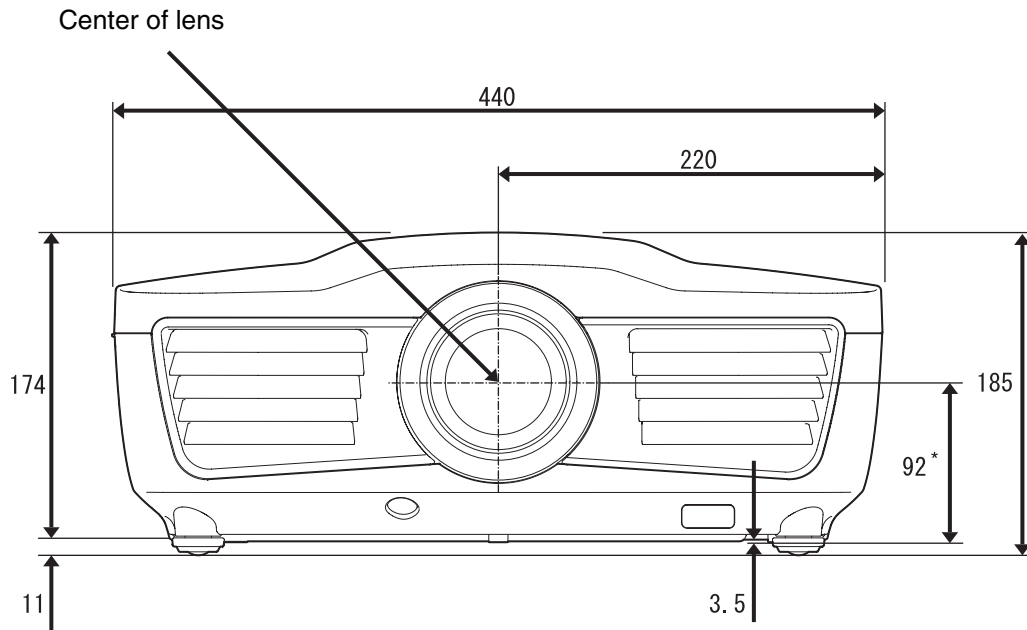

* Distance from center of lens to suspension bracket fixing point

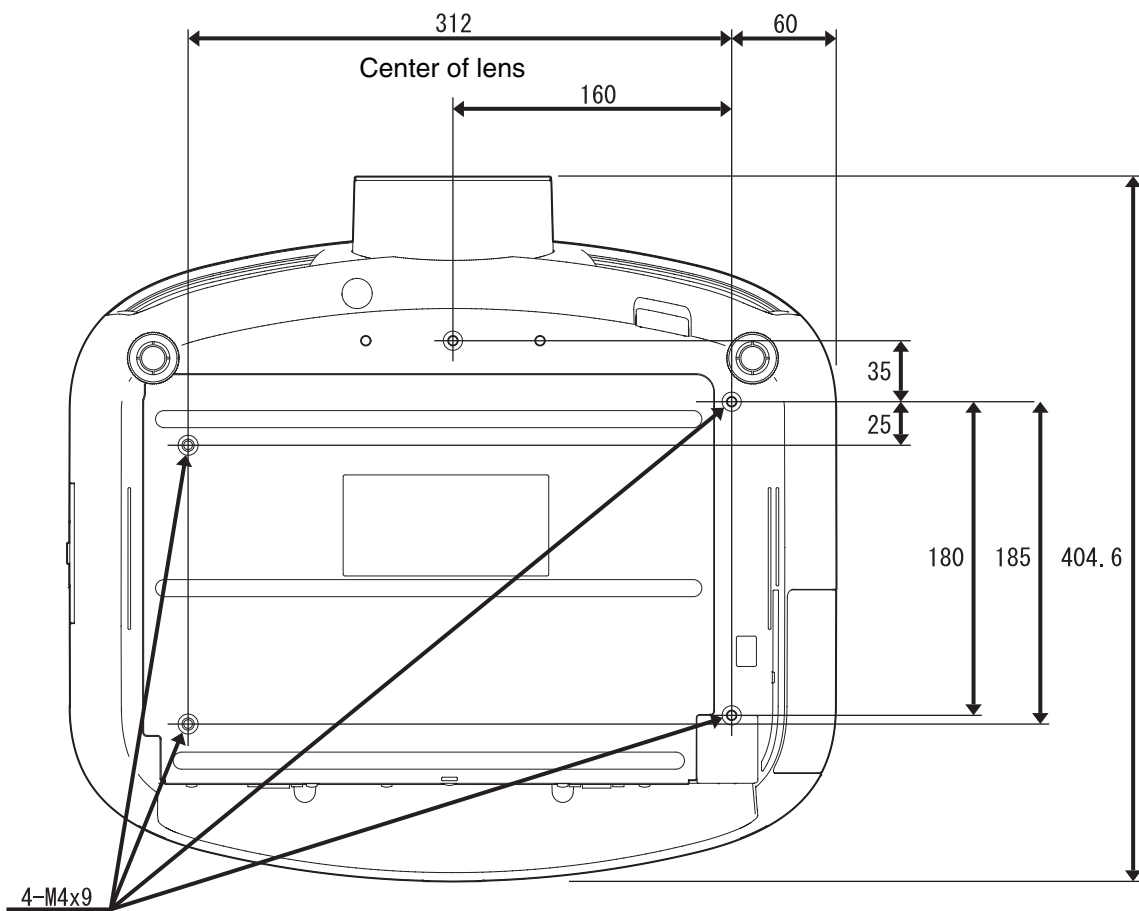

Units: mm

Adjusting the projection size

When the projector is further away from the screen, the projection image size is larger. While referring to the table below, position the projector so that the images are projected onto the screen at the optimum size. The values should be used as a guide for setting up the projector.

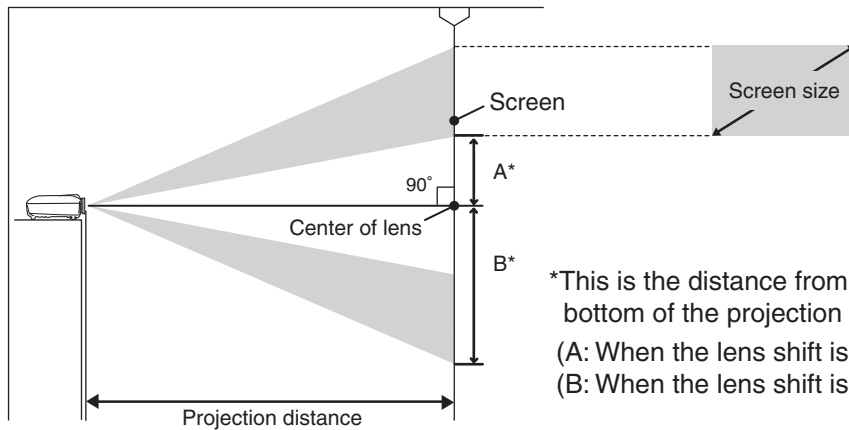

Units: cm

16:9 screen size		Projection distance		A	B
		Shortest (Wide)	Longest (Tele)		
30"	66×37	83	179	13	50
40"	89×50	111	240	17	67
60"	130×75	169	361	26	101
80"	180×100	226	482	35	134
100"	220×120	283	604	44	168
120"	270×150	341	725	52	202
150"	330×190	427	908	65	252
200"	440×250	570	1211	87	336

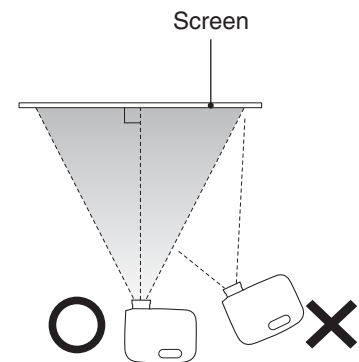

Set up so that the projector is parallel to the screen. If the projector is set up at an angle to the screen, distortion of the images will occur.

Units: cm

4:3 screen size		Projection distance		A	B
		Shortest (Wide)	Longest (Tele)		
30"	61×46	102	220	16	62
40"	81×61	137	294	21	82
60"	120×90	207	443	32	123
80"	160×120	277	591	43	165
100"	200×150	348	740	53	206
120"	240×180	418	889	64	247
150"	300×230	523	1112	80	309
200"	410×300	699	1483	107	411

Lens shift adjustment

The lens shift can be used to position the image and the feature is especially useful under the following conditions.
 📖 p.16

- When the projector is suspended from the ceiling
- When the height of the projector does not match with that of the screen
- When the projector is set up to the side so that the screen can be viewed sitting right in front of it

When positioning an image using the lens shift dial, hardly any deterioration of the image occurs because the lens shift correction is adjusted optically. However, for optimal image quality the lens shift function should not be used.

Projection methods

- Warning**
- If you are installing the projector on the ceiling, this projector should be installed by qualified technicians using only approved mounting equipment. If installation work is not carried out correctly, the projector could fall down. This may result in injury or accidents. Contact your dealer to carry out the installation work.
 - If you use a ceiling mount and apply adhesives to the mount to prevent the screws from loosening, or if you use lubricants or oils on the projector, the projector housing may crack and the projector may fall from its ceiling mount. This could cause serious injury to anyone under the mount and could damage the projector. When installing or adjusting a ceiling mount, do not use adhesives to prevent the screws from loosening and do not use oils or lubricants.

- Attention**
- Do not use the projector in places where there is a lot of humidity or dust, near cooking or heating appliances, or in places where it may come into contact with smoke or steam. Do not use or store this projector outdoors for an extended length of time. Fire or electric shock may result.
 - Clean the air filter at least once every three months.
Clean the air filter more frequently if using the projector in a dusty environment.
 - Do not use the projector on its side. This may cause malfunctions to occur.

■ When projecting from directly in front

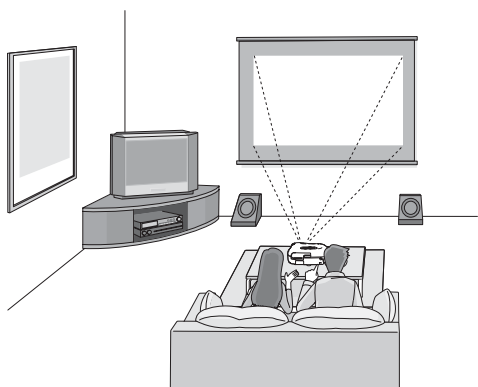

■ When projecting from the side of the screen

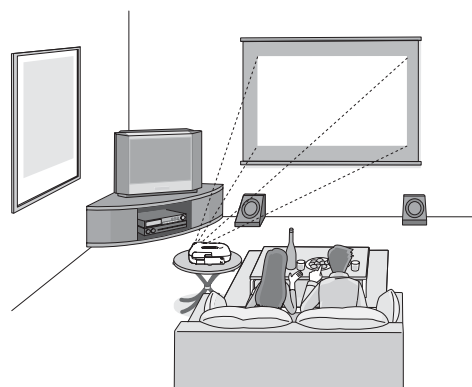

■ When projecting from a ceiling

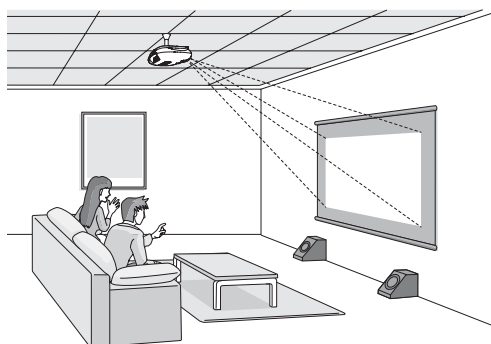

* If you place the projector off to the side, aim it straight ahead (rather than at the center of the screen), then use the horizontal lens shift dial to center the image on the screen.

* When suspending the projector from a ceiling, change the configuration menu settings. p.42

Configuration menu

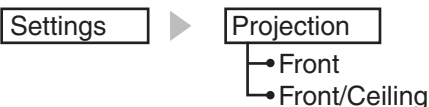

The illustrations used here are of EH-R4000.

Attention

- Turn the power off for both the projector and the signal source before connecting them. If the power for either device is on at the time of connection, damage may result.
- Check the shapes of the cable connectors and the device ports before making the connections. If you try to force a connector to fit a device port with a different shape or number of terminals, a malfunction or damage to the connector or port may result.

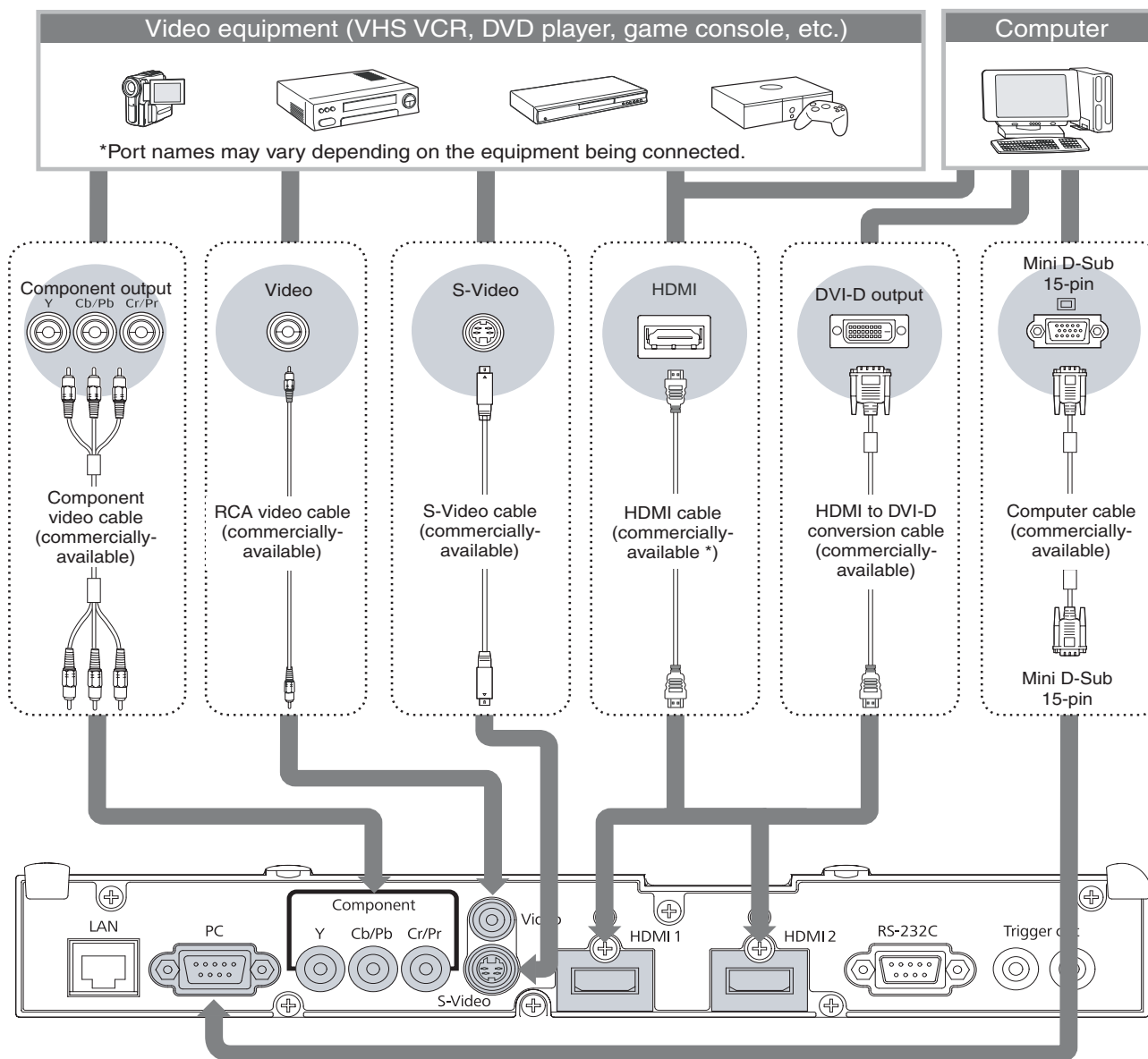

* Use a HDMI cable that conforms to the HDMI specifications.



TIP

The cables used will vary depending on the output signals of the video equipment which is being connected.

Some video equipment can output several different types of signal.

Refer to the documentation provided with the video equipment for details on what types of signal the video equipment can output.

Inserting batteries into the remote control

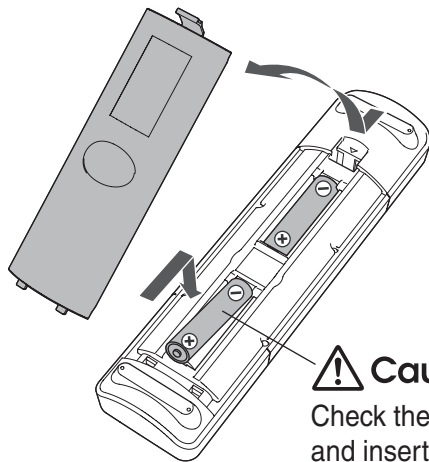

At the time of purchase, the batteries are not inserted into the remote control. Insert the supplied batteries before using the remote control.

- 1 Lift up the battery cover while pressing its tab.
- 2 Insert the batteries in the correct direction.
- 3 Close the cover.

⚠ Caution

Check the (+) and (-) indications inside the battery compartment and insert the batteries so that they face correctly.



TIP

If delays in the responsiveness of the remote control occur or if it does not operate after it has been used for some time, it probably means that the batteries are becoming flat. When this happens, replace them with new batteries. Have two AA size manganese or alkaline batteries ready. You cannot use other batteries except for the AA size manganese or alkaline.

Using the remote control

■ Operating range (horizontal)

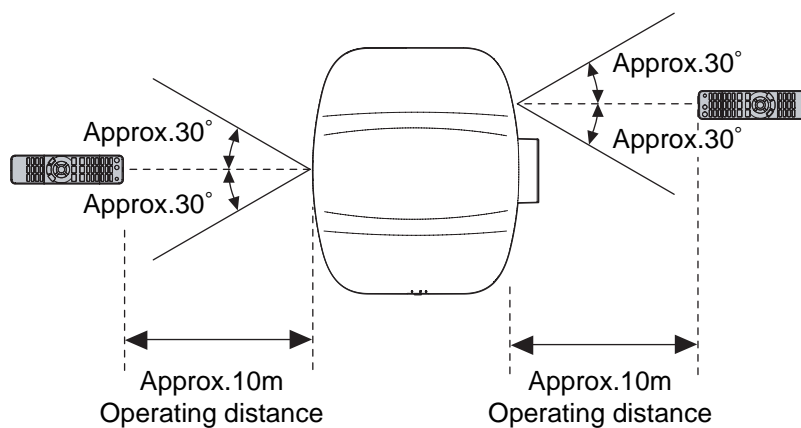

■ Operating range (vertical)

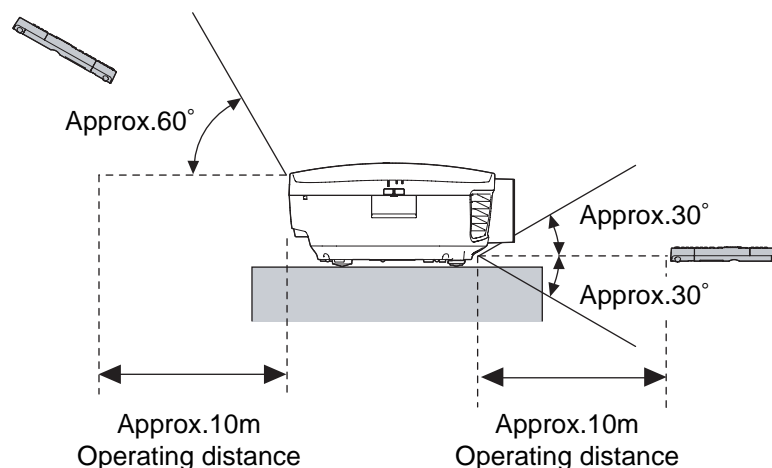

Turning the power on and projecting images

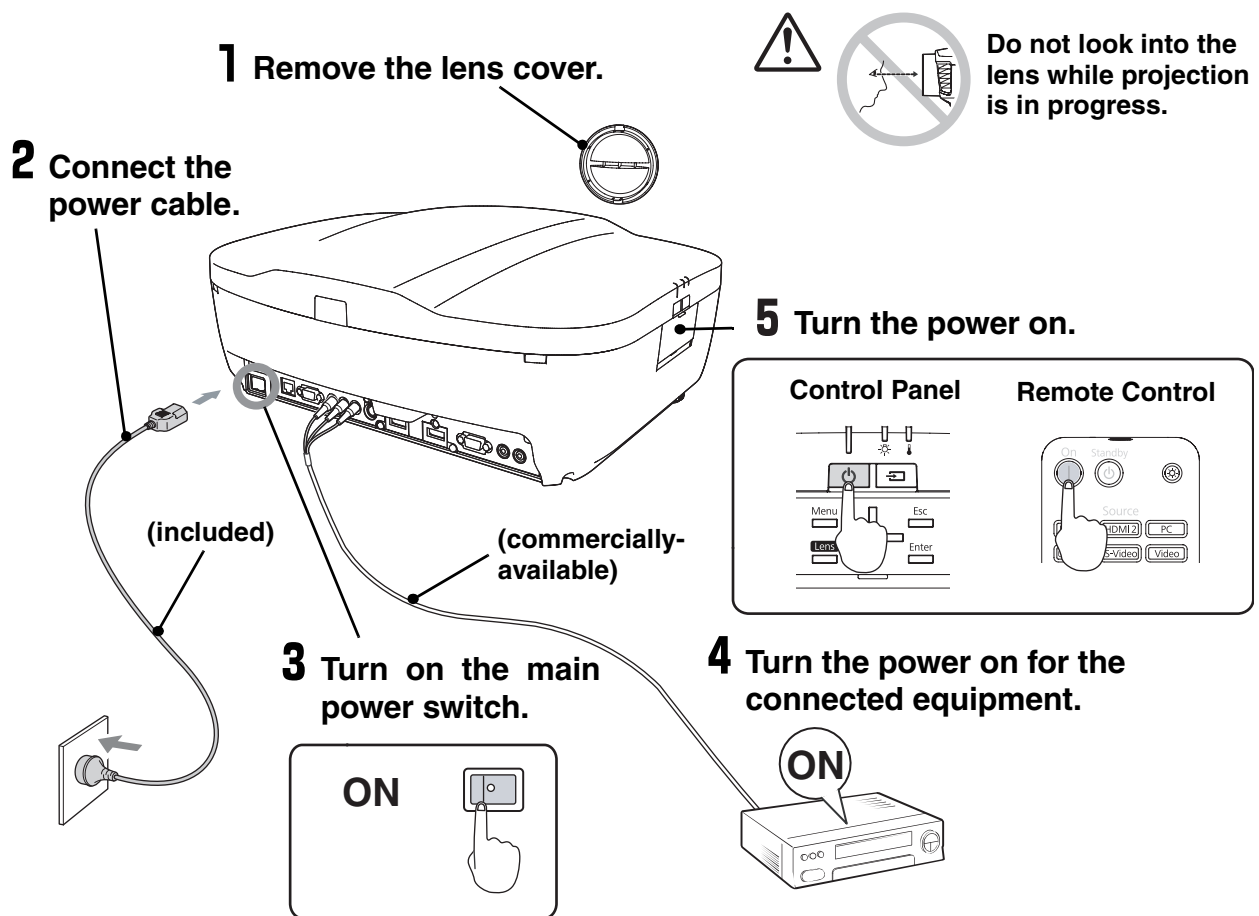

If there is a problem with projection even though the projector is set up and connected correctly, refer to [p.15, 54](#).



- If you set the "Direct Power On" to "On", the power of the unit will turn on when the main power switch is turned on, without having to press the power button of the remote control or the projector's control panel. [p.42](#)
- The projector is equipped with the "Child Lock" function that prevents young children from accidentally turning the power on and looking into the lens, and also the "Control Panel Lock" function that prevents mis-operations is available. [p.42](#)
- When using the projector at an altitude of about 1500m or above, make sure you set the "High Altitude Mode" to "On". [p.43](#)
- This projector is equipped with an automatic adjustment function that automatically optimizes it when a computer input signal is switched.
- If a laptop computer or a computer with a LCD screen has been connected to the projector, you may need to use keyboard or function settings to change the output destination. While holding down the **[Fn]** key, press **[FO]** (the key with a symbol such as / on it). After the selection is made, projection will soon start.
[Computer's documentation](#)
- By setting "Standby Mode" to "On", you can turn the projector on and off from a web browser on a networked computer. (EH-R4000) [p.42](#)

Example of output selection	
NEC	
Panasonic	[Fn] + [F3]
SOTEC	
HP	[Fn] + [F4]
Toshiba	[Fn] + [F5]
IBM	
LENOVO	[Fn] + [F7]
SONY	
DELL	[Fn] + [F8]
Fujitsu	[Fn] + [F10]
Macintosh	Set mirror setting or display detection. Depending on OS, you can change the output selection by pressing [F7] .

When the expected images are not projected

If more than one signal source has been connected, or if no images are projected, use the remote control or the projector's control panel buttons to select the signal source. For video devices, press the [Play] button on the video equipment first, then select the signal source.

Using the remote control

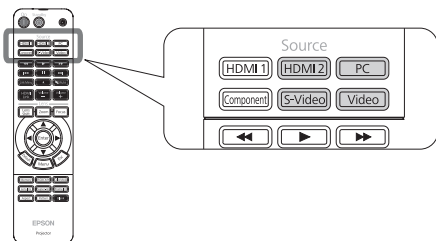

Press the button that has the name of the port on it that the desired signal source is connected to.





TIP

When the color of the image projected from the [Component] input port is unnatural, select an appropriate signal according to the signal from the device connected at "Input Signal" in the Configuration menu. [p.43](#)

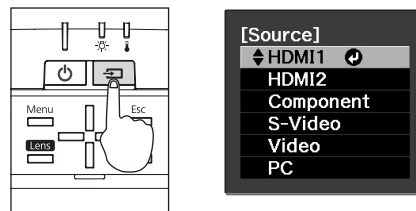
Using the control panel





When you press , the menu is displayed.

Each press of  moves the pointer. Move the pointer to the target input source to select it. The input source is automatically switched when no operations are performed about three seconds with placing pointer at the target input source. You can also press  to switch to the target source.

Turning the power off

1 Turn the power off for the signal sources that are connected to the projector.

2 Press  on the remote control or  on the projector's control panel.

If "Standby Confirmation" in the configuration menu is set to "On", the following message will be displayed when you press .



In such case, press  once more.

Power Off?

Yes : Press  button
No : Press any other button

You can set whether or not to display the confirmation message when  on the remote control is pressed. [p.43](#)

3 Once the **cool-down** period (approximately 16 seconds) has ended and the operation indicator has stopped flashing, turn off the main power switch.

The projector will switch to standby mode when  or  is pressed. To completely turn off the power for the projector, turn off the main power switch. The projector still consumes power while it is in standby mode.

4 Attach the lens cover.

If the projector is suspended from a ceiling and the lens cover is left removed, the lens cover will still be needed if the projector is moved anywhere, so keep it in a safe place.

Focus, zoom and image position can be adjusted electronically.

The following describes how to adjust these settings using the remote control. The settings can also be adjusted using the projector's control panel.

Focus adjustment

Press **Focus**, and then use to make the adjustment.

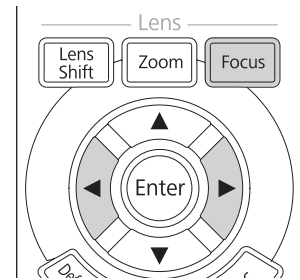
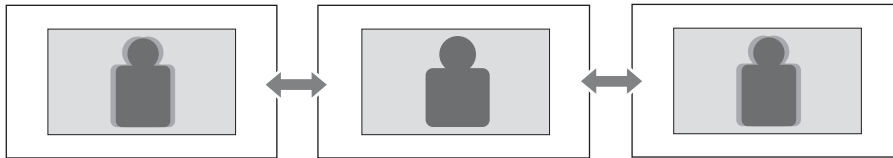

Projection size adjustment (Zoom adjustment)

Press **Zoom**, and then use to make the adjustment.

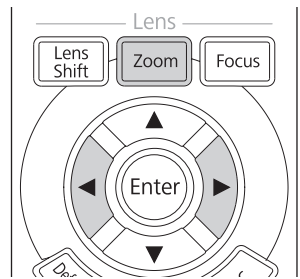
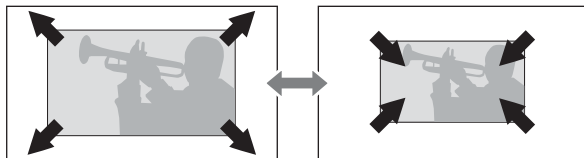

Projection image position adjustment (Lens shift)

If the projector cannot be set up directly in front of the screen, use the lens shift function to adjust the position of the projected images. The position can be adjusted within the range shown in the figure at right.

Press **Lens Shift** and then use to make the adjustment.

If you want to return the lens to the center position, hold down until the lens moves to the center position and stops.

To readjust, press the again.

The image position cannot be moved to the maximum vertical values and maximum horizontal values at the same time.

For example, when the image has been shifted vertically by the full amount, it can be shifted up to 4 percent of the horizontal width of the screen.

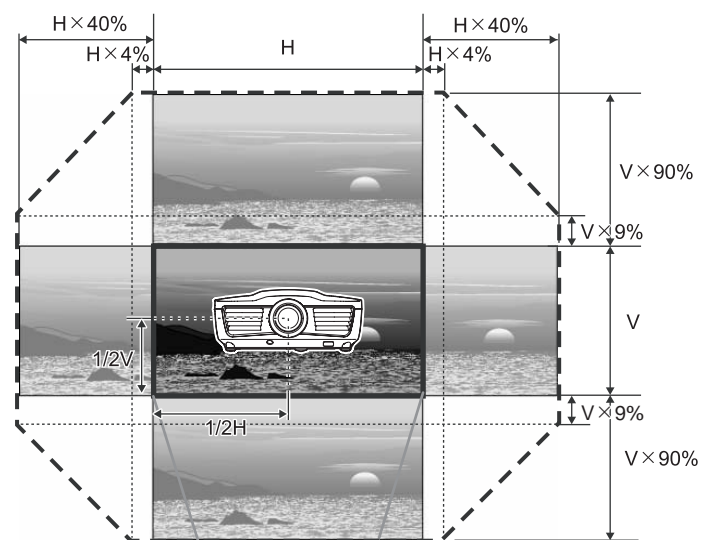



Attention Return the lens to the center position before transporting the projector. Transporting the projector with the lens positioned off center may damage the lens shift mechanism.

Standard projection position
(center position for lens shift)

Range that the picture can be shifted
from the standard projection position

Adjusting the tilt of the projector

When an image from the projector that is placed on a flat surface is tilting horizontally ( ) , use the front feet to correct the tilt.

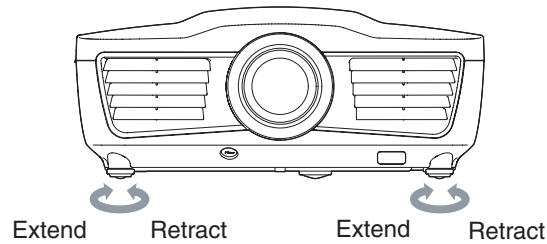

Displaying a test pattern

You can use a test pattern to make the first setup such as zoom, focus, and image position using the lens shift without connecting to any electrical equipment.

When you press  on the remote control, the test pattern menu will be displayed.

The display position and the R (red), G (green) and B (blue) settings can be adjusted.

To close the test pattern menu, press  or select "Exit".

Memory RGBCMY Color Mode
 Lens Iris Super-res Frame Int
 Aspect Pattern Blank

EPSON
Projector

Selecting the color mode

Selecting the aspect

Select Menu Operations

Use to select an item.
 Press to confirm the selection.
 *If you press , the Select menu disappears.

Selecting the color mode



Press and select the color mode from the menu. Setting is also possible using the configuration menu.



When inputting a signal through the HDMI1/HDMI2 terminals.

Dynamic : For projecting the brightest and clearest images.

Living Room : For projecting sharp and clear images.

Natural : For projecting images in the most natural and accurate colors. It is recommended that you start in this mode when making color adjustments.

Cinema : For viewing movies or films of concerts.

x.v.Color : You can select from either of the signals being input to the HDMI1 and HDMI2 terminals. Colors of images recorded in x.v.Color format can be produced accurately.

When you select any of the modes, the Epson cinema filter is automatically applied to achieve high fidelity color reproduction for original video sources.

Selecting the aspect»



Press **Aspect** and select the aspect mode from the menu.

Depending on the input signal, you may not be able to select the aspect ratio.









When projecting using **Auto**

- For 4:3 input signals → Normal
- For input images recorded in squeeze mode → Full
- For letterbox input signals → Zoom
- This is not available for when image signals are being input from a computer and for some component video» signals.
- If Auto is not suitable, the setting will become Normal.



TIP

If you project an image that is compressed, enlarged or separated using the aspect function in public places such as a store or hotel for the purposes of profit-making or public display, it may result in infringing on the author's right that is protected by copyright law.

Input signal	Recommended aspect mode	Result	Remarks
<ul style="list-style-type: none"> • Images with standard aspect ratio (4:3) • Computer images 	<div style="background-color: #555; color: white; padding: 5px; text-align: center;">Normal</div>	 <p>Black bands will appear at the left and right of the images.</p>	 <p>When HDTV images are projected, the images appear in 16:9 size.</p>
<p>Images recorded by a video camera or DVD software in squeeze mode</p>	<div style="background-color: #555; color: white; padding: 5px; text-align: center;">Full</div>	 <p>Input signals will be projected at the same width as the projector's panel resolution.</p>	 <p>When 4:3 images are projected, the images will be elongated horizontally.</p>
<p>Letterbox images</p>	<div style="background-color: #555; color: white; padding: 5px; text-align: center;">Zoom</div>	 <p>Input signals will be projected at the same height as the projector's panel resolution.</p>	<ul style="list-style-type: none"> • When a 4:3 image is projected, the top and bottom of the image are hidden from view. If this happens, the part of the image hidden from view at the top and bottom can be reduced in size in the vertical direction so that it can be viewed by "Zoom Size" in the Configuration menu. <small>☞ p.39</small> • When images with subtitles are projected and the subtitles are truncated, use the "Zoom Caption Pos." menu command to adjust. <small>☞ p.40</small>
<p>Images with standard aspect ratio (4:3)</p>	<div style="background-color: #555; color: white; padding: 5px; text-align: center;">Wide</div>	 <p>Input signals will be projected at the same height as the projector's panel resolution. At this time, the image enlargement ratio will be smaller near the middle of the images but become larger towards the left and right edges of the images.</p>	<p>This is useful for when 4:3 images are projected onto a wide screen. Because there is almost no distortion due to enlargement in the middle of the images, the images appear close to what they would be at their original size. And because both ends of the images are enlarged, movement at the edges of the images appears faster and gives an impression of greater speed, making it ideal for viewing sporting events.</p>
<ul style="list-style-type: none"> • Computer images • HD signals • SD signals 	<div style="background-color: #555; color: white; padding: 5px; text-align: center;">Anamorphic Wide</div>	 <p>Use this setting to view a movie in CinemaScope size on DVD or Blue-ray with a commercially-available anamorphic lens that can be attached to the projector.</p>	<p>Set "Overscan" to "Off" (100% display). Images may not be properly projected if other than "Off" is selected.</p>
<ul style="list-style-type: none"> • Computer images • HD signals • SD signals 	<div style="background-color: #555; color: white; padding: 5px; text-align: center;">Horiz. Squeeze</div>	 <p>Use this setting to view images in 16:9 or 4:3 when an anamorphic lens is attached on the projector.</p>	

You can select "Image" - "Sharpness" or "Advanced" to adjust the images according to your own preferences. The adjustment screen for "RGBCMY" can be displayed on the screen directly by pressing the corresponding button on the remote control.

The adjustment values can be stored in the memory so that you can retrieve them and apply them to the projected images at any time. ( p.26)

Hue, saturation, and brightness adjustment

The hue, saturation, and brightness for each of the R (red), G (green), B (blue), C (cyan), M (magenta) and Y (yellow) color components can be adjusted. Adjustment is not possible when "Color Mode" is set to "x.v. Color".

■ Hue

Adjusts the tone of the entire image to bluish, greenish and reddish.

■ Saturation





Adjusts the overall vividness of the images.

■ Brightness

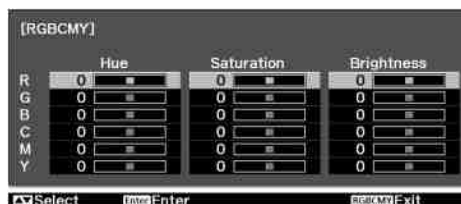

Adjusts the brightness of the overall image.

1 Press .

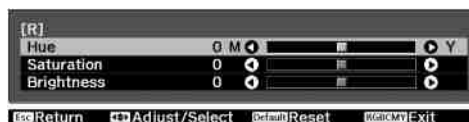

2 Use   to select and confirm the color, then select the hue, saturation or brightness and then use   to adjust.



To adjust another color, press .
To return the adjustment results to their default settings, press .

3 Press  to exit the menu.

Gamma adjustment

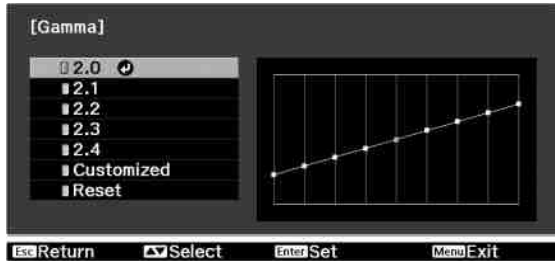

Differences between equipment may result in a slight variation in the coloring when images are projected, and you may want to adjust this. (Projection will stop temporarily during such adjustment.) There are two methods of doing so. One is to select one of the gamma correction values [2.0], [2.1], [2.2], [2.3], [2.4]. The other is customized adjustment, which is done with reference to the projected image or a gamma graph. The gamma graph's horizontal axis represents the input signal level and its vertical axis the output signal level. Adjustment is not possible when "Color Mode" is set to "x.v. Color".

■ Customized ("Adjust it from the image")

Press , and then select "Image" - "Advanced" - "Gamma" - "Customized" - "Adjust it from the image" in that order, and press to confirm the selection.

A gamma icon will appear in the projected image.



Use to move the gamma icon to the place where you want to adjust the brightness, and then press to confirm. The areas with the same brightness as the selected place will flash and the gamma adjustment graph will be displayed.

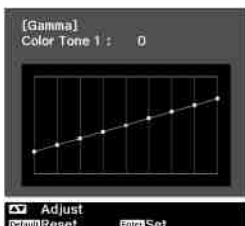

Use to adjust, and press to confirm. Press to go back and do it again.

■ Adjusting from the gamma correction values

Operate using the remote control.

1 Press , and then select "Image" - "Advanced" - "Gamma" in that order, and confirm the selection.

2 Use to select, and press to confirm.

Observe the gamma graph to check the result of the adjustment.

When a smaller value is selected, the dark areas of images become brighter, but the lighter areas may become oversaturated. This is indicated by bulging in the upper portion in the gamma graph.

When a larger value is selected, the bright areas of images become darker. This is indicated by bulging in the lower portion in the gamma graph.

■ Customized ("Adjust it from the graph")

Press , and then select "Image" - "Advanced" - "Gamma" - "Customized" - "Adjust it from the graph" in that order, and press to confirm the selection.

A gamma adjustment graph will appear.

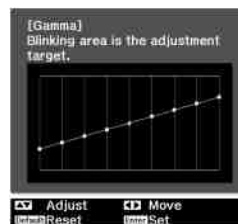

Use to select the place where you want to adjust the brightness of color tone.

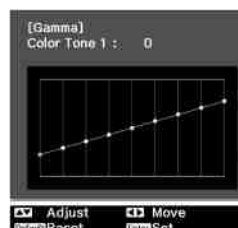

Use to adjust, and press to confirm. Press to go back and do it again.

RGB adjustment (Offset, Gain)

The image brightness can be adjusted by adjusting the individual R (red), G (green) and B (blue) components of the dark areas (offset) and bright areas (gain).

Adjustment is not possible when "Color Mode" is set to "x.v. Color".

■ Offset







If you would like dark areas to appear more clearly, change the setting to the + (right) side. If you change it to the – (left) side, the whole image will become sharper, but the contrast in dark areas will become poorer.

■ Gain

If you would like bright areas to appear more clearly, change the setting to the – (left) side. If you change it to the + (right) side, you will feel that the image is becoming brighter and closer to white, but the contrast in light areas will become poorer.

- 1 Press  and then select "Image" - "Advanced" - "RGB" in that order and confirm the selection.



- 2 Use   to select an item, and use   to adjust. To return the adjustment results to their default settings, press .
- 3 Press  to exit the menu.

Selecting the color gamut

Color gamut settings suited for various color formats of equipment are preset. You can make the color gamut setting appropriately just by selecting the item that matches with your equipment from the menu.

This setting is available only when "Color Mode" is set to "Natural".

- 1 Press  and then select "Image" - "Advanced" - "Color Gamut" in that order.

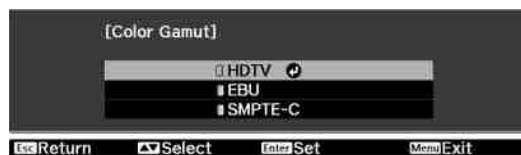

- 2 Select "HDTV", "EBU" or "SMPTE-C" according to the equipment being used, and then confirm the selection.
- 3 Press  to exit the menu.

In addition to color adjustments, adjustments to advanced sharpness and the amount of light from the lamp can also be made to match the image in search of the best picture.

Sharpness (Advanced) adjustment

If "Thin Line Enhancement" is set in the + direction, hair and the detailed areas of clothing will be emphasized.





If "Thick Line Enhancement" is set in the + direction, the areas emphasized by "Thin Line Enhancement" will be hardly emphasized. Instead, the rough areas of the entire subject, such as contour and background, will be emphasized, resulting in a sharp image.

Setting "Horiz. Line Enhancement" / "Vert. Line Enhancement" to the + side will enhance the image sharpness in the horizontal / vertical direction. Setting them to the - side will give a soft image.

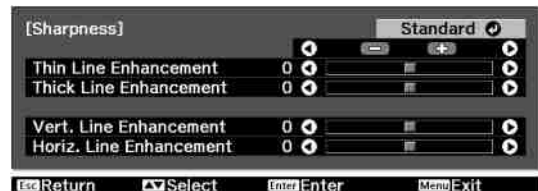
This cannot be adjusted during input of computer image signals.

- 1 Press , and then select "Image" - "Sharpness". Select "Advanced" at the top-right corner of the screen to confirm the selection.



- 2 Use   to select an item, and use   to adjust. You can adjust "Thin Line Enhancement" and "Thick Line Enhancement" at the same time by using the bar on the top in the screen. To return the adjustment results to their default settings, press .

- 3 Press  to exit the menu.



Auto Iris (automatic aperture) setting

When "Auto Iris" is on, the light intensity from the lamp is automatically controlled according to the brightness of images, and you can get higher contrast and rich images. Tracking speed of the light intensity control in response to changes in brightness of images can be set to either "Normal" or "High Speed" depending on your preference. Setting is not possible when "Color Mode" is set to "x.v. Color."

* An operation sound of Auto Iris function may be emitted while projecting some images. This is not a failure of the projector.

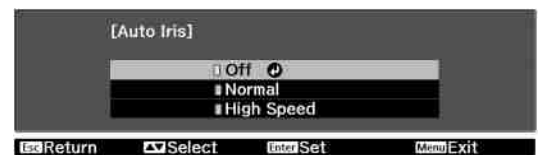
- 1 Press , and then select "Image" - "Auto Iris".



- 2 Use   to select an item, and then confirm the selection.

- 3 Press  to exit the menu.

Super-resolution

Blurred edges or portions of images caused by upscaling images, such as images of SD source, to panel resolution (1080p) can be sharpened with the super-resolution processing. The larger the number, the stronger the effect.

For some images, interference at the edges may become visually-enhanced.

This cannot be adjusted during input of computer image signals.

- 1 Press .



- 2 Press   to adjust.

- 3 Press  to exit.

Lens Iris

This adjusts the brightness by controlling the amount of light inside the projection lens. Unlike the Auto Iris function that automatically adjusts light intensity according to the images, you can manually change the amount of light, which is useful when viewing movies that have a lot of bright scenes.

- 1 Press .



- 2 Press   to adjust.

- 3 Press  to exit.

After using a subset of "Signal" and "Image" in the configuration menu to adjust the projected images, the adjusted values can then be saved (Save Memory).

In addition, the saved data can be retrieved easily, so that you can enjoy viewing images with the adjusted settings at any time (Load Memory).

Saving, Loading, Erasing and Renaming memory

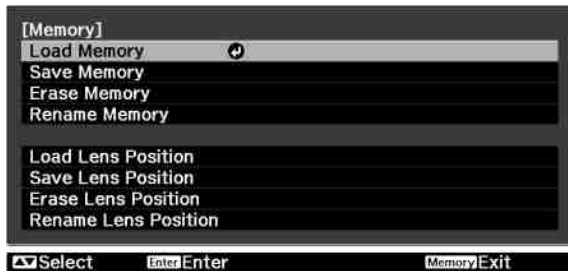

Up to ten adjustments can be saved to memory. The adjusted values of the following items can be saved.

Image Menu

All items

Signal Menu

- Progressive
- Frame Interpolation
- Super-resolution
- All items in "Advanced"

Depending on the input signals, it may not be possible to set some items.  p.30

Save Memory

1 Adjust each of the settings to the values to be saved.

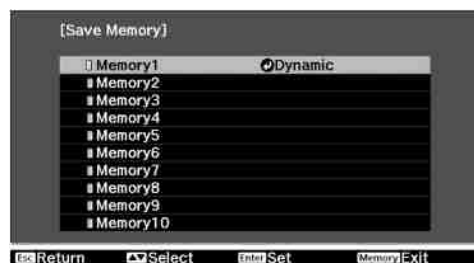

2 Press , and select "Save Memory".

The Save Memory screen is displayed.



3 Select the memory name to register the adjustments to from Memory1 to 10, and press  or .

When  preceding the memory name is green, this indicates that adjustments are already saved to memory.

Select an already saved memory name, and press  or . A confirmation message will be displayed. If you select "Yes", the previous memory content is erased, and the current adjustment values are saved.

Load Memory

Load saved memories.

1 Press , and select "Load Memory". The Load Memory screen will be displayed.

2 Select the target memory name.



TIP

- The color mode selected when the memory was registered is displayed on the right side.
- Some settings retrieved from memory may not be applied to the images depending on the input signal.

■ Erase Memory

This feature can be used to erase and clean up unwanted memories.





- 1 Press **Memory**, and select "Erase Memory". The Erase Memory screen will be displayed.
- 2 Select the memory name to erase. A confirmation message will be displayed. If you select "Yes", the memory will be erased.

To erase all saved memories, select "Reset" - "Reset Memory" in the Configuration menu.
 p.47

■ Rename Memory

The default names ("Memory1" to "Memory10") can be changed. You can rename memories so that its settings are easy to recognize.

- 1 Press **Memory**, and then select "Rename Memory". The "Rename Memory" screen is displayed.

- 2 Select the memory name to be changed, and then press **Enter** or **Enter**.
- 3 The name selection screen is displayed. To select a memory name from the displayed preset names, select the desired name and then press **Enter** or **Enter** and go to step 5. If you would like to use a custom name, select "Customized".
- 4 When you select "Customized", the following keyboard is displayed. Use     or  to select the desired key, and then press **Enter** or **Enter**. Up to 12 characters can be entered. Once you have entered the name, select "Finish" and then press **Enter** or **Enter**.



- 5 The selected or entered memory name is displayed beside the preset memory number to indicate that the name has been changed. After this, the changed name is displayed in the "Load Memory" and "Save Memory" screens.

The Focus, zoom and lens shift adjustment results can be stored as a setting file in the memory of projector. (Save Lens Position)

The stored settings can be loaded easily, so that you can enjoy watching images without adjusting the focus, zoom, and lens position. (Load Lens Position)

You can change the default names of the stored setting files, so that you can easily find your desired one from the list of the setting files. (Rename Lens Position)

Saving, Loading, Deleting and Renaming lens position

■ Save Lens Position

The current zoom, focus and lens shift settings will be saved.

Up to three setting files can be stored.

- 1 Press  and select "Memory" - "Save Lens Position".

The Save Lens Position screen will be displayed.

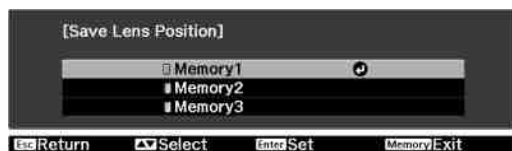

- 2 Select "Memory1", "Memory2" or "Memory3", and then confirm the selection. The current settings are stored in the selected memory.

If you select the memory in which you have already stored settings, a confirmation message will be displayed.

If you select "Yes", the previous settings will be overwritten with the current settings.

■ Loading Adjustment Values

The stored settings can be retrieved.

- 1 Press  and select "Memory" - "Load Lens Position".

The Load Lens Position screen will be displayed.

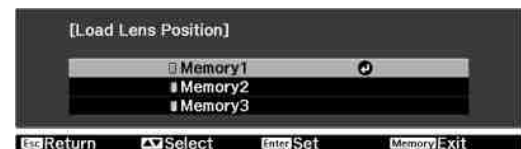

- 2 Select the desired lens position name.

The zoom, focus and lens shift will be adjusted to the selected lens position settings.

While adjustment is in progress, a message will be displayed and the projector cannot be operated.



TIP

About "Load Lens Position"

This does not guarantee that the stored settings are fully reproduced. Some differences may occur.

■ Deleting Stored Settings

The stored settings can be erased.

- 1 Press  and select "Memory" - "Erase Lens Position".
The Erase Lens Position screen will be displayed.

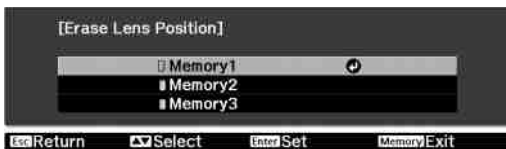

- 2 Select the lens position to be erased.
A confirmation message will be displayed.
Select "Yes" to erase.

To erase all of the stored lens positions, select "Reset" - "Reset Lens Position" in the configuration menu.

 p.47







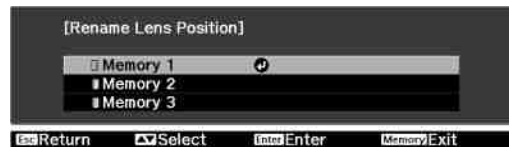

■ Changing the Name of Stored Settings

The names of stored settings can be changed.

- 1 Press  and select "Memory" - "Rename Lens Position".
The Rename Lens Position screen will be displayed.



- 2 Select the lens position to be renamed and then press  or .

- 3 The keyboard screen will be displayed.
Use     or  to select the desired key, and then press  or . Once you have entered the name, select "Finish" and then press  or .



- 4 The selected or entered name is displayed beside the lens position name to indicate that the name has been changed.

After this, the changed name is displayed in the "Load Lens Position" and "Save Lens Position" screens.

The configuration menus can be used to make a variety of adjustments and settings involving image quality and input signals.

The following describes how to make these settings using the remote control. The settings can also be adjusted using the projector's control panel.

All items in the configuration menu can be checked while the settings are being made.

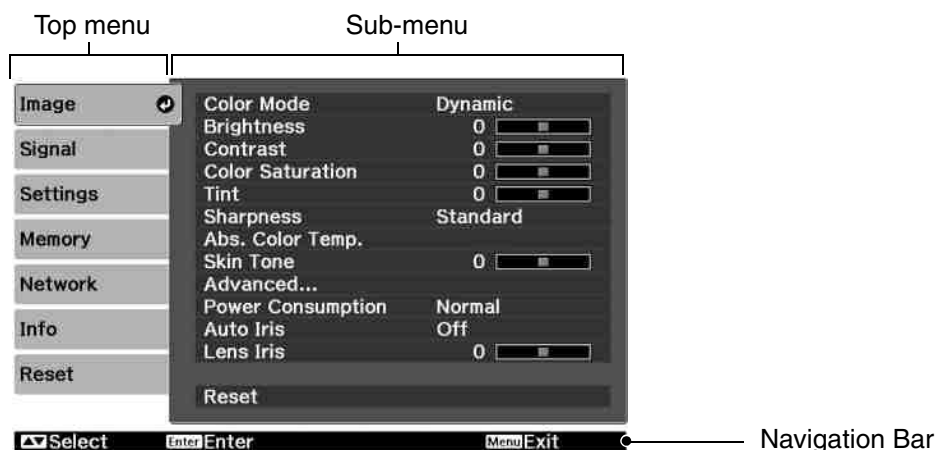

For details on the operation method, refer to "Using the configuration menus" in the next section.



The Configuration menu can be used to change the color pattern and display position of the menus.

☞ "Settings" - "Display" - "Menu Position", "Menu Color"



Using the configuration menus

1 Displaying a menu

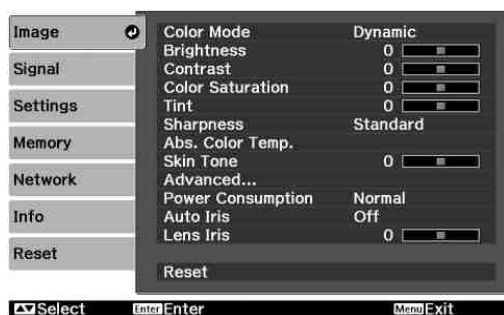
Press .



2 Selecting a menu item

Use  or  to select a menu item, then press .

3 Changing settings

Example:



Use or to adjust values.

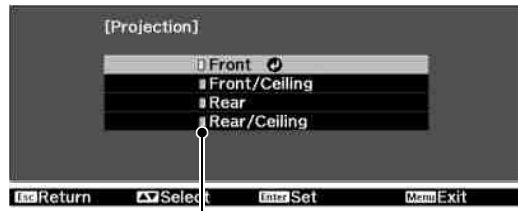

(green): Current setting value

Use or to select an item, then press .

If you press when an item with next to it is selected, the selection screen for that item will be displayed.

To return to a previous display, press .



TIP

- For items such as "Brightness" which can be adjusted using an adjustment bar, the adjustment values can be reset to the default if you press while the adjustment bar is being displayed.
- If on the remote control is pressed while a menu is being displayed, the menu screen disappears. This is useful for checking your adjustment result on the images. If you press once more, the menu is displayed again.

4 When setting is complete

Press .

List of configuration menus (EH-R2000)

When no image signals are being input, the "Image" menu and the "Signal" menu cannot be adjusted. Also, the items displayed in the "Image" menu, the "Signal" menu and the "Info" menu will vary depending on the type of image signals that are being projected.

Not displayed when image signals are being input from a computer.

Image	Color Mode	p.38	Dynamic, Living Room, Natural, Cinema, x.v.Color ("x.v.Color" is displayed when a signal is being input through the HDMI1/HDMI2 input terminals.)
	Brightness	p.38	Standard
	Contrast	p.38	Advanced Thin Line Enhancement, Thick Line Enhancement, Horiz. Line Enhancement, Vert. Line Enhancement
	Color Saturation	p.38	Gamma
	Tint	p.38	2.0, 2.1, 2.2, 2.3, 2.4
	Sharpness	p.38	Customized Adjust it from the image Adjust it from the graph
	Abs. Color Temp.	p.38	Reset
	Skin Tone	p.38	RGB
	Advanced	p.38	Offset R, G, B Gain R, G, B
	Power Consumption	p.39	Normal, ECO
	Auto Iris	p.39	Off, Normal, High Speed
	Lens Iris	p.39	Color Gamut
	Reset	p.39	Yes, No



Not displayed when image signals are being input from a computer.
 Only displayed for Computer image input (does not appear when signals from the [HDMI1]/[HDMI2] input port are being input)

Only displayed for component video or computer image signals from [HDMI1]/[HDMI2] input.
 Only displayed for component video image input.





Signal	Aspect	p.39	Auto, Normal, Full, Zoom, Wide, Anamorphic Wide, Horiz. Squeeze
	Zoom Size	p.39	
	Zoom Caption Pos.	p.40	
	Tracking	p.40	
	Sync	p.40	
	Position	p.40	
	Progressive	p.40	Video, Film, Auto
	Frame Interpolation	p.40	Off, Low, Normal, High
	Super-resolution	p.40	
	Auto Setup	p.40	On, Off
	Advanced	p.40	Noise Reduction Off, 1, 2, 3 Mosquito NR Off, 1, 2, 3 Block NR On, Off Setup Level 0%, 7.5% EPSON Super White On, Off
	Reset	p.41	Yes, No
			Overscan Auto, Off, 2%, 4%, 6%, 8% HDMI Video Range Auto, Normal, Expanded

Settings	Lock Setting p.42	Lens Lock	On, Off
		Child Lock	On, Off
		Control Panel Lock	On, Off
	Projection p.42	Front, Front/Ceiling, Rear, Rear/Ceiling	
	Operation p.42	Direct Power On	On, Off
		Sleep Mode	Off, 5min., 10min., 30min.
		Illumination	On, Off
		Trigger Out	Off, Power, Anamorphic Wide
		High Altitude Mode	On, Off
	Display p.43	Menu Position	Top-left, Top-center, Top-right, Center-left, Center, Center-right, Bottom-left, Bottom-center, Bottom-right
Menu Color		Color 1, Color 2	
Messages		On, Off	
Display Background		Black, Blue, Logo	
Startup Screen		On, Off	
Standby Confirmation		On, Off	
Input Signal p.43	Video Signal	Auto, <u>NTSC</u> ▶▶, NTSC4.43, <u>PAL</u> ▶▶, M-PAL, N-PAL, PAL60, <u>SECAM</u> ▶▶	
	Component	Auto, <u>YCbCr</u> ▶▶, <u>YPbPr</u> ▶▶	
Language p.44	日本語, English, Français, Deutsch, Italiano, Español, Português, 中文(简体), 中文(繁體), 한국어, Nederlands, Dansk, Polski, Magyar, Česky, Norsk, Svenska, Suomi, Русский, Ελληνικά, Türkçe		
Reset p.44	Yes, No		

Memory	Load Memory p.44	Memory1 to Memory10
	Save Memory p.44	Memory1 to Memory10
	Erase Memory p.44	Memory1 to Memory10
	Rename Memory p.44	Memory1 to Memory10
	Load Lens Position p.44	Memory1 to Memory3
	Save Lens Position p.44	Memory1 to Memory3
	Erase Lens Position p.44	Memory1 to Memory3
	Rename Lens Position p.44	Memory1 to Memory3

-  Only displayed for composite video/S-Video input
-  Only displayed for component video/Computer image input

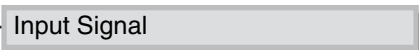
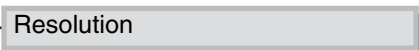
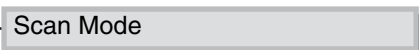
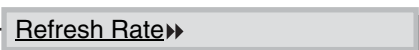
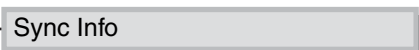
Info

-  Lamp Hours
 - The message text will be displayed in yellow when it is time to replace the lamp.
 - Time from 0H to 10H will be displayed as 0H. From 10H onwards, the display will be in units of 1H.
-  Source
-  Input Signal
-  Resolution
-  Scan Mode
-  Refresh Rate▶
-  Sync Info
-  Video Signal

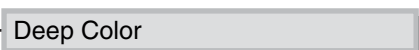







The "Info" menu is only used to display the projector status.
-  Deep Color

Display the color depth of HDMI transmission.
-  Status

This is information about errors that have occurred on the projector.
This value is sometimes referred to when inquiries are made.
-  Serial Number

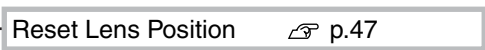
This value is sometimes referred to when inquiries are made.

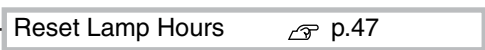
Reset

-  Reset All  p.47
-  Reset Memory  p.47
-  Reset Lens Position  p.47
-  Reset Lamp Hours  p.47

List of configuration menus (EH-R4000)

When no image signals are being input, the "Image" menu and the "Signal" menu cannot be adjusted. Also, the items displayed in the "Image" menu, the "Signal" menu and the "Info" menu will vary depending on the type of image signals that are being projected.

Not displayed when image signals are being input from a computer.

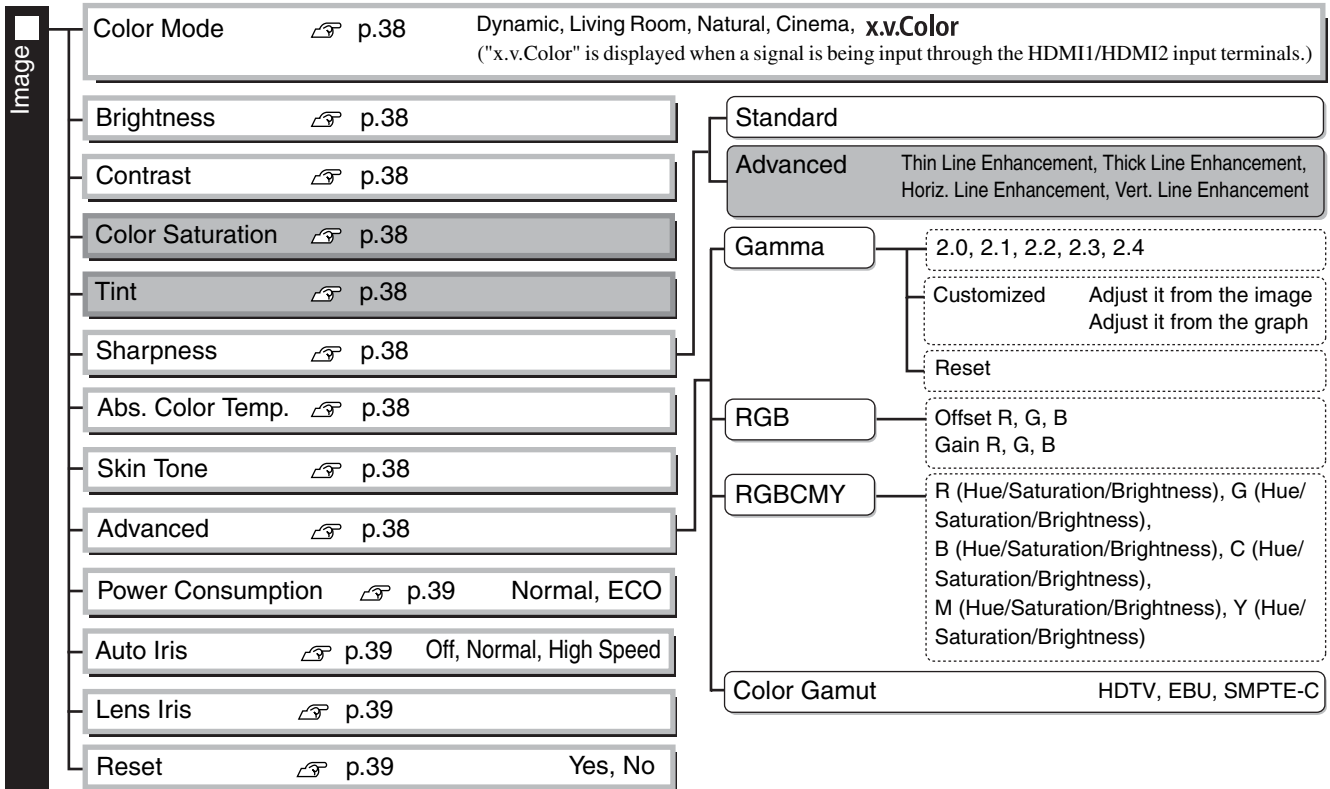







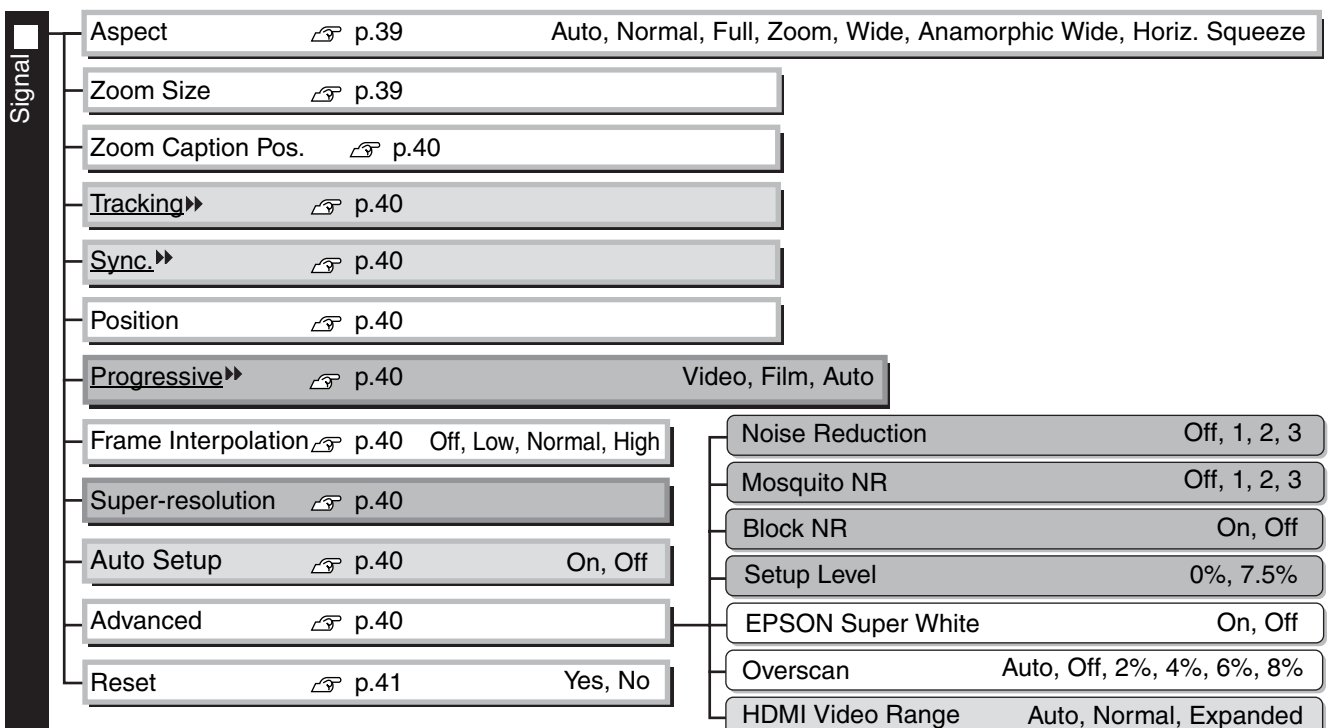

Not displayed when image signals are being input from a computer.









Only displayed for Computer image input (does not appear when signals from the [HDMI1]/[HDMI2] input port are being input)

Only displayed for component video or computer image signals from [HDMI1]/[HDMI2] input.

Only displayed for component video image signals input.



Settings	Lock Setting  p.42	Lens Lock	On, Off
		Child Lock	On, Off
		Control Panel Lock	On, Off
	Projection  p.42	Front, Front/Ceiling, Rear, Rear/Ceiling	
	Standby Mode  p.42	Communication On, Communication Off	
	Operation  p.42	Direct Power On	On, Off
		Sleep Mode	Off, 5min., 10min., 30min.
		Illumination	On, Off
		Trigger Out 1	Off, Power, Anamorphic Wide
		Trigger Out 2	Off, Power, Anamorphic Wide
High Altitude Mode		On, Off	
Display  p.43	Menu Position	Top-left, Top-center, Top-right, Center-left, Center, Center-right, Bottom-left, Bottom-center, Bottom-right	
	Menu Color	Color 1, Color 2	
	Messages	On, Off	
	Display Background	Black, Blue, Logo	
	Startup Screen	On, Off	
	Standby Confirmation	On, Off	
Input Signal  p.43	Video Signal	Auto, <u>NTSC</u> ^{▶▶} , NTSC4.43, <u>PAL</u> ^{▶▶} , M-PAL, N-PAL, PAL60, <u>SECAM</u> ^{▶▶}	
	Component	Auto, <u>YCbCr</u> ^{▶▶} , <u>YPbPr</u> ^{▶▶}	
Language  p.44	日本語, English, Français, Deutsch, Italiano, Español, Português, 中文(简体), 中文(繁體), 한국어, Nederlands, Dansk, Polski, Magyar, Česky, Norsk, Svenska, Suomi, Русский, Ελληνικά, Türkçe		
Reset  p.44	Yes, No		

Memory	Load Memory  p.44	Memory1 to Memory10
	Save Memory  p.44	Memory1 to Memory10
	Erase Memory  p.44	Memory1 to Memory10
	Rename Memory  p.44	Memory1 to Memory10
	Load Lens Position  p.44	Memory1 to Memory3
	Save Lens Position  p.44	Memory1 to Memory3
	Erase Lens Position  p.44	Memory1 to Memory3
	Rename Lens Position  p.44	Memory1 to Memory3

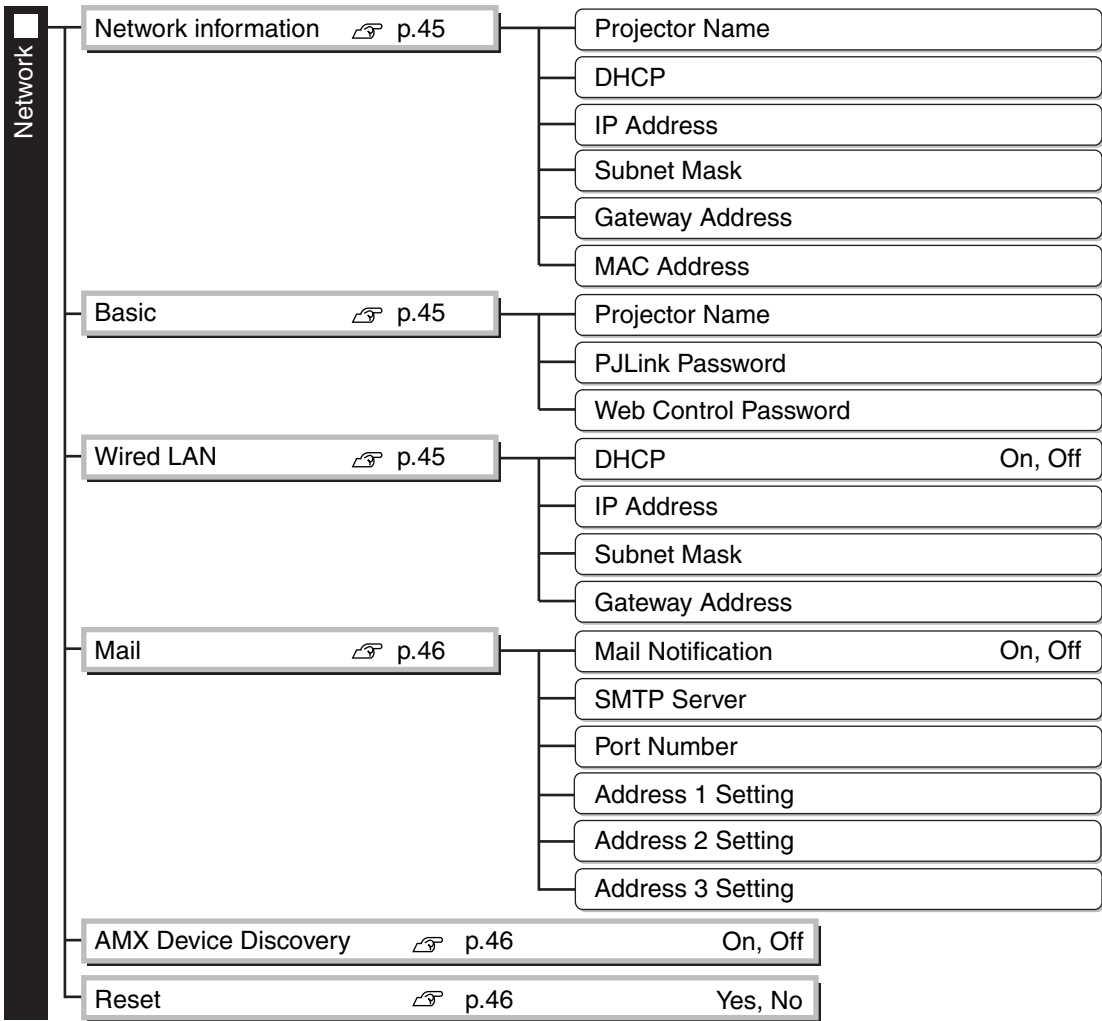

Only displayed for composite video/S-Video input
 Only displayed for component video/Computer image input

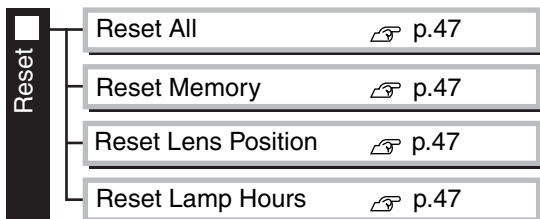
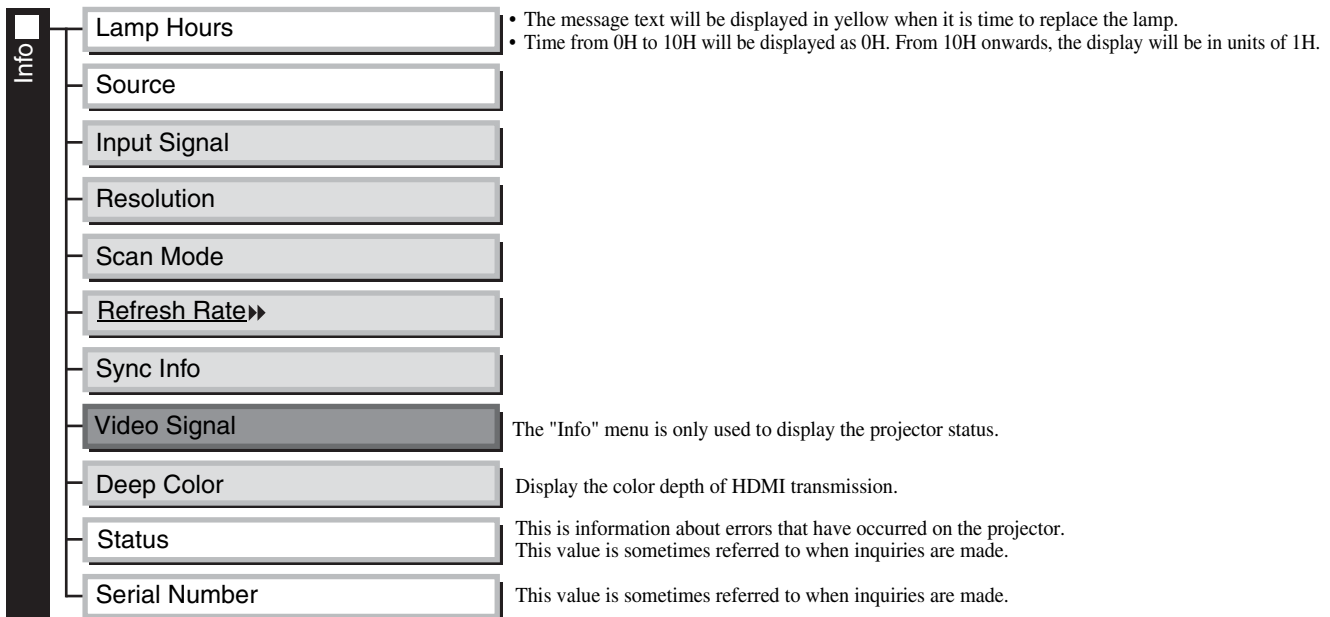

"Image" menu

Not displayed when image signals are being input from a computer.

Color Mode ^{*1}

Five different settings can be selected for the Color Mode, to match the images being projected or the projection environment.  p.18

Brightness ^{*2}

(Adjustment is not possible when "Color Mode" is set to "x.v.Color".)

Adjust this when the output level of the connected equipment is weak and you feel that images are dark.

Contrast ^{*2}

(Adjustment is not possible when "Color Mode" is set to "x.v.Color".)

Adjusts the difference between bright and dark areas.

When the contrast is increased, images with greater modulation are obtained.

Color Saturation ^{*2}

(Adjustment is not possible when "Color Mode" is set to "x.v.Color".)

This adjusts the color intensity for the images.

Tint ^{*2}

(Adjustment is not possible when "Color Mode" is set to "x.v.Color".)

This adjusts the image tint.

Sharpness ^{*2}

This adjusts the image sharpness.

Standard

The adjustment results are applied to the entire image.

Advanced

This can be used to adjust a specific region.  p.24

Abs. Color Temp. ^{*2}

(Adjustment is not possible when "Color Mode" is set to the following. EH-R4000 : "Natural", "x.v.Color")

This adjusts the overall tints of the images. If you select a higher value, images appear bluish, and if you select a lower value, images appear reddish. The absolute color temperature can be set to one of 12 settings within the range of 5000K to 10000K.

Skin Tone ^{*2}

(Adjustment is not possible when "Color Mode" is set to the following. EH-R4000 : "Natural", "x.v.Color")

This adjusts the skin tones of people who appear in the images. If you select a higher value, green tone is increased, and if you select a lower value, red tone is increased.

Advanced

(Adjustment is not possible when "Color Mode" is set to "x.v.Color".)

Gamma ^{*1}

This adjusts gamma. You can select a value, or make adjustments while viewing an image or a graph.  p.22

RGB ^{*1}

This lets you adjust the offset and gain for each of the R/G/B color components.  p.23

*1 The setting values are stored separately for each image source and signal type.

*2 The setting values are stored separately for each image source and color mode setting.

RGBCMY *1

This lets you adjust the hue, saturation, and brightness for each of the R/G/B/C/M/Y color components.  p.21

Color Gamut *1

(This can be set only when "Color Mode" is set to "Natural".)

Select according to the color gamut mode for the equipment being used.  p.23

- HDTV : Reproduces color gamut of the HDTV studio standard (international standard).
- SMPTE-C : Reproduces color gamut of the SMPTE-C standard.
- EBU : Reproduces color gamut of the EBU standard.

Power Consumption *2

This lets you set the lamp brightness to one of two settings.

Set to "ECO" if the projection images are too bright when projecting in a dark room or projecting onto a small screen. When used at the "ECO" setting, the power consumption and fan noise during projection is reduced.

Auto Iris *3

(Setting is not possible when "Color Mode" is set to "x.v.Color".)

Tracking speed of the light intensity control in response to changes in brightness of images can be set to either "Normal" or "High Speed" depending on your preference. If set to "Off", no light intensity control is performed.  p.24

Lens Iris

This adjusts the brightness by controlling the amount of light inside the projection lens.  p.25

Reset

This returns all settings in the "Image" menu to their default settings.

"Signal" menu**Aspect » *1**

Selects the aspect mode.  p.18

Zoom Size *1

(This can be set only when "Aspect" is set to "Zoom".)

This function enables the image to be reduced in size in the vertical direction so that the top and bottom of images that are hidden from view can be viewed when "Zoom" is set. The larger the adjustment value (reduction ratio) set here, the more the image is compressed and displayed squashed in the vertical direction.

*1 The setting values are stored separately for each image source and signal type.

*2 The setting values are stored separately for each image source and color mode setting.

*3 The setting values are stored separately for each color mode setting.

- Not displayed when image signals are being input from a computer.
- Only displayed for Computer image input (does not appear when signals from the [HDMI1] / [HDMI2] input port are being input)

Zoom Caption Pos. *1

(This can be set only when "Aspect" is set to "Zoom".)
 This function moves the display position of the image in one direction, up or down, to display captions when projecting images with captions.

Tracking ▶ *1





This adjusts the images if vertical stripes appear in the images.

Sync. ▶ *1

This adjusts the images if flickering, fuzziness or interference appear in the images.

- Flickering and fuzziness may also occur when the brightness, contrast▶ and sharpness settings are adjusted.
- Clearer adjustments can be obtained if you adjust the "Tracking" first and then adjust the "Sync."

Position *1

(Setting is not possible when signals are being input from the [HDMI1] / [HDMI2] input port.)
 When part of the image is clipped, move the image display position vertically and horizontally so that the entire image is projected. Press , ,  and  to adjust the position.

Progressive▶▶ *1

(This can be set only when signals are being input from the [Video] / [S-Video] input port, or 480i, 576i, 1080i signals are being input from the [Component] / [HDMI1] / [HDMI2] input port.)
Interlace▶▶ (i) signals are converted to progressive (p) signals using a method appropriate for the image.

- Video : This is ideal for general video images.
- Film : This is ideal for film images. Select this if the setting is "Auto" and flickering appears in the film images.
- Auto : Optimum conversion is performed for movie, computer graphics, and animation input signals.

Frame Interpolation *1

The current and previous frames are compared, and the frame in the middle of them is interpolated to reduce fuzziness and to produce clearer moving images. The degree of interpolation can be set to "Low", "Normal" or "High" as desired. Set to "Off" if noise occurs at the "Low", "Normal" or "High" setting.

Super-resolution *1

This improves blurred images and rough edges, giving the projected images a fine, detailed appearance. The larger the number is, the stronger the effect becomes.  p.25

Auto Setup

This sets automatic adjustment to on or off in order to set whether the projector automatically adjusts images to their optimum condition when the input signal is changed. The three automatically adjusted items are "Tracking", "Position" and "Sync."

Advanced

(Setting is not possible when "Color Mode" is set to "x.v.Color".)

Noise Reduction *1

This reduces flickering of images.
 Three modes are available. Select the mode to suit your liking.
 Set "Off" when the image source, such as DVD, contains little electrical interference.

Not displayed when image signals are being input from a computer.

Only displayed for Computer image input (does not appear when signals from the [HDMI1] / [HDMI2] input port are being input)

Mosquito NR (Mosquito Noise Reduction)^{*1}

This reduces the noise which can be generated around the edges of images when projecting MPEG images. Three modes are available. Select your preferred mode.

Block NR (Block Noise Reduction)^{*1}

Set to "On" to reduce block noise which can occur when projecting MPEG images which have been compressed at a low bit rate.

Setup Level^{*1}

(This can be set when **NTSC** signals are being input from the [Video] / [S-Video] input ports, or when component video signals are being input from the [Component] input port.)

If using products designed for destinations such as South Korea that have different black level (setup level) settings, use this function to obtain correct images. Check the specifications of the connected equipment when changing this setting.

EPSON Super White^{*1}

(This can only be adjusted when the color mode is set to "Natural" or "Cinema" and signals are being input via the [HDMI1]/[HDMI2] input ports.)

If bright white areas of images appear uneven and overexposed, set to "On".

When set to "On", the "HDMI Video Range" setting will be ignored.

Overscan^{*1}

(Setting is possible only when signals are being input from the [HDMI1]/[HDMI2]/[Component] input port.)

- Off, 2%, 4%, 6%, 8%: If set to "Off", the top and the bottom of the image are sometimes affected by electrical interference depending on the image signal. In such cases, try to adjust the display position ("Position").  p.40
- Auto: Displayed when the signals from [HDMI1] / [HDMI2] input port are being input. This is automatically set to Off or 8%, depending on the input signal. (If the DVI port of the connected equipment is connected to the [HDMI1] / [HDMI2] input port, "Auto" will not be displayed.)

HDMI Video Range^{*1}

(Setting is possible only when "EPSON Super White" is "Off". Setting is not possible, however, when "Color Mode" is set to "x.v.Color".)

When the [HDMI1] / [HDMI2] input port of the projector is connected to a DVD player, for example, setting this to Auto allows the projector to automatically determine and set the video range of the input signal.

If this is set to Auto and a blackout/whiteout condition occurs, set the video range of the projector to match that of the DVD player. The setting on the DVD player can be either Normal or Expand.

(If the DVI port of the connected equipment is connected to the [HDMI1] / [HDMI2] input port, "Auto" will not be displayed.)

Reset





All the adjustment values on the "Signal" menu, except "Aspect", are returned to their default values.

*1 The setting values are stored separately for each image source and signal type.



"Settings" menu

Lock Setting

Lens Lock

When this is set to "On", the "Focus", "Zoom" and "Lens Shift" settings will be locked at their current settings. If you press ,  or  when "Lens Lock" is "On",  will be displayed on the screen.



Child Lock

This locks the power on function of the  on the projector's control panel, so that a child cannot accidentally turn the projector's power on and look into the projector's lens. When the lock is applied, the power will only turn on if  is pressed down for about 3 seconds.  can be used to turn off the power, and the remote control will continue to operate as normal.

If you change the setting, the new setting will take effect after the power has been turned off and the cool-down period is complete.

Even if "Child Lock" is set to "On", be aware that projection starts merely by turning the main power switch on when "Direct Power On" is set to "On".

Control Panel Lock

When this is set to "On", all buttons on the projector's control panel except for  will become disabled.  will be displayed on the screen if any of the locked buttons is pressed. To cancel, press and hold  on the projector's control panel for about seven seconds or more.

If you change the setting, the new setting will take effect after exiting the configuration menu.

Projection

This should be set in accordance with the method used to set up the projector.



- Front : Select when the projector is set up in front of the screen.
- Front/Ceiling : Select when the projector is set up in front of the screen and suspended from a ceiling.
- Rear : Select when the projector is set up behind the screen.
- Rear/Ceiling : Select when the projector is set up behind the screen and suspended from a ceiling.

Standby Mode (EH-R4000 only)

Set to "Communication On" if you want to monitor and/or control the projector via a network even while the projector is in standby mode.

Operation

Direct Power On

When the main power switch is turned on, you can set for projection to start (On) / not start (Off) without pressing  or .

When set to "On" with the main power switch left on, be aware that sudden surges of electricity that may occur when the power comes back on after a power outage may cause the projector to turn on.

Sleep Mode

The projector is equipped with a power-saving function that causes the power to turn off automatically and the projector to switch to standby if no signal is input to the projector for a continuous length of time. The length of time before the power-saving function operates can be selected from four available settings.

If "Off" is selected, the power-saving function will not operate.

If you press  while the projector is in standby mode, projection will start again.

Illumination

Set to "Off" to turn off the light of  and operation indicator, so that you can enjoy watching movies in a dark room without being disturbed by the light.

Trigger Out

This sets the trigger out function which communicates information such as the power on status of the projector to external equipment.

If you change the setting, the new setting will take effect after the power has been turned off and the cool-down period is complete.

- Off : No voltage is output from the trigger out port.
- Power : When the projector's power is turned on, a voltage is output from the trigger out port.
- Anamorphic Wide: If the projector's power is turned on while the aspect mode is set to "Anamorphic Wide" or "Horiz. Squeeze", a voltage will be output from the trigger out port.





High Altitude Mode

A fan is set at a certain speed of rotation so as to bring down internal temperature.

When using above an altitude of about 1500m, set to "On".

Display

Menu Position

Press , ,  and  to specify the position for the menus to be displayed.

Menu Color

Selects the color for the main configuration menu.

- Color 1: Black
- Color 2: Blue

Messages

This sets whether the following message displays appear (On) or don't appear (Off).

- Image signal, color mode, aspect and item name when memory settings are retrieved.
- If no image signals are being input or the input signals are not supported.

Display Background

Displays a menu for selecting the screen status for when using the blank function or when no image signal is input.

Startup Screen

This sets whether the startup screen (the EPSON logo screen which is projected when projection starts) is displayed (On) or not displayed (Off). If you change the setting, the new setting will take effect after the power has been turned off and the cool-down period is complete.

Standby Confirmation

This sets whether a confirmation message is displayed (On) or not displayed (Off) when  on the remote control is pressed.

Input Signal

Video Signal

Sets the signal format in accordance with the video equipment that is connected to the [Video] or [S-Video] input port. If set to "Auto", the video signal format is set automatically.

If there is a lot of interference in the image, or if a problem such as no image being projected occurs even though "Auto" has been selected, select the correct signal format manually.

Component

Change this setting depending on the type of signal that is being output from the video equipment that is connected to the [Component] input port.

If "Auto" is selected, appropriate signal is automatically set. If colors appear unnatural even though "Auto" is selected, select appropriate signal name in the menu.

Language

This sets the display language for messages and menus.

Reset

All adjustment values in the "Settings" menu other than "High Altitude Mode", "Projection", "Component", "Language" and "Standby Mode" (EH-R4000 only) are reset to their default values.

"Memory" menu

Load Memory

This retrieves settings previously saved using "Save Memory".  p.26

This cannot be selected when nothing is saved at "Save Memory".

Save Memory

You can store the settings adjusted using the "Signal" and "Image" menus.  p.26

Erase Memory

You can erase stored memories that you no longer use.  p.26

Rename Memory

This can be used to change the names of the memories from "Memory1" to "Memory10". You can rename so that its settings are easy to recognize. Either of the following two methods can be used to change a memory name.  p.26

- Select a new memory from the list and then rename it.
- Select "Customized" and then enter a desired name.

Load Lens Position

This retrieves settings previously saved using "Save Lens Position".  p.28

This cannot be selected when nothing is saved at "Save Lens Position".

Save Lens Position

You can store the settings of focus, zoom and lens shift.  p.28

Erase Lens Position

You can erase stored lens position settings that you no longer use.  p.28

Rename Lens Position

This can be used to change the names of the memories from "Memory1" to "Memory3".



"Network" menu (EH-R4000 only)

Network information

You can check the setting status for each network.

Projector Name

Displays the projector name used to identify the projector when connected to a Network.

DHCP

Shows whether DHCP is in use (On) or not in use (Off).

IP Address

Shows the IP address to be assigned to the projector.

Subnet Mask

Shows the subnet mask for the projector.

Gateway Address

Shows the gateway IP address for the projector.

MAC Address

Displays the MAC address.

Basic

Projector Name

Displays the projector name used to identify the projector when connected to a Network. When editing, you can enter up to 16 single-byte alphanumeric characters.

PJLink Password

Set a Password to use when you access the projector using compatible PJLink software. You can enter up to 32 single-byte alphanumeric characters.

Web Control Password

Set a password to use when making settings and controlling the projector using Web Control. You can enter up to eight single-byte alphanumeric characters. Web Control is a computer function that allows you to set up and control the projector by using the Web browser on a computer connected on a Network.

Wired LAN

DHCP

Set whether or not (On/Off) to use DHCP. If this is set to "On" you cannot set any more addresses.

IP Address

You can input the IP Address assigned to the projector. You can enter a number from 0 to 255 in each field of the address. However, the following IP Addresses cannot be used.

0.x.x.x, 127.x.x.x, 224.0.0.0 to 255.255.255.255 (where x is a number from 0 to 255)

Subnet Mask

You can input the subnet mask for the projector. You can enter a number from 0 to 255 in each field of the address. However, the following Subnet Masks cannot be used.

0.x.x.x to 254.x.x.x, 255.255.255.255

Gateway Address

You can input the IP address for the gateway for the projector. You can enter a number from 0 to 255 in each field of the address. However, the following gateway addresses cannot be used.

0.x.x.x, 127.x.x.x, 224.0.0.0 to 255.255.255.255 (where x is a number from 0 to 255)

Mail**Mail Notification**

You can set whether or not (On/Off) to be notified by e-mail.

SMTP Server

You can input the IP Address for the SMTP Server for the projector.

You can enter a number from 0 to 255 in each field of the address. However, the following IP Addresses cannot be used.

0.x.x.x, 127.x.x.x, 224.0.0.0 to 255.255.255.255 (where x is a number from 0 to 255)

Port Number

You can input the Port Number for the SMTP Server. The default value is 25. You can input numbers between 1 to 65535.

Address 1-3 Setting

Input the Email Address and the contents of the Mail to receive notification when an abnormality or warning occurs in the projector. You can enter up to 32 single-byte alphanumeric characters for the e-mail addresses. You can select multiple problems or warnings to be notified about by Mail. You can also change each Email Address.

AMX Device Discovery

When the projector is connected to a network, set this to "On" to allow the projector to be detected by AMX Device Discovery. Set this to "Off" if you are not connected to an environment controlled with a controller from AMX or AMX Device Discovery.

Reset

To reset all of the Network settings, select "Yes".

Soft keyboard operations

The Network menu contains items that require input of alphanumerics during setup. In this case, the following software keyboard is displayed. Use or to move the cursor to the desired key, and then press to enter the alphanumeric. After inputting, press [Finish] on the keyboard to confirm your input. Press [Cancel] on the keyboard to cancel your input.



Each time the [CAPS] key is selected, it sets and changes between upper case and lower case letters.

Each time the [SYM1/2] key is selected, it sets and changes the symbol keys for the section enclosed by the frame.

"Reset" menu

Reset All

This resets all configuration menu settings to their default settings. The "Component" and "Language" settings in the "Settings" menu and the "Memory" settings are not reset when the "Reset All" command is used.

Settings for the "Network" menu are not reset when the "Reset All" command is used. (EH-R4000 only)

Reset Memory

This resets (erases) all settings that have been made using the "Save Memory".

Reset Lens Position

This resets (erases) all settings that have been made using the "Save Lens Position".

Reset Lamp Hours

Clear the cumulative lamp operating time and reset to "0H". Perform this procedure when you replace the lamp.

HDMI-CEC compatible audio-video devices connected to the HDMI ports of the projector can be controlled from one remote control; such as turning on the projector and the devices at one time, or adjusting the volume of the amplifier using the projector's remote control. Even if the amplifier does not conform to the HDMI-CEC standard, the remote operations can be carried out as long as the connected device conforms to the HDMI-CEC standard.

Connection example

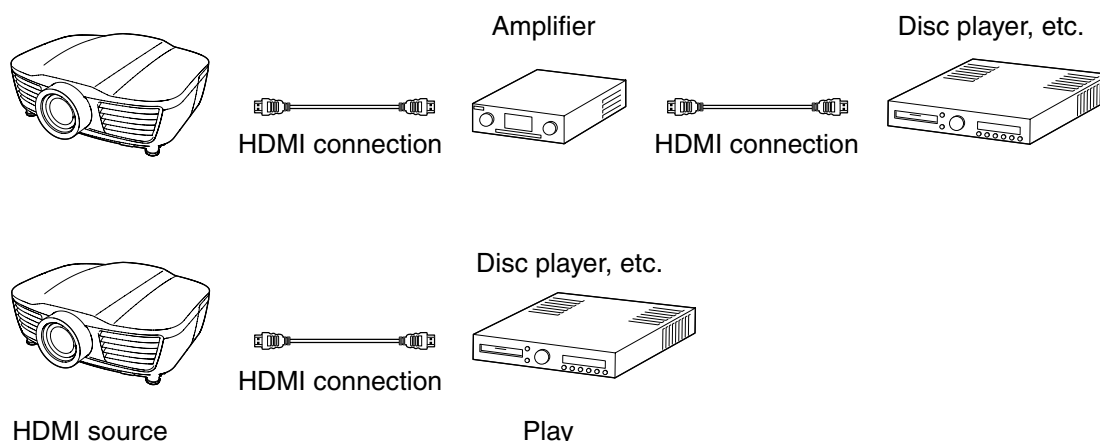

Setting the HDMI link

Press  on the remote control to select "HDMI Link". Setting it to "On" offers the following functions.



- Power On Link (Device -> PJ)
- Power Off Link (PJ -> Device)
- Control of connected devices (Play, stop, fast forward, rewind, forward chapter search, reverse chapter search, pause)
- Power On Link (PJ -> Device)
- AV amplifier volume adjustment

You need to set up the connected devices so that the HDMI link can be used. For details, refer to the documentation provided with the devices.

■ Power On Link (Device -> PJ)

When audio and video playback is started by the connected device, the projector is turned on.

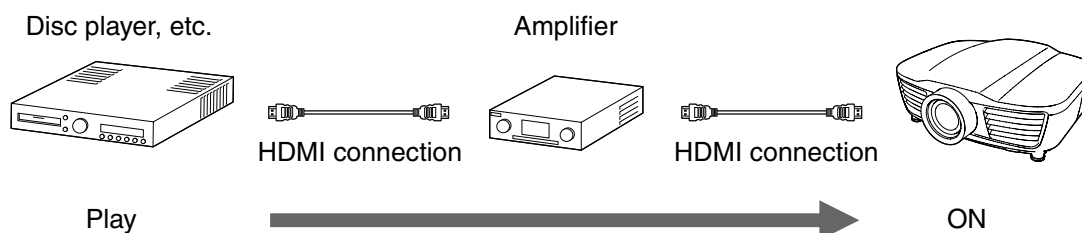

Power On Link (PJ -> Device)

When the projector is turned on, the connected devices are also turned on.

If you have connected multiple devices other than an amplifier, the power for the last-used device is turned on.

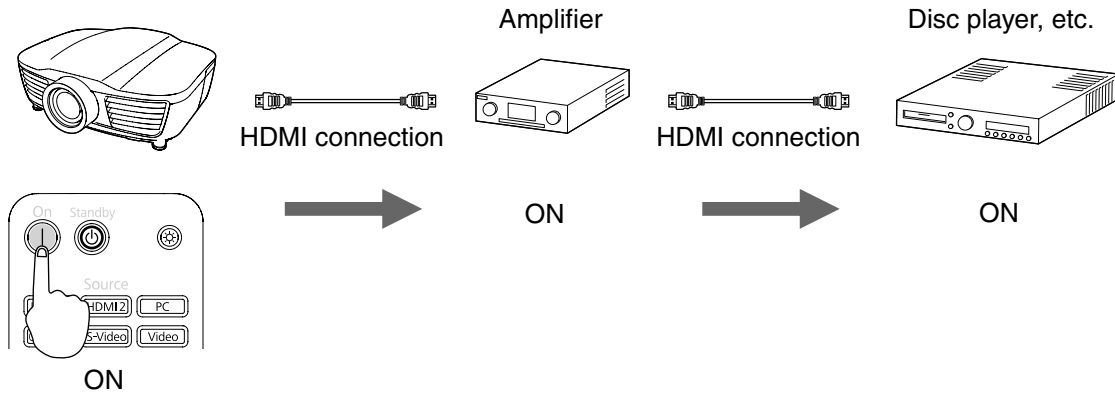

Power Off Link (PJ -> Device)

When the projector is turned off, the connected devices are also turned off.

- The CEC power link function of the connected devices must be enabled.
- Turning off the devices may not be possible depending on their status, such as during recording.

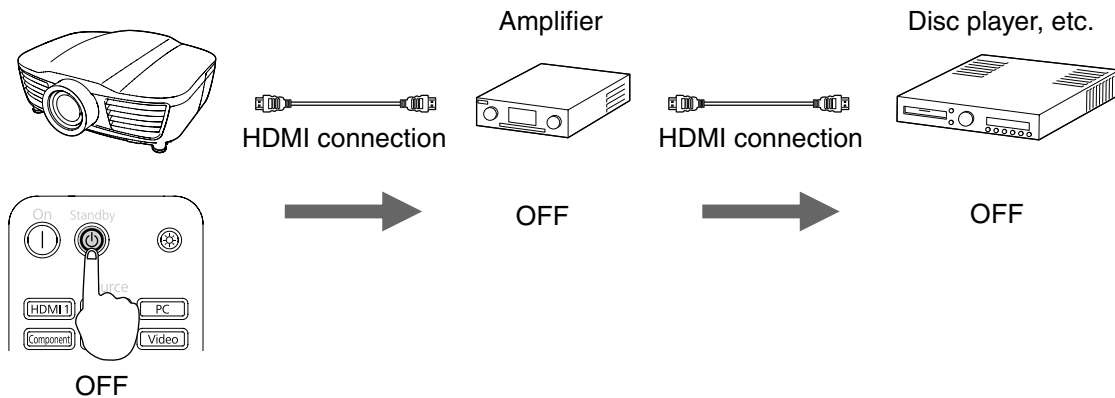

Signal input link

When audio and video playback is started by the connected device, the input source is switched to the HDMI source.

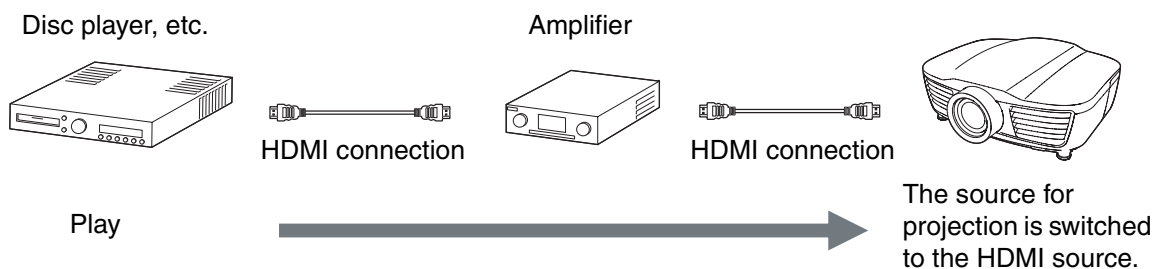

■ AV amplifier volume adjustment / Control of connected devices

You can adjust the volume of the amplifier, mute audio, or perform other operations using the keys.

If you have connected multiple amplifiers or devices, a device first recognized is operated. To control another device, select the target device from the list of connected devices.

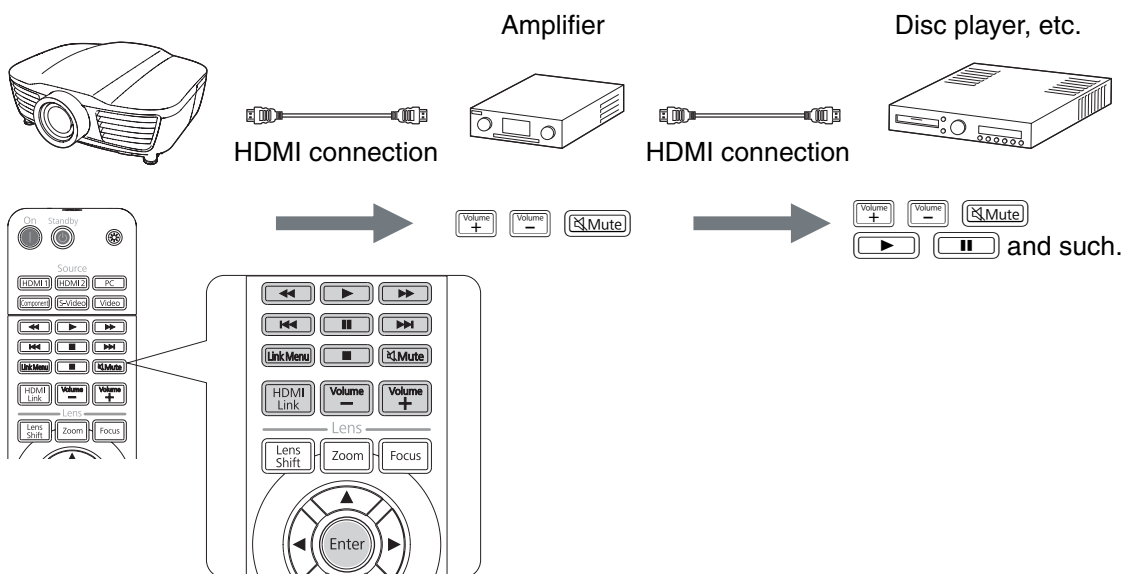

List of connected devices

1 Press on the remote control to select "Device Connections".

A list of devices connected to the HDMI source will be displayed.

Up to 10 devices can be displayed in the list.

Type: The device type (Player, Recorder, AV System, or Tuner) will be displayed.

The green light () to the left of the device type indicates the currently selected device.

Name: Product name such as the model number of HDMI-CEC compatible devices will be displayed. Nothing will be displayed when any product name cannot be obtained from the device.

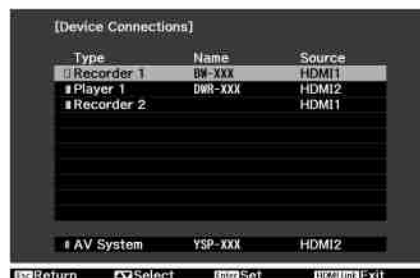

2 Once the target device is selected, the following operations become possible.

- Turning on the device when it is in standby mode.
- Switching the input source to HDMI 1 or HDMI2 where the device is connected, and projecting the images.
- Operating the link menu of the device or starting playback on the device.



- You need to use HDMI compatible cables.
- Some HDMI-CEC compatible devices may not be operated at all, or some of their functions may not work. Refer to the documentation provided with the devices.
 Device documentation

Changing Settings Using a Web Browser (Web Control)

You can set up and control the projector from a computer by using the Web browser of a computer that is connected to the projector via a network. Setup and control operations can be performed remotely if this function is used. In addition, since you can use the computer's keyboard, entering characters required for the setup is easier.

Use Microsoft Internet Explorer 6.0 or later as the Web browser. If using a Macintosh, you can also use Safari. If, however, you are using Safari under Mac OS X 10.2.8, some of the Web control radio buttons may not display properly.



TIP

You can make settings or control the projector from a Web browser even while the projector is in standby mode by setting "Standby Mode" in the "Settings" menu of the projector to "Communication On".

Connecting a LAN Cable

Connect with a commercially available 100BASE-TX or 10BASE-T LAN cable. To prevent malfunctions, use a category 5 shielded LAN cable.

Displaying Web Control

Use the following procedure to display Web Control.



TIP

If your Web browser is set up to connect via a proxy server, Web Control cannot be displayed. To use Web Control, you need to make network connection settings with a device other than a proxyserver.

Entering the IP address of the projector

Web Control can be opened by specifying the IP address of the projector as follows.

- 1 Start the Web browser on the computer.**
- 2 Enter the IP address of the projector in the address input box of the Web browser, and press the [Enter] key on the computer's keyboard.**

Web Control is displayed.

When "Web Control Password" is set in the "Network" menu from the projector's Configuration Menu, enter the password. Enter the character set for the "Web Control Password" as the password.  p.45

Projector Setup

You can set items that are usually set in the projector's Configuration Menu. The contents set are reflected in the Configuration Menu. There are also items that can only be set in the Web browser.

Items in the Configuration menu that cannot be set by the Web browser

All items in the Configuration Menu can be set with the exception of the following items.

- "Signal" - "Zoom Size"
- "Signal" - "Zoom Caption Pos."
- "Settings" - "Operation" - "High Altitude Mode"
- "Settings" - "Display" - "Menu Position"
- "Settings" - "Display" - "Menu Color"
- "Settings" - "Display" - "Standby Confirmation"
- "Settings" - "Display" - "Model Name"
- "Settings" - "Language"
- "Reset" - "Reset All", "Reset Lamp Hours"

The items available on each menu are the same as the Configuration Menu of the projector.

 p.30

Using the Mail Notification Function to Report Problems



By setting the Mail Notification function from the projector's Configuration Menu, notification messages will be sent to the preset email addresses when a problem or warning occurs with a projector. This will enable the operator to be notified of problems with projectors even at locations away from the projectors.  p.30



TIP

- Up to a maximum of three notification destinations (Addresses) can be recorded, and notification messages can be sent to all three destinations at once.
- If a projector develops a critical problem and suddenly stops working, it may not be able to send a message notifying an operator of the problem.
- Monitoring is possible if "Communication On" is set from the "Settings" menu of the projector's Configuration Menu, even if the projector is in "Standby Mode".

Reading the indicators





The projector indicates its status using the indicators.  and operation indicator light and flash, and  lights and flashes red according to the current status.

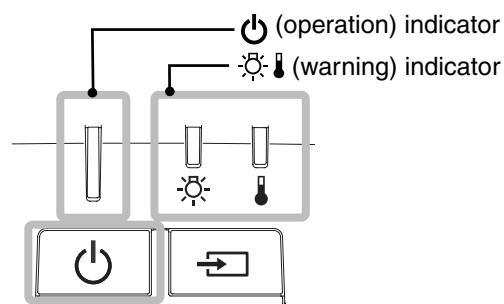





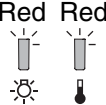

The following tables show what the indicators mean and how to remedy the problems that they indicate.

* If all indicators are switched off, check that the power cable is connected correctly and that the main power switch is on.

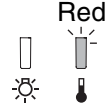
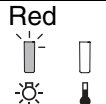

When the (warning) indicator is lit or flashing **warning/problem**

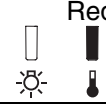
 : Lit  /  : Flashing  : Off

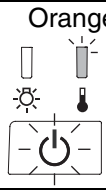
	<p>Internal problem Auto iris problem/ Cinema filter problem</p>	<p>Attention Disconnect the power cable from the electrical outlet. Then contact your local dealer or the nearest address provided in the <i>Support and Service Guide</i>.  <i>Epson Projector Contact List</i></p>
	<p>Fan problem / Sensor problem</p>	
	<p>Lamp problem / Lamp on error Check if the lamp is broken.  p.69 Clean the air filter.  p.65</p>	
<p>If the lamp is not broken</p>	<p>Replace the lamp and then turn the power on.</p>	<p>If the problem is still not solved after the lamp is replaced, stop using the projector and disconnect the power cable from the electrical outlet. Then contact your local dealer or the nearest address provided in the <i>Support and Service Guide</i>.  <i>Epson Projector Contact List</i></p>
<p>If the lamp is broken</p>	<p>Contact your local dealer or the nearest address provided in the <i>Epson Projector Contact List</i>.</p>	
<p>When using above an altitude of about 1500 m, make sure you set the "High Altitude Mode" to "On".  p.43</p>		
	<p>High internal temperature (overheating) The lamp will switch off automatically and projection will stop. Wait for approximately 5 minutes. When the cooling fan stops, turn off the main power switch at the rear of the projector.</p>	<ul style="list-style-type: none"> • If the projector is installed against a wall, leave a space of 20 cm or more between it and the wall. • Clean the air filters if they are blocked.  p.65
	<p>High-speed cooling in progress You can continue using the projector, but if the temperature rises again, it will switch off automatically.</p>	

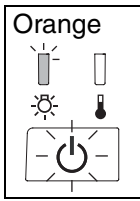

Lamp replacement warning

It is time to replace the lamp. Replace the lamp with a new one as soon as possible.  p.70
If you continue to use the projector without replacing the lamp, the lamp may blowout.

Indicator statuses in normal operation

During normal operation, the  indicator is off.

 /  : Lit  /  : Flashing

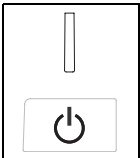

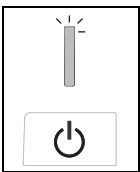

Standby condition If you press , projection will start after a brief interval.



Warm-up in progress

Warm-up time is approximately 50 seconds.

While the projector is warming up, you cannot press  on the remote control or  on the projector's control panel to switch the projector to standby mode.

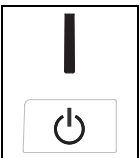

Projection in progress

Normal operation is in progress.

The indicator is off when the illumination function is set to "Off".

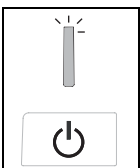

Cool-down  in progress (Approx. 16 seconds)

Remote control and control panel are disabled while cool-down is in progress. Once cool-down is complete, the projector turns to stand-by mode. If the main power switch at the rear of the projector is turned off while cool-down is still in progress, wait until the lamp has cooled down sufficiently (approximately 10 minutes is required), and then turn the main power switch back on.

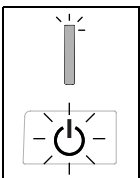











Preparing for network monitoring (EH-R4000 only)

None of the buttons can be operated while this is flashing.

When the indicators provide no help

If any of the following problems occur and the indicators do not offer a solution, refer to the pages given for each problem.

Problems relating to images

- **No images appear**  **p.57**
Projection does not start, the projection area is completely black, the projection area is completely blue, etc.
- **Moving images are not displayed**  **p.57**
Moving images played on computer are not displayed.
- **The message "Not Supported" is displayed**  **p.58**
- **The message "No Signal" is displayed**  **p.58**
- **Images are fuzzy or out of focus**  **p.59**
- **Interference or distortion appear in images**  **p.59**
- **Image is truncated (large) or small**  **p.60**
Only part of the image is displayed.
- **Image colors are not right**  **p.60**
The whole image appears purplish or greenish, images are black & white, colors appear dull, etc.
(Computer monitors and LCD screens have different color reproduction performance, so that the colors projected by the projector and the colors appearing on the monitor may not necessarily match, but this is not a sign of a problem.)
- **Images appear dark**  **p.61**
- **Projection stops automatically**  **p.61**

Problems when projection starts

- **Power does not turn on**  **p.61**

Problems with the remote control

- **The remote control does not work**  **p.62**

Other problems

- **I want to change the language for messages and menus**  **p.62**

Network problems (EH-R4000 only)











- **Mail is not received even if a problem occurs in the projector**  **p.62**

HDMI link problems

- **Operations cannot be carried out using the HDMI link**  **p.63**
- **Device name does not appear in the list of connected devices**  **p.63**

Problems relating to images

■ No images appear

Have you pressed the [Power] button?	Press  on the remote control or  on the projector's control panel.
Is the main power switch turned off?	Turn on the main power switch at the rear of the projector.
Are all of the indicators switched off?	Disconnect the power cable and then reconnect it.  p.14 Check the circuit breaker to see if power is being supplied.
Is blank mode active?	Press  on the remote control to cancel the blank function.
Is a video signal being input?	Check that the power for the connected equipment is turned on. If the "Messages" menu command has been set to "On", messages relating to the image signals will be displayed.  "Settings" - "Display" - "Messages" p.43
Are the image signal format settings correct?	If a <u>composite video</u>  or <u>S-Video</u>  signal is being input If projection does not occur when the "Video Signal" menu command is set to "Auto", select the signal format that matches the signal source.  "Settings" - "Input Signal" - "Video Signal" p.43 If the signal source is connected to the [Component] input port If projection does not occur when the "Component" in the "Input Signal" menu command is set to "Auto", set the signal format that matches the signal that is being projected from the connected equipment.  "Settings" - "Input Signal" - "Component" p.44
Have the configuration menu settings been made correctly?	Try resetting all of the current settings.  p.47
Were the projector and computer connected while their power was already turned on? <div data-bbox="236 1395 552 1469" style="background-color: black; color: white; padding: 5px; margin-top: 10px;">When a computer is connected</div>	If the connection is made while the power is already turned on, the function [Fn] key that switches the computer's video signal to external output may not work. Turn the power for the computer that is connected to the projector off and then back on again.

■ Moving images are not displayed

Is the computer image signal set to output simultaneously both externally and to the LCD monitor? <div data-bbox="204 1742 592 1881" style="background-color: black; color: white; padding: 5px; margin-top: 10px;">Only when projecting images from a laptop computer or computer with a built-in LCD screen</div>	When attempting to display images simultaneously on an external monitor and an LCD monitor, moving images may not be displayed due to specifications of the computer. Set the image signal to output only externally.  Computer documentation, under a title such as "External output" or "Connecting an external monitor"
---	--

■ The message "Not Supported" is displayed

<p>Are the image signal format settings correct?</p>	<p>If a <u>composite video</u> or <u>S-Video</u> is being input If projection does not occur when the "Video Signal" menu command is set to "Auto", select the signal format that matches the signal source. ☞ "Settings" - "Input Signal" - "Video Signal" p.43</p> <hr/> <p>If the signal source is connected to the [Component] input port If projection does not occur when the "Component" in the "Input Signal" menu command is set to "Auto", set the signal format that matches the signal that is being projected from the connected equipment. ☞ "Settings" - "Input Signal" - "Component" p.44</p>
<p>Does the mode match the frequency and resolution of the image signals?</p> <p>Only when projecting computer images</p>	<p>Use the "Resolution" menu command to check the signals being input, and check the "List of Supported Monitor Displays" to make sure that the signals are compatible. ☞ "Info" - "Resolution" p.34, p.37 ☞ "List of Supported Monitor Displays" p.74</p>

■ The message "No Signal" is displayed

<p>Are the cables connected correctly?</p>	<p>Check that all of the cables required for projection are securely connected. ☞ p.12</p>
<p>Has the correct video input port been selected?</p>	<p>Press HDMI 1, HDMI 2, Component, PC, S-Video or Video on the remote control or  on the projector's control panel to change the image source. ☞ p.15</p>
<p>Is the power for the connected equipment turned on?</p>	<p>Turn the power on for the devices.</p>
<p>Are the image signals being output to the projector?</p> <p>Only when projecting images from a laptop computer or computer with a built-in LCD screen</p>	<p>If the image signals are only being output to the computer's LCD monitor, you need to change the output. For some computer models, when the image signals are output externally, they no longer appear on the LCD monitor. ☞ Computer documentation, under a title such as "External output" or "Connecting an external monitor"</p> <hr/> <p>If the connection is made while the power is already turned on, the function [Fn] key that switches the computer's video signal to external output may not work. Turn the power for the projector and the computer off and then back on again. ☞ p.14</p>



■ Images are fuzzy or out of focus

Has the focus been adjusted correctly?	Adjust the focus. 📖 p.16
Is the lens cover still attached?	Remove the lens cover.
Is the projector at the correct distance?	The recommended distance from the projector to the screen is within 83 to 1210 cm for a screen size of 16:9, and 102 to 1482 cm for a screen size of 4:3. Set up the projector so that the projection distance is within this range. 📖 p.10
Has condensation formed on the lens?	If the projector is suddenly taken from a cold environment to a warm environment or if sudden ambient temperature changes occur, condensation may form on the surface of the lens, and this may cause the images to appear fuzzy. Set the projector up in the room approximately one hour before it is to be used. If condensation forms on the lens, turn the power off and wait for the condensation to disappear.

■ Interference or distortion appear in images

Are the image signal format settings correct?	<p>If a <u>composite video</u> or <u>S-Video</u> is being input If projection does not occur when the "Video Signal" menu command is set to "Auto", select the signal format that matches the signal source. 📖 "Settings" - "Input Signal" - "Video Signal" p.43</p> <p>If the signal source is connected to the [Component] input port If projection does not occur when the "Component" in the "Input Signal" menu command is set to "Auto", set the signal format that matches the signal that is being projected from the connected equipment. 📖 "Settings" - "Input Signal" - "Component" p.44</p>
Are the cables connected correctly?	Check that all of the cables required for projection are securely connected. 📖 p.12
Is an extension cable being used?	If an extension cable is used, interference may increase. Try connecting a signal amplifier.
Have the "Sync." and "Tracking" settings been adjusted correctly? <div style="background-color: black; color: white; padding: 5px; text-align: center; margin-top: 10px;"> Only when projecting computer images </div>	The projector has an automatic adjustment function that causes the optimum images to be projected. However, for some types of signal, the correct adjustments may not be obtained even after automatic adjustment is carried out. In such cases, use the "Tracking" and "Sync." menu commands to make the adjustments. 📖 "Signal" - "Tracking", "Sync." p.40
Has the correct resolution been selected? <div style="background-color: black; color: white; padding: 5px; text-align: center; margin-top: 10px;"> Only when projecting computer images </div>	Set the computer so that the signals that are output are compatible with this projector. 📖 "List of Supported Monitor Displays" p.74 Computer documentation

■ Image is truncated (large) or small

<p>Has the correct <u>aspect</u> been selected?</p>	<p>Press <input type="button" value="Aspect"/> to select the aspect that corresponds to the input signal. ☞ p.19 If images with subtitles are being projected using "Zoom", use the "Zoom Caption Pos." menu command to adjust the images. ☞ "Signal" - "Zoom Caption Pos." p.40</p>
<p>Has the "Position" setting been adjusted correctly?</p>	<p>Use the "Position" the menu command to make the adjustment. ☞ "Signal" - "Position" p.40</p>
<p>Has the computer been set for dual display?</p> <p style="background-color: black; color: white; padding: 5px; text-align: center;">Only when projecting computer images</p>	<p>If the dual display setting has been activated by the connected computer, only half of the images on the computer screen is displayed by the projector. To display the whole of the image on the computer screen, turn off the dual display setting. ☞ Computer video driver documentation</p>
<p>Has the correct resolution been selected?</p> <p style="background-color: black; color: white; padding: 5px; text-align: center;">Only when projecting computer images</p>	<p>Set the computer so that the signals that are output are compatible with this projector. ☞ "List of Supported Monitor Displays" p.74 Computer documentation</p>



■ Image colors are not right

<p>Are the image signal format settings correct?</p>	<p>If a <u>composite video</u> or <u>S-Video</u> is being input If projection does not occur when the "Video Signal" menu command is set to "Auto", select the signal format that matches the signal source. ☞ "Settings" - "Input Signal" - "Video Signal" p.43</p>
	<p>If the signal source is connected to the [Component] input port If projection does not occur when the "Component" in the "Input Signal" menu command is set to "Auto", set the signal format that matches the signal that is being projected from the connected equipment. ☞ "Settings" - "Input Signal" - "Component" p.44</p>
<p>Are the cables connected correctly?</p>	<p>Check that all of the cables required for projection are securely connected. ☞ p.12</p>
<p>Has the image <u>contrast</u> been adjusted correctly?</p>	<p>Use the "Contrast" menu command to adjust the color. ☞ "Image" - "Contrast" p.38</p>
<p>Has color been adjusted appropriately?</p>	<p>Use the "Advanced" menu command to adjust the color. ☞ "Image" - "Advanced" p.38</p>
<p>Have the color intensity and tint been adjusted correctly?</p> <p style="background-color: black; color: white; padding: 5px; text-align: center;">Only when projecting images from a video source</p>	<p>Use the "Color Saturation" and "Tint" menu commands to adjust the color and tint. ☞ "Image" - "Color Saturation", "Tint" p.38</p>

■ Images appear dark





Has the image brightness been adjusted correctly?	Use the "Brightness" menu commands to make the adjustments. ☞ "Image" - "Brightness" p.38
Has the image contrast been adjusted correctly?	Use the "Contrast" menu command to adjust the color. ☞ "Image" - "Contrast" p.38
Is the lamp due for replacement?	When the lamp is nearly due for replacement, the images will become darker and the color quality will become poorer. When this happens, the lamp should be replaced with a new one. ☞ p.69
Has the lens iris been adjusted correctly?	Adjust the "Lens Iris" setting. ☞ p.25

■ Projection stops automatically

Is sleep mode active?	When "Sleep Mode" has been set to On, the lamp turns off automatically if no signal is input for about 30 minutes, and the projector switches to standby mode. Press the  on the remote control or the  on the projector's control panel to turn the projector's power back on. To cancel the sleep mode setting, change "Sleep Mode" menu command to "Off". ☞ "Settings" - "Operation" - "Sleep Mode" p.42
------------------------------	--

Problems when projection starts

■ Power does not turn on

Have you pressed the [Power] button?	Press  on the remote control or  on the projector's control panel.
Is "Child Lock" set to "On"?	If the "Child Lock" menu command is set to "On", press  on the projector's control panel for about 3 seconds or press  on the remote control to turn the power on. ☞ "Settings" - "Operation" - "Child Lock" p.42
Are all of the indicators switched off?	Disconnect the power cable and then reconnect it. ☞ p.14 Check the circuit breaker to see if power is being supplied.
Do the indicators turn off and on when the power cable is touched?	Turn the power off, disconnect the power cable and then reconnect it. If this does not solve the problem, there may be a problem with the power cable. Then contact your local dealer or the nearest address provided in the <i>Support and Service Guide</i> . ☞ <i>Epson Projector Contact List</i>

Problems with the remote control

■ The remote control does not work

Is the remote control light-emitting area facing towards the remote control light-receiving area when it is operated?	Face the remote control towards the remote control light-receiving area. Operating range ↗ p.13
Is the remote control too far from the projector?	The operating range for the remote control is approximately 10m. ↗ p.13
Is direct sunlight or strong light from fluorescent lamps shining onto the remote control light-receiving area?	Set the projector up in a location where strong light will not shine onto the remote control light-receiving area.
Are the batteries dead, or have the batteries been inserted correctly?	Insert new batteries, while making sure that they face correctly. ↗ p.13

Other problems

■ I want to change the language for messages and menus

Change the Language setting.	Adjust the "Language" setting from the configuration menu. ↗ "Settings" - "Language" p.44
-------------------------------------	--

Network problems (EH-R4000 only)

■ Mail is not received even if a problem occurs in the projector

Is the network connect setting correct?	Check the projector's network settings. ↗ p.45
Is "Standby Mode" set to "Communication On"?	To use the Mail Notification function when the projector is in standby, set "Communication On" in "Standby Mode" from the Configuration Menu. ↗ "Extended" - "Standby Mode" p.42
Did a fatal abnormality occur and the projector come to a sudden stop?	When the projector comes to a sudden stop, e-mail cannot be sent. If, after checking the projector, the abnormal state continues, contact your local dealer or the nearest address provided in the <i>Support and Service Guide</i> . ↗ <i>Epson Projector Contact List</i>
Is power being supplied to the projector?	Check that there has not been a local power failure or that the circuit breaker for the electrical outlet of the projector has not been tripped.
Is Mail Notification function set correctly in the Configuration Menu?	Mail notification of problems is sent according to the "Mail" settings in the Configuration Menu. Check if it is set correctly. ↗ "Network" - "Mail" p.46
Is the network cable connected correctly?	Check that the network cable is connected correctly. Reconnect it if it is not connected or not connected properly.



HDMI link problems

■ Operations cannot be carried out using the HDMI link

Are HDMI compatible cables being used?	You need to use HDMI compatible cables.
Are the connected devices HDMI- CEC compatible?	An HDMI- CEC non-compatible device cannot be operated even if it has an HDMI port. Refer to the documentation provided with the device. ↗ Device documentation
Are the cables connected correctly?	Check that all of the cables required for the HDMI link operation are securely corrected.
Is the power for the connected amplifier, DVD player or other device turned on?	Check that the connected devices are turned on and being in standby mode. Refer to the documentation provided with the devices. ↗ Device documentation
Have the devices been newly connected, or have connections been changed?	If operations cannot be carried out after a new device was connected or the connections were changed, it may be necessary to reset the CEC functions of the connected device or restart the device. ↗ Device documentation

■ Device name does not appear in the list of connected devices

Are the connected devices HDMI- CEC compatible?	The device name will not appear if the connected device does not conform to the HDMI CEC standard. Refer to the documentation provided with the device. ↗ Device documentation
--	--

Reading Problem Mail Notification Function

When the Mail Notification function is set to On and a problem/warning occurs in the projector, the following e-mail will be sent.

Subject: EPSON Projector

Line 1: The Projector Name where the problem has occurred

Line 2: The IP Address set for the projector where the problem has occurred

Line 3 and on: Details of the problem

The details of the problem are listed line by line. The following table shows the details that are given in the message for each item. To deal with problems/warnings, see "Reading the Indicators".

 p.54

Message	Cause
No-signal	No Signal No Signal is input to the projector. Check the connection status or check that the power for the signal source is turned on.
Internal error	Internal Error
Fan related error	Fan Error
Sensor error	Sensor Error
Auto Iris Error	Auto Iris Error
Cinema Filter Error	Cinema Filter Error
Power Err. (Ballast)	Power Err. (Ballast)
Lamp timer failure	Lamp Failure
Lamp out	Lamp Error
Lamp replacement notification	Replace Lamp
High Temp Warning	High Temp Warning
Lens Iris Warning	Lens Iris Warning
Cinema Filter Warn	Cinema Filter Warn.

A (+) or (-) appears at the start of the message.

(+): A projector problem has occurred

(-) : A projector problem has been dealt with

This section describes maintenance tasks such as cleaning the projector and replacing consumable parts.

Cleaning

You should clean the projector if it becomes dirty or if the quality of projected images starts to deteriorate.

Warning Do not use sprays containing a flammable gas to remove dirt or dust which is adhering to parts such as the lens or filter of the projector. Because the lamp inside the projector becomes very hot during use, the gases may ignite and result in a fire.

Cleaning the air filter

If the air filter becomes blocked with dust and the message "The projector is overheating. Make sure nothing is blocking the air vent, and clean or replace the air filter." is displayed, clean the air filter.

- Attention**
- If the air filter becomes clogged with dust, it can result in overheating which may cause operating problems or reduce the operating life of the optical parts. It is recommended that you clean the air filter about once every three month. If using the projector in a dusty location, the air filter should be cleaned more often.
 - The air filter is not washable. Also do not use detergent or solvents.
 - When using a brush for cleaning, use a soft brush with long bristles and brush the filter gently. If you brush too strong, dust may be pushed inside the air filter and hardly be removed.

1 Press the filter cover opening switch to remove the air filter cover.

The filter cover is on a string attached to the projector, so that it does not drop when you replace the air filter of the projector suspended from a ceiling.

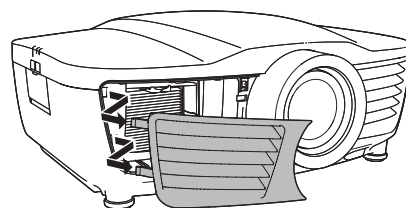
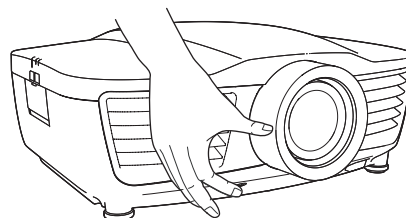

2 Hold the tab of the air filter and remove the air filter.

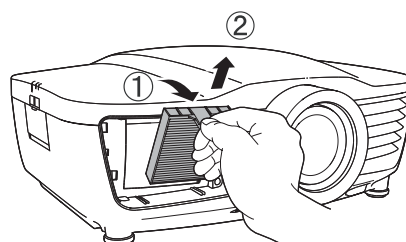

3 Tap the air filter four or five times with the surface facing downwards to shake off the dust.

Hold the filter at the other side and tap it again to shake off the dust.

Attention

- Do not hit the air filter hard, otherwise it may become bent or broken and can no longer be used.
- Be careful not to damage the tab of the air filter when shaking off the dust.

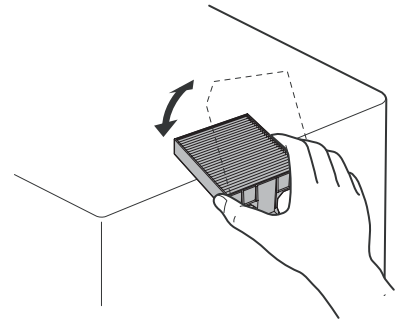

4 Use a vacuum cleaner to remove any remaining dust from the surface of the air filter.

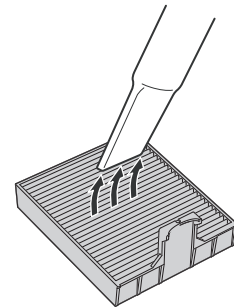

5 Install the air filter.

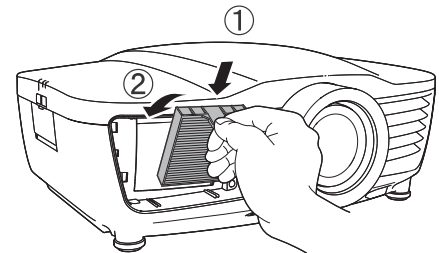

6 Install the air filter cover.

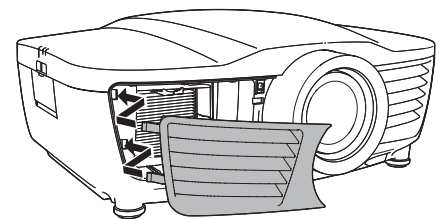

Cleaning the projector case

Clean the projector case by wiping it gently with a soft cloth.

If the projector is particularly dirty, moisten the cloth with water containing a small amount of neutral detergent, and then firmly wring the cloth dry before using it to wipe the projector case. Then wipe the case again with a soft, dry cloth.

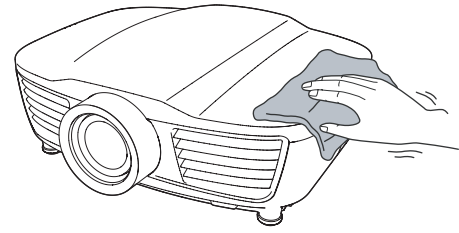
**Attention**

Do not use volatile substances such as wax, alcohol or thinner to clean the projector case. These can cause the case to warp and make the coating finish peel off.

Cleaning the lens

To clean the lens it is preferable to use an air blower purchased for the purpose. But alternatively you can wipe it gently clean with a spectacle-cleaning cloth.

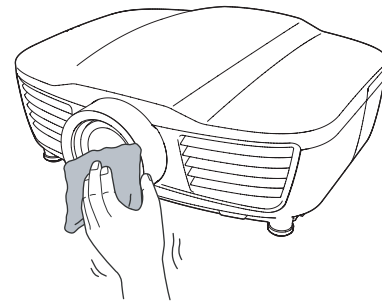
**Attention**

Do not rub the lens with harsh materials or subject the lens to shocks, as it can easily become damaged.

Consumable replacement periods

Air filter replacement period

- If the air filter has been broken or the "Replace" message is displayed even though the air filter has been cleaned.

Replace with an optional air filter.

 Replacing the air filter p.69

Lamp replacement period

- The message "Replace the lamp." appears on the screen when projection starts.

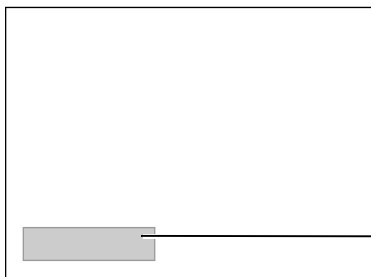

A message will be displayed.

- The projected images get darker or start to deteriorate.



TIP

- The replacement warning message is set to appear after a minimum of about 3900 hours of lamp use in order to maintain the initial brightness and quality of the projected images. The time taken for the message to appear will vary depending on usage conditions such as Color Mode settings. If you continue to use the lamp after this period, the possibility of the lamp breaking becomes greater. When the lamp replacement message appears, replace the lamp with a new one as soon as possible, even if it is still working.
- Depending on the characteristics of the lamp and on the way it has been used, the lamp may become darker or stop working before the lamp warning message appears. You should always have a spare lamp ready in case it is needed.
- Contact your local dealer or the nearest address provided in the Epson Projector Contact List.

Replacing consumables



Replacing the air filter

Caution Do not touch the lamp cover soon after power-off or you may get burned because it is very hot.



Dispose of used air filters properly in accordance with your local regulations.
Frame material: PP
Filter materials: PP, PET

TIP

1 Press **Standby**  or  to turn off the power, and then turn the main power switch OFF.

2 Press the filter cover opening switch.

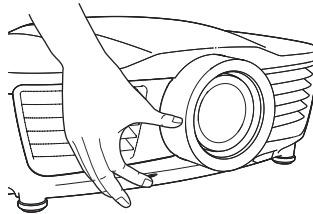

3 Remove the air filter cover.

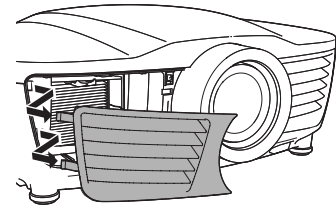

4 Remove the old air filter.

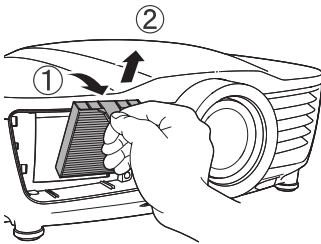

5 Insert the new air filter.

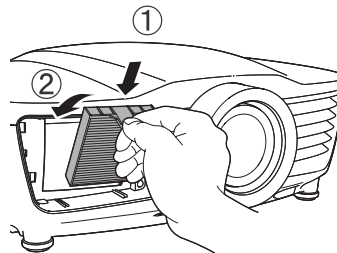

6 Install the air filter cover.

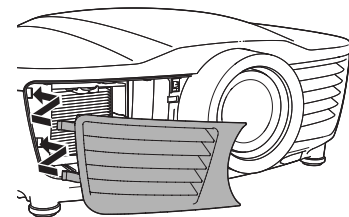

Replacing the lamp



Warning

If the lamp stops working and needs to be replaced, there is the danger that the lamp may already be broken.

If replacing the lamp of a projector which has been installed to the ceiling, you should always assume that the lamp is broken and handle it with extreme care during removal. Furthermore, you should stand to the side of the projector, not underneath it.

Caution

Wait until the lamp has cooled down sufficiently before removing the lamp cover. If the lamp is very hot, you may get burned.

- 1** Press  or  to turn off the power, and then turn the main power switch OFF.

* Wait until the lamp cools down (takes approximately 1 hour).

- 2** Loosen the lamp cover fixing screw.

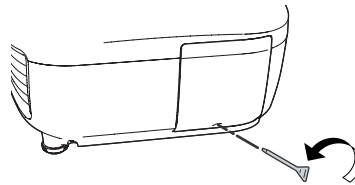

- 3** Remove the lamp cover.

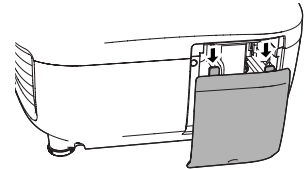

- 4** Loosen the lamp fixing screws.

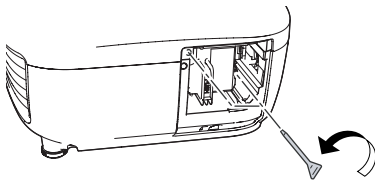

- 5** Remove the old lamp.

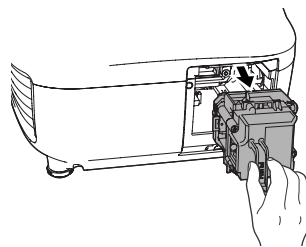

Pull out straight.

- 6** Insert the new lamp.

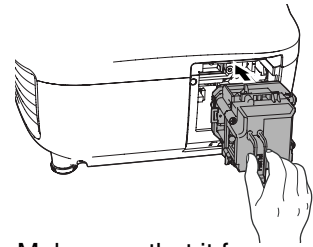

Make sure that it faces the correct way.

- 7** Securely tighten the lamp fixing screws.

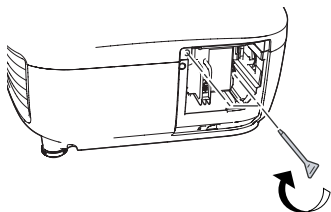

- 8** Install the lamp cover.

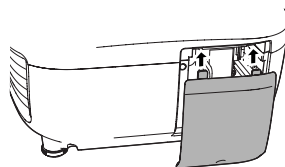

- 9** Tighten the lamp cover fixing screw.

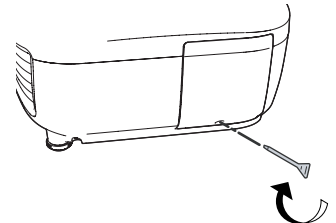

Resetting the lamp operating time

The lamp operating time must always be reset after the lamp has been replaced with a new one. The projector has a built-in counter which keeps track of the lamp operating time. When the cumulative operating time reaches a certain point, it causes the replacement warning message to be displayed.

1 Press  to turn on the power.

2 Press  to display the configuration menu.

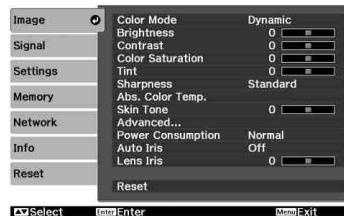

3 Select "Reset Lamp Hours" from the "Reset" menu.

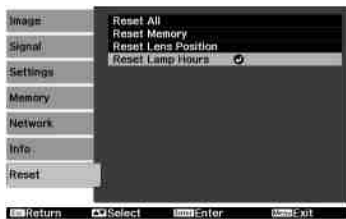

4 Select "Yes" and then press .



 **Warning** Never disassemble or modify the lamp.

Attention

- Install the lamp and the lamp cover securely. The projector will not turn on if the lamp or the lamp cover is not installed correctly.
- This product includes a lamp component that contains mercury (Hg). Please consult your local regulations regarding disposal or recycling. Do not dispose of it with normal waste.

The following optional accessories/consumables are available for purchase if required. This list of optional accessories/consumables is current as of: 2010.7. Details of accessories are subject to change without notice.

Varies depending on country of purchase.

■ Optional Accessories

50" Portable Screen A compact screen which can be carried easily. (Aspect Ratio▶▶ 4:3)	ELPSC06	Ceiling Pipe 600 (600 mm/white)* Ceiling Pipe 450 (450 mm/white)* Ceiling Pipe 700 (700 mm/white)*	ELPFP07 ELPFP13 ELPFP14
60" Portable Screen 80" Portable Screen 100" Portable Screen A portable roll-type screen. (Aspect 4:3)	ELPSC07 ELPSC08 ELPSC10	Cable Cover (Mat Black) Cable Cover (White)	ELPCC03B (Black) ELPCC03W (White)
VGA-HD15 PC Cable (1.8 m) VGA-HD15 PC Cable (3 m) VGA-HD15 PC Cable (20 m) (For mini D-Sub 15-pin/mini D-Sub 15-pin) Use to connect the projector to a computer.	ELPKC02 ELPKC09 ELPKC10	Ceiling Mount* (with ceiling plate) Use when installing the projector to a ceiling.	ELPMB20 ELPMB22

Use when installing the projector to a high ceiling or a ceiling with veneer panels.

Use to cover cables of the projector that is suspended from a ceiling to improve the appearance.

* A special method of installation is required in order to suspend the projector from the ceiling. Please contact the place of purchase if you would like to use this installation method.

■ Consumables

Lamp Unit (1 spare lamp, 1 spare screwdriver) Use as a replacement for spent lamps.	ELPLP59	Air Filter Set (1 air filter) Use as a replacement for old air filters.	ELPAF28
---	---------	---	---------

Installing and removing the cable cover

When the projector is suspended from a ceiling, you can use the cable cover to improve the appearance.

Installing the cable cover

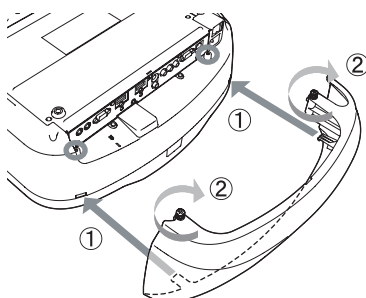

Removing the cable cover

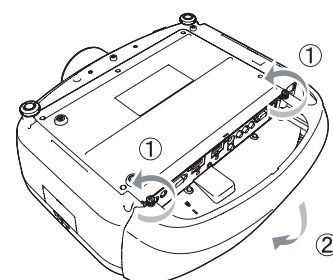

PJLink Class1 was established by the JBMIA (Japan Business Machine and Information System Industries Association) as a standard protocol for controlling network-compatible projector's as part of their efforts to standardize projector control protocols.

The projector complies with the PJLink Class1 standard established by the JBMIA.

It complies with all commands except for the following commands defined by PJLink Class1, and agreement was confirmed by the PJLink standard adaptability verification.

URL:<http://pjlink.jbmia.or.jp/english/>

- Non-compatible commands

Function		PJLink Command
Mute settings	Image muting set	AVMT 11

- Input names defined by PJLink and corresponding projector sources

Source	PJLink Command
PC	INPT 11
Video	INPT 21
S-Video	INPT 22
Component	INPT 24
HDMI1	INPT 32
HDMI2	INPT 33

- Manufacturer name displayed for "Manufacture name information query"

EPSON

- Model name displayed for "Product name information query"

Home Cinema EH-R4000

PowerLite Pro Cinema 61000

Home Cinema EH-R5000C



Component Video

Signal	Refresh rate (Hz)	Resolution (Dots)
<u>SDTV</u> (480i)	60	720×480
SDTV(576i)	50	720×576
SDTV(480p)	60	720×480
SDTV(576p)	50	720×576
<u>HDTV</u> (720p)	50/60	1280×720
HDTV(1080i)	50/60	1920×1080
HDTV(1080p)	50/60	1920×1080

Composite Video/S-Video

Signal	Refresh rate (Hz)	Resolution (Dots)
TV(<u>NTSC</u>)	60	720×480
TV(<u>SECAM</u>)	50	720×576
TV(<u>PAL</u>)	50/60	720×576



Input signal from the [HDMI1] / [HDMI2] input port

Signal	Refresh rate (Hz)	Resolution (Dots)
<u>VGA</u> ▶▶	60	640×480
<u>SDTV</u> ▶▶(480i)	60	720×480
SDTV(576i)	50	720×576
SDTV(480p)	60	720×480
SDTV(576p)	50	720×576
<u>HDTV</u> ▶▶(720p)	50/60	1280×720
HDTV(1080i)	50/60	1920×1080
HDTV(1080p)	24/50/60	1920×1080

Computer image (analog RGB)

Signal	Refresh rate (Hz)	Resolution (Dots)
<u>VGA</u> ▶▶	60/72/75/85	640×480
<u>SVGA</u> ▶▶	56/60/72/75/85	800×600
<u>XGA</u> ▶▶	60/70/75/85	1024×768
<u>SXGA</u> ▶▶	70/75/85	1152×864
	60/75/85	1280×960
	60/75/85	1280×1024
WXGA	60	1280×768
	60	1360×768
	60/75/85	1280×800
MAC13"	67	640×480
MAC16"	75	832×624
MAC19"	59/75	1024×768
MAC21"	75	1152×870

Product name			EH-R4000	EH-R2000
Dimensions			440 (W) × 175 (H) × 370 (D) mm (not including feet and projection lens)	
Panel size			0.74 inch wide	
Display method			Polysilicon TFT active matrix	
Resolution			2,073,600 pixels (1920 (W) × 1080 (H) dots) × 3	
Scanning frequencies	Digital	Pixel clock: 13.5 to 148.5 MHz		
		Horizontal: 15.63 to 67.5 kHz		
		Vertical: 24, 50 to 60 Hz		
	Analogue	Pixel clock: 13.5 to 157.5 MHz		
		Horizontal: 15.63 to 91.15 kHz		
		Vertical: 50 to 85 Hz		
Focus adjustment			Electric	
Zoom adjustment			Electric (Approx. 1 : 2.1)	
Lens shift			Electric (Maximums: Approx. 90% vertically, 40% horizontally)	
Lamp (light source)			UHE lamp, 200 W, Model No.: ELPLP59	
Power supply			100 to 240V AC±10%, 50/60Hz, 2.9 to 1.3A	
Power Consumption	100 to 120V area	Operating	291W (Power Consumption: Normal) 243W (Power Consumption: ECO)	
		Standby	8.8W (Communication On) 0.17W (Communication Off)	0.17W
	220 to 240V area	Operating	280W (Power Consumption: Normal) 235W (Power Consumption: ECO)	
		Standby	9.7W (Communication On) 0.27W (Communication Off)	0.27W
Operating altitude			0 to 2286m	
Operating temperature			+5 to +35°C (No condensation)	
Storage temperature			-10 to +60°C (No condensation)	
Mass			Approx. 10kg	

Ports	Component input	1 RCA pin jack × 3	
	PC input	1 Mini D-sub 15-pin (female) blue	
	HDMI input*	2 HDMI ↔ Compatible with HDCP, CEC signals	
	Video input	1 RCA pin jack	
	S-Video input	1 Mini DIN 4-pin	
	LAN	1 RJ-45	-
	RS-232C	1 D-sub 9-pin (male)	
	Trigger out	2 3.5 mm mini jack	1 3.5 mm mini jack

* You can connect any HDMI or DVI-D compatible equipment. However, depending on the equipment, the projector may not project any image.



Pixelworks DNX™ ICs are used in this Projector.

This product is also designed for IT power distribution system with phase-to-phase voltage 230V.

Product Information

For users in Turkey:

In Conformity with the Turkish EEE Regulation.

Türkiye'deki kullanıcılar için

EEE Yönetmeliğine Uygundur.

■ Angle of tilt

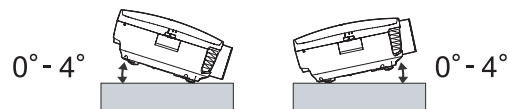

If you set the projector higher than 4 °, it could damage the projector and cause an accident.

■ **RS-232C cable layout**

- Connector shape: D-Sub 9-pin (male)
- Projector input connector: RS-232C

<At the projector> <At the computer>

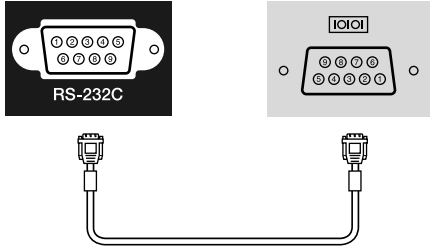

<At the projector> (PC serial cable) <At the computer>

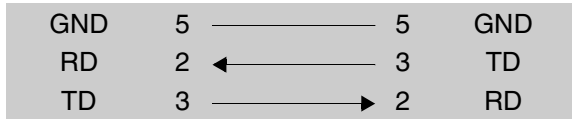

Signal	Function
GND	Signal wire ground
TD	Transmit data
RD	Receive data

■ **Communications protocol**

- Default baud rate setting: 9600 bps
- Data length: 8 bit
- Parity: None
- Stop-bit: 1 bit
- Flow control: None