

User's Guide

Multimedia Projector

EB-1775W

EB-1770W



EB-1760W

EB-1750





Notations Used in This Guide

- **Safety indications**

The documentation and the projector use graphical symbols to show how to use the projector safely. Please understand and respect these caution symbols in order to avoid injury to persons or property.

| | |
|--|--|
|  Warning | This symbol indicates information that, if ignored, could possibly result in personal injury or even death due to incorrect handling. |
|  Caution | This symbol indicates information that, if ignored, could possibly result in personal injury or physical damage due to incorrect handling. |

- **General information indications**

| | |
|---|---|
| Attention | Indicates procedures which may result in damage or injury if sufficient care is not taken. |
|  | Indicates additional information and points which may be useful to know regarding a topic. |
|  | Indicates a page where detailed information regarding a topic can be found. |
|  | Indicates that an explanation of the underlined word or words in front of this symbol appears in the glossary of terms. See the "Glossary" section of the "Appendix".  "Glossary" p.128 |
| [Name] | Indicates the name of the buttons on the remote control or the control panel. Example: [Esc] button |
| Menu Name | Indicates Configuration menu items. Example: Select Brightness from Image . Image - Brightness |

Notations Used in This Guide 2

Introduction

Projector Features 8

| | |
|---|---|
| List of Functions by Model | 8 |
| Quick and Easy Set up, Projection, and Storage | 8 |
| Connecting with a USB cable and projecting (USB Display) | 8 |
| Easy Image Correction | 8 |
| Adjusting the projected image to automatically fit into the screen frame - Screen Fit - (EB-1775W only) | 8 |
| Detecting projector movements and automatically correcting image distortion | 9 |
| Useful Functions for Expanding the Scope of Your Presentations | 9 |
| Increasing projection content in wide (WXGA) screen (EB-1775W/EB-1770W/EB-1760W only) | 9 |
| Connecting to a wireless LAN and projecting images from the computer's screen (EB-1775W/EB-1770W/EB-1760W only) | 9 |
| Connecting a projector and a computer wirelessly with Quick Wireless Connection (EB-1775W/EB-1770W/EB-1760W only) | 9 |
| Making the most of the remote control | 9 |

Part Names and Functions 10

| | |
|--|----|
| Front/Top | 10 |
| Rear | 11 |
| Base | 12 |
| Control Panel | 13 |
| Remote Control | 14 |
| Replacing the remote control batteries | 17 |
| Remote control operating range | 17 |

Preparing the Projector

Installing the Projector 19

| | |
|----------------------|----|
| Installation Methods | 19 |
| Installation methods | 19 |

| | |
|---|----|
| Screen Size and Approximate Projection Distance | 20 |
|---|----|

Connecting Equipment 21

| | |
|--------------------------|----|
| Connecting a Computer | 21 |
| Connecting Image Sources | 22 |
| Connecting USB Devices | 23 |

Basic Usage

Projecting Images 26

| | |
|---|----|
| From Installation to Projection | 26 |
| Automatically Detect Input Signals and Change the Projected Image (Source Search) | 27 |
| Switching to the Target Image by Remote Control | 28 |
| Projecting with USB Display | 28 |
| System Requirements | 28 |
| Connecting for the first time | 29 |
| Uninstalling | 30 |

Adjusting Projected Images 31

| | |
|---|----|
| Automatically Adjust to Fit the Screen Frame - Screen Fit - (EB-1775W only) | 31 |
| Correcting Keystone Distortion | 33 |
| Correcting automatically - Auto H/V-Keystone - (EB-1775W only) | 33 |
| Correcting automatically - Auto V-Keystone - (EB-1770W/EB-1760W/EB-1750 only) | 34 |
| Correcting manually - manual H/V-Keystone - | 34 |
| Correcting manually - Quick Corner - | 34 |
| Adjusting the Image Size | 36 |
| Adjusting the Image Position | 37 |
| Adjusting the Horizontal Tilt | 37 |
| Correcting the Focus | 37 |
| Adjusting the Volume | 38 |
| Selecting the Projection Quality (Selecting Color Mode) | 38 |
| Setting Auto Iris | 39 |
| Changing the Aspect Ratio | 40 |
| Changing methods | 40 |
| Changing the aspect ratio for video equipment images | 40 |



Changing the aspect ratio for computer images 42

Useful Functions

Projection Functions 45

Projecting Without a Computer (Slideshow) 45

 Specifications for files that can be projected using Slideshow 45

 Slideshow examples 45

 Slideshow operating methods 46

 Projecting the selected image 48

 Projecting image files in a folder in sequence (Slideshow) 49

 Playing a scenario 49

 Operating procedures during scenario playback 49

 Image file display settings and Slideshow operation settings 50

Hiding the Image and Sound Temporarily (A/V Mute) 51

Freezing the Image (Freeze) 52

Pointer Function (Pointer) 52

Enlarging Part of the Image (E-Zoom) 53

Using the Remote Control to Operate the Mouse Pointer (Wireless Mouse) 54

Setting the ID and Using the Remote Control 56

 Setting the Projector ID 57

 Setting the remote control ID 57

Correcting Color when Projecting from Multiple Projectors 58

 Summary of correction procedure 58

 Correcting 58

Saving a User's Logo 60

Security Functions 62

Managing Users (Password Protect) 62

 Kinds of Password Protect 62

 Setting Password Protect 62

 Entering the Password 63

Restricting Operation (Control Panel Lock) 64

Anti-Theft Lock 65

Configuration Menu

Using the Configuration Menu 67

List of Functions 68

Configuration Menu Table 68

 Network menu (EB-1775W/EB-1770W/EB-1760W only) 69

Image Menu 70

Signal Menu 71

Settings Menu 73

Extended Menu 74

Network Menu (EB-1775W/EB-1770W/EB-1760W Only) 76

 Notes on operating the Network menu 76

 Soft keyboard operations 77

 Basic menu 78

 Wireless LAN menu 79

 Security menu 80

 Mail menu 82

 Others menu 82

 Reset menu 83

Info Menu (Display Only) 84

Reset Menu 84

Troubleshooting

Using the Help 87

Problem Solving 88

Reading the Indicators 88

When the Indicators Provide No Help 91

Problems Relating to Images 92

 No images appear 92

 Moving images are not displayed (only the moving image portion turns black) 93

 Projection stops automatically 93

 The message "Not supported" is displayed 93

 The message "No Signal" is displayed 93

| | |
|---|----|
| Images are fuzzy, out of focus, or distorted | 94 |
| Interference or distortion appear in images | 95 |
| The image is truncated (large) or small, or the aspect is not suitable | 95 |
| Image colors are not right | 96 |
| Images appear dark | 97 |
| Problems when Projection Starts | 97 |
| The projector does not turn on | 97 |
| Other Problems | 98 |
| No sound can be heard or the sound is faint | 98 |
| The remote control does not work | 98 |
| I want to change the language for messages and menus | 99 |
| Email is not received even if a problem occurs in the projector (EB-1775W/ EB-1770W/EB-1760W only) | 99 |

Maintenance

| | |
|--|------------|
| Cleaning | 101 |
| Cleaning the Projector's Surface | 101 |
| Cleaning the Lens | 101 |
| Cleaning the Air Filter | 101 |
| Replacing Consumables | 103 |
| Replacing the Lamp | 103 |
| Lamp replacement period | 103 |
| How to replace the lamp | 104 |
| Resetting the lamp hours | 106 |
| Replacing the Air Filter | 106 |
| Air filter replacement period | 106 |
| How to replace the air filter | 106 |

Appendix

| | |
|--|------------|
| Useful Software | 109 |
| EasyMP Network Projection(EB-1775W/EB-1770W/EB-1760W only) | 109 |
| EasyMP Slide Converter | 109 |
| EasyMP Monitor(EB-1775W/EB-1770W/EB-1760W only) | 109 |

| | |
|---|------------|
| Optional Accessories and Consumables | 110 |
| Optional Accessories | 110 |
| Consumables | 110 |

Monitoring and Controlling (EB-1775W/EB-1770W/EB-1760W Only) 111

| | |
|---|-----|
| Changing Settings Using a Web Browser (Web Control) | 111 |
| Projector setup | 111 |
| Displaying the Web Control screen | 111 |
| Displaying the Web Remote screen | 111 |
| Using the Mail Notification Function to Report Problems | 113 |
| Reading Error Notification Mail | 113 |
| Management Using SNMP | 113 |
| ESC/VP21 Commands | 114 |
| Before starting | 114 |
| Command list | 114 |
| Communications protocol | 114 |

About Event ID (EB-1775W/EB-1770W/EB-1760W Only) 116

About PJLink (EB-1775W/EB-1770W/EB-1760W Only) 117

Screen Size and Projection Distance 118

| | |
|--|-----|
| Projection Distance (For EB-1775W/EB-1770W/EB-1760W) | 118 |
| Projection Distance (For EB-1750) | 119 |

Supported Monitor Displays 121

| | |
|---|-----|
| Supported Resolutions | 121 |
| Computer signals (analog RGB) | 121 |
| Component video | 121 |
| Composite video | 121 |
| Input signal from the HDMI port (EB-1775W/EB-1770W/EB-1760W only) | 121 |

Specifications 123

| | |
|--|-----|
| Projector General Specifications | 123 |
|--|-----|



| | |
|----------------------------|------------|
| Appearance | 127 |
| Glossary | 128 |
| General Notes | 130 |
| About Notations | 130 |
| General Notice: | 130 |
| Index | 147 |



Introduction

This chapter explains the projector's features and the part names.

List of Functions by Model

Available functions differ depending on the model being used. See the table below for a list of the functions available for each model.

| Function | EB-1775W | EB-1770W | EB-1760W | EB-1750 |
|---------------------------|----------|----------|----------|---------|
| USB Display | ✓ | ✓ | ✓ | ✓ |
| HDMI Connection | ✓ | ✓ | ✓ | - |
| Screen Fit | ✓ | - | - | - |
| Auto H/V-Keystone | ✓ | - | - | - |
| Auto V-Keystone | - | ✓ | ✓ | ✓ |
| Wireless LAN Connection | ✓ | ✓*1 | ✓*1 | - |
| WXGA Resolutions | ✓ | ✓ | ✓ | - |
| Quick Wireless Connection | ✓ | ✓*2 | ✓*2 | - |
| Network Menu | ✓ | ✓ | ✓ | - |
| Slideshow | ✓ | ✓ | ✓ | ✓ |

*1 The Wireless LAN unit is available as an option.

*2 The Quick Wireless Connection USB Key is available as an option.

Quick and Easy Set up, Projection, and Storage

- The portable, lightweight design allows you to easily make presentations away from your office.
- Turn the projector on and off by simply plugging in or unplugging.
- Project onto large screens from a short distance.

- Make easy height adjustments with one lever.
- No cool down delay makes it easy to put away.

Connecting with a USB cable and projecting (USB Display)

By simply connecting the supplied USB cable, you can project images from a computer's screen without a computer cable.

☛ "Projecting with USB Display" p.28

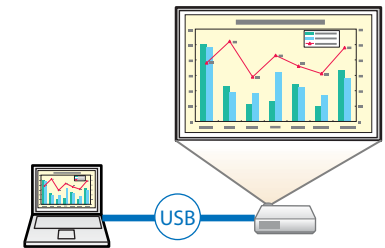

Easy Image Correction

Adjusting the projected image to automatically fit into the screen frame - Screen Fit - (EB-1775W only)

By pressing the [Screen Fit] button, you can automatically adjust the projected image to fit into the screen frame by correcting any image distortion.

☛ "Automatically Adjust to Fit the Screen Frame - Screen Fit - (EB-1775W only)" p.31

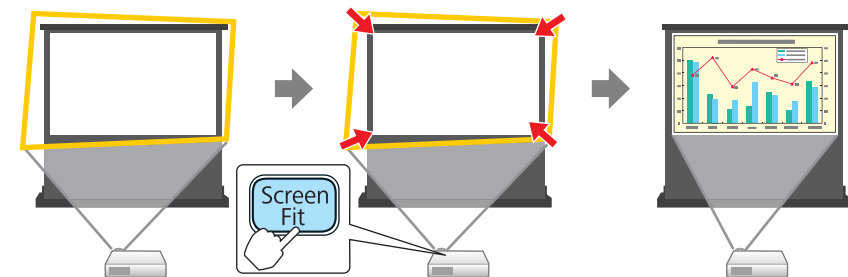

Detecting projector movements and automatically correcting image distortion

This projector automatically corrects keystone distortion and focus problems which occur when positioning or moving the projector.

For EB-1775W

Automatically corrects vertical and horizontal keystone distortion.

☛ "Correcting automatically - Auto H/V-Keystone - (EB-1775W only)" p.33

For EB-1770W/EB-1760W/EB-1750

Automatically corrects vertical keystone distortion.

☛ "Correcting automatically - Auto V-Keystone - (EB-1770W/EB-1760W/EB-1750 only)" p.34

Useful Functions for Expanding the Scope of Your Presentations

Increasing projection content in wide (WXGA) screen (EB-1775W/EB-1770W/EB-1760W only)

By increasing the volume of images and text that you can display, you can improve the impact of your presentation.

☛ "Changing the Aspect Ratio" p.40

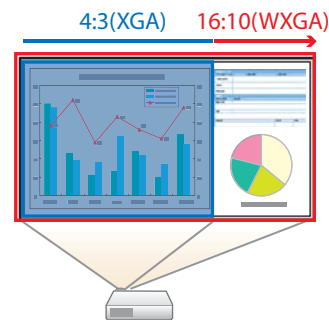

Connecting to a wireless LAN and projecting images from the computer's screen (EB-1775W/EB-1770W/EB-1760W only)

By using EasyMP Network Projection and the supplied or optional Wireless LAN unit, you can wirelessly project the computer's screen.

☛ [EasyMP Network Projection Operation Guide](#)



Connecting a projector and a computer wirelessly with Quick Wireless Connection (EB-1775W/EB-1770W/EB-1760W only)

By simply connecting the supplied or optional Quick Wireless Connection USB Key to a computer, you can connect the projector and the computer using the wireless communication and project images from the computer.

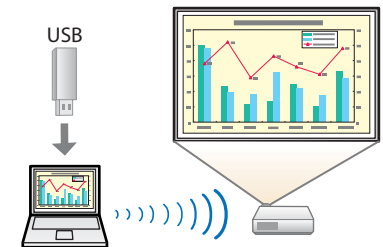

Making the most of the remote control

You can use the remote control to perform operations such as enlarging part of the image. You can also use the remote control as a pointer during presentations or as a mouse for the computer.

☛ "Pointer Function (Pointer)" p.52

☛ "Enlarging Part of the Image (E-Zoom)" p.53

☛ "Using the Remote Control to Operate the Mouse Pointer (Wireless Mouse)" p.54

All of the features in this guide are explained using illustrations of EB-1775W unless otherwise mentioned.

Front/Top

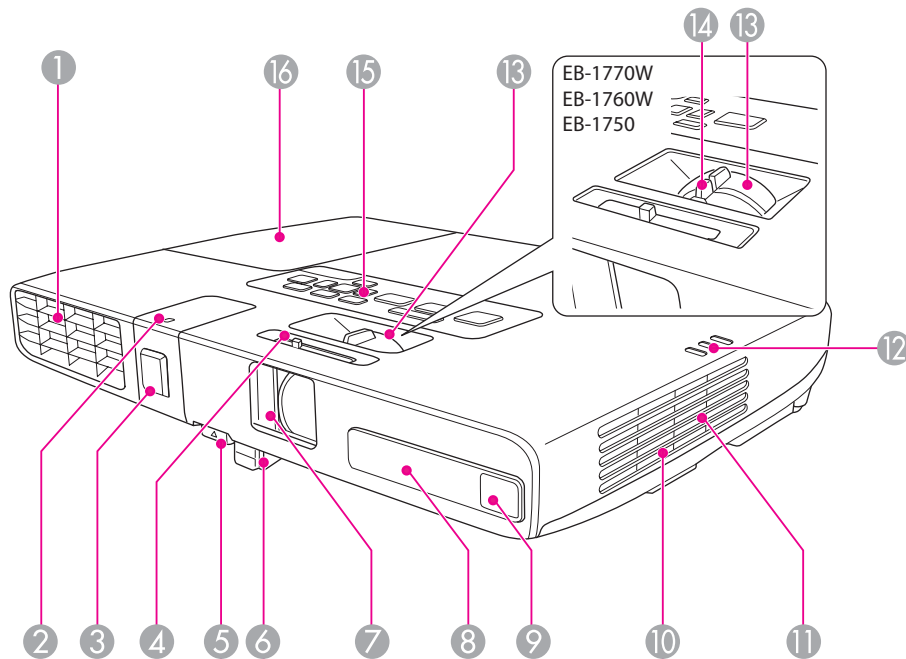

| Name | Function |
|---------------------------|---|
| ① Air exhaust vent | Exhaust vent for air used to cool the projector internally. <div style="border: 1px solid black; padding: 5px; background-color: #ffffcc;"> <p>Caution</p> <p>While projecting, do not put your face or hands near the air exhaust vent, and do not place objects that may become warped or damaged by heat near the vent.</p> </div> |

| Name | Function |
|---|--|
| ② Wireless LAN indicator (EB-1775W/EB-1770W/ EB-1760W only) | Displays the access status of the supplied or optional Wireless LAN unit. |
| ③ Wireless LAN unit cover (EB-1775W/EB-1770W/ EB-1760W only) | When making a wireless connection between the projector and computer, remove this cover to install the supplied or optional Wireless LAN unit. |
| ④ A/V mute slide knob | Slide the knob to open and close the A/V mute slide. |
| ⑤ Foot adjust lever | Press the foot lever to extend and retract the front foot. ☛ "Adjusting the Image Position" p.37 |
| ⑥ Front adjustable foot | When setup on a surface such as a desk, extend the foot to adjust the position of the image. ☛ "Adjusting the Image Position" p.37 |
| ⑦ A/V mute slide | Close when not using the projector to protect the lens. By closing during projection you can hide the image and the sound. ☛ "Hiding the Image and Sound Temporarily (A/V Mute)" p.51 |
| ⑧ Remote receiver | Receives signals from the remote control. |
| ⑨ Sensor (EB-1775W only) | Takes measurements when the projector automatically corrects the projected image. |
| ⑩ Air intake vent (air filter) | Takes in air to cool the projector internally. ☛ "Cleaning the Air Filter" p.101 |
| ⑪ Speaker | Plays back audio. |
| ⑫ Indicators | Indicates the projector's status. ☛ "Reading the Indicators" p.88 |
| ⑬ Zoom ring | Adjusts the image size. ☛ "Adjusting the Image Size" p.36 |
| ⑭ Focus ring (EB-1770W/EB-1760W/ EB-1750 only) | Adjusts the image focus. ☛ "Correcting the Focus" p.37 |

| Name | Function |
|-------------------------|---|
| 15 Control panel | Operates the projector. ☛ "Control Panel" p.13 |
| 16 Lamp cover | Open when replacing the projector's lamp. ☛ "Replacing the Lamp" p.103 |

Rear

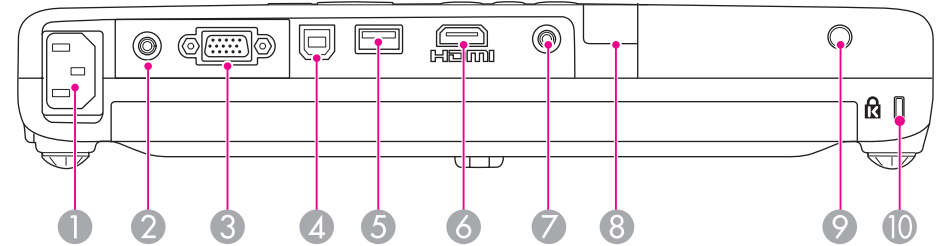

| Name | Function |
|---|--|
| 1 Power inlet | Connects the power cable to the projector. ☛ "From Installation to Projection" p.26 |
| 2 Video port | Inputs composite video signals from video sources. |
| 3 Computer port | Inputs image signals from a computer and component video signals from other video sources. |
| 4 USB (TypeB) port | <ul style="list-style-type: none"> Connects the projector to a computer via the supplied USB cable, and the image on the computer is projected. ☛ "Projecting with USB Display" p.28 Connects the projector to a computer via the supplied USB cable to use the Wireless Mouse function. ☛ "Using the Remote Control to Operate the Mouse Pointer (Wireless Mouse)" p.54 |
| 5 USB (Type A) port | <ul style="list-style-type: none"> Connects a USB memory or digital camera to project data converted by EasyMP Slide Converter (.FSE and .SIT). The data is projected using Slideshow. ☛ "Projecting Without a Computer (Slideshow)" p.45 Connects the optional Document Camera (ELPDC06). |
| 6 HDMI port (EB-1775W/EB-1770W/ EB-1760W only) | Inputs video signals from HDMI compatible video equipment and computers. This projector is compatible with HDCP . ☛ "Connecting Equipment" p.21 |

| Name | Function |
|----------------------------------|---|
| 7 Audio port | Connects an audio cable to output audio from the projector's speakers. |
| 8 Remote receiver | Receives signals from the remote control. ☛ "Remote control operating range" p.17 |
| 9 Lamp Cover Fixing Screw | Screw to fix the lamp cover in place. |
| 10 Security slot | The security slot is compatible with the Microsaver Security System manufactured by Kensington. ☛ "Anti-Theft Lock" p.65 |

Base

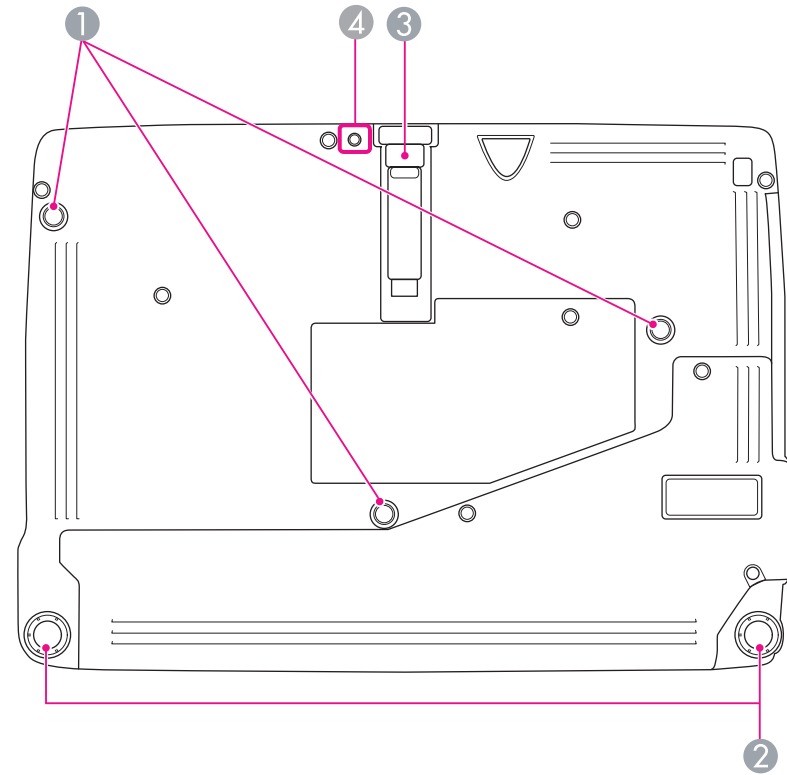

| Name | Function |
|---|--|
| 1 Ceiling mount fixing points (three points) | Attach the optional attachment plate here when suspending the projector from a ceiling. ☛ "Installing the Projector" p.19 ☛ "Optional Accessories" p.110 |
| 2 Rear feet | When setup on a surface such as a desk, turn to extend and retract to adjust the horizontal tilt. ☛ "Adjusting the Horizontal Tilt" p.37 |

| Name | Function |
|--|---|
| ③ Front adjustable foot | When setup on a surface such as a desk, extend the foot to adjust the position of the image. ☛ "Adjusting the Image Position" p.37 |
| ④ Screw hole for the wireless LAN unit cover (EB-1775W/EB-1770W/EB-1760W only) | Screw hole to fix the wireless LAN unit cover. |

Control Panel

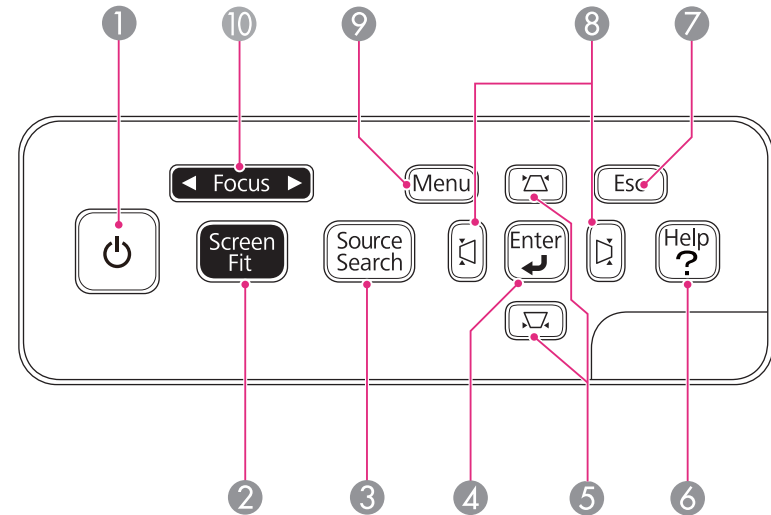

| Name | Function |
|---|--|
| ① [Power] button | Turns the projector power on or off. ☛ "From Installation to Projection" p.26 |
| ② [Screen Fit] button (EB-1775W only) | Adjusts the projected image so that it fits the screen frame. ☛ "Automatically Adjust to Fit the Screen Frame - Screen Fit - (EB-1775W only)" p.31 This button is disabled when the projector is suspended from a ceiling. |
| ③ [Source Search] button | Changes to the next input source that is sending an image. ☛ "Automatically Detect Input Signals and Change the Projected Image (Source Search)" p.27 |
| ④ [Enter] button | <ul style="list-style-type: none"> When the Configuration menu or the Help screen is displayed, it accepts and enters the current selection and moves to the next level. If pressed during projection of computer signal images, it automatically adjusts the Tracking, Sync., and Position to project the optimum image. |

| Name | Function |
|-----------------------------------|---|
| 5 [△][▽] buttons | <ul style="list-style-type: none"> Performs vertical keystone correction. <ul style="list-style-type: none"> "Correcting keystone distortion in vertical directions" p.34 If pressed when the Configuration menu or the Help screen is displayed, these buttons select menu items and setting values. <ul style="list-style-type: none"> "Using the Configuration Menu" p.67 "Using the Help" p.87 |
| 6 [Help] button | <p>Displays and closes the Help screen which shows you how to deal with problems if they occur.</p> <ul style="list-style-type: none"> "Using the Help" p.87 |
| 7 [Esc] button | <ul style="list-style-type: none"> Stops the current function. If pressed when the Configuration menu is displayed, it moves to the previous menu level. <ul style="list-style-type: none"> "Using the Configuration Menu" p.67 |
| 8 [◀][▶] buttons | <ul style="list-style-type: none"> Performs horizontal keystone correction. <ul style="list-style-type: none"> "Correcting keystone distortion in horizontal directions" p.34 If pressed when the Configuration menu or the Help screen is displayed, these buttons select menu items and setting values. <ul style="list-style-type: none"> "Using the Configuration Menu" p.67 "Using the Help" p.87 |
| 9 [Menu] button | <p>Displays and closes the Configuration menu.</p> <ul style="list-style-type: none"> "Using the Configuration Menu" p.67 |
| 10 [Focus] button (EB-1775W only) | <p>Adjusts the image focus.</p> <ul style="list-style-type: none"> "Correcting the Focus" p.37 |

Remote Control

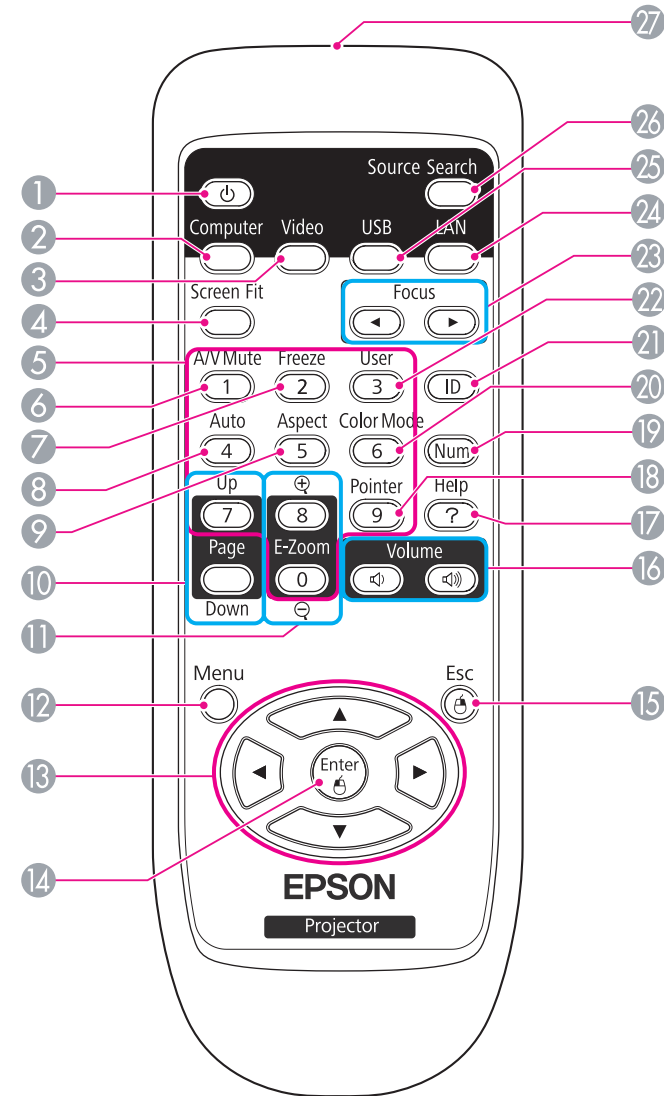

| Name | Function |
|-----------------------|--|
| ① [Power] button | Turns the projector power on or off. ☛ "From Installation to Projection" p.26 |
| ② [Computer] button | Changes to images from the Computer port. |
| ③ [Video] button | Each time you press the button, the input source changes between images from the Video port and the HDMI port (EB-1775W/EB-1770W/EB-1760W only). |
| ④ [Screen Fit] button | Adjusts the projected image so that it fits the screen frame. (EB-1775W only) ☛ "Automatically Adjust to Fit the Screen Frame - Screen Fit - (EB-1775W only)" p.31 When the projector is suspended from a ceiling or when using EB-1770W/EB-1760W/EB-1750, this does not function even if the button is pressed. |
| ⑤ Numeric buttons | <ul style="list-style-type: none"> Use this button to enter passwords and set the remote control ID. ☛ "Setting the remote control ID" p.57 ☛ "Setting Password Protect" p.62 Use this button to enter numbers in Network settings from the Configuration menu. (EB-1775W/EB-1770W/EB-1760W only) |
| ⑥ [A/V Mute] button | Turns the video and audio on or off. ☛ "Hiding the Image and Sound Temporarily (A/V Mute)" p.51 |
| ⑦ [Freeze] button | Images are paused or unpaused. ☛ "Freezing the Image (Freeze)" p.52 |
| ⑧ [Auto] button | If pressed during projection of computer signal images, it automatically adjusts the Tracking , Sync. , and Position to project the optimum image. |
| ⑨ [Aspect] button | The aspect ratio changes each time the button is pressed. ☛ "Changing the Aspect Ratio" p.40 |

| Name | Function |
|------------------------------|---|
| ⑩ [Page] buttons [Up] [Down] | Changes pages in files such as PowerPoint files when using the following projection methods. <ul style="list-style-type: none"> When using the Wireless Mouse function ☛ "Using the Remote Control to Operate the Mouse Pointer (Wireless Mouse)" p.54 When using USB Display ☛ "Projecting with USB Display" p.28 During a network connection (EB-1775W/EB-1770W/EB-1760W only) When projecting images or scenarios using Slideshow, pressing these buttons displays the previous/next screen. |
| ⑪ [E-Zoom] buttons [E+][E-] | Enlarges or reduces the image without changing the projection size. ☛ "Enlarging Part of the Image (E-Zoom)" p.53 |
| ⑫ [Menu] button | Displays and closes the Configuration menu. ☛ "Using the Configuration Menu" p.67 |
| ⑬ [Navigation] buttons | <ul style="list-style-type: none"> When the Configuration menu or the Help screen is displayed, pressing these buttons selects menu items and setting values. ☛ "Using the Configuration Menu" p.67 When projecting a Slideshow, pressing these buttons displays the previous/next image, rotates the image, and so on. ☛ "Slideshow operating methods" p.46 During Wireless Mouse function, the mouse pointer moves in the direction of the button that was pushed. ☛ "Using the Remote Control to Operate the Mouse Pointer (Wireless Mouse)" p.54 |

| Name | Function |
|--------------------------------|--|
| 14 [Enter] button | <ul style="list-style-type: none"> When the Configuration menu or the Help screen is displayed, it accepts and enters the current selection and moves to the next level. <ul style="list-style-type: none"> "Using the Configuration Menu" p.67 Acts as a mouse's left button when using the Wireless Mouse function. <ul style="list-style-type: none"> "Using the Remote Control to Operate the Mouse Pointer (Wireless Mouse)" p.54 |
| 15 [Esc] button | <ul style="list-style-type: none"> Stops the current function. If pressed when the Configuration menu is displayed, it moves to the previous level. <ul style="list-style-type: none"> "Using the Configuration Menu" p.67 Acts as a mouse's right button when using the Wireless Mouse function. <ul style="list-style-type: none"> "Using the Remote Control to Operate the Mouse Pointer (Wireless Mouse)" p.54 |
| 16 [Volume] buttons [<] [>] | <p>[<] Decreases the volume. [>] Increases the volume.</p> <ul style="list-style-type: none"> "Adjusting the Volume" p.38 |
| 17 [Help] button | <p>Displays and closes the Help screen which shows you how to deal with problems if they occur.</p> <ul style="list-style-type: none"> "Using the Help" p.87 |
| 18 [Pointer] button | <p>Displays the on-screen pointer.</p> <ul style="list-style-type: none"> "Pointer Function (Pointer)" p.52 |
| 19 [Num] button | <p>Hold down this button and press the numeric buttons to enter passwords and numbers.</p> <ul style="list-style-type: none"> "Setting Password Protect" p.62 |
| 20 [Color Mode] button | <p>Each time the button is pressed, the Color Mode changes.</p> <ul style="list-style-type: none"> "Selecting the Projection Quality (Selecting Color Mode)" p.38 |
| 21 [ID] button | <p>Hold down this button and press the numeric buttons to set the remote control ID.</p> <ul style="list-style-type: none"> "Setting the remote control ID" p.57 |

| Name | Function |
|---------------------------------------|--|
| 22 [User] button | <p>Select any frequently used item from the five available Configuration menu items, and assign it to this button. By pressing the [User] button, the assigned menu item selection/adjustment screen is displayed, allowing you to make one-touch settings/adjustments.</p> <ul style="list-style-type: none"> "Settings Menu" p.73 <p>Power Consumption is assigned as the default setting.</p> |
| 23 [Focus] buttons [←][→] | <p>Adjusts the image focus. (EB-1775W only)</p> <p>When using EB-1770W/EB-1760W/EB-1750, this does not function even if the button is pressed.</p> <ul style="list-style-type: none"> "Correcting the Focus" p.37 |
| 24 [LAN] button | <p>Changes to the image projected with EasyMP Network Projection. When projecting using the supplied or optional Quick Wireless Connection USB Key, this button switches to that image. (EB-1775W/EB-1770W/EB-1760W only)</p> |
| 25 [USB] button | <p>Each time the button is pressed, it cycles through the following images:</p> <ul style="list-style-type: none"> USB Display Images from the device connected to the USB (TypeA) port |
| 26 [Source Search] button | <p>Changes to the next input source that is sending an image.</p> <ul style="list-style-type: none"> "Automatically Detect Input Signals and Change the Projected Image (Source Search)" p.27 |
| 27 Remote control light-emitting area | <p>Outputs remote control signals.</p> |

Replacing the remote control batteries

If delays in the responsiveness of the remote control occur or if it does not operate after it has been used for some time, it probably means that the batteries are becoming flat. When this happens, replace them with new batteries. Have two AA size manganese or alkaline batteries ready. You cannot use other batteries except for the AA size manganese or alkaline.

Attention

Make sure you read the following manual before handling the batteries.

 [Safety Instructions](#)

1 Remove the battery cover.

While pushing the battery compartment cover catch, lift the cover up.

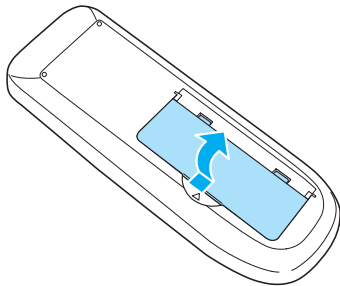

2 Replace the old batteries with new batteries.

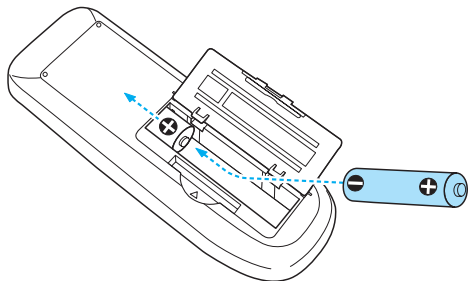

Caution

Check the positions of the (+) and (-) marks inside the battery holder to ensure the batteries are inserted the correct way.

3 Replace the battery cover.

Press the battery compartment cover until it clicks into place.

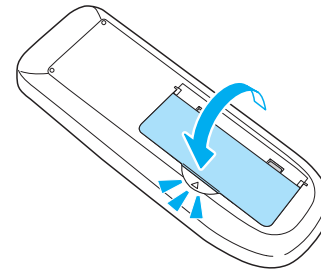

Remote control operating range

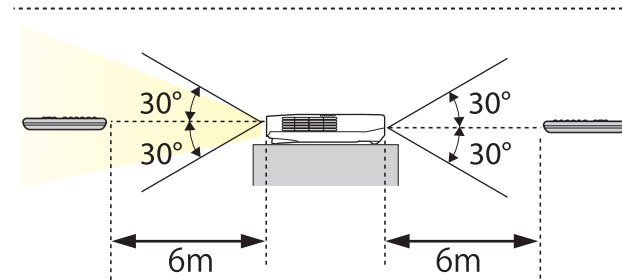
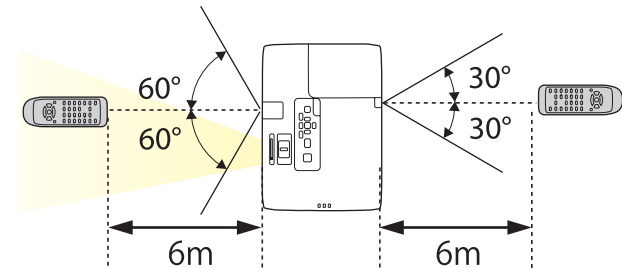



Preparing the Projector

This chapter explains how to install the projector and connect projection sources.

Installation Methods

The projector supports the following four different projection methods. Install the projector according to the conditions of the installation location.

- Project images from in front of the screen. (Front projection)

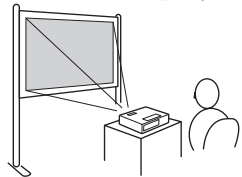

- Project images from behind a translucent screen. (Rear projection)

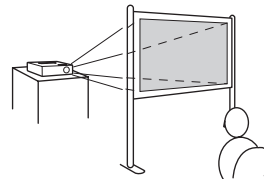

- Suspend the projector from the ceiling and project images from in front of a screen. (Front/Ceiling projection)

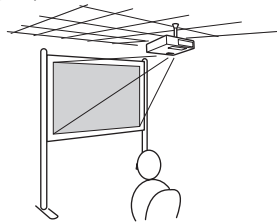

- Suspend the projector from the ceiling and project images from behind a translucent screen. (Rear/Ceiling projection)

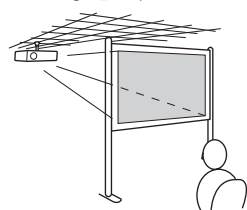

Warning

- A special method of installation is required when suspending the projector from a ceiling (ceiling mount). If it is not installed correctly, it could fall causing an accident and injury.
- If you use adhesives on the Ceiling mount fixing points to prevent the screws from loosening, or if you use things such as lubricants or oils on the projector, the projector case may crack causing it to fall from its ceiling mount. This could cause serious injury to anyone under the ceiling mount and could damage the projector.
When installing or adjusting the ceiling mount, do not use adhesives to prevent the screws from loosening and do not use oils or lubricants and so on.

Attention

- Do not use the projector on its side. This may cause malfunctions to occur.
- Do not cover the projector's air intake vent or air exhaust vent. If either of the vents are covered, the internal temperature could rise and cause a fire.



- An optional ceiling mount and attachment plate are required when suspending the projector from a ceiling.
☛ "Optional Accessories" [p.110](#)
- You can change the setting as follows by pressing down the [A/V Mute] button on the remote control for about five seconds.
Front ↔ Front/Ceiling
Set **Rear** or **Rear/Ceiling** from the Configuration menu.
☛ **Extended - Projection** [p.74](#)

Installation methods

Install the projector so that it is parallel to the screen.

If the projector is installed at an angle to the screen, keystone distortion occurs in the projected image. See the following for more information on correcting keystone distortion.

☛ "Automatically Adjust to Fit the Screen Frame - Screen Fit - (EB-1775W only)" [p.31](#)

☛ "Correcting Keystone Distortion" [p.33](#)

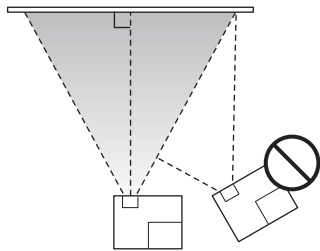

Place the projector on a level surface. See the following if the projected image is tilted horizontally.

☛ "Adjusting the Horizontal Tilt" [p.37](#)

Screen Size and Approximate Projection Distance

Projection size is determined by the distance from the projector to the screen. See the illustrations on the right to select the best position according to the screen size. The illustrations show the approximate shortest distance at maximum zoom. See the following for more information on the projection distance.

☛ "Screen Size and Projection Distance" [p.118](#)



When you correct keystone distortion, the projected image may be reduced.

For EB-1775W/EB-1770W/EB-1760W

16:10 Screen Size

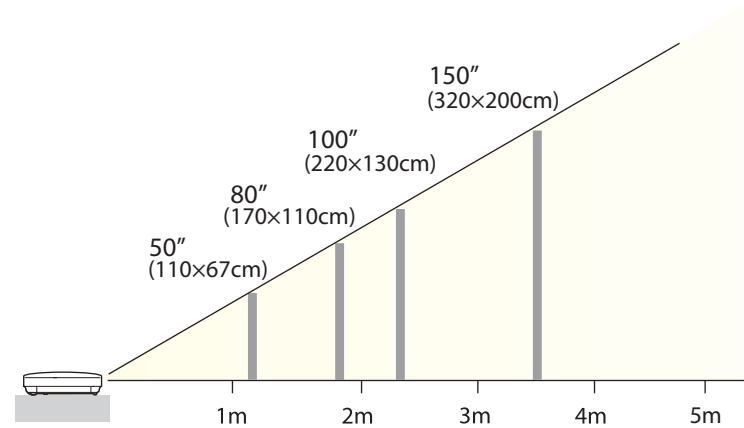

For EB-1750

4:3 Screen Size

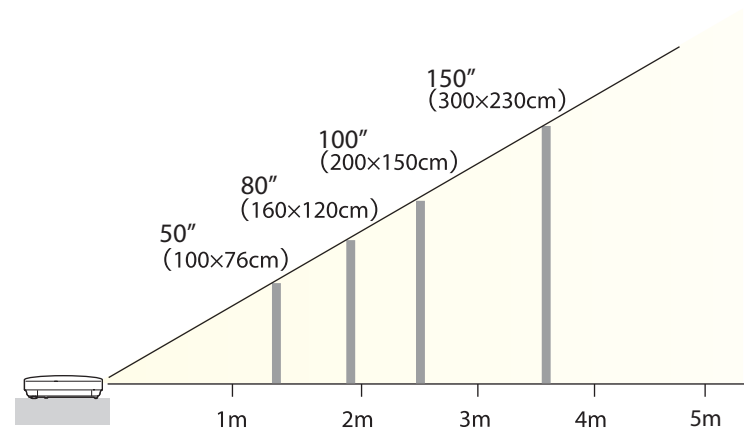

This section gives examples of how to connect the projector and the projection source. Illustrations in this section are of EB-1775W/EB-1770W/EB-1760W. The port name, location, and connector orientation differ depending on the source being connected.

Connecting a Computer

To project images from a computer, connect the computer using one of the following methods.

1 When using the supplied computer cable

Connect the computer's display output port to the projector's Computer input port using the supplied computer cable. To output audio from the projector's speaker, you need to connect a commercially available audio cable.

2 When using the supplied USB cable

Connect the computer's USB port to the projector's USB (Type B) port using the supplied USB cable.

3 When using a commercially available HDMI cable

Connect the computer's HDMI port to the projector's HDMI port using a commercially available HDMI cable.

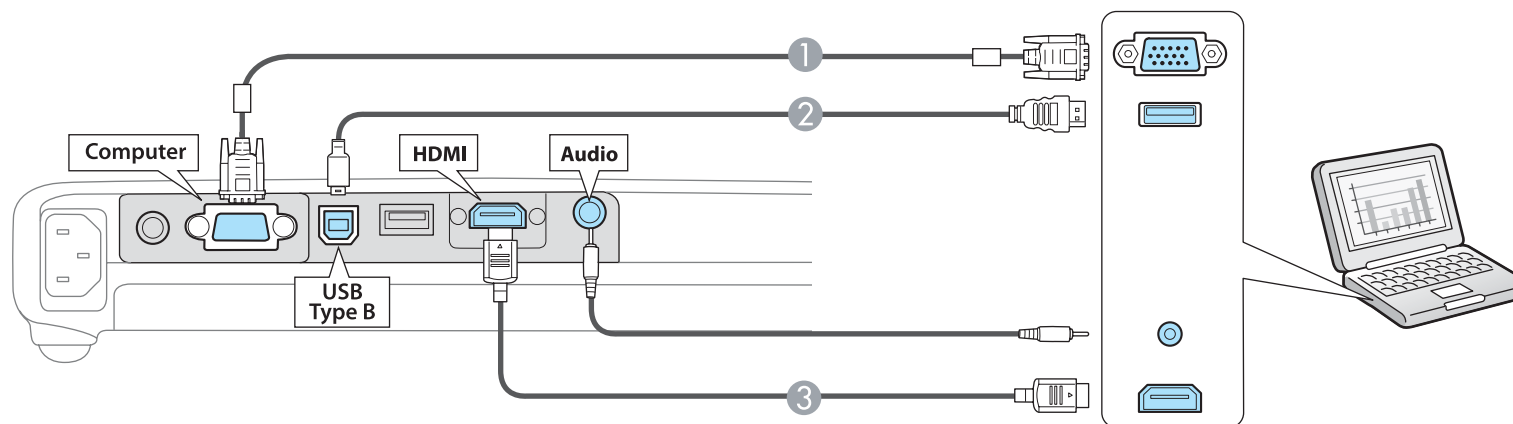

Simply by connecting the projector to a computer via a USB cable, you can project images from the computer. This function is called USB Display.

☛ "Projecting with USB Display" [p.28](#)

Connecting Image Sources

To project images from DVD players or VHS video and so on, connect to the projector using one of the following methods.

1 When using a commercially available video cable

Connect the video output port on the image source to the projector's Video input port using a commercially available video cable. To output audio from the projector's speaker, you need to connect a commercially available audio cable.

2 When using the optional component video cable

☞ "Optional Accessories" p.110

Connect the component output port on the image source to the projector's Computer input port using the optional component video cable. To output audio from the projector's speaker, you need to connect a commercially available audio cable.

3 When using a commercially available HDMI cable

Connect the HDMI port on the image source to the projector's HDMI port using a commercially available HDMI cable.

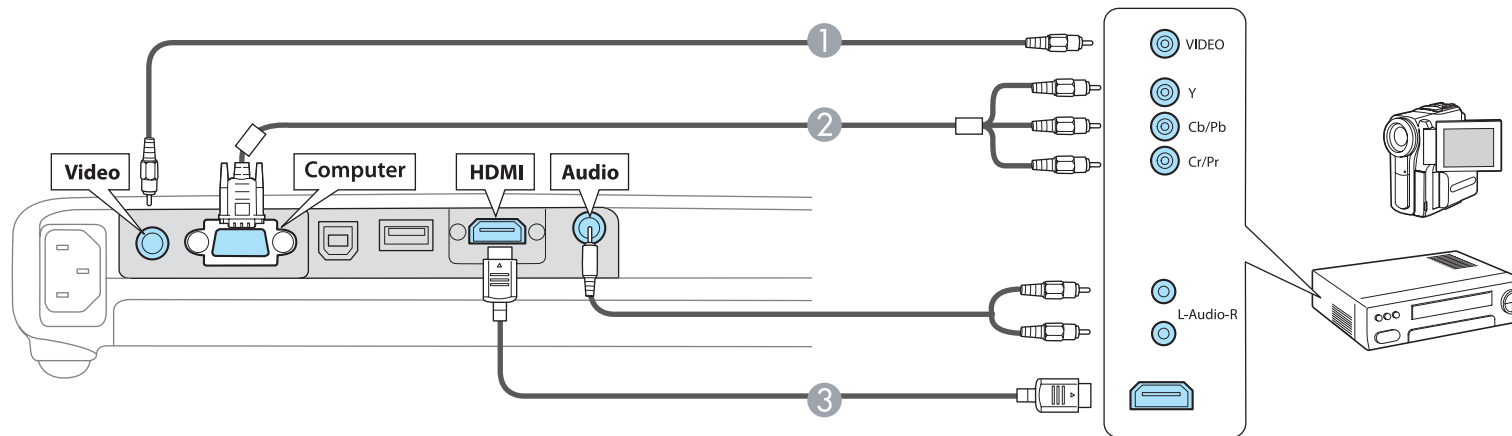

Attention

- If the input source is on when you connect it to the projector, it could cause a malfunction.
- If the orientation or shape of the plug differs, do not try to force it in. The device could be damaged or could malfunction.



- If the source you want to connect to has an unusually shaped port, use the cable supplied with the device or an optional cable to connect to the projector.
- When using a commercially available 2RCA(L/R)/stereo mini-pin audio cable, make sure it is labeled "No resistance".

Connecting USB Devices

You can connect devices such as USB memory, the optional Document Camera, and USB compatible hard disks and digital cameras.

Using the USB cable supplied with the USB device, connect the USB device to the USB (Type A) port on the projector.

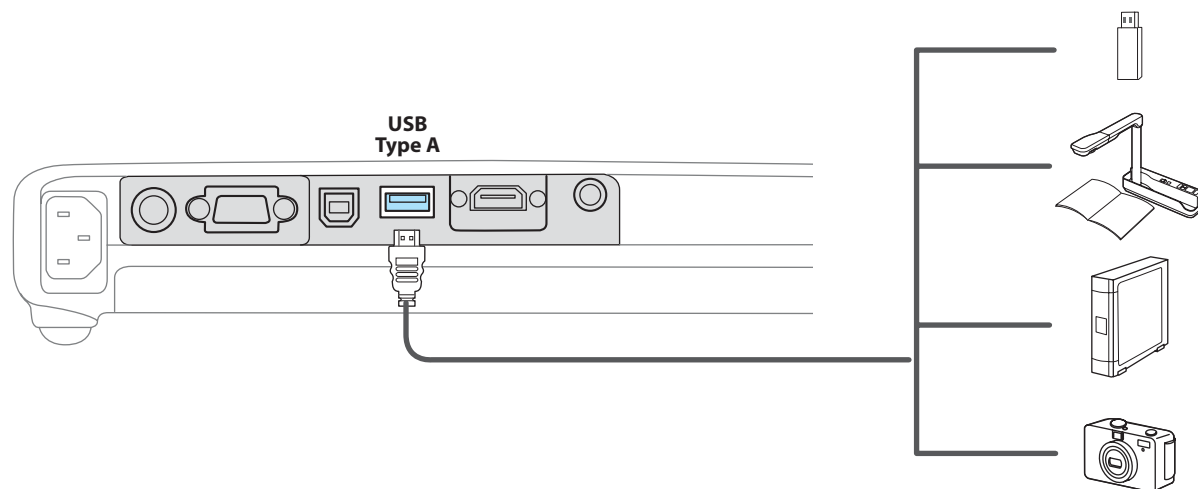

When the USB device is connected, you can project image files on the USB memory or digital camera using Slideshow.

☛ "Slideshow examples" [p.45](#)

If the Document Camera is connected while another image source is projecting, press the [USB] button on the remote control, or the [Source Search] button on the control panel to switch to images from the Document Camera.

☛ "Automatically Detect Input Signals and Change the Projected Image (Source Search)" [p.27](#)

Attention

- If you use a USB hub, the connection may not operate correctly. Devices such as digital cameras and USB devices should be connected to the projector directly.
- When connecting and using a USB-compatible hard disk, make sure you connect the AC adaptor supplied with the hard disk.
- Connect a digital camera or hard disk to the projector using a USB cable supplied with or specified for use with the device.
- Use a USB cable less than 3 m in length. If the cable exceeds 3 m, Slideshow may not function correctly.



Removing USB devices

After finishing projecting, remove USB devices from the projector. For devices such as digital cameras or hard disks, turn off the device and then remove it from the projector.





Basic Usage

This chapter explains how to project and adjust images.

From Installation to Projection

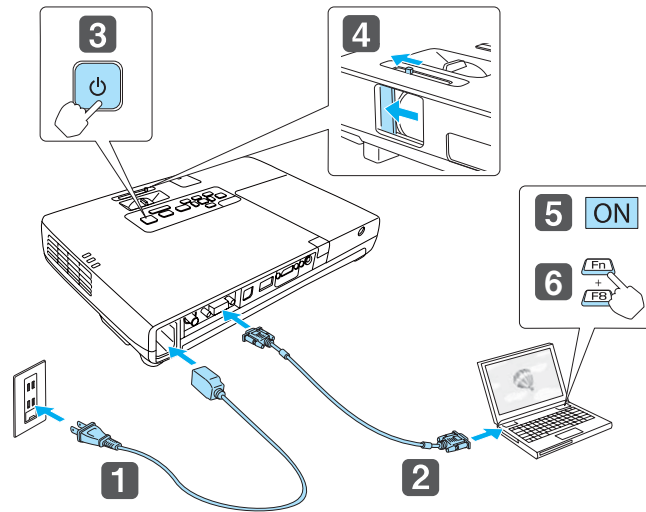
This section explains the procedure for connecting the projector to a computer with the computer cable and projecting images.



- 1** Connect the projector to an electrical outlet with the power cable.
- 2** Connect the projector to the computer with the computer cable.
- 3** Turn on the projector.
- 4** Slide open the A/V mute slide.
- 5** Turn on your computer.
- 6** Change the computer's screen output.
When using a laptop computer, you need to change the screen output from the computer.
Hold down the Fn key (function key), and press the /□ key.



The method for changing differs depending on the computer being used. See the documentation supplied with the computer.

If the image is not projected, you can change the projected image using one of the following methods.

- Press the [Source Search] button on the control panel or the remote control.
 - "Automatically Detect Input Signals and Change the Projected Image (Source Search)" [p.27](#)
- Press the button for the target port on the remote control.
 - "Switching to the Target Image by Remote Control" [p.28](#)



After projecting the image, adjust the image if necessary.

- "Automatically Adjust to Fit the Screen Frame - Screen Fit - (EB-1775W only)" [p.31](#)
- "Correcting Keystone Distortion" [p.33](#)
- "Correcting the Focus" [p.37](#)

Automatically Detect Input Signals and Change the Projected Image (Source Search)

Press the [Source Search] button to project images from the port currently receiving an image.

Because only images from ports receiving an image are projected, you can quickly project the image you want.

Using the remote control

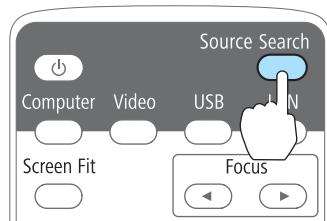

Using the control panel

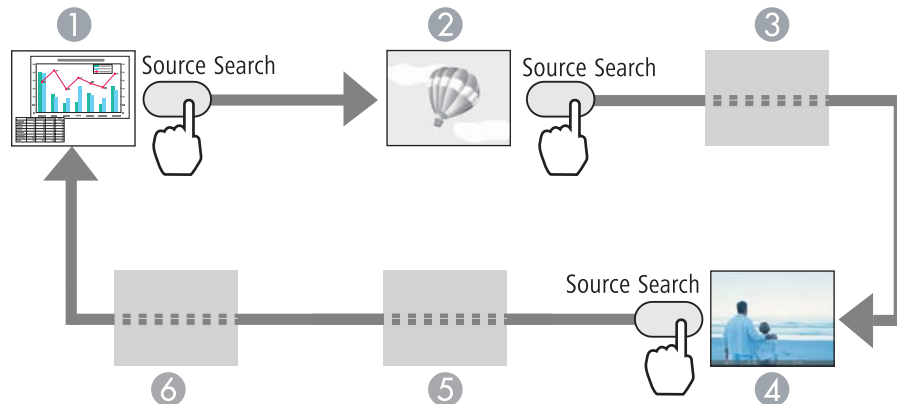
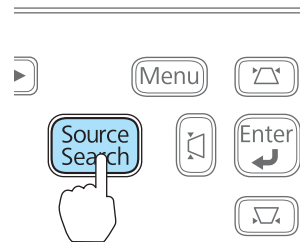

- ① Computer
- ② Video
- ③ HDMI (EB-1775W/EB-1770W/EB-1760W only)
- ④ USB Display
- ⑤ USB

⑥ LAN (EB-1775W/EB-1770W/EB-1760W only)

When two or more image sources are connected, press the [Source Search] button until the target image is projected.

When your video equipment is connected, start playback before beginning this operation.



The following screen is displayed when only the image that the projector is currently displaying is available, or when no image signal can be found. You can select the port where the equipment you want to use is connected. If no operation is performed after about 10 seconds, the screen closes.

Example: EB-1775W/EB-1770W/EB-1760W

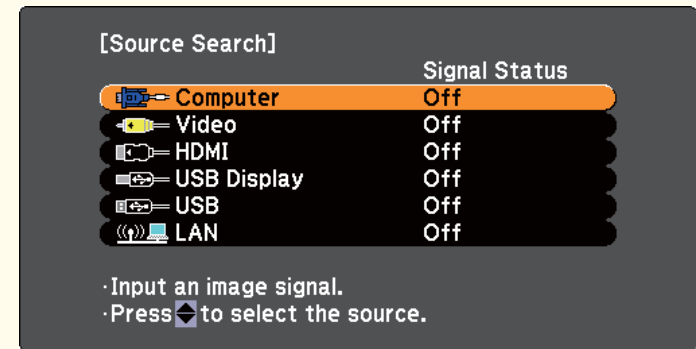

[] : Select [Enter] : Enter [Esc] : Exit

Switching to the Target Image by Remote Control

You can change directly to the target image by pressing the following buttons on the remote control.

Remote control

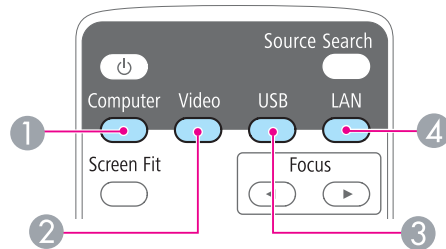

- ① Changes to images from the Computer port.
- ② Each time the button is pressed, it cycles through the following images:
 - Video port
 - HDMI port (EB-1775W/EB-1770W/EB-1760W only)
- ③ Each time the button is pressed, it cycles through the following images:
 - USB Display
 - Images from the device connected to the USB (TypeA) port
- ④ Changes to the image projected with EasyMP Network Projection. When projecting using the supplied or optional Quick Wireless Connection USB Key, this button switches to that image. (EB-1775W/EB-1770W/EB-1760W only)

Projecting with USB Display

You can use the supplied USB cable to connect the projector to a computer to project images from the computer.

To start USB Display, set **USB Type B** to **USB Display** from the Configuration menu.

☛ **Extended - USB Type B** p.74

System Requirements

For Windows

| | |
|-----------------------------|---|
| OS | Windows 2000 Service Pack 4 The following 32 bit operating systems: Windows XP Windows XP Service Pack 2 or later Windows Vista Windows Vista Service Pack 1 or later Windows 7 |
| CPU | Mobile Pentium III 1.2 GHz or faster Recommended: Pentium M 1.6 GHz or faster |
| Amount of Memory | 256 MB or more Recommended: 512 MB or more |
| Hard Disk Free space | 20 MB or more |
| Display | Resolution of no less than 640x480 and no higher than 1600x1200. Display color in 16-bit color or greater |

For Mac OS

| | |
|-----------------------------|--|
| OS | Mac OS X 10.5.1 or later Mac OS X 10.6.x |
| CPU | Power PC G4 1GHz or faster Recommended: Core Duo 1.83GHz or faster |
| Amount of Memory | 512 MB or more |
| Hard Disk Free Space | 20 MB or more |
| Display | Resolution of no less than 640x480 and no higher than 1680x1200. Display color in 16-bit color or greater |

Connecting for the first time

The first time you connect the projector and the computer using the USB cable, the driver needs to be installed. The procedure is different for Windows and Mac OS.



- You do not need to install the driver the next time you connect.
- When inputting images from multiple sources, change the input source to USB Display.

For Windows

- 1** Driver installation starts automatically.
When you are using Windows 2000, double-click **Computer - EPSON_PJ_UD - EMP_UDSE.EXE** on your computer.
- 2** When the License Agreement screen is displayed, click **Agree**.
- 3** Computer images are projected.
It may take a while before computer images are projected. Until computer images are projected, leave the equipment as it is and do not disconnect the USB cable or turn off the power to the projector.
- 4** Disconnect the USB cable when you are finished.
When disconnecting the USB cable, there is no need to use **Safely Remove Hardware**.



- If it is not installed automatically, double-click **My Computer** - **EPSON_PJ_UD** - **EMP_UDSE.EXE** on your computer.
- If nothing is projected for some reason, click **All Programs** - **EPSON Projector** - **EPSON USB Display** - **EPSON USB Display Vx.xx** on your computer.
- When using a computer running Windows 2000 under user authority, a Windows error message is displayed and you may not be able to use the software. In this case, try updating Windows to the latest version, restart, and then try to connect again.

For more details, contact your local dealer or the nearest address provided in the following document.

 [Epson Projector Contact List](#)

For Mac OS

- 1** The Setup folder of USB Display is displayed in the Finder.
- 2** Double-click the **USB Display Installer** icon.
- 3** Follow the on-screen instructions to install.
- 4** When the License Agreement screen is displayed, click **Agree**.
Enter the administrator authority password and start the installation.
When the installation is complete, the USB Display icon is displayed in the Dock and menu bar.
- 5** Computer images are projected.
It may take a while before computer images are projected. Until computer images are projected, leave the equipment as it is and do not disconnect the USB cable or turn off the power to the projector.
- 6** Select **Disconnect** from the **USB Display** icon menu on the menu bar or Dock, and then remove the USB cable.



- If the USB Display setup folder is not displayed automatically in the Finder, double-click **EPSON PJ_UD** - **USB Display Installer** on your computer.
- If nothing is projected for some reason, click the **USB Display** icon in the Dock.
- If there is no **USB Display** icon in the Dock, start **USB Display** from the Applications folder.
- If you select **Exit** from the **USB Display** icon menu on the Dock, USB Display does not start automatically when you connect the USB cable.

Uninstalling

For Windows

Click **Control Panel** - **Add/Remove Programs** and uninstall **EPSON USB Display**.

For Mac OS

Double-click **Applications** and then **USB Display**. Start **USB Display UnInstaller** in the **Tool** folder.

Automatically Adjust to Fit the Screen Frame - Screen Fit - (EB-1775W only)

Screen Fit is a function that corrects the projected image so that it aligns with the frame (outer border) of the screen, white board, and so on. By pressing the [Screen Fit] button on the remote control or the control panel, the projected image is adjusted to fit the screen, and keystone correction and focus adjustments are performed automatically.

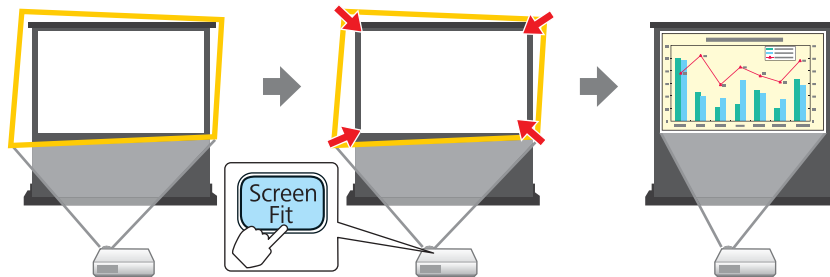

The following conditions are necessary to correct the projected image using Screen Fit.

Screen size: less than or equal to 100"

Distance between projector and screen: approx. 1.0 to 2.5 m

Correction angle: approx 20° right and left/approx. 30° up and down

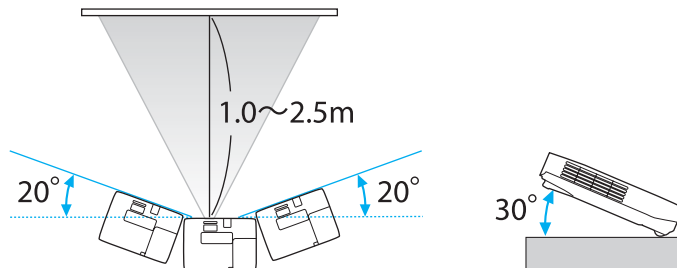

- If you exceed the above mentioned range, the projected image cannot be corrected properly. Correct the projected image manually.
- Screen Fit does not function if the projector is suspended from a ceiling. Correct the projected image manually.

- 1 Press the [Screen Fit] button on the remote control or the control panel during projection.

Using the remote control

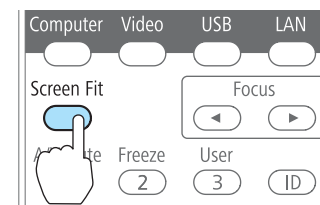

Using the control panel

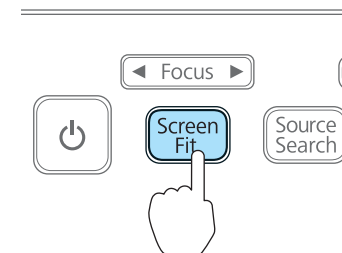

- Adjust the zoom ring so that the yellow frame is bigger than the screen frame as shown below. Position the black message box in the center of the screen.

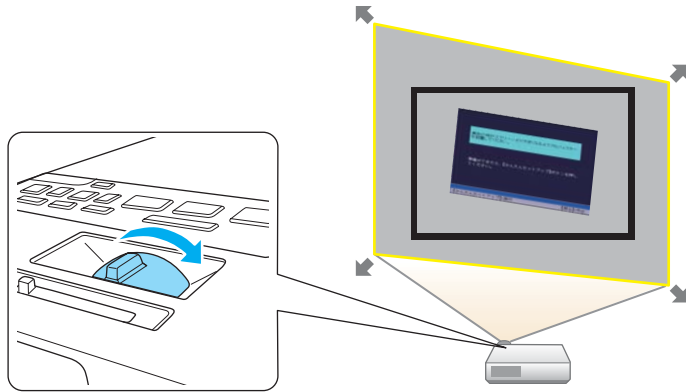

If the yellow frame is still within the screen frame even after adjusting the zoom ring to its maximum size, try moving the projector further away from the screen.

- Press the [Screen Fit] button or the [Enter] button. After the adjustment screen appears, the projected image is corrected according to the aspect ratio of the image being input.

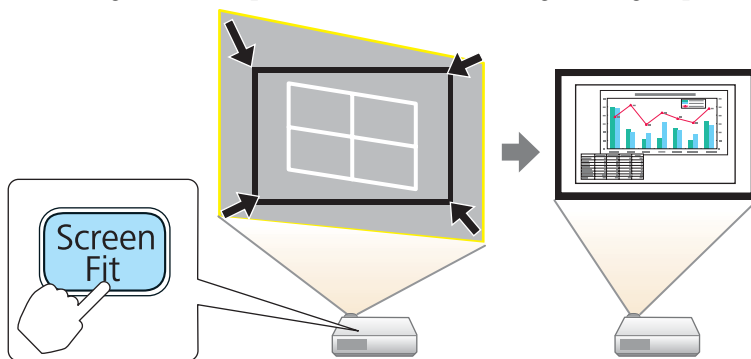

Once the adjustment screen appears, do not move the projector or block the image. The projected image will not be corrected properly.

- After the correction is performed, the following message appears. To exit the correction menu, press the [Esc] button on the remote control or the control panel to clear the message. To fine-tune the projected image after it has been corrected, make the adjustments using the [↶][↷][↵][↶] buttons on the control panel.

The revision result can be adjusted by  on the main control panel.

If no operation is performed, the message closes after about 7 seconds.

After executing Screen Fit, **Keystone** from the Configuration menu is set to **Quick Corner**. After this, any correction of the projected image using the [↶][↷][↵][↶] buttons on the control panel is performed using the Quick Corner function.

☛ "Correcting manually - Quick Corner -" [p.34](#)



- Screen Fit corrects the projected image when it detects two or more sides inside the projected area, and aligns with the detected frame. For example, when projecting onto a wide screen in a small room, you can make corrections by fitting the top and bottom sides of the screen into the projected area.

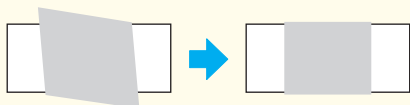

- Screen Fit may not work well in dark environments, such as a room with lights turned off. In this case, make the room brighter, and then try executing Screen Fit again.
- Because Screen Fit uses a sensor, it may not work properly depending on the condition of the projection surface (deflections, patterns, and so on) or the effects of outside light. In this case, make the adjustments manually.

☞ "Correcting manually - manual H/V-Keystone -" [p.34](#)

- Correcting manually (manual H/V-Keystone)
Manually correct distortion in the horizontal and vertical directions independently.

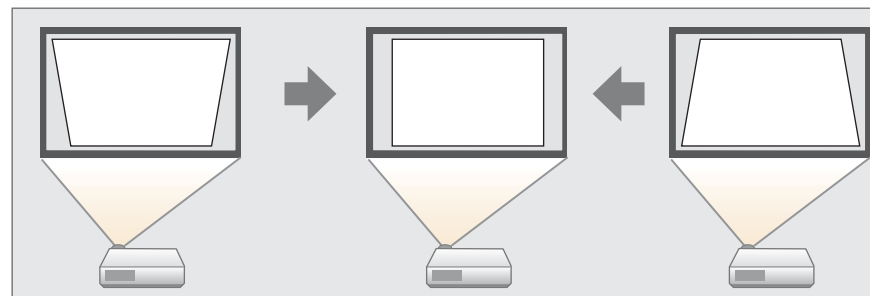

- Correcting manually (Quick Corner)
Manually correct the four corners independently.

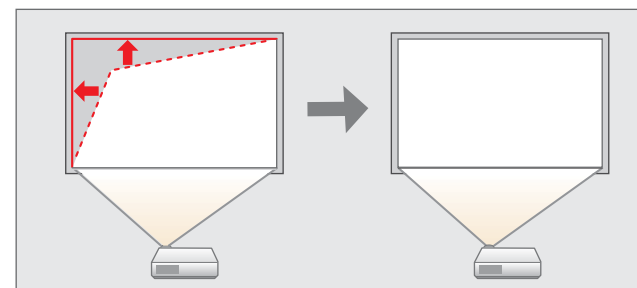

When you correct keystone distortion, the projected image may be reduced.

Correcting Keystone Distortion

You can correct keystone distortion using one of the following methods.

- Correcting automatically
Automatically correct keystone distortion.
-Auto H/V-Keystone (EB-1775W only)
-Auto V-Keystone (EB-1770W/EB-1760W/EB-1750 only)

Correcting automatically - Auto H/V-Keystone - (EB-1775W only)

When the projector detects any movement, for example when it is installed, moved, repositioned, or tilted, it automatically corrects vertical and horizontal keystone distortion. This function is called Auto H/V-Keystone.

When the projector remains still for about two seconds after it detects movement, it displays a screen for adjustment and then automatically corrects the projected image.

- Auto H/V-Keystone only works when **Projection** is set to **Front** from the Configuration menu.
 🖱️ **Extended - Projection** p.74
- If you do not want to use the Auto H/V-Keystone function, set **Auto H/V-Keystone** to **Off**.
 🖱️ **Settings - Keystone - H/V-Keystone - Auto H/V-Keystone** p.73

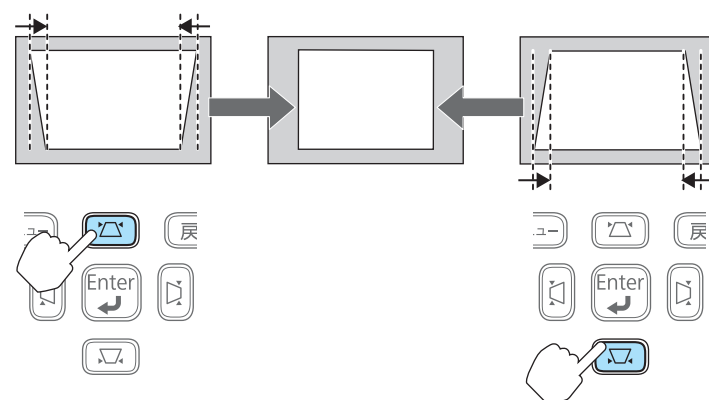

Correcting keystone distortion in horizontal directions

Press the   buttons on the control panel.

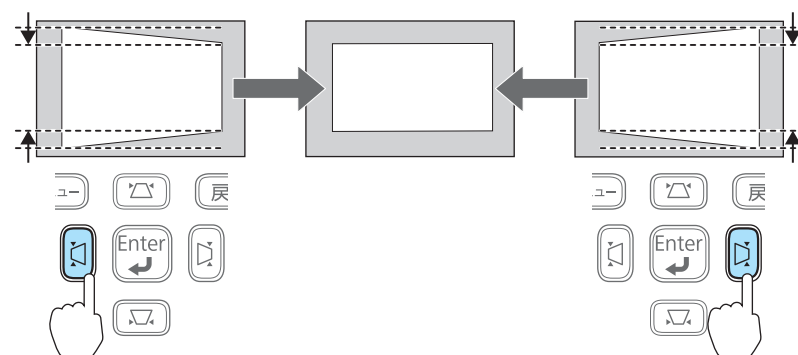

Correcting manually - manual H/V-Keystone -

Manually correct distortion in the horizontal and vertical directions independently. H/V-Keystone correction is ideal for fine-tuning keystone distortion.

Correcting keystone distortion in vertical directions

Press the   buttons on the control panel.

- You can set manual H/V-Keystone from the Configuration menu.
 🖱️ **Settings - Keystone - H/V-Keystone** p.73

Correcting manually - Quick Corner -

This allows you to manually correct each of the four corners of the projected image separately.

1 Press the [Menu] button while projecting.

☛ "Using the Configuration Menu" p.67

Using the remote control

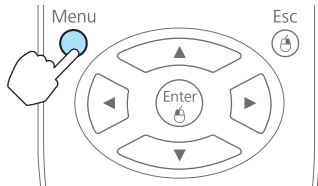

Using the control panel

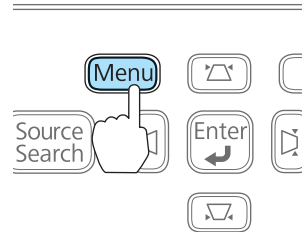

2 Select **Keystone** from **Settings**.

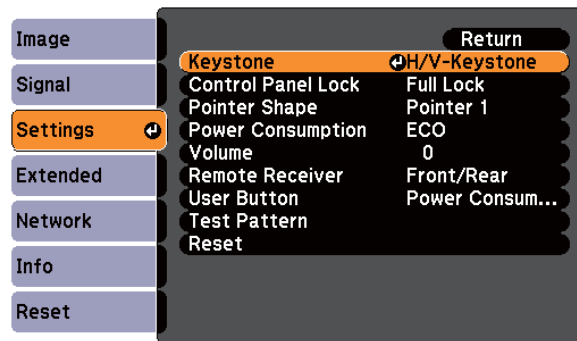

[Esc]:Return [↕]:Select [Enter]:Enter [Menu]:Exit

3 Select **Quick Corner**, and then press the [Enter] button.

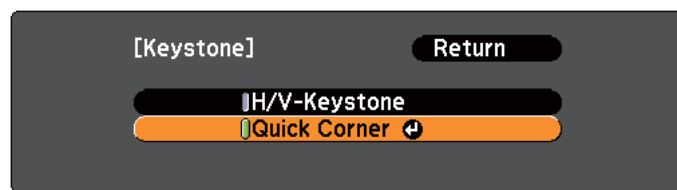

[Esc]:Return [↕]:Select [Enter]:Enter [Menu]:Exit

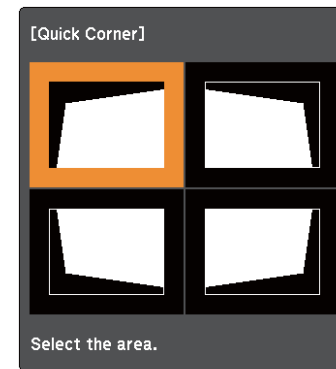

[↕/↔]:Select
[Enter]:Enter
[Esc]:Return (press for 2 seconds to reset/switch)

4 Using the [↕], [↔], [↶], and [↷] buttons on the remote control, or the [↕], [↔], [↶], and [↷] buttons on the control panel, select the corner to correct, and then press the [Enter] button.

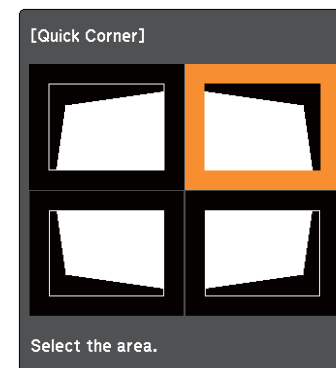

5 Using the [↖], [↘], [←], and [→] buttons on the remote control, or the [↖], [↘], [←], and [→] buttons on the control panel, correct the position of the corner.

If the triangle in the direction you are adjusting the shape turns gray, as shown in the screenshot below, you cannot adjust the shape any further in that direction.

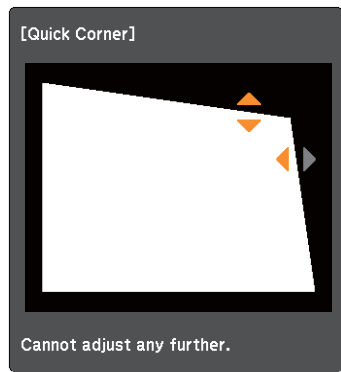

6 Repeat procedures 4 and 5 as needed to adjust any remaining corners.

7 When you are done, press the [Esc] button to exit the correction menu.

Because **Keystone** was changed to **Quick Corner**, the corner selection screen from step 3 is displayed when you press the [↖], [↘], [←], and [→] buttons on the control panel next time. Change **Keystone** to **H/V-Keystone** if you want to perform horizontal and vertical correction using the [↖], [↘], [←], and [→] buttons on the control panel.

☛ **Settings - Keystone - H/V-Keystone p.73**



- When **Auto H/V-Keystone** is set to **On**, the message "Do you want to perform Auto H/V-Keystone correction?" is displayed when the projector is moved. (EB-1775W only)

After you perform this function, the **Keystone** setting changes from **Quick Corner** to **H/V-Keystone**, after which pressing the [↖], [↘], [←], and [→] buttons on the control panel performs H/V-Keystone.

☛ **Settings - Keystone - H/V-Keystone p.73**

- If the [Esc] button is held down for about two seconds while correcting with Quick Corner, the following screen is displayed.

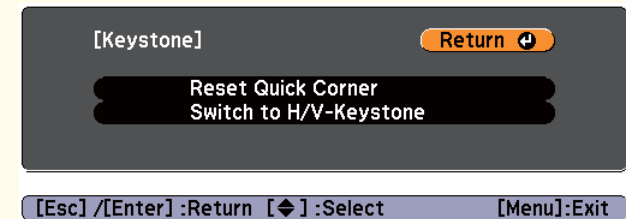

Reset Quick Corner: Resets the result of Quick Corner corrections.

Switch to H/V-Keystone: Switches the correction method to H/V-Keystone.

☛ "Settings Menu" p.73

Adjusting the Image Size

Turn the zoom ring to adjust the size of the projected image.

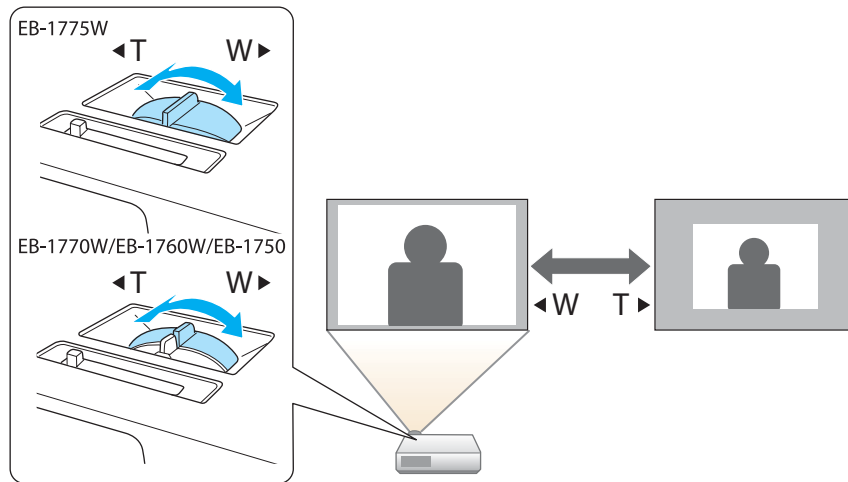

Adjusting the Image Position

Press the foot lever to extend and retract the front foot. You can adjust the position of the image by tilting the projector up to 14 degrees.

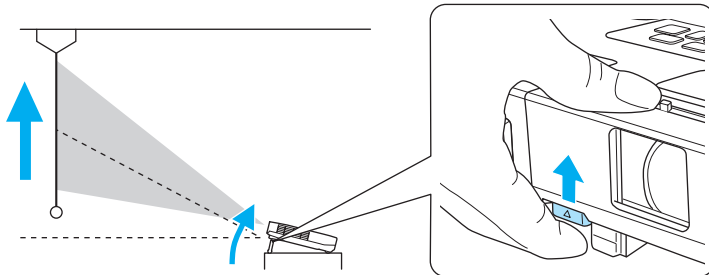

The larger the angle of tilt, the harder it becomes to focus. Install the projector so that it only needs to be tilted at a small angle.

Adjusting the Horizontal Tilt

Extend and retract the rear feet to adjust the projector's horizontal tilt.

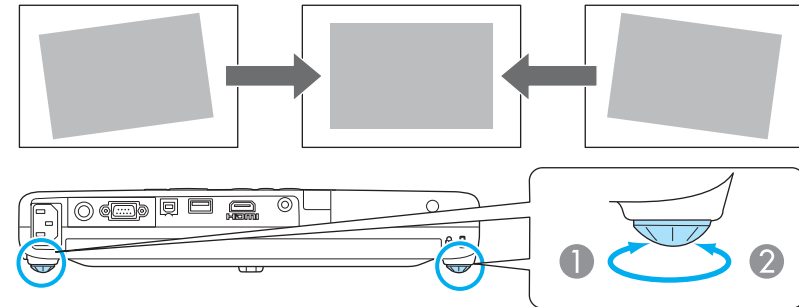

- 1 Extend the rear foot.
- 2 Retract the rear foot.

Correcting the Focus

You can correct the focus using one of the following methods.

- Press the [Focus] button on the control panel or the remote control to adjust the focus. (EB-1775W only)

- Turn the focus ring to adjust the focus. (EB-1770W/EB-1760W/EB-1750 only)

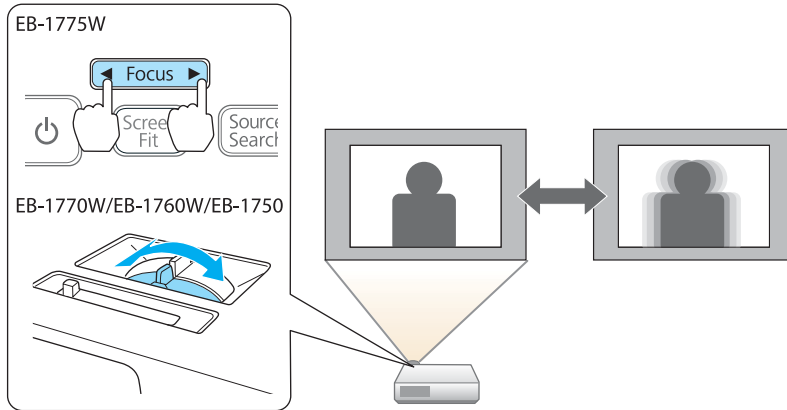

- Adjust the volume from the Configuration menu.
 ⚙️ **Settings - Volume** p.73

⚠️ Caution

Do not start at high volume.
 A sudden excessive volume may cause loss of hearing. Always lower the volume before powering off, so that you can power on and then gradually increase the volume.

Adjusting the Volume

You can adjust the volume using one of the following methods.

- Press the [Volume] buttons on the remote control to adjust the volume.

Remote control

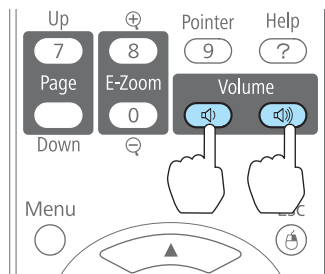

[◀️] Decreases the volume.

[▶️] Increases the volume.

Selecting the Projection Quality (Selecting Color Mode)

You can easily obtain the optimum image quality simply by selecting the setting that best corresponds to your surroundings when projecting. The brightness of the image varies depending on the mode selected.

| Mode | Application |
|---------------------|--|
| Dynamic | Ideal for use in a bright room. This is the brightest mode, and reproduces shadow tones well. |
| Presentation | Ideal for making presentations using color materials in a bright room. |
| Theatre | Ideal for watching films in a dark room. Gives images a natural tone. |
| Photo*1 | Ideal for projecting still pictures, such as photos, in a bright room. The images are vivid and brought into contrast. |
| Sports*2 | Ideal for watching TV programmes in a bright room. The images are vivid and brought to life. |
| sRGB | Ideal for images that conform to the <u>sRGB</u> color standard. |

| Mode | Application |
|-------------------|---|
| Blackboard | Even if you are projecting onto a blackboard (greenboard), this setting gives your images a natural tint, just like when projecting onto a screen. |
| Whiteboard | Ideal for making presentations using a whiteboard. |
| Customized | Select Customized if you want to adjust the R, G, B, C, M, and Y settings in the Color Adjustment submenu of the Configuration menu. |

*1 This selection is only available when the input signal is RGB or when the source is USB Display, USB, or LAN. (Depending on the model used, some sources are not supported.)

*2 This selection is only available when the input signal is component video, or when the source is Video.

Each time you press the [Color Mode] button, the Color Mode name is displayed on the screen and the Color Mode changes.

Remote control

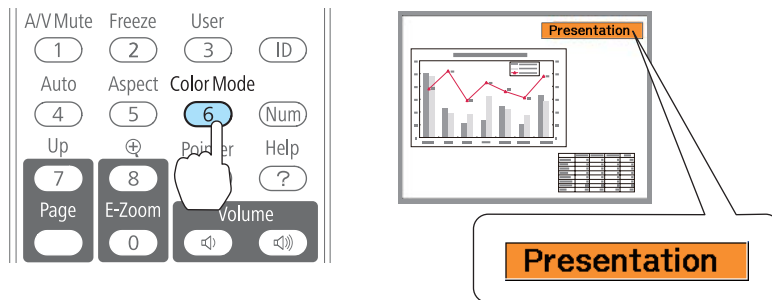

You can set Color Mode from the Configuration menu.

🖱️ **Image - Color Mode** p.70

Setting Auto Iris

By automatically setting the luminance according to the brightness of the displayed image, it lets you enjoy deep and rich images.

1 Press the [Menu] button.

🖱️ "Using the Configuration Menu" p.67

Using the remote control

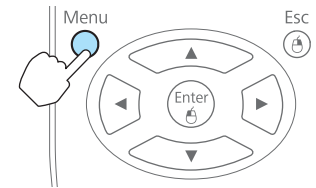

Using the control panel

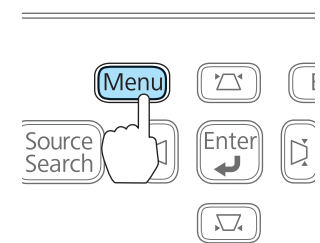

2 Select **Auto Iris** from **Image**.

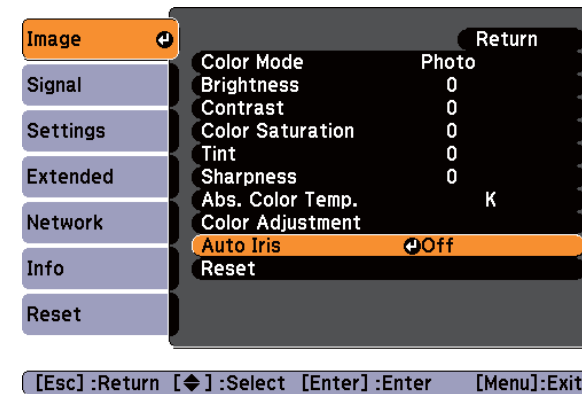

3 Select **On**.

The setting is stored for each Color Mode.

4 Press the [Menu] button to finish making settings.



Auto Iris can be set only when the **Color Mode** is **Dynamic**, **Theatre**, or **Customized**.

Changing the Aspect Ratio

Change the aspect ratio when video equipment is connected so that images that have been recorded in digital video or onto DVDs can be viewed in 16:9 wide-screen format. Change the aspect ratio when projecting computer images at full size.

Available Aspect Modes vary depending on the image signal currently being projected.

The changing methods and the types of Aspect Modes are as follows.

Changing methods

Each time you press the [Aspect] button, the Aspect Mode name is displayed on the screen and the aspect ratio changes.

Remote control

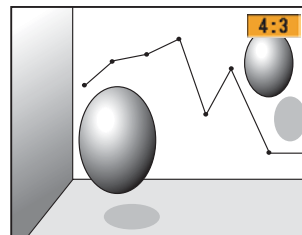
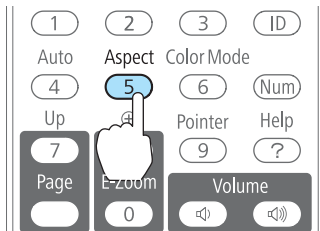

You can set the aspect ratio from the Configuration menu.

➔ **Signal - Aspect p.71**

Changing the aspect ratio for video equipment images

For EB-1775W/EB-1770W/EB-1760W

Each time the button is pressed, the aspect ratio changes in the order of **Normal** or **Auto**, **16:9**, **Full**, **Zoom**, and **Native**.

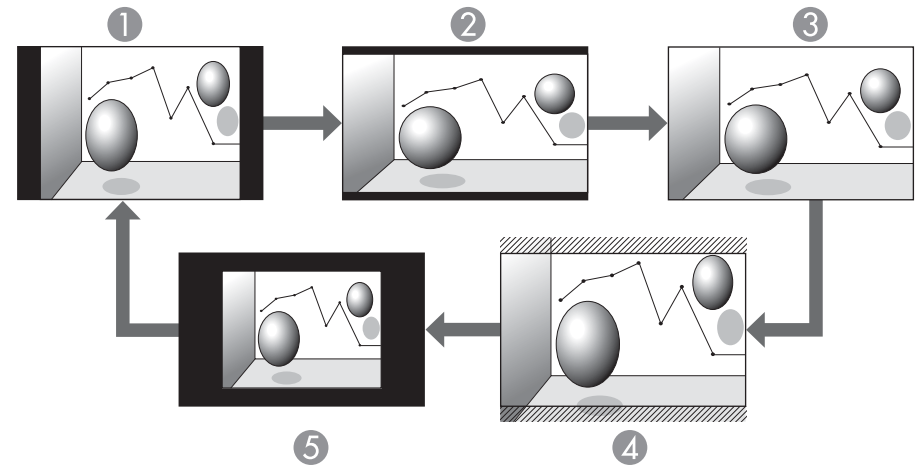

- ① Normal or Auto
- ② 16:9
- ③ Full
- ④ Zoom
- ⑤ Native

For EB-1750

Each time the button is pressed, the aspect ratio changes in the order of **Normal**, **4:3**, and **16:9**.

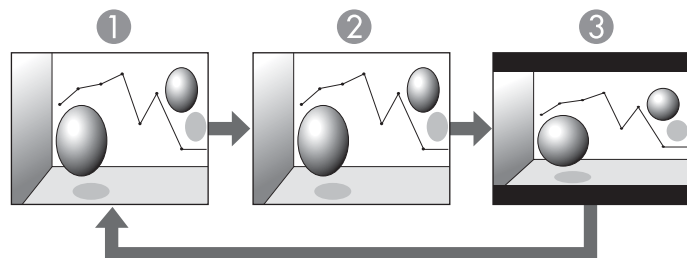

- ① Normal
- ② 4:3
- ③ 16:9

* When a 720p/1080i signal is input, the display is in a zoomed 4:3 format (the image is cut off on the right and left sides).

Changing the aspect ratio for computer images

For EB-1775W/EB-1770W/EB-1760W

Each time the button is pressed, the aspect ratio changes in the order of **Normal** or **Auto**, **16:9**, **Full**, **Zoom**, and **Native**.

| Computer Input | | Projector Aspect Setting | | | | |
|-----------------|--------------|--------------------------|------|------|------|--------|
| Resolution | Aspect Ratio | Normal/Auto* | 16:9 | Full | Zoom | Native |
| XGA (1024x768) | 4:3 | | | | | |
| WXGA (1280x800) | 16:10 | | | | | |

* Only available when the source is HDMI.

For EB-1750

Each time the button is pressed, the aspect ratio changes in the order **Normal**, **4:3**, and **16:9**.

| Computer Input | | Projector Aspect Setting | | |
|----------------|--------------|--------------------------|-----|------|
| Resolution | Aspect Ratio | Normal | 4:3 | 16:9 |
| XGA (1024x768) | 4:3 | | | |

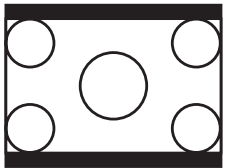
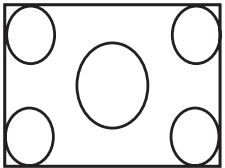
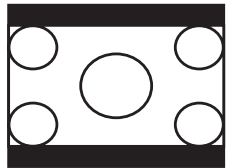
| Computer Input | | Projector Aspect Setting | | |
|-----------------|--------------|---|---|---|
| Resolution | Aspect Ratio | Normal | 4:3 | 16:9 |
| WXGA (1280x800) | 16:10 |  |  |  |



If parts of the image are missing, set the **Resolution** setting to **Wide** or **Normal** from the Configuration menu, according to the size of the computer panel.

☛ **Signal - Resolution** [p.71](#)



Useful Functions

This chapter explains useful tips for giving presentations, and the Security functions.

Projecting Without a Computer (Slideshow)

By connecting a USB storage device such as a USB memory or a USB hard disk to the projector, you can project the files stored on the device without using a computer. This function is called Slideshow.

You can make presentations with just a USB storage device and the projector by converting PowerPoint files to scenarios using the supplied EasyMP Slide Converter, and then saving them to the USB storage device.



- You may not be able to use USB storage devices that incorporate security functions.
- You cannot correct keystone distortion while projecting a Slideshow, even if you press the [Z], [V], [M], and [D] buttons on the control panel.

| Type | File Type (Ex-tension) | Notes |
|---------------|------------------------|--|
| | .png | Cannot project images with a resolution greater than 1280x800. |
| Scenario file | .fse | PowerPoint files are converted to this format in EasyMP Slide Converter. |
| | .sit | PowerPoint files are converted to this format using simplified conversion in EasyMP Slide Converter. None of the PowerPoint animation effects are converted. |



- When connecting and using a USB-compatible hard disk, make sure you connect the AC adaptor supplied with the hard disk.
- The projector does not support some file systems, so use media that has been formatted in Windows.
- Format the media in FAT16/32.

Specifications for files that can be projected using Slideshow

| Type | File Type (Ex-tension) | Notes |
|-------|------------------------|--|
| Image | .jpg | The following cannot be projected. - CMYK color mode formats - Progressive formats - Images with a resolution greater than 8192x8192 Due to the characteristics of JPEG files, images may not be projected clearly if the compression ratio is too high. |
| | .bmp | Cannot project images with a resolution greater than 1280x800. |
| | .gif | <ul style="list-style-type: none"> • Cannot project images with a resolution greater than 1280x800. • Cannot project animated GIFs. |

Slideshow examples

Projecting images stored on USB storage



☛ "Projecting the selected image" [p.48](#)

☛ "Projecting image files in a folder in sequence (Slideshow)" [p.49](#)

Projecting PowerPoint files converted in EasyMP Slide Converter

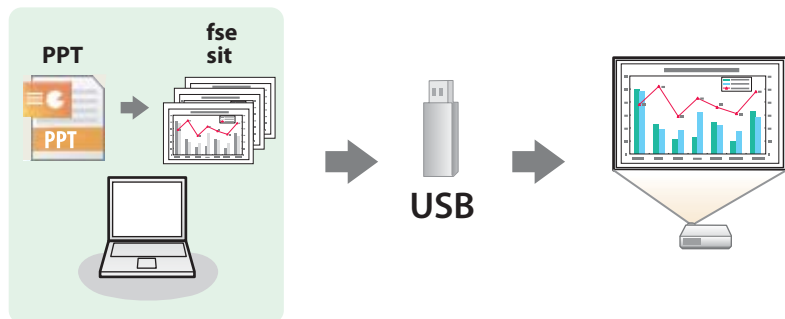

See the following manual for more information on converting PowerPoint files to scenarios using EasyMP Slide Converter.

[EasyMP Slide Converter Operation Guide](#)

Slideshow operating methods







Although the following steps are explained based on the remote control, you can perform the same operations from the control panel.

Starting Slideshow

- 1** Change the projected image to USB.
 - ☛ "Switching to the Target Image by Remote Control" [p.28](#)
- 2** Connect the USB storage device or digital camera to the projector.
 - ☛ "Connecting USB Devices" [p.23](#)

Slideshow starts and the file list screen is displayed.

- JPEG files are displayed as thumbnails (file contents are displayed as small images).
- Scenarios (FSE files and SIT files) are displayed as thumbnails as the first image in the slide.
- Other files or folders are displayed as icons as shown in the following table.

| Icon | File | Icon | File |
|---|-------------|---|-----------|
|  | FSE files* |  | BMP files |
|  | SIT files* |  | GIF files |
|  | JPEG files* |  | PNG files |

* When it cannot be displayed as a thumbnail, it is displayed as an icon.



- When AutoRun is set for a scenario, it is automatically played back with the highest priority over other input sources. If you want to stop it from playing back, press the [Esc] button on the remote control.
- You can also insert a memory card into a USB card reader and then connect the reader to the projector. However, some commercially available USB card readers may not be compatible with the projector.
- If the following screen (Select Drive screen) is displayed, press the [Up], [Down], [Left], and [Right] buttons to select the drive you want to use, and then press the [Enter] button.

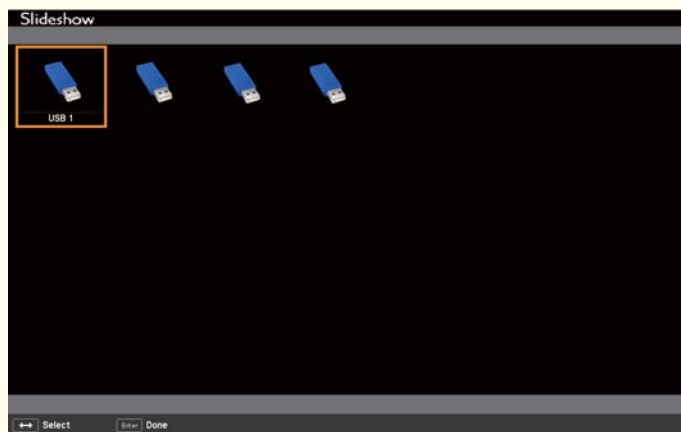

- To display the Select Drive screen, position the cursor on **Select Drive** at the top of the file list screen, and then press the [Enter] button.

Projecting images

- 1 Use the [Up], [Down], [Left], and [Right] buttons to select the file or folder you want to project.



If not all of the files and folders are displayed on the current screen, press the [Down] button on the remote control, or position the cursor on **Next Page** at the bottom of the screen and press the [Enter] button.

To return to the previous screen, press the [Up] button on the remote control, or position the cursor on **Previous Page** at the top of the screen and press the [Enter] button.

- 2 Press the [Enter] button.

The selected image is displayed.

When a folder is selected, the files in the selected folder are displayed. To return to the previous screen, position the cursor on **Back to Top** and press the [Enter] button.

Rotating images

You can rotate the played images in 90° increments. The rotating function is also available during Slideshow.

- 1 Play images, or run Slideshow.

- 2** While projecting, press the [▲] or [▼] button.

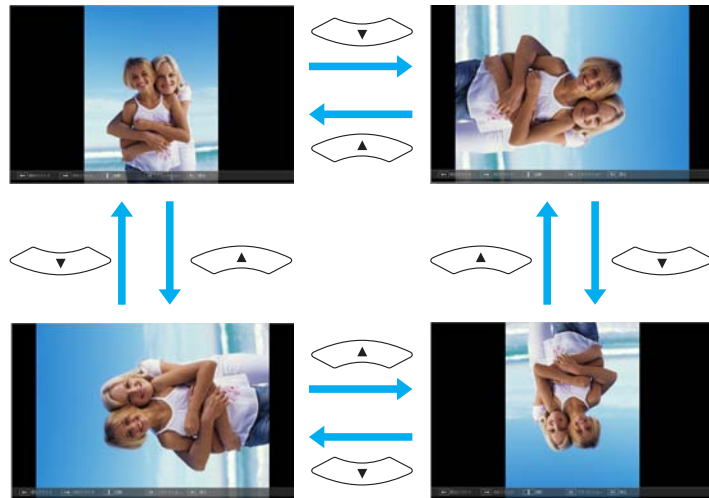

Stopping Slideshow

To close Slideshow, disconnect the USB device from the USB port on the projector. For digital cameras, hard disks, and so on, turn off the power to the device and then remove.

Projecting the selected image

Attention

Do not disconnect the USB storage device while it is being accessed. An error may occur in Slideshow.

- 1** Start Slideshow.
The file list screen is displayed.
☛ "Starting Slideshow" p.46

- 2** Press the [▲], [▼], [◀], and [▶] buttons to select the image file you want to project.



- 3** Press the [Enter] button.
The image is displayed.

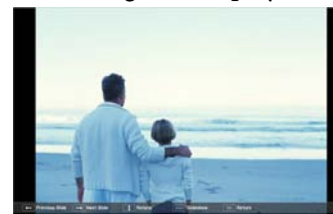

Press the [◀] [▶] buttons to move to the next or previous image file.





- 4** Press the [Esc] button to return to the file list screen.

Projecting image files in a folder in sequence (Slideshow)

You can project the image files in a folder in sequence, one at a time. This function is called Slideshow. Use the following procedure to run Slideshow.







To change files automatically when you run Slideshow, set **Screen Switching Time** from **Option** in Slideshow to anything other than **No**. The default setting is 3 seconds.

- 1** Start Slideshow.
 The file list screen is displayed.
 🖱️ "Starting Slideshow" [p.46](#)
- 2** Use the [][][][] buttons to position the cursor over the folder for the Slideshow that you want to run and press the [Enter] button.
- 3** Select **Slideshow** at the bottom right of the file list screen, and then press the [Enter] button.
 Slideshow starts, and the image files in the folder are automatically projected in sequence, one at a time.
 When the last file is projected, the file list is displayed again automatically. If you set **Continuous Play** to **On** in the Option window, projection starts again from the beginning again when it reaches the end.
 🖱️ "Image file display settings and Slideshow operation settings" [p.50](#)
 You can proceed to the next screen, return to the previous screen, or stop playback while projecting a Slideshow.



If **Screen Switching Time** on the **Option** screen is set to **No**, files do not change automatically when you select Play Slideshow. Press the [] button, the [Enter] button, or the [Down] button on the remote control to continue to the next file.

Playing a scenario

- 1** Start Slideshow.
 The file list screen is displayed.
 🖱️ "Starting Slideshow" [p.46](#)
- 2** Press the [], [], [], and [] buttons to select the scenario you want to playback.
- 3** Press the [Enter] button.
 Playback starts.

Operating procedures during scenario playback

Screen switching

For FSE files

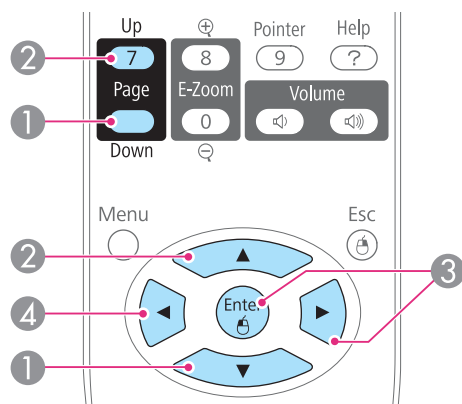

- ① Next Slide
- ② Previous Slide
- ③ Next Slide or Animation
- ④ Previous Slide or Animation

The following functions can be used when projecting a scenario or image file with Slideshow.

- Freeze
 - ☛ "Freezing the Image (Freeze)" [p.52](#)
- A/V Mute
 - ☛ "Hiding the Image and Sound Temporarily (A/V Mute)" [p.51](#)
- E-Zoom
 - ☛ "Enlarging Part of the Image (E-Zoom)" [p.53](#)



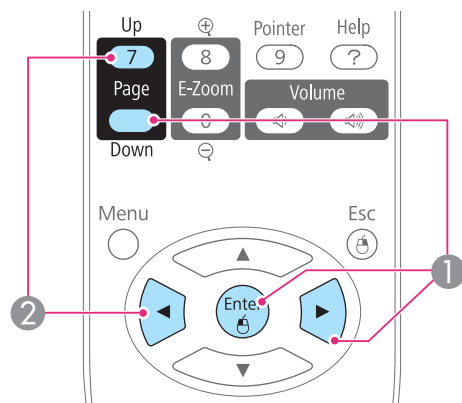

For SIT files



- ① Next Slide
- ② Previous Slide

Image file display settings and Slideshow operation settings

You can set the file display order and Slideshow operations on the Option screen.

1 Press the [] [] [] [] buttons to position the cursor over the folder where you want to set display conditions and press the [Esc] button. Select **Option** from the submenu displayed, then press the [Enter] button.

2 When the following Option screen is displayed, set each of the items.

Enable settings by positioning the cursor on the target item and pressing the [Enter] button.

The following table shows the details for each item.

Stopping playback

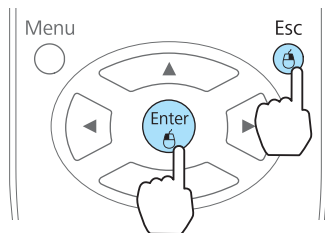

The message "Do you want to quit playing the scenario?" is displayed when you press the [Esc] button. Close by selecting **Exit** and pressing the [Enter] button.

Continue playback by selecting **Return** and pressing the [Enter] button.



| | |
|------------------------------|---|
| Display Order | You can select to display the files in Name Order or Date Order . |
| Sort Order | You can select to sort the files In Ascending or In Descending order. |
| Continuous Play | You can set whether to repeat the Slideshow. |
| Screen Switching Time | You can set the time for a single file to be displayed in Play Slideshow. You can set a time between No (0) to 60 Seconds. When you set No , auto play is disabled. |
| Effect | You can set the screen effects when changing slides. |

3 When you have finished making settings, use the [Up], [Down], [Left], and [Right] buttons to position the cursor over **OK** and press [Enter].

The settings are applied.

If you do not want to apply the settings, position the cursor on **Cancel** and press the [Enter] button.

Hiding the Image and Sound Temporarily (A/V Mute)

You can use this when you want to focus the audience's attention on what you are saying, or if you do not want to show details such as when you are changing between files during presentations from a computer.

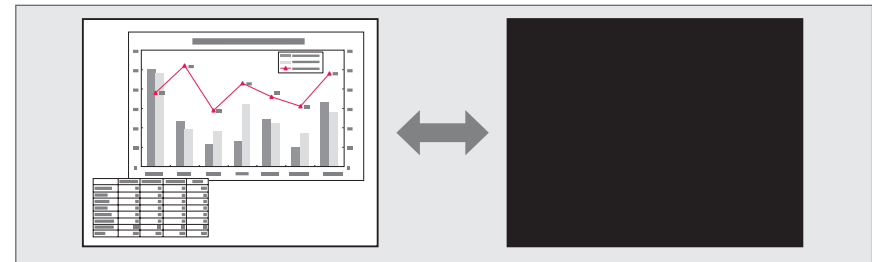

Each time you press the [A/V Mute] button, or open/close the lens cover A/V Mute turns on or off.

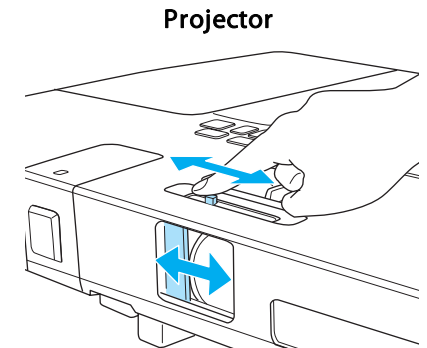
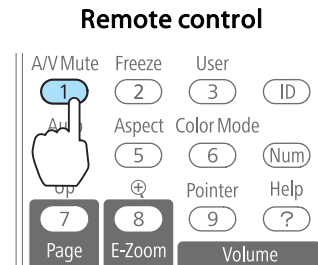



- If you use this function when projecting moving images, the images and sound continue to be played back by the source, and you cannot return to the point where A/V Mute was activated.
- You can select the screen displayed when the [A/V Mute] button is pressed from the Configuration menu.
 - ☛ **Extended - Display - A/V Mute p.74**
- When the A/V mute slide is closed for approximately 30 minutes, Lens Cover Timer activates and the power is automatically turned off. If you do not want Lens Cover Timer to activate, set **Lens Cover Timer to Off**.
 - ☛ **Extended - Operation - Lens Cover Timer p.74**
- The lamp is still lit during A/V Mute, so the lamp hours continue to accumulate.



- Audio does not stop.
- For moving images, the images continue to play back while the screen is frozen, so it is not possible to resume projection from the point where the screen was frozen.
- If the [Freeze] button is pressed while the Configuration menu or the Help screen is displayed, the menu or the Help screen that is displayed is closed.
- Freeze still works while E-Zoom is being used.

Freezing the Image (Freeze)

When Freeze is activated on moving images, the frozen image continues to project on the screen, so you can project a moving image one frame at a time like a still photo. Also, you can perform operations such as changing between files during presentations from a computer without projecting any images if the Freeze function is activated beforehand.

Each time you press the [Freeze] button, Freeze turns on or off.

Remote control

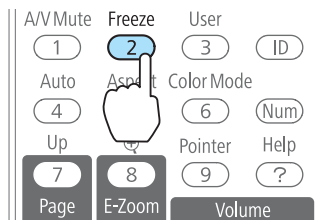

Pointer Function (Pointer)

This allows you to move a Pointer icon on the projected image, and helps you draw attention to the area you are talking about.

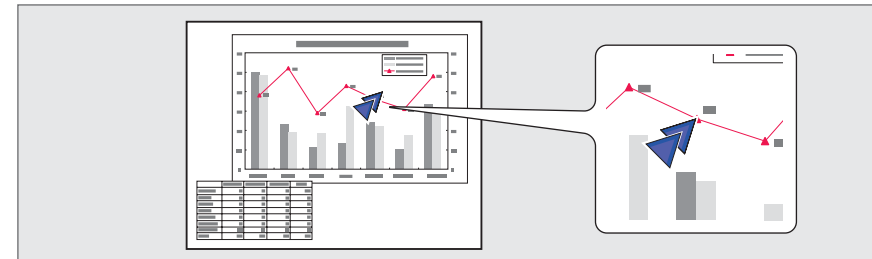

1 Display the Pointer.

Each time you press the [Pointer] button, the pointer appears or disappears.

Remote control

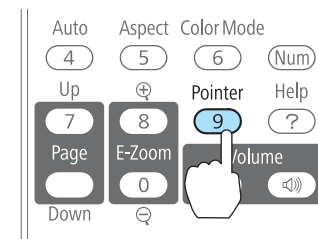

2 Move the Pointer icon (↗).

Remote control

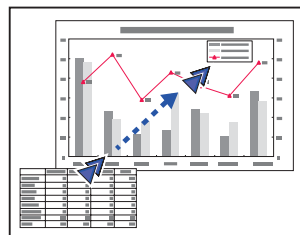
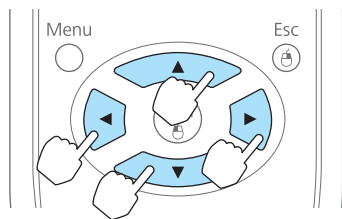

When pressed in conjunction with the adjacent [↖], [↘], [↙], and [↗] buttons, the pointer can be moved diagonally.



You can use **Pointer Shape** to set the shape of the pointer icon.

🖱️ **Settings - Pointer Shape** [p.73](#)

Enlarging Part of the Image (E-Zoom)

This is useful when you want to expand images to see them in greater detail, such as graphs and tables.

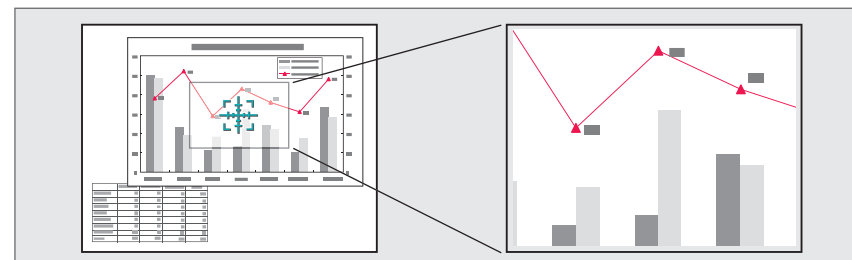

1 Start E-Zoom.

Press the [⊕] button to display the Cross (⊕).

Remote control

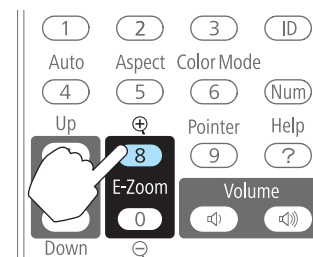

- 2** Move the Cross (⊕) to the area of the image that you want to enlarge.

Remote control

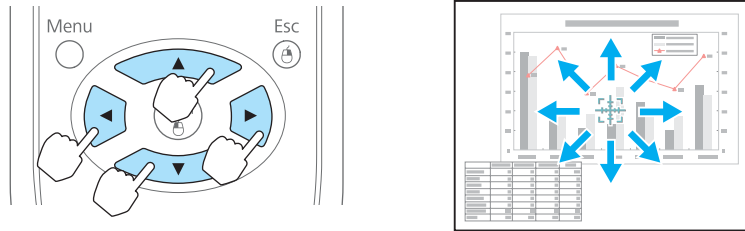

When pressed in conjunction with the adjacent [↑], [↓], [←], and [→] buttons, the pointer can be moved diagonally.

- 3** Enlarge.

Remote control

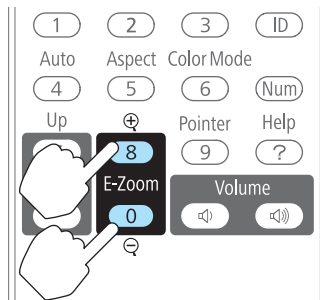

[⊕] button: Expands the area each time it is pressed. You can expand quickly by holding the button down.

[⊖] button: Reduces images that have been enlarged.

[Esc] button: Cancels E-Zoom.

- The enlargement ratio appears on the screen. The selected area can be enlarged to between 1 to 4 times in 25 incremental steps.
- During enlarged projection, press the [↑], [↓], [←], and [→] buttons to scroll the image.
- If E-Zoom is selected, **Progressive** and **Noise Reduction** are cancelled.

Using the Remote Control to Operate the Mouse Pointer (Wireless Mouse)

When the USB port of a computer and the USB (TypeB) port on the projector are connected with the supplied USB cable, you can use the remote control to control the computer's mouse pointer.

This is only available when the source is Computer or HDMI (EB-1775W/EB-1770W/EB-1760W only).

☛ "Connecting a Computer" [p.21](#)

To activate the Wireless Mouse function, set **USB Type B** to **Link 21L**. By default, **USB Type B** is set to **USB Display**. Change the setting beforehand.

☛ **Extended - USB Type B** [p.74](#)

The following operating systems are compatible with Wireless Mouse.

| | Windows | Mac OS |
|-----------|---------------|-----------------|
| OS | Windows 98 | Mac OS X 10.3.x |
| | Windows 98SE | Mac OS X 10.4.x |
| | Windows Me | Mac OS X 10.5.x |
| | Windows 2000 | Mac OS X 10.6.x |
| | Windows XP | |
| | Windows Vista | |
| | Windows 7 | |

* It may not be possible to use the Wireless Mouse function under some versions of the operating systems.

Once the connection has been made, the mouse pointer can be operated as follows.

Moving the mouse pointer

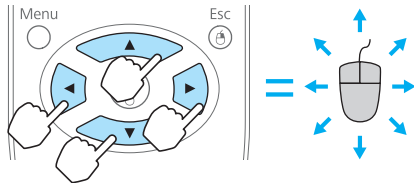

[Up] [Down] [Left] [Right] buttons:
Moves the mouse pointer.

Mouse clicks

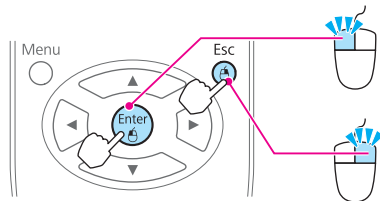

[Enter] button: Left click. Press quickly twice to double-click.

[Esc] button: Right click.

Drag and drop

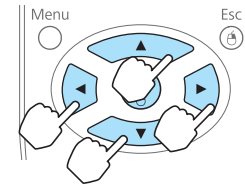

While holding down the [Enter] button, press the [Up], [Down], [Left], and [Right] buttons.

Release the [Enter] button to drop at the desired location.



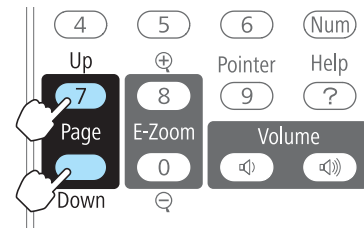

Page Up/Down



[Up] button: Moves to the previous page.

[Down] button: Moves to the next page.









- When pressed in conjunction with the adjacent [, [, [, and [] buttons, the pointer can be moved diagonally.
- If the mouse button settings are set to reverse on the computer, the operation of the remote control buttons will also be reversed.
- The Wireless Mouse function cannot be used while the following functions are being used.
 - While the Configuration menu is being displayed
 - While a help menu is being displayed
 - While the E-Zoom function is being used
 - While a user's logo is being captured
 - While a pointer function is being used
 - While adjusting sound volume
 - While USB Display is being operated
 - While displaying a Test Pattern
 - While Color Mode is being set
 - While Color Mode name is being displayed
 - While the Source name is being displayed
 - While switching input source

Setting the ID and Using the Remote Control

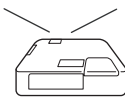
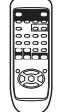
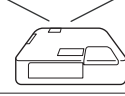
When an ID is set for the projector and the remote control, you can use the remote control to operate only the projector with a matching ID. This is useful when managing multiple projectors.

You can set an ID for the projector within a range of "1" to "9". The default value is Off.

You can set an ID for the remote control within a range of "0" to "9". The default value is "0". The following table shows the possible combinations of Projector ID and remote control ID.

| Operation | Combinations | | Descriptions |
|--------------|---|----------------------|--|
| Possible |  | Projector ID: 1 | The projector ID and the remote control ID are identical, therefore you can operate the projector with the remote control. |
| |  | Remote control ID: 1 | |
| Possible |  | Projector ID: Off | When the Projector ID is Off, you can operate with the remote control regardless of the remote control ID setting. |
| |  | Remote control ID: 1 | |
| Possible |  | Projector ID: 1 | When the remote control ID is "0", you can operate with the remote control regardless of the Projector ID setting. |
| |  | Remote control ID: 0 | |
| Not possible |  | Projector ID: 1 | The Projector ID and the remote control ID do not match, therefore you cannot operate the projector with the remote control. |
| |  | Remote control ID: 3 | |

Setting the Projector ID

- 1 Press the [Menu] button while projecting.
 ☛ "Using the Configuration Menu" p.67

Using the remote control

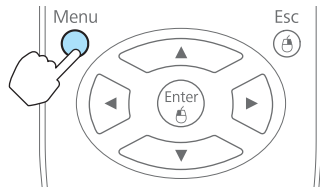

Using the control panel

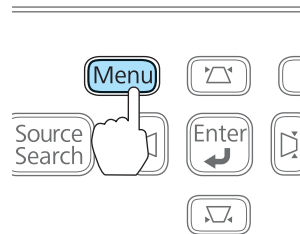

- 2 Select **Projector ID** from **Extended**.

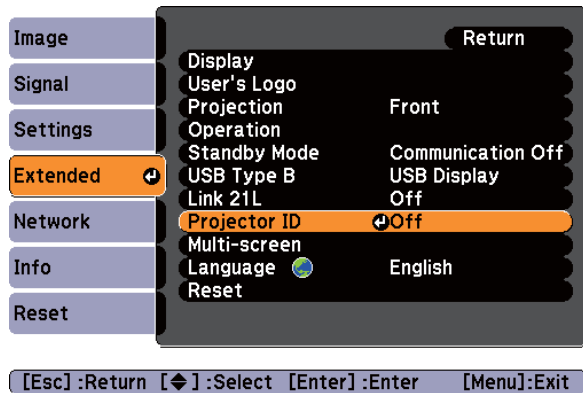

- 3 Choose the ID you want to set and press the [Enter] button.

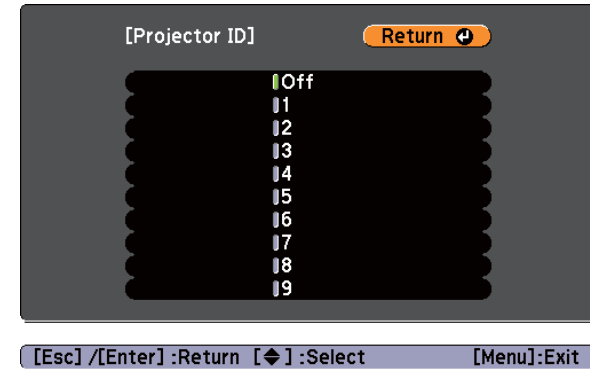

- 4 Press the [Menu] button to finish making settings.

Setting the remote control ID

Set the ID on the remote control each time you switch the projector power on. When the projector is powered on, the remote control ID is set to "0" (that is, you can operate the projector with the remote control regardless of the projector ID).

- 1 Point the remote control at the remote receiver of the target projector and press the [ID] button on the remote control.

When you press the [ID] button, the current Projector ID is displayed on the projection screen. It disappears in about three seconds.

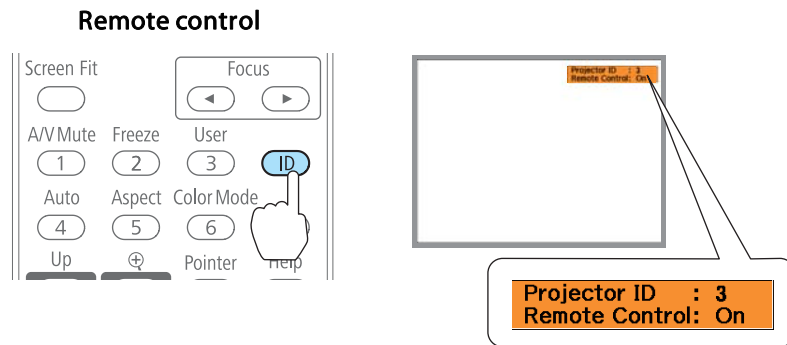

- 2 While holding the [ID] button, press the number button that matches the ID of the projector you want to operate.

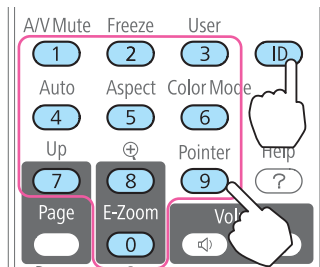

Once this setting has been made, the projector that can be operated by the remote control is limited.



When you power off the projector, the remote control ID is reset to "0" (that is, you can operate the projector with the remote control regardless of the projector ID).

Correcting Color when Projecting from Multiple Projectors

When multiple projectors are lined up and projecting images, you can correct the brightness and color tone of each projector's image with multi-screen color adjustment so that the colors of images from each projector match closely.



In some cases the brightness and color tone may not match completely even after correction.

Summary of correction procedure

When multiple projectors are set up and you need to make corrections, use the following procedure to correct one projector at a time.

1. **Set the projector ID and the remote control ID.**

Set a projector ID for the target projector, then set the same ID for the remote control, so that you can limit the operation to one target projector.

☞ "Setting the ID and Using the Remote Control" [p.56](#)

2. **Correct the color difference.**

You can carry out color correction when projecting from multiple projectors. You can adjust from black to white in five stages called levels 1 to 5, and in each of these 5 levels you can adjust the following two points.

- Correcting brightness
You can correct the image brightness to make them all equal.
- Correcting color
You can correct the image color so that they match closely.

Correcting

After setting up the projectors, correct the brightness and tone for each projector to reduce the differences.

- 1 Press the [Menu] button.
 - ☛ "Using the Configuration Menu" p.67

- 2 Select **Multi-screen** from **Extended**.

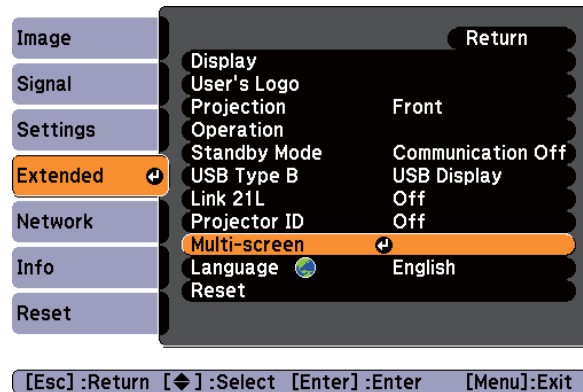

- 3 Select the level to be corrected in **Adjustment Level**.

- Each time a level is selected, the pattern of the level selected is displayed.
- You can start correcting from any level, usually you can make it darker or lighter by correcting 1 to 5 or 5 to 1.

- 4 Correct the brightness with **Brightness Correct**.

- When you select **Level 5**, all the images are adjusted to the darkest image from multiple projectors.
- When you select **Level 1**, all the images are adjusted to the brightest image from multiple projectors.
- When you select **Level 2 to Level 4**, all the images are adjusted to the mid-range brightness image from multiple projectors.
- Because each time the [Enter] button is pressed the image displayed changes between the pattern display and the actual image, you can check the correction results and make corrections in the actual image.

- 5 Correct the **Color Correct. (G/R)** and **Color Correct. (B/Y)** settings.

- 6 Repeat procedures 3 to 5 until corrections are finished.

- 7 When all corrections are finished, press the [Menu] button to finish making settings.

Saving a User's Logo

You can save the image that is currently being projected as a User's Logo.



Once a User's Logo has been saved, the logo cannot be returned to the factory default.

- 1 Project the image you want to save as the User's Logo, and then press the [Menu] button.

☛ "Using the Configuration Menu" p.67

Using the remote control

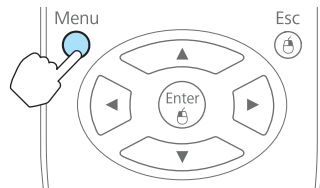

Using the control panel

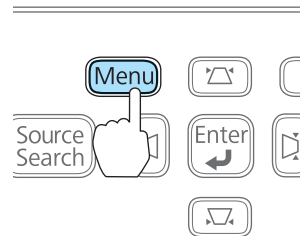

- 2 Select **User's Logo** from **Extended**.

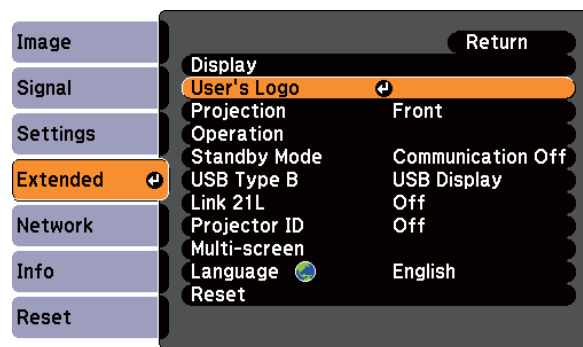

[Esc] :Return [↔] :Select [Enter] :Enter [Menu] :Exit



- When **User's Logo Protect** from **Password Protect** is set to **On**, a message is displayed and the User's Logo cannot be changed. You can make changes after setting **User's Logo Protect** to **Off**.

☛ "Managing Users (Password Protect)" p.62

- If **User's Logo** is selected when Keystone, E-Zoom, Aspect, Progressive, or Zoom are being performed, the function currently being performed is cancelled.

- 3 When the message "Choose this image as the User's Logo?" is displayed, select **Yes**.



When you press the [Enter] button on the remote control or the control panel, the screen size may change depending on the signal to match the actual resolution of the image signal.

- 4 Move the box to select the part of the image to use as the User's Logo.

You can perform the same operations from the projector's control panel.

Remote control

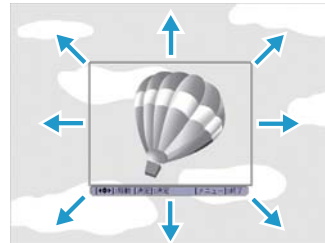
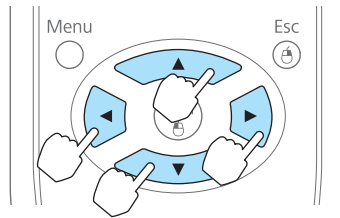

You can save at 400x300 dots in size.

- 5** When you press the [Enter] button and the message "Select this image?" is displayed, select **Yes**.

- 6** Select the zoom factor from the zoom setting screen.

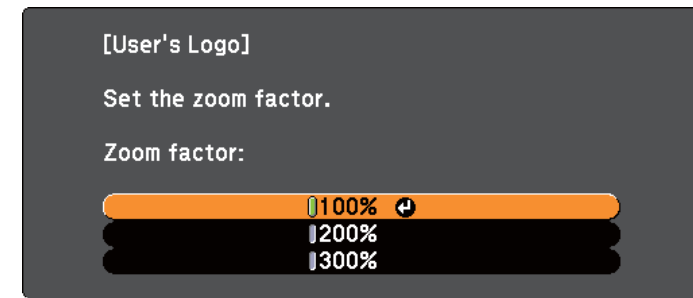

[Esc]:Return [◆]:Select [Enter]:Set [Menu]:Exit

- 7** When the message "Save this image as the User's Logo?" is displayed, select **Yes**.

The image is saved. After the image has been saved, the message "Completed." is displayed.



- When a User's Logo is saved, the previous User's Logo is erased.
- Saving the User's Logo may take approximately 15 seconds. Do not operate the projector or any connected equipment while it is saving, otherwise malfunctions may occur.

The projector has the following enhanced security functions.

- **Password Protect**
You can limit who can use the projector.
- **Control Panel Lock**
You can prevent people changing the settings on the projector without permission.
☛ "Restricting Operation (Control Panel Lock)" [p.64](#)
- **Anti-Theft Lock**
The projector is equipped with the following anti-theft security device.
☛ "Anti-Theft Lock" [p.65](#)

Managing Users (Password Protect)

When Password Protect is activated, people who do not know the password cannot use the projector to project images even if the projector power is on. Furthermore, the user's logo that is displayed when you turn on the projector cannot be changed. This acts as an anti-theft device as the projector cannot be used even if it is stolen. At the time of purchase, Password Protect is not activated.

Kinds of Password Protect

The following three kinds of Password Protect settings can be made according to how the projector is being used.

- **Power On Protect**
When **Power On Protect** is **On**, you need to enter a preset password after the projector is plugged in and turned on (this also applies to Direct Power On). If the correct password is not entered, projection does not start.

- **User's Logo Protect**

Even if someone tries to change the User's Logo set by the owner of the projector, it cannot be changed. When **User's Logo Protect** is set to **On**, the following setting changes for the User's Logo are prohibited.

- Capturing a User's Logo
- Setting **Display Background**, **Startup Screen**, or **A/V Mute** from **Display**
☛ **Extended - Display** [p.74](#)
- **Network Protect** (EB-1775W/EB-1770W/EB-1760W only)
When **Network Protect** is set to **On**, changing the settings for **Network** is prohibited.
☛ "Network Menu (EB-1775W/EB-1770W/EB-1760W Only)" [p.76](#)

Setting Password Protect

Use the following procedure to set Password Protect.

- 1 During projection, hold down the [Freeze] button for about five seconds.

The Password Protect setting menu is displayed.

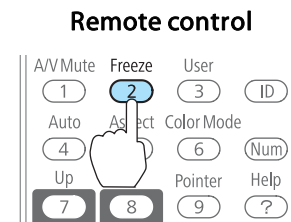



- If Password Protect is already activated, you must enter the password.
If the password is entered correctly, the Password Protect setting menu is displayed.
- "Entering the Password" p.63
- When the password is set, stick the supplied password protect sticker in a visible position on the projector as a further theft deterrent.

- 2** Select the type of Password Protect you want to set, and then press the [Enter] button.

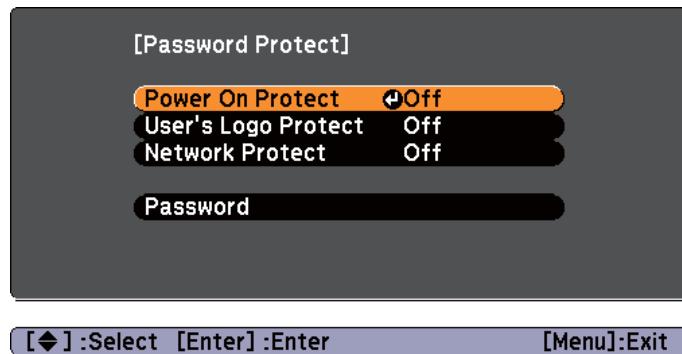

- 3** Select **On**, and then press the [Enter] button.
Press the [Esc] button, the screen displayed in step 2 is displayed again.

- 4** Set the password.
- (1) Select **Password**, and then press the [Enter] button.
 - (2) When the message "Change the password?" is displayed, select **Yes** and then press the [Enter] button. The default password is set to "0000". Change this to your own desired password. If you select **No**, the screen displayed in step 2 is displayed again.

- (3) While holding down the [Num] button, enter a four digit number using the numeric buttons. The number entered is displayed as "****". When you enter the fourth digit, the confirmation screen is displayed.

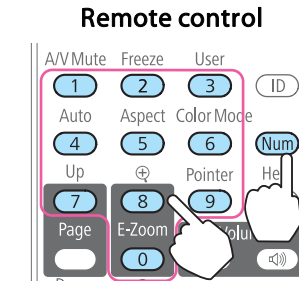

- (4) Re-enter the password.
The message "Password accepted." is displayed.
If you enter the password incorrectly, a message is displayed prompting you to re-enter the password.

Entering the Password

When the password entry screen is displayed, enter the password using the numeric buttons on the remote control.

While holding down the [Num] button, enter the password by pressing the numeric buttons.

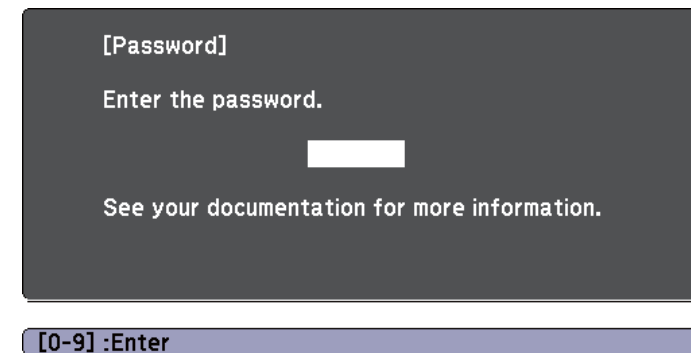

When you enter the correct password, Password Protect is temporarily released.

Attention

- If an incorrect password is entered three times in succession, the message "The projector's operation will be locked." is displayed for approximately five minutes, and then the projector switches to standby mode. If this happens, disconnect the power plug from the electrical outlet and then reinsert it and turn the projector's power back on. The projector displays the password entry screen again so that you can enter the correct password.
- If you have forgotten the password, make a note of the "Request Code: xxxxx" number that appears on the screen and contact the nearest address provided in the *Epson Projector Contact List*.
[Epson Projector Contact List](#)
- If you continue to repeat the above operation and input the wrong password thirty times in succession, the following message is displayed and the projector does not accept any more password entries. "The projector's operation will be locked." "Contact Epson as described in your documentation."
[Epson Projector Contact List](#)

Restricting Operation (Control Panel Lock)

Perform one of the following to lock the operation buttons on the control panel.

- Full Lock
All of the buttons on the control panel are locked. You cannot perform any operations from the control panel, including turning the power on or off.
- Partial Lock
All of the buttons on the control panel, except for the [⏻] button, are locked.

This is useful at events or shows when you want to deactivate all buttons during projection or at schools when you want to limit button operation. The projector can still be operated using the remote control.

- 1 Press the [Menu] button while projecting.

"Using the Configuration Menu" p.67

Using the remote control

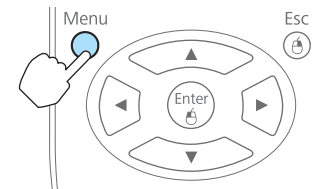

Using the control panel

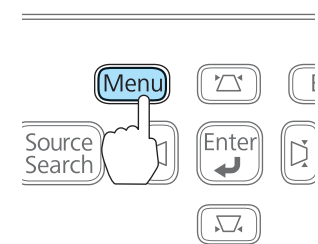

- 2 Select **Control Panel Lock** from **Settings**.

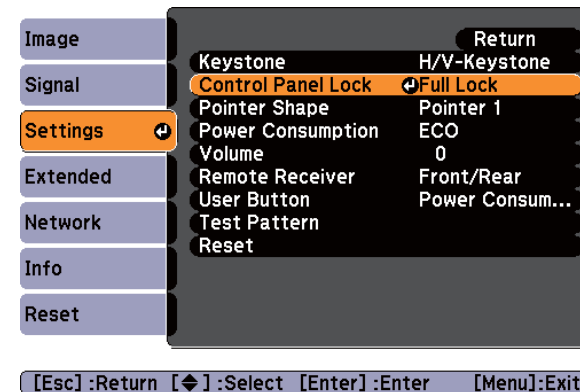

- 3 Select either **Full Lock** or **Partial Lock** according to your purpose.

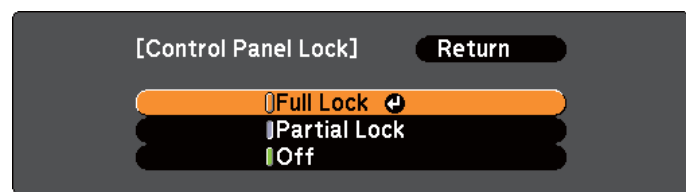

- 4** Select **Yes** when the confirmation message is displayed.
The control panel buttons are locked according to the setting you chose.



You can release the control panel lock by one of the following two methods.

- Select **Off** from **Control Panel Lock**.
 👉 **Settings - Control Panel Lock** p.73
- Press and hold down the [Enter] button on the control panel for about seven seconds, a message is displayed and the lock is released.

Anti-Theft Lock

As an anti-theft measure, the projector is equipped with a security slot compatible with the Microsaver Security System manufactured by Kensington.

See the following for more details on the Microsaver Security System.

👉 <http://www.kensington.com/>



Configuration Menu

This chapter explains how to use the Configuration menu and its functions.

This section explains how to use the Configuration menu.

Although steps are explained using the remote control as an example, you can perform the same operations from the control panel. Check the guide under the menu for the available buttons and their operations.

1 Display the Configuration menu screen.

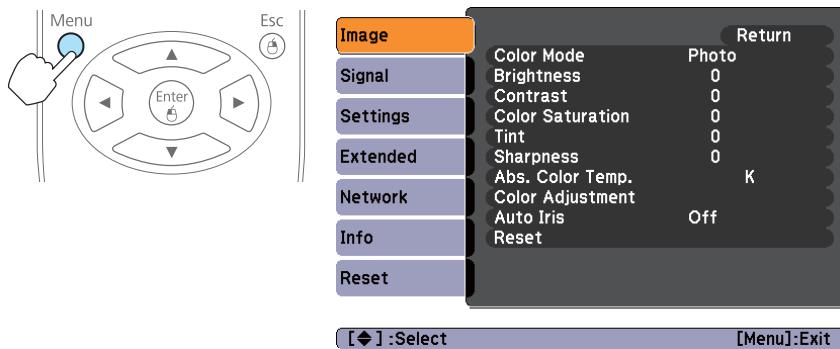

2 Select a top menu item.

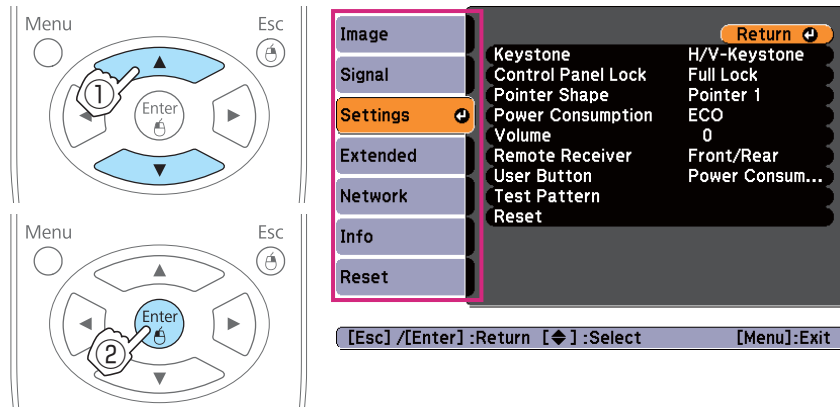

3 Select a submenu item.

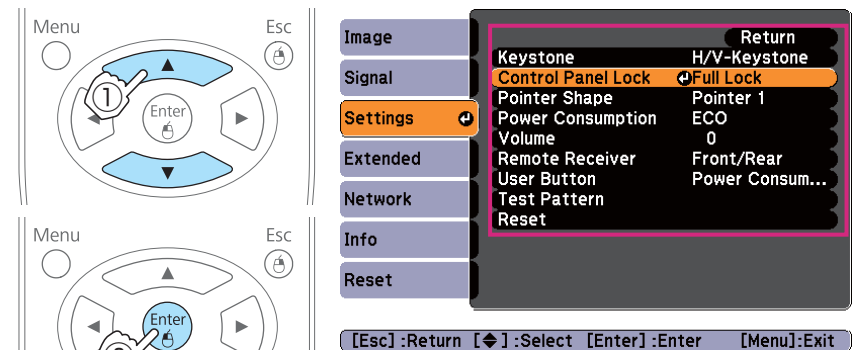

4 Change settings.

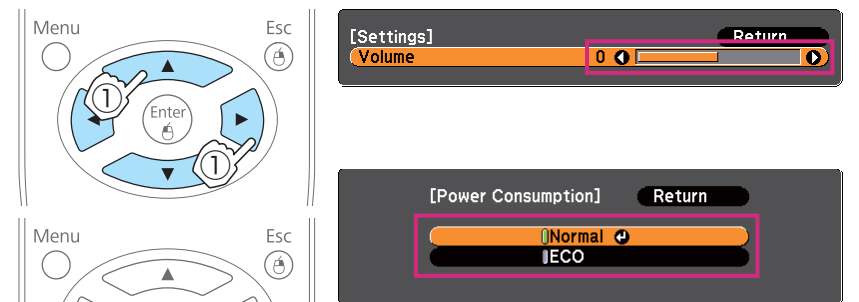

5 Press the [Menu] button to finish making settings.

Configuration Menu Table

Settable items vary depending on the model being used and the image signal and source being projected.

| Top Menu Name | Submenu Name | Setting Values |
|-----------------------|--------------------------|---|
| Image menu ☛ p.70 | Color Mode | Dynamic, Presentation, Theatre, Photo, sRGB, Blackboard, Whiteboard, and Customized |
| | Brightness | -24 to 24 |
| | Contrast | -24 to 24 |
| | Color Saturation | -32 to 32 |
| | Tint | -32 to 32 |
| | Sharpness | -5 to 5 |
| | Abs. Color Temp. | 5000K to 10000K |
| | Color Adjustment | R: -16 to 16 G: -16 to 16 B: -16 to 16 |
| Auto Iris | On and Off | |
| Signal menu ☛ p.71 | Auto Setup | On and Off |
| | Resolution | Auto, Wide, and Normal |
| | Tracking | 1216 to 1470 |
| | Sync. | 0 to 31 |
| | Position | Up, Down, Left, and Right |
| | Progressive | Off, Video, and Film/Auto |
| | Noise Reduction | Off, NR1, and NR2 |
| | HDMI Video Range | Auto, Normal, and Expanded |
| Input Signal | Auto, RGB, and Component | |

| Top Menu Name | Submenu Name | Setting Values |
|-------------------------|--------------------|---|
| | Video Signal | Auto, NTSC, NTSC4.43, PAL, M-PAL, N-PAL, PAL60, and SECAM |
| | Aspect | Normal, 4:3, 16:9, Full, Zoom, and Native |
| | Overscan | Auto, Off, 4%, and 8% |
| Settings menu ☛ p.73 | Keystone | H/V-Keystone and Quick Corner |
| | Control Panel Lock | Full Lock, Partial Lock, and Off |
| | Pointer Shape | Pointer 1, 2, and 3 |
| | Power Consumption | Normal and ECO |
| | Volume | 0 to 20 |
| | Remote Receiver | Front/Rear, Front, Rear and Off |
| | User Button | Power Consumption, Info, Progressive, Test Pattern, Multi-screen, and Resolution |
| Test Pattern | - | |
| Extended menu ☛ p.74 | Display | Messages, Display Background, Startup Screen, and A/V Mute |
| | User's Logo | - |
| | Projection | Front, Front/Ceiling, Rear, and Rear/Ceiling |
| | Operation | Direct Power On, Sleep Mode, Sleep Mode Timer, Lens Cover Timer, and High Altitude Mode |
| | Standby Mode | Communication On and Communication Off |
| | USB Type B | USB Display and Link 21L |
| | Link 21L | On and Off |
| | Projector ID | Off and 1 to 9 |

| Top Menu Name | Submenu Name | Setting Values |
|----------------------|------------------|---|
| | Multi-screen | Adjustment Level, Brightness Correct., Color Correct. (G/R), and Color Correct. (B/Y) |
| | Language | 15 or 35 languages*1 |
| Info menu ☛ p.84 | Lamp Hours | - |
| | Source | - |
| | Input Signal | - |
| | Resolution | - |
| | Video Signal | - |
| | Refresh Rate | - |
| | Sync Info | - |
| | Status | - |
| | Serial Number | - |
| | Event ID | - |
| Reset menu ☛ p.84 | Reset All | - |
| | Reset Lamp Hours | - |

*1 The number of supported languages differs depending on the region where the projector is purchased.

Network menu (EB-1775W/EB-1770W/EB-1760W only)

| Top Menu Name | Submenu Name | Setting Values |
|-----------------------------|----------------------|--------------------|
| Basic menu ☛ p.78 | Projector Name | - |
| | PJLink Password | - |
| | Web Control Password | - |
| | Projector Keyword | On and Off |
| Wireless LAN menu ☛ p.79 | Wireless LAN Power | On and Off |
| | Connection Mode | Quick and Advanced |

| Top Menu Name | Submenu Name | Setting Values |
|-------------------------|--|--|
| | Channel | 1ch, 6ch, and 11ch |
| | Wireless LAN system | 802.11b/g and 802.11b/g/n |
| | SSID Auto Setting | On and Off |
| | SSID | - |
| | IP Settings | DHCP, IP Address, Subnet Mask, and Gateway Address |
| | SSID Display | On and Off |
| | IP Address Display | On and Off |
| Security menu ☛ p.80 | Security | None, WEP, WPA-PSK, and WPA2-PSK |
| | WEP Encryption | 128Bit and 64Bit |
| | Format | ASCII and HEX |
| | Key ID | 1, 2, 3, 4 |
| | Encryption Key 1, Encryption Key 2, Encryption Key 3, and Encryption Key 4 | - |
| | Authentication Type | Open and Shared |
| | PSK | - |
| | | |
| Mail menu ☛ p.82 | Mail Notification | On and Off |
| | SMTP Server | - |
| | Port Number | - |
| | Address 1 Setting, Address 2 Setting, and Address 3 Setting | - |
| Others menu ☛ p.82 | SNMP | On and Off |
| | Trap IP Address 1 and Trap IP Address 2 | - |
| | AMX Device Discovery | On and Off |

Image Menu

Settable items vary depending on the image signal and source currently being projected. Setting details are saved for each image signal.

☛ "Automatically Detect Input Signals and Change the Projected Image (Source Search)" [p.27](#)

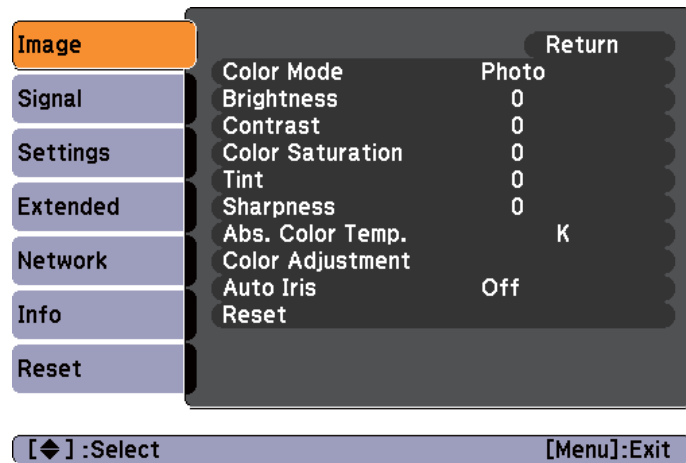

| Submenu | Function |
|-------------------------|--|
| Color Mode | You can select the quality of the image to suit your surroundings. ☛ "Selecting the Projection Quality (Selecting Color Mode)" p.38 |
| Brightness | You can adjust the image brightness. |
| Contrast | You can adjust the difference between light and dark in the images. |
| Color Saturation | You can adjust the color saturation for the images. |
| Tint | (Adjustment is only possible when NTSC signals are being input if you use composite video signals.) You can adjust the image tint. |

| Submenu | Function |
|-------------------------|--|
| Sharpness | You can adjust the image sharpness. |
| Abs. Color Temp. | (This item cannot be selected if Color Mode is set to sRGB ▶.) You can adjust the overall tint of the image. You can adjust tints in 10 stages from 5000 K to 10000 K. The image is tinted blue when a high value is selected and tinted red when a low value is selected. |
| Color Adjustment | (This item cannot be selected if Color Mode is set to sRGB ▶.) <ul style="list-style-type: none"> When Color Mode is set to anything other than Customized: You can adjust the color strength for Red, Green, and Blue individually. When Color Mode is set to Customized: You can adjust the Hue, Saturation, and Brightness for R (red), G (green), B (blue), C (cyan), M (magenta), and Y (yellow) individually. |
| Auto Iris | (This item can be set only if Color Mode is set to Dynamic , Theatre , or Customized .) Set to On to adjust the iris to obtain the optimum light for images being projected. The setting is stored for each Color Mode. ☛ "Setting Auto Iris" p.39 |
| Reset | You can reset all adjustment values for the Image menu to their default settings. See the following to return all menu items to their default settings. ☛ "Reset Menu" p.84 |

Signal Menu

Settable items vary depending on the image signal and source currently being projected. Setting details are saved for each image signal.

You cannot make settings on the Signal menu when the source is USB Display, USB, or LAN.

☛ "Automatically Detect Input Signals and Change the Projected Image (Source Search)" [p.27](#)

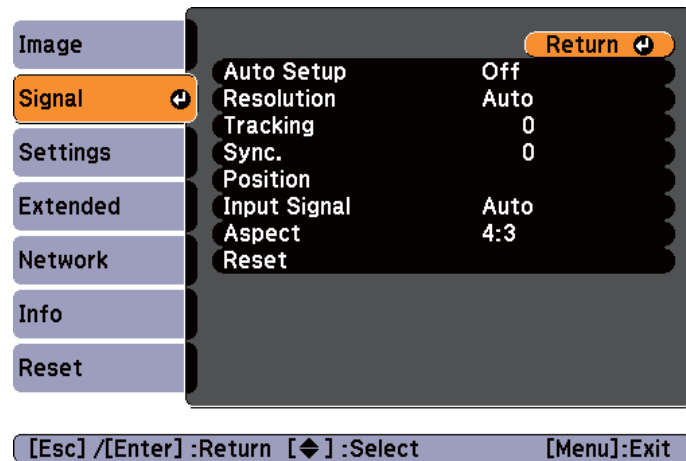

| Submenu | Function |
|-------------------|---|
| Auto Setup | Set to On to automatically adjust the image to the optimum state when the input signal changes. |
| Resolution | Set to Auto to automatically identify the resolution of the input signal. If images are not projected correctly when set to Auto , for example if some of the image is missing, adjust to Wide for wide screens, or set to Normal for 4:3 or 5:4 screens depending on the connected computer. |
| Tracking | You can adjust computer images when vertical stripes appear in the images. |



| Submenu | Function |
|--|---|
| Sync. | You can adjust computer images when flickering, fuzziness, or interference appear in the images. |
| Position | You can adjust the display position up, down, left, and right when a part of the image is missing so that the whole image is projected. |
| Progressive | (This setting can only be adjusted when a component video or RGB video with an interlaced signal (480i/576i/1080i) is input. This cannot be set when a digital RGB signal is input.) <u>Interlace</u> (i) signal is converted to <u>Progressive</u> (p). (IP conversion) Off: Ideal for images with a large amount of movement. Video: Ideal for general video images. Film/Auto: Ideal for movies, CG, and animation. |
| Noise Reduction | (This cannot be set when a digital RGB signal is input, or when an interlace signal is being displayed when Progressive is set to Off .) Smoothes out rough images. There are two modes. Select your favorite setting. It is recommended that this is set to Off when viewing image sources in which noise is very low, such as for DVDs. |
| HDMI Video Range (EB-1775W/ EB-1770W/ EB-1760W only) | When the projector's HDMI port is connected to a DVD player, the projector's video range is set according to the DVD player's video range setting. |
| Input Signal | You can select the input signal from the Computer port. If set to Auto , the input signal is set automatically according to the connected equipment. If colors do not appear correctly when set to Auto , select the appropriate signal according to the connected equipment. |
| Video Signal | You can select the input signal from the Video port. If this is set to Auto , video signals are recognized automatically. If interference appears in the image or a problem occurs such as no image is being projected when set to Auto , select the appropriate signal depending on the connected equipment. |



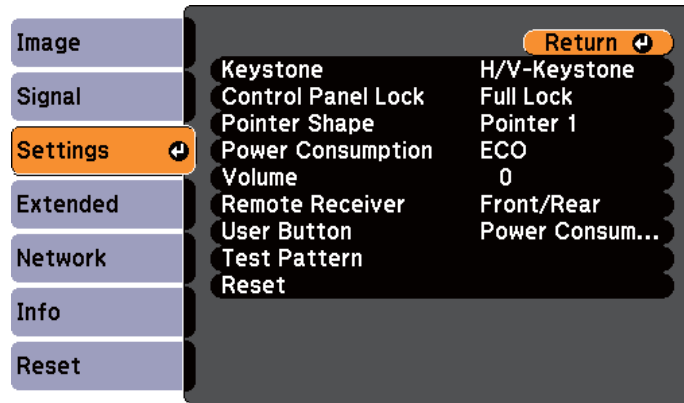

| Submenu | Function |
|-----------------|--|
| Aspect | <p>You can set the <u>aspect ratio</u> for projected images.</p> <p>☛ "Changing the Aspect Ratio" p.40</p> |
| Overscan | <p>(This cannot be set when a digital RGB signal is input.)</p> <p>Changes the output image ratio (the range of the projected image). You can set the cropping range to Off, 4%, or 8%. When the source is HDMI, Auto is available. When Auto is selected, it automatically changes to Off or 8% according to the input signal. However, this only occurs when the HDMI port of the connected device is connected to the projector's HDMI port.</p> |
| Reset | <p>You can reset all adjustment values on the Signal menu to their default settings, except for Input Signal.</p> <p>See the following to return all menu items to their default settings.</p> <p>☛ "Reset Menu" p.84</p> |

Settings Menu



[Esc] / [Enter] : Return [◆] : Select [Menu] : Exit

| Submenu | Function |
|---------------------------|--|
| Keystone | <p>You can correct keystone distortion.</p> <ul style="list-style-type: none"> When H/V-Keystone is selected: <ul style="list-style-type: none"> Correcting manually Adjust V-Keystone and H-Keystone to correct horizontal and vertical keystone distortion. Correcting automatically Set Auto H/V-Keystone* to On.  "Correcting automatically - Auto H/V-Keystone - (EB-1775W only)" p.33 * When using EB-1770W/EB-1760W/EB-1750, set Auto V-Keystone to On. When Quick Corner is selected: Select and correct the four corners of the projected image.  "Correcting manually - Quick Corner -" p.34 |
| Control Panel Lock | <p>You can use this to restrict operation of the projector's control panel.</p>  "Restricting Operation (Control Panel Lock)" p.64 |

| Submenu | Function |
|--------------------------|--|
| Pointer Shape | <p>You can select the shape of the pointer.</p> <p>Pointer 1: </p> <p>Pointer 2: </p> <p>Pointer 3: </p> <p> "Using the Remote Control to Operate the Mouse Pointer (Wireless Mouse)" p.54</p> |
| Power Consumption | <p>You can set the lamp brightness to one of two settings. Select ECO if the images being projected are too bright, such as when projecting images in a dark room or onto a small screen. When ECO is selected, the power consumption is changed as follows, and fan rotation noise during projection is reduced.</p> <p>Electrical consumption: about 27% decrease</p> |
| Volume | <p>You can adjust the volume. Setting values are saved for each source.</p> |
| Remote Receiver | <p>You can limit the reception of the operation signal from the remote control.</p> <p>When set to Off, you cannot perform any operations from the remote control. If you want to make operations from the remote control, hold down the [Menu] button on the remote control or the control panel for at least 15 seconds to reset the setting to its default value.</p> |
| User Button | <p>You can select and assign an item from the Configuration menu with the remote control's [User] button. Pressing the [User] button directly displays the assigned menu item selection/adjustment screen, allowing you to make one-touch changes to settings/adjustments. You can assign one of the following items to the [User] button.</p> <p>Power Consumption, Info, Progressive, Test Pattern, Multi-screen, and Resolution</p> |



| Submenu | Function |
|---------------------|--|
| Test Pattern | You can display a test pattern to adjust the projection without connecting other equipment when you set up the projector. While the test pattern is displayed, you can adjust keystone, zoom, and focus. To cancel the test pattern, press the [Esc] button on the remote control or the control panel. |
| Reset | You can reset all adjustment values on the Settings menu to their default settings, except for User Button . See the following to return all menu items to their default settings. ☛ "Reset Menu" p.84 |

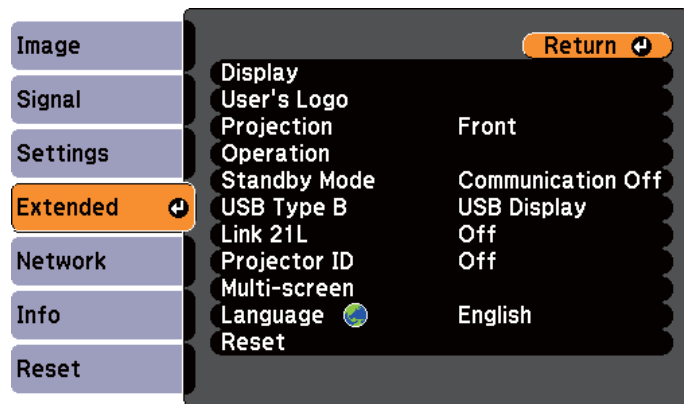

| Submenu | Function |
|----------------------|--|
| Display | You can make settings related to the projector's display. Messages: When set to Off , the following items will not be displayed. The name of the current selection when changing the source, color mode, or aspect ratio; a message when no image signal is input; warnings such as the High Temp Warning. Display Background*1: You can set the screen background to Black , Blue , or Logo when no image signal is available. Startup Screen*1: Set to On to display the User's Logo when projection starts. A/V Mute*1: You can set the screen displayed when the remote control's [A/V Mute] button is pressed to Black , Blue , or Logo . |
| User's Logo*1 | You can change the user's logo that is displayed as a background during Display Background, A/V Mute, and so on. ☛ "Saving a User's Logo" p.60 |
| Projection | Select from one of the following projection methods depending on how the projector is installed. Front , Front/Ceiling , Rear , and Rear/Ceiling You can change the setting as follows by pressing down the [A/V Mute] button on the remote control for about five seconds. Front ↔ Front/Ceiling Rear ↔ Rear/Ceiling ☛ "Installation Methods" p.19 |

Extended Menu



[Esc] / [Enter] : Return [◆] : Select [Menu] : Exit

| Submenu | Function |
|---------------------|---|
| Operation | <p>Direct Power On: Set to On to turn on the projector simply by plugging it in.</p> <p>When the power cable is plugged in, note that the projector turns on automatically in cases such as a power outage being restored.</p> <p>Sleep Mode: When set to On, this automatically stops projection when no image signal is being input and no operations are carried out.</p> <p>Sleep Mode Timer: When Sleep Mode is set to On, you can set the time before the projector automatically turns off within a range of 1 to 30 minutes.</p> <p>Lens Cover Timer: When set to On, this turns off the power automatically 30 minutes after the A/V mute slide is closed.</p> <p>This is set to On by default.</p> <p>High Altitude Mode: Set to On when using the projector above an altitude of 1500 m.</p> |
| Standby Mode | <p>You can use network monitoring and control functions while the projector is in standby mode when this is set to Communication On. (EB-1775W/EB-1770W/EB-1760W only)</p> <p>You can monitor and control the status of the projector over the network by using SNMP, or by using the EasyMP Monitor software.</p> <p> "Useful Software" p.109</p> |
| USB Type B | <p>Set to USB Display when the projector and a computer are connected by a USB cable and computer images are projected.</p> <p> "Projecting with USB Display" p.28</p> <p>Set to Link 21L to operate the mouse pointer by remote control.</p> <p> "Using the Remote Control to Operate the Mouse Pointer (Wireless Mouse)" p.54</p> |
| Link 21L | Set to On to use the Link 21L utility software. |

| Submenu | Function |
|---------------------|---|
| Projector ID | <p>Set the ID for the projector to a number between 1 and 9. Off indicates that no ID is set.</p> <p> "Setting the Projector ID" p.57</p> |
| Multi-screen | <p>You can adjust the hue and brightness of each projected image when multiple projectors are lined up and projecting.</p> <p>Adjustment Level: You can adjust from black to white in five stages called Level 1 to 5, and in each of these 5 levels, you can adjust Brightness Correct. and Color Correct.</p> <p>Brightness Correct.: You can correct the difference in the brightness of each projector.</p> <p>Color Correct. (G/R) / Color Correct. (B/Y): You can correct the difference in the color of each projector.</p> <p> "Correcting Color when Projecting from Multiple Projectors" p.58</p> |
| Language | You can set the language for messages and menus. |
| Reset | <p>You can reset the adjustment values for Display*1 and Operation*2 from the Extended menu to their default settings.</p> <p>See the following to return all menu items to their default settings.</p> <p> "Reset Menu" p.84</p> |

*1 When **User's Logo Protect** is set to **On** in **Password Protect**, settings related to user's logo cannot be changed. You can make changes after setting **User's Logo Protect** to **Off**.

 "Managing Users (Password Protect)" [p.62](#)

*2 Except for High Altitude Mode.

Network Menu (EB-1775W/EB-1770W/EB-1760W Only)

When **Network Protect** is set to **On** in **Password Protect**, a message is displayed and the network settings cannot be changed. Set **Network Protect** to **Off** and then configure the network.

☛ "Setting Password Protect" p.62

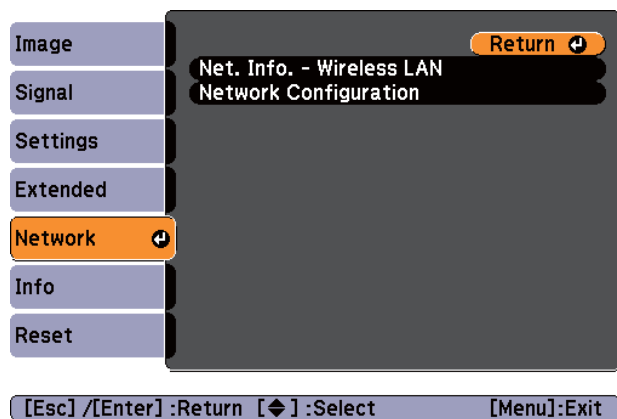

| Submenu | Function |
|----------------------------------|--|
| Net. Info. - Wireless LAN | Displays the following network setting status information. <ul style="list-style-type: none"> • Connection Mode • Antenna Level • Projector Name • SSID • DHCP • IP Address • Subnet Mask • Gateway Address • MAC Address • Region Code* |

| Submenu | Function |
|------------------------------|---|
| Network Configuration | The following menus are available for setting Network items. Basic, Wireless LAN, Security, Mail, Others, Reset, and Setup complete |

* Displays available region information for the Wireless LAN unit being used. For more details, contact your local dealer or the nearest address provided in the Epson Projector Contact List.

☛ [Epson Projector Contact List](#)



By using the Web browser of a computer connected to the projector on a network, you can set functions and control the projector. This function is called Web Control. You can easily enter text using a keyboard to make settings for Web Control such as security settings.

☛ "Changing Settings Using a Web Browser (Web Control)" p.111

Notes on operating the Network menu

Selecting from the top menu and sub menus, and changing selected items is the same as making operations from the Configuration menu.

When done, make sure you go to the **Setup complete** menu, and select **Yes**, **No**, or **Cancel**. When you select **Yes** or **No**, you are returned to the Configuration menu.



[Esc] : Return [Left/Right] : Select [Enter] : Execute

Yes: Saves the settings and exits the Network menu.

No: Does not save the settings and exits the Network menu.

Cancel: Continues displaying the Network menu.

Soft keyboard operations

The Network menu contains items that require input of alphanumerics during setup. In this case, the following software keyboard is displayed. Use the [↶], [↷], [↵], and [↷] buttons on the remote control or the [↶], [↷], [↵], and [↷] buttons on the control panel to move the cursor to the desired key, and then press the [Enter] button to enter the alphanumeric character. Enter figures by holding down the [Num] button on the remote control, and pressing the numeric buttons. After inputting, press **Finish** on the keyboard to confirm your input. Press **Cancel** on the keyboard to cancel your input.

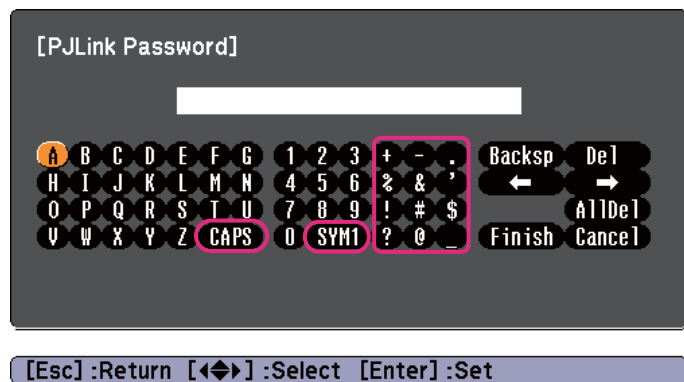

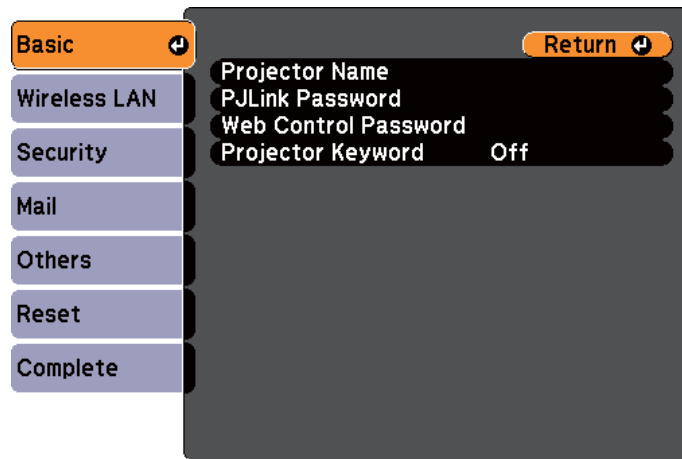

- Each time the **CAPS** key is selected and the [Enter] button is pressed, it sets and changes between upper case and lower case letters.
- Each time the **SYM1/2** key is selected and the [Enter] button is pressed, it sets and changes the symbol keys for the section enclosed by the frame.

Basic menu



[Esc] / [Enter] :Return [◆] :Select

| Submenu | Function |
|--------------------|--|
| Projector Key-word | <p>When set to On, you have to enter the keyword when you try to connect the projector to a computer via a network. As a result, you can prevent presentations from being interrupted by connections from other computers. Normally this should be set to On.</p> <p> EasyMP Network Projection Operation Guide</p> |

| Submenu | Function |
|-----------------------------|--|
| Projector Name | <p>Displays the projector name used to identify the projector when connected to a network.</p> <p>When editing, you can enter up to 16 single-byte alphanumeric characters.</p> |
| PJLink Password | <p>Set a password to use when you access the projector using compatible PJLink software.</p> <p>You can enter up to 32 single-byte alphanumeric characters.</p> |
| Web Control Password | <p>Set a password to use when making settings and controlling the projector using Web Control. Enter no more than eight single-byte alphanumeric characters. Web Control is a function that allows you to set up and control the projector by using the Web browser on a computer connected on a network.</p> <p> "Changing Settings Using a Web Browser (Web Control)" p.111</p> |

Wireless LAN menu

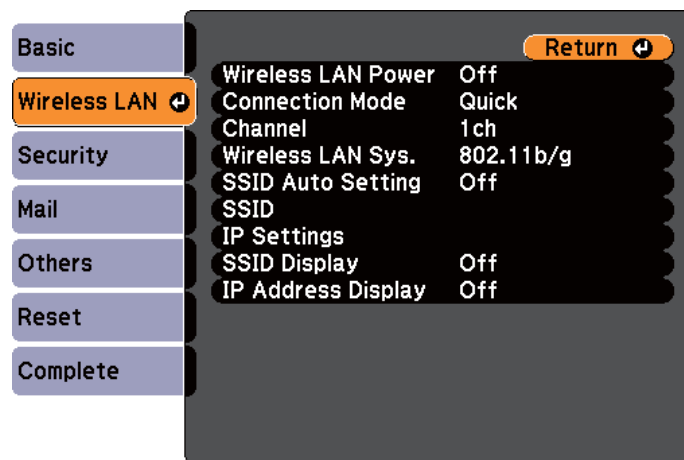

[Esc] / [Enter] : Return [◆] : Select

| Submenu | Function |
|---------------------------|---|
| Wireless LAN Power | Turn On when connecting the projector to the computer over wireless LAN. If you do not want to connect via wireless LAN, turn it Off to prevent unauthorized access by others. This is set to On by default. |
| Connection Mode | Set the connection mode when using EasyMP Network Projection to connect the projector and computer. This is set to Quick by default. See the following manual for details on connection mode. EasyMP Network Projection Operation Guide |
| Channel | (This can only be set if Connection Mode is set to Quick .) Select the frequency band used by the wireless LAN from 1ch , 6ch , or 11ch . This is set to 11ch by default. |

| Submenu | Function |
|---------------------------|---|
| Wireless LAN Sys. | Set the Wireless LAN system to either 802.11b/g or 802.11b/g/n . This is set to 802.11b/g by default. |
| SSID Auto Setting | Set to On to reduce the projector search time when connecting to a network using Quick from Connection Mode . Set to Off when connecting to multiple projectors at the same time. This is set to On by default. |
| SSID | Enter an SSID . When an SSID is provided for the wireless LAN system in which the projector participates, enter the SSID. You can enter up to 32 single-byte alphanumeric characters. |
| IP Settings | You can make network settings. DHCP : Set to On to make network settings using DHCP . If this is set to On , you cannot set any more addresses. IP Address : You can input the IP address assigned to the projector. You can enter a number from 0 to 255 in each field of the address. However, the following IP addresses cannot be used. 0.0.0.0, 127.x.x.x, 224.0.0.0 to 255.255.255.255 (where x is a number from 0 to 255) Subnet Mask : You can input the subnet mask for the projector. You can enter a number from 0 to 255 in each field of the address. However, the following subnet masks cannot be used. 0.0.0.0, 255.255.255.255 Gateway Address : You can input the IP address for the gateway for the projector. You can enter a number from 0 to 255 in each field of the address. However, the following gateway addresses cannot be used. 0.0.0.0, 127.x.x.x, 224.0.0.0 to 255.255.255.255 (where x is a number from 0 to 255) |
| SSID Display | To prevent the SSID from being displayed on the LAN Standby screen, set this to Off . |
| IP Address Display | To prevent the IP address from being displayed on the LAN Standby screen, set this to Off . |

Security menu

Only available when the supplied or optional Wireless LAN unit is installed.



| Submenu | Function |
|-----------------------|--|
| Security | Select the security type from the items that are displayed. When setting up Security, follow the instructions from the administrator of the network system you are about to access. |
| WEP Encryption | You can set the encryption for WEP encryption. 128Bit: Uses 128 (104) bit encoding. 64Bit: Uses 64 (40) bit encoding. |
| Format | You can set the input method for the WEP encryption key. ASCII: Input text. HEX: Input in HEX (hexadecimal). |
| Key ID | Selects the WEP encryption ID key. |

| Submenu | Function |
|--|--|
| Encryption Key 1/Encryption Key 2/Encryption Key 3/Encryption Key 4 | You can enter the key used for WEP encryption. Enter the key in single-byte characters following instructions from the network administrator for the network in which the projector participates. The type and number of characters that can be entered differ depending on the WEP Encryption and Format settings. 128Bit - ASCII: Single-byte alphanumeric, 13 characters. 64Bit - ASCII: Single-byte alphanumeric, 5 characters. 128Bit - HEX: 0 to 9 and A to F, 26 characters 64Bit - HEX: 0 to 9 and A to F, 10 characters |
| Authentication Type | Set the WEP authentication type. Open: Uses open system authentication. Shared: Uses shared key authentication. |
| PSK | (This can only be set when WPA-PSK or WPA2-PSK are selected from Security .) You can enter a Pre-Shared Key (encrypted key) in single-byte alphanumeric characters. Enter at least 8 and up to 32 characters. |

Type of security

When the supplied or optional wireless LAN unit is installed and being used in Advanced connection mode, it is strongly recommended that you set security. Select one of the following security methods.

- **WEP**

Data is encrypted with a code key (WEP key). This mechanism prevents communication unless the encrypted keys for the access point and the projector match.

- **WPA**

This is an encryption standard that improves security which is a weak point of WEP. Although there are multiple kinds of WPA encryption methods, this projector uses TKIP and AES.

WPA also includes user authentication functions. WPA authentication provides two methods: using an authentication server, or authenticating between a computer and an access point without using a server. This projector supports the latter method, without a server.



For setting details, follow the directions from the network administrator of your network.

Mail menu

When this is set, you receive an email notification if a problem or warning occurs in the projector.

☛ "Using the Mail Notification Function to Report Problems" p.113

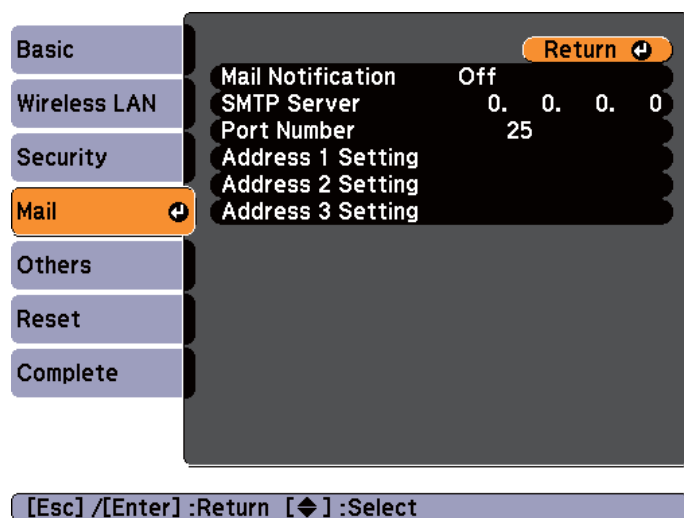

| Submenu | Function |
|--------------------------|---|
| Mail Notification | Set to On to send an email to the preset addresses when a problem or warning occurs with a projector. |
| SMTP Server | You can input the <u>IP address</u> for the SMTP server for the projector. You can enter a number from 0 to 255 in each field of the address. However, the following IP addresses cannot be used. 127.x.x.x, 224.0.0.0 to 255.255.255.255 (where x is a number from 0 to 255) |
| Port Number | You can input the port number for the SMTP server. The default value is 25. You can input numbers between 1 to 65535. |

| Submenu | Function |
|--|--|
| Address 1 Setting, Address 2 Setting, and Address 3 Setting | You can input the email address of the destination to send the notification email to. You can register up to three destinations. You can enter up to 32 single-byte alphanumeric characters for the email addresses. You can select the problems or warnings to be notified about by email. When the selected problem or warning occurs in the projector, an email is sent to the specified destination address notifying that a problem or warning has occurred. You can select multiple items from the displayed items. |

Others menu

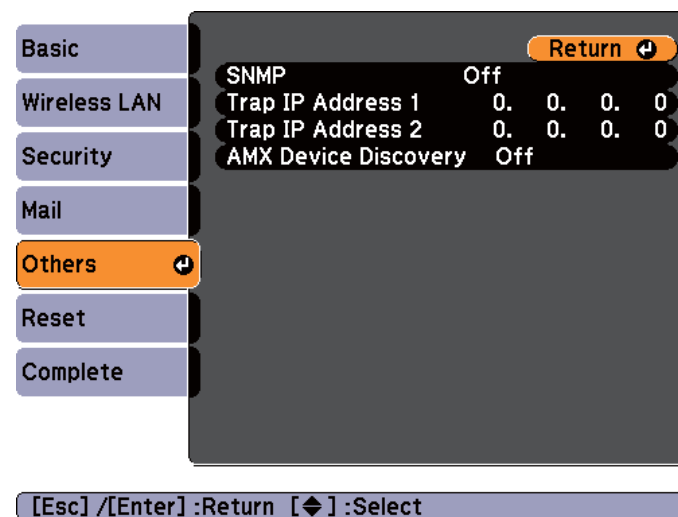

| Submenu | Function |
|-------------|---|
| SNMP | Set to On to monitor the projector using SNMP. To monitor the projector, you need to install the SNMP manager program on your computer. SNMP should be managed by a network administrator. The default value is Off . |

| Submenu | Function |
|--|---|
| Trap IP Address 1/Trap IP Address 2 | You can register up to two IP addresses for the SNMP trap notification destination. You can enter a number from 0 to 255 in each field of the address. However, the following IP addresses cannot be used. 127.x.x.x, 224.0.0.0 to 255.255.255.255 (where x is a number from 0 to 255) |
| AMX Device Discovery | When the projector is connected to a network, set this to On when you want to allow the projector to be detected by <u>AMX Device Discovery</u> . Set this to Off if you are not connected to an environment controlled by a controller from AMX or AMX Device Discovery. |

Reset menu

Resets all of the network settings.

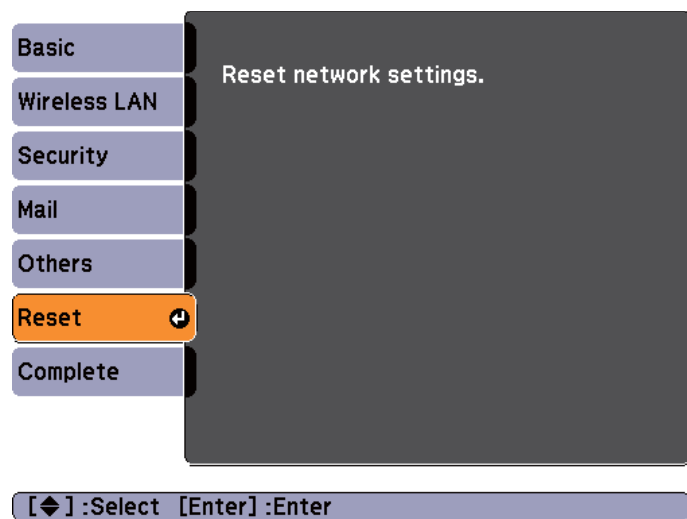

| Submenu | Function |
|--------------------------------|---|
| Reset network settings. | To reset all of the Network settings, select Yes . |

Info Menu (Display Only)

Lets you check the status of the image signals being projected and the status of the projector. Items that can be displayed vary depending on the source currently being projected. Depending on the model used, some input sources are not supported.

☛ "Automatically Detect Input Signals and Change the Projected Image (Source Search)" [p.27](#)

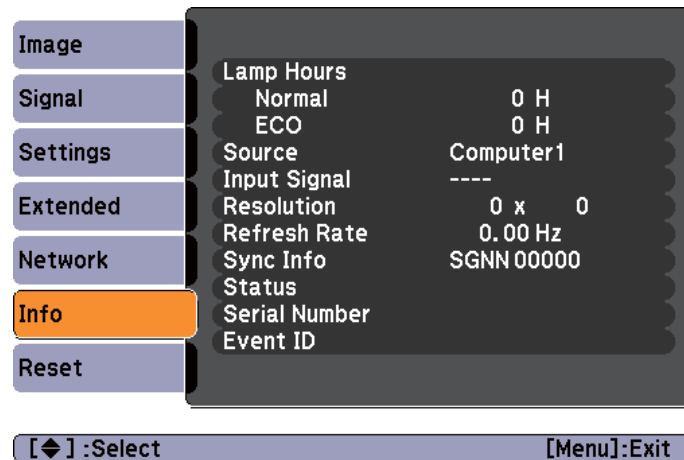

| Submenu | Function |
|--------------|---|
| Lamp Hours | You can display the cumulative lamp operating time*. When it reaches the lamp warning time, the characters are displayed in yellow. |
| Source | You can display the source name for the connected equipment currently being projected. |
| Input Signal | You can display the content of Input Signal set in the Signal menu according to the source. |
| Resolution | You can display the resolution. |

| Submenu | Function |
|---|--|
| Video Signal | You can display the settings for Video Signal in the Signal menu. |
| Refresh Rate | You can display the <u>refresh rate</u> ▶▶. |
| Sync Info | You can display the image signal information. This information may be needed if service is required. |
| Status | This is information about errors that have occurred on the projector. This information may be needed if service is required. |
| Serial Number | Displays the projector's serial number. |
| Event ID (EB-1775W/ EB-1770W/ EB-1760W only) | Displays the application error log. ☛ "About Event ID (EB-1775W/EB-1770W/EB-1760W Only)" p.116 |

* The cumulative use time is displayed as "0H" for the first 10 hours. 10 hours and above is displayed as "10H", "11H", and so on.

Reset Menu

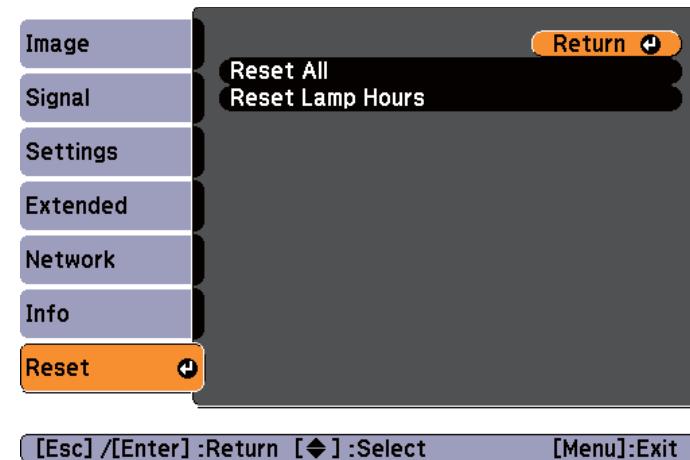

| Submenu | Function |
|-------------------------|---|
| Reset All | You can reset all items in the Configuration menu to their default settings. The following items are not reset to their defaults: Input Signal , User's Logo , all items for Network menus*, Lamp Hours , Language , Password , User Button , and Multi-screen . |
| Reset Lamp Hours | Clears the cumulative lamp hours use time. Reset when you replace the lamp. |

* (EB-1775W/EB-1770W/EB-1760W only)



Troubleshooting

This chapter explains how to identify problems and what to do if a problem is found.

If a problem occurs with the projector, the Help screen is displayed to assist you by pressing the Help button. You can solve problems by answering the questions.

- 1 Press the [Help] button.
The Help screen is displayed.

Using the remote control

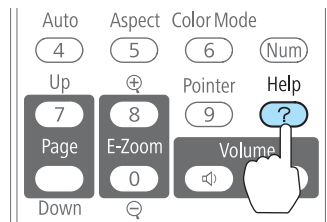

Using the control panel

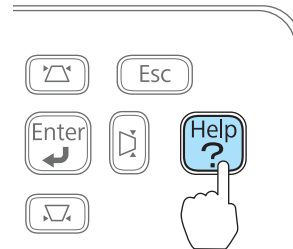

- 2 Select a menu item.

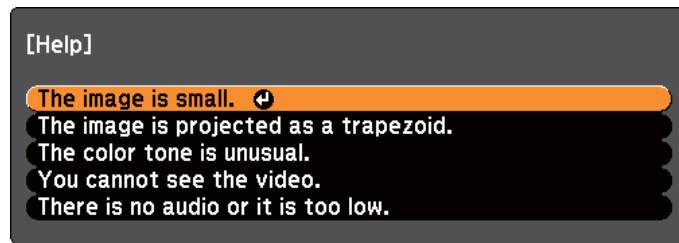

[◀] :Select [Enter] :Enter [Help] :Exit

Using the remote control

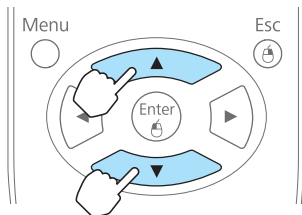

Using the control panel

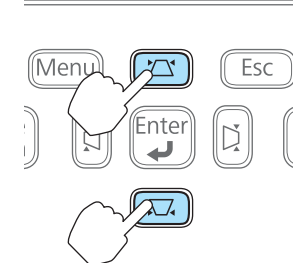

- 3 Confirm the selection.

Using the remote control

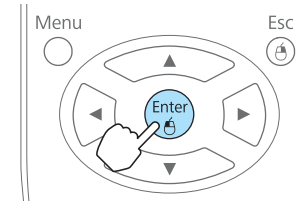

Using the control panel

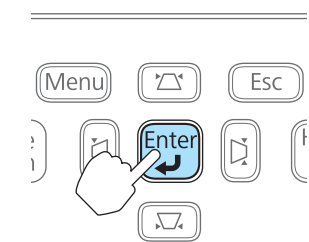

Questions and solutions are displayed as shown on the screen below. Press the [Help] button to exit the Help.

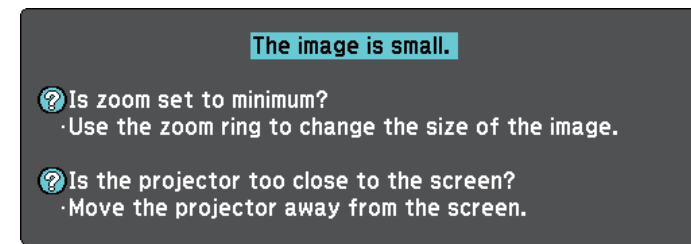

[Esc] :Return [Help] :Exit



See the following if the Help function does not provide a solution to the problem.

☞ "Problem Solving" p.88

If you are having a problem with the projector, first check the projector's indicators and refer to "Reading the Indicators" below. See the following if the indicators do not show clearly what the problem might be.

☛ "When the Indicators Provide No Help" [p.91](#)



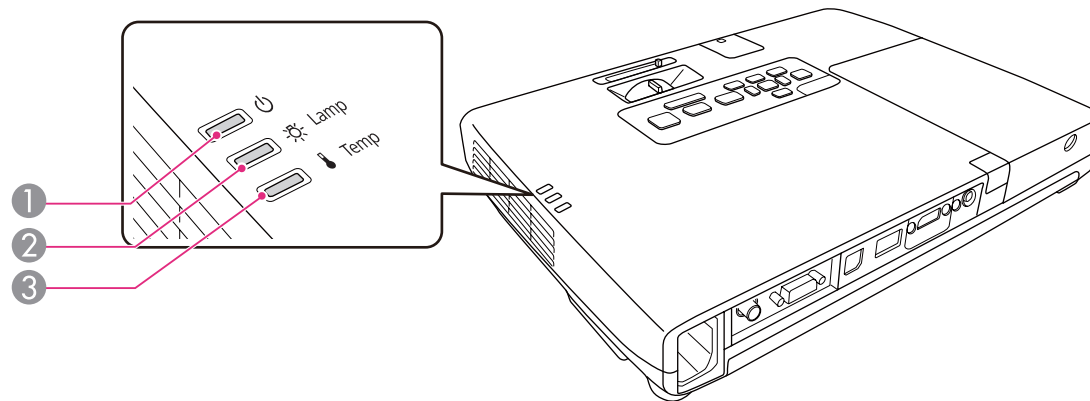

Reading the Indicators

The projector is provided with the following three indicators that indicate the operating status of the projector.



① Power indicator

Indicates the operating status.

-  Standby condition
When the [⏻] button is pressed in this condition, projection starts.
-  Preparing for network monitoring or cool down in progress
All buttons are disabled while the indicator is flashing.
-  Warming up
Warm-up time is about 30 seconds. After warm-up is complete, the indicator stops flashing.
The [⏻] button is disabled during warm-up.
-  Projecting

② Lamp indicator

Indicates the projection lamp status.





③ Temp indicator































Indicates the internal temperature status.



Refer to the following table to see what the indicators mean and how to remedy problems that they indicate.

If all indicators are off, check that the power cable is connected correctly and that the power is being supplied normally.

Sometimes, when the power cable is unplugged, the  indicator remains lit for a short period, but this is not a fault.

 : Lit  : Flashing  : Off  : Varies according to the projector status

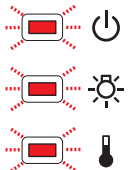
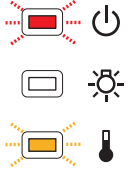
| Status | Cause | Remedy or Status |
|---|----------------------------------|---|
|       | Internal Error | Stop using the projector, remove the power plug from the electrical outlet, and contact your local dealer or the nearest address provided in the <i>Epson Projector Contact List</i> .  Epson Projector Contact List |
|       | Fan Error Sensor Error | Stop using the projector, remove the power plug from the electrical outlet, and contact your local dealer or the nearest address provided in the <i>Epson Projector Contact List</i> .  Epson Projector Contact List |
|       | High Temp Error (overheating) | The lamp turns off automatically and projection stops. Wait for about five minutes. After about five minutes the projector switches to standby mode, so check the following two points. <ul style="list-style-type: none"> • Check that the air filter and air exhaust vent are clear, and that the projector is not positioned against a wall. • If the air filter is clogged, clean or replace it. <ul style="list-style-type: none">  "Cleaning the Air Filter" p.101, "Replacing the Air Filter" p.106 If the error continues after checking the points above, stop using the projector, remove the power plug from the electrical outlet, and contact your local dealer or the nearest address provided in the <i>Epson Projector Contact List</i> .  Epson Projector Contact List |
| | | When using at an altitude of 1500 m or more, set High Altitude Mode to On .  "Extended Menu" p.74 |
|       | Lamp Error Lamp Failure | Check the following two points. <ul style="list-style-type: none"> • Take out the lamp and check if it is cracked. <ul style="list-style-type: none">  "Replacing the Lamp" p.103 • Clean the air filter. <ul style="list-style-type: none">  "Cleaning the Air Filter" p.101 |

| Status | Cause | Remedy or Status |
|---|---|--|
| | | <p>If it is not cracked: Reinstall the lamp and turn on the power.</p> <p>If the error continues: Replace the lamp with a new one and then turn on the power.</p> <p>If the error continues: Stop using the projector, remove the power plug from the electrical outlet, and contact your local dealer or the nearest address provided in the <i>Epson Projector Contact List</i>.</p> <p>☛ Epson Projector Contact List</p> |
| | | <p>If it is cracked: Contact your local dealer or the nearest address provided in the <i>Epson Projector Contact List</i>. (Images cannot be projected until the lamp is replaced.)</p> <p>☛ Epson Projector Contact List</p> |
| | | <p>When using at an altitude of 1500 m or more, set High Altitude Mode to On.</p> <p>☛ "Extended Menu" p.74</p> |
|  | Auto Iris Error Power Err. (Ballast) | <p>Stop using the projector, remove the power plug from the electrical outlet, and contact your local dealer or the nearest address provided in the <i>Epson Projector Contact List</i>.</p> <p>☛ Epson Projector Contact List</p> |
|  | High Temp Warning | <p>(This is not an abnormality. However, if the temperature rises too high again, projection stops automatically.)</p> <ul style="list-style-type: none"> • Check that the air filter and air exhaust vent are clear, and that the projector is not positioned against a wall. • If the air filter is clogged, clean or replace it. <ul style="list-style-type: none"> ☛ "Cleaning the Air Filter" p.101, "Replacing the Air Filter" p.106 |
|  | Replace Lamp | <p>Replace it with a new lamp.</p> <p>☛ "Replacing the Lamp" p.103</p> <p>If you continue to use the lamp after the replacement period has passed, the possibility that the lamp may explode increases. Replace it with a new lamp as soon as possible.</p> |











- See the following if the projector is not operating properly, even though the indicators are all showing normal.
 - ☛ "When the Indicators Provide No Help" [p.91](#)
- If the indicators are in a state not shown in this table, stop using the projector, remove the power plug from the electrical outlet, and contact your local dealer or the nearest address provided in the *Epson Projector Contact List*.
 - ☛ [Epson Projector Contact List](#)

When the Indicators Provide No Help

If any of the following problems occur and the indicators do not offer a solution, refer to the pages given for each problem.



Problems Relating to Images



| | |
|---|--|
| <ul style="list-style-type: none"> • No images appear Projection does not start, the projection area is completely black, or the projection area is completely blue. |  p.92 |
| <ul style="list-style-type: none"> • Moving images are not displayed Moving images being projected from a computer appear black and nothing is projected. |  p.93 |
| <ul style="list-style-type: none"> • Projection stops automatically |  p.93 |
| <ul style="list-style-type: none"> • The message "Not supported" is displayed |  p.93 |
| <ul style="list-style-type: none"> • The message "No Signal" is displayed |  p.93 |
| <ul style="list-style-type: none"> • Interference or distortion appear in images |  p.95 |
| <ul style="list-style-type: none"> • The image is truncated (large) or small, or the aspect ratio is not suitable Only part of the image is displayed, or the height and width ratios of the image are not correct. |  p.95 |
| <ul style="list-style-type: none"> • Image colors are not right The whole image appears purplish or greenish, images are black & white, or colors appear dull. |  p.96 |
| <ul style="list-style-type: none"> • Images appear dark |  p.97 |

Problems when projection starts

| | |
|---|--|
| <ul style="list-style-type: none"> • The projector does not turn on |  p.97 |
|---|--|

Other Problems

| | |
|--|--|
| <ul style="list-style-type: none"> • No sound can be heard or the sound is faint |  p.98 |
| <ul style="list-style-type: none"> • The remote control does not work |  p.98 |

| | |
|--|--|
| <ul style="list-style-type: none"> • I want to change the language for messages and menus |  p.99 |
| <ul style="list-style-type: none"> • Email is not received even if a problem occurs in the projector (EB-1775W/EB-1770W/EB-1760W only) |  p.99 |

Problems Relating to Images

No images appear

| Check | Remedy |
|---|---|
| Did you press the [⏻] button? | Press the [⏻] button to turn the power on. |
| Are the indicators switched off? | The power cable is not connected correctly or power is not being supplied. Connect the projector's power cable correctly. ☛ "From Installation to Projection" p.26 Check that your electrical outlet or power source is functioning correctly. |
| Is A/V Mute active? | Press the [A/V Mute] button on the remote control to cancel A/V Mute. ☛ "Hiding the Image and Sound Temporarily (A/V Mute)" p.51 |
| Is the A/V mute slide closed? | Open the A/V mute slide. ☛ "Front/Top" p.10 |
| Are the Configuration menu settings correct? | Reset all of the settings. ☛ Reset - Reset All p.84 When using USB Display, set USB Type B to USB Display . ☛ Extended - USB Type B p.74 |
| Is the image to be projected completely black? (Only when projecting computer images) | Some input images, such as screen savers, may be completely black. |
| Is the image signal format setting correct? (Only when projecting images from a video source) | Change the setting according to the signal for the connected equipment. ☛ Signal - Video Signal p.71 |
| Is the USB cable connected correctly? (Only when projecting using USB Display) | Check that the USB cable is connected correctly. Reconnect it if it is not connected or not connected properly. |
| Is Windows Media Center displayed in full screen? (Only when projecting using USB Display or network connection) | When Windows Media Center is displayed at full screen, you cannot project using USB Display or network connection. Reduce the screen size. |
| Is an application using the Windows DirectX function displayed? (Only when projecting using USB Display or network connection) | Applications using the Windows DirectX function may not display images correctly. |

Moving images are not displayed (only the moving image portion turns black)

| Check | Remedy |
|--|--|
| <p>Is the computer's image signal being output to the LCD and the monitor? (Only when projecting images from a laptop computer or a computer with a built-in LCD screen)</p> | <p>Change the image signal from the computer to external output only. Check your computer's documentation, or contact the computer's manufacturer.</p> |

Projection stops automatically

| Check | Remedy |
|---|--|
| <p>Is Sleep Mode set to On?</p> | <p>Press the [⏻] button to turn the power on. If you do not want to use Sleep Mode, change the setting to Off. ☛ Extended - Operation - Sleep Mode p.74</p> |

The message "Not supported" is displayed

| Check | Remedy |
|---|--|
| <p>Is the image signal format setting correct? (Only when projecting images from a video source)</p> | <p>Change the setting according to the signal for the connected equipment. ☛ Signal - Video Signal p.71</p> |
| <p>Do the image signal resolution and the refresh rate correspond to the mode? (Only when projecting computer images)</p> | <p>Refer to the computer's documentation for how to change the image signal resolution and the refresh rate output from the computer. ☛ "Supported Monitor Displays" p.121</p> |

The message "No Signal" is displayed

| Check | Remedy |
|---|---|
| <p>Are the cables connected correctly?</p> | <p>Check that all the cables required for projection are securely connected. ☛ "From Installation to Projection" p.26</p> |
| <p>Is the correct port selected?</p> | <p>Change the image by pressing the [Source Search] button on the remote control or the control panel. ☛ "Automatically Detect Input Signals and Change the Projected Image (Source Search)" p.27</p> |
| <p>Is the power for the computer or video source turned on?</p> | <p>Turn the power on for the equipment.</p> |

| Check | Remedy |
|---|--|
| <p>Are the image signals being output to the projector? (Only when projecting images from a laptop computer or a computer with a built-in LCD screen)</p> | <p>If the image signals are only being output to the computer's LCD monitor or to the accessory monitor, you need to change the output to an external destination as well as the computer's own monitor. For some computer models, when the image signals are output externally, they no longer appear on the LCD monitor or accessory monitor.</p> <p>If the connection is made while the power of the projector or computer is already turned on, the Fn key (Function key) that changes the computer's image signal to external output may not work. Turn the power for the computer and the projector off and then back on again.</p> <ul style="list-style-type: none"> ☛ "From Installation to Projection" p.26 ☛ Computer's documentation |

Images are fuzzy, out of focus, or distorted

| Check | Remedy |
|--|--|
| <p>Is the distance between the projector and the screen over 2.5 m? (For EB-1775W)</p> | <p>For the projected image to be automatically adjusted by Auto H/V-Keystone or Screen Fit, the projector cannot be more than approximately 1.0 to 2.5 m away from the screen. If the projector must be placed further away than this, manually adjust the projected image.</p> |
| <p>Is Auto H/V-Keystone set to Off? (EB-1775W only)</p> | <p>Setting it to On enables Auto H/V-Keystone.</p> <ul style="list-style-type: none"> ☛ Settings - Keystone - Auto H/V-Keystone p.73 <p>If you are using the projector with this setting off, manually adjust the projected image.</p> <ul style="list-style-type: none"> ☛ "Correcting manually - manual H/V-Keystone -" p.34 |
| <p>Is the focus adjusted correctly?</p> | <p>Adjust the focus using the [Focus] buttons (EB-1775W only) or Focus ring (EB-1770W/EB-1760W/EB-1750 only).</p> <ul style="list-style-type: none"> ☛ "Correcting the Focus" p.37 |
| <p>Is the projector at the correct distance?</p> | <p>Is it projecting outside of the recommended projection distance range? Setup within the recommended range.</p> <ul style="list-style-type: none"> ☛ "Screen Size and Projection Distance" p.118 |
| <p>Is the keystone adjustment value too large?</p> | <p>Lower the projection angle to reduce the amount of keystone correction.</p> <ul style="list-style-type: none"> ☛ "Adjusting the Image Position" p.37 |
| <p>Has condensation formed on the lens?</p> | <p>If the projector is suddenly taken from a cold environment to a warm environment, or if sudden ambient temperature changes occur, condensation may form on the surface of the lens, and this may cause the images to appear fuzzy. Set the projector up in the room about one hour before it is used. If condensation forms on the lens, turn the projector off and wait for the condensation to disappear.</p> |

Interference or distortion appear in images

| Check | Remedy |
|--|--|
| Is the image signal format setting correct? (Only when projecting images from a video source) | Change the setting according to the signal for the connected equipment. ☛ Signal - Video Signal p.71 |
| Are the cables connected correctly? | Check that all the cables required for projection are securely connected. ☛ "Connecting Equipment" p.21 |
| Is an extension cable being used? | If an extension cable is used, electrical interference may affect the signals. Use the cables supplied with the projector to check if the cables you are using may be causing the problem. |
| Is the correct resolution selected? (Only when projecting computer images) | Set the computer so that the signals being output are compatible with the projector. ☛ "Supported Monitor Displays" p.121 ☛ Computer's documentation |
| Are the Sync and Tracking settings adjusted correctly? (Only when projecting computer images) | Press the [Auto] button on the remote control or the [Enter] button on the control panel to perform automatic adjustment. If the images are not adjusted correctly even after performing automatic adjustment, you can also make adjustments from the Configuration menu. ☛ Signal - Tracking, Sync. p.71 |
| Is Transfer layered window selected? (Only when projecting using USB Display) | Click All Programs - EPSON Projector - EPSON USB Display - EPSON USB Display Vx.xx Settings , and then clear the Transfer layered window checkbox. |

The image is truncated (large) or small, or the aspect is not suitable

| Check | Remedy |
|---|--|
| Is a wide panel computer image being projected? (Only when projecting computer images) | Change the setting according to the signal for the connected equipment. ☛ Signal - Resolution p.71 |
| Is the image still being enlarged by E-Zoom? | Press the [Esc] button on the remote control to cancel E-Zoom. ☛ "Enlarging Part of the Image (E-Zoom)" p.53 |
| Is the image position adjusted correctly? | Press the [Auto] button on the remote control or the [Enter] button on the control panel to perform automatic adjustment of the computer image being projected. If the images are not adjusted correctly even after performing automatic adjustment, you can also make adjustments from the Configuration menu. Apart from computer image signals, you can adjust other signals while projecting from the Configuration menu. ☛ Signal - Position p.71 |

| Check | Remedy |
|---|--|
| Is the computer set for dual display? (Only when projecting computer images) | If dual display is activated in the Display Properties of the computer's Control Panel, only about half of the image on the computer screen is projected. To display the entire image on the computer screen, turn off the dual display setting. ☛ Computer video driver documentation |
| Is the correct resolution selected? (Only when projecting computer images) | Set the computer so that the signals being output are compatible with the projector. ☛ "Supported Monitor Displays" p.121 ☛ Computer's documentation |

Image colors are not right

| Check | Remedy |
|--|--|
| Do the input signal settings match the signals from the connected device? | Change the following settings according to the signal for the connected equipment. <ul style="list-style-type: none"> • When image is from a device connected to the Computer port ☛ Signal - Input Signal p.71 • When image is from a device connected to the Video port ☛ Signal - Video Signal p.71 |
| Is the image brightness adjusted correctly? | Adjust the Brightness setting from the Configuration menu. ☛ Image - Brightness p.70 |
| Are the cables connected correctly? | Check that all the cables required for projection are securely connected. ☛ "Connecting Equipment" p.21 |
| Is the <u>contrast</u>  adjusted correctly? | Adjust the Contrast setting from the Configuration menu. ☛ Image - Contrast p.70 |
| Is the color adjustment set correctly? | Adjust the Color Adjustment setting from the Configuration menu. ☛ Image - Color Adjustment p.70 |
| Are the color saturation and tint adjusted correctly? (Only when projecting images from a video source) | Adjust the Color Saturation and Tint settings from the Configuration menu. ☛ Image - Color Saturation, Tint p.70 |

Images appear dark

| Check | Remedy |
|--|--|
| Is the image brightness set correctly? | Adjust the Brightness and Power Consumption settings from the Configuration menu. ☛ Image - Brightness p.70 ☛ Settings - Power Consumption p.73 |
| Is the <u>contrast</u> adjusted correctly? | Adjust the Contrast setting from the Configuration menu. ☛ Image - Contrast p.70 |
| Is it time to replace the lamp? | When the lamp is nearly ready for replacement, the images become darker and the color quality becomes poorer. When this happens, replace the lamp with a new lamp. ☛ "Replacing the Lamp" p.103 |

Problems when Projection Starts

The projector does not turn on

| Check | Remedy |
|--|---|
| Did you press the [⏻] button? | Press the [⏻] button to turn the power on. |
| Are the indicators switched off? | The power cable is not connected correctly or power is not being supplied. Disconnect and then reconnect the power cable. ☛ "From Installation to Projection" p.26 Check that your electrical outlet or power source is functioning correctly. |
| Do the indicators turn on and off when the power cable is touched? | There is probably a poor contact in the power cable, or the power cable may be defective. Reinsert the power cable. If this does not solve the problem, stop using the projector, disconnect the power cable from the electrical outlet, and contact your local dealer or the nearest address provided in the <i>Epson Projector Contact List</i> . ☛ Epson Projector Contact List |
| Is the Control Panel Lock set to Full Lock ? | Press the [⏻] button on the remote control. If you do not want to use Control Panel Lock , change the setting to Off . ☛ Settings - Control Panel Lock p.73 |
| Is the correct setting for the remote receiver selected? | Check the Remote Receiver from the Configuration menu. ☛ Settings - Remote Receiver p.73 |

Other Problems

No sound can be heard or the sound is faint

| Check | Remedy |
|---|---|
| Check that the audio/video cable is securely attached to both the projector and audio source. | Disconnect the cable from the Audio port, and then reconnect the cable. |
| Is the volume adjusted to the minimum setting? | Adjust the volume so that sound can be heard. ⚙️ Settings - Volume p.73 ⚙️ "Adjusting the Volume" p.38 |
| Is A/V Mute active? | Press the [A/V Mute] button on the remote control to cancel A/V Mute. ⚙️ "Hiding the Image and Sound Temporarily (A/V Mute)" p.51 |
| Is the audio cable's specification "No resistance"? | When using a commercially available audio cable, make sure it is labeled "No resistance". |
| Is it connected with an HDMI cable? (EB-1775W/EB-1770W/EB-1760W only) | If no audio is output when connecting via an HDMI cable, set the connected equipment to PCM output. |
| Is Output audio from the projector selected? (Only when projecting using USB Display) | Click All Programs - EPSON Projector - EPSON USB Display - EPSON USB Display Vx.xx Settings , and then select Output audio from the projector . |

The remote control does not work

| Check | Remedy |
|---|---|
| Is the remote control light-emitting area pointing towards the remote receiver on the projector during operation? | Point the remote control towards the remote receiver. ⚙️ "Remote control operating range" p.17 |
| Is the remote control too far from the projector? | The operating range for the remote control is about 6 m. ⚙️ "Remote control operating range" p.17 |
| Is direct sunlight or strong light from fluorescent lamps shining onto the remote receiver? | Set the projector up in a location where strong light does not shine onto the remote receiver. Or set the remote receiver to Off from Remote Receiver in the Configuration menu. ⚙️ Settings - Remote Receiver p.73 |
| Is the correct setting for the Remote Receiver selected? | Check the Remote Receiver from the Configuration menu. ⚙️ Settings - Remote Receiver p.73 |

| Check | Remedy |
|---|---|
| Are the batteries dead or have the batteries been inserted correctly? | Make sure the batteries are inserted correctly or replace the batteries with new ones if necessary. ☛ "Replacing the remote control batteries" p.17 |
| Are the remote control ID and the projector ID matched? | Make sure the ID for the projector you want to operate and the ID for the remote control match. To operate all projectors by remote control regardless of the ID setting, set the remote control ID to "0". ☛ "Setting the remote control ID" p.57 |

I want to change the language for messages and menus

| Check | Remedy |
|------------------------------|--|
| Change the Language setting. | Adjust the Language setting from the Configuration menu. ☛ Extended - Language p.74 |

Email is not received even if a problem occurs in the projector (EB-1775W/EB-1770W/EB-1760W only)

| Check | Remedy |
|--|---|
| Is Standby Mode set to Communication On ? | To use the Mail Notification function when the projector is in standby, set Communication On in Standby Mode from the Configuration menu. ☛ Extended - Standby Mode p.74 |
| Did a fatal abnormality occur and the projector come to a sudden stop? | When the projector comes to a sudden stop, email cannot be sent. If the abnormal state continues, contact your local dealer or the nearest address provided in the <i>Epson Projector Contact List</i> . ☛ Epson Projector Contact List |
| Is power being supplied to the projector? | Check that your electrical outlet or power source is functioning correctly. |
| Is Mail Notification function set correctly in the Configuration menu? | An error notification email is sent according to the Mail settings in the Configuration menu. Check if it is set correctly. ☛ "Mail menu" p.82 |



Maintenance

This chapter provides information on maintenance procedures to ensure the best level of performance from the projector for a long time to come.

You should clean the projector if it becomes dirty or if the quality of projected images starts to deteriorate.

Attention

Turn off the projector's power before cleaning.

Cleaning the Projector's Surface

Clean the projector's surface by wiping it gently with a soft cloth.

If the projector is particularly dirty, moisten the cloth with water containing a small amount of neutral detergent, and then firmly wring the cloth dry before using it to wipe the projector's surface.

Attention

Do not use volatile substances such as wax, alcohol, or thinner to clean the projector's surface. The quality of the case may change or become discolored.

Cleaning the Lens

Use a commercially available cloth for cleaning glasses to gently wipe the lens.

Warning

Do not use sprays that contain flammable gas to remove dust and lint from the lens. The projector may catch fire due to the high internal temperature of the lamp.

Attention

Do not rub the lens with harsh materials or subject the lens to shocks, as it can easily become damaged.

Cleaning the Air Filter

Clean the air filter and the air intake vent when the following message is displayed.

"The projector is overheating. Make sure nothing is blocking the air vent, and clean or replace the air filter."

Attention

- If dust collects on the air filter it can cause the internal temperature of the projector to rise, and this can lead to problems with operation and shorten the optical engine's service life. Clean the air filter immediately when the message is displayed.
- Do not rinse the air filter in water. Do not use detergents or solvents.

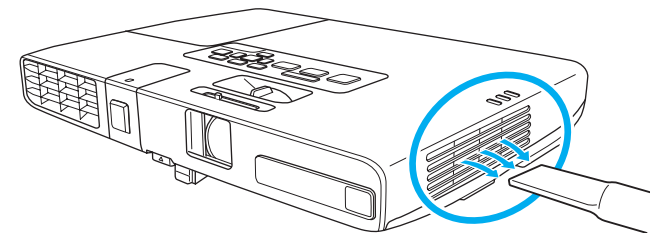



- If a message is frequently displayed, even after cleaning, it is time to replace the air filter. Replace it with a new air filter.
 - ☛ "Replacing the Air Filter" [p.106](#)
- It is recommended that you clean these parts at least once every three months. Clean them more often than this if using the projector in a particularly dusty environment.

This section explains how to replace the lamp and the air filter.

Replacing the Lamp

Lamp replacement period

It is time to replace the lamp when:

- The message "Replace the lamp." is displayed at the lower left of the projection screen when you start projecting.



The message is displayed for 30 seconds.

- The lamp indicator flashes orange.

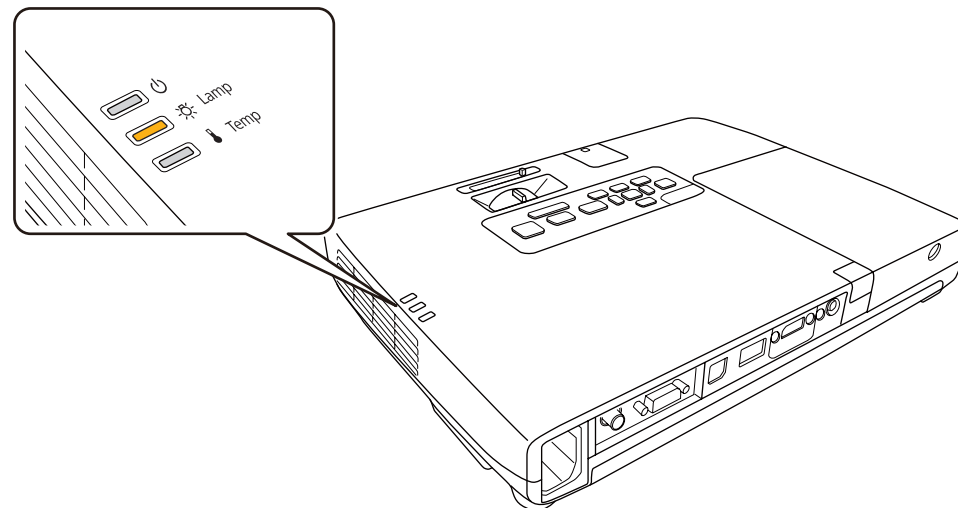

- The projected image gets darker or starts to deteriorate.

Attention

- The lamp replacement message is set to appear after the following time periods in order to maintain the initial brightness and quality of the projected images.

Lamp operating life: about 3900 hours

- If you continue to use the lamp after the replacement period has passed, the possibility that the lamp may explode increases. When the lamp replacement message appears, replace the lamp with a new one as soon as possible, even if it is still working.
- Do not repeatedly turn off the power and immediately back on. Turning the power on and off frequently may shorten the lamp's operating life.
- Depending on the characteristics of the lamp and the way it has been used, the lamp may become darker or stop working before the lamp warning message appears. You should always have a spare lamp unit ready in case it is needed.

How to replace the lamp

The lamp can be replaced even when the projector is suspended from a ceiling.

Warning

- When replacing the lamp because it has stopped illuminating, there is a possibility that the lamp may be broken. If replacing the lamp of a projector which has been installed on the ceiling, you should always assume that the lamp is cracked, and you should stand to the side of the lamp cover, not underneath it. Remove the lamp cover gently.
- Never disassemble or remodel the lamp. If a modified or disassembled lamp is installed in the projector and used, it could cause a fire, electric shock, or an accident.

Caution

Wait until the lamp has cooled down sufficiently before removing the lamp cover. If the lamp is still hot, burns or other injuries may result. It takes about one hour after the power has been turned off for the lamp to be cool enough.

- 1** After you turn off the projector's power and the confirmation buzzer beeps twice, disconnect the power cable.
- 2** Wait until the lamp has sufficiently cooled down, and then remove the lamp cover at the top of the projector.
Loosen the lamp cover fixing screw with the screwdriver supplied with the new lamp unit or a + head screwdriver.

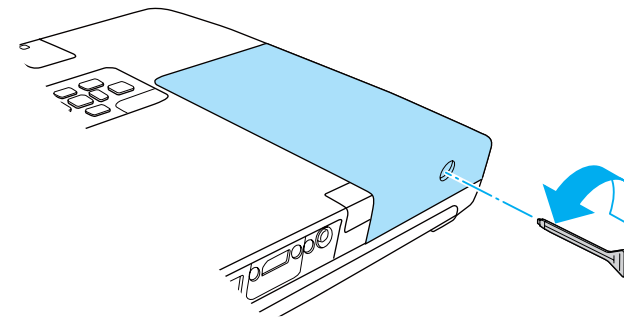

Then slide the lamp cover straight forward and lift it to remove.

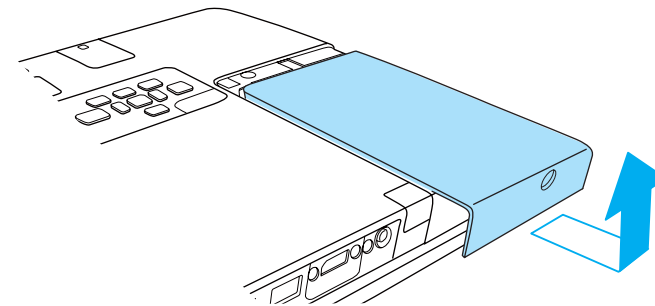

- 3** Raise the lamp fixing spring.

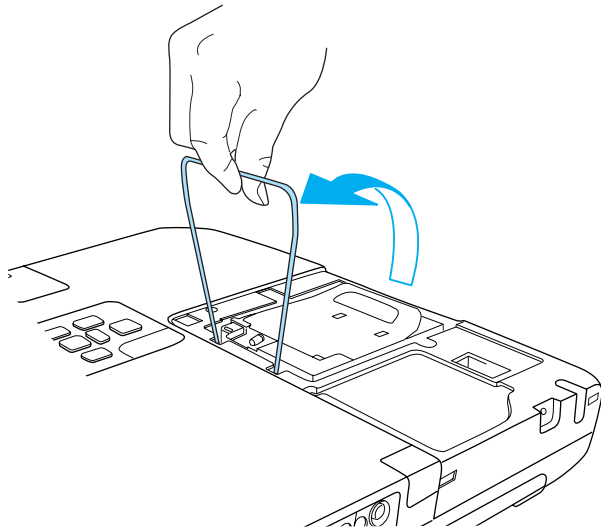

- 4** Raise the handle and take out the old lamp.
If the lamp is cracked, contact your local dealer or the nearest address provided in the *Epson Projector Contact List*.

☛ [Epson Projector Contact List](#)

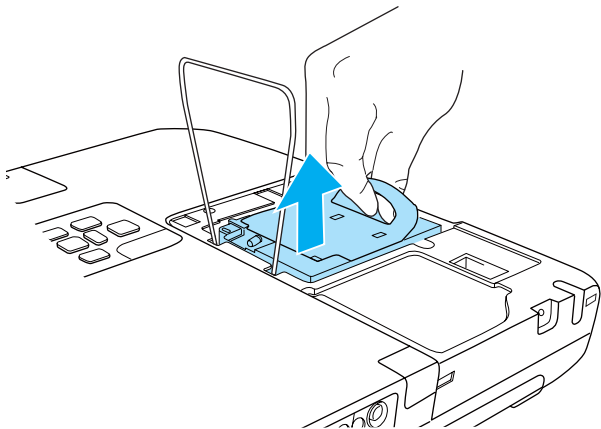

- 5** Install the new lamp.
Insert the new lamp along the guide rails in the correct direction so that it fits, and push it firmly into place. Press down on the part marked PUSH to fix the lamp in place.

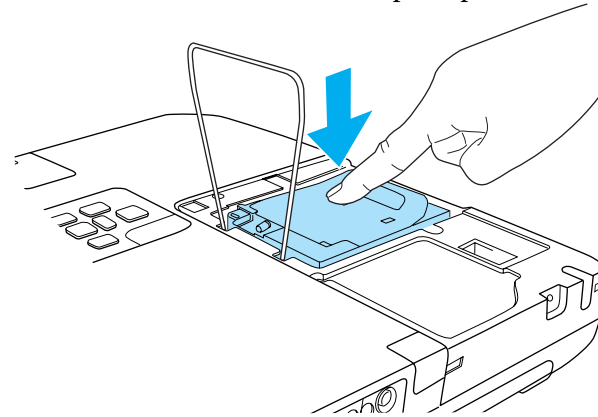

- 6** Lower the lamp fixing spring, and press down on the left and right until it clicks into place.

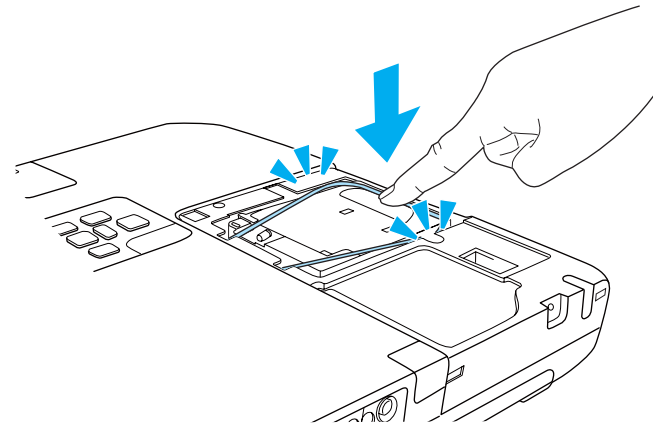

- 7** Replace the lamp cover.
Insert the hook as shown in the illustration below, and attach the cover. Tighten the lamp cover fixing screw.

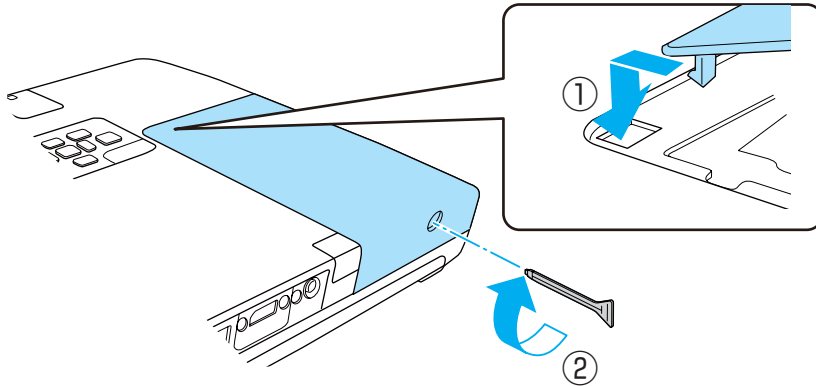

Attention

- Make sure you install the lamp securely. If the lamp cover is removed, the power turns off automatically as a safety precaution. If the lamp or the lamp cover is not installed correctly, the power does not turn on.
- This product includes a lamp component that contains mercury (Hg). Please consult your local regulations regarding disposal or recycling. Do not dispose of it with normal waste.

Resetting the lamp hours

The projector records how long the lamp is turned on and a message and indicator notify you when it is time to replace the lamp. After replacing the lamp, make sure you reset the **Lamp Hours** from the Configuration menu.

☛ "Reset Menu" [p.84](#)



Only reset the **Lamp Hours** after the lamp has been replaced. Otherwise the lamp replacement period is not indicated correctly.

Replacing the Air Filter

Air filter replacement period

It is time to replace the air filter when:

- There is a tear in the air filter.
- The message is displayed even though the air filter has been cleaned.

How to replace the air filter

The air filter can be replaced even when the projector is suspended from a ceiling.

- 1** After you turn off the projector's power and the confirmation buzzer beeps twice, disconnect the power cable.
- 2** Remove the air filter.
Grip the tab in the center of the air filter, and pull it straight out.

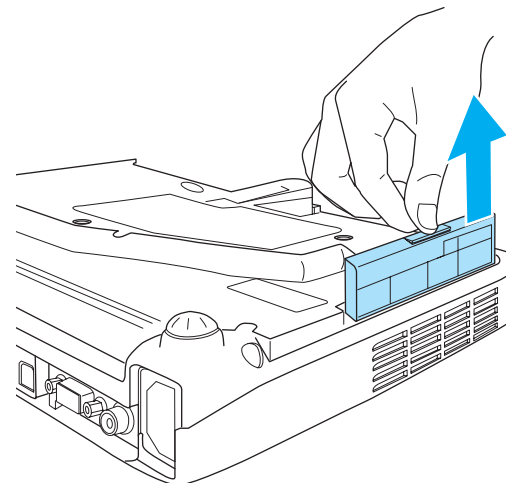

- 3** Install the new air filter.
Push in the air filter until it clicks into place.

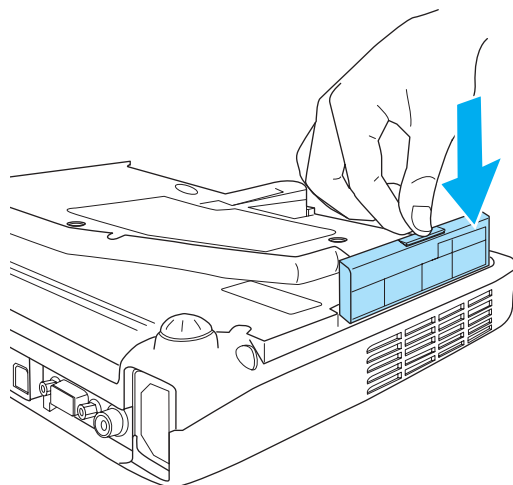

Dispose of used air filters properly in accordance with your local regulations.

Material of the frame part: Polyphenylene ether and polystyrene resin

Material of the filter part: Polyurethane foam



Appendix

EasyMP Network Projection (EB-1775W/EB-1770W/EB-1760W only)

By using the supplied EasyMP Network Projection, you can project your computer screen from the projector via a network. Sharing the projector over the network allows you to project data from different computers without changing the signal cable. Even if the projector is away from the computer, you can still project data via a network. You can also output the computer's audio from the projector.

This projector only supports network projection using a wireless LAN connection.

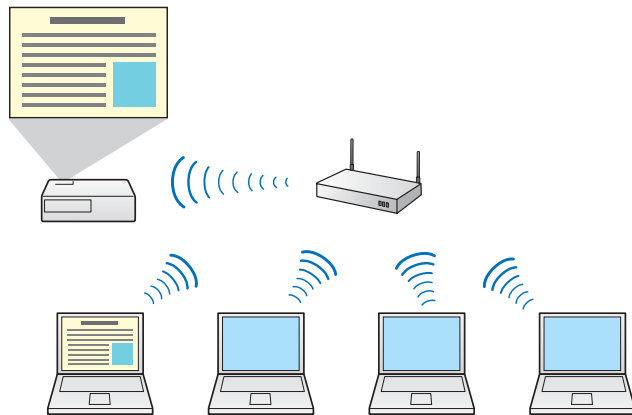

See the following for more details.

☛ [EasyMP Network Projection Operation Guide](#)

EasyMP Slide Converter

By using the supplied EasyMP Slide Converter, you can convert PowerPoint files to scenarios that can be played directly from the projector.

Save the converted scenario to a USB storage device. When the USB storage device is connected to the projector, Slideshow starts.

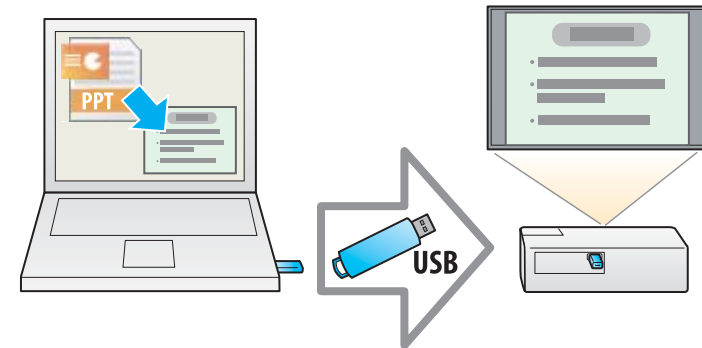

See the following for more details.

☛ [EasyMP Slide Converter Operation Guide](#)

☛ "Slideshow operating methods" p.46

EasyMP Monitor (EB-1775W/EB-1770W/EB-1760W only)

By using EasyMP Monitor, you can check the status of multiple Epson projectors on the network, and you can control them from your computer.

You can download EasyMP Monitor from the following Web site.

<http://www.epson.com>

The following optional accessories and consumables are available. Please purchase these products as and when needed. The following list of optional accessories and consumables is current as of: August 2010. Details of accessories are subject to change without notice and availability may vary depending on the country of purchase.

Optional Accessories

50" portable screen ELPSC06

A compact screen that can be carried easily. ([aspect ratio](#) ▶▶ 4:3)

60" portable screen ELPSC27

80" portable screen ELPSC28

100" screen ELPSC29

Portable roll-type screens. (aspect ratio 4:3)

53" portable screen ELPSC30

64" portable screen ELPSC31

Portable magnetic screens. (aspect ratio 4:3)

Computer cable ELPKC02

(1.8 m - for mini D-Sub15-pin/mini D-Sub 15pin)

This is the same as the computer cable supplied with the projector.

Computer cable ELPKC09

(3 m - for mini D-Sub15-pin/mini D-Sub 15pin)

Computer cable ELPKC10

(20 m - for mini D-Sub15-pin/mini D-Sub 15pin)

Use one of these longer cables if the computer cable supplied with the projector is too short.

Component video cable ELPKC19

(3 m - for mini D-Sub 15-pin/RCA male×3)

Use to connect a [component video](#) ▶▶ source.

Document camera ELPDC06

Use when projecting images such as books, OHP documents, or slides.

Wireless LAN unit ELPAP07 (EB-1770W/EB-1760W only)

Use when connecting the projector to a computer wirelessly and projecting.

Quick Wireless Connection USB Key ELPAP08 (EB-1775W/EB-1770W/EB-1760W only)

Use when you want to quickly establish one-to-one connection between the projector and a computer with Windows installed.

Ceiling pipe (450 mm)* ELPFP13

Ceiling pipe (700 mm)* ELPFP14

Use when installing the projector on a high ceiling.

Ceiling mount* ELPMB23

Use when installing the projector on a ceiling.

Attachment plate* ELPPT01

Use when attaching the ceiling mount to the projector.

* Special expertise is required to suspend the projector from a ceiling. Contact your local dealer or the nearest address provided in the *Epson Projector Contact List*.

👉 [Epson Projector Contact List](#)

Consumables

Lamp unit ELPLP65

Use as a replacement for used lamps.

Air filter ELPAF31

Use as a replacement for used air filters.

Changing Settings Using a Web Browser (Web Control)

By using the Web browser of a computer connected to the projector on a network, you can make settings and control the projector. This function allows you to perform setup and control operations remotely. In addition, since you can use the computer's keyboard, entering characters required for the setup is easier.

Use Microsoft Internet Explorer 6.0 or later as the Web browser. You can also use Safari if you are using Mac OS.



If you set **Standby Mode** to **Communication On**, you can use the Web browser to make settings and perform control even if the projector is in standby mode (when the power is off).

☛ **Extended - Standby Mode** p.74

Projector setup

In the Web browser, you can set items that are usually set in the projector's Configuration menu. The settings are reflected in the Configuration menu. There are also items that can only be set in the Web browser.

Items in the Configuration menu that cannot be set by the Web browser

- Settings Menu - Pointer Shape
- Settings Menu - Test Pattern
- Settings Menu - User Button
- Extended Menu - User's Logo
- Extended Menu - Language
- Extended Menu - Operation - High Altitude Mode
- Extended Menu - Operation - Lens Cover Timer
- Reset Menu - Reset All and Reset Lamp Hours

The settings for items on each menu are the same as the projector's Configuration menu.

☛ "Configuration Menu" p.66

Items that can only be set with a Web browser

- SNMP Community Name
- Monitor Password

Displaying the Web Control screen

Use the following procedure to display the Web Control screen.



If your Web browser is set up to connect via a proxy server, the Web Control screen cannot be displayed. To display Web Control, you need to make settings so that a proxy server is not used for a connection.

- 1** Start the Web browser on the computer.
- 2** Enter the IP address of the projector in the address input box of the Web browser, and press the Enter key on the computer's keyboard.
The Web Control screen is displayed.
When Web Control Password is set in the Network menu from the projector's Configuration menu, the password entry screen is displayed.

Displaying the Web Remote screen

The Web Remote function allows you to perform projector remote control operations with a Web browser.

- 1** Display the Web Control screen.

2 Click Web Remote.



3 The Web Remote screen is displayed.

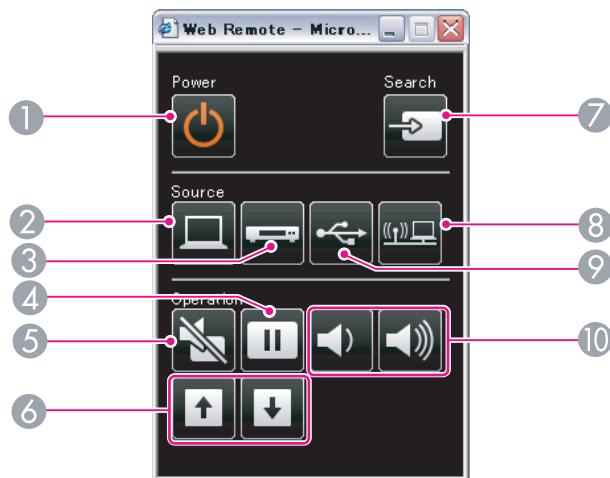

| Name | Function |
|---------------------|--|
| 1 [Power] button | Turns the projector power on or off. ☛ "From Installation to Projection" p.26 |
| 2 [Computer] button | Changes to images from the Computer port. |
| 3 [Video] button | Each time you press the button, the input source changes between images from the Video port and the HDMI port (EB-1775W/EB-1770W/EB-1760W only). |
| 4 [Freeze] button | Images are paused or unpaused. ☛ "Freezing the Image (Freeze)" p.52 |

| Name | Function |
|---|--|
| 5 [A/V Mute] button | Turns the video and audio on or off. ☛ "Hiding the Image and Sound Temporarily (A/V Mute)" p.51 |
| 6 [Page] buttons [Up] [Down] | Changes pages in files such as PowerPoint files when using the following projection methods. <ul style="list-style-type: none"> • When using the Wireless Mouse function ☛ "Using the Remote Control to Operate the Mouse Pointer (Wireless Mouse)" p.54 • When using USB Display ☛ "Projecting with USB Display" p.28 • During a network connection (EB-1775W/EB-1770W/EB-1760W only) When projecting images or scenarios using Slideshow, pressing these buttons displays the previous/next screen. |
| 7 [Source Search] button | Changes to the next input source that is sending an image. ☛ "Automatically Detect Input Signals and Change the Projected Image (Source Search)" p.27 |
| 8 [LAN] button | Changes to the image projected with EasyMP Network Projection. When projecting using the supplied or optional Quick Wireless Connection USB Key, this button switches to that image. (EB-1775W/EB-1770W/EB-1760W only) ☛ "Switching to the Target Image by Remote Control" p.28 |
| 9 [USB] button | Each time the button is pressed, it cycles through the following images: <ul style="list-style-type: none"> • USB Display • Images from the device connected to the USB port ☛ "Switching to the Target Image by Remote Control" p.28 |
| 10 [Volume] buttons [Decrease] [Increase] | [Decrease] Decreases the volume. [Increase] Increases the volume. ☛ "Adjusting the Volume" p.38 |

Using the Mail Notification Function to Report Problems

When you set Mail Notification, notification messages are sent to the preset email addresses when a problem or warning occurs with a projector. This will enable the operator to be notified of problems with projectors even at locations away from the projectors.

 [Network - Mail - Mail Notification p.82](#)



- Up to a maximum of three notification destinations (addresses) can be registered, and notification messages can be sent to all three destinations at once.
- If a projector develops a critical problem and suddenly stops working, it may not be able to send a message notifying an operator of the problem.
- If you set **Standby Mode** to **Communication On**, you can control the projector even if it is in standby mode (when the power is off).

 [Extended - Standby Mode p.74](#)

Reading Error Notification Mail

When the Mail Notification function is set to On and a problem or warning occurs in the projector, the following email will be sent.

Subject: EPSON Projector

Line 1: The projector name where the problem has occurred

Line 2: The IP address set for the projector where the problem has occurred.

Line 3 and on: Details of the problem

The following messages are listed line by line to indicate the details of the problem. See the following to deal with problems or warnings.

 ["Reading the Indicators" p.88](#)

- Internal error
- Fan related error
- Sensor error
- Lamp timer failure
- Lamp out
- Internal temperature error
- High-speed cooling in progress
- Lamp replacement notification
- No-signal
- Auto Iris Error
- Power Err. (Ballast)

A (+) or (-) appears at the start of the message.

(+): A projector problem has occurred

(-): A projector problem has been dealt with

Management Using SNMP

By setting **SNMP** to **On**, notification messages are sent to preset email addresses when a problem or warning occurs. This will enable the operator to be notified of problems with projectors even at locations away from the projectors.

 [Network - Others - SNMP p.82](#)



- SNMP should be managed by a network administrator or someone who is familiar with the network.
- To use the SNMP function to monitor the projector, you need to install the SNMP manager program on your computer.
- The managing function using SNMP cannot be used via wireless LAN in Quick connection mode.
- Up to two destination IP addresses can be saved.

ESC/VP21 Commands

You can monitor and control the projector from a computer via USB. Connect the device and the projector with a USB cable, and then enter the communication commands (ESC/VP21 commands).

Before starting

To control and monitor the projector using ESC/VP21 commands, the following preparations must be carried out.

- 1** Install the USB communication driver (EPSON USB-COM Driver) to your computer. For information about the EPSON USB-COM Driver, contact your local dealer or the nearest address provided in the Epson Projector Contact List.
 - ☛ [Epson Projector Contact List](#)
- 2** Set **USB Type B** to **Link 21L** from the projector's Configuration menu.
 - ☛ **Extended** - [USB Type B p.74](#)
- 3** Set **Link 21L** to **On**.
 - ☛ **Extended** - [Link 21L p.74](#)
- 4** Connect the computer's USB port to the projector's USB (Type B) port with a USB cable.

Start from step 2 from the second time.

Command list

When the power ON command is transmitted to the projector, the power turns on and it enters warm-up mode. When the projector's power has turned on, a colon ":" (3Ah) is returned.

When a command is input, the projector executes the command and returns a ":", and then accepts the next command.

If the command being processed terminates abnormally, an error message is output and a ":" is returned.

| Item | | Command | |
|---------------------------------------|--|-----------|-----------|
| Power ON/OFF | On | PWR ON | |
| | Off | PWR OFF | |
| Signal selection | Computer | Auto | SOURCE 1F |
| | | RGB | SOURCE 11 |
| | | Component | SOURCE 14 |
| | HDMI (EB-1775W/EB-1770W/ EB-1760W only) | | SOURCE 30 |
| | Video | | SOURCE 41 |
| | USB Display | | SOURCE 51 |
| | USB | | SOURCE 52 |
| A/V Mute On/Off | On | MUTE ON | |
| | Off | MUTE OFF | |
| A/V Mute selection | Black | MSEL 00 | |
| | Blue | MSEL 01 | |
| | Logo | MSEL 02 | |
| LAN (EB-1775W/EB-1770W/EB-1760W only) | | SOURCE 53 | |

Add a Carriage Return (CR) code (0Dh) to the end of each command and transmit.

Communications protocol



- Default baud rate setting: 9600 bps
- Data length: 8 bit
- Parity: None



- Stop-bit: 1 bit
- Flow control: None

Check the numbers and then apply the following countermeasures. If you cannot resolve the problem, contact your network administrator, or contact your local dealer or the nearest address provided in the Epson Projector Contact List.

 [Epson Projector Contact List](#)

| Event ID | Cause | Remedy |
|------------------------------|---|---|
| 0432 0435 | Failed to startup EasyMP Network Projection. | Restart the projector. |
| 0434 0482 0484 0485 | Network communication is unstable. | Check the network communication status, and reconnect after waiting for a while. |
| 0433 | Cannot play transferred images. | Restart EasyMP Network Projection. |
| 0481 | Communication was disconnected from the computer. | |
| 0483 04FE | EasyMP Network Projection ended unexpectedly. | Check the network communication status, and then restart the projector. |
| 0479 04FF | A system error occurred in the projector. | Restart the projector. |
| 0891 | Cannot find an access point with the same SSID. | Set the computer, the access point, and the projector to the same SSID. |
| 0892 | The WPA/WPA2 authentication type does not match. | Check that the wireless LAN security settings are correct. |
| 0893 | The WEP/TKIP/AES encryption type does not match. |  Security p.80 |
| 0894 | Communication was disconnected because the projector connected to an unauthorized access point. | Contact your network administrator for more information. |
| 0898 | Failed to acquire DHCP. | Check that the DHCP server is operating correctly. If you are not using DHCP, turn off the DHCP setting.  Wireless LAN - IP Settings p.79 |
| 0895 0899 | Other communication errors | If restarting the projector or EasyMP Network Projection does not solve the problem, contact your local dealer or the nearest address provided in the Epson Projector Contact List.  Epson Projector Contact List |

PJLink Class1 was established by the JBMIA (Japan Business Machine and Information System Industries Association) as a standard protocol for controlling network-compatible projector's as part of their efforts to standardize projector control protocols.

The projector complies with the PJLink Class1 standard established by the JBMIA.

It complies with all commands except for the following commands defined by PJLink Class1, and agreement was confirmed by the PJLink standard adaptability verification.

URL: <http://pjlink.jbmia.or.jp/english/>

- **Non-compatible commands**

| | Function | PJLink Command |
|---------------|------------------|----------------|
| Mute settings | Image muting set | AVMT 11 |
| | Audio muting set | AVMT 21 |

- **Input names defined by PJLink and corresponding projector sources**

| Source | PJLink Command |
|-------------|----------------|
| Computer | INPT 11 |
| Video | INPT 21 |
| HDMI | INPT 32 |
| USB | INPT 41 |
| LAN | INPT 52 |
| USB Display | INPT 53 |

- Manufacturer name displayed for "Manufacture name information query"
EPSON

- Model name displayed for "Product name information query"
EB-1775W/PowerLite 1775W/EB-C300MS
EB-1770W/PowerLite 1770W/EB-C300MN/EB-C3010WN
EB-1760W/PowerLite 1760W/EB-C260MN

Projection Distance (For EB-1775W/EB-1770W/EB-1760W)

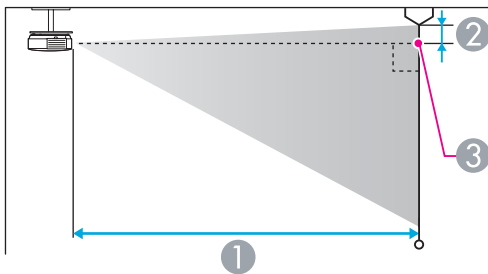
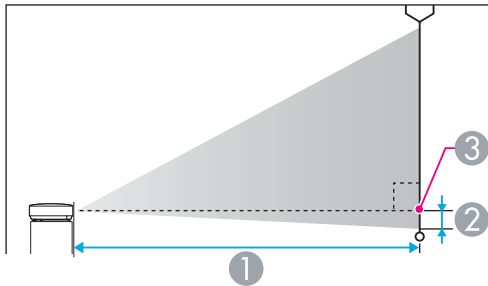

- ① Projection distance
- ② Distance from the center of the lens to the base of the screen (or to the top of the screen, if suspended from a ceiling)
- ③ Center of lens

Unit: cm

| 4:3 Screen Size | | ① | ② |
|-----------------|-------|----------------------------------|----|
| | | Minimum (Wide) to Maximum (Tele) | |
| 28" | 57x43 | 71 - 85 | -4 |
| 30" | 61x46 | 76 - 91 | -4 |

| 4:3 Screen Size | | ① | ② |
|-----------------|---------|----------------------------------|-----|
| | | Minimum (Wide) to Maximum (Tele) | |
| 40" | 81x61 | 102 - 122 | -6 |
| 50" | 100x76 | 127 - 153 | -7 |
| 60" | 120x91 | 153 - 184 | -8 |
| 80" | 160x120 | 205 - 246 | -11 |
| 100" | 200x150 | 256 - 308 | -14 |
| 150" | 300x230 | 385 - 462 | -21 |
| 200" | 410x300 | 514 - 617 | -28 |
| 250" | 500x380 | 643 - 771 | -35 |
| 260" | 520x400 | 668 - 802 | -36 |

Unit: cm

| 16:9 Screen Size | | ① | ② |
|------------------|---------|----------------------------------|-----|
| | | Minimum (Wide) to Maximum (Tele) | |
| 30" | 66x37 | 69 - 83 | -2 |
| 40" | 89x50 | 92 - 111 | -2 |
| 50" | 110x62 | 115 - 139 | -3 |
| 60" | 130x75 | 139 - 167 | -3 |
| 70" | 160x87 | 162 - 195 | -4 |
| 80" | 180x100 | 186 - 223 | -5 |
| 100" | 220x120 | 232 - 279 | -6 |
| 150" | 330x190 | 349 - 419 | -8 |
| 200" | 440x250 | 466 - 560 | -11 |
| 250" | 550x310 | 583 - 700 | -14 |
| 280" | 620x350 | 653 - 784 | -16 |

Unit: cm

| 16:10 Screen Size | | ① | |
|-------------------|---------|----------------------------------|--|
| | | Minimum (Wide) to Maximum (Tele) | |
| 30" | 64x40 | 67 - 80 | |
| 40" | 86x54 | 89 - 108 | |
| 50" | 110x67 | 112 - 135 | |
| 60" | 130x81 | 135 - 162 | |
| 80" | 170x110 | 181 - 217 | |
| 100" | 220x130 | 226 - 271 | |
| 150" | 320x200 | 340 - 408 | |
| 200" | 430x270 | 454 - 545 | |
| 250" | 540x340 | 567 - 681 | |
| 300" | 640x400 | 681 - 818 | |

②

Projection Distance (For EB-1750)

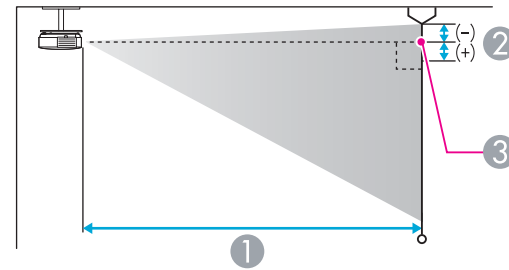
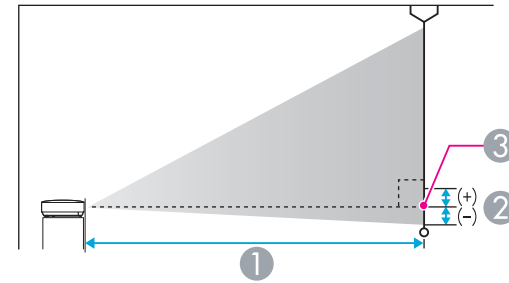

- ① Projection distance
- ② Distance from the center of the lens to the base of the screen (or to the top of the screen, if suspended from a ceiling)
- ③ Center of lens

Unit: cm

| 4:3 Screen Size | | ① | |
|-----------------|--------|----------------------------------|--|
| | | Minimum (Wide) to Maximum (Tele) | |
| 30" | 61x46 | 72 - 86 | |
| 40" | 81x61 | 96 - 116 | |
| 50" | 100x76 | 120 - 145 | |

②

| 4:3 Screen Size | | ① | ② |
|-----------------|---------|----------------------------------|-----|
| | | Minimum (Wide) to Maximum (Tele) | |
| 60" | 120x91 | 145 - 174 | -10 |
| 80" | 160x120 | 194 - 233 | -14 |
| 100" | 200x150 | 242 - 291 | -17 |
| 150" | 300x230 | 364 - 438 | -26 |
| 200" | 410x300 | 486 - 584 | -34 |
| 250" | 510x380 | 608 - 730 | -43 |
| 300" | 610x460 | 730 - 877 | -51 |

Unit: cm

| 16:9 Screen Size | | ① | ② |
|------------------|---------|----------------------------------|----|
| | | Minimum (Wide) to Maximum (Tele) | |
| 30" | 66x37 | 78 - 94 | +1 |
| 40" | 89x50 | 105 - 126 | +1 |
| 50" | 110x62 | 131 - 158 | +1 |
| 60" | 130x75 | 158 - 190 | +1 |
| 70" | 160x87 | 185 - 222 | +1 |
| 80" | 180x100 | 211 - 254 | +2 |
| 100" | 220x120 | 264 - 317 | +2 |
| 150" | 330x190 | 397 - 477 | +3 |
| 200" | 440x250 | 530 - 636 | +4 |
| 250" | 550x310 | 663 - 796 | +5 |
| 275" | 610x340 | 729 - 875 | +6 |

Supported Resolutions

Computer signals (analog RGB)

| Signal | Refresh Rate (Hz) | Resolution (dots) |
|-------------|-------------------|-------------------|
| VGA | 60/72/75/85 | 640x480 |
| SVGA | 56/60/72/75/85 | 800x600 |
| XGA | 60/70/75/85 | 1024x768 |
| WXGA | 60 | 1280x768 |
| | 60 | 1360x768 |
| | 60/75/85 | 1280x800 |
| WXGA+ | 60/75/85 | 1440x900 |
| SXGA | 70/75/85 | 1152x864 |
| | 60/75/85 | 1280x1024 |
| | 60/75/85 | 1280x960 |
| SXGA+ | 60/75 | 1400x1050 |
| WSXGA+*1, 2 | 60 | 1680x1050 |
| UXGA | 60 | 1600x1200 |
| MAC13" | 67 | 640x480 |
| MAC16" | 75 | 832x624 |
| MAC19" | 75 | 1024x768 |
| | 59 | 1024x768 |
| MAC21" | 75 | 1152x870 |

*1 (EB-1775W/EB-1770W/EB-1760W only)

*2 Only compatible when **Wide** is selected as the **Resolution** from the Configuration menu.

Even when signals other than those mentioned above are input, it is likely that the image can be projected. However, not all functions may be supported.

Component video

| Signal | Refresh Rate (Hz) | Resolution (dots) |
|--------------|-------------------|-------------------|
| SDTV (480i) | 60 | 720x480 |
| SDTV (576i) | 50 | 720x576 |
| SDTV (480p) | 60 | 720x480 |
| SDTV (576p) | 50 | 720x576 |
| HDTV (720p) | 50/60 | 1280x720 |
| HDTV (1080i) | 50/60 | 1920x1080 |
| HDTV (1080p) | 24/30/50/60 | 1920x1080 |

Composite video

| Signal | Refresh Rate (Hz) | Resolution (dots) |
|------------|-------------------|-------------------|
| TV (NTSC) | 60 | 720x480 |
| TV (SECAM) | 50 | 720x576 |
| TV (PAL) | 50/60 | 720x576 |

Input signal from the HDMI port (EB-1775W/EB-1770W/EB-1760W only)

| Signal | Refresh Rate (Hz) | Resolution (dots) |
|--------|-------------------|-------------------|
| VGA | 60 | 640x480 |
| SVGA | 60 | 800x600 |
| XGA | 60 | 1024x768 |
| WXGA | 60 | 1280x800 |
| SXGA | 60 | 1280x960 |
| | 60 | 1280x1024 |
| SXGA+ | 60 | 1400x1050 |



| Signal | Refresh Rate (Hz) | Resolution (dots) |
|------------------|-------------------|-------------------|
| UXGA | 60 | 1600x1200 |
| SDTV (480i/480p) | 60 | 720x480 |
| SDTV (576i/576p) | 50 | 720x576 |
| HDTV (720p) | 50/60 | 1280x720 |
| HDTV (1080i) | 50/60 | 1920x1080 |
| HDTV (1080p) | 24/30/50/60 | 1920x1080 |

Projector General Specifications

| | | | | | |
|------------------------------|--------------------------|--|--|--|--|
| Product name | | EB-1775W | EB-1770W | EB-1760W | EB-1750 |
| Dimensions | | 292 (W) x 44 (H) x 210 (D) mm (not including raised section) | | | |
| LCD panel size | | 0.59" Wide | | | 0.55" |
| Display method | | Polysilicon TFT active matrix | | | |
| Resolution | | 1,024,000 pixels WXGA (1280 (W)x 800 (H) dots)x 3 | | | 786,432 pixels XGA (1024 (W) x 768 (H) dots)x 3 |
| Focus adjustment | | Electric/Auto | Manual | | |
| Zoom adjustment | | Manual (1 to 1.2) | | | |
| Lamp | | UHE lamp, 230 W Model No.: ELPLP65 | UHE lamp, 205 W Model No.: ELPLP65 | UHE lamp, 230 W Model No.: ELPLP65 | |
| Max. audio output | | 1 W monaural | | | |
| Speaker | | 1 | | | |
| Power supply | | 100 to 240 V AC \pm 10%, 50/60 Hz 3.3 to 1.5 A | 100 to 240 V AC \pm 10%, 50/60 Hz 3.0 to 1.4 A | 100 to 240 V AC \pm 10%, 50/60 Hz 3.3 to 1.5 A | |
| Power consumption | 100 to 120 V area | Operating: 322 W Standby power consumption (Communication On): 7.4 W Standby power consumption (Communication Off): 0.38 W | Operating: 293 W Standby power consumption (Communication On): 7.4 W Standby power consumption (Communication Off): 0.38 W | Operating: 322 W Standby power consumption (Communication On): 7.4 W Standby power consumption (Communication Off): 0.38 W | |
| | 220 to 240 V area | Operating: 304 W Standby power consumption (Communication On): 7.7 W Standby power consumption (Communication Off): 0.44 W | Operating: 278 W Standby power consumption (Communication On): 7.7 W Standby power consumption (Communication Off): 0.44 W | Operating: 304 W Standby power consumption (Communication On): 7.7 W Standby power consumption (Communication Off): 0.44 W | |
| Operating altitude | | Altitude 0 to 2,286 m | | | |
| Operating temperature | | 5 to +35°C (No condensation) | | | |
| Storage temperature | | -10 to +60°C (No condensation) | | | |

| | |
|-------------|----------------|
| Mass | Approx. 1.7 kg |
|-------------|----------------|

| Product name | | | EB-1775W | EB-1770W | EB-1760W | EB-1750 |
|-------------------------------|---|----------|---------------------------------------|----------|----------|---------|
| Con- nec- tors | Computer port | 1 | Mini D-Sub15-pin (female) | | | |
| | Video port | 1 | RCA pin jack | | | |
| | Audio port | 1 | Stereo mini jack | | | |
| | HDMI port | 1 | HDMI (Audio is only supported by PCM) | | | - |
| | USB (TypeA) Port* | 1 | USB connector (Type A) | | | |
| | USB (TypeB) Port* | 1 | USB connector (Type B) | | | |
| | USB port (dedicated Wireless LAN unit) | 1 | USB connector (Type A) | | | - |

* Supports USB 2.0. However, USB ports are not guaranteed to operate all devices that support USB.

This product is also designed for IT power distribution system with phase-to-phase voltage 230V.

Angle of tilt

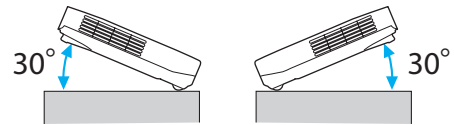

If you use the projector tilted at an angle of more than 30° it could be damaged and cause an accident.

DECLARATION of CONFORMITY

According to 47CFR, Part 2 and 15

Class B Personal Computers and Peripherals; and/or
CPU Boards and Power Supplies used with Class B Personal Computers

We: Epson America, Inc.
Located at: 3840 Kilroy Airport Way
MS: 3-13
Long Beach, CA 90806
Tel: 562-290-5254

Declare under sole responsibility that the product identified herein, complies with 47CFR Part 2 and 15 of the FCC rules as a Class B digital device. Each product marketed, is identical to the representative unit tested and found to be compliant with the standards. Records maintained continue to reflect the equipment being produced can be expected to be within the variation accepted, due to quantity production and testing on a statistical basis as required by 47CFR 2.909. Operation is subject to the following two conditions : (1) this device may not cause harmful interference, and (2) this device must accept any interference received, including interference that may cause undesired operation.

Trade Name: EPSON
Type of Product: Projector
Model: H361C/H362C/H363C/H372C

FCC Compliance Statement For United States Users

This equipment has been tested and found to comply with the limits for a Class B digital device, pursuant to Part 15 of the FCC Rules. These limits are designed to provide reasonable protection against harmful interference in a residential installation. This equipment generates, uses, and can radiate radio frequency energy and, if not installed and used in accordance with the instructions, may cause harmful interference to radio or television reception. However, there is no guarantee that interference will not occur in a particular installation. If this equipment does cause interference to radio and television reception, which can be determined by turning the equipment off and on, the user is encouraged to try to correct the interference by one or more of the following measures.

- Reorient or relocate the receiving antenna.
- Increase the separation between the equipment and receiver.
- Connect the equipment into an outlet on a circuit different from that to which the receiver is connected.
- Consult the dealer or an experienced radio/TV technician for help.

WARNING

The connection of a non-shielded equipment interface cable to this equipment will invalidate the FCC Certification or Declaration of this device and may cause interference levels which exceed the limits established by the FCC for this equipment. It is the responsibility of the user to obtain and use a shielded equipment interface cable with this device. If this equipment has more than one interface connector, do not leave cables connected to unused interfaces. Changes or modifications not expressly approved by the manufacturer could void the user's authority to operate the equipment.

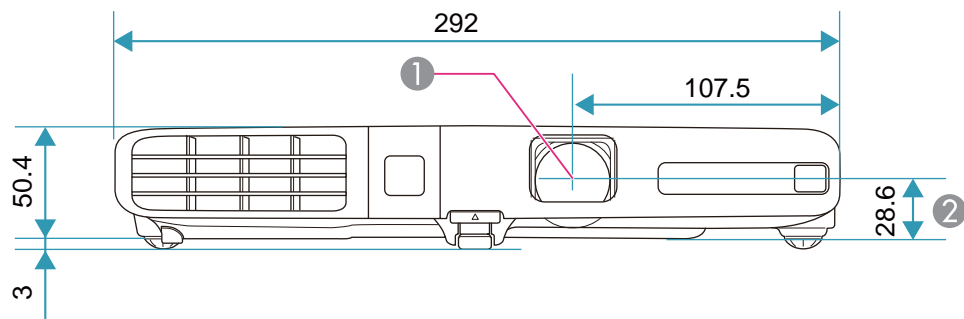

- ① Center of lens
- ② Distance from center of lens to suspension bracket fixing point

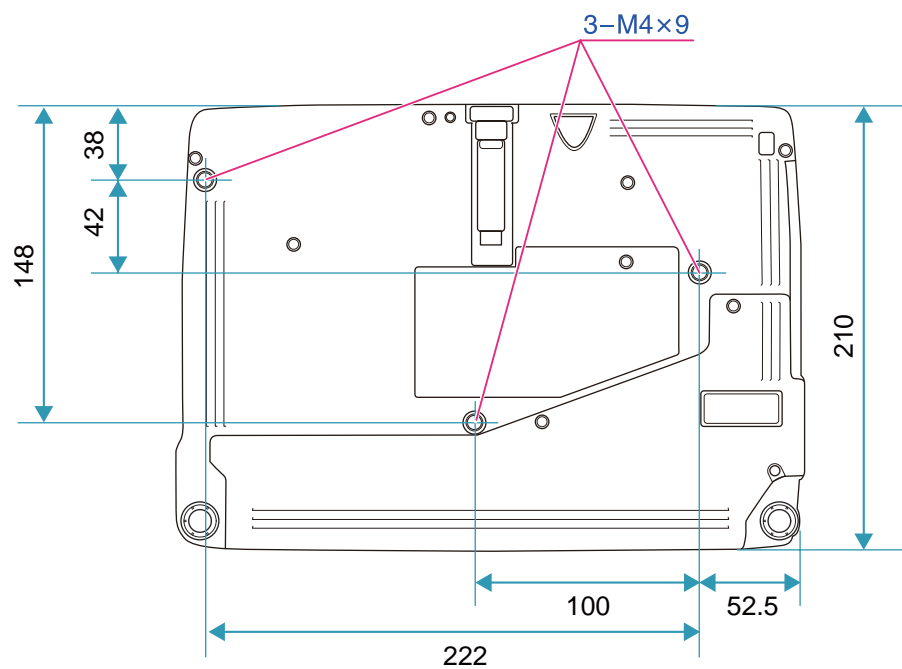

Units: mm

This section briefly explains the difficult terms that are not explained in the text of this guide. For details, refer to other commercially available publications.

| | |
|-----------------------------|--|
| AMX Device Discovery | AMX Device Discovery is a technology developed by AMX to facilitate AMX control systems for easy operation of the target equipment. Epson have implemented this protocol technology, and have provided a setting to enable the protocol function (ON). See the AMX Web site for more details. URL http://www.amx.com/ |
| Aspect Ratio | The ratio between an image's length and its height. Screens with a horizontal:vertical ratio of 16:9, such as HDTV screens, are known as wide screens. SDTV and general computer displays have an aspect ratio of 4:3. |
| Component Video | A method that separates the video signal into a luminance component (Y), and a blue minus luminance (Cb or Pb) and a red minus luminance (Cr or Pr). |
| Composite video | A method that combines the video signal into a luminance component and a color component for transmission down a single cable. |
| Contrast | The relative brightness of the light and dark areas of an image can be increased or decreased to make text and graphics stand out more clearly, or to make them appear softer. Adjusting this particular property of an image is called contrast adjustment. |
| DHCP | An abbreviation of Dynamic Host Configuration Protocol, this protocol automatically assigns an IP address to equipment connected to a network. |
| Gateway Address | This is a server (router) for communicating across a network (subnet) divided according to subnet mask . |
| HDCP | HDCP is an abbreviation for High-bandwidth Digital Content Protection. It is used to prevent illegal copying and protect copyrights by encrypting digital signals sent over DVI and HDMI ports. Because the HDMI port on this projector supports HDCP, it can project digital images protected by HDCP technology. However, the projector may not be able to project images protected with updated or revised versions of HDCP encryption. |
| HDTV | An abbreviation for High-Definition Television that refers to high-definition systems which satisfy the following conditions. <ul style="list-style-type: none"> • Vertical resolution of 720p or 1080i or greater (p = Progressive, i = Interlace) • Screen aspect ratio of 16:9 |
| Interlace | Transmits information needed to create one screen by sending every other line, starting from the top of the image and working down to the bottom. Images are more likely to flicker because one frame is displayed every other line. |
| IP Address | A number to identify a computer connected to a network. |
| Progressive | Projects information to create one screen at a time, displaying the image for one frame. Even though the number of scan lines is the same, the amount of flicker in images decreases because the volume of information has doubled compared with an interlace system. |
| SDTV | An abbreviation for Standard Definition Television that refers to standard television systems which do not satisfy the conditions for HDTV High-Definition Television. |
| SNMP | An abbreviation for Simple Network Management Protocol, which is the protocol for monitoring and controlling devices such as routers and computers connected to a TCP/IP network. |

| | |
|------------------------|---|
| sRGB | An international standard for color intervals that was formulated so that colors that are reproduced by video equipment can be handled easily by computer operating systems (OS) and the Internet. If the connected source has an sRGB mode, set both the projector and the connected signal source to sRGB. |
| SSID | SSID is identification data for connecting to another device on a wireless LAN. Wireless communication is possible between devices with matching SSID. |
| Subnet Mask | This is a numerical value that defines the number of bits used for the network address on a divided network (subnet) from the IP address. |
| SVGA | A screen size standard with a resolution of 800 (horizontal) x 600 (vertical) dots. |
| S-Video | A method that separates the video signal into a luminance component (Y) and a color component (C). |
| SXGA | A screen size standard with a resolution of 1,280 (horizontal) x 1,024 (vertical) dots. |
| Sync. | The signals output from computers have a specific frequency. If the projector frequency does not match this frequency, the resulting images are not of a good quality. The process of matching the phases of these signals (the relative position of the crests and the troughs in the signal) is called Synchronization. If the signals are not synchronized, flickering, blurriness, and horizontal interference occur. |
| Tracking | The signals output from computers have a specific frequency. If the projector frequency does not match this frequency, the resulting images are not of a good quality. The process of matching the frequency of these signals (the number of crests in the signal) is called Tracking. If Tracking is not carried out correctly, wide vertical stripes appear in the signal. |
| Trap IP Address | This is the IP address for the destination computer used for error notification in SNMP. |
| VGA | A screen size standard with a resolution of 640 (horizontal) x 480 (vertical) dots. |
| XGA | A screen size standard with a resolution of 1,024 (horizontal) x 768 (vertical) dots. |