

EPSON®

MEDIA PROJECTOR
ULTI

User's Guide

EMP-820
EMP-811
EMP-600

M
U
L
T
I
M
E
D
I
A



About The Manuals and Notations Used

◆ Types of Manual

The documentation for your EPSON projector is divided into the following three manuals. The manuals cover the following topics.

- **User's Guide (this manual)**
This Users Guide contains information on installing the projector, basic operation, using the projector menus, troubleshooting and maintenance.
- **Safety Instructions/World-Wide Warranty Terms**
This manual contains information on using the projector safely, and also includes World-Wide Warranty Terms and a Troubleshooting check sheet.
Be sure to read this manual thoroughly before using the projector.
- **Quick Reference Guide**
Contains an overview of the most commonly-used projector functions for easy reference. You should keep this Quick Reference Guide near the projector at all times and refer to it before starting presentations and while using the projector in order to check details of operation.

◆ Notations used in this Users Guide

General information

Caution :	Indicates procedures which may result in damage or injury if sufficient care is not taken.
Tip :	Indicates additional information and points which may be useful to know regarding a topic.
▶▶	Indicates that an explanation of the underlined word or words in front of this symbol appears in the Glossary of Terms. Refer to the Glossary in the Appendix. (P.101)
Procedure	Indicates operating methods and the order of operations. The procedure indicated should be carried out in the order of the numbers.

Meaning of "unit" and "projector"

When "unit" or "projector" appears in the text of this Users Guide, they may refer to items which are accessories or optional equipment in addition to the main projector unit itself.

Unpacking the Projector

When you unpack the projector, make sure that you have all these components. If any of the components are missing or incorrect, please contact the place of purchase.

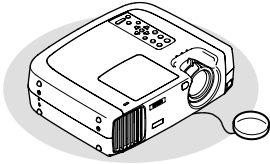

Projector

(with lens cover attached by a cord) At the time of purchase, there is packing attached to the rear adjustable foot. Remove this packing before using the projector.

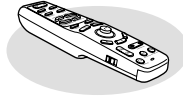

Remote control

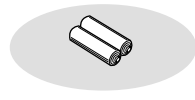

2 AA manganese batteries
(for the remote control)

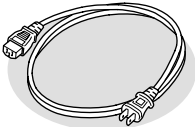

Power cord

(3 m (9.8 ft.))
For connecting the projector to a wall outlet

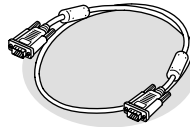

Computer cable

(mini D-SUB 15-pin / mini D-Sub 15-pin 1.8 m (6 ft.))
For connecting the projector to a computer

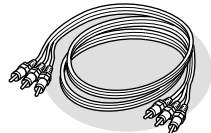

Audio/Video (A/V) cable

(red/white/yellow 1.8 m (6 ft.))
For connecting the projector to a video component

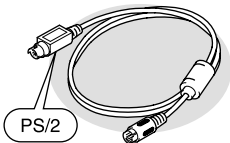

PS/2 mouse cable

(1.8 m (6 ft.))
For connecting to a computer with a PS/2 mouse port in order to use the wireless mouse function

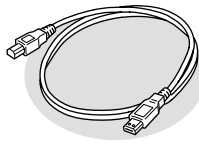

USB cable

(1.8 m (6 ft.))
For connecting to a computer with a USB port

Documentation

- Safety Instructions/ World-Wide Warranty Terms
- User's Guide (this manual)
- Quick Reference Guide

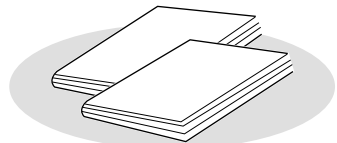

Features of the Projector

Horizontal and vertical keystone correction function

Keystone distortion in the projected image can be easily corrected, not only vertically but horizontally also. This allows even images which have been captured from a sideways angle to be projected correctly. (P. 44)

Color mode function

The optimum images can be projected simply by selecting the image quality from the following six pre-recorded settings according to the projection environment being used. (P. 63, 66)

- **sRGB** ▶
- Normal
- Meeting
- Presentation
- Theater
- Amusement

Easy to Operate

The accessory remote control can be used for operations such as pausing projection (See "Freeze" on page 54) and zooming in on important areas of an image (See "E-Zoom" on page 56). In addition, the remote control can be used to move the pointer around on the computer screen during projection, to carry out operations such as moving to the next page to be projected. (See "Using the Remote Control to Operate the Mouse Pointer" on page 25.)

If using the wireless mouse function with a USB connection you can use the remote control to display the next page or previous page when giving a presentation using PowerPoint documents.

Compact and lightweight

The projector has a compact body with a footprint the size of an A4 page (348 (W) x 104 (H) x 274 (D) mm) and is light in weight (approximately 4.2kg (9.3 lbs)).

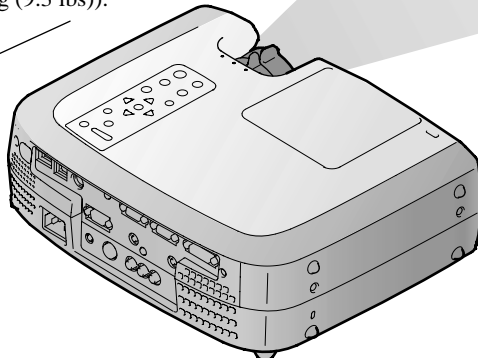
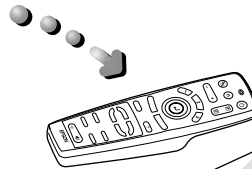

Brilliant, Attractive Images

Despite its compact size, the projector can display images at high resolutions with a high degree of luminance, providing beautifully clear images even in bright environments.

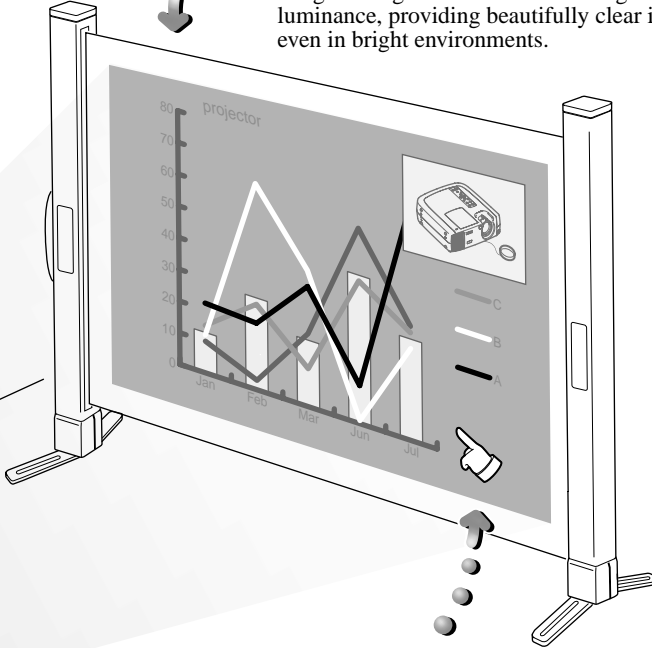

Presentation Support Functions

Effect options such as indicating important points using a pointer, positioning stamps and drawing lines can be used to provide effective support for presentations. (P. 58)

Picture-in-Picture Function

Computer images and VCR images can be played back and projected simultaneously on a single screen. A sub-screen appearing on the main computer screen can show moving images from a VCR, thereby increasing the power of your presentation. (P. 60)

Contents

Unpacking the Projector	1
Features of the Projector	2

Before Using the Projector

Part Names and Functions	8
Front/Top	8
Control panel	9
Rear	10
Base	11
Remote control	12
Before Using the Remote Control	13
Inserting the Batteries	13
Battery Replacement Period and Cautions	13
Using the Remote Control and Remote Operating Range	14
Notes on Handling the Remote Control	15
Installation	16
Setting Up the Projector	16
Screen Size and Projection Distance	18
Connecting to a Computer	19
Eligible Computers	19
Projecting Images from the Computer	20
Playing Sound from the Computer	24
Using the Remote Control to Operate the Mouse Pointer	25
Connecting to an External Monitor	28
Connecting to a Video Source	29
Projecting Composite Video Images	29
Projecting S-Video Images	30
Projecting Component Video Images	31
Projecting RGB Video Images	32
Connecting to an External Speaker	34

Basic Operations

Turning On the Projector	36
Connecting the Power Cord	36
Turning On the Power and Projecting Images	37
Turning Off the Projector	39

Adjusting the Screen Image	41
Adjusting the Image Size	41
Adjusting the Image Angle	42
Correcting Keystone Distortion	44
Adjusting the Image Quality	46
Focusing the Screen Image	46
Adjusting Computer Images	46
Adjusting the Volume	49

Advanced Operations

Functions for Enhancing Projection	52
List of Functions	52
Function Details	52
Using the Projector Menu Functions	62
List of Functions	62
Using the Menus	75

Appendices

Troubleshooting	78
Using the Help	78
When Having Some Trouble.....	80
When the Indicators Provide No Help	83
Maintenance.....	91
Cleaning	91
Replacing Consumables.....	93
Saving a User's Logo	98
Optional Accessories	100
Glossary	101
List of ESC/VP21 Commands	103
Command List.....	103
Communication protocol	104
USB Connection Setup	104
Cable layouts.....	105
List of Supported Monitor Displays	106
Specifications	107
Appearance.....	109
Index	110



Before Using the Projector

This chapter describes the procedures for setting up the projector before use.

Part Names and Functions	8
Before Using the Remote Control	13
• Inserting the Batteries	13
• Battery Replacement Period and Cautions	13
• Using the Remote Control and Remote Operating Range	14
• Notes on Handling the Remote Control	15
Installation	16
• Setting Up the Projector	16
• Screen Size and Projection Distance	18
Connecting to a Computer	19
• Eligible Computers	19
• Projecting Images from the Computer	20
• If the monitor port is a mini D-Sub 15-pin connector	20
• If the monitor port is a digital RGB connector	21
• If the monitor port is a 5BNC connector	22
• If the monitor port is a 13w3 connector	23
• Playing Sound from the Computer	24
• Using the Remote Control to Operate the Mouse Pointer	25
• Connecting to an External Monitor	28
Connecting to a Video Source	29
• Projecting Composite Video Images	29
• Projecting S-Video Images	30
• Projecting Component Video Images	31
• Projecting RGB Video Images	32
Connecting to an External Speaker	34

Part Names and Functions

Front/Top

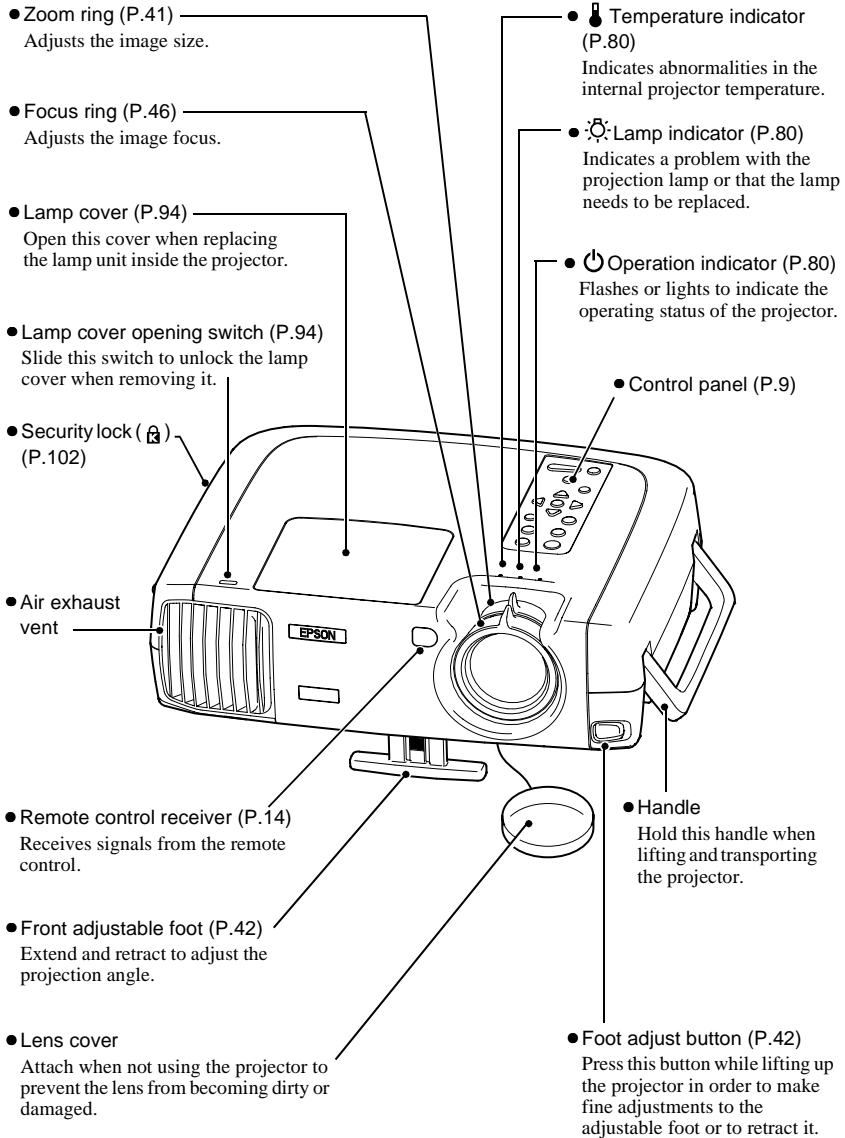

Control panel

-
- **[Power] (P.37)**
Turns the projector power on and off.
 - **[Computer/YCbCr] (P.38)**
Switches the input source between the Computer 1 port and the Computer 2/Component Video port each time the button is pressed.
 - **[Menu] (P.75)**
Displays or hides the menus.
 - **[V-Keystone] (P.44)**
Press this button if the projected image has vertical keystone distortion.
If you press and hold the [Shift] button while pressing this button, you can adjust the synchronization of computer images.
 - **[Shift] (P.47)**
This button does not function by itself. Press and hold this button while pressing either [Keystone] button to activate the function that is printed in orange on the control panel (Sync or Tracking).
 - **[A/V Mute] (P.52)**
Turns off the audio and video.
 - **[Help] (P.78)**
Displays the online help menu to assist you if you have a problem.
 - **[Video] (P.38)**
Switches the input source between the Video port and the S-Video port each time the button is pressed.
 - **[Esc] (P.75)**
Stops the current function. Pressing [Esc] while viewing a menu or the online help displays the previous screen or menu.
 - **[H-Keystone] (P.44)**
Press this button if the projected image has horizontal keystone distortion.
If you press and hold the [Shift] button while pressing this button, you can adjust the tracking of computer images.
 - **[Auto] (P.46)**
Automatically adjusts the computer image to the optimum image.
When a setting menu or help screen is displayed, this key functions as an  button.
When a menu item is selected, press this button to proceed to the next screen.
 - **[Resize] (P.41, 55)**
Changes the size of the projection area.
 - **[Volume] (P.49)**
Adjusts the volume.

Rear

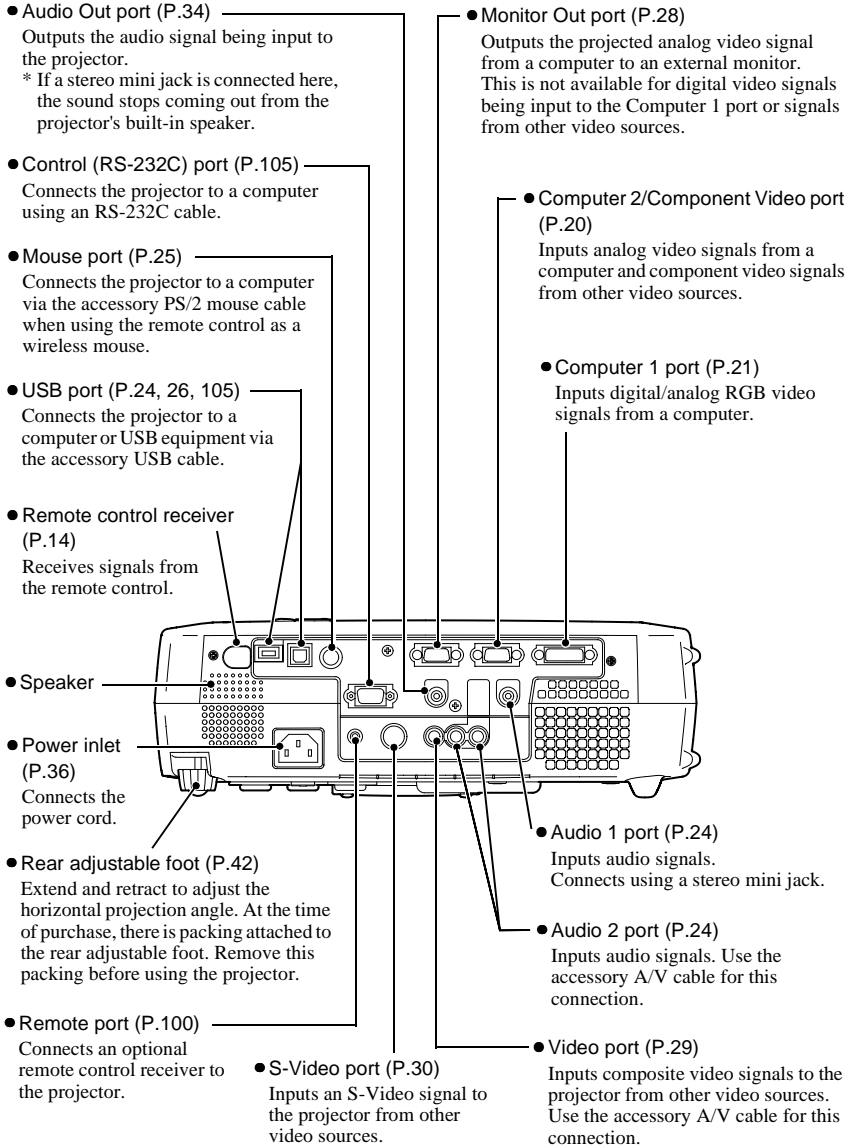

Base

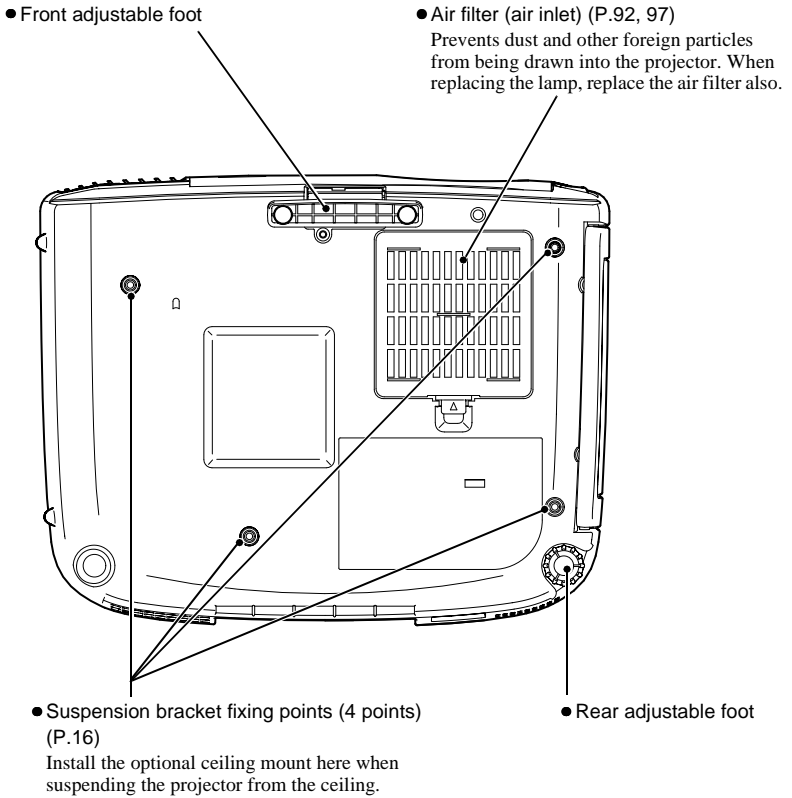

Remote control

- Remote control transmitter (P.14)
Outputs infrared remote control signals.
- Indicator
Lights when a remote control signal is being output.
- [Freeze] (P.54)
Keeps the current computer or video image on the screen.
- [A/V Mute] (P.52)
Turns off the audio and video.
- [E-Zoom] (P.56)
Enlarges or reduces the size of the image without changing the size of the projection area.
- Effect buttons (P.58)
Special effects functions are assigned to these buttons as follows.
[1]: Pointer/stamp
[2]: Spotlight
[3]: Bar
- [Left] (P.27)
Acts as a mouse left-click when using the remote control as a wireless mouse.
- [Menu] (P.75)
Displays or hides the menus.
- [Auto] (P.46)
Automatically adjusts the computer image to the optimum image.
- [P in P] (P.60)
Activates the Picture in Picture (P in P) function.
- [Volume] (P.49)
Adjusts the volume.
- [Power] (P.37)
Turns the projector power on and off.
- [↑]/[↓] (P.26)
When the projector is connected to a computer using the accessory USB cable, these keys function in the same way as the [↑]/[↓] keys on the USB keyboard.
- R/C switch (P.14)
Turns the remote control power on and off.
- ⌂ (P.27, 75)
Press the edge of the ⌂ button to move the mouse pointer in the direction of the edge pressed. When a menu is displayed, the ⌂ button accepts the menu selection and displays the next screen or menu.
- [Right]/[Esc] (P.27, 76)
Stops the current function. Displays the previous screen or menu while viewing a menu or the online help. Acts as a mouse right-click when using the remote control as a wireless mouse.
- [Help] (P.78)
Displays the online help menu.
- [Source] (P.38)
[Comp1]: Switches to the images input from the Computer 1 port.
[Comp2/YCbCr]: Switches to the images input from the Computer 2/Component Video port.
[S-Video]: Switches to the images input from the S-Video port.
[Video]: Switches to the images input from the Video port.
- [Preset] (P.63)
Selects one of the computer image resolutions that have been preset.
- [Resize] (P.41, 55)
Changes the size of the projection area.

Before Using the Remote Control

Inserting the Batteries

The batteries are not inserted into the remote control at the time of purchase, and so you need to insert them before the remote control can be used.

Procedure

1 Remove the battery compartment cover.

While pushing the catch of the battery compartment cover, lift the cover up to remove it.

2 Insert the batteries.

Make sure the polarities of the batteries are correct.

3 Replace the battery compartment cover.

Press the battery compartment cover until it clicks into place.

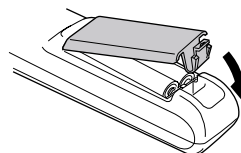
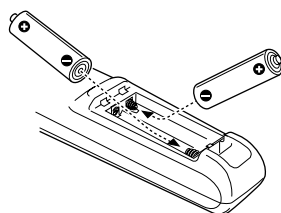
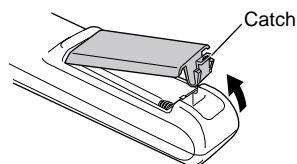

Battery Replacement Period and Cautions

If the remote control becomes slow in responding or if it stops working, the batteries may be spent. If this happens, replace the batteries with fresh ones.

Guide to battery replacement period: After about 6 months if the remote control is used for 30 minutes each day

* The replacement period given above may vary depending on the amount of usage and the ambient conditions.

Use the following type of batteries as replacements.

2 AA manganese batteries

Using the Remote Control and Remote Operating Range

Using the Remote Control

The remote control is used in the following way.

Procedure

- 1 Set the R/C switch on the remote control to the ON position.
- 2 Point the remote control transmitter toward one of the remote control receivers on the projector and operate the remote control buttons.

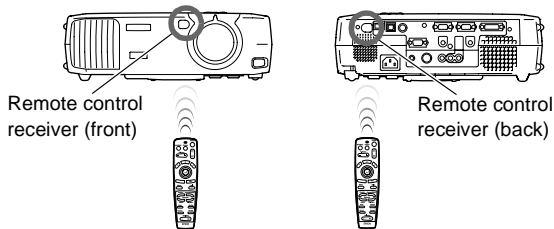
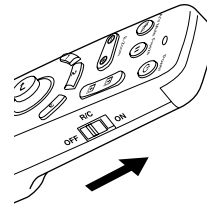

Tip :

- Do not allow sunlight or light from fluorescent lamps to shine directly onto the projector's remote control receivers, otherwise it may interfere with the reception of signals from the remote control.
- Set the R/C switch on the remote control to the OFF position when not using the remote control. Leaving the R/C switch on will consume battery power.

Remote Operating Range

Use the remote control within the ranges indicated below. If the distance or angle between the remote control and the remote control receiver is outside the normal operating range, the remote control may not work.

Operating distance	Operating angle
Approx. 10 m (30 ft.)	Approx. $\pm 30^\circ$ horizontally Approx. $\pm 15^\circ$ vertically

Approx. $\pm 30^\circ$ horizontally

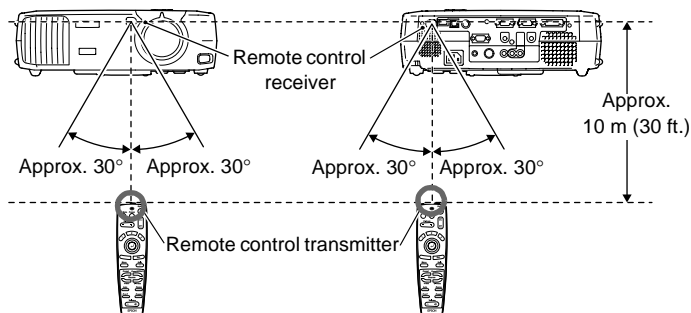

Approx. $\pm 15^\circ$ vertically

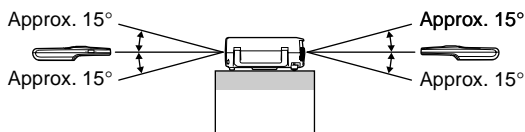

When suspended from the ceiling

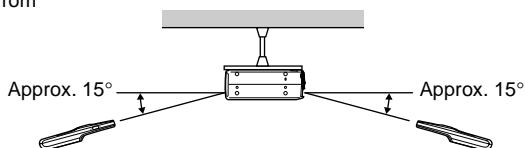

Tip :

*If you would like to use the remote control from a distance outside the normal operating range, use the optional remote control receiver.
See "Appendix: Optional Accessories" (P.100)*

Notes on Handling the Remote Control

Make sure that you observe the following at all times to avoid malfunctions or damage to the remote control.

- Do not drop the remote control or subject it to strong shocks.
- Do not allow the remote control to become wet. If it does become wet, wipe it immediately with a dry cloth.
- Remove the batteries if you will not be using the remote control for a long period of time. The batteries may leak if they are left inside the remote control.
- Some functions can only be carried out using the remote control. Keep the remote control near the projector at all times so that you do not lose the remote control.

Installation

Setting Up the Projector

The projector supports the following four different projection methods, allowing you to choose the best method for displaying your images.

When setting up the projector, be sure to first read the Safety Instructions/ World-Wide Warranty Terms for information on the safety precautions that must be observed at this time.

- Front projection

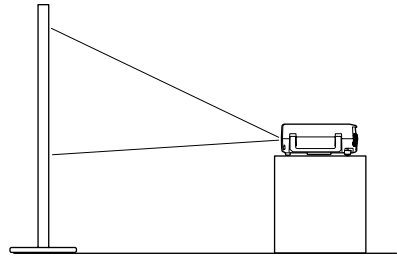
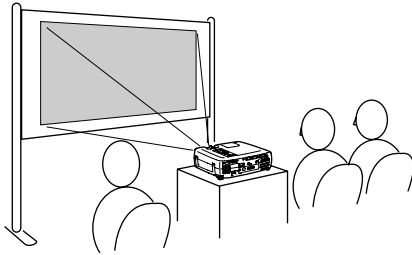

- Front/ceiling projection

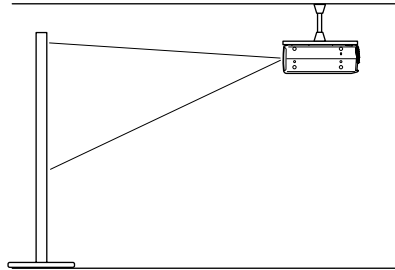
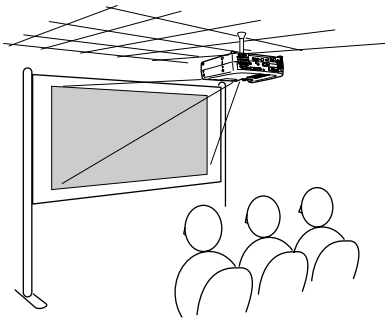

* A special method of installation is required in order to suspend the projector from the ceiling. Please contact the place of purchase if you would like to use this installation method.

- Rear projection using a translucent screen

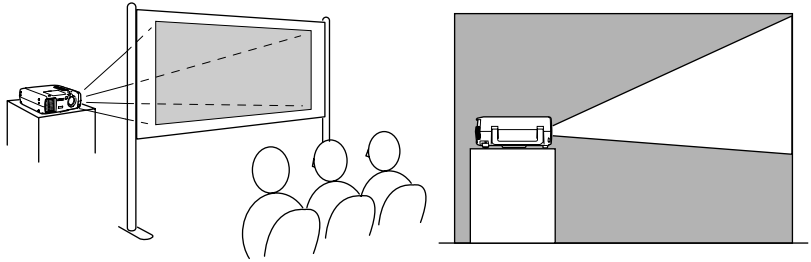

- Rear/ceiling projection using a translucent screen

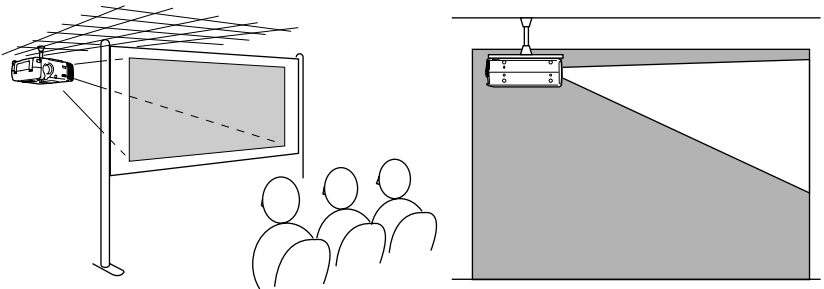

* A special method of installation is required in order to suspend the projector from the ceiling. Please contact the place of purchase if you would like to use this installation method.

Screen Size and Projection Distance

The distance between the projector and the screen determines the actual image size.

Recommended distance	0.9m – 12.4m (3.0 – 40.7 ft.)
----------------------	-------------------------------

While referring to the table below, position the projector so that the image size is smaller than the screen size.

Screen size (cm (ft.))	Approximate projection distance* (m (ft.))
30" (61 × 46 (2.0 × 1.5))	0.9 – 1.1 (3.0 – 3.6)
40" (81 × 61 (2.7 × 2.0))	1.2 – 1.6 (3.9 – 5.2)
60" (120 × 90 (3.9 × 3.0))	1.8 – 2.4 (5.9 – 7.9)
80" (160 × 120 (5.3 × 3.9))	2.5 – 3.2 (8.2 – 10.5)
100" (200 × 150 (6.6 × 4.9))	3.1 – 4.1 (10.2 – 13.5)
200" (410 × 300 (13.5 × 9.8))	6.1 – 8.3 (20.0 – 27.2)
300" (610 × 460 (20.0 × 15.1))	9.2 – 12.4 (30.2 – 40.7)

* The value for the projection distance should be used as a guide for setting up the projector. The actual distance will vary depending on projection conditions.

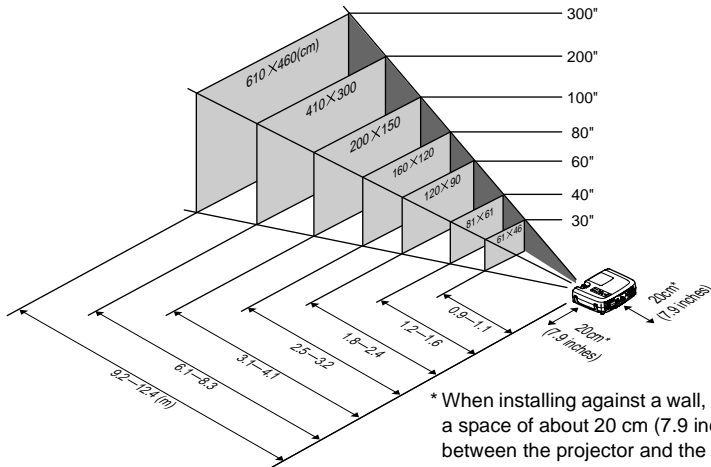

Tip :

- The projector’s lens allows a zoom ratio of up to about 1.35. The image size at the maximum zoom setting is about 1.35 times bigger than the image size at the minimum zoom setting.
- The image size will be reduced when keystone correction is carried out.

Connecting to a Computer

Caution :

When connecting the projector to a computer, be sure to check the following.

- *Turn off the power for both the projector and the computer before connecting them. If the power for either device is on at the time of connection, damage may result.*
- *Check the shapes of the cable connectors and the device ports before making the connections. If you try to force a connector to fit a device port with a different shape or number of terminals, damage to the connector or port may result.*

Eligible Computers

The projector cannot be connected to some types of computer, or projection of images may not be possible even if actual connection is possible. Make sure that the computer you intend to use satisfies the conditions given below.

- **Condition 1:** The computer must have a video signal output port.
Check that the computer has a port such as an RGB port, monitor port or CRT port which can output image signals.
If the computer has a built-in monitor, or if using a laptop computer, it may not be possible to connect the computer to the projector, or alternatively you may need to purchase a separate external output port. Refer to the documentation for your computer under a heading such as "Connecting an external monitor" or similar for further details.
- **Condition 2:** The display resolution and frequency of the computer must be listed in the "List of Supported Monitor Displays".
See "Appendix: List of Supported Monitor Displays"(P.106)
Some computers may have functions for changing the output resolution. For details, refer to the section of the documentation provided with your computer and change the setting to within a range given in the list of supported resolutions.

Projecting Images from the Computer

The shape and specifications of the computer's monitor port will determine which projector port and what type of cable should be used. Check the following to see which type of port your computer has.

If the monitor port is a mini D-Sub 15-pin port

Use the accessory computer cable to connect the Computer 2/Component Video port at the rear of the projector to the monitor port of the computer.

If you are connecting two computers with analog RGB output to the projector, use the optional DVI analog cable to connect the monitors of the two computers to the Computer 1 port at the rear of the projector.

See "Appendix: Optional Accessories" (P.100)

When connecting to the Computer 2/Component Video port

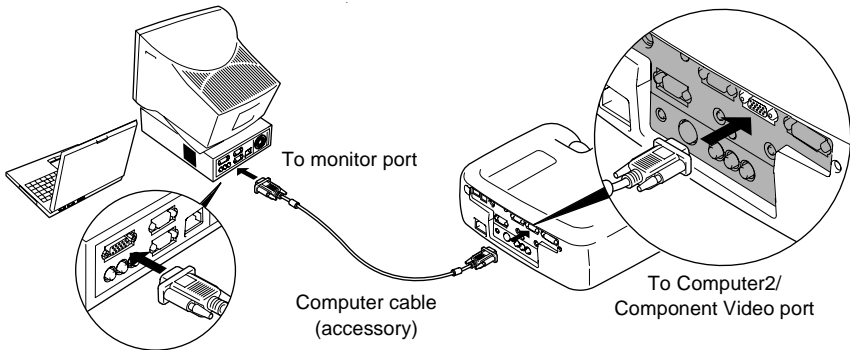

Tip :

- After making the connections, change the **Comp2/YCbCr Input** setting in the **Setting** menu to **Analog-RGB**. (P.69)
- Do not bind the power cord and the computer cable together; otherwise image interference or errors in operation may result.
- You may need to purchase a separate adapter to connect the computer to the projector, depending on the shape of the computer's monitor port. Refer to the documentation for the computer for details.
- A commercially-available adapter is required in order to connect the projector to a Macintosh computer.
- If the computer and projector are too far away from each other for the accessory cable to reach, or if you would like to project computer images at UXGA resolution, use the optional computer cable. See "Appendix: Optional Accessories" (P.100)

If the monitor port is a digital RGB connector

If the computer has a standard **DVI** or **DFP**-compliant digital video card or video output port, use an optional digital video cable or DVI analog cable to connect the monitor port of the computer to the Computer 1 port at the rear of the projector. The type of connection cable used will vary depending on the specifications for the computer's monitor port. See “Appendix: Optional Accessories” (P.100)

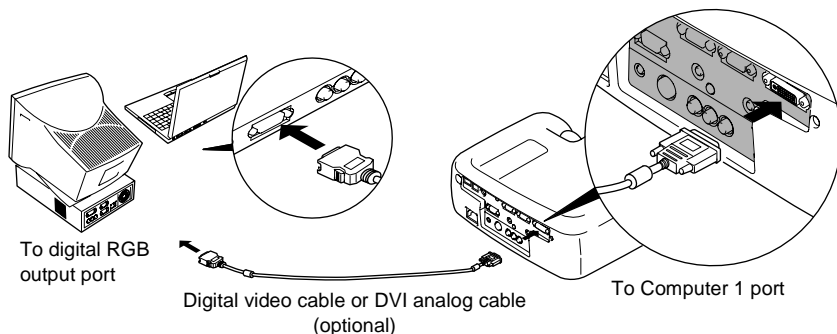

Tip :

- You may need to change the computer settings when switching the computer output to digital RGB. Refer to the documentation for the computer for details.
- If you are connecting a computer with a mini D-Sub 15-pin output port to the projector at the same time, connect the computer with the mini D-Sub 15-pin output port to the Computer 2/Component Video port of the projector.
- After making the connections, change the **Comp1 Input** setting in the **Setting** menu to **Digital-RGB**. (P.69)

If the monitor port is a 5BNC port

Use the optional computer cable to connect the Computer 2/Component Video port at the rear of the projector to the monitor port of the computer. See “Appendix: Optional Accessories” (P.100)

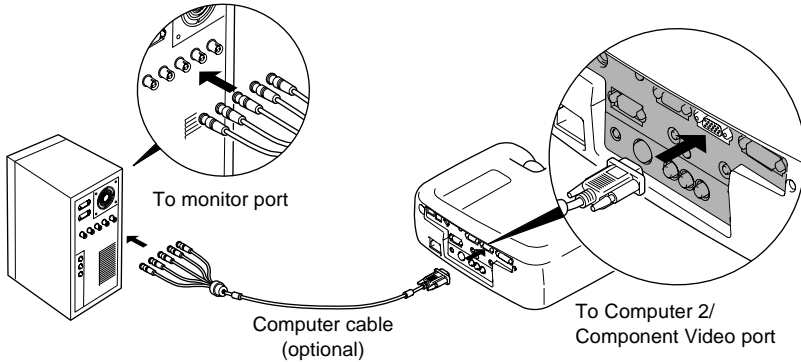

Tip :

- After making the connections, change the **Comp2/YCbCr Input** setting in the **Setting** menu to **Analog-RGB**. (P.69)
- Do not bind the power cord and the computer cable together, otherwise image interference or errors in operation may result.

If the monitor port is a 13w3 port

Some workstation-type computers have a 13w3 monitor port. Use a commercially-available 13w3 ↔ D-Sub 15-pin adapter cable to connect the Computer 2/Component Video port at the rear of the projector to the monitor port of the computer.

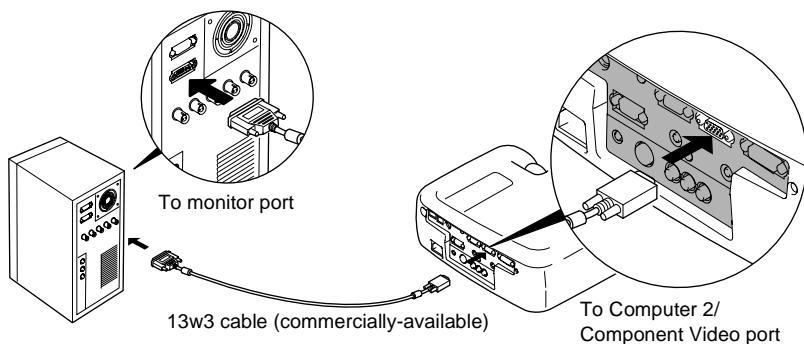

Tip :

- After making the connections, change the **Comp2/YCbCr Input** setting in the **Setting** menu to **Analog-RGB**. (P.69)
- Do not bind the power cord and the computer cable together, otherwise image interference or errors in operation may result.
- Some workstations may require a special cable. Consult the workstation manufacturer for further details.

Playing Sound from the Computer

The projector has a single built-in speaker with a maximum output of 5W. You can use this built-in speaker to output the audio signals from a computer by using any one of the following three connection methods, depending on the shape of the computer's audio output port and the type of cable you have.

- By using the accessory A/V cable (white/red) to connect the computer's audio output ports to the Audio 2 port (RCA jack) at the rear of the projector

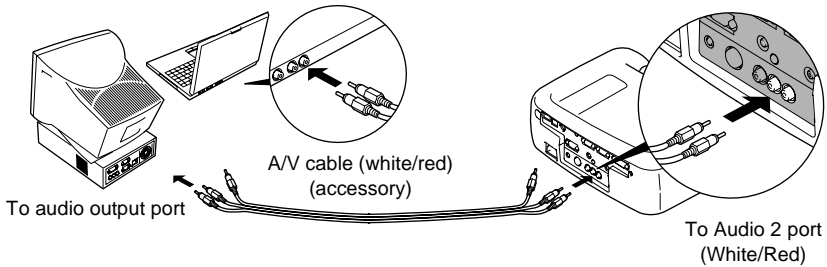

- By using a commercially-available audio cable to connect the computer's audio output ports to the Audio 1 port (stereo mini jack) at the rear of the projector. It is recommended that you use an audio cable with a 3.5 mm diameter stereo mini jack.

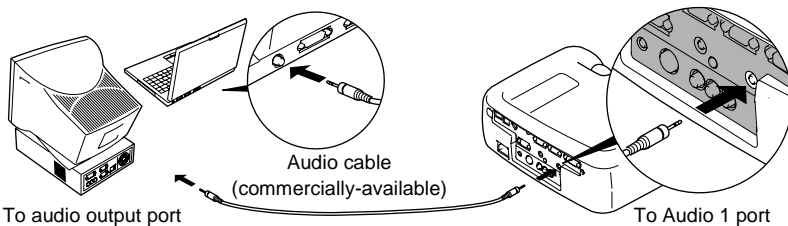

- For a computer which is capable of USB audio output, by using the accessory USB cable to connect the computer's USB port to the USB port at the rear of the projector.

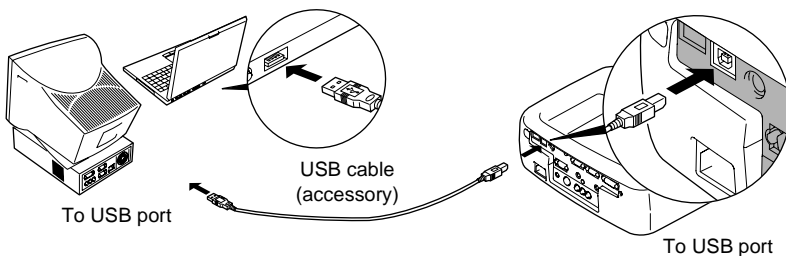

Tip :

- After making the connections, change the **Audio Input** setting in the **Audio** menu to either **Audio1**, **Audio2** or **USB**, depending on which input port you are using. (P.67)
- You can also connect external speakers to the projector in order to reproduce the audio signals. (P.34)
- The USB cable can only be connected to computers with a standard USB interface. If using a computer which is running Windows, the computer must have had a full version of Windows 98/2000/Me installed. If the computer is running a version of Windows 98/2000/Me that has been upgraded from an earlier version of Windows, correct operation cannot be guaranteed. If using a Macintosh computer, the computer must be running OS9.0 – 9.1. It may not be possible to use the USB audio function under some versions of both the Windows and Macintosh operating systems.
- If using a USB cable to output sound from the computer, you may need to change the computer settings. For details, refer to the section of the documentation provided with your computer.

Using the Remote Control to Operate the Mouse Pointer

You can use the remote control as a wireless mouse to control the mouse pointer on the computer screen. To do this, you must use a mouse cable to connect the mouse port of the computer to the mouse port or the **USB** port at the rear of the projector.

Computer	Mouse used	Applicable cable
Windows	PS/2 mouse	PS/2 mouse cable (supplied)
	USB mouse	USB cable (supplied)
Macintosh (OS8.6 – 9.1)	USB mouse	USB cable (supplied)

Example of PS/2 mouse connection

Turn off the power for both the projector and the computer before connecting them. If the power for either device is on at the time of connection, errors in operation or damage may result.

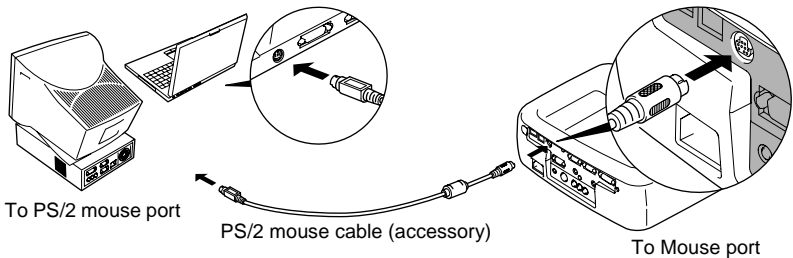

Example of USB mouse connection

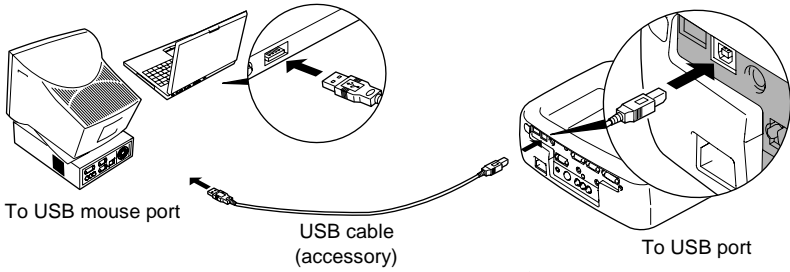



* If you make a USB connection, you can use the [↑] and [↓] buttons on the remote control. These buttons can be used to scroll back and forth through pages when projecting a PowerPoint presentation.

Tip :

- The **USB** cable can only be connected to computers with a standard USB interface. If using a computer which is running Windows, the computer must have had a full version of Windows 98/2000/Me installed. If the computer is running a version of Windows 98/2000/Me that has been upgraded from an earlier version of Windows, correct operation cannot be guaranteed.
If using a Macintosh computer, the computer must be running OS8.6 – 9.1.
It may not be possible to use the mouse function under some versions of both the Windows and Macintosh operating systems.
- Some computer settings may have to be changed in order for the mouse function to be used. Consult the Users Guide for the computer for further details.
- A PS/2 mouse and a USB mouse cannot be used simultaneously.

Once the connection has been made, the mouse pointer can be operated as follows.

Moving the mouse pointer

Press the edge of the  button to move the mouse pointer in the direction of the edge pressed. The  button can be tilted in any one of 16 directions.

Left click

Press the [Left] button.

Right click

Press the [Right/Esc] button.

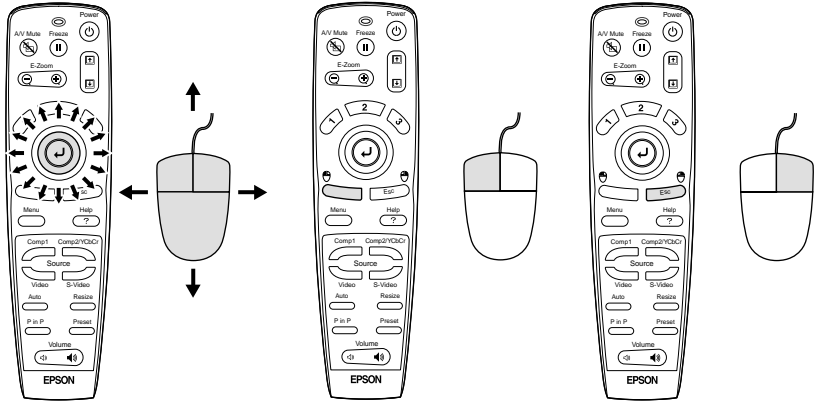

Tip :

- If the mouse button settings have been reversed at the computer, the operation of the remote control buttons will also be reversed.
- The wireless mouse function cannot be used when any of the following functions are being used.
 - During menu display
 - Effect
 - Before setting a Picture in Picture sub-screen
 - E-zoom
 - When image size is set to normal display (resizing off) (for resolutions of SXGA and above)

Connecting to an External Monitor

Images can be viewed on an external computer monitor at the same time they are being projected by the projector. Use the cable provided with the computer monitor to connect the monitor to the Monitor Out port at the rear of the projector.

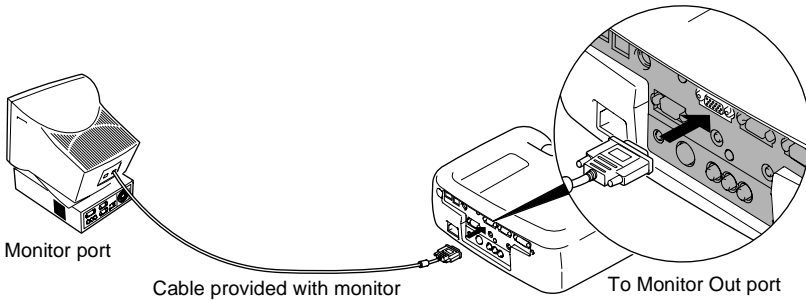

Tip :

- *Digital RGB signals that are being input to the Computer 1 port cannot be output to an external monitor.*
- *Video images cannot be output to an external monitor.*

Connecting to a Video Source

Caution :

When connecting the projector to other video sources, take the following precautions.

- Turn off the power for both the projector and the video source before connecting them. If the power for either device is on at the time of connection, damage may result.
- Check the shapes of the cable connectors and the device ports before making the connections. If you try to force a connector to fit a device port with a different shape or number of terminals, a malfunction or damage to the connector or port may result.

Projecting Composite Video Images

- Use the accessory A/V cable (red/white/yellow) to connect the video source to the Video and Audio 2 ports at the rear of the projector.
- If the audio output port of the video source is a stereo mini jack, use a commercially-available audio cable to connect the video source to the Audio 1 port at the rear of the projector.

When connecting using the A/V cable

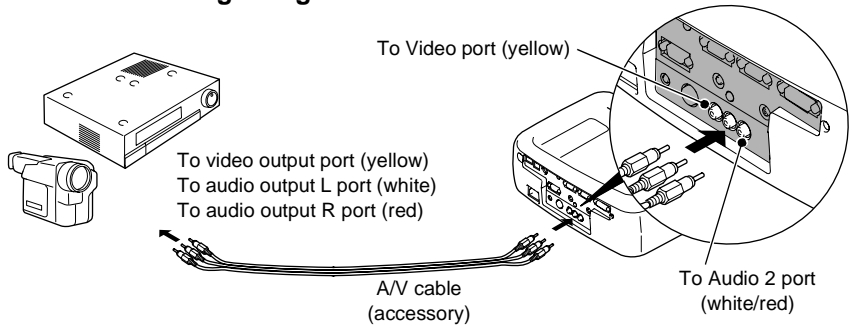

When the video equipment's audio output port is a stereo mini jack

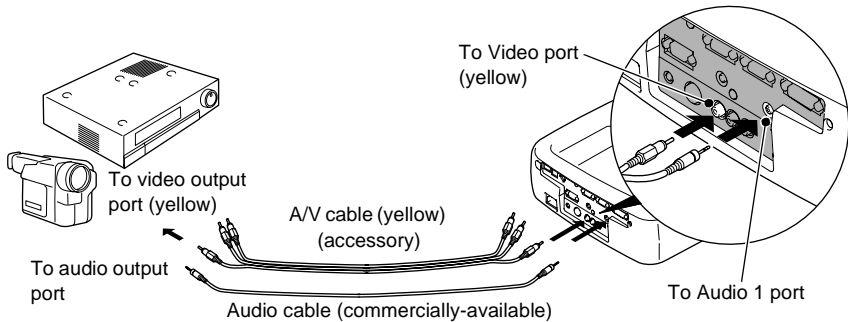

Tip :

After making the connections, change the **Audio Input** setting in the **Audio** menu to either **Audio1**, **Audio2** or **USB**, depending on which input port you are using. The default setting is **Audio2**.

Projecting S-Video Images

- Use a commercially-available S-Video cable to connect the video source to the S-Video port at the rear of the projector.
- If you would like the sound to come out of the projector's built-in speaker, use the accessory A/V cable (red/white) to connect the video source to the Audio 2 port at the rear of the projector. Alternatively, use a commercially-available audio cable to connect the video source to the Audio 1 port at the rear of the projector. Use either method depending on the shape of the video source's audio output port and on the type of cable you have.

When connecting the audio output using an A/V cable

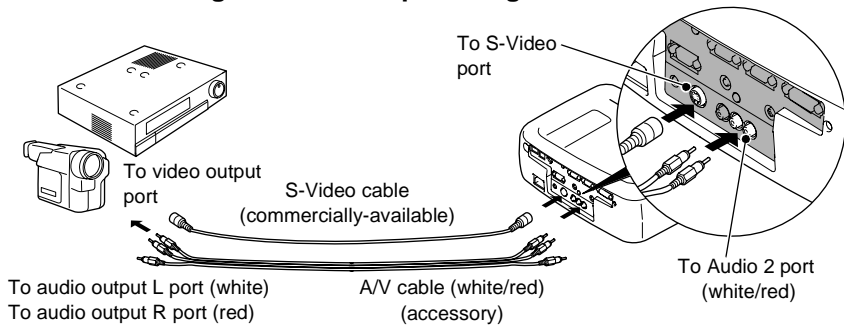

When the video equipment's audio output port is a stereo mini jack

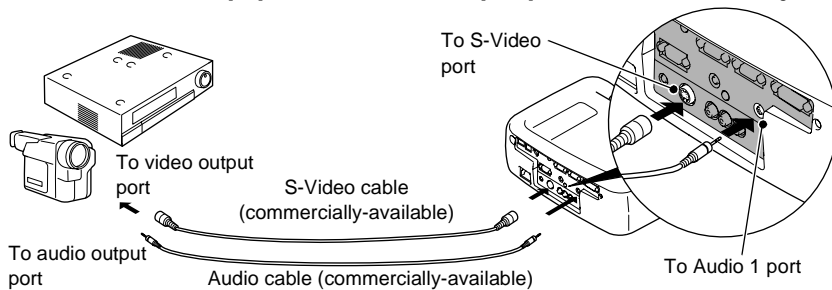

Tip :

After making the connections, change the **Audio Input** setting in the **Audio** menu to either **Audio1**, **Audio2** or **USB**, depending on which input port you are using. The default setting is **Audio2**.

Projecting Component Video Images

- Use the optional component video cable to connect the video source to the Computer 2/Component Video port at the rear of the projector. See “Appendix: Optional Accessories” (P.100)
- If you would like the sound to come out of the projector's built-in speaker, use the accessory A/V cable (red/white) to connect the video source to the Audio 2 port at the rear of the projector. Alternatively, use a commercially-available audio cable to connect the video source to the Audio 1 port at the rear of the projector. Use either method depending on the shape of the video source's audio output port and on the type of cable you have.

When connecting the audio output using an A/V cable

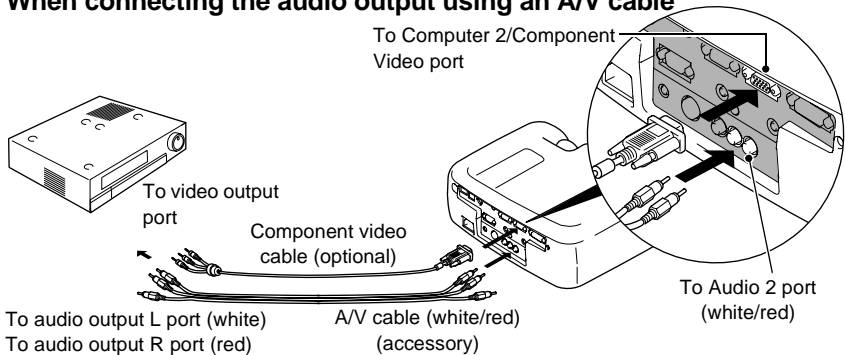

When the video equipment's audio output port is a stereo mini jack

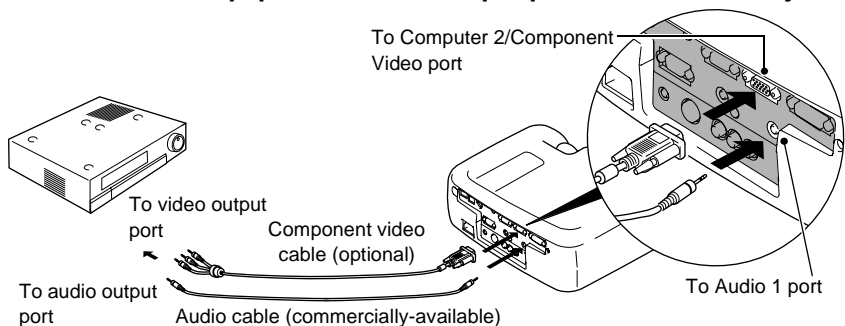

Tip :

- After making the connections, change the **Comp2/YCbCr Input** in the **Setting** menu to either "YCbCr" or "YPbPr" to match the signals from these devices. (P.69)
For HDTV (750P or 1125i), "YPbPr" will be selected regardless of the above setting.
- After making the connections, change the **Audio Input** setting in the **Audio** menu to either **Audio1**, **Audio2** or **USB**, depending on which input port you are using.

Projecting RGB Video Images

RGB video is used when RGB signals that have copy protection added are input and projected.

- Use the accessory computer cable to connect the video source to the Computer 2/Component Video port at the rear of the projector. Alternatively, use the optional DVI analog cable to connect the video source to the Computer 1 port at the rear of the projector.
See “ Appendix: Optional Accessories” (P.100)
- If you would like the sound to come out of the projector's built-in speaker, use the accessory A/V cable (red/white) to connect the video source to the Audio 2 port at the rear of the projector. Alternatively, use a commercially-available audio cable to connect the video source to the Audio 1 port at the rear of the projector. Use either method depending on the shape of the video source's audio output port and on the type of cable you have.

When connecting the audio output using an A/V cable

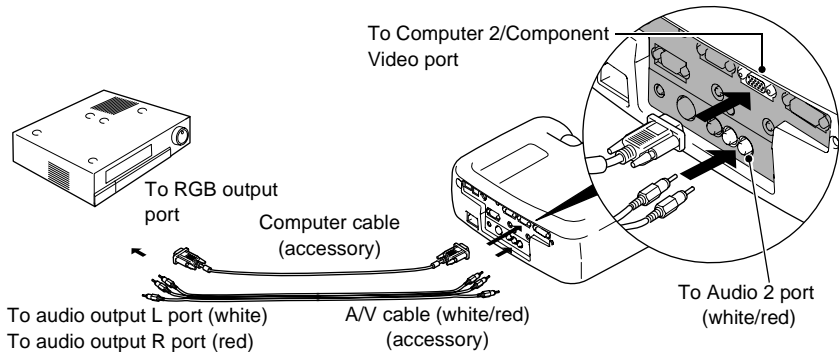

When the video equipment's audio output port is a stereo mini jack

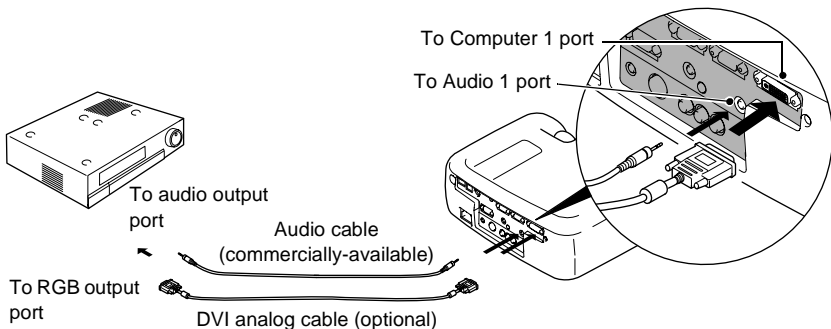

Tip :

- *RGB video is only compatible with sync-on-green signals. This can be checked by looking at **SYNC Mode** in the **About** menu.*
- *After making the connections, change the **Comp1 Input** or **Comp2 /YCbCr Input** setting in the **Setting** menu to **RGB Video**.
For separate sync (separate H-SYNC and V-SYNC) signals, set to **Analog-RGB**.
(P.69) This can be checked by looking at **SYNC Mode** in the **About** menu.*
- *After making the connections, change the **Audio Input** setting in the **Audio** menu to either **Audio1**, **Audio2** or **USB**, depending on which input port you are using. The default setting is **Audio2**.*

Connecting to an External Speaker

You can connect the projector's Audio Out port to speakers with a built-in amplifier in order to enjoy even fuller sound.

Use a commercially-available audio cable with pin jack ↔ stereo mini jack 3.5 mm (0.14 inches) plugs or similar.

Use an audio cable with a connector that matches the port for the audio equipment.

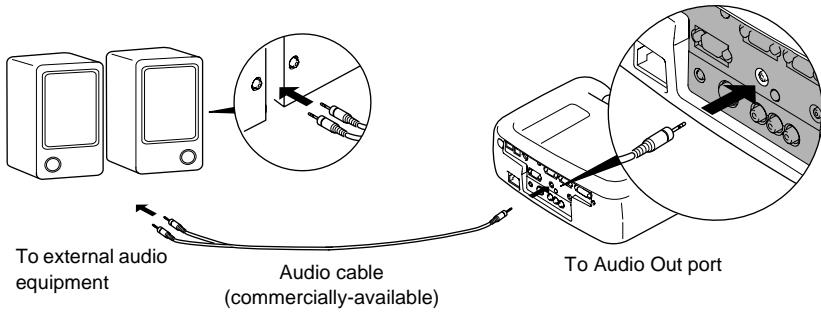

Tip :

If a stereo mini jack is connected to the Audio Out port, the sound will be externally output, and will stop coming out from the projector's built-in speaker.



Basic Operations

This chapter describes basic operations such as turning projection on and off and adjusting the projected images.

Turning On the Projector	36
• Connecting the Power Cord.....	36
• Turning On the Power and Projecting Images.....	37
Turning Off the Projector	39
Adjusting the Screen Image	41
• Adjusting the Image Size.....	41
• Adjusting the Image Angle.....	42
• Correcting Keystone Distortion.....	44
Adjusting the Image Quality	46
• Focusing the Screen Image.....	46
• Adjusting Computer Images.....	46
• Automatic adjustment	46
• Adjusting the tracking	47
• Adjusting the synchronization	48
Adjusting the Volume	49

Turning On the Projector

Turn on the power to start projecting images.

Be sure to read the separate Safety Instructions/World-Wide Warranty Terms and check the points that must be noted before using the projector to project images.

Connecting the Power Cord

Procedure

- 1 Check that the power is turned off for the projector and all components connected to the projector.**
- 2 Connect the computer or other video source to the projector.
(P.19, 29)**
- 3 Remove the lens cover.**
Place your finger under the top of the lens cover and pull to remove the cover.

- 4 Connect the accessory power cord to the projector.**

Check that the power cord connector is facing the same way as the power inlet on the projector, and then insert the power cord connector securely into the projector.

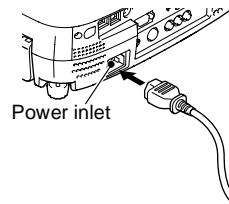

- 5 Connect the other end of the power cord to a grounded electrical outlet.**

The operation indicator lights orange.

Tip :

The projector buttons cannot be operated while the operation indicator is flashing orange. Wait until it lights steadily.

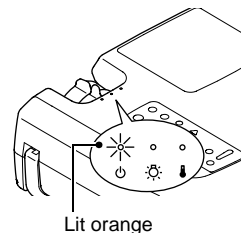

Turning On the Power and Projecting Images

Procedure

- 1 Turn on the power for all equipment connected to the projector.**

For a video source, press the [Play] button at the video source to start playback if necessary.

- 2 Check that the operation indicator has stopped flashing and lights orange.**

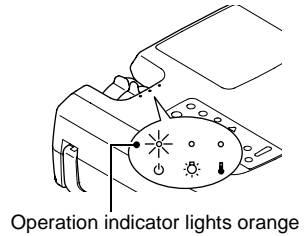

- 3 If using the remote control, set the R/C switch on the remote control to the ON position.**

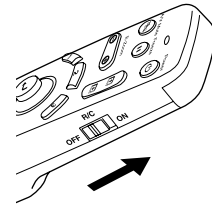

- 4 Press the [Power] button on either the remote control or the projector's control panel to turn on the power for the projector.**

The operation indicator flashes green, and after a short period projection starts. Depending on the settings, the message "No-Signal." may appear. (P.70)

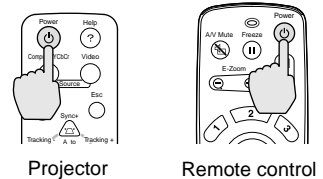

- 5 Check that the operation indicator has stopped flashing and lights green.**

Tip :

The projector buttons cannot be operated while the operation indicator is flashing green. Wait until it lights steadily.

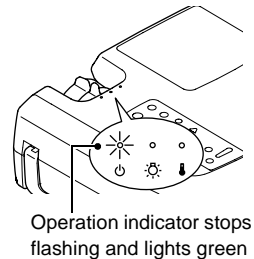

6 If more than one signal source has been connected, use the remote control or control panel buttons to select the port which the signal source that you would like to use is connected to, while referring to the following table.

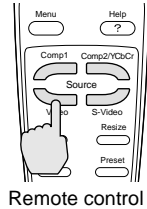
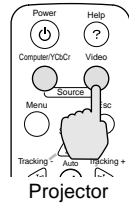

Port	Button to press		Display at bottom-left of screen
	Control panel	Remote control	
Computer1		[Comp1]	Computer1(Digital-RGB) Computer1(Analog-RGB) Computer1(RGB-Video)
Computer2/ Component Video	[Computer/YCbCr]	[Comp2/YCbCr]	Computer2(Analog-RGB) Computer2(RGB-Video) Computer2(YCbCr) Computer2(YPbPr)
S-Video	[Video]	[S-Video]	S-Video
Video		[Video]	Video

Tip :

- If only one signal source has been connected, the signals from that source will be projected without needing to press one of the above buttons.
- If the "No-Signal." message does not disappear, check the connections again.
- If a laptop computer or a computer with a LCD screen has been connected to the projector, the images may not be projected straight away. After making the connections, check that the computer has been set up to output signals. The following table shows examples of how to toggle output settings. For details, refer to the section of the documentation provided with your computer under a heading such as "External output", "Connecting an external monitor" or similar.

NEC	Panasonic	Toshiba	IBM	Sony	Fujitsu	Macintosh
[Fn]+[F3]	[Fn]+[F3]	[Fn]+[F5]	[Fn]+[F7]	[Fn]+[F7]	[Fn]+[F10]	After startup, change the Control Panel adjustments so that Mirroring is active.

- If the same still picture is projected for a long period of time, the projected image may become "burned in" on the computer screen. You should avoid leaving the same image displayed for long periods.

Turning Off the Projector

Follow the procedure below to turn off the power of the projector.

Procedure

1 Turn off the power for the signal sources that are connected to the projector.

Check that the power for all connected components has been tuned off.

2 Press the [Power] button on either the remote control or the projector's control panel.

The following confirmation message will appear.

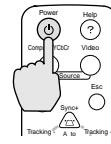
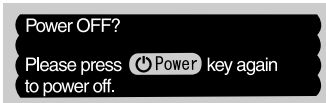

Projector

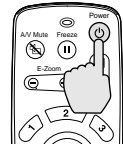

Remote control

If you do not want to turn off the power, press any button except the [Power] button.

If you do not press any button, the message will disappear automatically after seven seconds. (The power will not turn off at this time.)

3 Press the [Power] button once more.

The lamp unit will turn off and the operation indicator will flash orange as the cool-down period starts.

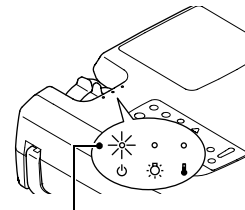

Operation indicator stops flashing and lights orange

4 Check that the cool-down is complete.

When cool-down is complete, the operation indicator lights orange.

The cool-down period lasts for approximately 2 minutes. (This varies depending on factors such as the ambient air temperature.)

Tip :

The projector buttons cannot be operated while the operation indicator is flashing orange. Wait until it lights steadily.

5 Unplug the power cord from the electrical outlet.

Caution :

Do not disconnect the power cord from the outlet while the operation indicator is still flashing orange. If you disconnect the power cord while the indicator is still flashing, it may result in errors in projector operation and reduce the lamp unit operating life.

6 Set the R/C switch on the remote control to the OFF position.

Tip :

If you leave the R/C switch at the ON position, the remote control will continue to consume battery power.

Move the R/C switch to the OFF position when not using the remote control.

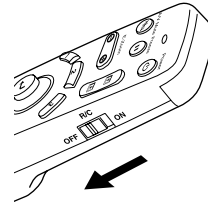

7 Retract the front adjustable foot if it is extended.

Gently push down on the projector while pressing the foot adjust button.

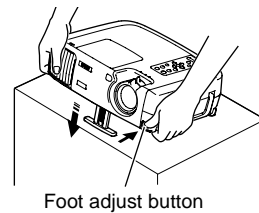

8 Attach the lens cover.

Attach the lens cover to the lens when not using the projector, in order to stop the lens from getting dusty or dirty.

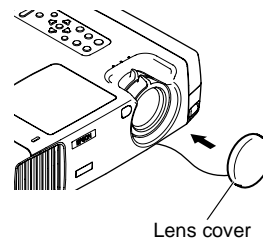

Adjusting the Screen Image

You can adjust the screen image in order to obtain the best possible picture.

Adjusting the Image Size

The size of the projected image is basically determined by the distance from the projector to the screen. (P.18)

The following procedures explain how to adjust the screen image once the projector itself has been set up.

Tip :

The E-Zoom function lets you enlarge parts of the image. (P.56)

Procedure

Turn the zoom ring on the projector to adjust the image.

The image can be enlarged in this way to 1.35 times the normal size.

If you would like to enlarge the image further, move the projector further away from the screen. (P.18)

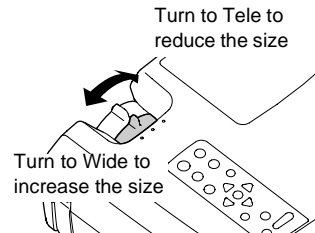

Tip :

For computer images, you can use the [Resize] button to switch between resized display and normal size display.

• Resized display (default):

The images are processed so that they automatically fill the whole of the projection area, regardless of the resolution setting.

• Normal sized display (window display):

The images are projected at the same resolution that they are input. The image size and the projection area may be different depending on the resolution.

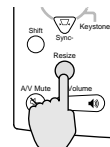

Projector

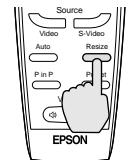

Remote control

Adjusting the Image Angle

You can change the projection angle for the projector. The projector should be as perpendicular to the screen as possible.

Seen from the side

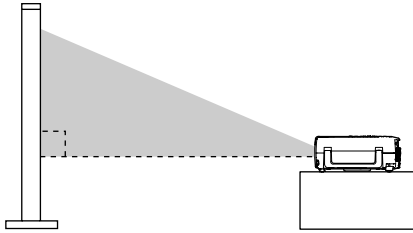

Seen from above

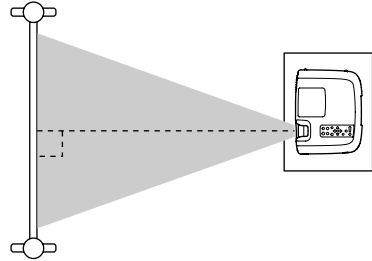

You can extend or retract the front adjustable foot to adjust the projection angle within a maximum range of 12°.

Procedure

While pressing the foot adjust button, lift up the front of the projector so that the front adjustable foot can extend.

Extend the front adjustable foot until the desired angle is obtained, and then release the foot adjust button.

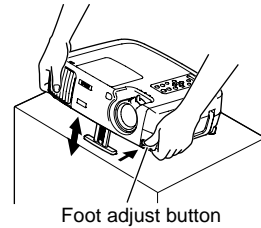

Tip :

- When the foot is adjusted, it may cause the size of the projected images to become distorted. Use the keystone correction function to adjust this distortion. (P.44)
- To retract the front adjustable foot, keep pressing the foot adjust button. The front adjustable foot will slowly retract inside the projector.
- If the projector is tilted horizontally, turn the rear adjustable foot to adjust the angle.

If the projector cannot be set up so that it is perpendicular to the screen, you can use the keystone correction function which is described on the following page to adjust the projected images if the angle of the projector is within a range of approximately 30° vertically or approximately 10° horizontally from the perpendicular.

The values given here are for when the image is at the smallest zoom setting (telephoto). The maximum angles will be smaller if the zoom setting has been increased in the wide angle direction. Furthermore, if the projector has been tilted both vertically and horizontally, the maximum adjustable angle will again be smaller than the maximum angle if the projector had been tilted in only one direction.

- When tilted vertically

Approx. 30° above

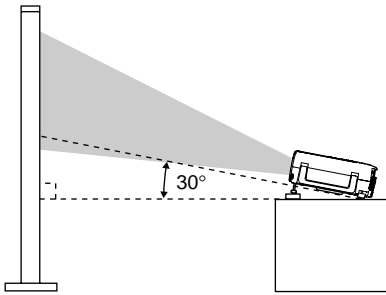

Approx. 30° below

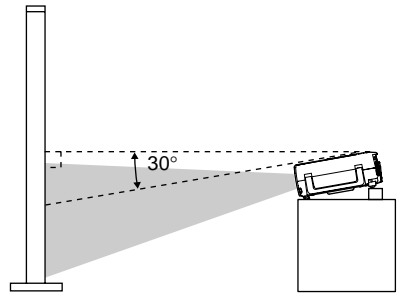

- When tilted horizontally

Approx. 10° to the right

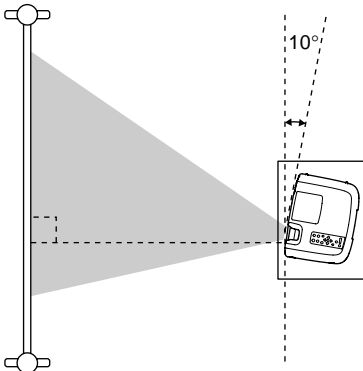

Approx. 10° to the left

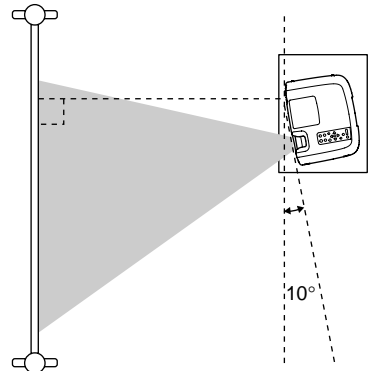

Correcting Keystone Distortion

In some cases it may not be possible to set up the projector so that the setting angle is perpendicular to the position of the screen. In such cases, a type of distortion known as "keystone distortion" may appear in the projected images. If keystone distortion occurs, you can correct it using the [Keystone] buttons on the projector's control panel.

- Correcting vertical keystone distortion

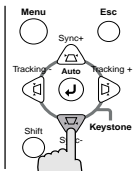
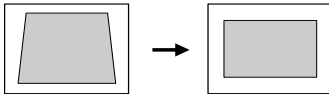

Projector

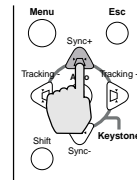
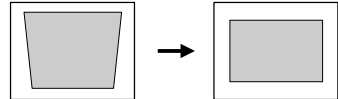

Projector

- Correcting horizontal keystone distortion

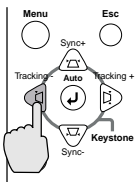
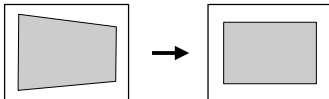

Projector

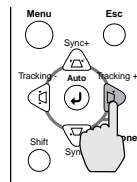
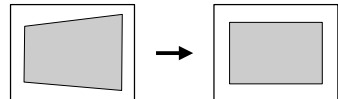

Projector

Tip :

- When keystone correction is carried out, the projected image will become smaller.
- **Procedure to follow if using both horizontal and vertical keystone correction:**
 1. With the front adjustable foot retracted, set the projector so that it is fully horizontal.
 2. Extend the front adjustable foot to adjust the angle as necessary.
 3. Adjust the vertical keystone distortion until both sides of the picture are vertical.
 4. Adjust the horizontal keystone distortion until the top and bottom edges of the picture are both horizontal.
- The keystone correction settings are memorized, so that if you change the position or angle of the projector, you may need to readjust the keystone correction settings. To return a previous keystone correction to the initial setting, carry out the following operations.

To initialize vertical keystone correction: While holding down the [Sync +] button, press the [Sync -] button for 1 second or more.

To initialize horizontal keystone correction: While holding down the [Tracking +] button, press the [Tracking -] button for 1 second or more.
- If the images become uneven in appearance after keystone correction is carried out, decrease the Sharpness setting. (P.63)
- Keystone correction can also be carried out using the projector menu. (P.69)
- If you carry out both horizontal and vertical keystone correction, the correction range will become smaller than it would be if only one type of correction was carried out.
- If the value displayed in the gauge on the screen stops changing when horizontal or vertical keystone correction is being carried out, it indicates that the limit for horizontal or vertical keystone correction has been exceeded. Check that the projector has not been set up at an angle which exceeds the proper limit.
- If the horizontal (or vertical) keystone correction function is used at the same time that the E-Zoom, Effects or P in P function is being used, the keystone correction amount may change when the E-Zoom, Effects or P in P function is operated while the keystone correction amount is near the limit value.
- The limit value for keystone correction will vary depending on the video signal being input.

Adjusting the Image Quality

The quality of the screen images can be adjusted as follows.

Focusing the Screen Image

Procedure

Turn the focus ring to adjust the image focus.

Turn the focus ring of the projector until the projected images are in proper focus.

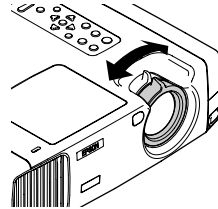

Tip :

- If the surface of the lens is dirty or misted over as a result of condensation, it may not be possible to adjust the focus correctly. If this happens, clean or de-mist the lens. (P.91)
- If the projector is positioned outside the normal projecting range of 0.9 – 12.4 m (3.0 – 40.7 ft.), it may not be possible to obtain the correct focus. If you have trouble obtaining the correct focus, check the projection distance.

Adjusting Computer Images

Automatic adjustment

This procedure adjusts computer images to the optimum settings. Automatic adjustment involves adjustment of the following three items: Tracking▶▶, Display position and Synchronization (Sync)▶▶.

Procedure

While an image is being projected from the computer, press the [Auto] button on either the remote control or the projector's control panel.

The screen will appear black while the adjustment is being made.

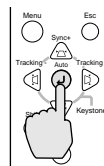

Projector

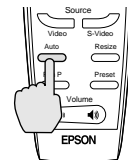

Remote control

Tip :

- The [Auto] button on the projector's control panel does not work while a menu or help screen is being displayed. To use the [Auto] button on the projector's control panel, you need to first exit the menu or help screen. Alternatively, you can use the [Auto] button on the remote control instead.
- If you use the remote control to activate the automatic adjustment function while the E-Zoom, A/V Mute or Picture in Picture functions are in use, the functions being used will be canceled before automatic adjustment is carried out. If the [Auto] button on the projector's control panel is pressed, automatic adjustment will not be carried out if the E-Zoom or Picture in Picture function is being used.
- Automatic adjustment may not work properly with some types of signals which are output by computers. In such cases, you may need to adjust the tracking and synchronization manually.

Adjusting the tracking

If vertical stripes appear in the projected images, and this cannot be fixed using automatic adjustment. You will need to adjust the tracking manually using the following procedure.

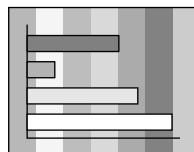

Procedure

While holding down the [Shift] button on the projector's control panel, press the [Tracking +] button.

The tracking value will increase by one setting each time the [Tracking +] button is pressed.

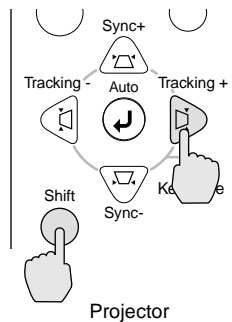

[While holding down the [Shift] button on the projector's control panel, press the [Tracking -] button.

The tracking value will decrease by one setting each time the [Tracking -] button is pressed.

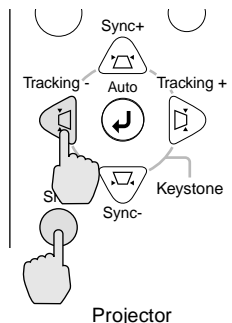

Tip :

The image will flash when continuous tracking adjustment is carried out, but this is normal.

Adjusting the synchronization

If flickering, fuzziness or interference appear in images that are input from the computer, and this cannot be fixed using automatic adjustment, you will need to adjust the synchronization manually using the following projection.

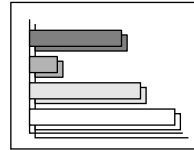

Procedure

While holding down the [Shift] button on the projector's control panel, press the [Sync +] button.

The synchronization value will increase by one setting each time the [Sync +] button is pressed.

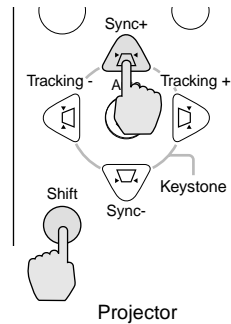

While holding down the [Shift] button on the projector's control panel, press the [Sync -] button.

The synchronization value will decrease by one setting each time the [Sync -] button is pressed.

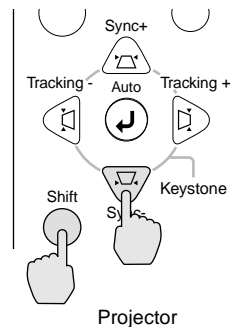



Tip :



- If you do not adjust the tracking first and then adjust the synchronization, it will not be possible to get the best adjustment results. Incorrect tracking adjustment may not be noticeable with some types of picture. However, pictures with lots of lines and shading will tend to show incorrect tracking adjustments more clearly, so be sure to check the tracking adjustment first.
- It may also be possible to fix flickering and fuzziness by adjusting the brightness, contrast, sharpness and keystone correction settings.

Adjusting the Volume

You can adjust the volume for the sound from the projector's internal speaker or from the external speakers that are connected to the projector.

Procedure

Press the [Volume  , ] button on either the remote control or the projector's control panel.

When the button is pressed to [], the volume increases, and when the button is pressed to [], the volume decreases. The volume gauge appears on the screen when the volume has been adjusted.

Tip :

When the sound is being output to external speakers, the volume from the external speakers is adjusted.

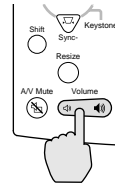

Projector

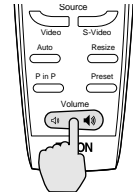

Remote control



Advanced Operations

This chapter describes functions for enhancing the projection of images, and how to use the setting menus.

Functions for Enhancing Projection.....	52
• List of Functions.....	52
• Function Details	52
• A/V Mute	52
• Freeze.....	54
• Wide-screen Projection	55
• E-Zoom	56
• Effects	58
• Canceling effects.....	59
• Picture in Picture (P in P).....	60
Using the Projector Menu Functions.....	62
• List of Functions.....	62
• Video menu	62
• Audio menu.....	67
• Effect menu	68
• Setting menu	69
• User's Logo menu	71
• Advanced menu.....	72
• About menu.....	73
• Reset All menu.....	74
• Using the Menus.....	75

Functions for Enhancing Projection

This section describes the various useful functions that can be used to enhance projection.

List of Functions

The following functions are available for enhancing projection.

Function	Description	Reference page
A/V Mute	Momentarily pauses both the image and the sound.	P.52
Freeze	Pauses only the projected image.	P.54
Wide-screen Projection	When projecting video images, changes the aspect ratio from 4:3 to 16:9 to view the images in wide screen format.	P.55
E-Zoom	Enlarge a part of the image.	P.56
Effect 1	Lets you use a pointer to indicate areas of an image, or stamps the pointer icon on a specified part of the image.	P.58
Effect 2	Spotlights a specified part of the image.	P.58
Effect 3	Draws a colored bar over the image.	P.58
P in P	Displays a sub-screen containing a video image over part of a computer or component video image.	P.60

Function Details

Detailed descriptions of the above functions are given below.

A/V Mute

This function momentarily pauses the image and sound.

For example, it can be used when you do not want to show viewers details of operations such as selecting different files while computer images are being projected.

However, if you use this function when projecting moving images, the images and sound will still continue to be played back by the source, and you cannot return to the point where the mute function was activated.

Procedure

Press the [A/V Mute] button on either the remote control or the projector's control panel.

The image and sound will then be paused.

Press the [A/V Mute] button on either the remote control or the projector's control panel to continue normal projection.

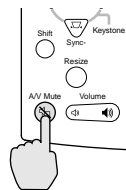

Projector

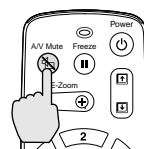

Remote control

You can use the [A/V Mute] function in the [Setting] menu to set the screen appearance when the images and sound have been paused to any one of the following three settings. (P.69)

Black

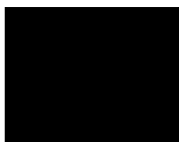

Default setting

Blue



User's logo



Tip :

The default user's logo is the EPSON logo. You can change the user's logo by recording and setting your own logo. (P.98)

Freeze

This function pauses only the projected images. The sound keeps playing without pausing.

Furthermore, for moving pictures, the playback signal continues to be input even while the picture is paused, so playback will not resume from the point from where it was paused.

Procedure

Press the [Freeze] button on the remote control.

The images will then be paused.

To continue projecting the images, either press the [Freeze] button again or press the [Esc] button.

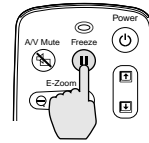

Remote control

Tip :

- Pressing the [Freeze] button also clears menu displays, effects functions and help messages.
- If you press the [Freeze] button while using the E-Zoom function or after a P in P sub-screen has been set, all of the screen displays will be paused.

Wide-screen Projection

This function changes the aspect ratio of video images from 4:3 to 16:9 when video images are being projected. Images which have been recorded in digital video or onto DVDs can be viewed in 16:9 wide-screen format. In the case of HDTV, the central part of the image can be displayed in the whole of the screen.

Procedure

Press the [Resize] button on either the remote control or the projector's control panel. The image size will change each time the button is pressed.

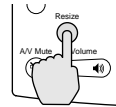

Projector

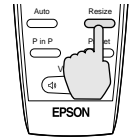

Remote control

For SDTV

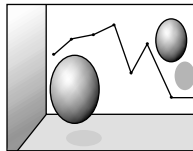

4:3 display

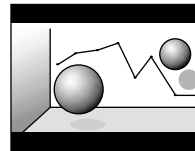

16:9 display

For HDTV

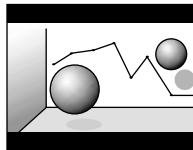

16:9 display

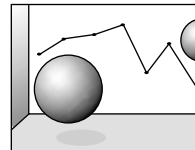

4:3 display

Changing the display position for 16:9 display

While holding down the [Shift] button on the projector's control panel, press the [Resize] button. The display position changes as follows each time the [Resize] button is pressed.

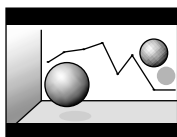

Center

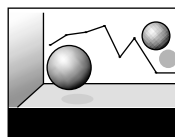

Top

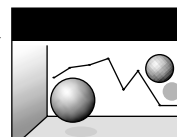

Bottom



E-Zoom

This function lets you enlarge and reduce a part of projected images such as graphs and tables.

Procedure

1 Press the [E-Zoom] button on the remote control.

A cursor (cross) indicating the center point for the area to be enlarged will appear on the screen.

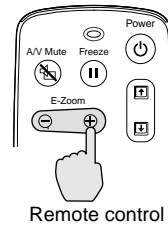

2 Move the cross to the area of the image that is to be enlarged or reduced.

Tilt the  button on the remote control to move the cross.

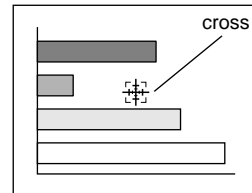

3 When the [E-Zoom] button is pressed to (+), the image is enlarged with the cross as its center. When it is pressed to (-), the enlarged picture is then reduced.

The enlargement ratio will appear at the bottom-left of the screen. You can scroll around the image by tilting the  button.

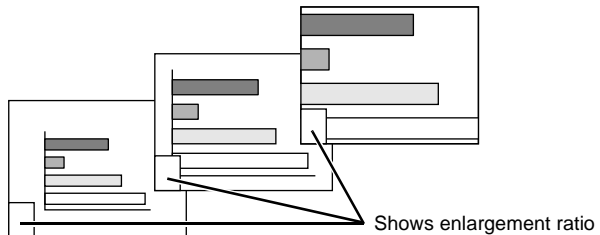

To cancel the zoom, press the [Esc] button.

Tip :

- *The selected area can be enlarged to between 1 – 4 times, in 25 steps of x 0.125.*
- *If a sub-screen has been set using the P in P function, the enlargement function is applied to both the main screen and the sub-screen.*
- *Effect functions cannot be carried out while the E-Zoom function is being used. Furthermore, keystone correction, tracking adjustment and sync adjustment cannot be carried out using the projector's control panel buttons.*
- *If the E-Zoom function is used while the keystone correction amount is near the limit value, the keystone correction amount may change.*

Effects

The [1], [2] and [3] buttons on the remote control can be used to add display effects to images that are being projected during a presentation. This can be used to emphasize particular parts of the images.

Effect 1 [1]	Pointer/ stamp	An icon appears on the screen and it can be moved around like a pointer. In addition, the icon can be made to appear on the image as a stamp.
Effect 2 [2]	Spotlight	Parts of the projected image can be spotlighted.
Effect 3 [3]	Bar	Bars (horizontal and vertical lines) can be drawn on top of the projected image.

Procedure

1 Press the [1], [2] or [3] button on the remote control to select the type of effect.

The following icon or bar appears at the center of the projected image.

- [1]: Pointer icon
- [2]: Spotlight
- [3]: Bar



Remote control

2 Select the type of pointer icon or bar.

The pointer icon changes in the following order each time the [1] button is pressed.



The size of the spotlight changes in the following order each time the [2] button is pressed.

Medium → Large → Small

The type of bar changes in the following order each time the [3] button is pressed.



Tip :

You can use the **Effect** menu to set the type of icon or bar and the size and display sequence for the spotlight.

3 Tilt the ⤵ button on the remote control up, down or to the left or right to move the item displayed around the screen.

Effect 1: The pointer icon moves.

Effect 2: The spotlight moves.

Effect 3: Horizontal bars are moved vertically, and vertical bars are moved horizontally.

4 For effect 1, move the icon to the place where you would like it to be stamped, and then press the ⤵ button.

Tip :

- *Only one type of effect can be displayed at any one time. If you press a different effect button while using an effect function, the current effect will be canceled and the effect function for the new button pressed will start.*
- *The normal wireless mouse function of the remote control cannot be used while an effect function is in use.*
- *If the effect function is used while the keystone correction amount is near the limit value, the keystone correction amount may change.*

Canceling effects

Press a button other than the [1], [2], [3], ⤵ or [Left] buttons. The effect function will be canceled and the items which were drawn on the screen will disappear.

Picture in Picture (P in P)

This function lets you simultaneously display computer or component video images on the main screen and video images (Video or S-Video) in a sub-screen. The video images in the sub-screen can be selected using the **P in P** command in the **Setting** menu. (P.70)

Tip :

- The P in P function cannot be used if the refresh rate for the computer images is set to interlaced.
- The P in P function cannot be used when TV (525i) component video images are being projected.

Procedure

- 1 Connect all components, set the type of sub-screen using the Setting menu, and then press the [P in P] button on the remote control.**

The sub-screen will appear at the top-right of the screen, and the operation guide will appear at the bottom-left of the screen.

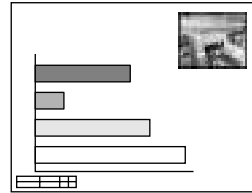

- 2 Tilt the  button on the remote control to change the position of the sub-screen.**

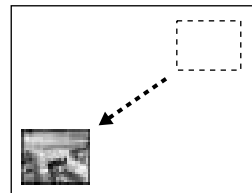

- 3 Press the [E-Zoom] button on the remote control to change the size of the sub-screen.**

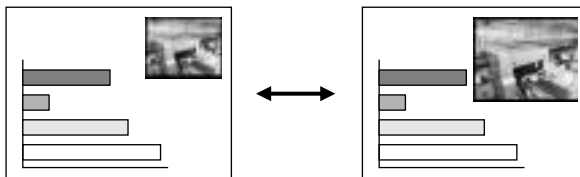

The size of the sub-screen can be changed to one of five different sizes. The following values are the ratios for the vertical and horizontal lengths of the sub-screens to those of the main screen when the lengths of the main screen sides are 1.

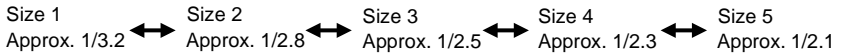

When the [P in P] button is pressed, the initial sub-screen appears in size 2.

4 Press the button on the remote control to accept the display position and size for the sub-screen.

If you press the [P in P] button once more, the sub-screen will disappear.

Tip :

- If you change the position of the sub-screen, the sub-screen will appear in the last position which was set next time the P in P function is used.
- The E-Zoom function can be used at the same time that the P in P function is being used.
- If the audio input connector for the main screen and the sub-screen have already been set using the Audio Input command in the Audio menu, you can use the Effect buttons to switch between the sound for the two screens.
Effect [1] button: Main screen audio
Effect [2] button: Sub-screen audio
- If the P in P function is used while the keystone correction amount is near the limit value, the keystone correction amount may change.

Using the Projector Menu Functions

The setting menus can be used to carry out a variety of settings and adjustments.

The menus have a hierarchical structure, with a main menu that is divided into sub-menus, which are further divided into other sub-menus.

Refer to “Using the Menus” (P.75) for details on using the menus.

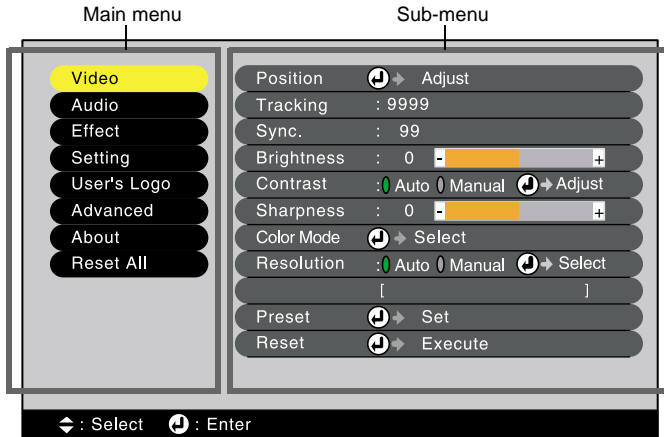

List of Functions

Video menu

- The functions in the **Video** menu cannot be adjusted while no video signal is being input.
- The functions which appear in the **Video** menu will change depending on the type of input source being used for the video signal. Functions which are not available in the **Video** menu for a particular input source cannot be adjusted.

Analog-RGB

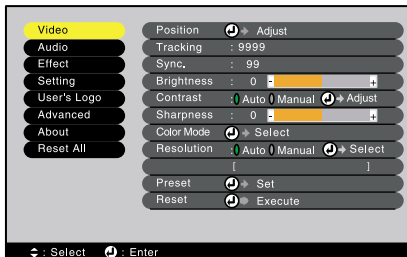

Digital-RGB

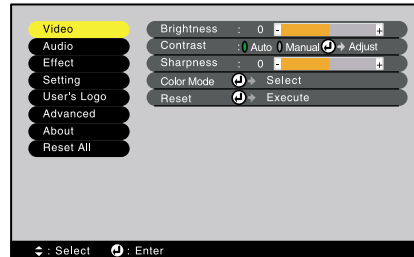

Computer (Analog-RGB, Digital-RGB)

Main menu	Sub-menu	Function	Default setting
Video	Position	(Analog-RGB only) Moves the image display position vertically and horizontally. <ul style="list-style-type: none"> Press the  button and make the adjustment using the display position adjustment screen which appears. 	Depends on connection
	Tracking	(Analog-RGB only) Adjusts computer images when vertical stripes appear in the images.	Depends on connection
	Sync.	(Analog-RGB only) Adjusts computer images when flickering, fuzziness or interference appear in the images. <ul style="list-style-type: none"> Flickering and fuzziness may also appear when the brightness, contrast▶▶, sharpness or keystone settings are adjusted. You can obtain the best results if you adjust the tracking first and then adjust the synchronization. 	0
	Brightness	Adjusts the image brightness.	Median value (0)
	Contrast ▶▶	Adjusts the difference between light and shade in the images. <ul style="list-style-type: none"> If Auto is selected, automatic gain adjustment is carried out at periodical intervals. 	Auto
	Sharpness	Adjusts the image sharpness.	Median value (0)
	Color Mode	Corrects the vividness of the image color. The settings can be saved separately for each type of source (computer or video source). You can select from six different quality settings depending on the surroundings. <ul style="list-style-type: none"> sRGB▶▶ : Images conform to the sRGB standard.* Normal : For presentation in bright rooms where brightness is emphasized. Meeting : Images are modulated using their original tints, with no color enhancement. Presentation: For presentations in dark rooms. Theater : Movie images are optimized using natural tints. Amusement: Produced modulated images with natural tints. Ideal for games. 	Normal
	Resolution	(Analog-RGB only) Select Auto or Manual. <ul style="list-style-type: none"> If Auto is selected, automatic setup is carried out. If Manual is selected, you can select the image resolution for adjustment from a list. 	Auto
	Preset	(Analog-RGB only) Saves the current input resolution to the preset list.	-

Using the Projector Menu Functions

Main menu	Sub-menu	Function	Default setting
Video	Reset	Resets all adjustment values for the Video menu functions to their default settings. <ul style="list-style-type: none">• Press the  button to display the confirmation screen, and select Yes.• Select Reset All to return all menu settings to their default settings. (P.74)	-

* If set to **sRGB**, the color temperature for the **Color Adjustment** command in the **Advanced** menu will be set to 6500K.

RGB-Video

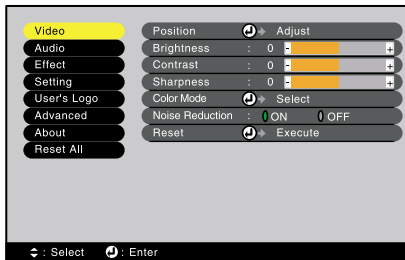

Component (YCbCr, YPbPr)

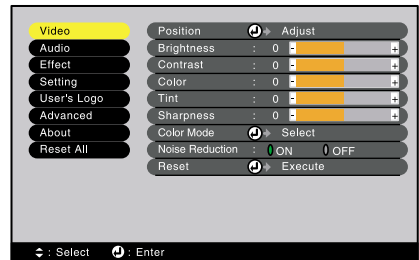

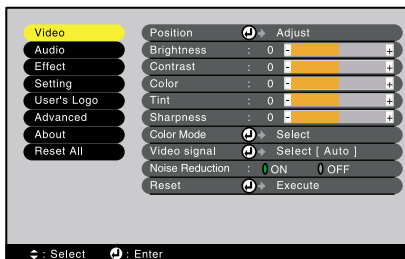

S-Video, Video



Video (RGB-Video, YCbCr, YPbPr, S-Video, Video)

Main menu	Sub-menu	Function	Default setting
Video	Position	Moves the image display position vertically and horizontally. • Press the button and make the adjustment using the display position adjustment screen which appears.	Depends on connection
	Brightness	Adjusts the image brightness.	Median value (0)
	<u>Contrast</u> ▶▶	Adjusts the difference between light and shade in the images.	Median value (0)
	Color	(Not available for RGB-Video) Adjusts the color intensity for the images.	Median value (0)
	Tint	(Not available for RGB-Video) Adjust the image tint. Adjustment is only possible for NTSC signals.	Median value (0)
	Sharpness	Adjusts the image sharpness.	Median value (0)

Using the Projector Menu Functions

Main menu	Sub-menu	Function	Default setting
Video	Color Mode	<p>Corrects the vividness of the image color. The settings can be saved separately for each type of source (computer or video source). You can select from six different quality settings depending on the surroundings.</p> <ul style="list-style-type: none"> • sRGB  : Images conform to the sRGB standard.* • Normal : For presentation in bright rooms where brightness is emphasized. • Meeting : Images are modulated using their original tints, with no color enhancement. • Presentation: For presentations in dark rooms. • Theater : Movie images are optimized using natural tints. The black & white extension function operates to emphasize the gradation differences (color densities) when projecting images in dark or light environments, in order to make the images easier to see. • Amusement: Produced modulated images with natural tints. Ideal for games. 	Theater
	Video Signal	<p>Sets the video signal format.</p> <ul style="list-style-type: none"> • Press the  button, and choose the setting from the video signal format selection sub-menu which appears. • When set to Auto, the video signal format is set automatically, but if projecting signals in PAL (60 Hz) format, the setting needs to be made manually. 	Auto
	Noise Reduction	<p>Turns the Noise Reduction function on and off. When set to ON, noise is reduced. Ignored when a menu or help screen is being displayed, even when set to ON. The setting becomes effective from the point where the menu or help screen is closed.</p>	ON
	Reset	<p>Resets all adjustment values for the Video menu functions to their default settings.</p> <ul style="list-style-type: none"> • Press the  button to display the confirmation screen, and select Yes. • Select Reset All to return all menu settings to their default settings. (P.74) 	-

* If set to **sRGB**, the color temperature for the **Color Adjustment** command in the **Advanced** menu will be set to 6500K.

Audio menu

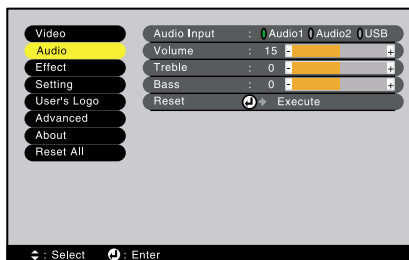

Main menu	Sub-menu	Function	Default setting
Audio	Audio Input	Sets the audio input port from Audio 1, Audio 2 or USB to match the current video source.	Depends on connection
	Volume	Adjusts the volume.	15
	Treble	Adjusts the treble setting.	Median value (0)
	Bass	Adjusts the bass setting.	Median value (0)
	Reset	Resets all adjustment values for the Audio menu functions to their default settings. <ul style="list-style-type: none"> Press the button to display the confirmation screen, and select Yes. Select Reset All to return all menu settings to their default settings. (P.74) 	-

Effect menu

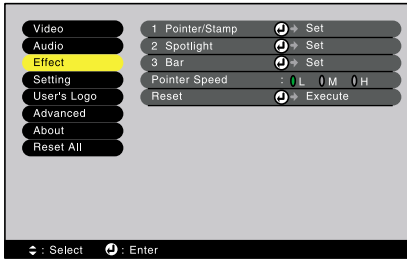

Main menu	Sub-menu	Function	Default setting
Effect	Pointer/Stamp	<p>Sets the three types of pointer icon which appear when the [1] button on the remote control is pressed from the eight available types, and sets the display ratio.</p> <ul style="list-style-type: none"> Press the button, and choose the setting from the Pointer/Stamp sub-menu which appears. The pointer and stamp function can be used by pressing the [1] button on the remote control. (P.58) 	
	Spotlight	<p>Sets the size of the spotlight which appears when the [2] button on the remote control is pressed.</p> <ul style="list-style-type: none"> Press the button, and choose the setting from the Spotlight sub-menu which appears. This selects the sequence of sizes for the spotlight which appear each time the [2] button is pressed. The spotlight function can be used by pressing the [2] button on the remote control. (P.58) 	<p>Size: Medium → Large → Small</p>
	Bar	<p>Sets the color, direction and thickness of the bar which appears when the [3] button on the remote control is pressed.</p> <ul style="list-style-type: none"> Press the button, and choose the setting from the Bar sub-menu which appears. The bar function can be used by pressing the [3] button on the remote control. (P.58) 	
	Pointer Speed	<p>Selects the pointer speed. L: Slow, M: Medium, H: Fast</p>	M
	Reset	<p>Resets all adjustment values for the Effect menu functions to their default settings.</p> <ul style="list-style-type: none"> Press the button to display the confirmation screen, and select Yes. Select Reset All to return all menu settings to their default settings. (P.74) 	-

Setting menu

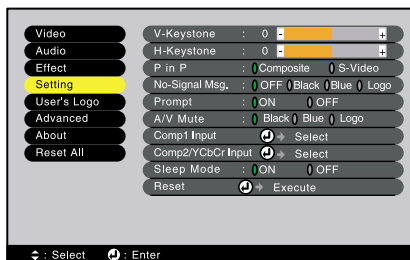



Main menu	Sub-menu	Function	Default setting
Setting	V-Keystone	<p>Corrects vertical keystone distortion in images.</p> <ul style="list-style-type: none"> When keystone correction is carried out, the projected image will become smaller. If using both horizontal and vertical keystone correction, first make the vertical correction and then make the horizontal correction in that order. The keystone correction settings are memorized, so that if you change the position or angle of the projector, you may need to readjust the keystone correction settings. If the images become uneven in appearance after keystone correction is carried out, decrease the Sharpness setting. If you carry out both horizontal and vertical keystone correction, the correction range will become smaller than it would be if only one type of correction was carried out. 	Median value (0)
	H-Keystone	<p>Corrects horizontal keystone distortion in images.</p> <ul style="list-style-type: none"> When keystone correction is carried out, the image becomes smaller. If using both horizontal and vertical keystone correction, first make the vertical correction and then make the horizontal correction in that order. The keystone correction settings are memorized, so that if you change the position or angle of the projector, you may need to readjust the keystone correction settings. If the images become uneven in appearance after keystone correction is carried out, decrease the Sharpness setting. If you carry out both horizontal and vertical keystone correction, the correction range will become smaller than it would be if only one type of correction was carried out. 	Median value (0)

Using the Projector Menu Functions

Main menu	Sub-menu	Function	Default setting
Setting	P in P	Sets the input source for the sub-screen of the Picture in Picture function to either Composite Video or S-Video. <ul style="list-style-type: none"> The Picture in Picture function can be used by pressing the [P in P] button. (P.60) 	Composite
	No-Signal Msg.	Sets the message status and background color at times such as when no video signal is being input. <ul style="list-style-type: none"> To change the user's logo, you need to record and set your own logo. (P.98) 	Blue
	Prompt	Sets whether the source prompt for the input image is displayed on the screen or not.	ON
	A/V Mute	Sets the screen status when the [A/V Mute] button is pressed. <ul style="list-style-type: none"> To change the user's logo, you need to record and set your own logo. 	Black
	Comp1 Input	Sets the video signal for Computer 1 input.	Digital-RGB/ Analog-RGB
	Comp2/ YCbCr Input	Sets the video signal for Computer 2 input.	Analog-RGB
	Sleep Mode	Sets the energy saving operation when no video signal is being input. <ul style="list-style-type: none"> When set to ON, projection stops automatically and the projector changes to sleep mode if no operations are carried out for 30 minutes while the "No-Signal." message is being displayed. (The operation indicator lights orange.) Projection starts again when the [Power] button is pressed. 	ON
	Reset	Returns the adjustment values for the Setting menu to their default settings. <ul style="list-style-type: none"> Press the  button to display the confirmation screen, and select Yes. Select Reset All to return all menu settings to their default settings. 	-

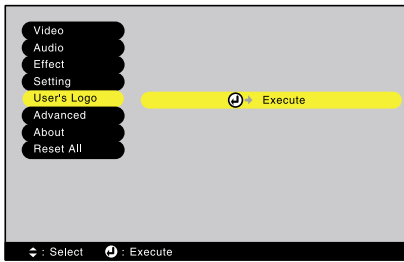
User's Logo menu



Main menu	Sub-menu	Function	Default setting
User's Logo	Execute	Records a user's logo. (P.98) <ul style="list-style-type: none">• Press the  button and follow the procedure appearing on the screen.	EPSON logo

Advanced menu

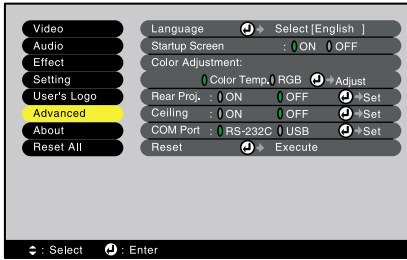

Main menu	Sub-menu	Function	Default setting
Advanced	Language	Sets the language for message displays. <ul style="list-style-type: none"> Press the button and select the language from the selection menu that appears. 	English
	Startup Screen	Sets whether the startup screen is displayed or not. <ul style="list-style-type: none"> To change the user's logo, you need to record and set your own logo. 	ON
	Color Adjustment	Adjusts the <u>color temperature</u> and intensity of each RGB color in the image. Color Temp.: Sets the color temperature. <ul style="list-style-type: none"> Press the button and set the color temperature in the Color Adjustment sub-menu. RGB: Sets the color intensity for each RGB (red/green/blue) color in the image. <ul style="list-style-type: none"> Press the button, select R (red), G (green) or B (blue) in the Color Adjustment sub-menu, and make the required setting for each color. You can adjust the colors while viewing the results on the screen. (This item cannot be selected if sRGB has been selected as the Color Mode setting in the Video menu.)	Color Temp : Depends on connection
	Rear Proj.	Use when projecting images from behind a translucent screen. When set to ON , the projected images are horizontally reversed.	OFF
	Ceiling	Use when installing the projector to a ceiling. When set to ON , the projected images are horizontally and vertically reversed.	OFF
	COM Port	Sets the communication ports for switching between RS-232C connections and USB connections.	RS-232C
	Reset	Resets all adjustment values for the Advanced menu functions to their default settings. <ul style="list-style-type: none"> Press the button to display the confirmation screen, and select Yes. Select Reset All to return all menu settings to their default settings. 	-

About menu

- The **About** menu shows the setting details for the current video source.
- The **Lamp** setting appears as **0H** for 0 – 10 hours, after that, it appears in units of 1 hour.

Computer

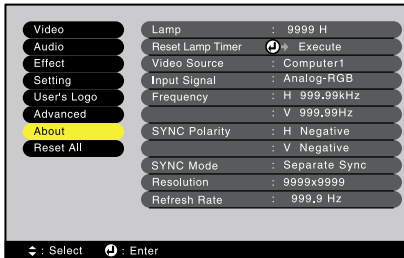

Computer (Digital-RGB, Analog-RGB, RGB-Video, YCbCr, YPbPr)

Main menu	Sub-menu	Function	Default setting
About	Lamp	Displays the cumulative lamp operating time. <ul style="list-style-type: none"> • When the lamp warning period is reached, the display characters appear in red. 	0H
	Reset Lamp Timer	Initializes the lamp operating time. When this command is selected, the cumulative lamp operating time is reset to the initial default value.	-
	Video Source	Displays the input source which is currently being projected.	-
	Input Signal	Displays the input signal settings.	-
	Frequency	Displays the horizontal scanning frequency.	-
	SYNC Polarity	Displays the synchronization polarity.	-
	SYNC Mode	Displays the synchronization attributes.	-
	Resolution	Displays the input resolution.	-
	Refresh Rate▶▶	Displays the refresh rate.	-

Using the Projector Menu Functions

Video

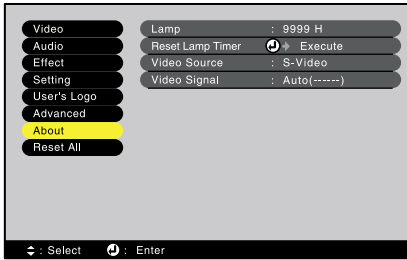

Video (S-Video, Video)

Main menu	Sub-menu	Function	Default setting
About	Lamp	Displays the cumulative lamp operating time. • When the lamp warning period is reached, the display characters appear in red.	0H
	Reset Lamp Timer	Initializes the lamp operating time. When this command is selected, the cumulative lamp operating time is reset to the initial default value.	-
	Video Source	Displays the input source which is currently being projected.	
	Video Signal	Displays the video signal format.	Auto

Reset All menu

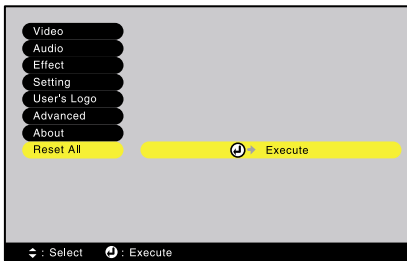

Main menu	Sub-menu	Function	Default setting
Reset All	Execute	Resets all items in all setting menus to their default settings. • Press the button to display the confirmation screen, and select Yes . • Select Reset in an individual menu to reset only the settings for the items in each sub-menu. • The User's Logo, Lamp and Language settings will not return to their default settings.	-

Using the Menu

The menu can be operated using either the remote control or the projector's control panel.

Procedure

- 1 Press the [Menu] button on either the remote control or the projector's control panel.**

The Main menu will be displayed.

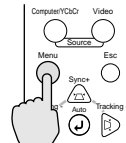

Projector

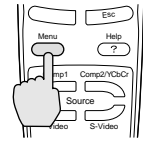

Remote control

- 2 Select a menu item.**

If using the control panel, press the [Sync +] or [Sync -] button.

If using the remote control, press the top or bottom of the  button.

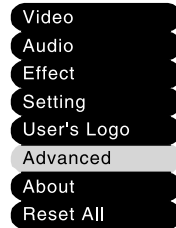

- 3 Confirm the selection.**

Press the  button to confirm the selection of a menu item.

The selected sub-menu will then be displayed.

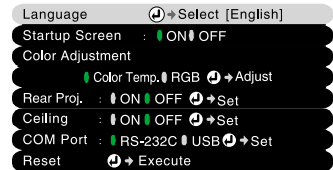

- 4 Select a sub-menu item.**

If using the control panel, press the [Sync +] or [Sync -] button.

If using the remote control, press the top or bottom of the  button.

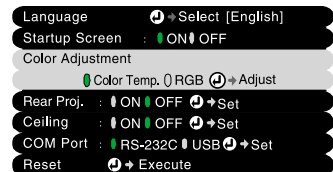

The items appearing in the **Video** menu and the **About** menu will vary depending on the type of input source being projected.



5 Select a setting value.

If using the control panel, press the [Tracking -] or [Tracking +] button.

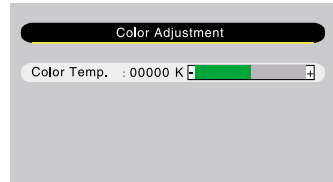
If using the remote control, press the left or right edge of the  button.



Tip :

- *Sub-menu items which cause another sub-menu to be displayed when they are selected have  (Enter) after them. If you select such menu items and press the  button, you can then change the settings in the next sub-menu which appears.*
- *Refer to "List of Functions" for details on the functions of each menu item. (P.62)*

6 Select other menu items in the same way.

Repeat steps 2 to 5 to change the setting for other menu items. To return to a previous menu, press the [Esc] button.

7 Close the menu.

Press the [Menu] button.



Appendices

This chapter provides information on troubleshooting and maintenance procedures to ensure the best level of performance for the projector for a long time.

Troubleshooting	78
• Using the Help	78
• When Having Some Trouble	80
• When the Indicators Provide No Help	83
Maintenance	91
• Cleaning	91
• Cleaning the Projector Case.....	91
• Cleaning the Lens.....	91
• Cleaning the Air Filter.....	92
• Replacing Consumables	93
• Lamp Replacement Period.....	93
• Replacing the Lamp.....	94
• Resetting the Lamp Operating Time.....	96
• Replacing the Air Filter.....	97
Saving a User's Logo	98
Optional Accessories	100
Glossary	101
List of ESC/VP21 Commands	103
• Command List	103
• Communication protocol	104
• USB Connection Setup	104
• Cable layouts	105
• Serial connection.....	105
• USB connection.....	105
List of Supported Monitor Displays	106
Specifications	107
Appearance	109
Index	110

Troubleshooting

This section describes how to identify problems and what to do if a problem is found.

Using the Help

If a problem occurs with the projector, the Help function uses on-screen displays to assist you in solving the problem. It uses a series of menus in a question and answer format.

Procedure

- 1 Press the [Help] button on either the remote control or the projector's control panel.**

The Help menu will be displayed.

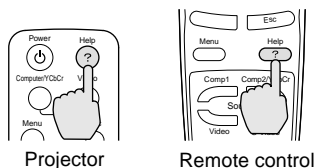

- 2 Select a menu item.**

If using the control panel, the [Sync +] and [Sync -] buttons function as the up and down keys.

If using the remote control, press the top or bottom of the  button.

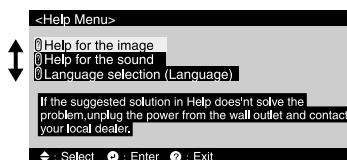
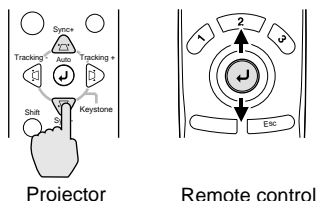

- 3 Confirm the selection.**

Press the  button to confirm the selection of a menu item.

You can press the [Esc] button to return to the previous menu.

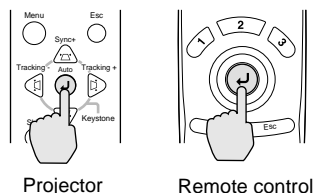

4 Repeat the operations in steps 2 and 3 to proceed through the menu to more detailed items.

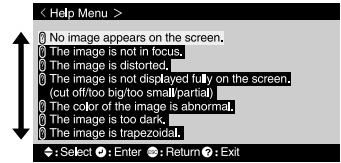

You can exit the Help menu at any time by pressing the [Help] button.

Tip :

If the Help function does not provide a solution to the problem, refer to "When Having Some Trouble" (P.80) or "When the Indicators Provide No Help" (P.83).

When Having Some Trouble

If you are having a problem with the projector, first check the projector's indicators.

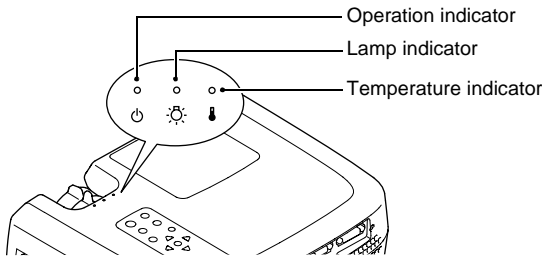

The projector is provided with the following three indicators. These indicators alert you to problems with projector operation.







The following tables show what the indicators mean and how to remedy problems that they indicate.

● : lit ✨ : flashing ○ : off

Indicator status	Projector status	Problem and remedy	Reference page
red ● red ✨ red ✨ ● ✨ ✨ ○ ✨ ✨	Internal problem	Stop using the projector, disconnect the power cord from the electrical outlet, and contact your dealer or the nearest address provided at "International Warranty Conditions" in <i>Safety Instructions/World-Wide Warranty Terms</i> included in the package.	
red ● ○ red ✨ ● ○ ✨ ○ ✨ ✨	Fan problem/ Sensor problem	Stop using the projector, disconnect the power cord from the electrical outlet, and contact your dealer or the nearest address provided at "International Warranty Conditions" in <i>Safety Instructions/World-Wide Warranty Terms</i> included in the package.	
red ● red ● ○ ● ✨ ✨ ○ ✨ ✨	Lamp problem	Replace the lamp with a new one. When replacing the lamp, check that the lamp and the lamp cover are securely installed. If the lamp or lamp cover is not securely installed, the projector power will not turn on.	P.94

Indicator status	Projector status	Problem and remedy	Reference page
<p>red red</p> 	<p>Lamp operating error</p>	<p>This can happen when the power cord was disconnected from the electrical outlet before the cool-down period had finished the last time the projector was turned off.</p> <p>When turning off the projector, wait 2 minutes. After about 2 minutes, the cooling fan will stop. When the cooling fan stops, disconnect the power plug and then re-insert it. When the power cord is plugged back in, the projector will return to its previous state, so press the [Power] button on either the remote control or the projector's control panel to turn it back on. If the lamp operating error happens again when the power is turned back on, remove the lamp and check if the lamp is broken. If it is not broken, reinstall it. If it is broken, replace it. Then press the [Power] button on either the remote control or the projector's control panel. If the indicators still show a problem, stop using the projector, disconnect the power cord from the electrical outlet, and contact your dealer or the nearest address provided at "International Warranty Conditions" in <i>Safety Instructions/World-Wide Warranty Terms</i> included in the package.</p>	
<p>red red</p> 	<p>High temperature inside projector (overheating)</p>	<p>The lamp will turn off automatically and projection will stop. Wait for about 5 minutes without operating the projector. After 5 minutes have elapsed, the projector's cooling fan will stop. Once the cooling fan has stopped, unplug the power cord and then plug it back in again.</p> <p>If the projector overheats, check the following two points.</p> <ul style="list-style-type: none"> • Is the setting-up location well ventilated? Check that the air inlet and air outlet are clear, and that the projector is not positioned against a wall. • Is the air filter blocked with dust? If the air filter is dirty, it should be cleaned. <p>When the power cord is plugged back in, the projector will return to its previous state, so press the [Power] button on either the remote control or the projector's control panel to turn it back on. If the projector continues to overheat even after the above points have been checked, or if the indicators show a problem when the power is turned back on, stop using the projector, disconnect the power cord from the electrical outlet, and contact your dealer or the nearest address provided at "International Warranty Conditions" in <i>Safety Instructions/World-Wide Warranty Terms</i> included in the package.</p>	<p>P.18 P.92</p>

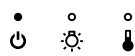
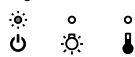
Indicator status	Projector status	Problem and remedy	Reference page
<p>red</p>  <p>orange</p> 	High-speed cooling in progress	<p>(This is not an abnormality, but if the temperature rises too high again, projection will stop automatically.)</p> <ul style="list-style-type: none"> Set the projector up in a place which is well-ventilated, and so that the air inlet and exhaust vents are clear. Clean the air filter. 	P.18 P.92
<p>orange</p> 	Lamp will soon need to be replaced.	<p>Have a new replacement lamp ready. The lamp service life can become shorter than normal as a result of the usage conditions, and so the lamp should be replaced as soon as possible.</p> <p>* The appearance of the operation indicator at this time will vary depending on the status of the projector.</p>	P.94
<p>orange</p> 	Standby condition	<p>(No abnormality) Projection starts when the [Power] button is pressed.</p>	P.37
<p>green</p> 	Warm-up in progress	<p>(No abnormality) Wait for a short while. The indicator will stop flashing and light with a green color.</p>	P.37
<p>green</p> 	Projecting in progress	<p>(No abnormality)</p>	P.37
<p>orange</p> 	Cool-down in progress	<p>(No abnormality)</p> <ul style="list-style-type: none"> Wait for a short while. The cool-down (lamp cooling operation) period lasts for about 2 minutes. The actual time will vary depending on the external air temperature. The [Power] button will not operate during the cool-down period. When cool-down is complete, the indicator will stop flashing and light orange. You can then use the [Power] button. 	P.39

Tip :

- If the projector is not operating properly even though the indicators are all showing normal, refer to "When the Indicators Provide No Help" on the following page.
- If an indicator is showing a status which does not appear in the previous tables, contact your dealer or the nearest address provided at "International Warranty Conditions" in Safety Instructions/World-Wide Warranty Terms included in the package.

When the Indicators Provide No Help

If any of the following problems occur and the indicators do not offer a solution, refer to the pages given for each problem.

- No images appear (P.83, 84)
- Poor image quality (P.85, 86)
- Only part of the image is displayed (Large/small) (P.87)
- Images appear dark (P.87)
- The image colors are not right (P.88)
- No sound can be heard (P.89)
- The remote control does not work (P.90)
- The power does not turn off (P.90)

No images appear (Nothing at all appears)



No images appear

- Is the lens cover still attached? (P.36)
- Was the power turned off and then straight back on again?
After the power is turned off (during cool-down), the [Power] button will not work. Wait until cool-down has finished. You can then use the [Power] button. (P.39)
- Is sleep mode active?
When sleep mode has been set to **ON**, the lamp turns off automatically if no operations are carried out for 30 minutes while no video signal is being input. The operation indicator lights orange at this time.
Setting - Sleep Mode (P.70)
- Have you pressed the [Power] button? (P.37)
- Has the image brightness been adjusted correctly?
Video - Brightness (P.63)
- Is A/V Mute mode active? (P.52)
- Is the projected image completely black?
Some input images, such as screen savers, may be completely black.
- Is a video signal being input?
If **No-Signal Msg.** in the **Setting** menu has been set to **OFF**, no messages will be displayed. Set it to **Black** or **Blue** for messages to be displayed. If a message is displayed, refer to the item indicated. (P.70)
- Try resetting all of the current settings.
Reset All - Execute (P.74)

No images appear (Messages do appear)

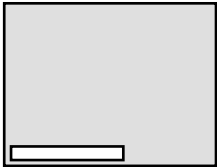
	<ul style="list-style-type: none">• Check the mode which corresponds to the frequency of the image signals being output from the computer. Refer to the documentation provided with your computer for details on changing the resolution and frequency of the image signals being output from the computer. (P.106)• Does the input signal match the connected source? Use the Comp1 Input or Comp2/YCbCr Input command in the Setting menu to select the signal format that matches the connected source. For Comp1: Digital-RGB, Analog-RGB, RGB-Video For Comp2: Analog-RGB, RGB-Video, YCbCr, YPbPr (P.70)
<p>"Not Supported" is displayed.</p>	<ul style="list-style-type: none">• Are the cables connected correctly? (P.19 – 33)• Has the correct video input port been selected? Press the [Computer/YCbCr] or [Video] button on the projector's control panel or the [Comp1], [Comp2/YCbCr], [Video] or [S-Video] button on the remote control to change the image source. (P.38)• Is the power for the computer or video source turned on? (P.37)• If a laptop computer or a computer with a LCD screen has been connected to the projector, it is necessary to output the video signals to the projector rather than to the screen. Normally video signals are output to only the computer's LCD screen, so you need to change the output to an external destination. For some computer models, when the image signals are output externally, they no longer appear on the LCD screen. For details, refer to the section of the documentation provided with your computer under a heading such as "External output", "Connecting an external monitor" or similar. (P.38)



"No-Signal." is displayed.

Poor image quality

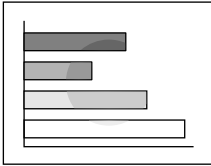

- The image is fuzzy
 - Part of the image is out of focus
 - The whole image is out of focus
- Has the focus been adjusted correctly? (P.46)
 - Has the front adjustable foot been adjusted so that the image angle is too big?
If the image angle is too big, the image will be out of focus vertically. (P.42)
 - Is the projector at the correct distance?
The recommended distance from the projector to the screen is within 0.9 – 12.4 m (3.0 – 40.7 ft.). Set up the projector so that the projection distance is within this range. (P.18)
 - Is the projector beam perpendicular to the screen? (P.42)
 - Is the lens dirty? (P.91)
 - Has condensation formed on the lens?
If the projector is suddenly taken from a cold environment to a warm environment, condensation may form on the lens, and this may cause the images to appear fuzzy. If this happens, turn off the power and wait for the condensation to disappear.
 - Have the synchronization▶▶, tracking▶▶ and display position been adjusted correctly?
Press the [Auto] button to adjust these settings. You can also use the menus to make the adjustment. (P.46), **Video** (P.63)
 - Are the image signal format settings correct?
Use the **Video Signal** command in the **Video** menu to select the video signal format. The projector may not be able to automatically identify some types of video signal that are input. (P.66)
 - Does the input signal match the connected source?
Use the **Comp1 Input** or **Comp2/YCbCr Input** command in the **Setting** menu to select the signal format that matches the connected source.
For Comp1: Digital-RGB, Analog-RGB, RGB-Video
For Comp2: Analog-RGB, RGB-Video, YCbCr, YPbPr (P.70)

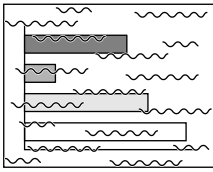

- Image is distorted
- Image contains interference

- Are the cables connected correctly?
(P.19 – P.33)
- Has the correct resolution been selected?
Set the computer so that the signals that are output are compatible with this projector. Refer to the documentation provided with your computer for details on changing the settings. (P.106)
- Have the **synchronization**▶▶, **tracking**▶▶ and display position been adjusted correctly?
Press the [Auto] button to adjust these settings. You can also use the menus to make the adjustment. (P.46, 63)
- Is an extension cable being used?
If an extension cable is used, electrical interference may increase. Use the accessory cables provided, or connect a signal amplifier and see if this helps.
- Are the image signal format settings correct?
Use the **Video Signal** command in the **Video** menu to select the video signal format. The projector may not be able to automatically identify some types of video signal that are input. (P.66)
- Does the input signal match the connected source?
Use the **Comp1 Input** or **Comp2/YCbCr Input** command in the **Setting** menu to select the signal format that matches the connected source.
For Comp1: Digital-RGB, Analog-RGB, RGB-Video
For Comp2: Analog-RGB, RGB-Video, YCbCr, YPbPr
(P.70)

Only part of the image is displayed (Large/small)

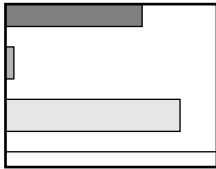

Only part of the image is displayed

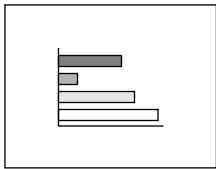

Small

- The [Resize] setting may not be selected correctly. Press the [Resize] button. (P.41, 55)
- Has the **Position** setting been adjusted correctly? Use the **Position** command in the **Video** menu to adjust. (P.63)
- Has the correct resolution been selected? Set the computer so that the signals that are output are compatible with this projector. Refer to the documentation provided with your computer for details on changing the settings. (P.106)
- Change the resolution for the laptop computer or computer with a LCD screen. Change the resolution so that the image is displayed in the whole of the projection area, or set the video signal to external output only. (P.38)
- Has the computer been set for dual display? If dual display has been activated in the Display Properties of the computer's Control Panel, the projector will only project about half of the image on the computer screen. To display the whole of the image on the computer screen, turn off the dual display setting. Refer to the video driver manual for the computer's monitor for further details.

Images appear dark

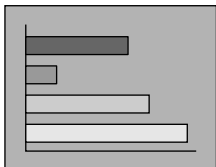

- Is the lamp due for replacement? If the lamp indicator is flashing orange, it means that the lamp will soon be due for replacement. When the lamp is nearly due for replacement, the image will become darker, and so the lamp should be replaced with a new one. (P.93)
- Has the image brightness been adjusted correctly? **Video - Brightness (P.63)**
- Has the image contrast▶▶ been adjusted correctly? **Video - Contrast (P.63)**

The image colors are not right

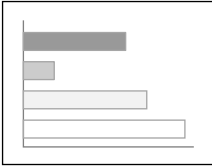

- Has the image brightness been adjusted correctly?
Video - Brightness (P.63)
- Are the cables connected correctly?
(P.19 – P.33)
- Has the image contrast▶▶ been adjusted correctly?
Video - Contrast (P.63)
- Has the color been adjusted correctly?
Video - Color Mode (P.63)
- Have the color intensity and tint been adjusted correctly?
(The colors may not exactly match the colors in the image on the computer screen or LCD screen, but this is normal and is not the sign of a problem.)
Video - Color (P.65)
Video - Tint (P.65)
- Is the lamp due for replacement?
If the lamp indicator is flashing orange, it means that the lamp will soon be due for replacement. When the lamp is nearly due for replacement, the image will become darker, and so the lamp should be replaced with a new one. (P.93)
- Does the input signal match the connected source?
Use the **Comp1 Input** or **Comp2/YCbCr Input** command in the **Setting** menu to select the signal format that matches the connected source.
If the signal format is set to "YCbCr" or "YPbPr" when a computer is connected, the projected images will appear purplish.
If the signal format is set to "Analog-RGB" when a component video source is connected, the projected images will appear greenish.
(P.70)

No sound can be heard

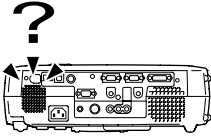

- Is the audio source connected correctly?
(P.24)
- Has the correct audio input port been selected?
Use the **Audio Input** command in the **Audio** menu to set the port for audio signal input. (P.67)
- Is sound being output from the audio source?
Check the volume for the audio source.
- Has the volume been adjusted to the minimum setting?
(P.49)
- Has the A/V Mute function been turned on?
The projector may be in A/V Mute mode. Press the [A/V Mute] button on the projector's control panel or the remote control to cancel the **A/V Mute** sub-menu command. (P.52)
- Is sound being output to external speakers?
If a stereo mini jack is connected to the Audio Out port, no sound will be output from the projector's built-in speaker. (P.34)
- Have the correct USB audio settings for this projector been made at the computer?
If using a USB cable to output sound from the computer, you need to select USB audio for the projector in the audio properties for the computer.

The remote control does not work



- Is the R/C switch on the remote control set to the ON position? (P.14)
- Is the remote control being pointed in the right direction?
The operating angle for the remote control is approximately $\pm 30^\circ$ horizontally and approximately $\pm 15^\circ$ vertically.
- Is the remote control too far from the projector?
The operating distance for the remote control is approximately 10 m (30 ft.). (P.14)
- Is the remote control being pointed at the projector when a remote control receiver has been connected?
- Is direct sunlight or strong light from fluorescent lamps shining onto the remote control receiver?
- Are there batteries in the remote control? (P.13)
- Are the batteries dead?
- Have the batteries been inserted correctly? (P.13)
- If the mouse function does not work after connecting a PS/2 mouse, you will need to restart the computer.

The power does not turn off (after the [Power] button is pressed)

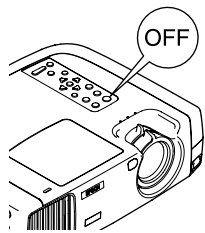

- The operation indicator remains orange.
This projector is designed so that the operation indicator remains lit even when after the power has been turned off. The operation indicator will switch off when the power cord is disconnected from the electrical outlet.
 - Cooling fan does not stop.
After the [Power] button on either the remote control or the projector's control panel is pressed to turn off the power, the cool-down period starts. After this, the operation indicator changes to a steady orange, and you can then disconnect the power cord from the electrical outlet.
- * The cool-down period lasts for about 2 minutes. The actual time will vary depending on the external air temperature.

Maintenance

This section describes maintenance tasks such as cleaning the projector and replacing consumable parts.

Cleaning

You should clean the projector if it becomes dirty or if the quality of projected images starts to deteriorate.

Be sure to read the separate Safety Instructions/World-Wide Warranty Terms for details on safe handling of the projector during cleaning.

Cleaning the Projector Case

Clean the projector case by wiping it gently with a soft cloth.

If the projector is particularly dirty, moisten the cloth with water containing a small amount of neutral detergent, and then firmly wring the cloth dry before using it to wipe the projector case. Then wipe the case again with a soft, dry cloth.

Caution :

Do not use volatile substances such as wax, alcohol or thinner to clean the projector case. These can cause the case to warp and make the coating finish peel off.

Cleaning the Lens

Use a commercially-available air blower, or use a lens cleaning paper to gently wipe the lens.

Caution :

Do not rub the lens with harsh materials or subject the lens to shocks, as it can easily become damaged.

Cleaning the Air Filter

If the air filter becomes clogged with dust, it can cause overheating and damage the projector.

Stand up the projector in order to prevent dust getting inside the projector, and then use a vacuum cleaner to clean away the dust from the air filter.

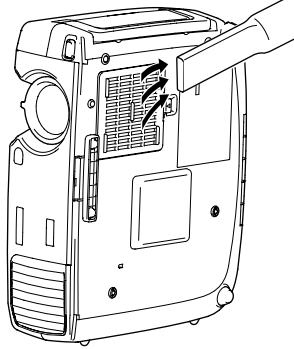

Tip :

- *If the air filter is difficult to clean or if it is broken, it should be replaced. Contact your dealer for a spare air filter.*
- *Replacement lamps are provided with a spare air filter. The air filter should also be replaced when the lamp is replaced.*

Replacing Consumables

This section describes how to replace the lamp and the air filter.

Lamp Replacement Period

It is time to replace the lamp when:

- The message "Lamp Replace" appears on the screen for 30 seconds when projection starts.

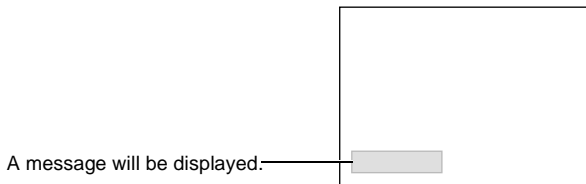

- The lamp indicator flashes orange or lights red.

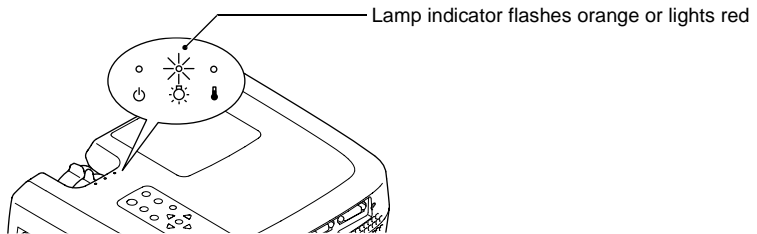

- The projected image gets darker or starts to deteriorate.

Tip :

- In order to maintain the brightness and quality of the projected images, replace the lamp as soon as possible after the warning message appears.
- The replacement warning message is set to appear after 1400 hours of lamp use in order to maintain the brightness and quality of the projected images. If you continue to use the lamp after this period, the possibility of the lamp breaking becomes greater. When the lamp replacement message appears, replace the lamp with a new one as soon as possible, even if it is still working.
- The warning message appears after 1400 hours of use, but the actual life of each individual lamp will vary depending on the characteristics of the lamp and on the way it has been used. Some lamps may stop operating before 1400 hours of use, so you should always have a spare lamp ready in case.
- When the lamp replacement warning message appears, the user's logo will not appear even if the start-up screen setting is ON.
- Contact your dealer for a spare lamp.

Replacing the Lamp

Caution :

If the lamp stops working and needs to be replaced, there is the danger that the lamp may break when handled.

If replacing the lamp of a projector which has been installed to the ceiling, you should always assume that the lamp is broken and handle it with extreme care during removal.

Furthermore, you should stand to the side of the projector, not underneath it.

Procedure

- 1 Turn off the projector power, wait for the cool-down period to end, and then disconnect the power cord.**

The cool-down period lasts for about 2 minutes. The actual time will vary depending on the external air temperature.

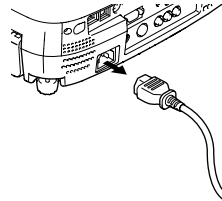

- 2 Wait until the lamp has cooled down, and then remove the lamp cover.**

It takes approximately 30 minutes for the lamp to cool down by itself.

Use the screwdriver that is provided with the replacement lamp to slide the lamp cover opening switch so that the lamp cover lifts up. Hold the raised section of the lamp cover and then slide it forward to remove it from the projector.

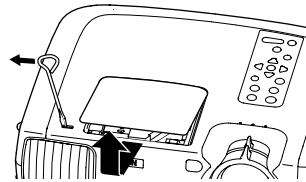

- 3 Loosen the two lamp fixing screws.**

Use the screwdriver that is supplied with the replacement lamp to loosen the two lamp fixing screws that are securing the lamp to the projector.

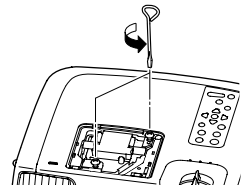

4 Take out the lamp.

Hold the lamp by the two recesses on the side to lift it up and out from the projector.

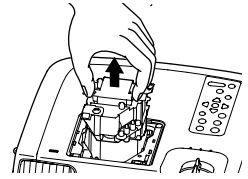

5 Install the new lamp.

Hold the lamp so that it faces the correct way to fit into the projector, and then insert the lamp until it clicks into place and tighten the two fixing screws.

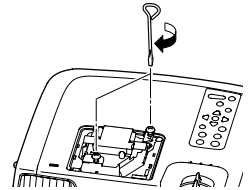

6 Install the lamp cover.

Insert the two cover tabs into the projector, and then press the other side of the lamp cover until it clicks into place.

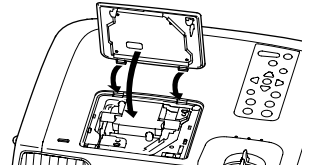

Tip :

- *Install the lamp securely. If the lamp cover is removed, the lamp turns off automatically as a safety precaution. Moreover, the lamp will not turn on if the lamp or the lamp cover is not installed correctly.*
- *Replacement lamps are provided with a spare air filter. The air filter should also be replaced when the lamp is replaced.*
- *Dispose of used lamps properly in accordance with your local regulations.*

Resetting the Lamp Operating Time

The projector has a built-in counter which keeps track of the lamp operating time. When the cumulative operating time reaches a certain point, it causes the replacement warning message to be displayed. Therefore, the counter needs to be reset after the lamp has been replaced with a new one. You can do this using the projector menu.

Procedure

- 1 Press the [Menu] button on either the remote control or the projector's control panel.

The Main menu will be displayed.

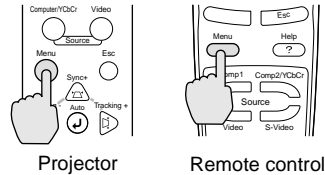

- 2 Select Reset Lamp Timer from the About menu and then press the  button.

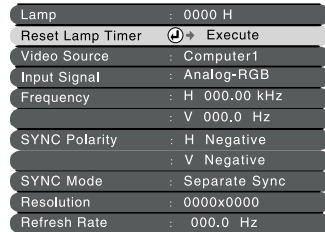

- 3 Select Yes and then press the  button.

The lamp operating time will then be reset.

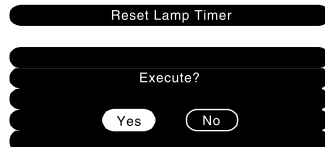

Tip :

Do not reset the lamp operating time except after the lamp has been replaced, otherwise the lamp replacement period will not be indicated correctly.

Replacing the Air Filter

Procedure

- 1 Turn off the projector power, wait for the cool-down^{▶▶} period to end, and then disconnect the power cord.**

The cool-down period lasts for about 2 minutes. The actual time will vary depending on the external air temperature.

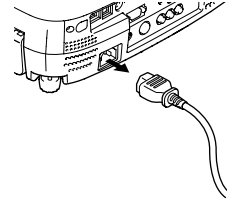

- 2 Put your finger into the recess in the air filter hook, and lift up the air filter to remove it.**

In order to prevent any dust on the air filter from getting into the projector, be sure to stand up the projector so that the handle is at the top.

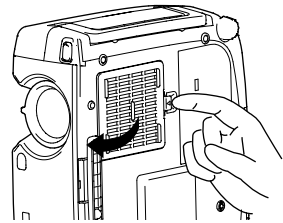

- 3 Install the new air filter.**

First insert the tabs, and then press down on the opposite side until it clicks into place.

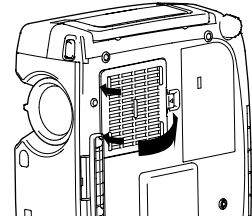

Tip :

Dispose of used air filters properly in accordance with your local regulations.

Saving a User's Logo

You can record the image that is currently being projected as a user's logo.

Procedure

1 Project the image that you would like to use as a user's logo, and then press the [Menu] button on the projector's control panel or the remote control.

2 Select the User's Logo menu, and then press the  button.

Tip :

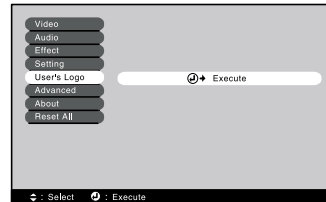

If keystone correction has been carried out, it will be canceled when the User's Logo menu is selected.

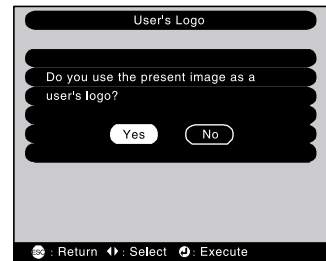

3 Select Yes in the sub-menu, and then press the  button.



4 The image to be recorded and a selection marquee box will be displayed. Move the marquee box to select the part of the image to use.

Tilt the  button on the remote control to select the part of the image to use as the user's logo, and then press the  button.

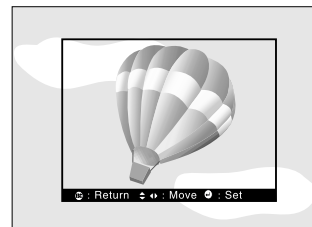

Tip :

If the video signal being input is a YCbCr or YPbPr signal, the selection marquee box can only be moved around the middle of the image.

- 5** Select Yes at the confirmation screen, and then press the  button.

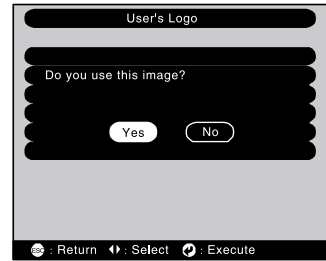

- 6** Select the zoom rate in the Zoom rate setting screen, and then press the  button.

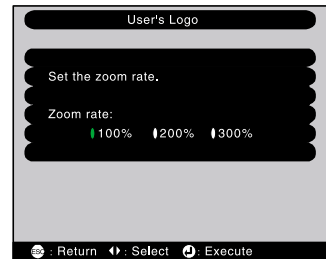

- 7** Select Yes at the confirmation screen, and then press the  button.

The image will then be saved. Once the image has been saved, the message "Saving the user's logo is completed." will be displayed.



Tip :

- Saving the user's logo may take a few moments (about 40 seconds). Do not use the projector or any other sources which are connected to the projector while the user's logo is being saved, otherwise it may result in errors in projector operation.
- User's logos can be saved at up to 400 x 300 dots in size.
- If the image resolution is not XGA, or if a video image is being projected, the display size will be changed.
- Once a user's logo has been saved, the logo setting cannot be returned to the factory default.

Optional Accessories

The following optional accessories are available for purchase if required. This list of optional accessories is current as of April 2002. Details of accessories are subject to change without notice.

Hard travel case Soft carrying case Use this case if you need to carry the projector by hand.	ELPKS26 ELPKS27	Digital video cable (3 m (9.8 ft.) - for DVI-D/DFP 20-pin) DFP cable for connecting the projector to a computer with a digital RGB output interface.	ELPKC21
Spare lamp Use as a replacement for spent lamps.	ELPLP15	DVI analog cable (3 m (9.8 ft.) - for DVI-I/mini D-Sub 15-pin) Use to connect the projector to connect two computers with analog RGB output to the projector.	ELPKC25
Portable screen (50 inch) A compact screen which can be carried easily.	ELPSC06	Component video cable (3 m (9.8 ft.) - for mini D-Sub 15-pin/RCA x 3) Use to connect a component video source.	ELPKC19
60 inch screen	ELPSC07	Remote control receiver Use to control the projector with the remote control from a distance.	ELPST04
80 inch screen	ELPSC08	Ceiling mount * Use when installing the projector to a ceiling.	ELPMB07
Computer cable (1.8 m (6 ft.) - for mini D-Sub 15-pin/mini D-Sub 15-pin) Use to connect the projector to a computer when you would like to use UXGA display resolution.	ELPKC02	Ceiling plate * Pipe 370 (370 mm (14.57 inches)/silver)* Pipe 570 (570 mm (22.4 inches)/silver)* Pipe 770 (770 mm (30.3 inches)/silver)* Use when installing the projector to a high ceiling or a ceiling with veneer panels.	ELPFC03 ELPFP04 ELPFP05 ELPFP06
Computer cable (3 m (9.8 ft.) - for mini D-Sub 15-pin/mini D-Sub 15-pin)	ELPKC09	Image presentation camera Use when projecting books, OHP films and slides.	ELPDC02 ELPDC03 ELPDC04
Computer cable (20 m (65.6 ft.) - for mini D-Sub 15-pin/mini D-Sub 15-pin) Use this extension cable if the accessory computer cable is too short.	ELPKC10		
Computer cable (1.8 m (6 ft.) - for mini D-Sub 15-pin/5BNC) Use to connect the projector to a workstation.	ELPKC11		
Digital video cable (3 m (9.8 ft.) - DVI-D male-male) DVI cable for connecting the projector to a computer with a digital RGB output interface.	ELPKC20		

* A special method of installation is required in order to suspend the projector from the ceiling. Please contact the place of purchase if you would like to use this installation method.

Glossary

Following is an explanation of some of the terms used in this guide which may be unfamiliar or which were not explained in the manual itself. Further information can be obtained by referring to other commercially-available publications.

5BNC	A port used to input analog video signals.
A/V Mute	The momentary canceling of audio and video output. This projector has an [A/V Mute] button which you can press to momentarily stop the projection of pictures and sound. The picture and sound can be restored by pressing the [A/V Mute] button on the projector's control panel or the remote control once more.
Aspect ratio	The ratio between an image's length and its height. HDTV images have an aspect ratio of 16:9 and appear elongated. The aspect ratio for standard images is 4:3.
Color difference signal (component)	A type of video signal output by video equipment which actually consists of three separate signals: a red + luminance signal (R-Y), a luminance signal (Y) and a blue + luminance signal (B-Y). Each signal is transmitted along a separate cable. Color difference signals generally result in a better image than composite signals (in which the red, green and blue signals and the luminance signal are all transmitted along a single cable).
Color temperature	The temperature of an object which is emitting light. If the color temperature is high, the colors tend to take on a bluish tinge. If the color temperature is lower, the colors tend to take on a reddish tinge.
Component video	Video signals which have the video brightness signals and color signals separated, in order to provide better image quality. In high-definition TV (HDTV), it refers to images which consist of three independent signals: Y (luminance signal), and Pb and Pr (color difference signals).
Composite video	Video signals which have the video brightness signals and color signals mixed together. The type of signals commonly used by household video equipment (NTSC format). The signals consist of the carrier signal Y (luminance signal) and the chroma (color) signal which are contained in the color bar signal.
Contrast	The relative brightness of the light and dark areas of an image can be increased or decreased in order to make text and graphics stand out more clearly, or to make them appear softer. Adjusting this particular property of an image is called "contrast adjustment".
Cool-down	The cooling process for the projector's lamp unit continues even after the [Power] button has been pressed to turn off the lamp. After the lamp turns off, the cooling fan continues operating, but all button operations are disabled. The length of time that this is happening is called the "cool-down period". The cool-down period lasts for about 2 minutes. The actual time will vary depending on the external air temperature.
DFP	Abbreviation for Digital Flat Panel. Refers to a standard method for digital transmission of video signals.
DVI	Abbreviation for Digital Visual Interface. Refers to a standard method for digital transmission of video signals. DVI is a standard which has also been applied to digital household electronic equipment other than computers. It allows images to be transmitted at higher resolutions than for DFP, and also includes a digital signal encoding function.
Freeze	The momentary pausing of image playback only. When the [Freeze] button on the projector is pressed, the image playback only can be paused. When the [Freeze] button is pressed again, playback resumes.
HDTV	An abbreviation for High-Definition Television. It refers to high-definition systems which satisfy the following conditions. <ul style="list-style-type: none">• Vertical resolution of 720P or 1080i or greater (P = progressive scanning, i = interlaced scanning)• Screen aspect ratio of 16:9• Dolby Digital audio reception and playback (or output)

Interlaced scanning	A method of image scanning whereby the signal bandwidth used is approximately half that required for sequential scanning when images with the same still picture resolution are broadcast.
Refresh Rate	The light-emitting element of a display maintains the same luminosity and color for an extremely short time. Because of this, the image must be scanned many times per second in order to refresh the light emitting element. The number of refresh operations per second is called the "refresh rate", and is expressed in hertz (Hz).
Remote port	Connects an optional remote control receiver.
S-Video images	A video signal which has the luminance component and color component separated in order to provide better image quality. It refers to images which consist of two independent signals: Y (luminance signal), and C (color signal).
SDTV	An abbreviation for Standard Definition Television. It refers to standard television systems which do not satisfy the conditions for High-Definition Television.
Security lock	A device consisting of a protector case with a hole in it that a commercially-available theft-prevention cable can be passed through in order to secure the device to a table or pillar. This projector is compatible with the Microsaver Security System manufactured by Kensington.
Source prompt	The screen display showing the type of signal being input.
sRGB	An international standard for color intervals that was formulated so that colors which are reproduced by video equipment can be handled easily by computer operating systems (OS) and the Internet.
SVGA	A type of video signal with a resolution of 800 (horizontal) x 600 (vertical) dots which is used by IBM PC/AT-compatible computers (DOS/V computers).
SXGA	A type of video signal with a resolution of 1,280 (horizontal) x 1,024 (vertical) dots which is used by IBM PC/AT-compatible computers (DOS/V computers).
Synchronization (Sync.)	The signals output from computers have a specific frequency. If the projector frequency does not match this frequency, the resulting images will not be of a good quality. The process of matching the phases of these signals (the relative position of the crests and troughs in the signal) is called "synchronization". If the signals are not synchronized, problems such as flickering, blurriness and horizontal interference can occur.
Tracking	The signals output from computers have a specific frequency. If the projector frequency does not match this frequency, the resulting images will not be of a good quality. The process of matching the frequency of these signals (the number of crests in the signal) is called "tracking". If tracking is not carried out correctly, wide vertical stripes will appear in the projected images.
USB	An abbreviation for Universal Serial Bus. USB is an interface for connecting personal computers to peripheral devices which only support relatively low data transmission speeds.
UXGA	A type of video signal with a resolution of 1,600 (horizontal) x 1,200 (vertical) dots which is used by IBM PC/AT-compatible computers (DOS/V computers).
VGA	A type of video signal with a resolution of 640 (horizontal) x 480 (vertical) dots which is used by IBM PC/AT-compatible computers (DOS/V computers).
XGA	A type of video signal with a resolution of 1,024 (horizontal) x 768 (vertical) dots which is used by IBM PC/AT-compatible computers (DOS/V computers).
YCbCr	The carrier signal which is contained in the color bar signal used in modern TV transmissions (NTSC format). The name comes from the Y (luminance) signal and the CbCr (chroma [color]) signals.
YPbPr	The carrier signal which is contained in the color bar signal used in high-definition TV (HDTV) transmissions. The name comes from the Y (luminance) signal and the PbPr (color difference) signals.

List of ESC/VP21 Commands

Command List

When a power ON command is sent to the projector, the power for the projector turns on. When the projector is in a command ready state, it returns the '3Ah' (:) code. Furthermore, when command processing is complete, the projector also returns a ":" code.

The ":" code status can be used to determine whether the projector is ready or busy. If command processing terminates with an error, an error message is output and then the ":" code is sent.

	Item	Command
Power ON/OFF	ON	PWR ON
	OFF	PWR OFF
Signal selection	Computer1 (Analog-RGB)	SOURCE 11
	Computer1 (Digital-RGB)	SOURCE 12
	Computer1 (RGB-Video)	SOURCE 13
	Computer2/Component Video (Analog-RGB)	SOURCE 21
	Computer2/Component Video (RGB-Video)	SOURCE 22
	Computer2/Component Video (YCbCr)	SOURCE 23
	Computer2/Component Video (YPbPr)	SOURCE 24
	Video	SOURCE 41
	S-Video	SOURCE 42
A/V Mute ON/OFF	ON	MUTE ON
	OFF	MUTE OFF
A/V Mute selection	Black	MSEL 00
	Blue	MSEL 01
	User's Logo	MSEL 02

Communication protocol

- Standard baud rate : 9600 bps
- Data length : 8 bits
- Parity : None
- Stop bit : 1 bit
- Flow control : Xon/Xoff

USB Connection Setup

This projector is controlled by ESC/VP21 commands, so if using a USB cable to connect the projector to a computer, you must carry out the following preparations beforehand.

Procedure

1 Download the "EMP Link21L" utility software from the EPSON website.

For details on acquiring the software, please contact one of the service offices listed in the catalog.

2 The USB driver will be downloaded at the same time. Install this USB driver to the computer.

For details on installing the software, refer to the EMP Link21L User's Guide which was downloaded together with the software.

3 Set the "COM Port" setting in the "Advanced" menu to "USB".

Communication via a USB connection will then be possible.

Cable layouts

Serial connection

- Connector shape : D-sub 9 pin (male)
- Projector input connector : Control (RS-232C)

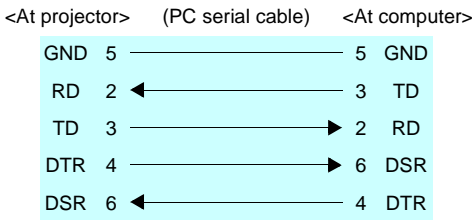
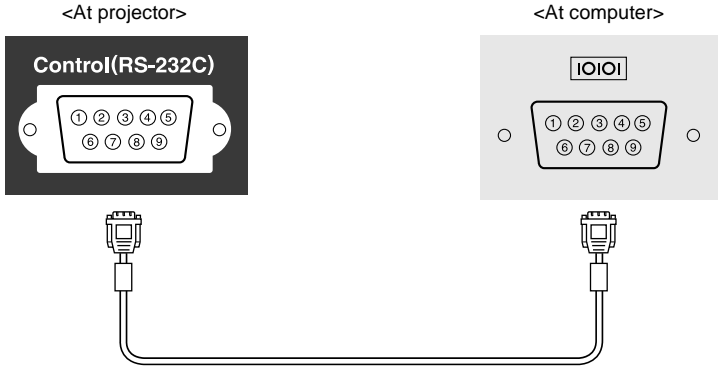

Signal	Function
GND	Signal wire ground
TD	Transmit data
RD	Receive data
DSR	Data set ready
DTR	Data terminal ready

USB connection

- Connector shape : USB (type B)

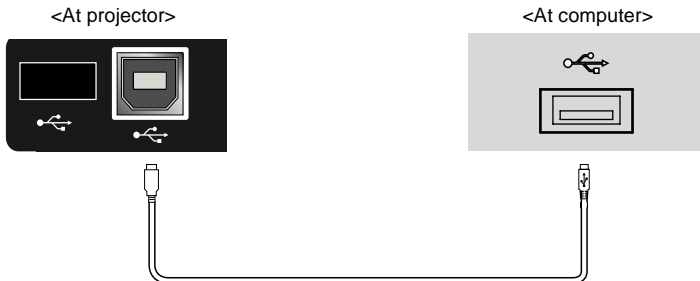

List of Supported Monitor Displays

Signal	Refresh rate▶▶ (Hz)	Resolution (dots)	Resolutions for resized display (resizing ON) (dots)		Resolutions for normal display (resizing OFF) (dots)
			EMP-820/811	EMP-600	
PC98		640x400	1024x640	800x500	640x400
EGA		640x350	1024x560	800x438	640x350
VGA	60	640x480	1024x768	800x600	640x480
VGACGA		640x400	1024x640	800x500	640x400
VGAEGA		640x350	1024x560	800x438	640x350
VGA text		720x400	1024x568	800x444	720x400
		720x350	1024x498	800x388	720x350
VESA	72/75/85/ 120,iMac*3	640x480	1024x768	800x600	640x480
SVGA	56/60/72/75/ 85/120,iMac*3	800x600	1024x768	800x600	800x600
XGA	43i/60/70/75/ 85/120,iMac*3	1024x768	1024x768	800x600	1024x768
SXGA	70/75/85/100	1152x864	1024x768	800x600	1152x864*1
SXGA	60/75/85	1280x960	1024x768	800x600	1280x960*1
SXGA	43i/60/75/85	1280x1024	960x768	750x600	1280x1024*1
SXGA+	60/75/85	1400x1050	1024x768	800x600	1400x1050*1
UXGA*2	48i/60/65/ 70/75/80/85	1600x1200	1024x768	-	1600x1200*1
MAC13"		640x480	1024x768	800x600	640x480
MAC16"		832x624	1024x768	800x600	832x624
MAC19"		1024x768	1024x768	800x600	1024x768
MAC21"		1152x870	1016x768	794x600	1152x870*1
TV(525i)	60	640x480	1024x768	800x600	640x480
TV(625i)	50	720x540	1024x768	800x600	720x540
SDTV(525p)	60	640x480	1024x768	800x600	640x480
HDTV(750p)	60	1280x720	1024x576	800x450	
HDTV (1125i, 1125p)	60	1920x1080	1024x576	800x450	

*1 Virtual (window) display

*2 The EMP-600 is not compatible with UXGA.

The EMP-820/811 can only handle UXGA display resolutions when the optional computer cable is being used. The accessory computer cable cannot be used for UXGA resolutions.

See "Appendix: Optional Accessories" (P.100)

*3 Connection is not possible if the equipment does not have a VGA output port.

Specifications

Product name	Multimedia projector EMP-820/811/600		
Model	EMP-810UG/800UG/600		
Dimensions	348 (W) x 104 (H) x 274 (D) mm (13.7 (W) x 4.1 (H) x 10.8 (D) inches) (not including feet)		
Panel size	0.9 inches		
Display method	Polysilicon TFT active matrix		
Drive method	Full-line 12-phase block sequential writing		
Resolution	EMP-820/811 : XGA 786,432 pixels (1024 (W) x 768 (H) dots) x 3 EMP-600 : SVGA 480,000 pixels (800 (W) x 600 (H) dots) x 3		
Focus adjustment	Manual		
Zoom adjustment	Manual (approx. 1:1.35)		
Lamp (light source)	UHE lamp, 200 W, Model No.: ELPLP15		
Max. audio output	5W monaural		
Speaker	1		
Power supply	100 – 120 VAC, 3.1A 200 – 240 VAC, 1.5A 50/60 Hz		
Operating temperature	+5°C – +35°C (41°F – 95°F) (No condensation)		
Storage temperature	-10°C – +60°C (14°F – 140°F) (No condensation)		
Weight	Approx. 4.2 kg (9.3 lbs)		
Connectors	Computer 1:	1	DVI-I
	Computer 2/Component Video:	1	Mini D-Sub 15-pin (female)
	Audio 1:	1	Stereo mini jack
	Audio Out:	1	Stereo mini jack
	Video:	1	RCA pin jack
	S-Video:	1	Mini DIN 4-pin
	Audio 2:	1	RCA pin jack x 2 (L, R)
	Mouse:	1	DIN jack 9-pin
	USB:	2	USB connectors (A/B series)
	Control (RS-232C):	1	D-Sub 9-pin (male)
	Monitor Out:	1	Mini D-Sub 15-pin (female)
	Remote:	1	Stereo mini jack

*The USB connector is not guaranteed to operate correctly with all USB-compatible devices.

Safety

USA

UL1950 3rd Edition

Canada

CSA C22.2 No.950 -95 (cUL)

European Community

The Low Voltage Directive (73/23/EEC)

IEC60950 2nd Edition, +Amd.1, +Amd.2, +Amd.3, +Amd.4

EMC

USA

FCC 47CFR Part15B Class B (DoC)

Canada

ICES-003 Class B

European Community

The EMC Directive (89/336/EEC)

EN55022, 1998 Class B

EN55024, 1998

IEC61000-4-2, IEC61000-4-3, IEC61000-4-4, IEC61000-4-5,

IEC61000-4-6, IEC61000-4-8, IEC61000-4-11,

IEC61000-3-2, IEC61000-3-3

Australia/New Zealand

AS/NZS 3548:1995, A1:1997, A2:1997 Class B

CISPR Pub.22:1993, A1:1995, A2:1996, Class B

Appearance

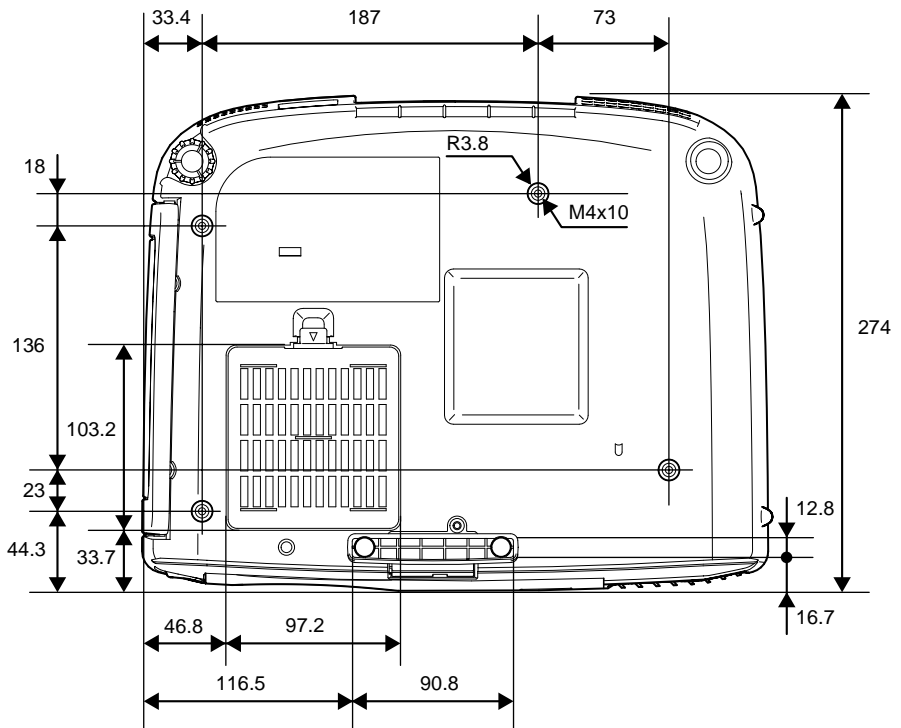
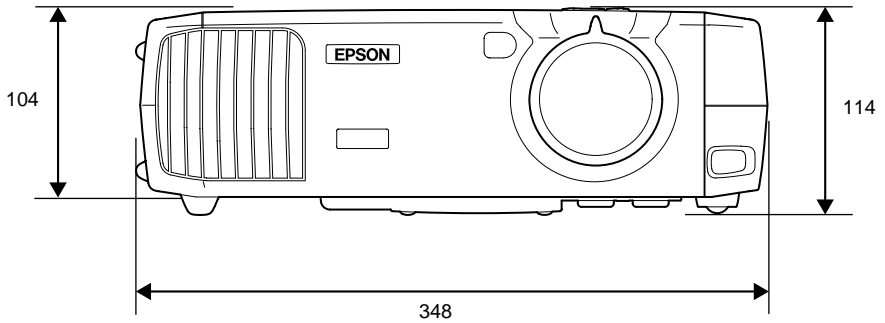

Units: mm

Buttons

- ⊞ (Enter) button 12
- [↑], [↓] buttons 12, 26
- [1]/[2]/[3] (Effect) buttons 12, 58
- [Auto] button 9, 12, 46
- [A/V Mute] button 9, 12, 53
- [Comp1] button 12, 38
- [Comp2/YCbCr] button 12, 38
- [Computer/YCbCr] button 9, 38
- [Esc] button 9, 12
- [E-Zoom] button 12, 56, 60
- [Freeze] button 12, 54
- [Help] button 9, 12, 78
- [Keystone] button 9, 44
- [Left] button 12, 27
- [Menu] button 9, 12, 75
- [P in P] button 12, 60
- [Power] button 9, 12, 37
- [Preset] button 12
- [Resize] button 9, 12, 41, 55
- [Right]/[Esc] button 12, 27
- [Shift] button 9, 47, 48, 55
- [S-Video] button 12, 38
- [Source] button 12
- [Sync] button 9, 48, 75, 78
- [Tracking] button 9, 47, 76
- [Video] button 9, 38
- [Volume] button 9, 12, 49

General Terms

- 13w3 cable 23
- 13w3 connector 23
- 5BNC connector 22

A

- A/V cable 1, 24, 29, 30, 31, 32
- A/V mute function 52, 70, 101
- About menu 73
- Advanced menu 72
- Air filter 11
- Air filter cleaning 92
- Air filter replacement 97
- Air inlet 11
- Analog-RGB 38, 62, 73
- Aspect ratio 55, 101
- Audio input 67
- Audio menu 67
- Audio Out connector 10, 34, 107
- Audio1 connector 10, 24, 107
- Audio2 connector 10, 24, 107
- Automatic adjustment 46

B

- Bar 58, 68
- Bass 67
- Battery compartment cover 13
- Brightness 63, 65

C

- Ceiling 16, 17, 72
- Check sheet Separate
- Cleaning 91
- Color 65
- Color adjustment 75

Color mode 63, 66
 Color temperature 73, 102
 COM port 72
 Comp1 input 70
 Comp2/YCbCr input 70
 Component video 31, 101
 Composite video 29, 101
 Computer connections 19
 Computer1 connector
 10, 20, 21, 38, 107
 Computer2/Component Video connector
 10, 38, 107
 Connectors 38, 107
 Contrast 63, 65, 101
 Control (RS-232C) connector 10, 107
 Control panel 9
 Cool-down 39, 83, 101
 Cross 56

D

DFP 21, 101
 Digital video cable 100
 Digital-RGB 38, 63, 73
 DVI 21, 101
 DVI analog cable 20, 32

E

E-Zoom function 56
 Effect menu 68
 Effects 58
 Eligible computers 19
 Exhaust vent 8
 External monitor 28
 External speakers 34, 49

F

Focus 46

Focus ring 8, 46
 Foot adjust button 8
 Foot adjustment 42
 Freeze function 54
 Frequency 73
 Front adjustable foot 8, 11, 42

G

Glossary 101

H

Handle 8
 HDTV 55, 101
 Help function 78
 Horizontal keystone 44, 69

I

Image adjustment 46
 Image size 41
 Indicators 8, 12, 83
 Input signal 73
 Inserting batteries 13
 Installation 16

K

Keystone correction 44

L

Lamp 73, 74
 Lamp cover 8, 94
 Lamp cover opening switch 8, 94
 Lamp indicator 8, 80
 Lamp replacement 93
 Lamp replacement period 93
 Lamp resetting 73, 74, 96
 Language 72

Lens cleaning 92
Lens cover 8
List of Functions 52, 62

M

Main menu 62
Menu functions 62
Menu operations 75
Menus 62
Mini D-Sub 15-pin connector 20
Monitor out connector 10, 28, 107
Mouse connection 25
Mouse connector 10, 25, 107
Mouse pointer 25

N

No-Signal 70
Noise reduction 66

O

Operating temperature 107
Operation indicator 8, 80
Optional accessories 100
Overheating 81

P

P in P function 60, 70
Part Names and Functions 8
Picture in Picture 60, 70
Pointer 59, 68
Pointer Speed 68
Position 55, 63, 65
Power cord 1, 36
Power inlet 10, 36
Preset 63
Projection 16, 37

Projection angle 42
Projection distance 18
Prompt 70
PS/2 mouse 25
PS/2 mouse cable 1, 25

R

R/C switch 12, 14
Rear adjustable foot 10, 11
Rear Proj. 72
Refresh Rate 73, 102
Remote connector 10, 102, 107
Remote control 12, 13, 14, 25
Remote control transmitter 12, 14
Remote operating distance 14
Remote operating range 14
Remote control receiver 8, 10, 14
Reset All menu 74
Resized display 41, 106
Resolution 63, 73, 106
RGB settings 72
RGB video 32, 38, 65, 73

S

S-Video 30, 65, 74, 102
S-Video connector 10, 30, 38, 107
Safety Instructions Separate
Screen size 18
SDTV 55
Security lock 8, 102
Setting menu 69
Sharpness 63, 65
Sleep mode 70
Speaker 10, 24, 35
Specifications 107
Spotlight 58, 68

sRGB 63, 66
Stamp 58, 68
Startup screen 72
Storage temperature 107
Sub-menu 62
Supported displays 106
Suspension bracket fixing point 11
SYNC Mode 73
SYNC Polarity 73
Sync, 48, 63, 102
Synchronization 48, 63, 102

T

Temperature indicator 8, 80
Tint 65
Tracking 47, 63, 102
Treble 67
Troubleshooting 78
Turning off 39

U

USB cable 1, 24, 25
USB connector 10, 24, 25, 107
USB mouse 25
User's Logo menu 71
User's Logo saving 98

V

Vertical keystone 44, 69
Video 65, 75
Video connector 10, 29, 38, 107
Video menu 62
Video Signal 66, 74
Video Source 73, 74
Video source connection 29
Volume 49, 67

W

Warranty Separate
When Having Some Trouble 80
Wide-screen 55
Window display 41
Wireless mouse 25, 26
Workstation 23, 100
World-wide Warranty Terms Separate

Y

YCbCr 38, 65, 73, 102
YPbPr 38, 65, 73, 102

Z

Zoom ring 8, 41

DECLARATION of CONFORMITY

According to 47CFR, Part 2 and 15
Class B Personal Computers and Peripherals; and/or
CPU Boards and Power Supplies used with Class B
Personal Computers

We :EPSON AMERICA, INC.
Located at :3840 Kilroy Airport Way
MS: 3-13
Long Beach, CA 90806
Tel :562-290-5254

Declare under sole responsibility that the product identified herein, complies with 47CFR Part 2 and 15 of the FCC rules as a Class B digital device. Each product marketed, is identical to the representative unit tested and found to be compliant with the standards. Records maintained continue to reflect the equipment being produced can be expected to be within the variation accepted, due to quantity production and testing on a statistical basis as required by 47CFR 2.909. Operation is subject to the following two conditions : (1) this device may not cause harmful interference, and (2) this device must accept any interference received, including interference that may cause undesired operation.

Trade Name :EPSON
Type of Product :Projector
Model :EMP-810UG / ELP-810UG
EMP-800UG / ELP-800UG
EMP-600 / ELP-600
EMP-820 / ELP-820
EMP-811 / ELP-811

FCC Compliance Statement For United States Users

This equipment has been tested and found to comply with the limits for a Class B digital device, pursuant to Part 15 of the FCC Rules. These limits are designed to provide reasonable protection against harmful interference in a residential installation. This equipment generates, uses, and can radiate radio frequency energy and, if not installed and used in accordance with the instructions, may cause harmful interference to radio or television reception. However, there is no guarantee that interference will not occur in a particular installation. If this equipment does cause interference to radio and television reception, which can be determined by turning the equipment off and on, the user is encouraged to try to correct the interference by one or more of the following measures.

- Reorient or relocate the receiving antenna.
- Increase the separation between the equipment and receiver.
- Connect the equipment into an outlet on a circuit different from that to which the receiver is connected.
- Consult the dealer or an experienced radio/TV technician for help.

WARNING

The connection of a non-shielded equipment interface cable to this equipment will invalidate the FCC Certification or Declaration of this device and may cause interference levels which exceed the limits established by the FCC for this equipment. It is the responsibility of the user to obtain and use a shielded equipment interface cable with this device. If this equipment has more than one interface connector, do not leave cables connected to unused interfaces. Changes or modifications not expressly approved by the manufacturer could void the user's authority to operate the equipment.

All rights reserved. No part of this publication may be reproduced, stored in a retrieval system, or transmitted in any form or by any means, electronic, mechanical, photocopying, recording, or otherwise, without the prior written permission of SEIKO EPSON CORPORATION. No patent liability is assumed with respect to the use of the information contained herein. Neither is any liability assumed for damages resulting from the use of the information contained herein.

Neither SEIKO EPSON CORPORATION nor its affiliates shall be liable to the purchaser of this product or third parties for damages, losses, costs, or expenses incurred by purchaser or third parties as a result of: accident, misuse, or abuse of this product or unauthorized modifications, repairs, or alterations to this product, or (excluding the U.S.) failure to strictly comply with SEIKO EPSON CORPORATION's operating and maintenance instructions.

SEIKO EPSON CORPORATION shall not be liable against any damages or problems arising from the use of any options or any consumable products other than those designated as Original EPSON Products or EPSON Approved Products by SEIKO EPSON CORPORATION.

EPSON is a registered trademark and PowerLite is a trademark of SEIKO EPSON CORPORATION.

General Notice: The following trademarks and registered trademarks are the property of their respective owners and are used in this publication for identification purposes only.

- EPSON/Seiko Epson Corp.
- Macintosh, PowerBook/Apple Computer Inc.
- IBM/International Business Machine Corp.
- Windows/Microsoft Corp.

Other product names used herein are also for identification purposes only and may be trademarks of their respective owners. EPSON disclaims any and all rights in those marks.

EPSON®



Printed on 100% recycled paper.



Printed in Japan
402520600
02.03-.4A(C05)