

User's Guide

Multimedia Projector

EB-460i

EB-460

EB-450Wi



EB-450W

EB-440W





Notations Used in This Guide

- **Safety indications**

The documentation and the projector use graphical symbols to show how to use the projector safely. Please understand and respect these caution symbols in order to avoid injury to persons or property.

 Warning	This symbol indicates information that, if ignored, could possibly result in personal injury or even death due to incorrect handling.
 Caution	This symbol indicates information that, if ignored, could possibly result in personal injury or physical damage due to incorrect handling.

- **General information indications**

Attention	Indicates procedures which may result in damage or injury if sufficient care is not taken.
	Indicates additional information and points which may be useful to know regarding a topic.
	Indicates a page where detailed information regarding a topic can be found.
	Indicates that an explanation of the underlined word or words in front of this symbol appears in the glossary of terms. See the "Glossary" section of the "Appendix".  p.131
Procedure	Indicates operating methods and the order of operations. The procedure indicated should be carried out in the order of the numbered steps.
[(Name)]	Indicates the name of the buttons on the Remote Control or the Control panel. Example: [Esc] button
"(Menu Name)" Brightness	Indicates Configuration Menu items. Example: Select "Brightness" from the Image menu. Image menu - Brightness



Notations Used in This Guide 2

Introduction

Projector Features 7

- Convenient Equipment Designed for Ease of Use 7
 - Easy to handle 7
 - Enhanced security functions 7
- Controlling Computer on Projection Surface (EB-460i/450Wi Only) 8
 - Easy Interactive Function 8
 - Drawing function 8
- Selecting Various Input Sources with Multi-Connection 8
 - Taking full advantage of a network connection 8
 - Connecting with a USB cable and projecting (USB Display) 9
 - Projecting a computer screen with the optional Quick Wireless Connection USB Key 9
 - Projecting JPEG images without connecting a computer 10
 - Enlarge and project your files with the Document Camera 10

Part Names and Functions 11

- Front/Top 11
- Sides 12
- Interfaces 13
- Base (with Slide Plate) 14
- Base (without Slide Plate) 15
- Control panel 15
- Remote Control 16
- Easy Interactive Pen(EB-460i/450Wi Only) 18

Various Ways to Use the Projector

Changing the Installation Mode 20

Changing the Projected Image 21

- Automatically Detect Input Signal and Change the Projected Image (Source Search) 21

- Switch to the target image by Remote Control 22

Connecting with a USB Cable and Projecting (USB Display) 23

- System Requirements 23
- Connecting 24
 - Connecting for the first time 24
 - From the second time 27

Presentations Using Slideshow 28

- Files that can be Projected Using Slideshow 28
 - Specifications for files that can be projected using Slideshow 28
 - Slideshow usage examples 28
- Slideshow Basic Operations 29
 - Starting and closing Slideshow 29
 - Slideshow basic operations 29
 - Rotating images 30
- Projecting Image Files 31
 - Projecting images 31
 - Projecting all image files in a folder in sequence (Slideshow) 32
- Image File Display Settings and Slideshow Operation Settings 33

Connecting External Equipment 34

- Connecting and Removing USB Devices 34
 - Connecting USB devices 34
 - Removing USB devices 34
- Connecting an External Monitor 35
- Connecting External Speakers 36
- Connecting a microphone 36

Connecting a LAN Cable 37

Installing the Wireless LAN Unit 38

Functions for Enhancing Projection 39

- Selecting the Projection Quality (Selecting Color Mode) 39
- Setting the Auto Iris 40
- Hiding the Image and Sound Temporarily (A/V Mute) 40
- Freezing the Image (Freeze) 41
- Changing the Aspect Ratio 41

- Changing methods 41
- Changing the aspect ratio for video equipment images 42
- Changing the aspect ratio for computer images (EB-460i/460) 43
- Changing the aspect ratio for computer images (EB-450Wi/450W/440W) 44
- Using the Pointer to Highlight Sections (Pointer) 46
- Enlarging Part of the Image (E-Zoom) 47
- Operating the Mouse Pointer by Remote Control (Wireless Mouse) 48

Security Functions 50

- Managing Users (Password Protect) 50
 - Type of Password Protect 50
 - Setting Password Protect 50
 - Entering the Password 51
- Restricting Operation (Control Panel Lock) 52
- Anti-Theft Lock 53
 - Installing the wire lock 53

Easy Interactive Function (EB-460i/450Wi only) 54

- Summary of Easy Interactive Function 54
- Operation Steps 55
 - Using Easy Interactive Function for the first time 55
 - From the second time 55
- System Requirements 55
- Using Easy Interactive Function for the First Time 56
- Using Easy Interactive Function from the Second Time 59
- Calibration 61
 - Cases in which calibration is required 61
- Replacing the Batteries for the Easy Interactive Pen 61

Changing Settings Using a Web Browser (Web Control) 63

- Displaying Web Control 63
 - Entering the IP address of the projector 63
- Displaying Web Remote 64

Using the Mail Notification Function to Report Problems 66

Management Using SNMP 67

Saving a User's Logo 68

Saving User Pattern 70

Configuration Menu

Using the Configuration Menu 73

List of Functions 74

- Image Menu 74
- Signal Menu 75
- Settings Menu 76
- Extended Menu 78
- Network Menu 80
 - Notes on using the Network menu 81
 - Soft keyboard operations 81
 - Basic Menu 82
 - Wireless LAN Menu 83
 - Security menu 84
 - When WEP is selected 85
 - When WPA-PSK (TKIP) or WPA2-PSK (AES) is selected 85
 - Wired LAN menu 86
 - Mail menu 87
 - Others Menu 88
 - Reset Menu 89
- Info Menu (Display Only) 90
- Reset Menu 91

Troubleshooting

Using the Help	93
Problem Solving	94
Reading the Indicators	94
⏻ indicator is lit or flashing red	95
🔊 indicator is flashing or lit orange	96
When the Indicators Provide No Help	97
Problems relating to images	98
Problems when projection starts	102
Problems relating to monitoring and control	102
Problems relating to Easy Interactive Function	103
Other problems	104
Reading Error Notification Mail	106

Appendix

Cleaning Parts	108
Cleaning the Projector's Surface	108
Cleaning the Projection Window	108
Cleaning the Air Filter	108
Replacing Consumables	110
Replacing the Remote Control Batteries	110
Replacing the Lamp	111
Lamp replacement period	111
How to replace the Lamp	111
Resetting the Lamp Hours	114
Replacing the Air Filter	114
Air filter replacement period	114
How to replace the air filter	114
Optional Accessories and Consumables	116
Optional accessories	116
Consumables	116

Screen Size and Projection Distance 117

Projection Distance (EB-460i/460)	117
Projection Distance (EB-450Wi/450W/440W)	117

List of Supported Resolutions 119

Supported Monitor Displays (EB-460i/460)	119
Computer signals (analog RGB)	119
Component Video	119
Composite Video/S-Video	119
Supported Monitor Displays (EB-450Wi/450W/440W)	119
Computer signals (analog RGB)	119
Component Video	120
Composite Video/S-Video	120

ESC/VP21 Commands 121

Command List	121
Cable Layouts	122
Serial Connection	122
Communications protocol	122

About PJLink 123

Specifications 124

Projector General Specifications	124
--	-----

Appearance 129

Glossary 131

General Notes 133

Wireless Telegraphy Act Regulations	133
About Notations	133
General Notice	133

Index 151



Introduction

This chapter explains the projector's features and the part names.

Convenient Equipment Designed for Ease of Use

Easy to handle

- **Easy wall mounting**

The projector is supplied with a dedicated slide plate that makes troublesome wall mounting easy.

The slide plate is integrated into the projector main unit, so mounting is easy and installation time has been reduced compared to previous models.

☛ [Installation Guide](#)

You can also perform maintenance such as replacing the air filter and lamp simply while projector is mounted to a wall.

- **No special screen required**

Installation in a wide range of places is possible because you can project images onto a projection surface such as a wall if there is no projector screen.

- **Short distance projection**

At 47 cm, the recommended shortest projection distance allows you to place the projector close to the screen. ☛ [p.117](#)

If you mount the projector to a wall and project images from diagonally above, you can give your presentation without the shadow of anybody who stands up near the projection surface appearing in the images.

Furthermore, when your back is facing the screen, the projector light does not dazzle you because it does not interfere with your field of view.

- **Direct power on/off**

In places where power is managed centrally, such as in a conference room, you can set the projector to turn on or off when the main power source to which the projector is connected is switched on or off.

- **Display of projection lines on the projection surface**

The pattern function for projecting ruled lines or a grid enables effective use of the projection surface in lessons and presentations.

- **Speaker**

The incorporation of a high-output 10 W speaker enables your voice to reach the edges of the room even in spacious classrooms.

- **Projection screen for WXGA (EB-450Wi/450W/440W only)**

With a computer that has a 16:10 WXGA wide LCD display, the image can be projected in the same aspect. This allows you to effectively use the width of whiteboards and other landscape-oriented projection surfaces.

- **Control the projector from a computer**

You can use the Web Control function and Web Remote function to perform the same operations on a computer as with the projector's control panel or remote control. ☛ [p.63](#)

Enhanced security functions

- **Password Protect to restrict and manage users**

By setting a Password you can restrict who can use the projector.

☛ [p.50](#)

- **Control Panel Lock restricts button operation on the Control panel**

You can use this to prevent people changing projector settings without permission at events, in schools, and so on. ☛ [p.52](#)

- **Equipped with anti-theft security devices**

The projector is equipped with the following types of anti-theft security functions. ☛ [p.53](#)

- Security slot
- Security cable installation point

Controlling Computer on Projection Surface (EB-460i/450Wi Only)

Easy Interactive Function

By simply connecting a computer to the projector, you can control the computer on the projection screen and give an effective, interactive presentation or lesson.  [p.54](#)

Drawing function

You can use a graphics application to import text and diagrams have been hand-drawn on the projection surface with an electronic pen (Easy Interactive Pen). This combines the functions of a whiteboard and screen without the need for either.  [p.54](#)

Selecting Various Input Sources with Multi-Connection

As well as connecting a computer cable, you can select various interfaces such as a USB cable, USB memory, or LAN connection. This allows you to select from a range of input sources to match your usage environment.

Taking full advantage of a network connection

You can make effective use of your network by using the supplied "EPSON Projector Software for Meeting & Monitoring" to perform efficient and varied presentations and meetings.  [EasyMP Network Projection Operation Guide](#)

- **Connect a Computer to the projector via a network**

You can project by connecting to an already constructed network system. You can hold efficient meetings by projecting from multiple computers connected to a network system without having to change any cables.

- **Connecting wirelessly to a computer**

When you install the optional wireless LAN unit in the projector, you can connect wirelessly to a computer.  [p.38](#)

- **Connection method for various networks**

The following methods are available for connecting the projector to a network. Select whichever method suits your environment.  [EasyMP Network Projection Operation Guide](#)

- **Advanced Connection Mode**

Advanced Connection Mode is an infrastructure connection, offering you a method of connecting to an already constructed network.

- **Quick Connection Mode**

Quick Connection Mode is a connection method that can only be executed when the optional wireless LAN unit is installed.

Quick Connection Mode temporarily allocates the projector's SSID to the computer and makes an ad-hoc connection, and then restores the computer's network settings after disconnecting.

Connecting with a USB cable and projecting (USB Display)

By simply connecting the supplied USB cable to a computer, you can project images from the computer's screen.

 [Quick Start Guide](#) , p.23

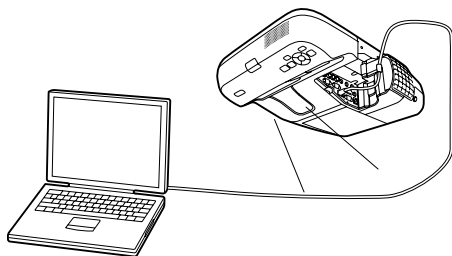

Projecting a computer screen with the optional Quick Wireless Connection USB Key

Using the optional Quick Wireless Connection USB Key, you can quickly connect a computer to the projector for projection.

With the Quick Wireless Connection USB Key, you can connect to a projector on a network even if EasyMP Network Projection is not installed.

For example, you can connect under the following environments.

- Connect in Quick Connection Mode using the optional Wireless LAN unit.

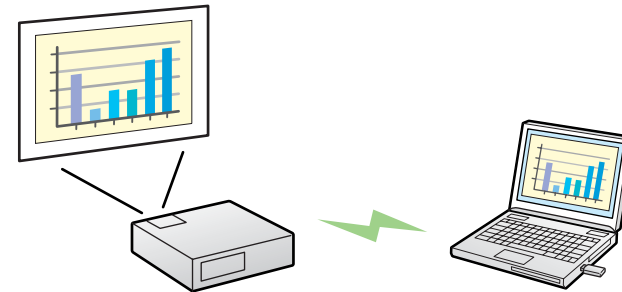

- Connect to the network via an access point.

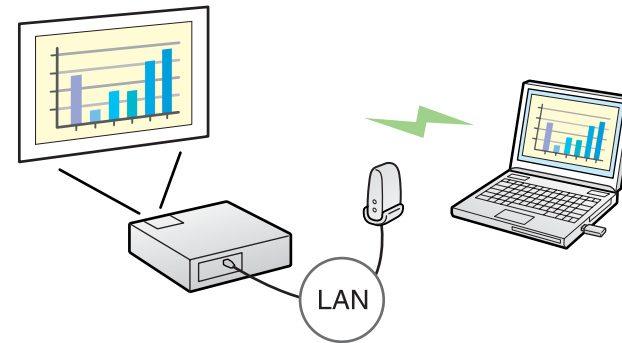

- Connect to the network via a wired LAN connection.

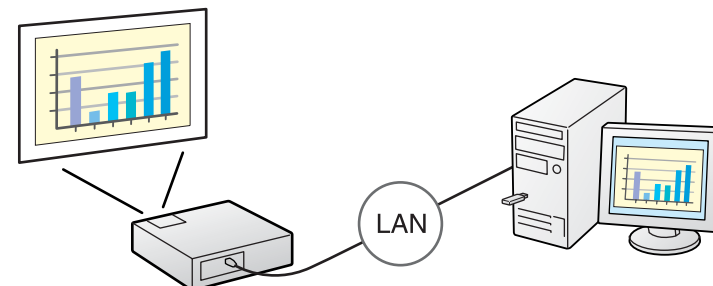

☛ p.116



- This projector is not compatible with the Network Projector function which is a standard feature in Windows Vista and Windows 7.
- Limitations when projecting from Windows Media Center
When Windows Media Center is in full-screen mode, images cannot be projected. Switch to the window display mode to project the images.

Projecting JPEG images without connecting a computer

You can project a slideshow of JPEG images saved on a USB device such as a USB compatible digital camera, hard disk, or USB memory by simply connecting to the projector. ☛ p.28

Enlarge and project your files with the Document Camera

A USB compatible Document Camera is available as an optional extra. With this Document Camera there is no need for a power cable. You can connect easily with one USB cable, and its clean design really simplifies projecting and enlarging your documents. ☛ p.34

Front/Top

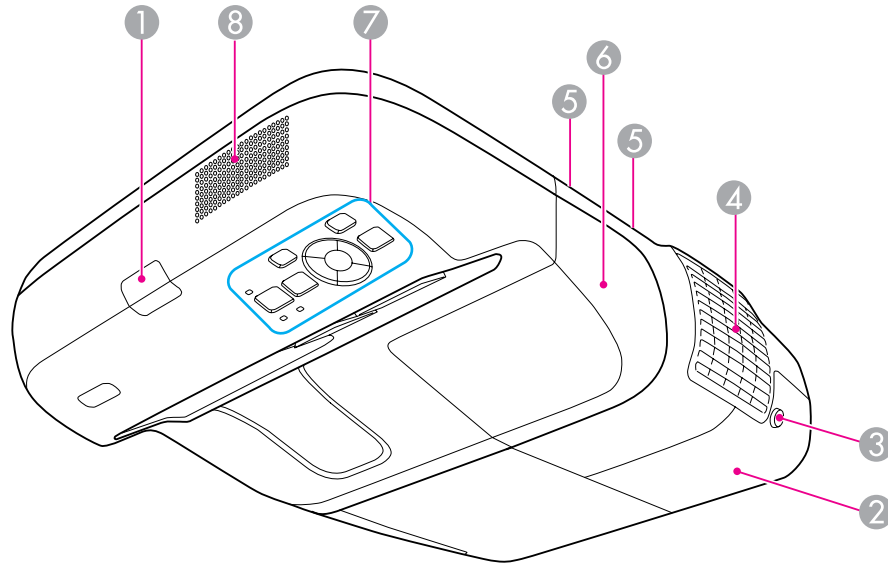







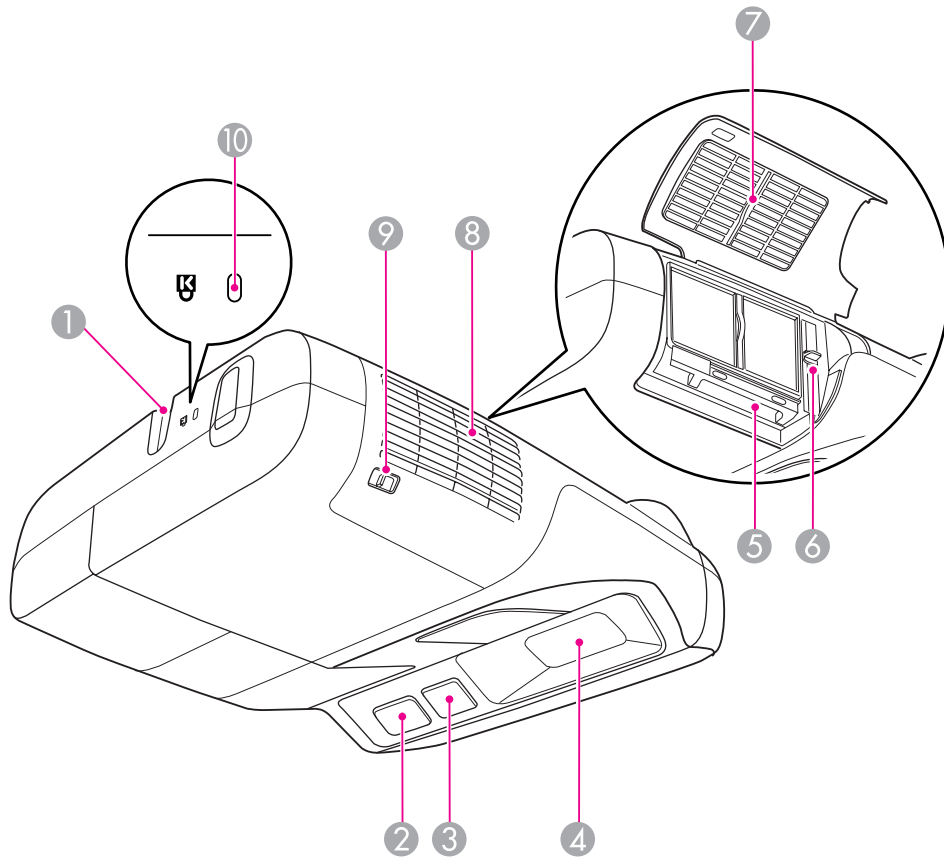



Name	Function
① Remote Receiver	Receives signals from the remote control. ☛ <i>Quick Start Guide</i>
② Lamp cover	Open this cover when replacing the projector's Lamp. ☛ p.111
③ Lamp Cover Fixing Screw	Screw to fix the Lamp cover in place. ☛ p.111
④ Air exhaust vent	Exhaust vent for air used to cool the projector internally. <div style="border: 1px solid black; padding: 5px; margin-top: 10px;"> <p>⚠ Caution</p> <p><i>Do not place anything that can become warped or damaged by heat near the air exhaust vents, or bring your hands or face close to the vents while projection is in progress.</i></p> </div>

Name	Function
⑤ Cable cover fixing screws	Screws to fix the cable cover in place. ☛ <i>Quick Start Guide</i>
⑥ Cable cover	When connecting to an input port, loosen the two screws and open this cover. ☛ <i>Quick Start Guide</i>
⑦ Control panel	Allows you to operate and check the status of the projector. ☛ p.15
⑧ Speaker	Outputs audio for images currently being projected or audio from the Microphone (Mic) input port.

Sides



Name	Function
① Security cable installation point	Pass a commercially available wire lock through here and lock it in place.  p.53
② Remote Receiver	Receives signals from the remote control.  Quick Start Guide

Name	Function
③ Easy Interactive Function receiver (EB-460i/450Wi only)	Receives signals from the Easy Interactive Pen.  p.54
④ Projection window	Projects images. <div style="border: 1px solid black; padding: 5px; margin-top: 10px;">  Warning <ul style="list-style-type: none"> Do not look at this during projection. Do not place objects on or hand nears this. Doing so is dangerous because the focus of projection light results in high temperatures. </div>
⑤ Wireless LAN unit insertion slot	Insert the optional wireless LAN unit.  p.38
⑥ Focus lever	Adjusts the image focus. Opens the air filter cover and operates the focus lever.  Quick Start Guide
⑦ Air filter cover	Open this cover when replacing the air filter or installing the optional Wireless LAN unit.
⑧ Air intake vent (Air filter)	Takes in air to cool the projector internally. If dust collects here it can cause the internal temperature to rise, and this can lead to problems with operation and shorten the optical engine's service life. Be sure to clean the Air filter regularly.  p.108 , p.114
⑨ Air filter cover open/close lever	Opens and closes the air filter cover.  p.114 Open this cover when installing the optional Wireless LAN unit.  p.38
⑩ Security slot	The Security slot is compatible with the Microsaver Security System manufactured by Kensington.  p.53



Interfaces





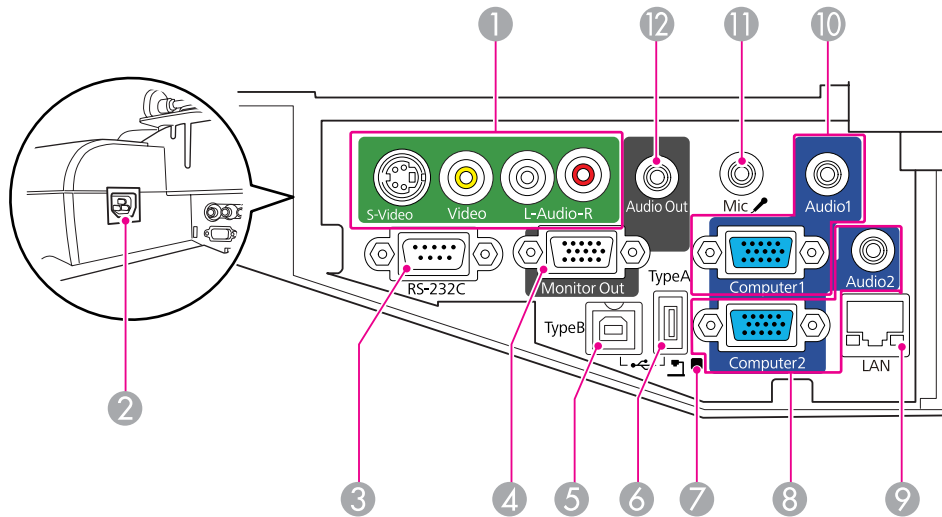

Remove the cable cover to view the following ports.

Remove the cable cover to connect equipment.

 *Quick Start Guide*



Name	Function
1 S-Video input port Video input port Audio-L/R input port	For S-video signals from video sources. For composite video signals from video sources. Connects to the audio output port to output audio from equipment connected to the S-Video input port or the Video input port.  <i>Quick Start Guide</i>
2 Power inlet	Connects to the power cable.  <i>Quick Start Guide</i>

Name	Function
3 RS-232C port	When controlling the projector from a computer, connect it to the computer with an RS-232C cable. This port is for control use and should not normally be used.  p.122
4 Monitor Output (Monitor Out) port	Outputs the image signals from the computer connected to the Computer1 input port to an external monitor. This is not available for component video signals or other signals being input to any port other than the Computer1 input port.  p.35
5 USB(TypeB) port	Connects the projector to a computer via the supplied USB cable to project images from the computer.  p.23 Also use this port to connect to a computer via the supplied USB cable to use the wireless mouse function.  p.48 Also use this port to connect to a computer via the supplied USB cable to use the Easy Interactive Function. (EB-460i/450Wi only)  p.54
6 USB(TypeA) port	Projects a JPEG image Slideshow when memories or digital cameras are connected to the USB compatible port.  p.28 Also connects to the optional Document Camera.
7 USB indicator	Notifies you of the status of the USB device connected to the USB(TypeA) port as described below. OFF: USB device is not connected Orange Light ON: USB device is connected Green Light ON: USB device is operating Red Light ON: Error

Name	Function
<p>8 Computer2 input port</p> <p>Audio2 port</p>	<p>Inputs image signals from a computer and component video signals from other video sources.</p> <p>Connects to the audio output port of equipment connected to the Computer2 input port to input audio. Also, when the input source is one of the following and you want to output audio from the projector, connect the audio source to the Audio2 port.</p> <ul style="list-style-type: none"> - USB: When playing back a slideshow from a USB storage device connected to the USB(TypeA) port, or when projecting from the optional Document Camera - USB Display - LAN <p>☛ <i>Quick Start Guide</i></p>
9 LAN port	<p>Connects to a LAN cable and then to a network.</p> <p>☛ p.37</p>
<p>10 Computer1 input port</p> <p>Audio1 port</p>	<p>Inputs image signals from a computer and component video signals from other video sources.</p> <p>Connects to the audio output port of equipment connected to the Computer1 input port to input audio.</p> <p>☛ <i>Quick Start Guide</i></p>
11 Microphone (Mic) input port	<p>Connects to a microphone. ☛ p.36</p>
12 Audio Output (Audio Out) port	<p>Outputs the audio of the images currently being projected or the audio input from the Microphone (Mic) input port to an external speaker. ☛ p.36</p>

Base (with Slide Plate)

A slide plate is attached to the projector main unit at the time of shipment.

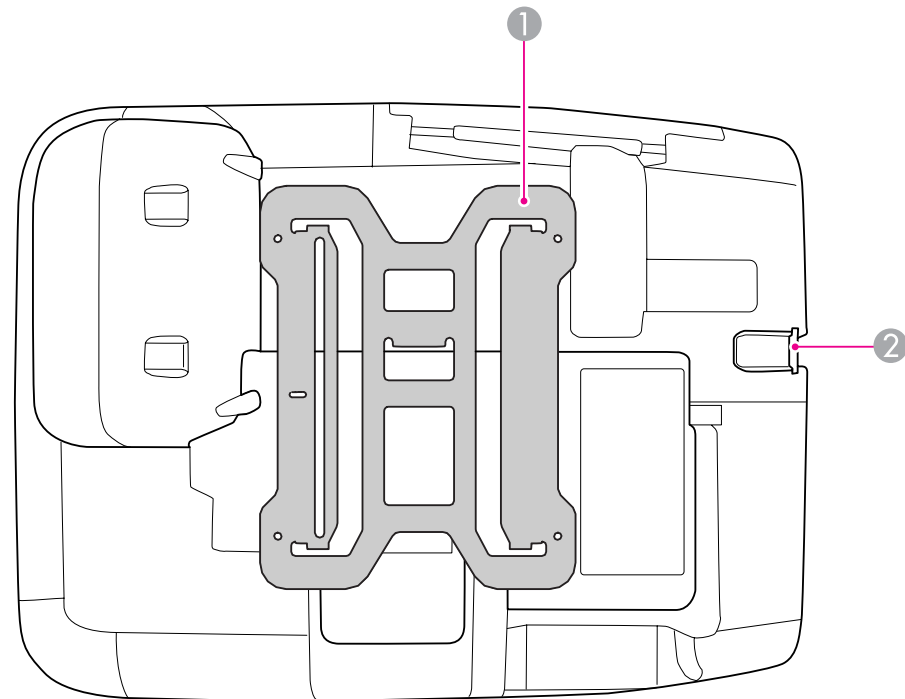

Name	Function
1 Slide plate	<p>Connect this to the setting plate when mounting the projector on a wall. ☛ <i>Installation Guide</i></p>
2 Security cable installation point	<p>Pass a commercially available wire lock through here and lock it in place. ☛ p.53</p>



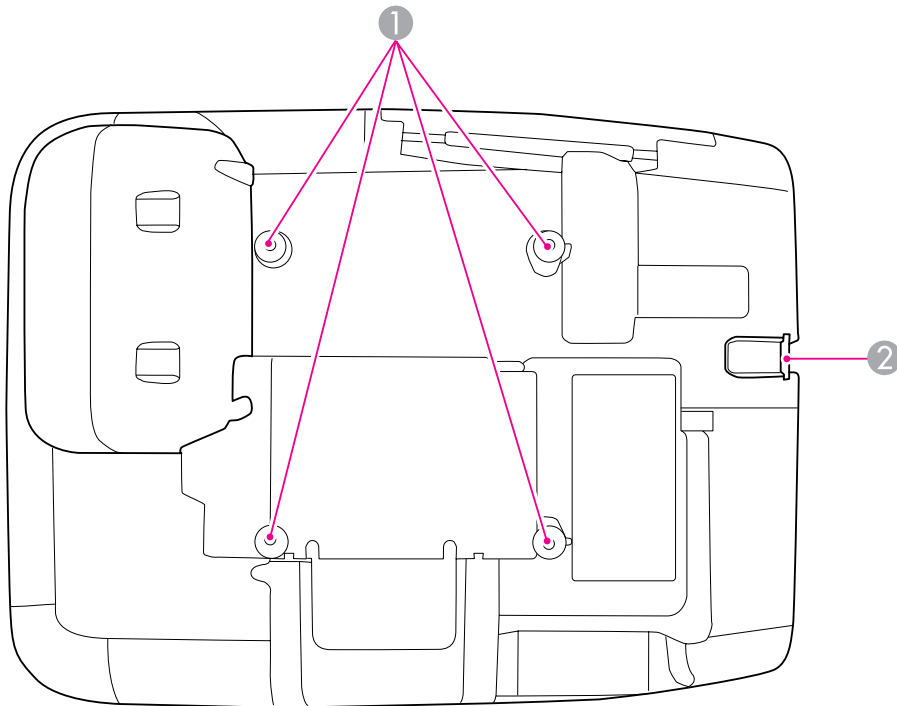

Base (without Slide Plate)

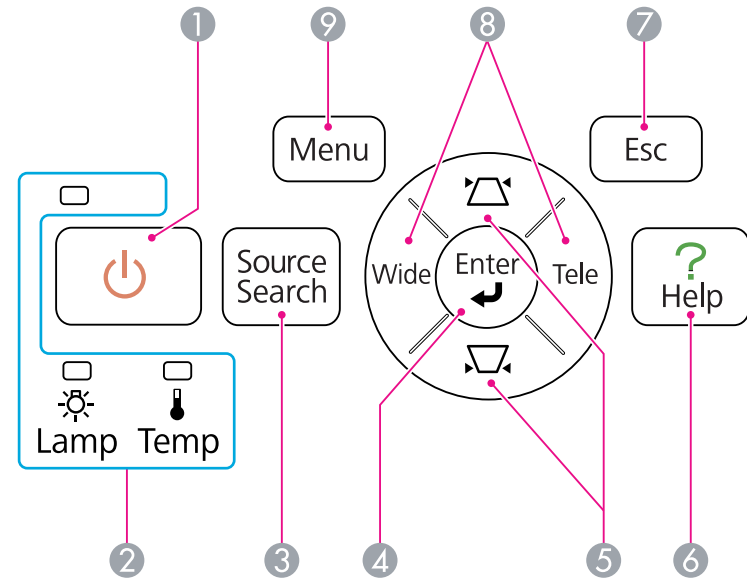

Name	Function
① Ceiling mount fixing points (four points)	Connect the ceiling mount fixing points to a commercially available ceiling mount or wall mount when mounting the projector to a ceiling or wall. For details, see the documentation supplied with the the ceiling mount or wall mount.
② Security cable installation point	Pass a commercially available wire lock through here and lock it in place.  p.53

Control panel



Name	Function
① [Power] button	Turns the projector power on or off.  Quick Start Guide
② Status indicators	The color of the indicators and whether they are flashing or lit indicate the status of the projector.  p.94
③ [Source Search] button	Changes to the next input source that is connected to the projector and is sending an image.  p.21
④ [Enter] button	If pressed during projection of a computer image signal, it automatically adjusts the Tracking-Sync., and Position to project the optimum image. When the Configuration Menu or Help screen is displayed, pressing this button confirms the current item and moves to the next level.  p.73



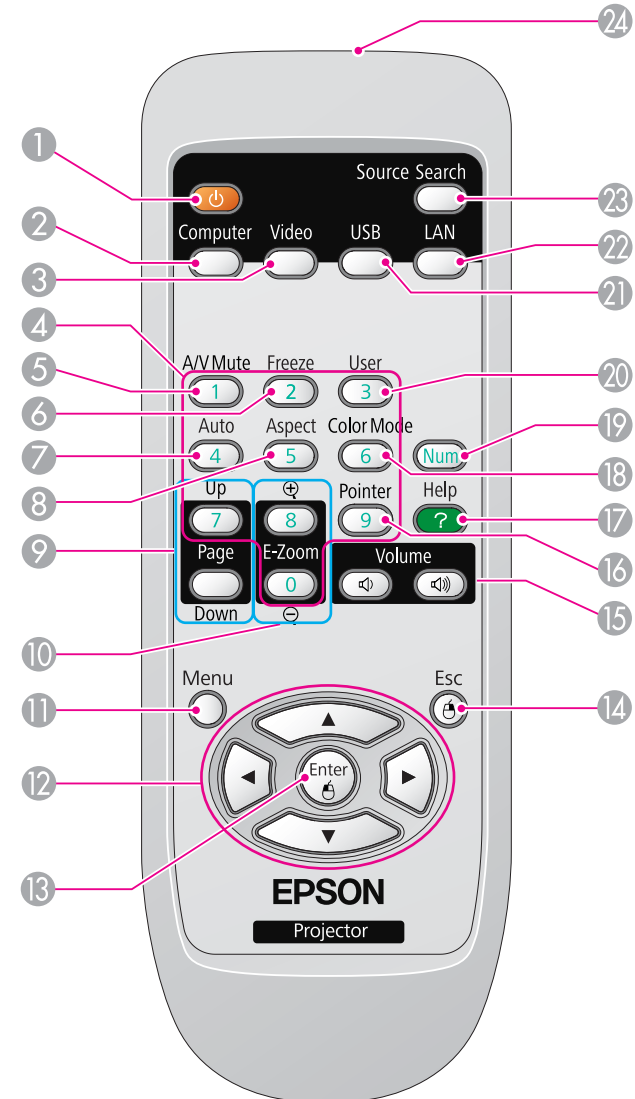

	Name	Function
5	[△][▽] buttons	<p>Corrects Keystone distortion. In the following cases, however, these buttons function as the [▲] and [▼] buttons.</p> <ul style="list-style-type: none"> - When the projected image is being sent through a Network connection - When the Slideshow function is being used for projection <p>If pressed when a Configuration Menu or Help screen is displayed, these buttons selects menu items and setting values.</p> <p>☛ <i>Quick Start Guide</i> , p.73</p>
6	[Help] button	<p>Displays and closes the Help screen which shows you how to deal with problems if they occur. ☛ p.93</p>
7	[Esc] button	<p>Stops the current function.</p> <p>When the Configuration Menu is displayed, pressing this button moves to the previous menu level. ☛ p.73</p>
8	[Wide][Tele] button	<p>Adjusts Tele/Wide. Press the [Tele] button to reduce the size of the projection screen and press the [Wide] button to increase the size of the projection screen.</p> <p>When the Configuration Menu or Help screen is displayed, these buttons function as the [◀][▶] buttons, which select menu items and setting values.</p> <p>☛ <i>Quick Start Guide</i></p>
9	[Menu] button	<p>Displays and closes the Configuration Menu.</p> <p>☛ p.73</p>

Remote Control





Name	Function
① [⏻] button	Turns the projector power on or off. ☛ <i>Quick Start Guide</i>
② [Computer] button	Each time you press the button, input changes between images from the Computer1 input port and the Computer2 input port. ☛ p.22
③ [Video] button	Each time you press the button, input changes between images from the Video input port and the S-Video input port. ☛ p.22
④ Numeric buttons	Use when entering a password. ☛ p.50
⑤ [A/V Mute] button	Turns the video and audio on or off. ☛ p.40
⑥ [Freeze] button	Images are paused or unpaused. ☛ p.41
⑦ [Auto] button	If pressed during projection of a computer image signal, it automatically adjusts the Tracking-Sync., and Position to project the optimum image.
⑧ [Aspect] button	The Aspect Ratio changes each time the button is pressed. ☛ p.41
⑨ [Page] buttons ([Up]) ([Down])	When you are using the Wireless Mouse function, USB Display function, or the input source is projecting a file of application software that supports page up/down via the LAN, you can move the page up and down by pressing these buttons. ☛ p.48
⑩ [E-Zoom] buttons (⊕)(⊖)	Enlarges or reduces the image without changing the projection size. ☛ p.47
⑪ [Menu] button	Displays and closes the Configuration Menu. ☛ p.73
⑫ [▲][▼] [◀][▶] buttons	When the Configuration Menu or Help screen is displayed, pressing these buttons selects menu items and setting values. ☛ p.73, p.93 During Wireless Mouse function, the mouse pointer moves in the direction the button is pushed. ☛ p.48

Name	Function
⑬ [Enter] button	When the Configuration Menu or Help screen is displayed, pressing this button confirms the current item and moves to the next level. ☛ p.73, p.93 Acts as a mouse's left button when using the Wireless Mouse function. ☛ p.48
⑭ [Esc] button	Stops the current function. If pressed when the Configuration Menu is displayed, it moves to the previous level. ☛ p.73, p.93 Acts as a mouse's right button when using the Wireless Mouse function. ☛ p.48
⑮ [Volume] buttons (◀) (▶)	(◀) Decreases the Volume. (▶) Increases the Volume. ☛ <i>Quick Start Guide</i>
<div style="border: 1px solid black; padding: 10px; background-color: #e0f2f1;">  <p>Caution</p> <p><i>Do not start when the volume is set too high. A sudden excessive volume may cause loss of hearing. Always lower the volume before turning the power off, and gradually increase the volume after turning the power on.</i></p> </div>	
⑯ [Pointer] button	Press this button to activate the on-screen pointer. ☛ p.46
⑰ [Help] button	Displays and closes the Help screen which shows you how to deal with problems if they occur. ☛ p.93
⑱ [Color Mode] button	Each time the button is pressed, the Color Mode changes. ☛ p.39
⑲ [Num] button	Use when entering a Password. ☛ p.50

Name	Function
20 [User] button	Select any frequently used item from the five available Configuration Menu items, and assign it to this button. By pressing the button the assigned menu item selection/adjustment screen is displayed, allowing you to make one-touch settings/adjustments.  p.76 The menu Power Consumption is assigned as the default setting.
21 [USB] button	Each time you press the button, input changes between images from the equipment connected to USB Display and USB(TypeA) port.  p.22
22 [LAN] button	Changes to the images projected with EasyMP Network Projection. When you are projecting via Quick Wireless Connection using the optional Quick Wireless Connection USB Key, pressing this button changes to that image.  p.22
23 [Search] button	Changes to the next input source that is connected to the projector and is sending an image.  p.21
24 Remote control light-emitting area	Outputs remote control signals.

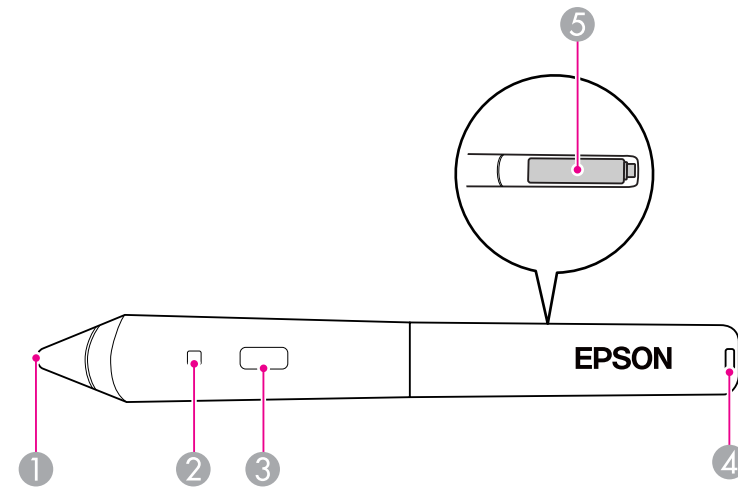
Easy Interactive Pen(EB-460i/450Wi Only)



Name	Function
1 Pen tip switch	Functions as the left button of a mouse.
2 Battery indicator	When you press the button, this indicator lights green if there is any remaining battery power. It does not light if there is not much remaining battery power. If this happens, replace the batteries.  p.61
3 Button	Functions as the right button of a mouse.
4 Strap attachment hole	You can attach a commercially available strap.
5 Battery cover	Open this cover when replacing the batteries.  p.61



Various Ways to Use the Projector

This chapter explains useful functions for giving presentations, connecting external equipment, and security functions.

The projector supports the following two different projection methods. Install according to the conditions of the installation location.

- Suspend the projector from the ceiling and project images from in front of the screen. (Front/Ceiling projection)
- Suspend the projector from the ceiling and project images from behind a translucent screen. (Rear/Ceiling projection)

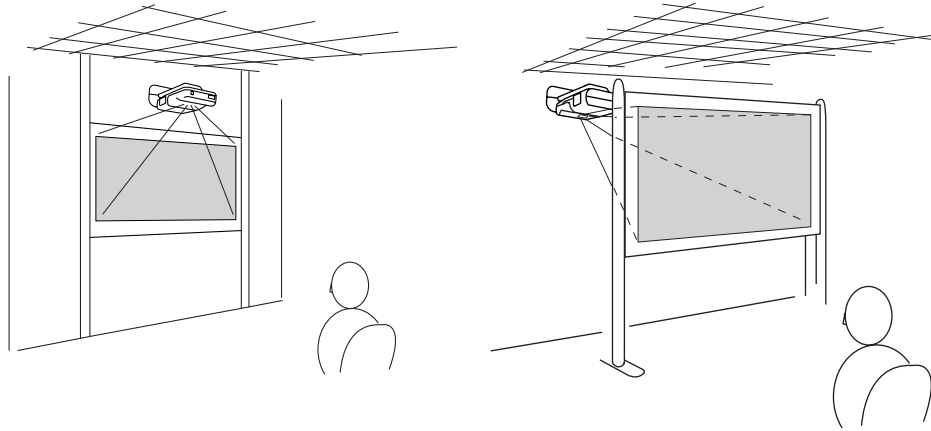

At the time of shipment, the projector is set to be installed suspended from a ceiling and to project images from the front of the screen (Front/Ceiling).



Set either **Front/Ceiling** or **Rear/Ceiling** setting from the Configuration Menu.  [p.78](#)

You can change the projected image in the following two ways.

- Changing by Source Search
The projector automatically detects signals being input from connected equipment, and the image being input from the equipment is projected.
- Changes to the target image.
You can use the Remote Control buttons to change to the target input port.

Automatically Detect Input Signal and Change the Projected Image (Source Search)

You can project the target image quickly as input ports with no image signal being input are ignored when you change by pressing the [Source Search] button.

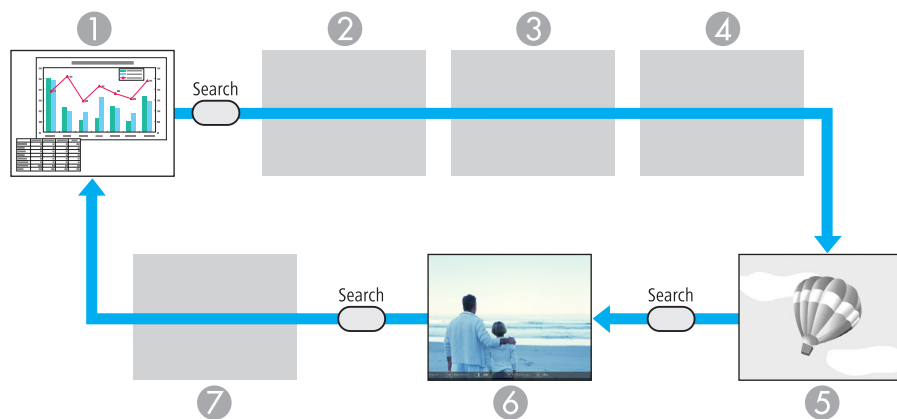

- 1 Computer1
- 2 Computer2
- 3 S-Video
- 4 Video
- 5 USB Display

- 6 USB*: When the image is from a device connected to the USB(TypeA) port.
- 7 LAN: When the projector is connected to a computer via a network, and images from EasyMP Network Projection are projected.

Skipped when no image signal is being input.

*USB input source indicates that a Slideshow is being played back from a USB storage device connected to the USB(TypeA) port, or that images are being projected from the optional Document Camera.

Procedure

When your video equipment is connected, start playback before beginning this operation.

Using the Remote Control

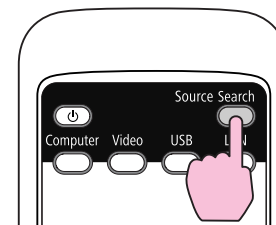

Using the Control panel

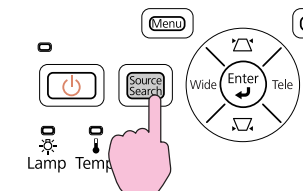

When two or more pieces of equipment are connected, press the [Source Search] button until the target image is projected.



The following screen showing the status of image signals is displayed when only the image that the projector is currently displaying is available, or when no image signal can be found. You can select the input port where the equipment you want to use is connected. If no operation is performed after about 10 seconds, the screen closes.

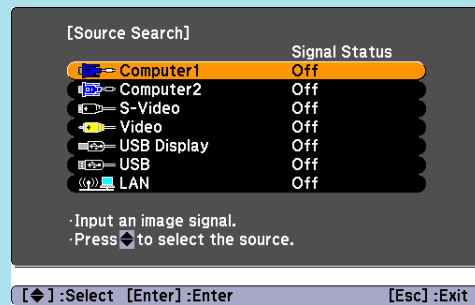

- Each time you press the button, input changes between images from the equipment connected to USB Display and USB(TypeA) port.
- Changes to the images projected with EasyMP Network Projection. When you are projecting via Quick Wireless Connection using the optional Quick Wireless Connection USB Key, this button changes to that image.

Switch to the target image by Remote Control

You can change directly to the target image by pressing the following buttons on the Remote Control.

Remote Control

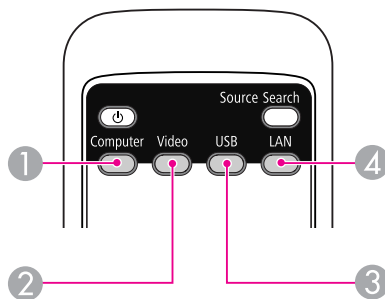

- Each time you press the button, input changes between images from the Computer1 input port and the Computer2 input port.
- Each time you press the button, input changes between images from the Video input port and the S-Video input port.

You can use the supplied USB cable to connect the projector to a computer to project images from the computer. This function is called USB Display. Simply by connecting via a USB cable, images from the computer can be displayed.

To activate the USB Display function, set USB Type B to USB Display from the Extended menu in the Configuration Menu.

The following shows the default settings for USB Type B.

- EB-460i/450Wi: Off
- EB-460/450W/440W: USB Display

For EB-460i/450Wi, the setting needs to be changed in advance.

 [p.78](#)

System Requirements

For Windows

OS	Windows 2000 Service Pack 4 Windows XP Windows XP Service Pack 2 or later Windows Vista Windows Vista Service Pack 1 or later Windows 7
CPU	Mobile Pentium III 1.2GHz or faster Recommended: Pentium M 1.6GHz or faster
Amount of Memory	256MB or more Recommended: 512MB or more
Hard Disk Free Space	20MB or more

Display	Resolution of no lower than 640x480 and no higher than 1600x1200. Display color of 16-bit color or greater
----------------	---

Only 32-bit versions are supported.

For Mac OS

OS	Mac OS X 10.5.1 or later Mac OS X 10.6.x
CPU	Power PC G4 1GHz or faster Recommended: Intel Core Duo 1.83GHz or faster
Amount of Memory	512MB or more
Hard Disk Free space	20MB or more
Display	Resolution of no lower than 640x480 and no higher than 1680x1200. Display color of 16-bit color or greater

Connecting

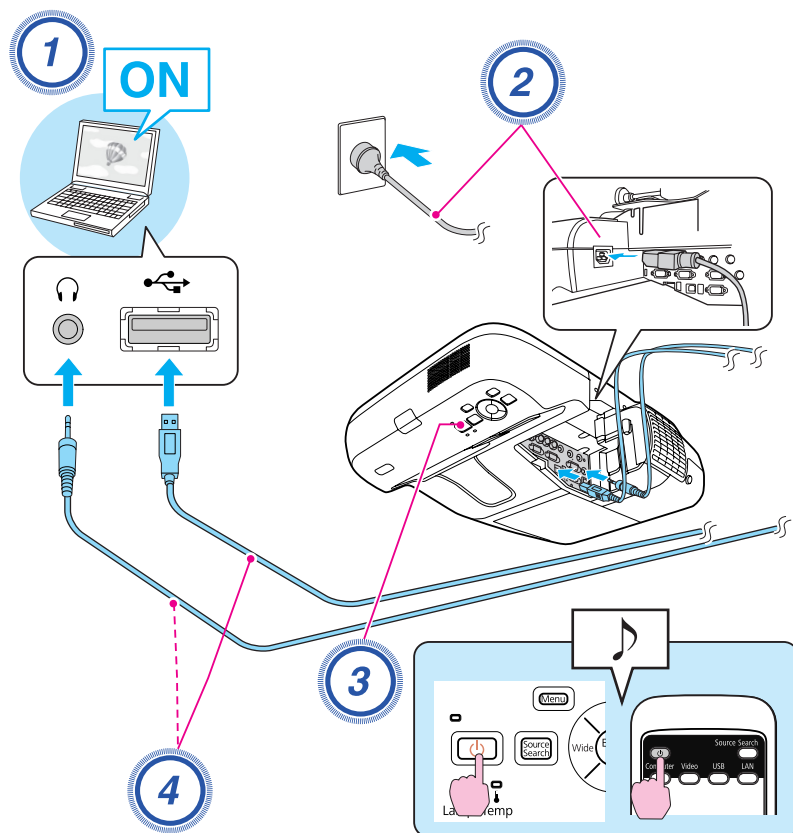

Procedure

- 1 Turn the computer on.
- 2 Connect to the power cable (supplied).
- 3 Turn the projector on.

4

Connect to the USB cable.

When outputting audio from the projector's speaker, connect an audio cable (commercially available) to the Audio2 port.

☛ "Connecting for the first time" p.24

☛ "From the second time" p.27

Attention

Connect the projector directly to the computer and not via a USB hub.

Connecting for the first time

The first time you connect, the driver needs to be installed. The procedure is different for Windows and Mac OS.

Procedure

For Windows

1

Driver installation starts automatically.

When you are using Windows 2000, double-click **My Computer** - EPSON_PJ_UD - EMP_UDSE.exe on your computer.

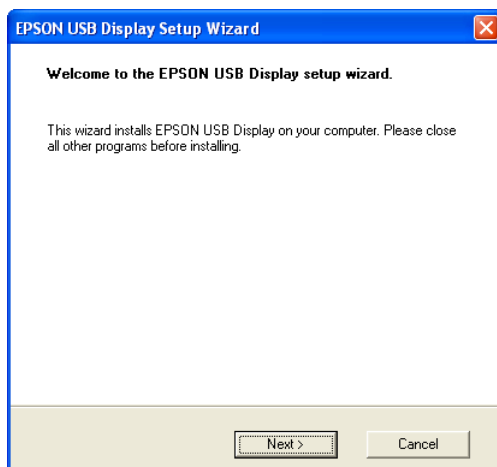

When using a computer running Windows 2000 under user authority, a Windows error message is displayed during installation and you may not be able to install the software. In this case, try updating Windows to the latest version, restart, and then try to connect again.

For more details, contact the nearest address provided in the Support and Service Guide. [Epson Projector Contact List](#)

2 When the License Agreement screen is displayed, click "Agree".

If the driver is not installed, you cannot start USB Display. Select **Agree** to install the driver. If you want to cancel installation, click **Disagree**.

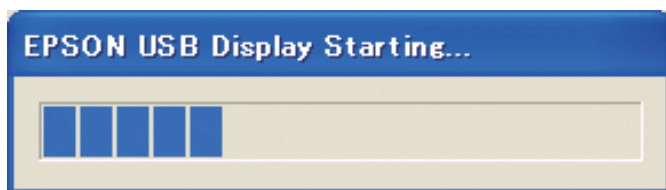

3 Computer images are projected.

It may take a while before computer images are projected. Until computer images are projected, leave the equipment as it is and do not disconnect the USB cable or turn off the power to the projector.

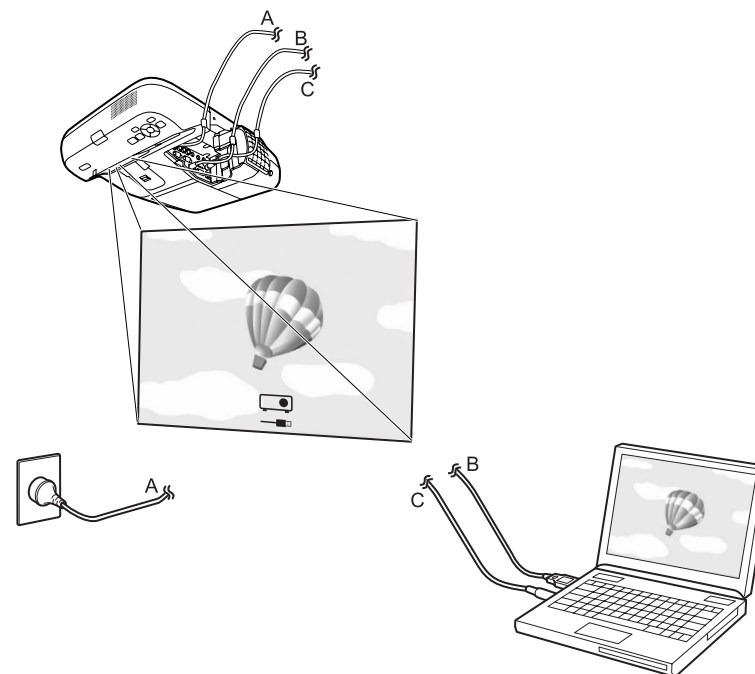



- If it is not installed automatically, double-click **My Computer - EPSON_PJ_UD - EMP_UDSE.EXE**, on your computer.
- If nothing is projected for some reason, click **All Programs - EPSON Projector - EPSON USB Display - EPSON USB Display Vx.x** on your computer.
- If the mouse pointer flickers on the computer screen, click **All Programs - EPSON Projector - EPSON USB Display - EPSON USB Display Vx.x** on your computer, and then clear the **Transfer layered window** checkbox.
- To uninstall the driver, open **Control Panel - Add/Remove Programs** - and uninstall **EPSON USB Display Vx.x**.
- Disconnecting
The projector can be disconnected simply by disconnecting the USB cable. There is no need to use the **Safely Remove Hardware** feature in Windows.

When connecting next time, see "From the second time" p.27.

For Mac OS

- 1 The setup folder of USB Display is displayed in the Finder.**
- 2 Double-click the UD_Installer icon.**
Enter the administrator authority password and start the installation.
- 3 Follow the on-screen instructions to install.**
- 4 When the License Agreement screen is displayed, click "Agree".**

If you do not select **Agree**, USB Display cannot be started. If you want to cancel projection, click **Disagree**.

When the installation is complete, the USB Display icon is displayed in the Dock and menu bar.



Computer images are projected.

It may take a while for computer images to be projected. Until the computer images are projected, leave the equipment as is and do not disconnect the USB cable or turn off the power of the projector.

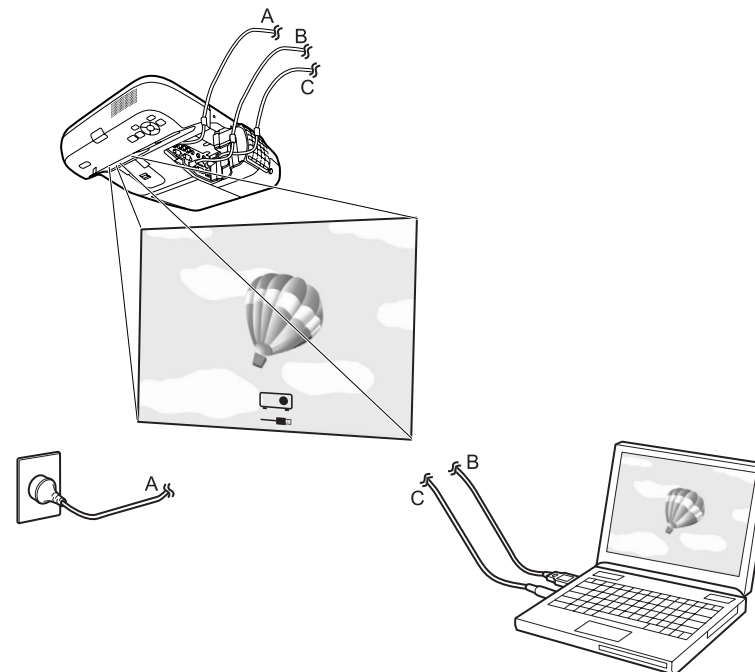

- If the USB Display setup folder is not displayed automatically in the Finder, double-click **EPSON PJ_UD - UD_Installer** on your computer.
- If nothing is projected for some reason, click the **USB Display** icon in the Dock.
- If there is no **USB Display** icon in the Dock, start **USB Display V.x.x** from the Applications folder.
- To uninstall the driver, start **Remove USB Display V.x.x** in the Tool folder of the Applications folder.

Attention

- To disconnect USB Display, click the menu bar icon or Dock icon, select **Disconnect** from the menu that is displayed, and then remove the USB cable.
- If you select **Exit** from the Dock icon menu, USB Display does not start automatically when you connect the USB cable.

From the second time

Computer images are projected.

It may take a while before computer images are projected. Please wait.



For Windows

- Applications that use part of DirectX functions may not be displayed correctly.
- Disconnecting
The projector can be disconnected simply by disconnecting the USB cable. There is no need to use the **Safely Remove Hardware** feature.
- Limitations when projecting from Windows Media Center
When Windows Media Center is in full-screen mode, images cannot be projected. Switch to the window display mode to project the images.

For Mac OS

If images are not projected, start **USB Display V.x.x** from the Applications folder.

Files that can be Projected Using Slideshow

You can use Slideshow to directly project files stored in a USB storage device or digital camera connected to the projector.



You may not be able to use USB storage devices that incorporate security functions.

Specifications for files that can be projected using Slideshow

Type	File Type (Ex-tension)	Notes
Still image	.jpg	<p>The following cannot be projected.</p> <ul style="list-style-type: none"> - CMYK color mode format - Progressive format - Images with a resolution greater than 4608x3072 - Files with the extension ".jpeg" <p>Due to the characteristics of JPEG files, images may not be projected clearly if the compression ratio is too high.</p>



- When using a USB hard disk, we recommend using an AC adapter power supply.
- The projector does not support some file systems, so use media that has been formatted in Windows.
- Format the media in FAT16/32.

Slideshow usage examples

Projecting images stored on USB storage and other media

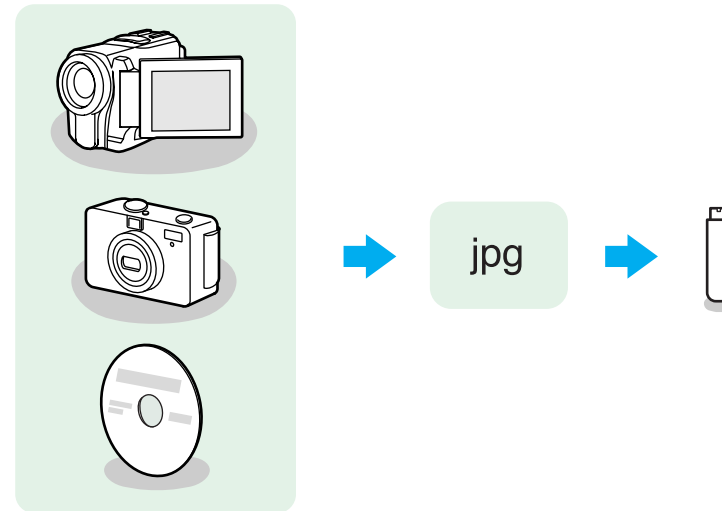

Example 1: Prepare multiple images and project them continuously (Slideshow)  [p.32](#)

Example 2: Select and project image files one at a time  [p.31](#)

Slideshow Basic Operations

Slideshow lets you play back and project image files stored on USB storage devices and digital cameras.



This section explains the basic operations for Slideshow.

Although the following steps are explained based on the remote control, you can perform the same operations from the projector's control panel.

Starting and closing Slideshow

Starting Slideshow

Procedure

- 1 **Change the projected image to USB.**
 p.21
- 2 **Connect the USB storage device or digital camera to the projector.**
 p.34

Slideshow starts and the file list screen is displayed.

Closing Slideshow

Procedure

To close Slideshow, disconnect the USB device from the USB(TypeA) port on the projector. For a digital camera, hard disk, or other equipment, turn off the power of the equipment and then disconnect the equipment.



- You can also insert a memory card into a USB card reader and then connect the reader to the projector. However, some commercially available card readers may not be compatible with the projector.
- When the following screen (Select drive screen) is displayed, use the [◀][▶] buttons to select the drive you want to use, and then press the [Enter] button.

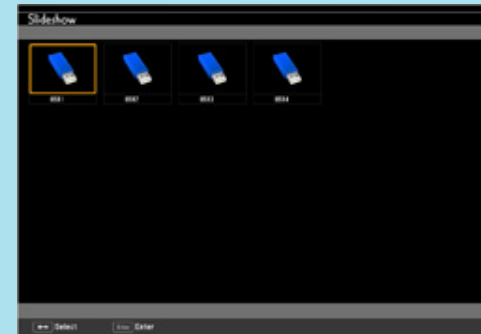

- To display the Select drive screen, position the cursor on **Select drive** at the top of the file list screen, and then press the [Enter] button.

Slideshow basic operations

The following describes the procedures for playing and projecting images using Slideshow.

Procedure

- 1 Use the [▲][▼][▶][◀] buttons to position the cursor on the target file or folder.



① Cursor

- JPEG files are displayed as thumbnails (file content is displayed as small images).
- Depending on the JPEG file, a thumbnail may not be displayed. In this case, a file icon is displayed.



If all files and folders cannot be displayed at the same time in the current screen, press the [Page] (Down) button on the remote control or position the cursor on **Next page** at the bottom of the screen and press the [Enter] button.
To return to the previous screen, press the [Page] (Up) button on the remote control or position the cursor on **Previous page** at the top of the screen and press the [Enter] button.



2 Press the [Enter] button.

The selected image is displayed.

When a folder is selected, the files in the selected folder are displayed. Select **Back to Top** on the screen that opened and press the [Enter] button to return to the previous screen.

Rotating images



You can rotate the played images in JPEG format in 90° increments. You can also rotate JPEG format images during Slideshow.

Rotate JPEG images in the following way.

Procedure



1 Play images in JPEG format, or run Slideshow.

To play images in JPEG format  [p.31](#)
To run Slideshow  [p.32](#)





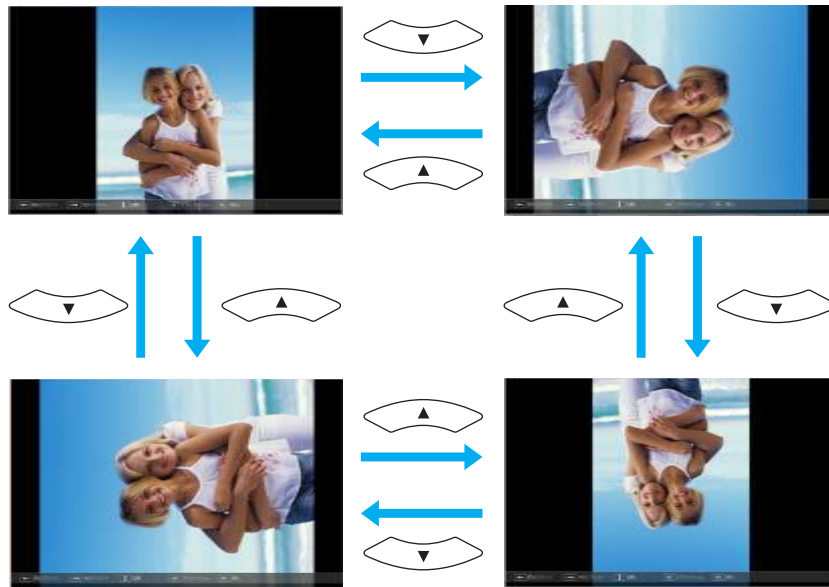

2 When a JPEG image is displayed, press the [] button or the [] button.



Projecting images

Procedure

- 1 Start Slideshow.  p.29
The file list screen is displayed.
- 2 Use the [] [] [] [] buttons to position the cursor on the image file to be projected.



① Image file

- 3 Press the [Enter] button.
The image starts to play back.

Projecting Image Files

Image files on USB storage and image files on a digital camera can be projected using Slideshow in either of the following two ways.

- Projecting selected image files
This is a function for projecting the content of a single file.
- Projecting all image files in a folder in sequence (Slideshow)
This is a function for projecting the content of files in a folder in order, one file at a time.

Attention

Do not disconnect the USB storage device while it is being accessed. Slideshow may not operate correctly.

Although the following steps are explained based on the remote control, you can perform the same operations from the projector's control panel.

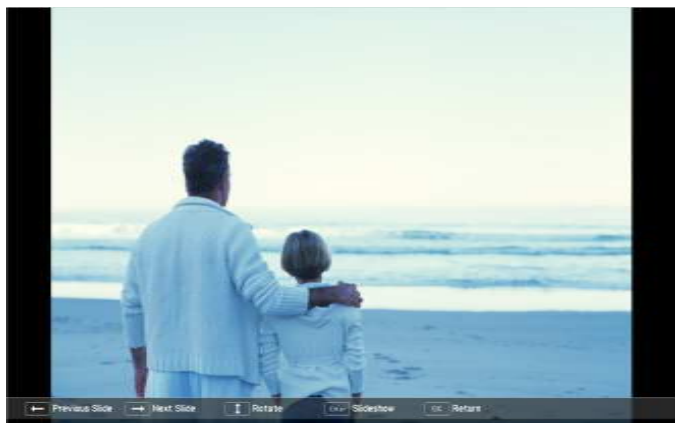

- 4 Press the [Esc] button to return to the file list screen.

Projecting all image files in a folder in sequence (Slideshow)

You can project the image files in a folder in sequence, one at a time. This function is called Slideshow. Use the following procedure to run Slideshow.



To change files automatically when you run Slideshow, set **Screen switching time** from **Option** in Slideshow to anything other than **No**. The default setting is **3 seconds**. 🖱️ "Image File Display Settings and Slideshow Operation Settings" p.33

Procedure

- 1 **Start Slideshow.** 🖱️ p.29
The file list screen is displayed.
- 2 Use the [⏪] [⏩] [⏴] [⏵] buttons to position the cursor on the folder to be played by Slideshow and press the [Enter] button.
- 3 **Select Slideshow from the the bottom of the file list screen, and then press the [Enter] button.**

Slideshow starts, and the image files in the folder are automatically projected in sequence, one at a time.

When the last file is projected, the file list is displayed again automatically. If you set **Continuous Play** to **On** from the Option screen, projection starts again from the beginning when it reaches the end. 🖱️ "Image File Display Settings and Slideshow Operation Settings" p.33

You can proceed to the next screen, return to the previous screen, or stop playback while projecting a Slideshow.







If **Screen switching time** on the **Option** screen is set to **No**, files do not change automatically when you select Play Slideshow. Press the [Enter] button or the [Page] (Down) button on the remote control to project the next file.

Image File Display Settings and Slideshow Operation Settings

You can set the file display order and Slideshow operations on the Option screen.

Although the following steps are explained based on the remote control, you can perform the same operations from the projector's control panel.

Procedure

1 Use the [][][][] buttons to position the cursor on the folder for which you want to set display conditions and press the [Esc] button. Select "Option" from the sub-menu that is displayed, and then press the [Enter] button.

2 When the following Option screen is displayed, set each of the items.

Position the cursor on the setting of the item you want to change and press the [Enter] button to enable the setting.

The following table shows the details of each item.



Display order	Set the order of the files to be displayed. You can select sorting of the files into either Name order or Date order.
Continuous Play	Set whether to repeat the Slideshow.
Screen switching time	Set the time to display one file when playing a Slideshow. You can set No or a time from (0) to 60 seconds. When you set No, auto play is disabled.

3 Use the [][][][] buttons to position the cursor on "OK" and press the [Enter] button.

The settings are applied.

If you do not want to apply the settings, position the cursor on **Cancel** and press the [Enter] button.

Connecting and Removing USB Devices

USB memories and USB compatible digital cameras, hard disk drives, and the optional Document Camera can be connected to the projector. Image files on a connected digital camera or JPEG files on a connected USB storage device can be played back as a Slideshow.  "Presentations Using Slideshow" [p.28](#)

When the optional Document Camera is connected, images from the Document Camera will be projected.

Connecting USB devices

This section describes how to connect USB devices, using the optional Document Camera as an example. Connect the Document Camera to the projector using the USB cable supplied with the Document Camera. When the Document Camera is connected to the projector during projection, press the [USB] button on the remote control or the [Source Search] button on the control panel to switch to images from the Document Camera.  [p.21](#)

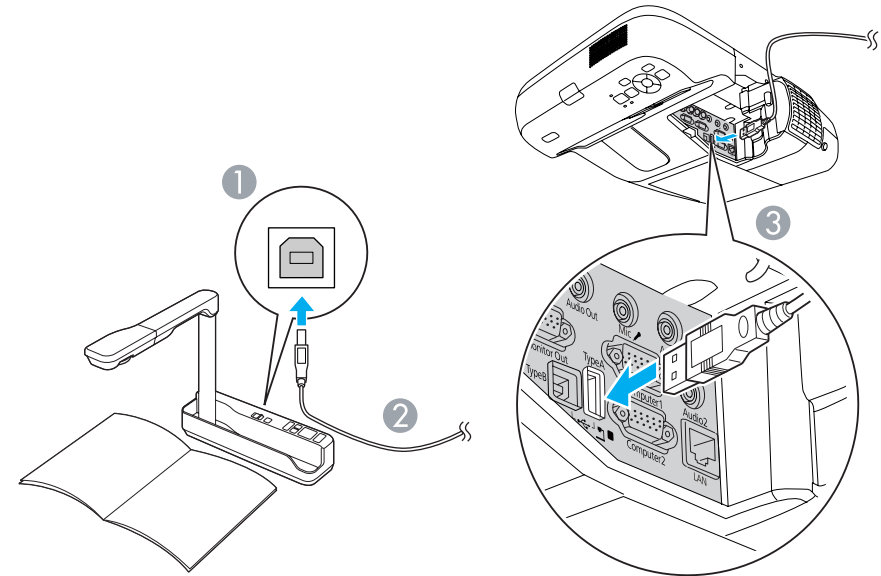

- ① To Document Camera USB port
- ② USB cable
- ③ USB(TypeA) port

Attention

- If you use a USB hub, operation may not be performed correctly. Connect a digital camera or USB storage device directly to the projector.
- When connecting and using a USB-compatible hard disk, make sure you connect the AC adaptor supplied with the hard disk.
- Connect a digital camera or hard disk to the projector using the USB cable supplied with or specified for use with the equipment.

Removing USB devices

After projection is finished, use the following procedure to remove the USB device from the projector.

Procedure

Disconnect the optional Document Camera from the projector's USB(TypeA) port.

For digital cameras, hard disks, and so on, turn off the power to the device and then remove.

③ To Monitor Output (Monitor Out) Port



- You cannot display component video signals or images from equipment connected to the Video input port or S-Video input port on an external monitor.
- Setting gauges for functions such as Keystone, Configuration Menu, or Help screens are not output to the external monitor.

Connecting an External Monitor

You can display computer images input from Computer1 input port on an external monitor and the screen connected to the projector at the same time. This means that you can check projected images on an external monitor when giving presentations even if you cannot see the screen. Connect using the cable supplied with the external monitor.

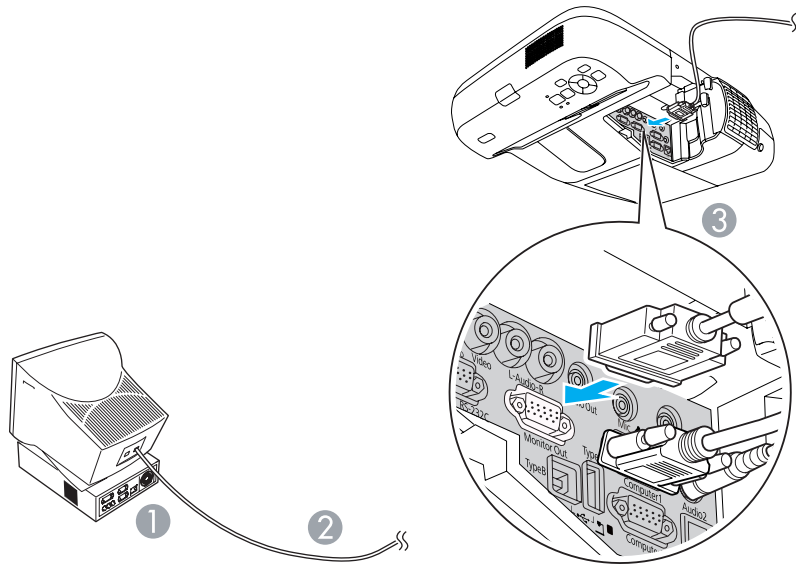

- ① To Monitor port
- ② Cable supplied with monitor

Connecting External Speakers

You can connect external speakers with built-in amplifiers to the projector's Audio Output (Audio out) port to enjoy better sound quality. Connect with a commercially available audio cable (such as pin plug ↔ 3.5 mm stereo mini plug). Use an audio cable compatible with the connector on the external speakers.

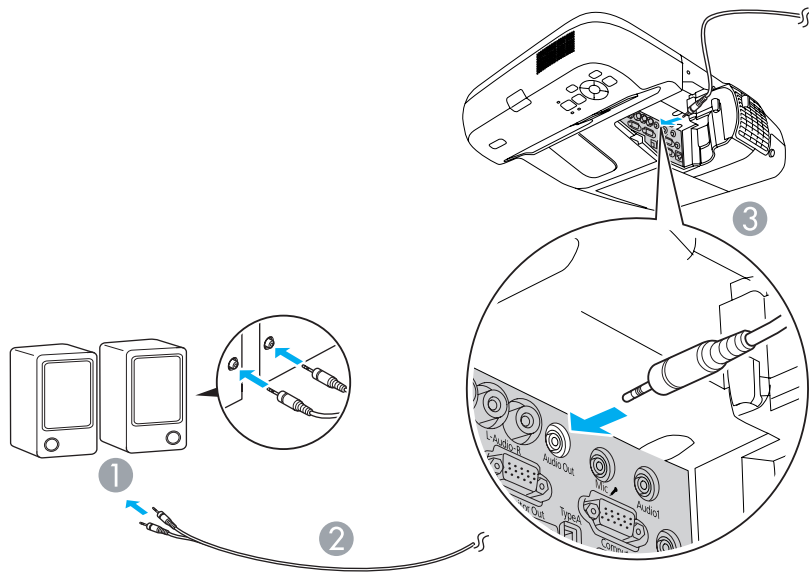

- ① To external audio equipment
- ② Audio cable (commercially available)
- ③ To Audio Output (Audio Out) port



- When the audio cable jack is inserted into the Audio Output (Audio Out) port, audio stops being output from the projector's built-in speakers and switches to external output.
- When using a commercially available 2RCA(L/R)/stereo mini-pin audio cable, make sure it is labeled "No resistance".

Connecting a microphone

You can output microphone audio from the projector's speaker by connecting a microphone to the projector's Microphone (Mic) input port. The projector does not support plug-in-power.

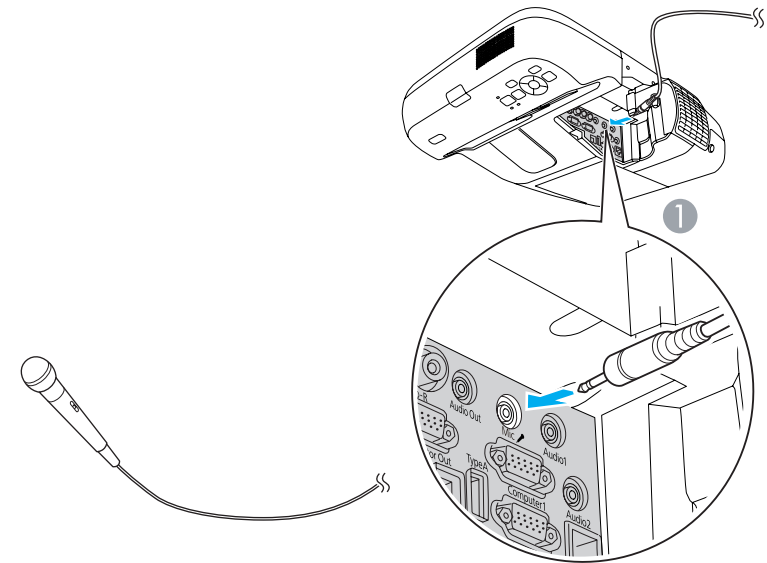

- ① To Microphone (Mic) input port

Connect with a commercially available 100BASE-TX or 10BASE-T LAN cable.

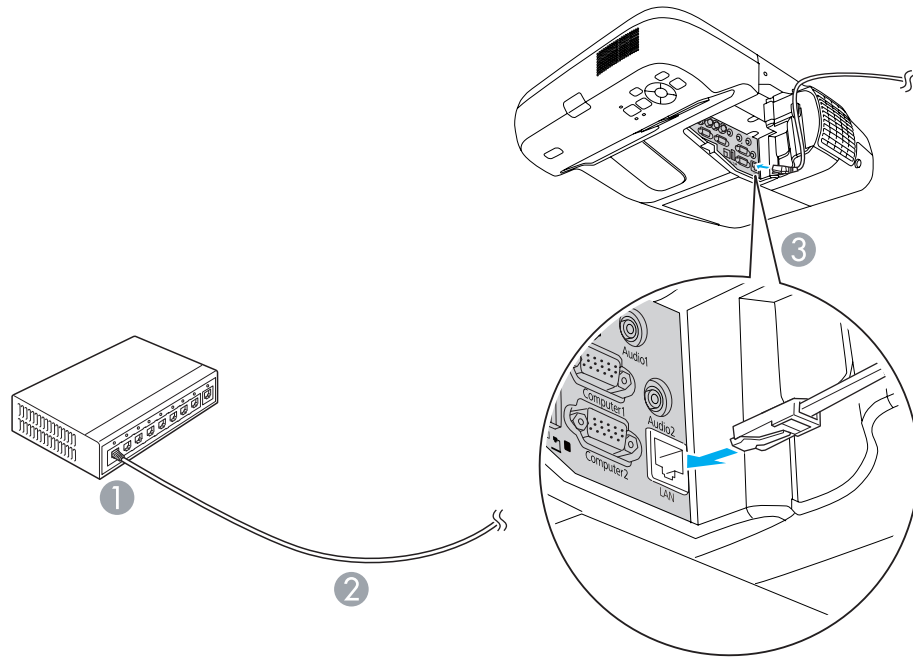

- ① To LAN port
- ② LAN cable (commercially available)
- ③ To LAN port

Attention

To prevent malfunctions, use a category 5 shielded LAN cable.

Install the optional wireless LAN unit in the projector.  "Optional Accessories and Consumables" p.116

Procedure

1 Open the air filter cover.

Slide the air filter cover open/close lever horizontally to open the air filter cover.

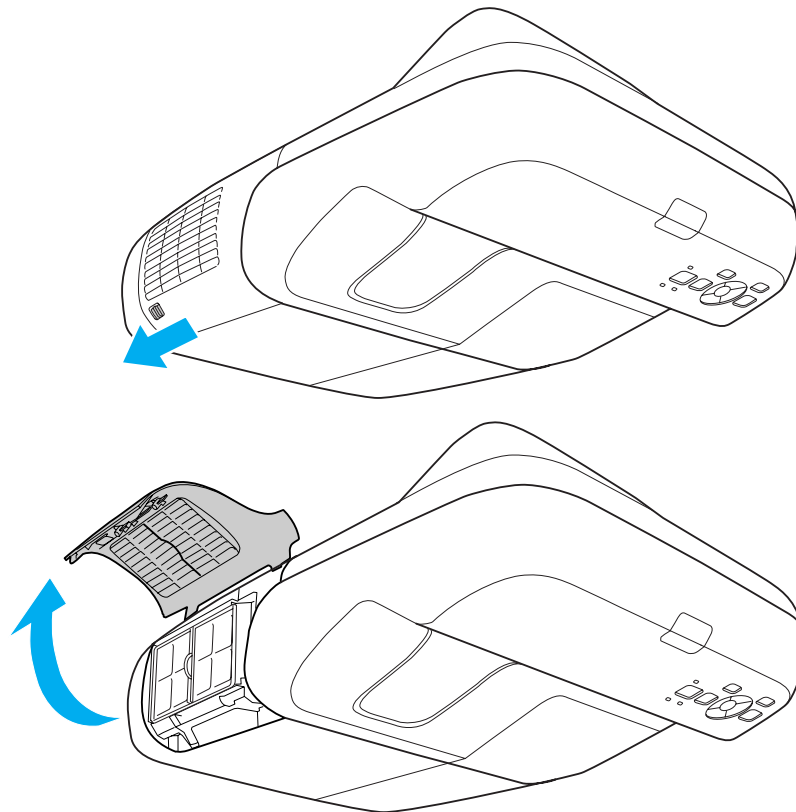

2 Install the Wireless LAN unit.

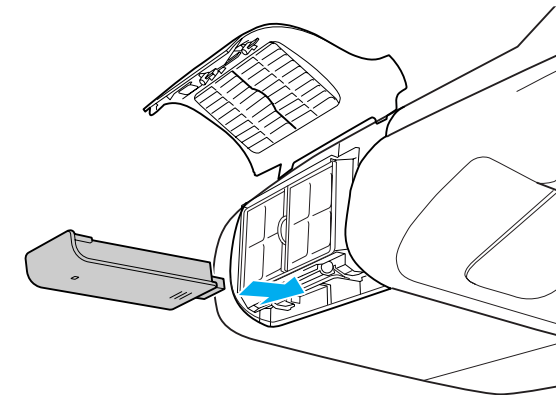

3 Secure the Wireless LAN unit using the screw included to avoid losing the unit.

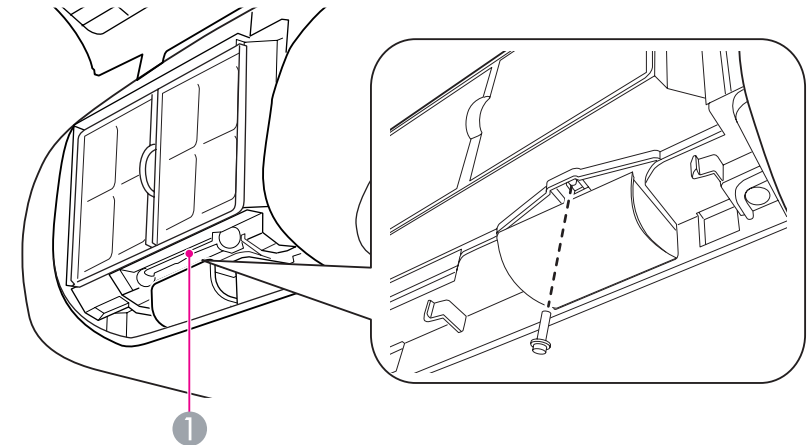

① Screw hole to fix wireless LAN unit

Selecting the Projection Quality (Selecting Color Mode)

You can easily obtain the optimum image quality simply by selecting the setting that best corresponds to your surroundings when projecting. The brightness of the image varies depending on the mode selected.

Mode	Application
Dynamic	Ideal for use in a bright room. This is the brightest mode, and reproduces shadow tones well.
Presentation	Ideal for making presentations using color materials in a bright room.
Theatre	Ideal for watching films in a dark room. Gives images a natural tone.
Photo	(When inputting computer image signals or the input source is USB or LAN) Ideal for projecting still pictures, such as photos, in a bright room. The images are vivid and brought into contrast.
Sports	(When Component Video, S-Video, or composite video images are input) Ideal for watching TV programmes in a bright room. The images are vivid and brought to life.
sRGB 	Ideal for images that conform to the sRGB color standard.
Blackboard	Even if you are projecting onto a Blackboard (greenboard), this setting gives your images a natural tint, just like when projecting onto a screen.
Whiteboard	Ideal for making presentations using a whiteboard.

Procedure

Remote Control

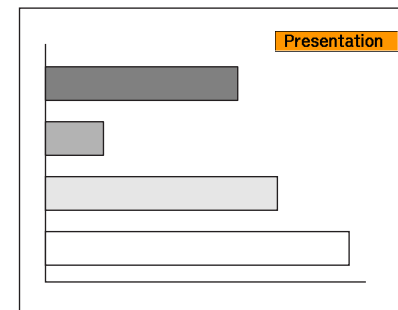
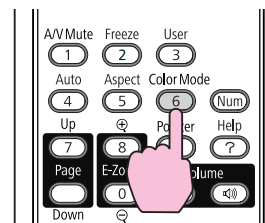

Each time you press the button, the Color Mode name is displayed on the screen and the Color Mode changes.

If you press the button while the Color Mode name is displayed on the screen, it changes to the next Color Mode.



The color mode can also be set from **Color Mode** in the **Image** menu from the Configuration Menu.  p.74

Setting the Auto Iris

By automatically setting the luminance according to the brightness of the displayed image, it lets you enjoy deep and rich images.

Procedure

- 1 Press the [Menu] button and select **Image - Auto Iris** from the Configuration Menu.  **"Using the Configuration Menu"**

Using the Remote Control

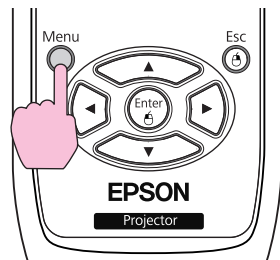

Using the Control panel

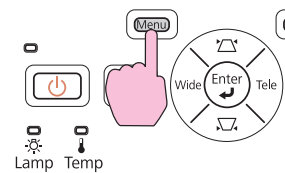

- 2 Select **"On"**.
The setting is stored for each Color Mode.

- 3 Press the [Menu] button to close the Configuration Menu.



Auto Iris can only be set when the **Color Mode** is set to **Dynamic** or **Theatre**.

Hiding the Image and Sound Temporarily (A/V Mute)

You can use this when you want to turn off screen images so that the audience's attention is focused on what you are saying, or when you do not want the audience to see operations such as changing files.

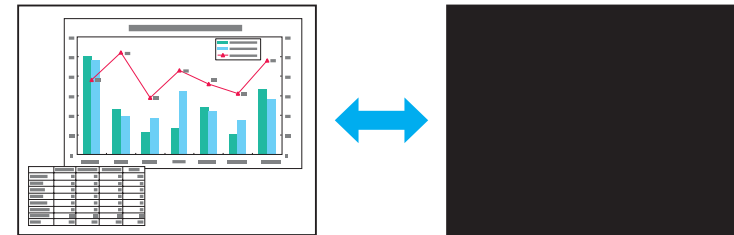

Procedure

Remote Control

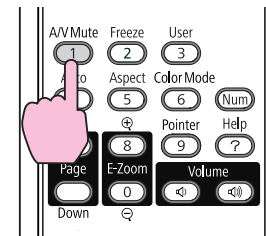

Each time you press the button, A/V Mute turns on or off.



- If you use this function when projecting moving images, the images and sound continue to be played back by the source, and you cannot return to the point where A/V Mute was activated.
- You can choose to display **Black**, **Blue**, or **Logo** as the A/V Mute display using the **Extended - Display - A/V Mute** setting from the configuration menu.  [p.78](#)
- Microphone audio is also output when A/V Mute is turned on.

Freezing the Image (Freeze)

When the moving image on the screen is frozen, the image continues to project, so you can project a moving image one frame at a time like a still photo. Also, you can perform operations such as changing between files during presentations from a computer without projecting any images if the freeze function is activated beforehand.

Procedure

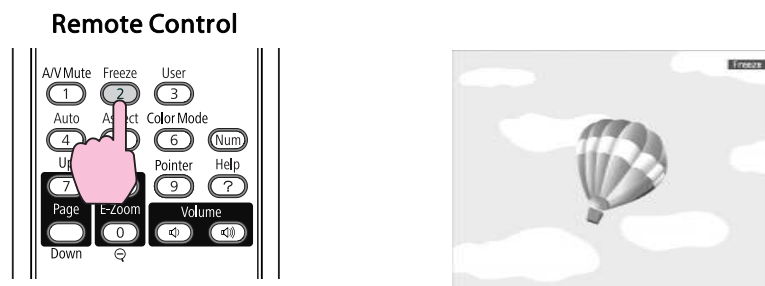

Each time you press the button, Freeze turns on or off.



- Audio does not stop.
- For moving images, the images continue to play back while the screen is frozen, so it is not possible to resume projection from the point where the screen was frozen.
- If the [Freeze] button is pressed while the Configuration Menu or a Help screen is displayed, the menu or Help screen being displayed is cleared.
- Freeze still works while E-Zoom is being used.

Changing the Aspect Ratio

Change the Aspect Ratio when video equipment is connected so that images that have been recorded in digital video or onto DVDs can be viewed in 16:9 wide-screen format. Change the Aspect Ratio when projecting computer images at full size.

The changing methods and the types of Aspect ratio are as follows.

Changing methods

Procedure

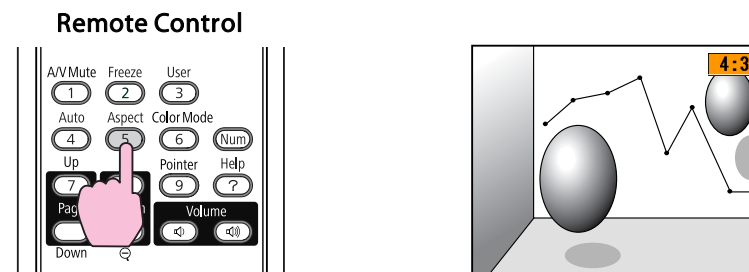

Each time you press the button, the Aspect name is displayed on the screen and the Aspect changes.



The aspect ratio can also be set from **Aspect** in the **Signal** menu from the Configuration Menu.  [p.75](#)

Changing the aspect ratio for video equipment images

EB-460i/460

Each time you press the button, the aspect ratio changes between 4:3 and 16:9.

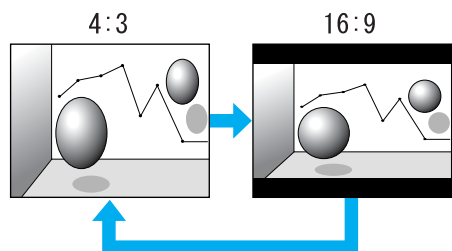

- ③ Full
- ④ Zoom
- ⑤ Native

EB-450Wi/450W/440W

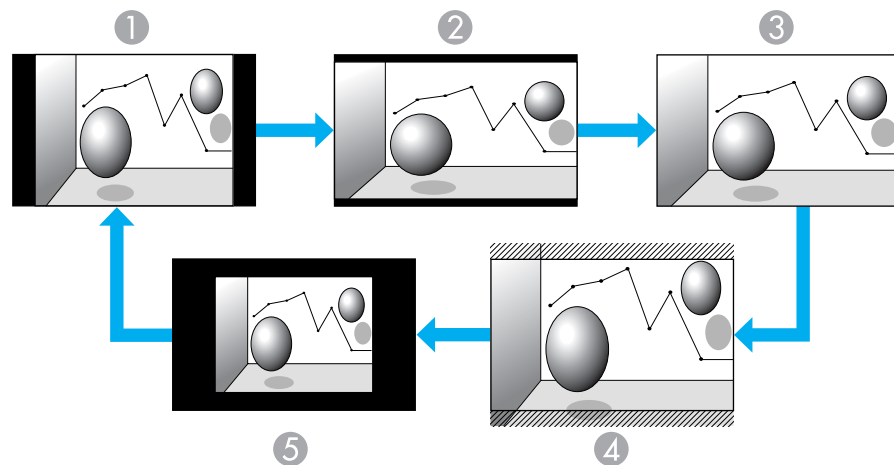

Each time the button is pressed, the aspect ratio changes in the order of Normal, 16:9, Full, Zoom, and Native.



- ① Normal
- ② 16:9

Changing the aspect ratio for computer images (EB-460i/460)

You can change the aspect ratio as follows.

Set Values	Operation	Projection example
Normal	Projects to the full projection size retaining the Aspect of the input image.	
4:3	Projects to the full projection size at an Aspect of 4:3. This is ideal for when you want to project images at an Aspect of 5:4 (1280 x 1024) to the full projection size.	When a 1280x1024 signal is input 
16:9	Projects at a 16:9 Aspect. This is ideal for projecting at full screen size when using a 16:9 screen.	When a 1280x1024 signal is input 



If parts of a projected image are missing and not all of the image can be projected, set **Resolution** from the Configuration Menu to **Wide** or **Normal** according to your computer's panel size.  [p.75](#)

Changing the aspect ratio for computer images (EB-450Wi/450W/440W)

You can change the aspect ratio as follows. EB-450Wi/450W/440W offers a panel resolution of WXGA so the projection size is 1280x800 dots (aspect ratio of 16:10). When projecting onto a 16:9 screen, set the the aspect ratio to 16:9.

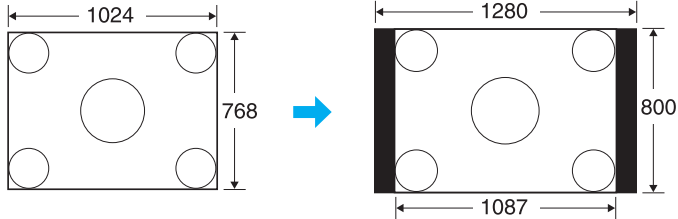
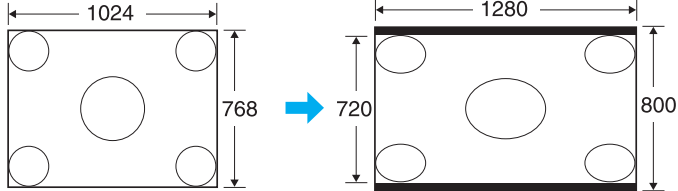
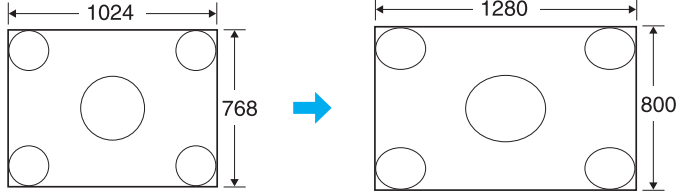
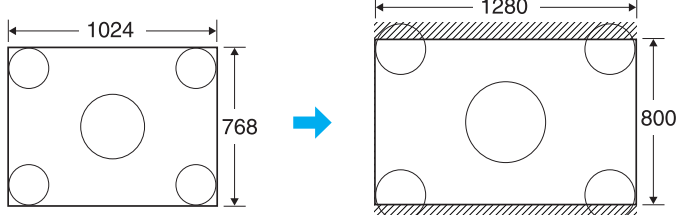
Set Values	Operation	Projection example
Normal	Projects to the full projection size retaining the Aspect of the input image.	When a 1024x768 signal is input 
16:9	Projects to the full projection size at an Aspect of 16:9.	When a 1024x768 signal is input 
Full	Project at full size.	When a 1024x768 signal is input 
Zoom	Projects the input image at the lateral direction aspect size as it is. Parts that extend beyond the projection size are not projected.	When a 1024x768 signal is input 

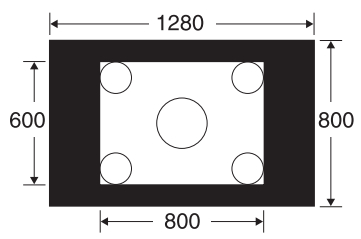
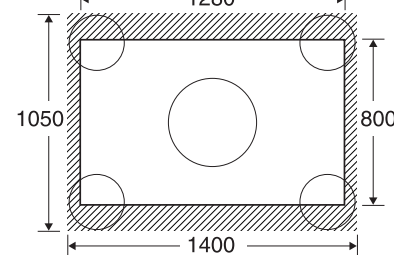
Set Values	Operation	Projection example	
<p>Native</p>	<p>Projects at the resolution of the input image size to the center of the screen. This is ideal for projecting clear images. If the image resolution exceeds 1280x800, the edges of the image are not projected.</p>	<p>When an 800x600 signal is input</p> 	<p>When an 1400x1050 signal is input</p> 



If parts of a projected image are missing and not all of the image can be projected, set **Resolution** from the Configuration Menu to **Wide** or **Normal** according to your computer's panel size. [p.75](#)

Using the Pointer to Highlight Sections (Pointer)

This allows you to move a Pointer icon on the projected image, and helps you draw attention to the area you are talking about.

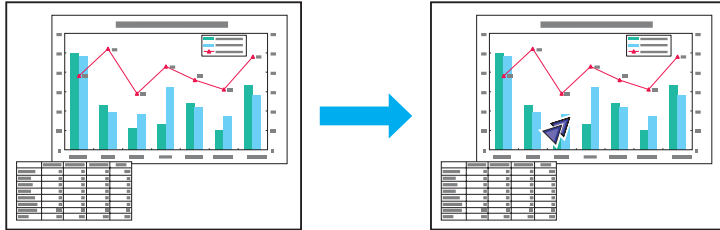

Procedure

- 1 Display the Pointer.

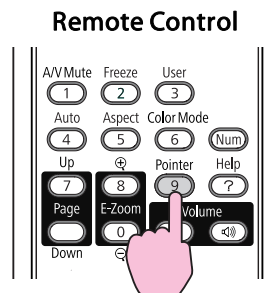

Each time you press the button, the pointer appears or disappears.

- 2 Move the Pointer icon (↗).

Remote Control

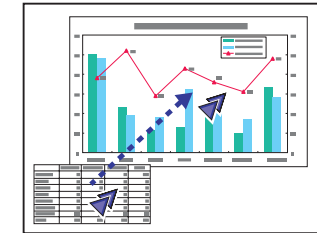
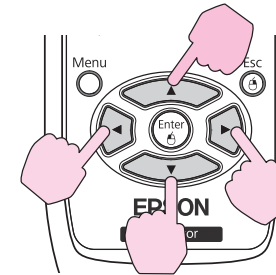

When you press two of the [▲][▼][▶][◀] buttons that are adjacent to each other at the same time, the pointer can be moved diagonally instead of up, down, left, or right.



You can choose from three different kinds of Pointer icon (↗, ✖, or ↘) in **Settings - Pointer Shape** from the Configuration Menu.
 p.76

Enlarging Part of the Image (E-Zoom)

This is useful when you want to expand images to see them in greater detail, such as graphs and tables.

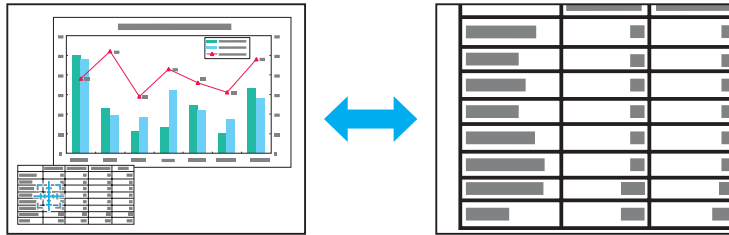

Procedure

1 Start E-Zoom.

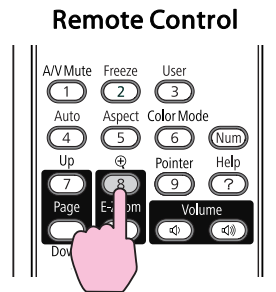

2 Move the cross (⊕) to the part of the image that you want to enlarge.

Remote Control

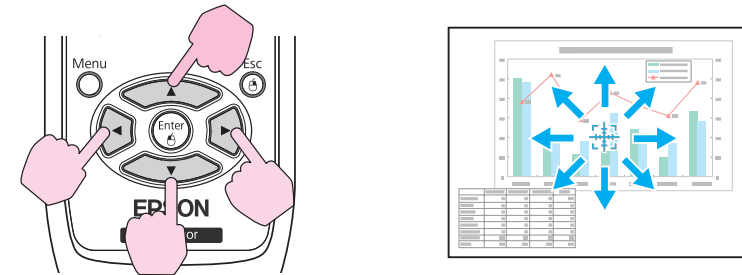

When you press two of the [▲][▼][▶][◀] buttons that are adjacent to each other at the same time, the cross can be moved diagonally instead of up, down, left, or right.

3 Enlarge.

Remote Control

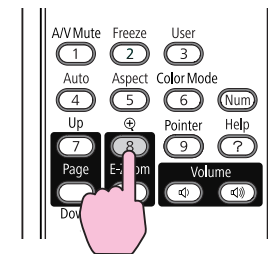





Each time the button is pressed, the area is expanded. You can expand quickly by holding the button down.

You can reduce the enlarged image by pressing the ⊖ button.

Press the [Esc] button to cancel.



- The enlargement ratio appears on the screen. The selected area can be enlarged to between 1 to 4 times in 25 incremental steps.
- Press the [] [] [] [] buttons to scroll the image.
- If E-Zoom is selected, Progressive and Noise Reduction are cancelled.

Operating the Mouse Pointer by Remote Control (Wireless Mouse)

To activate the Wireless Mouse function, set USB Type B to Wireless Mouse from the Extended menu in the Configuration Menu.

The following shows the default settings for USB Type B.

- EB-460i/450Wi: Off
- EB-460/450W/440W: USB Display

Change the setting beforehand.  [p.78](#)

By connecting a computer's USB port and the USB(TypeB) on the side of the projector with the supplied USB cable, you can use the projector's remote control like a wireless mouse to control the computer's mouse pointer.

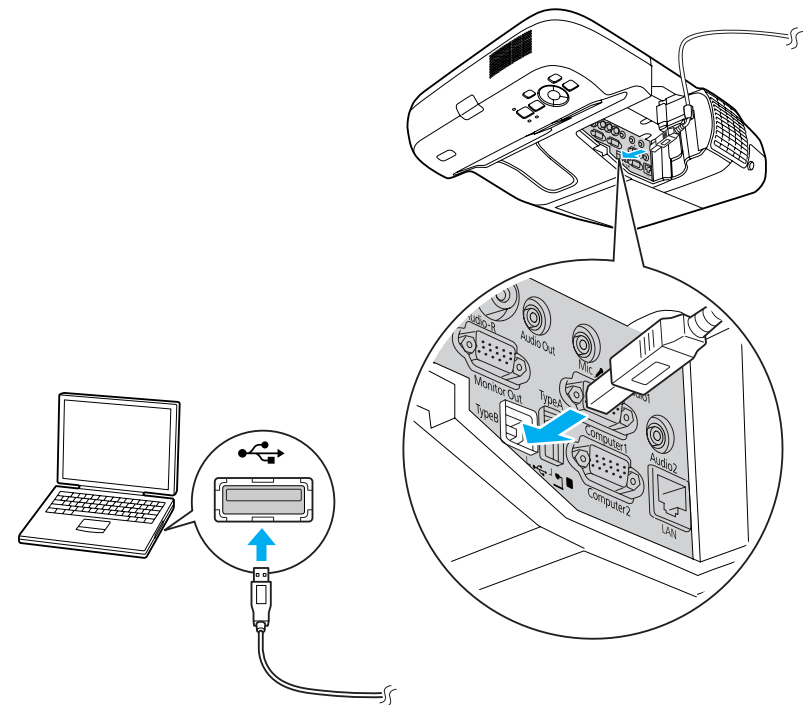

	Windows	Mac OS
OS	Windows 98 Windows 98SE Windows Me Windows 2000 Windows XP Windows Vista Windows 7	Mac OS X 10.3.x Mac OS X 10.4.x Mac OS X 10.5.x Mac OS X 10.6.x



- The Wireless Mouse function can only be used when the input source is Computer1/Computer2 and the input signal is RGB.
- You may not be able to use the Wireless Mouse function in some versions of Windows and Mac OS.
- Some computer settings may have to be changed in order for the mouse function to be used. Consult the documentation for the computer for further details.

Once the connection has been made, the mouse pointer can be operated as follows.

Moving the mouse pointer

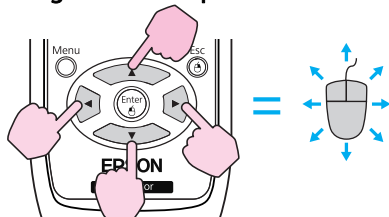

Mouse clicks

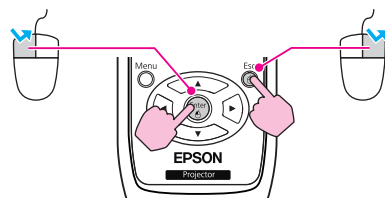

Left click: Press the [Enter] button.
 Right click: Press the [Esc] button.
 Double click: Press quickly twice.

Drag and drop

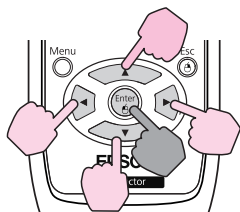

: Keep pressed

1. While holding down the [Enter] button, press the [Up], [Down], [Left], or [Right] button.

Switching PowerPoint screens

This is useful for displaying the previous or next slide in a PowerPoint Slideshow.

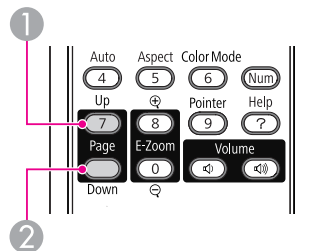

1 To previous slide

2. Release the [Enter] button to drop at the desired location. **2** To next slide



- When you press two of the [Up], [Down], [Left], or [Right] buttons that are adjacent to each other at the same time, the pointer can be moved diagonally instead of up, down, left, or right.
- If the mouse button settings are set to reverse on the computer, the operation of the Remote Control buttons will also be reversed.
- The Wireless Mouse function cannot be used while the following functions are being used.
 - While the Configuration Menu is being displayed
 - While a Help menu is being displayed
 - While the E-Zoom function is being used
 - While a User's Logo is being captured
 - While a User Pattern is being captured
 - While the Pointer function is being used
 - While the Volume is being adjusted
 - While USB Display is being operated
 - While a Pattern is being displayed
 - While Color Mode is being set
 - While the Source name is being displayed

The projector has the following enhanced security functions.

- **Password Protect**
You can limit who can use the projector.
- **Control Panel Lock**
You can prevent people changing the settings on the projector without permission. p.52
- **Anti-Theft Lock**
The projector is equipped with various types of anti-theft security devices. p.53

2. User's Logo Protect

There is little point in going to the trouble of saving a User's Logo to indicate the owner of a projector if the logo display is changed later. When **User's Logo Protect** is set to **On**, changing the following settings for the User's Logo is prohibited.

- Capturing a User's Logo
- Settings for **Display Background**, **Startup Screen**, and **A/V Mute** from **Display** in the Configuration Menu.

3. Network Protect

When **Network Protect** is set to **On**, changing the settings for **Network** in the Configuration Menu is prohibited.

Managing Users (Password Protect)

When Password Protect is activated, people who do not know the Password cannot use the projector to project images even if the projector power is on. Furthermore, the user's logo that is displayed when you turn on the projector cannot be changed. This acts as an anti-theft device as the projector cannot be used even if it is stolen. At the time of purchase, Password Protect is not activated.

Type of Password Protect

The following three kinds of Password Protect settings can be made according to how the projector is being used.

1. Power On Protect

When **Power On Protect** is **On**, you need to enter a preset Password after the projector is plugged in and turned on (this also applies to Direct Power On). If the correct Password is not entered, projection does not start.

Setting Password Protect

Use the following procedure to set Password Protect.

Procedure



During projection, hold down the [Freeze] button for about five seconds.

The Password Protect setting menu is displayed.

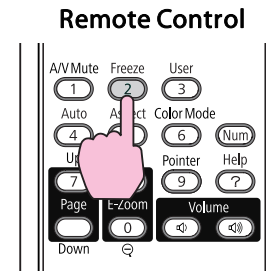



- If Password Protect is already activated, you are requested to enter the Password.
If the Password is entered correctly, the Password Protect setting menu is displayed. ➡ "Entering the Password" p.51
- When the password is set, stick the supplied password protect sticker in a visible position on the projector as a further theft deterrent.

2 Turn on Power On Protect.

- (1) Select **Power On Protect**, and then press the [Enter] button.
- (2) Select **On**, and then press the [Enter] button.
- (3) Press the [Esc] button.

3 Turn on User's Logo Protect.

- (1) Select **User's Logo Protect**, and then press the [Enter] button.
- (2) Select **On**, and then press the [Enter] button.
- (3) Press the [Esc] button.

4 Turn on Network Protect.

- (1) Select **Network Protect**, and then press the [Enter] button.
- (2) Select **On**, and then press the [Enter] button.
- (3) Press the [Esc] button.

5 Set the Password.

- (1) Select **Password**, and then press the [Enter] button.
- (2) When the message "**Change the password?**" is displayed, select **Yes** and then press the [Enter] button. The default setting for the Password is "0000". Make sure you change this to your own desired password. If you select **No**, the screen displayed in step 1 is displayed again.
- (3) While holding down the [Num] button, enter a four digit number using the numeric buttons. The number entered is displayed as "* * * *". When you enter the fourth digit, the confirmation screen is displayed.

Remote Control

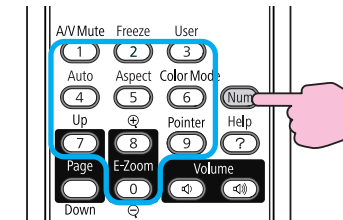

- (4) Re-enter the Password.
The message "**Password accepted.**" is displayed.
If you enter the Password incorrectly, a message is displayed prompting you to re-enter the password.

Entering the Password



When the Password entry screen is displayed, enter the Password using the numeric buttons on the Remote Control.

Procedure

While holding down the [Num] button, enter the Password by pressing the numeric buttons.

When you enter the correct Password, projection begins.

Attention

- If an incorrect password is entered three times in succession, the message "The projector's operation will be locked." for about five minutes, and then the projector switches to standby mode. If this happens, disconnect the power plug from the electrical outlet and then reinsert it and turn the projector's power back on. The projector displays the Password entry screen again so that you can enter the correct Password.
- If you have forgotten the password, make a note of the "Request Code: xxxxx" number that appears on the screen and contact the nearest address provided in the Support and Service Guide.  [Epson Projector Contact List](#)
- If you continue to repeat the above operation and enter the wrong Password thirty times in succession, the following message is displayed and the projector does not accept any more password entries. "The projector's operation will be locked. Contact Epson as described in your documentation".  [Epson Projector Contact List](#)

Restricting Operation (Control Panel Lock)

Perform one of the following to lock the operation buttons on the Control panel.

- Full Lock
All of the buttons on the Control panel are locked. You cannot perform any operations from the Control panel, including turning the power on or off.
- Partial Lock
All of the buttons on the Control panel, except for the [⏻] button, are locked.

This is useful at events or shows when you want to deactivate all buttons and only project, or at schools when you want to limit button operation. The projector can still be operated using the Remote Control.

Procedure

- 1 During projection, press the [Menu] button and select Control Panel Lock from the Settings Menu in the Configuration Menu.  "Using the Configuration Menu" [p.73](#)

Using the Remote Control

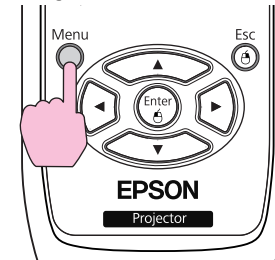

Using the Control panel

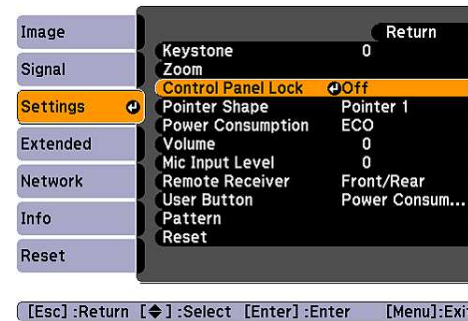
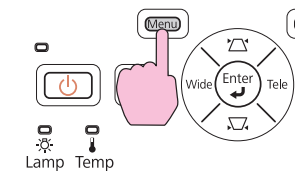

- 2 Select either Full Lock or Partial Lock.

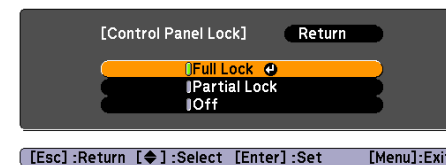

- 3 Select Yes when the confirmation message is displayed.

The Control panel buttons are locked according to the setting you chose.



You can release the Control panel lock by one of the following two methods.

- From the Remote Control, select **Off** in **Settings - Control Panel Lock** from the Configuration Menu.
- Press and hold down the [Enter] button on the Control panel for about seven seconds, a message is displayed and the lock is released.

Anti-Theft Lock

As the projector is often setup on ceiling mounts and left in rooms unattended, the projector includes the following security devices to prevent someone from taking the projector.

- **Security slot**
The Security slot is compatible with the Microsaver Security System manufactured by Kensington. You can find details about the Microsaver Security System on the Kensington homepage <http://www.kensington.com/>.
- **Security cable installation point**
A commercially available theft-prevention wire lock can be used to secure the projector to a pillar.

Installing the wire lock

Pass an anti-theft wire lock through the installation point.

See the documentation supplied with the wire lock for locking instructions.

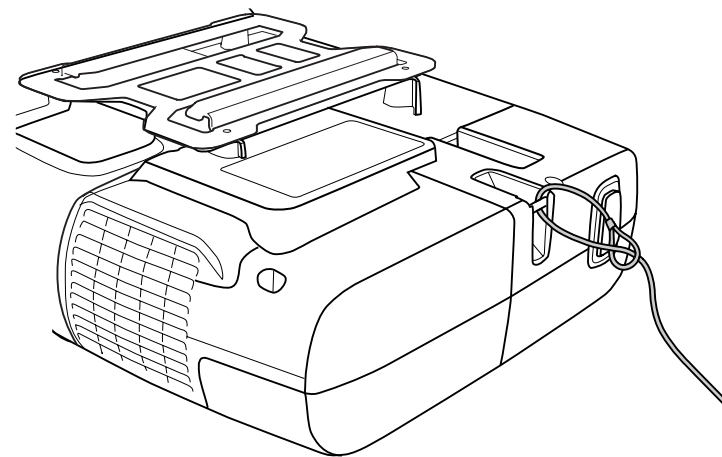

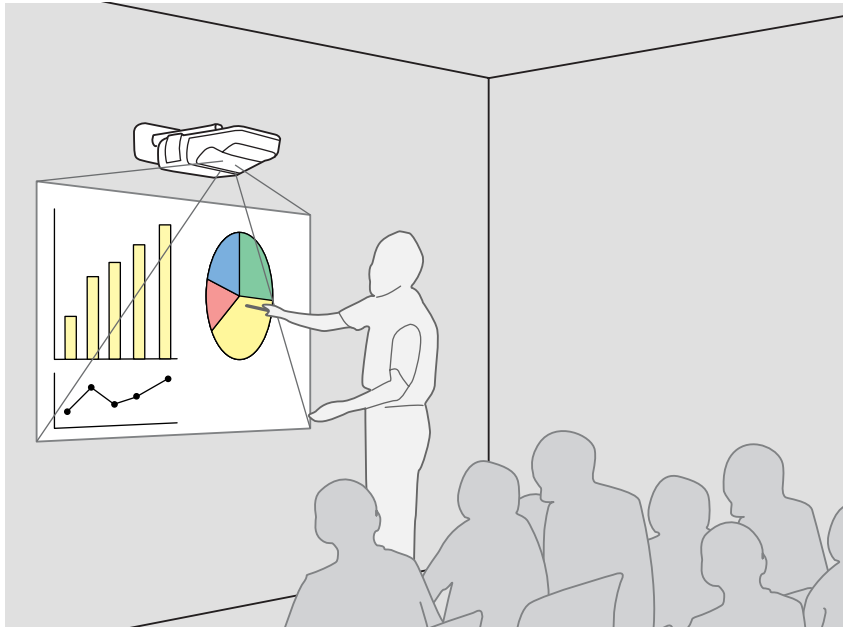

Summary of Easy Interactive Function

- By simply connecting a computer to the projector, you can control the computer on the projection screen and give an effective, interactive presentation or lesson.
- Using the dedicated Easy Interactive Pen
The supplied pen (Easy Interactive Pen) can be used like a mouse, which allows you to treat the projection surface in the same way as a computer screen. You can use an application with a drawing function to draw diagrams and write text on the projection surface.



Download Easy Interactive Tools, a dedicated application for the drawing function, from the Epson Web site.

 <http://www.epson.com>

- Position alignment (Calibration)
This operation is for aligning the pen position on the projection surface and the mouse position on the computer screen in order to use the Easy Interactive Pen. Touching the reference points displayed on the projection surface with the Easy Interactive Pen enables operation on the projection surface using the Easy Interactive Pen.

Operation Steps

Using Easy Interactive Function for the first time

 p.56

It is only necessary to install the driver and perform calibration the first time.

1. Connect the computer cable and USB cable, and turn on the computer.



2. Install Easy Interactive Driver.



3. Turn on the projector and start Easy Interactive Driver.



4. Perform position alignment (calibration).

After calibration, Easy Interactive Function is ready for use.

From the second time

 p.59

You can use Easy Interactive Function by just starting Easy Interactive Driver.

You will need to perform calibration again when you use a computer with a different resolution or change the projection area.

System Requirements

For Windows

OS	Windows 2000 Service Pack 4 or later Windows XP Service Pack 2 or later (Home Edition/Professional) Windows Vista* (All editions except for Starter) Windows 7*
CPU	Pentium III 1.2GHz or faster Recommended: Pentium M 1.6GHz or faster
Amount of Memory	256MB or more
Hard Disk Free Space	100MB or more
Display	Resolution greater than XGA (1024x768)

* 32-bit versions only

For Mac OS

OS	Mac OS X 10.3.x Mac OS X 10.4.x Mac OS X 10.5.x Mac OS X 10.6.x
CPU	Power PC G3 900MHz or faster Recommended: Intel Core Duo 1.5GHz or faster
Amount of Memory	256MB or more
Hard Disk Free Space	100MB or more
Display	Resolution greater than XGA (1024x768)



Some settings on the computer may need to be changed to use the mouse function. See the documentation supplied with the computer.

Using Easy Interactive Function for the First Time

Procedure

- 1 Connect the projector and computer with the computer cable and USB cable.
- 2 Turn on the computer.
- 3 Install Easy Interactive Driver.



Check the following points before starting installation.

- Install the software as a user with administrator authority.
- Close all running applications and then start the installation.

For Windows

- (1) Insert the "EPSON Projector Software for Easy Interactive Function Ver.x.xx" CD-ROM into your computer.
The setup program starts automatically.
- (2) Select the language you want to use on the language selection screen, and click **Next** >.
- (3) Follow the on-screen instructions to install.
- (4) Select **Register to Startup** and **Launch Easy Interactive Driver Ver.x.xx**.
- (5) Click **Finish** to close the installer and automatically start Easy Interactive Driver.

For Mac OS

- (1) Insert the "EPSON Projector Software for Easy Interactive Function Ver.x.xx" CD-ROM into your computer.
- (2) Double-click **EIDriverV100_Setup** in the EPSON window.

- (3) Select **Start up.** and **Launch Easy Interactive Driver Ver.x.xx**.
*These two settings are not displayed in Mac OS 10.3.
- (4) Follow the on-screen instructions to install.
- (5) When **Finished** is displayed, the installer closes and Easy Interactive Driver starts automatically.



- When the setup program does not start automatically (Windows only)

Select **Start - Run** to open the **Run** dialog box, type the letter for your CD-ROM drive followed by `:\EIDriverVxxx_Setup.exe`, and then click **OK**.

- When Easy Interactive Driver does not start automatically

For Windows

Select **Start - Programs** (or **All Programs**) - **EPSON Projector - Easy Interactive Driver Ver.x.xx**.

For Mac OS

Double-click the Applications folder of the hard disk volume on which Easy Interactive Driver is installed, and then double-click the **Easy Interactive Driver** icon.

- When uninstalling Easy Interactive Driver

For Windows

Select **Start - Settings - Control Panel - Add-Remove Programs** or **Add or Remove Programs** and then remove **Easy Interactive Driver**.

For Mac OS

Run **EIDriverVxxx_Uninstaller** in the the hard disk volume on which Easy Interactive Driver is installed.

4 Turn on the projector.

Check the following when images are not projected.

- Change the projector's input source to Computer1 or Computer2. [p.21](#)

- Change the output destination for the video signals on the computer. [Computer's documentation](#)

Images are projected shortly after you make the changes.

Example of Changing Output			
Epson	Fn + F8	Macintosh	Make mirroring settings or perform display detection. Depending on the OS, the output can be changed with F7.
NEC	Fn + F8		
Panasonic			
SOTEC			
HP	Fn + F4		
Toshiba	Fn + F5		
Lenovo/IBM	Fn + F7		
SONY			
DELL	Fn + F8		
Fujitsu	Fn + F10		

On some computers, the display state changes as follows each time you press the keys for changing the output.

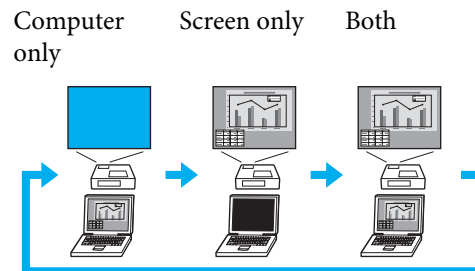

5 The connection status is indicated by an icon.

For Windows

The icon is displayed in the notification area of the taskbar.



For Mac OS

The icon is displayed in the Dock.

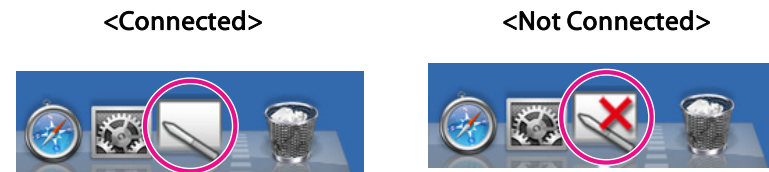

- It may take a few seconds for the icon to indicate the connection status.
- If the not connected icon is displayed, check whether or not the projector and computer are connected with the USB cable correctly. You may be able to resolve the problem by disconnecting and then reconnecting the USB cable.

6 Start calibration.

Check that the icon is indicating the connected status.
 Perform calibration with either **Calibrate (Normal)** (number of points: 25) or **Calibrate (Advanced)** (number of points: 49).
 We recommend that you normally use the **Calibrate (Normal)**. Select **Calibrate (Advanced)** when higher accuracy is required.

For Windows

Click the icon in the notification area of the taskbar, and select an item from the menu that is displayed.

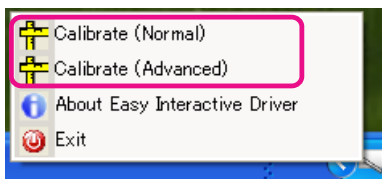

For Mac OS

Click the icon in the Dock or **Calibrate** on the menu bar, and select an item from the menu that is displayed.

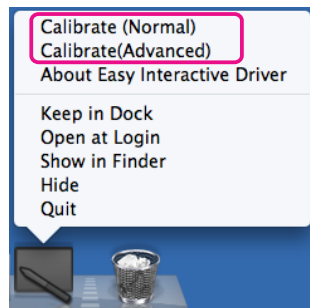



For details on calibration, see  "Calibration" p.61.

7 Click "OK" when the calibration start message is displayed.

8 A dot flashes in the top left of the screen.

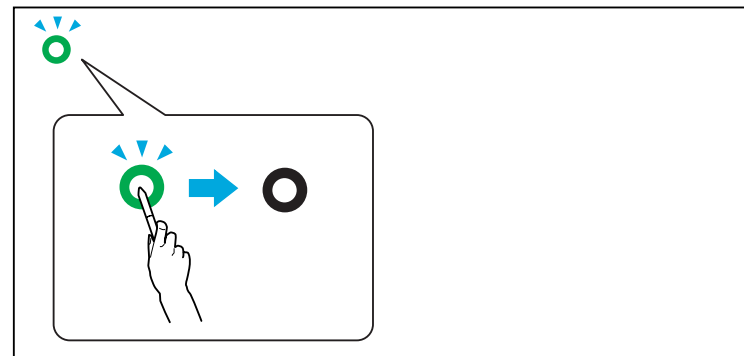
If you touch the center of the dot with the tip of the Easy Interactive Pen, the dot changes from flashing to lit.



Using Easy Interactive Pen  p.18



Make sure you touch the center of the dot. The dot changes from flashing to lit even if you touch an area outside of the circle. Since calibration is performed using the position touched, positioning may be offset if you touch an area other than the center of the circle.

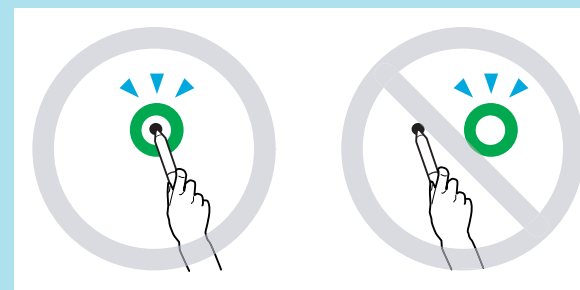

9 The dots are displayed in order from the top left to bottom right of the screen.

Repeat step 9 until all of the dots are lit.

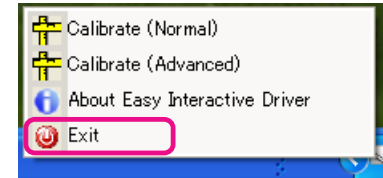
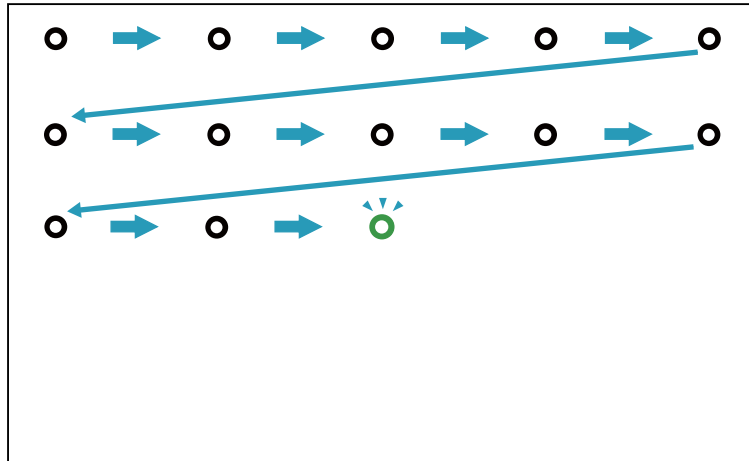

For Mac OS

Click the icon in the Dock or Easy Interactive Driver on the menu bar, and select **Quit** from the menu that is displayed.

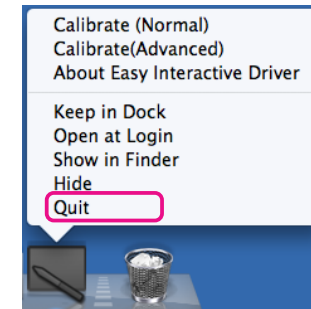

It may take a few seconds for the **Easy Interactive Driver** icon to change to connected status after all of the dots are lit.

10

After calibration, you can use the **Easy Interactive Pen** to perform the same operations as a mouse on the projection surface.

11

Use the following procedure to end the **Easy Interactive Function**.

For Windows

Click the icon in the notification area of the taskbar, and select **Exit**.

Using Easy Interactive Function from the Second Time

Procedure

1

Turn on the projector and computer.

Check that the projector and computer are connected with the computer cable and USB cable.

2 Easy Interactive Driver starts automatically.

Use the following procedure to start Easy Interactive Driver if it does not start.

For Windows

Select **Start - Programs** (or **All Programs**) - **EPSON Projector - Easy Interactive Driver Ver.x.xx**.

For Mac OS

Double-click the Applications folder of the hard disk volume on which Easy Interactive Driver is installed, and then double-click the **Easy Interactive Driver** icon.

3 The connection status is indicated by an icon.

For Windows

The icon is displayed in the notification area of the taskbar.

<Connected>



<Not Connected>



For Mac OS

The icon is displayed in the Dock.

<Connected>



<Not Connected>



After the projector and computer are connected, you can use Easy Interactive Pen to perform the same operations as a mouse on the projection surface.



- It may take a few seconds for the icon to indicate the connection status.
- If the not connected icon is displayed, check whether or not the EB-460i/450Wi and computer are connected with the USB cable correctly.
You may be able to resolve the problem by disconnecting and then reconnecting the USB cable.

4

Use the following procedure to end the Easy Interactive Function.

For Windows

Click the icon in the notification area of the taskbar, and select **Exit**.

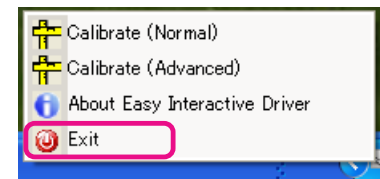

For Mac OS

Click the icon in the Dock or Easy Interactive Driver on the menu bar, and select **Quit** from the menu that is displayed.

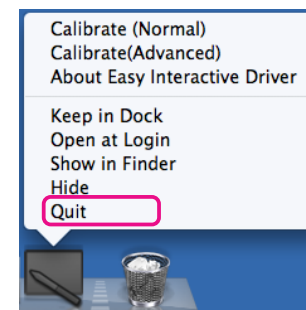

Calibration

To use Easy Interactive Function, you need to make sure you perform calibration to align the pen position on the screen and the mouse position on the projection screen with the Easy Interactive Pen.

There are two calibration modes: Calibrate (Normal) and Calibrate (Advanced).

Specify 25 points with the Calibrate (Normal), and 49 points with the Calibrate (Advanced).

Make sure you perform calibration the first time you use Easy Interactive Function. After that, you only need to perform calibration if the usage environment changes, for example if the connected computer is changed or the projection area is changed.

Cases in which calibration is required

In the following cases, the positioning of the Easy Interactive Pen on the projection surface and the mouse on the computer may be offset. When position offset becomes a problem, perform calibration again.

- When the computer's resolution is changed.
- When a computer with a resolution that differs from the last time calibration was performed is connected.
- When Keystone is performed from the Settings Menu in the Configuration Menu.
- When Zoom is changed from the Settings Menu in the Configuration Menu.
- When Auto Setup is performed from the Signal menu in the Configuration Menu.
- When Resolution is changed from the Signal menu in the Configuration Menu.
- When Tracking is changed from the Signal menu in the Configuration Menu.

- When Sync. is changed from the Signal menu in the Configuration Menu.
- When Position is changed from the Signal menu in the Configuration Menu.
- When Aspect is changed from the Signal menu in the Configuration Menu.
- When input detection is performed automatically.
- When position offset becomes a problem for other reasons.



- If you set Projection to Rear/Ceiling from the Extended menu in the Configuration Menu, Easy Interactive Function cannot be used because the pen position and mouse position will not match.
- The pen position and mouse position will not match while E-Zoom is being used.
- When you use Easy Interactive Function while images are projected with EasyMP Network Projection (input source: LAN), set **USB Type B** to **Wireless Mouse** or **Off** from the **Extended** menu in the Configuration Menu.

Replacing the Batteries for the Easy Interactive Pen

When the button is pressed, the indicator for the Easy Interactive Pen turns on. If it does not turn on, the batteries are out of power and need to be replaced. Have two AAA size alkaline batteries ready. For details on other batteries that can be used, contact your local dealer or the nearest address provided in the Support and Service Guide.

 [Epson Projector Contact List](#)

Attention

Make sure you read the separate Safety Instructions before handling the batteries.  [Safety Instructions](#)

Procedure

1 Remove the battery cover.

While pushing the battery cover catch, lift the cover up.

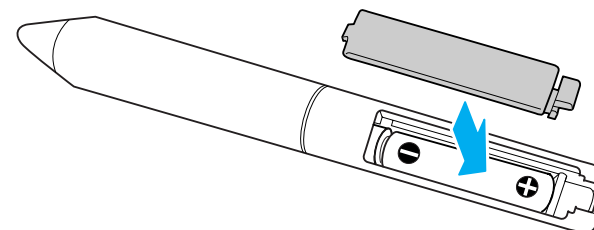
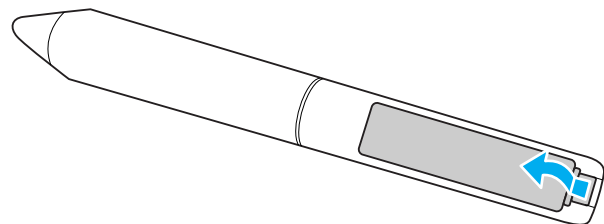

2 Replace the old batteries with new batteries.

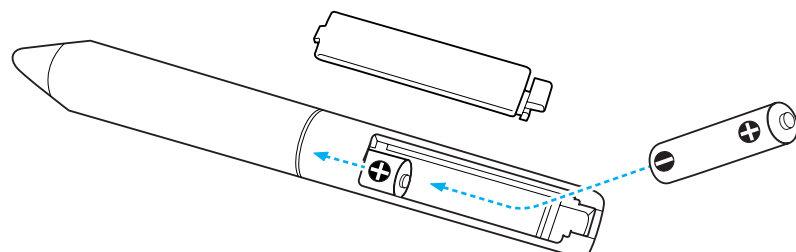

Caution

Check the positions of the (+) and (-) marks inside the battery holder to ensure the batteries are inserted correctly.

3 Reattach the battery cover.

Press the battery cover until it clicks into place.

You can make Configuration Menu settings and control the projector by using the Web browser of a computer that is connected to the projector via a network. By using this function you can perform setup and control operations remotely. In addition, since you can use the computer's keyboard, entering characters required for the setup is easier.

Use Microsoft Internet Explorer 6.0 or later as the Web browser. If you are using Mac OS, you can also use Safari.



If you set **Standby Mode** to **Communication On** from the **Extended** menu in the projector's Configuration Menu, you can use the Web browser to make settings and perform control even if the projector is in a standby state (when the power is off).

Some items cannot be set with a Web browser (but can be from the Configuration Menu) and some items can only be set with a Web browser.

Items in the Configuration Menu that cannot be set with a Web browser

All items in the projector's Configuration Menu can be set except for the following.

- Settings Menu - Pointer Shape
- Settings Menu - Pattern
- Settings Menu - User Button
- Extended Menu - Saving User's Logo
- Extended Menu - Language
- Extended Menu - Operation - High Altitude Mode
- Reset Menu - Reset All, and Reset Lamp Hours
- Password Protect Menu

The items available in each menu are the same as the Configuration Menu of the projector.

☛ "List of Functions" [p.74](#)

Items that can only be set with a Web browser

The following items can only be set with a Web browser. They cannot be set from the Configuration Menu.

- Network settings- Others - SNMP - Community Name
- Network settings- Basic - Monitor Password

Displaying Web Control

Use the following procedure to display Web Control.



If your Web browser is set to connect via a proxy server, Web Control cannot be displayed. To display Web Control, you need to make settings so that a proxy server is not used for a connection.

Entering the IP address of the projector

When you are using Advanced Connection Mode, you can open Web Control by specifying the IP address of the projector as follows.

Procedure



Start the Web browser on the computer.



Enter the IP address of the projector in the address input box of the Web browser, and press the Enter key on the computer's keyboard.

Web Control is displayed.

When Web Control Password is set from the Network menu in the Configuration Menu, a screen for entering the password is displayed. Enter the characters set for the Web Control Password.

Displaying Web Remote

The Web Remote function allows you to perform projector remote control operations with a Web browser.

Procedure

1 Display Web Control.





2 Click Web Remote.

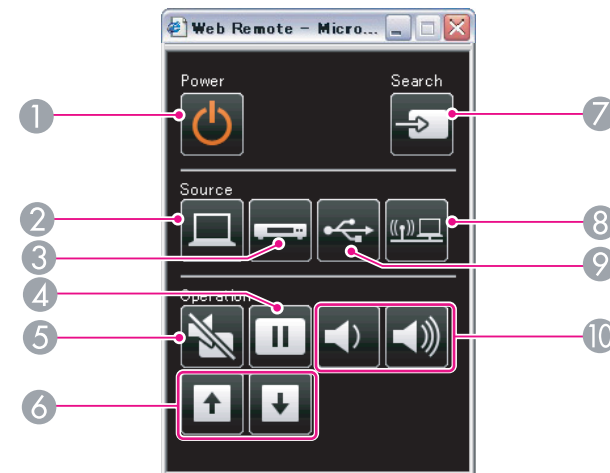

3 The Web Remote screen is displayed.



	Name	Function
1	[Power] button	Turns the projector power On or Off. ☞ Quick Start Guide
2	[Computer] button	Each time you press the button, input changes between images from the Computer1 input port and the Computer2 input port. ☞ p.22
3	[Video] button	Each time you press the button, input changes between images from the Video input port and the S-Video input port. ☞ p.22
4	[Freeze] button	Pauses or resumes image playback. ☞ p.41
5	[A/V Mute] button	Temporarily turns the images and audio on or off. ☞ p.40
6	[Page] buttons ([Up]) ([Down])	When you are using the Wireless Mouse function or the input source is projecting a file from an application that supports page up/down via LAN, you can move the page up and down by pressing these buttons. ☞ p.48 , EasyMP Network Projection Operation Guide
7	[Source Search] button	Changes to images from the next device inputting an image signal. ☞ p.21

Name	Function
<p>8 [LAN] button</p>	<p>Changes to the images projected with EasyMP Network Projection. When you are projecting via Quick Wireless Connection using the optional Quick Wireless Connection USB Key, this button changes to that image.  p.22</p>
<p>9 [USB] button</p>	<p>Each time you press the button, input changes between images from the equipment connected to USB Display and USB(TypeA) port.  p.22</p>
<p>10 [Volume] buttons (◀) (▶)</p>	<p>(◀) Decreases the Volume. (▶) Increases the Volume.  <i>Quick Start Guide</i></p> <div style="border: 1px solid black; padding: 5px; margin-top: 10px;"> <p> Caution</p> <p><i>Do not increase the volume too high at the start. A sudden increase in volume may cause loss of hearing. Always lower the volume before turning the power off, and gradually increase the volume after turning the power on.</i></p> </div>

By setting the Mail Notification function from the projector's Configuration Menu, notification messages will be sent to the preset email addresses when a problem or warning occurs with a projector. This will enable the operator to be notified of problems with projectors even at locations away from the projectors.

☛ "Network Menu" p.80, "Mail menu" p.87



- Up to a maximum of three notification destinations (Addresses) can be recorded, and notification messages can be sent to all three destinations at once.
- If a projector develops a critical problem and suddenly stops working, it may not be able to send a message notifying an operator of the problem.
- Monitoring is possible if **Network On** is set from the **Extended** menu of the projector's Configuration Menu, even if the projector is in **Standby Mode** (when the power is off).

By setting SNMP from the projector's Configuration Menu, notification messages are sent to preset e-mail addresses when a problem or warning occurs with a projector. This also enables you to know about errors when centrally managing projectors at a distance.

☛ "Network Menu" [p.80](#), "Mail menu" [p.87](#)



- SNMP should be managed by a network administrator or someone who is familiar with the network.
- The SNMP function to monitor projectors requires SNMP Manager to be installed on the computer.
- The managing function using SNMP cannot be used via a Wireless LAN in Quick Connection Mode.
- Up to two destination IP addresses can be saved.

You can save the image that is currently being projected as a User's Logo.



When a User's Logo is saved, the previous User's Logo is erased.

Procedure

- 1 Project the image you want to save as the User's Logo, and then press the [Menu] button.

Using Remote Control

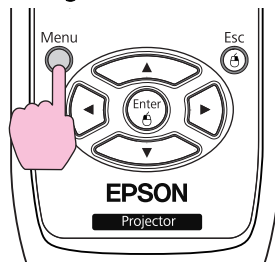

Using Control panel

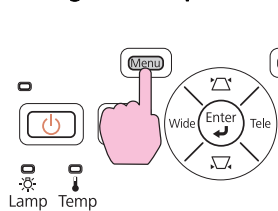

- 2 Select User's Logo from the Extended menu in the Configuration Menu.  "Using the Configuration Menu" p.73

Check the buttons you can use and the operations they perform in the guide under the menu.

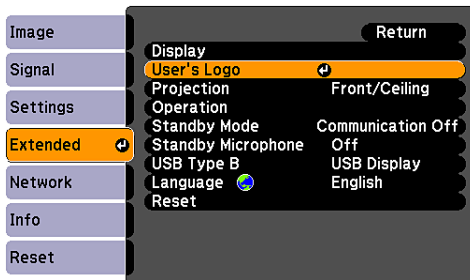

[Esc] :Return [◀] :Select [Enter] :Enter [Menu] :Exit



- When **User's Logo Protect** from **Password Protect** is set to **On**, a message is displayed and the User's Logo cannot be changed. You can make changes after setting **User's Logo Protect** to **Off**.  p.50
- If **User's Logo** is selected when one of the Keystone, E-Zoom, Aspect, Progressive, and Zoom Adjustment functions is being used, the function currently being used is cancelled temporarily.

- 3 When the message "Choose this image as the User's Logo?" is displayed, select Yes.



When you press the [Enter] button on the remote control or the control panel, the screen size may change depending on the signal to match the actual resolution of the image signal.

- 4 Move the box to select the part of the image to use as the User's Logo.

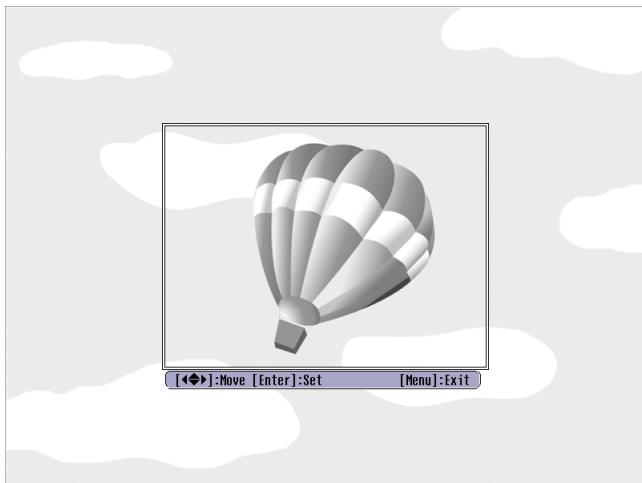

Using Remote Control

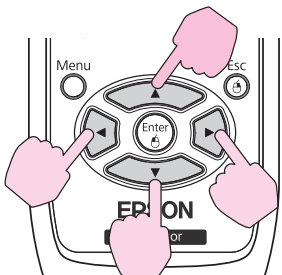

Using Control panel

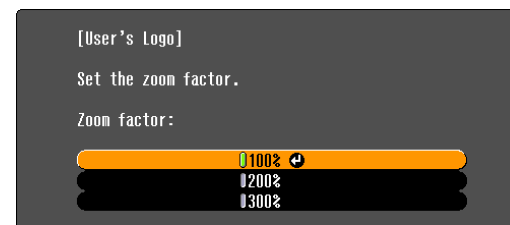
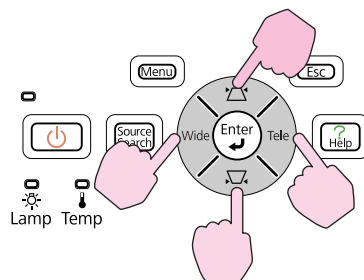

[Esc]:Return [◆]:Select [Enter]:Set [Menu]:Exit

7

When the message "Save this image as the User's Logo?" is displayed, select Yes.

The image is saved. After the image has been saved, the message "Completed." is displayed.



- Once a User's Logo has been saved, the logo cannot be returned to the factory default.
- Saving the user's logo may take approximately 15 seconds. Do not use the projector or any connected equipment while it is saving, otherwise malfunctions may occur.



You can save at a size of 400x300 dots.

5

When the message "Select this image?" is displayed, select Yes.

6

Select the zoom factor from the zoom setting screen.

You can save the image that is currently being projected as a User Pattern.

 When a User Pattern is saved, the previous User Pattern is erased.

Procedure

- 1 Project the image you want to use as the User Pattern, and then press the [Menu] button.**

Using Remote Control

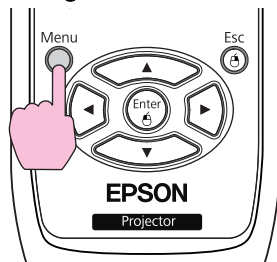

Using Control panel

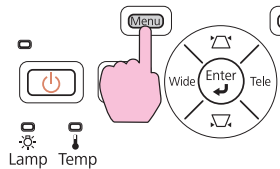

- 2 Select Pattern from the Settings Menu in the Configuration Menu. "Using the Configuration Menu" p.73**

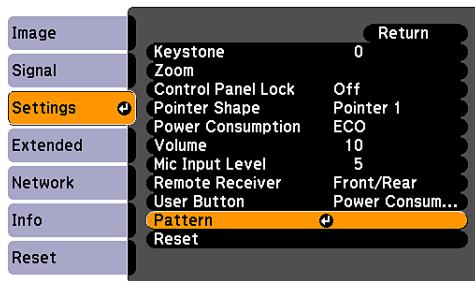

[Esc]:Return [↵]:Select [Enter]:Enter [Menu]:Exit

- 3 Select User Pattern.**

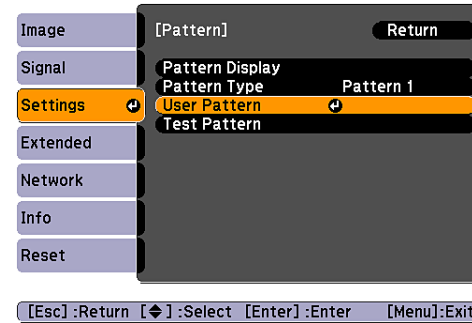



If **User Pattern** is selected when one of the Keystone, E-Zoom, Aspect, Progressive, and Zoom Adjustment functions is being used, the function currently being used is cancelled temporarily.

4

When "Do you want to use the currently projected image as the User Pattern?" is displayed, select Yes.

- You can save at a size of up to the projector screen size.
- When part of the projected image is missing (when the computer screen is larger than the projection screen), move the displayed box to select the part of the image to use as the User Pattern.

When **"Select this image?"** is displayed after you make a selection, select **Yes**.

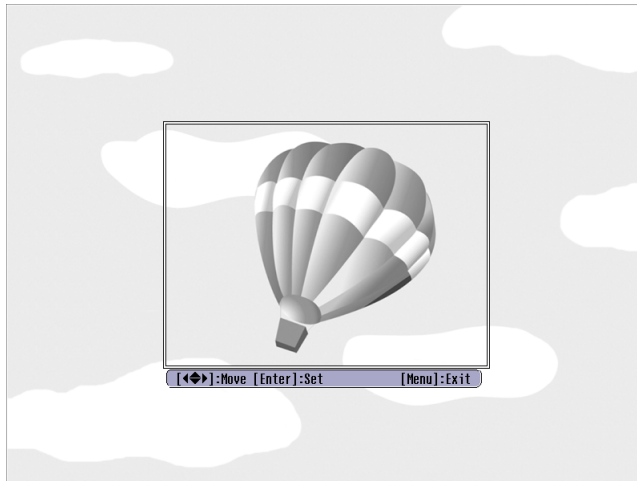

Using Remote Control

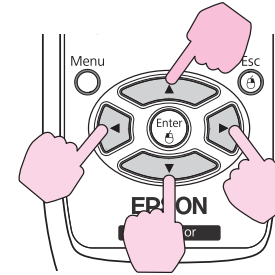

Using Control panel

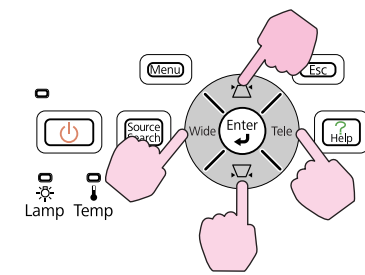

- When you press the [Enter] button on the remote control or the Control panel, the screen size may change depending on the signal to match the actual resolution of the image signal.

5

When the message "Save this image as the User Pattern?" is displayed, select Yes.

The image is saved. After the image has been saved, the message **"The User Pattern setting is complete."** is displayed.



- Once a User Pattern has been saved, User Pattern cannot be returned to the factory default.
- Saving the User Pattern may take approximately 15 seconds. Do not use the projector or any connected equipment while it is saving, otherwise malfunctions may occur.



Configuration Menu

This chapter explains how to use the Configuration Menu and its functions.

- 1 Selecting from the top menu
- 2 Selecting from the sub menu
- 3 Changing the selected item
- 4 Exit

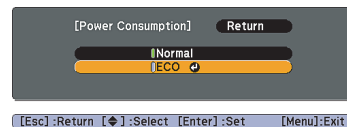
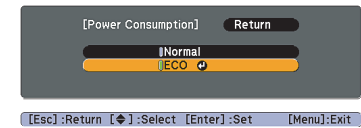
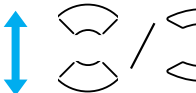
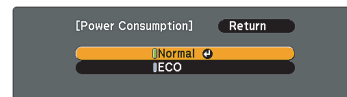
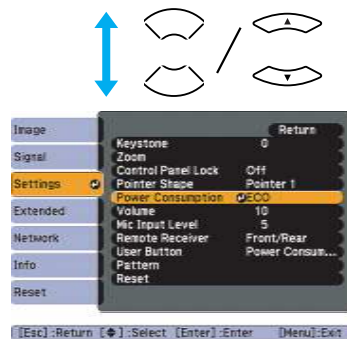
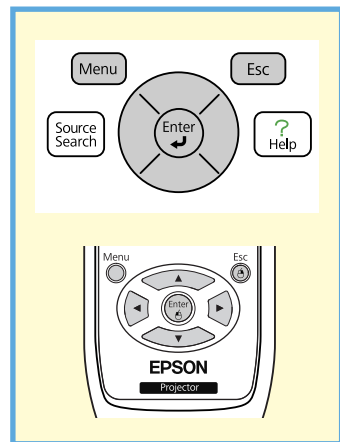
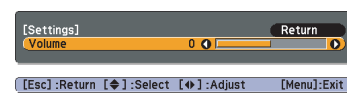
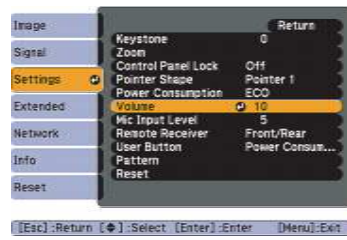
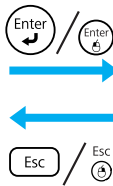
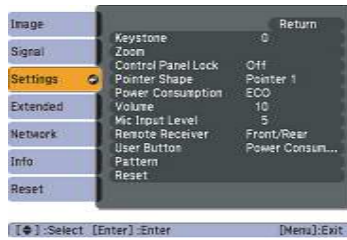
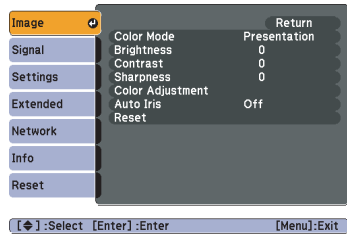

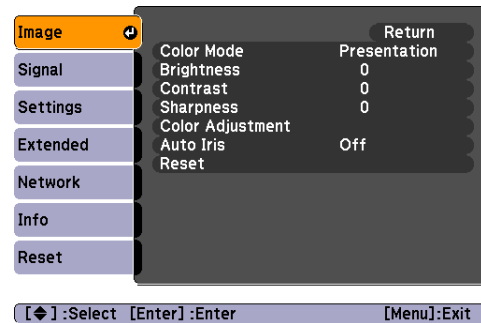

Image Menu

Items that can be set vary depending on the image signal and Source currently being projected as shown in the following screen shots. Setting details are saved for each image signal and Source.



Depending on the model used, some input sources are not supported.  p.21

Computer Signal/USB/USB Display/LAN

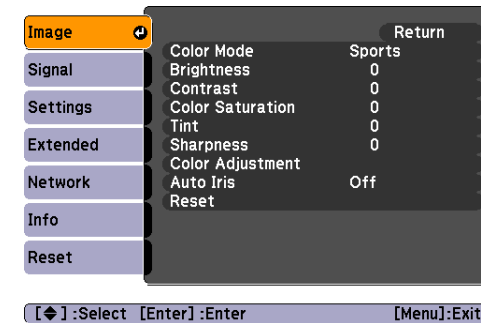

Component Video▶▶/Composite video▶▶/S-Video▶▶



Sub Menu	Function
Color Mode	You can select the quality of the image to suit your surroundings.  p.39
Brightness	You can adjust the image Brightness.
Contrast▶▶	You can adjust the difference between light and shade in the images.
Color Saturation	You can adjust the Color Saturation for the images.
Tint	(Adjustment is only possible when NTSC signals are being input if you use composite video/S-Video.) You can adjust the image Tint.
Sharpness	You can adjust the image sharpness.
Color Adjustment	You can make adjustments by choosing one of the following. (This item cannot be selected if the adjustment value of Color Mode is set to sRGB▶▶ from the Image menu.) Abs. Color Temp.: You can adjust the overall tint of the image. You can adjust tints in 10 stages from 5000 K to 10000 K. When a high value is selected the image becomes tinged with blue, when a low value is selected the image becomes tinged with red. Red, Green, Blue: You can adjust the saturation of each color individually.
Auto Iris	(This item is only displayed if the adjustment value of Color Mode is set to Dynamic or Theatre from the Image menu.) Set whether or not (On/Off) to adjust the iris to obtain the optimal light for the images.  p.40



Sub Menu	Function
Reset	You can reset all adjustment values of the Image menu to their default settings. To return all menu items to their default settings, see  p.91

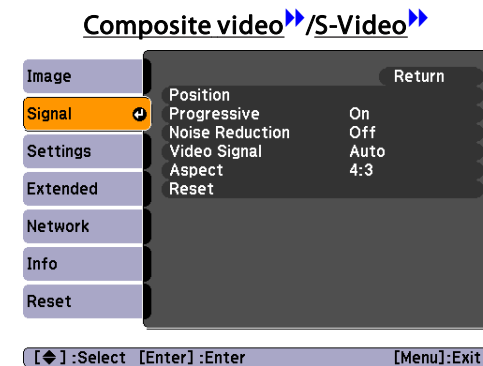
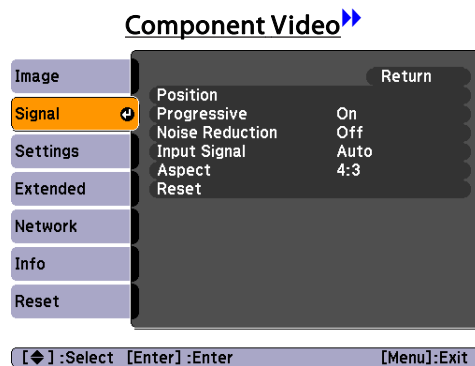
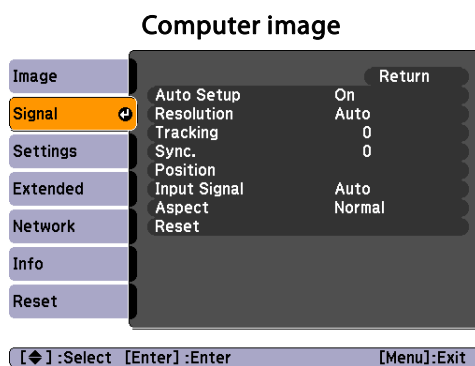

Signal Menu

Items that can be set vary depending on the image signal currently being projected as shown in the following screen shots. Setting details are saved for each image signal.

You cannot make settings in the **Signal** menu when the input source is LAN.









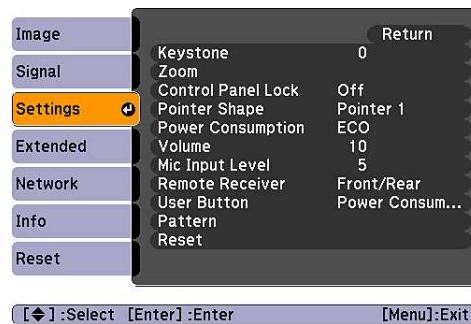





Sub Menu	Function
Auto Setup	You can select whether or not (On/Off) to automatically adjust the image to the optimal state when the input signal changes.  p.100
Resolution	When set to Auto , the resolution of the input signal is automatically identified. If the images cannot be projected correctly when set to Auto , such as when some of the image is missing, adjust to Wide depending on the connected computer for wide screens, or set to Normal for 4:3 or 5:4 screens.
Tracking	You can adjust computer images when vertical stripes appear in the images.  p.100
Sync.	You can adjust computer images when flickering, fuzziness, or interference appear in the images.  p.100
Position	You can adjust the display Position up, down, left, and right when a part of the image is missing so that the whole image is projected.
Progressive	(Component Video can only be set when 480i/576i/1080i signals are being input) Off: IP conversion is carried out for each field in the screen. This is ideal for viewing images with a large amount of movement. Video: This is ideal for viewing general video images. Film/Auto: This is ideal for movie films, computer graphics, and animation.

Sub Menu	Function
Noise Reduction	Smoothes out rough images. There are two modes. Select your favorite setting. Set this to Off when viewing image sources in which noise is very low, such as DVDs.
Input Signal	You can select an input signal from Computer1/2 input port. If this is set to Auto , the input signal is set automatically depending on the connected equipment. If colors do not appear correctly when this is set to Auto , select the appropriate signal depending on the connected equipment.
Video Signal	You can select the input signal from the Video input port. If set to Auto , video signals are recognized automatically. If interference appears in the image or a problem occurs such as no image is being projected when set to Auto , select the appropriate signal depending on the connected equipment.
Aspect	You can set the <u>Aspect Ratio</u> for projected images.  p.41
Reset	You can reset all adjustment values in the Signal menu to their default settings, except for Input Signal . To return all menu items to their default settings, see  p.91

Settings Menu





Sub Menu	Function
Keystone	You can correct keystone distortion in the vertical direction.  <i>Quick Start Guide</i>
Zoom	You can adjust Tele/Wide.
Control Panel Lock	You can use this to restrict operation of the projector's Control panel.  p.52
Pointer Shape	You can select the shape of the pointer.  p.46 Pointer 1:  Pointer 2:  Pointer 3: 

Sub Menu	Function
Power Consumption	<p>You can set the Lamp brightness to one of two settings.</p> <p>Select ECO if the images being projected are too bright such as when projecting images in a dark room or onto a small screen. When ECO is selected, power consumption during projection and the lamp life change as follows, and fan rotation noise is reduced. Electrical consumption: about 25% decrease, lamp life: about 1.4 times longer</p>
Volume	<p>You can adjust the Volume. Setting details are saved for each image signal.</p>
Mic Input Level	<p>Adjust this if the microphone input level is low and the microphone audio output from the projector's speaker is difficult to hear, or if the input level is too high, resulting in a crackling sound in the audio from the microphone. When Mic Input Level is turned down to 0, no microphone audio is output from the speaker.</p>
Remote Receiver	<p>You can limit the reception of the operation signal from the Remote Control.</p> <p>When you want to prohibit operation by Remote Control, or if the Remote Receiver has a fluorescent light too close to it, you can make settings to deactivate the remote receiver you do not want to use or that is experiencing interference.</p>
User Button	<p>You can select the item from the Configuration Menu with the Remote Control's User Button. By pressing the User Button the assigned menu item selection/adjustment screen is displayed, allowing you to make one-touch settings/adjustments. You can assign one of the following items to the User Button.</p> <p>Power Consumption, Info, Progressive, Test Pattern, Resolution, Mic Input Level, and Pattern Display</p>
Pattern	<p>Pattern Display: Display a pattern.</p> <p>Pattern Type: You can select from Patterns 1 to 4 or User Pattern. Patterns 1 to 4 display projection lines such as ruled lines or a grid.</p> <p>Pattern 1:  Pattern 2:  Pattern 3:  Pattern 4: </p> <p>User Pattern: Captures a user pattern.  p.70</p> <p>Test Pattern: When the projector is set up, a test pattern is displayed so that you can adjust the projection status without connecting equipment. While the Test Pattern is displayed, zoom, focus adjustments, and Keystone correction can be performed. To cancel the Test Pattern, press the [Esc] button on the Remote Control or the Control panel.</p> <div style="border: 1px solid black; background-color: #e0f2f7; padding: 10px; margin-top: 10px;"> <p>Attention</p> <p><i>If a pattern is displayed for a long time, a residual image may be visible in projected images.</i></p> </div>
Reset	<p>You can reset all adjustment values in the Settings Menu to their default settings, except for User Button.</p> <p>To return all menu items to their default settings, see  p.91</p>

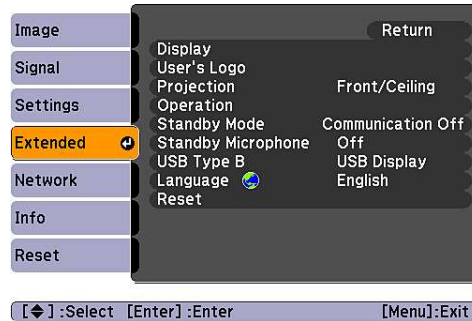
Extended Menu



Sub-menu	Function
Display	<p>You can make settings related to the projector's display.</p> <p>Messages: You can set whether or not (On/Off) to display the Source name when you change the Source, the Color Mode name when you change the Color Mode, a message when no image signal is input, and so on.</p> <p>Display Background*1: You can set the screen status for when no image signal is available to Black, Blue, or Logo.</p> <p>Startup Screen*1: You can set whether or not (On/Off) to display the startup screen (the image projected when starting the projector) at startup.</p> <p>A/V Mute*1: You can set the screen displayed during A/V Mute to Black, Blue, or Logo.</p>
User's Logo*1	You can change the User's Logo that is displayed as a background during Display Background, A/V Mute, and so on.  p.68
Projection	<p>You can set from the following according to the way the projector is setup.  p.20</p> <p>Front/Ceiling, Rear/Ceiling</p>
Operation	<p>Direct Power On: You can set whether or not (On/Off) to enable Direct Power On. When this is set to On and the power cable is plugged in, note that the projector turns automatically in cases such as a power outage being restored.</p> <p>Sleep Mode: When set to On, this automatically stops projection when no image signal is being input and no operations are carried out.</p> <p>Sleep Mode Timer: When Sleep Mode is set to On, you can set the time before the projector automatically turns off within a range of 1 to 30 minutes in one minute increments.</p> <p>High Altitude Mode: Set to On when using the projector above an altitude of 1500 m.</p>

Sub-menu	Function
Standby Mode	<p>You can use the following functions even when the projector is in standby mode if this is set to Communication On.</p> <ul style="list-style-type: none"> • Monitor and control the status of the projector over the network. • The microphone input function outputs audio from the projector's speaker when a microphone is connected to the Microphone (Mic) input port. <p>You can use SNMP or the application software "EasyMP Monitor" supplied with this product to monitor and control the status of the projector over the network.</p> <p>The microphone input is also enabled if this setting is set to Communication On and Standby Microphone is set to On.</p>
Standby Microphone	<p>(Only available when the Standby Mode mentioned above is set to Communication On)</p> <p>When Standby Mode is set to Communication On, set whether microphone input is enabled (On) or disabled (Off).^{*2}</p>
USB Type B	<p>Set this to USB Display when the projector and a computer are connected with a USB cable and computer images are projected.</p> <p>☛ <i>Quick Start Guide</i></p> <p>Set this to Wireless Mouse when the mouse pointer is to be operated by the remote control. ☛ p.48</p> <p>Set this to Off when using only Easy Interactive Function (EB-460i/450Wi only). ☛ p.54</p>
Language	<p>You can set the Language to use for displaying messages and menus.</p>
Reset	<p>You can return the adjustment values for Display^{*1} and Operation^{*3} in the Extended menu to their default settings.</p> <p>To return all menu items to their default settings, see ☛ p.91</p>

*1 When **User's Logo Protect** in **Password Protect** is set to **On**, settings related to User's Logo cannot be changed. You can make changes after setting **User's Logo Protect** to **Off**. ☛ [p.50](#)

*2 When **Power On Protect** in **Password Protect** is set to **On**, microphone input is not possible even when **Standby Microphone** is set to **On**.

*3 Except for "High Altitude Mode".

Network Menu

When **Network Protect** in **Password Protect** is set to **On**, a message is displayed and the settings cannot be changed. You can make changes after setting **Network Protect** to **Off**.  [p.50](#)

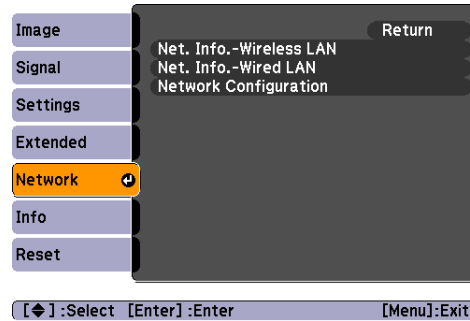

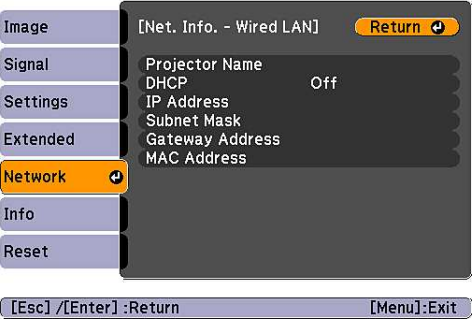
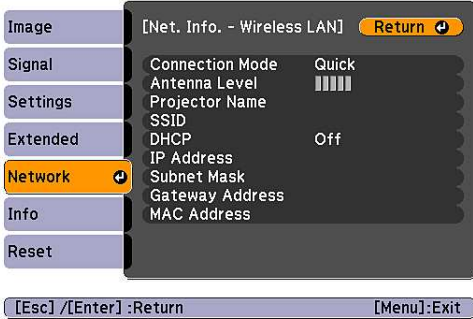
Sub-menu	Function
<p>Network Information</p>	<p>You can confirm the setting status for each network as follows.</p> <div style="display: flex; justify-content: space-around;"> <div data-bbox="779 847 1249 1166">  </div> <div data-bbox="1361 847 1832 1166">  </div> </div>
<p>Network Configuration</p>	<p>The following menus are available for setting Network items. Basic Menu, Wireless LAN Menu, Security Menu, Wired LAN Menu, Mail Menu, Others Menu, Reset Menu, Setup complete Menu</p>



By using the Web browser of a computer connected to the projector on a network, you can set the functions and control the projector. This function is called Web Control. You can easily enter text using a keyboard to make settings for Web Control such as Security settings.  [p.63](#)

Notes on using the Network menu

Select items from the top menu and sub menus and change selected items in the same way as in the Configuration Menu.

However, when you have finished, make sure you select the **Setup complete** menu, and select one of **Yes**, **No**, or **Cancel**. When you select **Yes** or **No**, you return to the Configuration Menu.

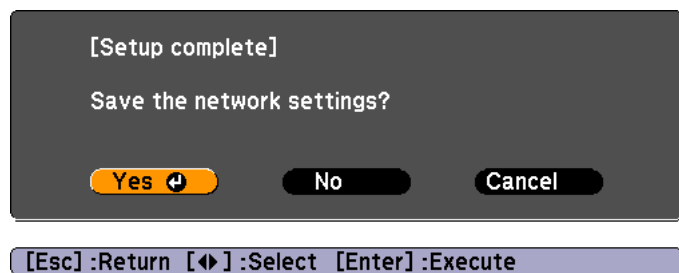









Yes: Saves the settings and closes the Network menu.

No: Does not save the settings and closes the Network menu.

Cancel: Continues displaying the Network menu.

Soft keyboard operations

The Network menu contains items that require you to enter alphanumeric characters when you set them. In this case, the following software keyboard is displayed. Use the [][][][] buttons on the Remote Control or the [], [], [], and [] buttons on the Control panel to move the cursor to the desired key, and then press the [Enter] button to enter the alphanumeric. Enter figures by holding down the [Num] button on the Remote Control, and pressing the numeric buttons. After inputting, press [Finish] on the keyboard to confirm your input. Press [Cancel] on the keyboard to cancel your input.

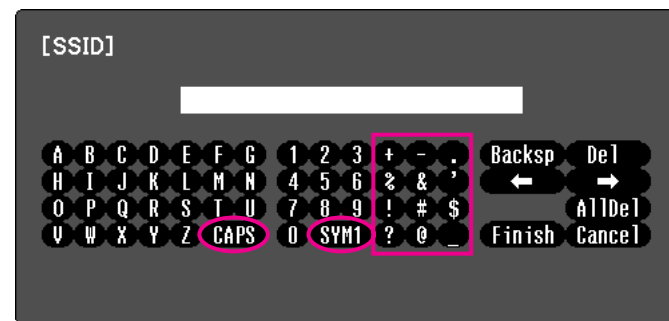



Each time the [CAPS] key is selected, it sets and changes between upper case and lower case letters.

Each time the [SYM1/2] key is selected, it sets and changes the symbol keys for the section enclosed by the frame.

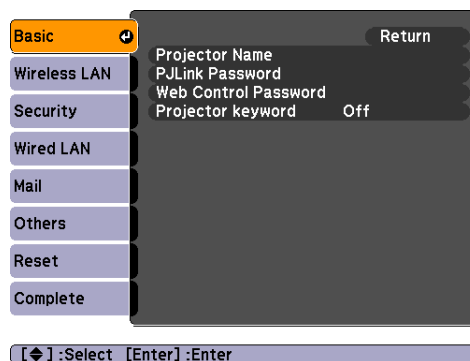
Basic Menu



Sub Menu	Function
Projector Name	Displays the projector name used to identify the projector when connected to a Network. When editing, you can enter up to 16 single-byte alphanumeric characters.
PJLink Password	Set a Password to use when you access the projector using compatible PJLink software.  p.123 You can enter up to 32 single-byte alphanumeric characters.
Web Control Password	Set a password to use when making settings and controlling the projector using Web Control. You can enter up to 8 single-byte alphanumeric characters. Web Control is a computer function that allows you to set up and control the projector by using the Web browser on a computer connected on a Network.  p.63
Projector Keyword	When this is set to On , you are requested to enter the Keyword when you attempt to connect the projector and a computer via a network. As a result, EasyMP Network Projection can prevent presentations from being interrupted by unscheduled connections from a computer during projection. Normally, set this to On .  EasyMP Network Projection Operation Guide "Connecting to a Projector on a Network and Projecting"

Wireless LAN Menu

Settings are enabled when the optional Wireless LAN unit is installed.

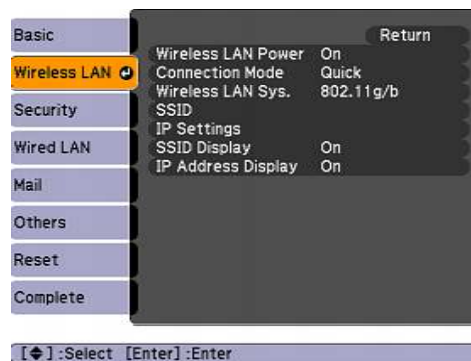

Sub Menu	Function
Wireless LAN Power	Set this to On when connecting the projector and a computer via a wireless LAN. If you do not want to connect via a wireless LAN, set this to Off to prevent unauthorized access by others. This is set to On by default.
Connection Mode	Use EasyMP Network Projection to set the mode, how the computer connect to the projector. Set this to Quick Connection Mode when you want to make a simple wireless connection. Set this to Advanced Connection Mode when you want to connect to a network system via an access point.
Wireless LAN system	Sets the Wireless LAN system.
SSID ▶▶	Enter an SSID. When an SSID is provided for the wireless LAN system in which the projector will participate, enter the SSID. You can enter up to 32 single-byte alphanumeric characters.
IP Settings	You can make settings related to the following addresses. DHCP ▶▶: Set whether or not (On/Off) to use DHCP. If this is set to On , you cannot set any more addresses. IP Address ▶▶: You can input the IP Address assigned to the projector. You can input a number from 0 to 255 in each field of the address. However, the following IP Addresses cannot be used. 0.0.0.0, 127.x.x.x, 224.0.0.0 to 255.255.255.255 (where x is a number from 0 to 255) Subnet Mask ▶▶: You can input the Subnet Mask for the projector. You can input a number from 0 to 255 in each field of the address. However, the following Subnet Masks cannot be used. 0.0.0.0, 255.255.255.255 Gateway Address ▶▶: You can input the IP Address for the gateway for the projector. You can input a number from 0 to 255 in each field of the address. However, the following Gateway Addresses cannot be used. 0.0.0.0, 127.x.x.x, 224.0.0.0 to 255.255.255.255 (where x is a number from 0 to 255)

Sub Menu	Function
SSID Display	To prevent the SSID from being displayed on Network Info in the Network menu and on the LAN Standby screen, set this to Off .
IP Address Display	To prevent the IP address from being displayed on Network Info in the Network Menu and on the LAN Standby screen, set this to Off .

Security menu

Settings are enabled when the optional Wireless LAN unit is installed.



Sub-menu	Function
Security	<p>Select one type of security from the following items.</p> <p>When setting security, follow the instructions from the administrator of the network system you are about to access. When using Advanced Connection Mode, be sure to make security settings.</p> <p>WEP: An encryption key (WEP key) is used to encrypt data. This mechanism prevents communication unless the encryption keys for the access point and the projector match.</p> <p>WPA/WPA2: This is an encryption standard that improves security, which is considered a weak point of WEP. Although there are multiple kinds of WPA encryption methods, this projector uses "TKIP" and "AES".</p> <p>WPA also includes user authentication functions. WPA authentication provides two methods: using an authentication server, or authenticating between a computer and an access point without a using server. This projector supports the latter method, without a server.</p>

When WEP is selected

You can set the following items.

Sub Menu	Function
WEP encryption	You can set the encryption method for WEP encryption. 128bit: Uses 128 (104) bit encoding 64bit: Uses 64 (40) bit encoding
Format	You can set the input method for the WEP encryption key. ASCII: Input in text. HEX: Input in HEX (hexadecimal).
Key ID	You can select the WEP encryption ID key.
Encryption key 1 Encryption key 2 Encryption key 3 Encryption key 4	You can enter the key used for WEP encryption. Enter the key in single-byte characters, following the instructions from the network administrator for the network in which the projector will participate. The type and number of characters that can be entered differ depending on the WEP encryption and Format settings. If the number of characters you enter is shorter than the required character length, or if the number of characters you enter is longer than the required character length, it does not connect. 128bit - ASCII: Single-byte alphanumeric characters, 13 characters. 64bit - ASCII: Single-byte alphanumeric characters, 5 characters. 128bit - HEX: 0 to 9 and A to F, 26 characters 64bit - HEX: 0 to 9 and A to F, 10 characters
Authentication Type	Set the WEP authentication type. Open: Uses open system authentication. Shared: Uses shared key authentication.

When WPA-PSK (TKIP) or WPA2-PSK (AES) is selected

You can set the following items.

Sub Menu	Function
PSK	You can enter a PreSharedKey (encrypted key) in single-byte alphanumeric characters. Enter at least 8 and up to 63 characters. When you enter the PreSharedKey, and press the [Enter] button, the setting value is displayed as asterisks (*). You cannot enter more than 32 characters in the Configuration Menu. If you want to set more than 32 characters, make the setting from Web Control.  p.63

Wired LAN menu

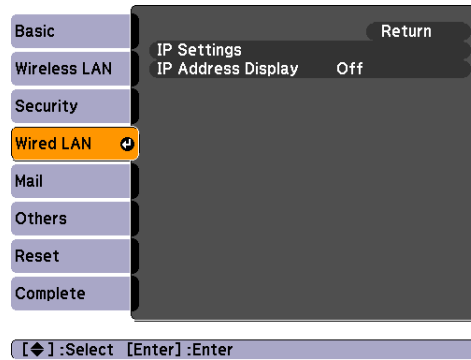

Sub Menu	Function
IP Settings	<p>You can make settings related to the following addresses.</p> <p>DHCP▶▶: Select whether or not (On/Off) to use DHCP. If this is set to On, you cannot set any more addresses.</p> <p>IP Address▶▶: You can input the IP address assigned to the projector. You can input a number from 0 to 255 in each field of the address. However, the following IP addresses cannot be used. 0.0.0.0, 127.x.x.x, 224.0.0.0 to 255.255.255.255 (where x is a number from 0 to 255)</p> <p>Subnet Mask▶▶: You can input the subnet mask for the projector. You can input a number from 0 to 255 in each field of the address. However, the following subnet masks cannot be used. 0.0.0.0, 255.255.255.255</p> <p>Gateway Address▶▶: You can input the IP address of the gateway for the projector. You can input a number from 0 to 255 in each field of the address. However, the following gateway addresses cannot be used. 0.0.0.0, 127.x.x.x, 224.0.0.0 to 255.255.255.255 (where x is a number from 0 to 255)</p>
IP Address Display	<p>To prevent the IP address from being displayed on Network Info in the Network Menu and on the LAN Standby screen, set this to Off.</p>

Mail menu

When this is set, you receive an e-mail notification if a problem or warning occurs in the projector. For information on the contents of the sent Mail, see "Reading Error Notification Mail"  p.106

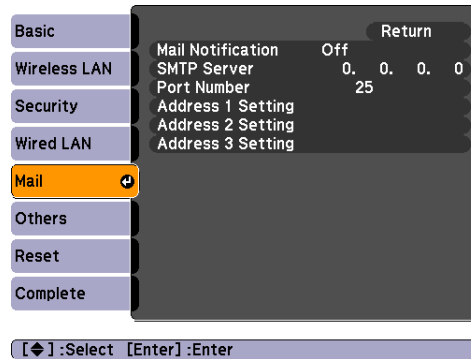

Sub Menu	Function
Mail Notification	You can set whether or not (On/Off) to be notified by mail.
SMTP Server	You can input the <u>IP address</u>  of the SMTP Server used by the projector. You can input a number from 0 to 255 in each field of the address. However, the following IP addresses cannot be used. 127.x.x.x, 224.0.0.0 to 255.255.255.255 (where x is a number from 0 to 255)
Port Number	You can input the Port Number for the SMTP Server. The default value is 25. You can input numbers between 1 to 65535.
Address 1 Setting Address 2 Setting Address 3 Setting	Enter the Email Address and the contents of the email to receive notification when an error or warning occurs in the projector. You can enter up to 32 characters for the mail address. You can select multiple problems or warnings to be notified about by Mail. You can also change each Email Address.



If you set **Standby Mode** to **Communication On** from the **Extended** menu in the Configuration Menu of the projector, you can perform monitoring even if the projector is in a standby state (when the power is off).

Others Menu

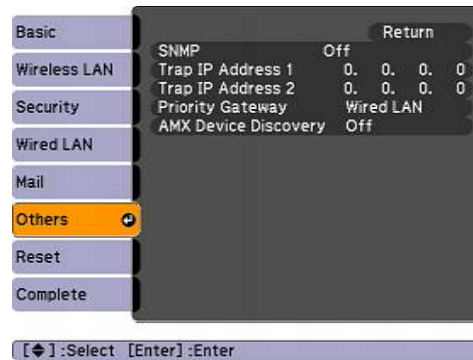

Sub-menu	Function
SNMP	Set whether or not (On/Off) to use SNMP.
Trap IP Address 1 Trap IP Address 2	You can register up to two IP addresses for the SNMP trap notification destination. You can input a number from 0 to 255 in each field of the address. However, the following IP addresses cannot be used. 127.x.x.x, 224.0.0.0 to 255.255.255.255 (where x is a number from 0 to 255) To use SNMP to monitor the projector, the SNMP manager program needs to be installed on your computer. Make sure management by SNMP is performed by the network administrator.
Priority gateway	For the priority gateway, select either wireless or wired.
<u>AMX Device Discovery</u>	When the projector is connected to a network, set this to On when you want to allow the projector to be detected by AMX Device Discovery. Set this to Off if you are not connected to an environment controlled with a controller from AMX or AMX Device Discovery.

Reset Menu

Resets all of the network settings.

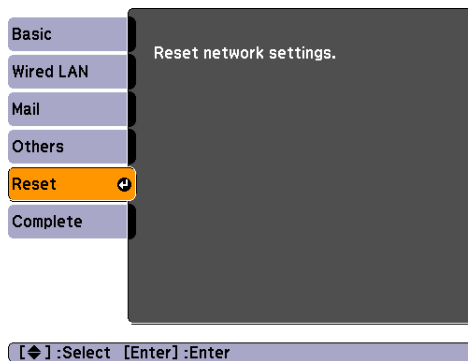

Sub Menu	Function
Reset network settings.	To reset all of the Network settings, select Yes . After you reset all of the settings, the Basic menu is displayed.

Info Menu (Display Only)

Lets you check the status of the image signals being projected and the status of the projector. Items that can be displayed vary depending on the image signal and Source currently being projected as shown in the following screen shots. Depending on the model used, some input sources are not supported.

☞ p.21

Computer Signal/Component Video▶▶/USB/USB
Display

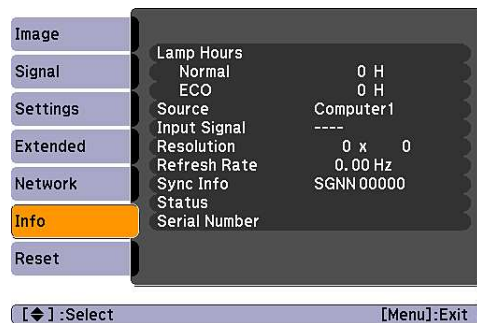

Composite video▶▶/S-Video▶▶

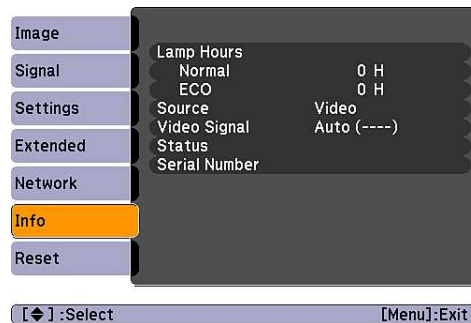

LAN

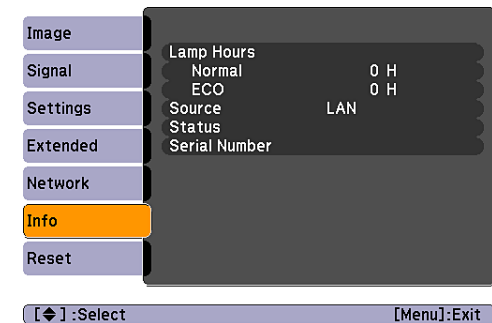

Sub-menu	Function
Lamp Hours	You can display the cumulative lamp operating time*. When it reaches the lamp warning time, the characters are displayed in yellow.
Source	You can display the Source name for the connected equipment currently being projected.
Input Signal	You can display the settings of Input Signal in the Signal menu depending on the Source .
Resolution	You can display the input resolution.
Video Signal	You can display the settings of Video Signal in the Signal menu.
Refresh Rate▶▶	You can display the refresh rate.
Sync Info	You can display the image signal Information. This information may be needed if service is required.
Status	This information is about errors that have occurred with the projector. It may be needed if service is required.
Serial Number	Displays the projector's serial number.

* The cumulative use time is displayed as "0H" for the first 10 hours. 10 hours and above is displayed in 1hour steps as "10 H", "11H", and so on.

Reset Menu

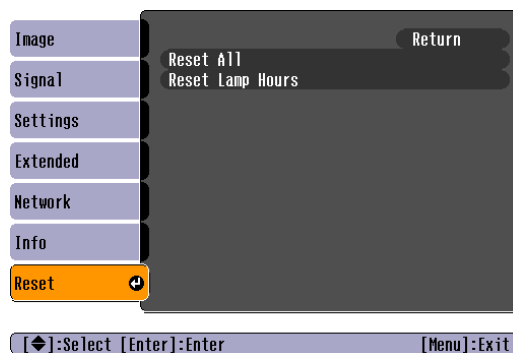

Sub Menu	Function
Reset All	You can reset all items in the Configuration Menu to their default settings. The following items are not reset to their defaults: Input Signal , User's Logo , all items in the Network menu, Lamp Hours , and Language .
Reset Lamp Hours	You can clear the cumulative lamp hours, and return it to "0H". Reset this when you replace the lamp.



Troubleshooting

This chapter explains how to identify problems and what to do if a problem is found.

If a problem occurs with the projector, the Help screen is displayed to assist you by pressing the [Help] button. You can solve problems by answering the questions.

Procedure

1 Press the [Help] button.

The Help screen is displayed.

Using Remote Control

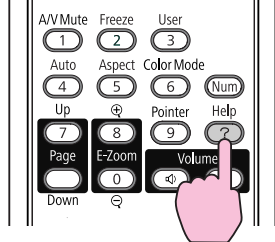

Using Control panel

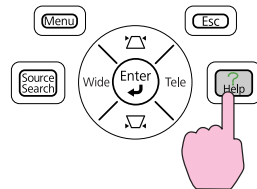

2 Select a menu item.

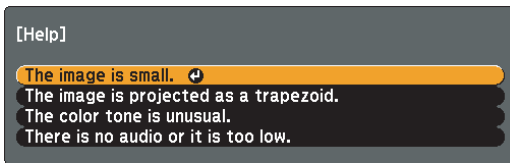

[Left Arrow] :Select [Enter] :Enter [Help] :Exit

Using Remote Control

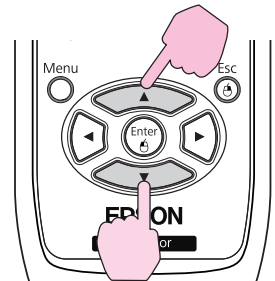

Using Control panel

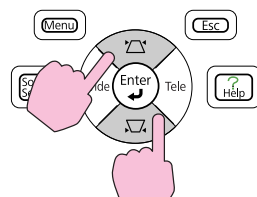

3 Confirm the selection.

Using Remote Control

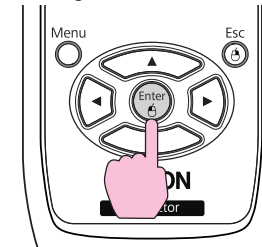

Using Control panel

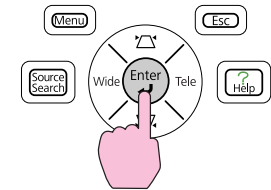

Questions and solutions are displayed as shown on the screen below. Press the [Help] button to exit the Help.

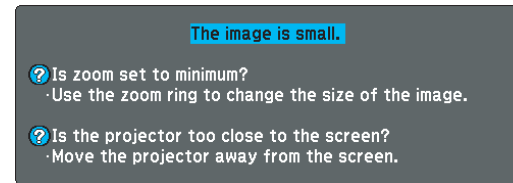

[Esc] :Return [Help] :Exit

 If the Help function does not provide a solution to the problem, see "Problem Solving" p.94.

If you are having a problem with the projector, first check the projector's indicators and see "Reading the Indicators".

If the indicators do not show clearly what the problem might be, see "When the Indicators Provide No Help".  [p.97](#)

Reading the Indicators

The projector is provided with the following three indicators that indicate the status of the projector.

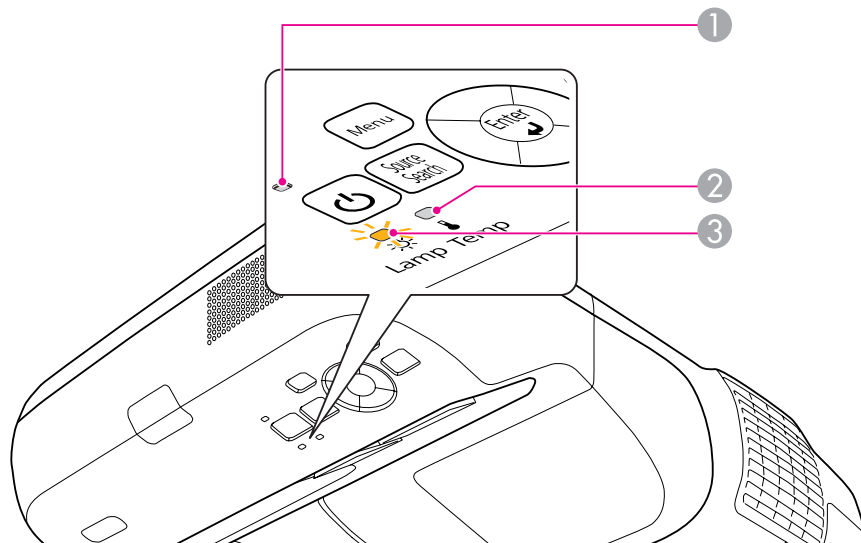

① Indicates the operating status.



Standby condition
When the [⏻] button is pressed in this status, projection starts.



Preparing for network monitoring or cool down in progress

Buttons are disabled while the indicator is flashing.



Warming up

Warm-up time is about 30 seconds. After warm-up is complete, the indicator stops flashing.



Projecting

② Indicates the internal temperature status.

③ Indicates the lamp status.





See the following table for the status of indicators and how to resolve the problems.

If all indicators are off, the power cable is not connected correctly or the power is not being supplied normally.

Sometimes, when the power cable is unplugged, the [⏻] indicator remains lit for a short period, but this is not a fault.



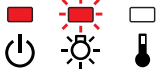











⏻ indicator is lit or flashing red

■ : Lit
 ■ (with red dots) : Flashing
 : Off

Status	Cause	Remedy or Status
	Internal Error	Stop using the projector, disconnect the power cable from the electrical outlet, and contact your local dealer or the nearest address provided in the Support and Service Guide. ☞ Epson Projector Contact List
	Fan Error Sensor Error	Stop using the projector, disconnect the power cable from the electrical outlet, and contact your local dealer or the nearest address provided in the Support and Service Guide. ☞ Epson Projector Contact List
	High Temp Error (overheating)	<p>The lamp turns off automatically and projection stops. Wait for approximately five minutes. After approximately five minutes the projector switches to standby mode, so check the following two points.</p> <ul style="list-style-type: none"> • Check that the air filter and air exhaust vent are not blocked, and that the projector is not positioned against a wall. • If the air filter is clogged, clean or replace it. ☞ p.108, p.114 <p>If the error continues after checking the points above, stop using the projector, disconnect the power cable from the electrical outlet, and contact your local dealer or the nearest address provided in the Support and Service Guide. ☞ Epson Projector Contact List</p> <p>When using the projector at an altitude of 1500 m or more, set High Altitude Mode to On. ☞ p.78</p>
	Lamp Error Lamp Failure	<p>Check the following two points.</p> <ul style="list-style-type: none"> • Take out the lamp and check whether it is cracked. ☞ p.111 • Clean the air filter. ☞ p.108 <p>If it is not cracked: Reinstall the lamp and turn on the power.</p> <p>If the error continues: Replace the lamp with a new one and then turn on the power.</p> <p>If the error continues: Stop using the projector, disconnect the power cable from the electrical outlet, and contact your local dealer or the nearest address provided in the Support and Service Guide. ☞ Epson Projector Contact List</p> <p>If it is cracked: Replace it with a new lamp, or contact your local dealer for further advice. If replacing the lamp yourself, be careful to avoid pieces of broken glass (you cannot continue projecting until the lamp is replaced). ☞ Epson Projector Contact List</p> <p>When using the projector at an altitude of 1500 m or more, set High Altitude Mode to On. ☞ p.78</p>
	Auto Iris Error Power Err. (Ballast)	Stop using the projector, disconnect the power cable from the electrical outlet, and contact your local dealer or the nearest address provided in the Support and Service Guide. ☞ Epson Projector Contact List

⚙️ **Indicator is flashing or lit orange**

■ : Lit
 ⏏ : Flashing
 : Off
 : Varies according to the projector status

Status	Cause	Remedy or Status
     	High Temp Warning	(This is not an abnormality. However, if the temperature rises too high again, projection stops automatically.) <ul style="list-style-type: none"> • Check that the air filter and air exhaust vent are not blocked, and that the projector is not positioned against a wall. • If the air filter is clogged, clean or replace it.  p.108, p.114
     	Replace Lamp	Replace it with a new lamp.  p.111 If you continue to use the lamp after the replacement period has passed, the possibility that the lamp may blow increases. Replace it with a new lamp as soon as possible.



- If the projector is not operating properly, even though the indicators are all showing normal, refer to "When the Indicators Provide No Help" [p.97](#).
- If the error is not indicated in this table, stop using the projector, disconnect the power cable from the electrical outlet, and contact your local dealer or the nearest address provided in the Support and Service Guide.  [Epson Projector Contact List](#)

When the Indicators Provide No Help

If any of the following problems occur and the indicators do not offer a solution, refer to the pages given for each problem.

Problems relating to images

- "No images appear" 🖱️ p.98
Projection does not start, the projection area is completely black, the projection area is completely blue, and so on.
- "Moving images are not displayed" 🖱️ p.98
Moving images played back from a computer appear black and the images are not projected.
- "Projection stops automatically" 🖱️ p.98
- "The message "Not supported" is displayed." 🖱️ p.99
- "The message "No Signal" is displayed." 🖱️ p.99
- "Images are fuzzy or out of focus" 🖱️ p.99
- "Interference or distortion appear in images" 🖱️ p.100
Problems such as interference, distortion, or black & white checked patterns appear.
- "The image is truncated (large) or small, or the aspect is not suitable" 🖱️ p.100
Only part of the image is displayed, or the height and width ratios of the image are not correct, and so on.
- "Image colors are not right" 🖱️ p.101
The whole image appears purplish or greenish, images are black and white, colors appear dull, and so on. (Computer monitors and LCD screens have different color reproduction performance, so the colors in images projected by the projector and the colors appearing on the monitor may not always match, but this is not a sign of a problem.)
- "Images appear dark" 🖱️ p.101

Problems when projection starts

- "The projector does not turn on" 🖱️ p.102

Problems relating to monitoring and control

"Mail is not received even if an error occurs with the projector" 🖱️ p.102

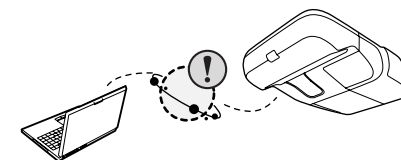

Problems relating to Easy Interactive Function

- "The message "Hardware device not found." is displayed." 🖱️ p.103
- "Easy Interactive Pen does not work" 🖱️ p.103
- "Flashing dots do not appear even if calibration is started" 🖱️ p.104
- "The dots do not change from flashing to always lit." 🖱️ p.104
- "The dots change from flashing to always lit automatically" 🖱️ p.104

Other problems

- "No sound can be heard or the sound is faint" 🖱️ p.104
- "No sound can be heard from the microphone" 🖱️ p.105
- "The remote control does not work" 🖱️ p.105
- "I want to change the language for messages and menus" 🖱️ p.105

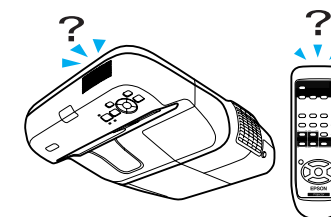

Problems relating to images

No images appear

Check	Remedy
Did you press the [⏻] button?	Press the [⏻] button to turn the power on.
Are all of the indicators off?	The power cable is not connected correctly or power is not being supplied normally. Check that your electrical outlet or power source is functioning correctly. If the lamp cover or the lamp are not installed correctly, the lamp does not turn on. Check that the lamp cover and lamp are securely installed. 🖱️ p.111
Is A/V Mute active?	Press the [A/V Mute] button on the remote control to cancel A/V Mute. 🖱️ p.40
Are the Configuration Menu settings correct?	Try to reset all of the settings. 🖱️ Reset Menu - Reset All p.91
Is the projected image completely black? Only when projecting computer images	Some input images, such as screen savers, may be completely black.
Is the image signal format setting correct? Only when projecting images from a video source	Change the setting according to the signal for the connected equipment. 🖱️ Signal Menu - Video Signal p.75

Moving images are not displayed

Check	Remedy
Is the computer's image signal being output to the LCD and the monitor? Only when projecting images from a laptop computer or a computer with a built-in LCD screen	Change the image signal to external output only. 🖱️ See the documentation supplied with the computer or contact the maker of the computer.

Projection stops automatically

Check	Remedy
Is Sleep Mode set to On ?	Press the [⏻] button to turn the power on. If you do not want to use Sleep Mode, change the setting to Off . 🖱️ Extended Menu - Operation - Sleep Mode p.78

The message "Not supported" is displayed.

Check	Remedy
Is the image signal format setting correct? Only when projecting images from a video source	Change the setting according to the signal for the connected equipment. 🖱️ Signal Menu - Video Signal p.75
Do the image signal resolution and refresh rate correspond to the mode? Only when projecting computer images	See the documentation supplied with the computer for how to change the image signal resolution and refresh rate output from the computer. 🖱️ "List of Supported Resolutions" p.119

The message "No Signal" is displayed.

Check	Remedy
Are the cables connected correctly?	Check that all the cables required for projection are securely connected. 🖱️ Quick Start Guide
Is the correct input port selected?	Change the image by pressing the [Source Search] button on the remote control or the control panel. 🖱️ p.21
Is the power for the computer or video source turned on?	Turn the power on for the equipment.
Are the image signals being output to the projector? Only when projecting images from a laptop computer or a computer with a built-in LCD screen	If the image signals are only being output to the computer's LCD monitor or accessory monitor, change the output so that the image signals are also output externally. With some computer models, when the image signals are output externally, the images no longer appear on the LCD monitor or accessory monitor. 🖱️ Computer's documentation, under a title such as "External output" or "Connecting an external monitor". If the connection is made while the power of the projector or computer is already turned on, the function [Fn] key that changes the computer's image signal to external output may not work. Turn the power for the computer and the projector off and then back on again.

Images are fuzzy or out of focus

Check	Remedy
Is the focus adjusted correctly?	Adjust the focus with the focus lever. 🖱️ Quick Start Guide
Is the projector at the correct distance?	Is it projecting outside of the recommended projection distance range? Setup within the recommended range. 🖱️ p.117
Is the Keystone adjustment value too large?	Lower the projection angle to reduce the amount of keystone correction. 🖱️ Quick Start Guide
Has condensation formed on the lens?	If the projector is suddenly taken from a cold environment to a warm environment, or if sudden ambient temperature changes occur, condensation may form on the surface of the lens, and this may cause the images to appear fuzzy. Set the projector up in the room about one hour before it is used. If condensation forms on the lens, turn the projector off and wait for the condensation to disappear.

Check	Remedy
Is a wide-panel computer image being projected? Only when projecting computer images	Change the setting according to the signal for the connected equipment. 🖱️ Signal menu - Resolution p.75
Is the correct resolution selected? Only when projecting computer images	Set the computer so that the signals being output are compatible with the projector. 🖱️ "List of Supported Resolutions" p.119 🖱️ Computer's documentation

Interference or distortion appear in images

Check	Remedy
Is the image signal format setting correct? Only when projecting images from a video source	Change the setting according to the signal for the connected equipment. 🖱️ Signal Menu - Video Signal p.75
Are the cables connected correctly?	Check that all the cables required for projection are securely connected. 🖱️ Quick Start Guide
Is an extension cable being used?	If an extension cable is used, electrical interference may affect the signals. Use the cables supplied with the projector to check if the cables you are using may be causing the problem.
Is the correct resolution selected? Only when projecting computer images	Set the computer so that the signals being output are compatible with the projector. 🖱️ "List of Supported Resolutions" p.119 🖱️ Computer's documentation
Are the " Sync. " and " Tracking " settings adjusted correctly? Only when projecting computer images	Press the [Auto] button on the remote control or the [Enter] button on the control panel to perform automatic adjustment. If the images are not adjusted correctly even after performing automatic adjustment, you can also make adjustments with Sync. and Tracking in the Configuration Menu. 🖱️ Signal Menu - Tracking and Sync. p.75

The image is truncated (large) or small, or the aspect is not suitable

Check	Remedy
Is a wide panel computer image being projected? Only when projecting computer images	Change the setting according to the signal for the connected equipment. 🖱️ Signal menu - Resolution p.75
Is the image still enlarged by E-Zoom?	Press the [Esc] button on the remote control to cancel E-Zoom. 🖱️ p.47
Is the display position adjusted correctly?	Press the [Auto] button on the remote control or the [Enter] button on the control panel to perform automatic adjustment while a computer image is being projected. If the images are not adjusted correctly even after performing automatic adjustment, you can also make adjustments using Position from the Configuration Menu. When projecting signals other than computer image signals, make adjustments with Position in the Configuration Menu. 🖱️ Signal Menu - Position p.75

















Check	Remedy
Is the computer set for dual display? Only when projecting computer images	If dual display is activated in "Display Properties" from the computer's Control panel, only approximately half of the image on the computer screen is projected. To display the entire image on the computer screen, turn off the dual display setting.  Computer's video driver documentation
Is the correct resolution selected? Only when projecting computer images	Set the computer so that the signals being output are compatible with the projector.  "List of Supported Resolutions" p.119  Computer's documentation

Image colors are not right





Check	Remedy
Do the input signal settings match the signals from the connected device?	Change the following settings according to the signal for the connected equipment. When the image is from equipment connected to the Computer input port  Signal menu - Input Signal p.75 When the image is from equipment connected to the Video or S-Video input port  Signal menu - Video Signal p.75
Is the image brightness adjusted correctly?	Adjust Brightness in the Configuration Menu.  Image menu - Brightness p.74
Are the cables connected correctly?	Check that all the cables required for projection are securely connected.  <i>Quick Start Guide</i>
Is Contrast  adjusted correctly?	Adjust the Contrast in the Configuration Menu.  Image Menu - Contrast p.74
Is color adjustment set to an appropriate value?	Adjust Color Adjustment in the Configuration Menu.  Image Menu - Color Adjustment p.74
Are the color saturation and tint adjusted correctly? Only when projecting images from a video source	Adjust Color Saturation and Tint in the Configuration Menu.  Image Menu - Color Saturation and Tint p.74

Images appear dark

Check	Remedy
Is the image brightness set correctly?	Adjust Brightness and Power Consumption from the Configuration Menu.  Image Menu - Brightness p.74  Settings Menu - Power Consumption p.76
Is the contrast  adjusted correctly?	Adjust Contrast from the Configuration Menu.  Image Menu - Contrast p.74
Is it time to replace the lamp?	When the lamp is nearly ready for replacement, the images become darker and the color quality declines. Replace the lamp with a new one.  p.111





Problems when projection starts



The projector does not turn on

Check	Remedy
Did you press the [⏻] button?	Press the [⏻] button to turn the power on.
Are all of the indicators off?	<p>The power cable is not connected correctly or power is not being supplied. Disconnect and then reconnect the power cable.  Quick Start Guide</p> <p>Check the breaker and so on to ensure power is being supplied.</p> <p>If the lamp cover or the lamp are not installed correctly, the lamp will not turn on. Check that the lamp cover and lamp are installed properly.  p.111</p>
Do the indicators turn on and off when the power cable is touched?	There is probably a poor contact in the power cable, or the power cable may be defective. Reinsert the power cable. If this does not solve the problem, stop using the projector, disconnect the power cable from the electrical outlet, and contact your local dealer or the nearest address provided in the Support and Service Guide.  Epson Projector Contact List
Is Control Panel Lock set to Full Lock ?	Press the [⏻] button on the remote control. If you do not want to use Control Panel Lock , change the setting to Off .  Settings Menu - Control Panel Lock p.52
Is the correct setting for the remote receiver selected?	Check the Remote Receiver setting from the Configuration Menu.  Settings Menu - Remote Receiver p.76

Problems relating to monitoring and control

Mail is not received even if an error occurs with the projector

Check	Remedy
Is the Wireless LAN unit installed?  For wireless LAN	Check that the optional Wireless LAN unit is installed in the projector properly.
Is the network cable connected correctly?  For wired LAN	Check that the network cable is connected correctly. Reconnect it if it is not connected or not connected properly.
Are the network connection settings correct?	Check the projector's network settings.  p.80
Is Standby Mode set to Communication On ?	To use Mail Notification when the projector is in a standby state, set Standby Mode to Communication On from the Configuration Menu.  Extended menu - Standby Mode p.78

Check	Remedy
Did a fatal error occur and the projector come to a sudden stop?	If the projector comes to a sudden stop, mail cannot be sent. If, after checking the projector, the error state cannot be resolved, contact your local dealer or the nearest address provided in the Support and Service Guide.  Epson Projector Contact List
Is power being supplied to the projector?	Check that your electrical outlet or power source is functioning correctly.
Is Mail Notification set correctly from the Configuration Menu?	Error notification mail is sent in accordance with the setting of the Mail menu from the Configuration Menu. Check if it is set correctly.  Network menu - Mail menu p.87

Problems relating to Easy Interactive Function

The message "Hardware device not found." is displayed.

Check	Remedy
The projector and computer are not connected correctly.	Check the USB cable connections. You may be able to resolve the problem by disconnecting and then reconnecting the USB cable.
An antivirus program may be blocking use of the port.	Disable the antivirus program and then restart Easy Interactive Function.
If you are using a notebook computer when the battery power is running low, the USB port may stop working and you might not be able to use USB devices.	Connect the power cable of the computer to an electrical outlet.

Easy Interactive Pen does not work

Check	Remedy
An object is blocking the path for sending the signal from the Easy Interactive Pen to the projector.	Move the object. Also, make sure you are not blocking the signal path when you stand in front of the projection surface.
There is insufficient battery power.	Replace the batteries.
The surroundings are too bright.	Make sure there is no strong light shining on the projection surface or the Easy Interactive Function receiver.
The projector and computer are not connected.	Check that the projector and computer are connected correctly.

Flashing dots do not appear even if calibration is started

Check	Remedy
The computer screen is being redisplayed.	End all applications such as Flash animations that redisplay the screen and then restart Easy Interactive Function.
The dots are not displayed if the projector is not detected by the computer.	Check that the projector and computer are connected correctly and then restart Easy Interactive Function.

The dots do not change from flashing to always lit.



Check	Remedy
The projector surface information cannot be received accurately because there is another light source nearby.	Move the light source away from the projector or change the installation location of the projector.
The projector surface information cannot be received accurately if the projector position is too close to the projection surface.	Check the installation position of the projector.

The dots change from flashing to always lit automatically

Check	Remedy
The Easy Interactive Pen has been disabled because the surrounding light source state is unstable.	Change the installation position of the projector or turn off the light source.

Other problems





No sound can be heard or the sound is faint

Check	Remedy
Is the audio source connected correctly?	Disconnect the cable from the Audio port, and then reconnect the cable.
Is the volume adjusted to the minimum setting?	Adjust the volume so that sound can be heard.  p.76  <i>Quick Start Guide</i>
Is A/V Mute active?	Press the [A/V Mute] button on the remote control to cancel A/V Mute.  p.40
Is the audio cable's specification "No resistance"?	When using a commercially available audio cable, make sure it is labeled "No resistance".

No sound can be heard from the microphone

Check	Remedy
Is the microphone connected correctly?	Disconnect the cable from the Microphone (Mic) input port, and then reconnect the cable.
Is the Mic Input Volume turned down too low?	Adjust the Mic Input Volume so that sound can be heard.  Settings Menu - Mic Input Level p.76

The remote control does not work

Check	Remedy
Is the remote control light-emitting area pointing towards the remote receiver on the projector during operation?	Point the remote control towards the remote receiver during operation. Operating range  Quick Start Guide
Is the remote control too far from the projector?	The operating range for the remote control is about 6 m.  Quick Start Guide
Is direct sunlight or strong light from fluorescent lamps shining onto the remote receiver?	Set the projector up in a location where strong light does not shine onto the remote receiver. Alternatively, set the remote receiver affected by light to Off from Remote Receiver in the Configuration Menu.  Settings Menu - Remote Receiver p.76
Is the remote receiver set correctly?	Check the Remote Receiver setting from the Configuration Menu.  Settings Menu - Remote Receiver p.76
Are the batteries dead or have the batteries been inserted in the wrong direction?	Insert new batteries in the correct direction.  p.110

I want to change the language for messages and menus

Check	Remedy
Change the language setting.	Change the Language setting from the Configuration Menu.  p.78

When the Mail Notification function is set to **On** and a problem/warning occurs in the projector, the following e-mail will be sent.

Subject: EPSON Projector

Line 1: The name of the projector where the problem occurred

Line 2: The IP Address set for the projector where the problem has occurred.

Line 3 and on: Details of the problem

The details of the problem are listed line by line. The following table shows the details that are given in the message for each item. To deal with problems/warnings, see "[Reading the Indicators](#)".  [p.94](#)

Message	Cause
Internal error	Internal Error
Fan related error	Fan Error
Sensor error	Sensor Error
Lamp timer failure	Lamp Failure
Lamp out	Lamp Error
Internal temperature error	High Temp Error (Overheating)
High-speed cooling in progress	High Temp Warning
Lamp replacement notification	Replace Lamp
No-signal	No Signal No Signal is input to the projector. Check the connection status or check that the power for the signal source is turned on.
Auto Iris Error	Auto Iris Error
Power Err. (Ballast)	Power Err. (Ballast)

A (+) or (-) appears at the start of the message.

(+): A projector problem has occurred

(-): A projector problem has been dealt with



Appendix

This chapter provides information on maintenance procedures to ensure the best level of performance from the projector for a long time to come.

Clean the projector if it becomes dirty or if the quality of the projected images starts to deteriorate.

Cleaning the Projector's Surface

Clean the projector's surface by wiping it gently with a soft cloth.

If the projector is particularly dirty, moisten the cloth with water containing a small amount of neutral detergent, and then firmly wring the cloth dry before using it to wipe the projector's surface.

Attention

Do not use volatile substances such as wax, alcohol, or thinner to clean the projector's surface. The quality of the case may change or become discolored.

Cleaning the Projection Window

Use a commercially available cloth for cleaning glasses to gently wipe off dirt from the projection window.

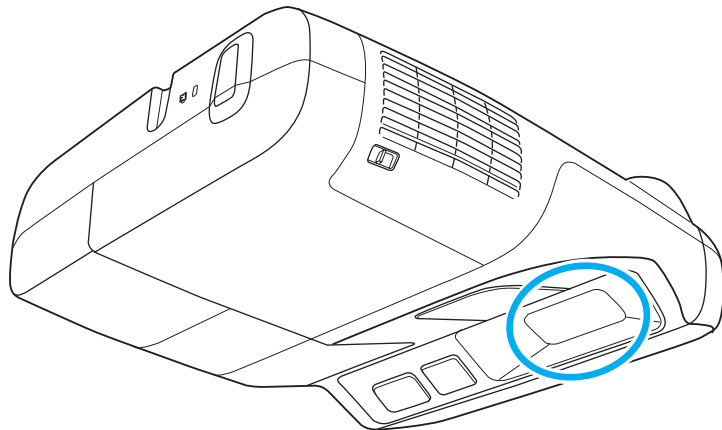

Warning

Do not use sprays that contain flammable gas to remove dirt and dust from the lens. The projector may catch fire because of the high temperature of the lamp inside the projector.

Attention

Do not rub the lens with harsh materials or subject the lens to shocks, as it can easily become damaged.

Cleaning the Air Filter

Clean the air filter and the air intake vent when the following message is displayed.

"The projector is overheating. Make sure nothing is blocking the air vent, and clean or replace the air filter".

Attention

- *Dust collecting on the air filter may cause the internal temperature of the projector to rise, leading to a malfunction or early deterioration of optical parts. If the message is displayed, clean the air filter as soon as possible.*
- *Do not rinse the air filter in water. Do not use detergents or solvents.*

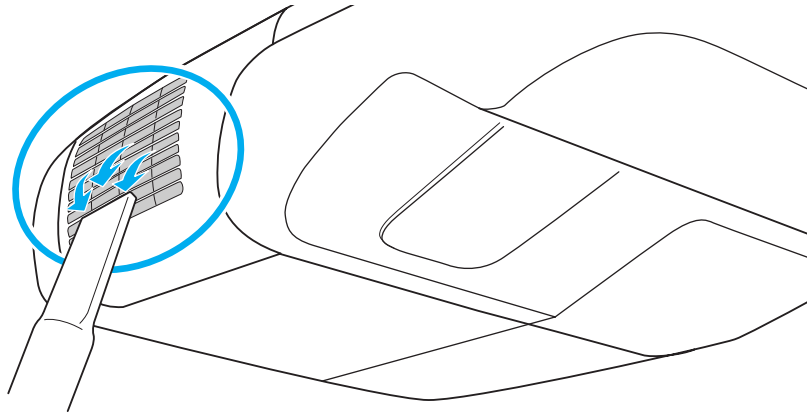

- If the message is displayed frequently even after cleaning, it is time to replace the air filter. Replace it with a new air filter.
☞ [p.114](#)
- It is recommended that you clean these parts at least once every three months. Clean them more often than this if you are using the projector in a particularly dusty environment.

This section explains how to replace the remote control batteries, lamp, and air filter.

Replacing the Remote Control Batteries

If the remote control becomes unresponsive or inoperable after it has been used for some time, the batteries may have reached the end of their service life. When this happens, replace them with new batteries. Obtain two AA size manganese or alkaline batteries. Batteries other than AA size manganese or alkaline batteries cannot be used.

Attention

Make sure you read the separate Safety Instructions before handling the batteries.  Safety Instructions

Procedure

1 Remove the battery cover.

While pushing the battery compartment cover catch, lift the cover up.

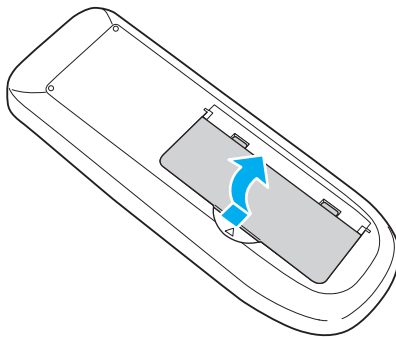

2 Replace the old batteries with new batteries.

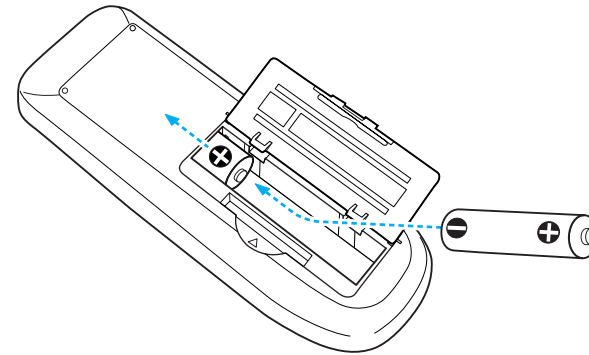

Caution

Check the positions of the (+) and (-) marks inside the battery holder to ensure the batteries are inserted the correct way.

3 Replace the battery cover.

Press the battery compartment cover until it clicks into place.

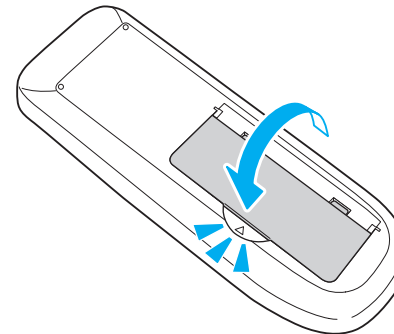

Replacing the Lamp

Lamp replacement period

It is time to replace the lamp when:

- The message "Replace the lamp." is displayed when you start projecting.

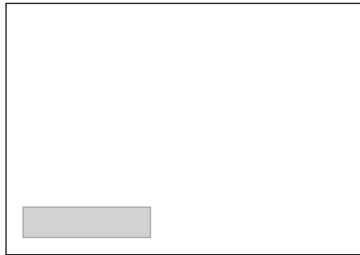

A message is displayed.

- The lamp indicator flashes orange.

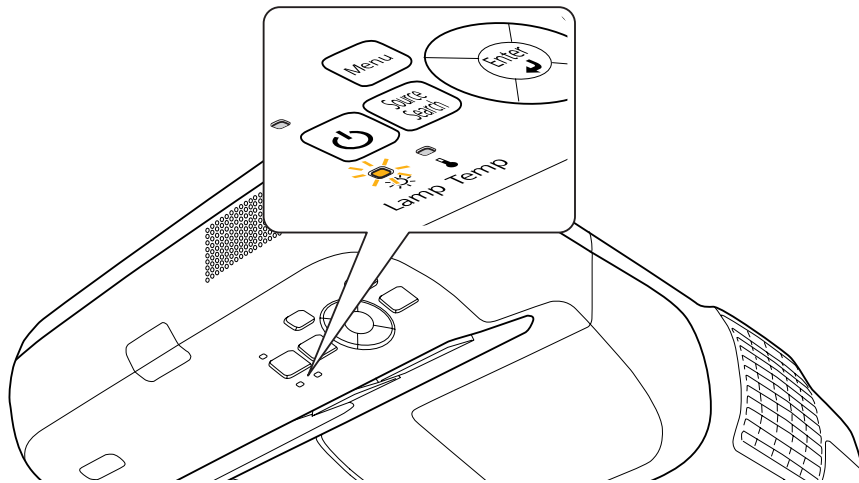

- The projected image gets darker or starts to deteriorate.

Attention

- The lamp replacement message is set to appear after the following time periods in order to maintain the initial brightness and quality of the projected images.
 - ☞ p.76
 - When **Power Consumption** is set to **Normal**: About 2400 hours
 - When **Power Consumption** is set to **ECO**: About 3400 hours
- If you continue to use the lamp after the replacement period has passed, the possibility that the lamp may blow increases. When the lamp replacement message is displayed, replace the lamp with a new one as soon as possible, even if it is still working.
- Depending on the individual characteristics of the lamp and the way it has been used, the lamp may become darker or stop working before the message is displayed. We recommend having a spare lamp ready in case it is needed.

How to replace the Lamp

Warning

- When replacing the lamp because it has stopped working, there is a possibility that the lamp may be cracked. If replacing the lamp of a projector which has been installed on a wall or ceiling, you should always assume that the lamp is broken, and you should stand to the side of the Lamp cover, not underneath it. Also, remove the lamp cover gently. There is the risk of small pieces of glass falling when you open the lamp cover. If this happens, see a doctor immediately.
- Never disassemble or modify a lamp. If a modified or disassembled lamp is installed in the projector and used, it could cause a fire, electric shock, or an accident.

Caution

Wait until the lamp has cooled down sufficiently before removing the lamp cover. If the lamp is still hot, burns or other injuries may result. It takes approximately one hour after the power has been turned off for the lamp to sufficiently cool down.

Procedure

- 1 After you turn off the projector's power and the confirmation buzzer beeps twice, disconnect the power cable.
- 2 Wait until the lamp has sufficiently cooled down, and then remove the lamp cover at the top of the projector.

Loosen the lamp cover fixing screw with the screwdriver supplied with the new lamp unit or a Phillips (+) screwdriver. Then slide the lamp cover straight forward and lift to remove it.

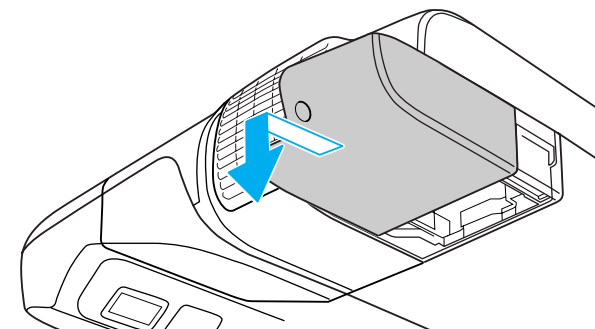
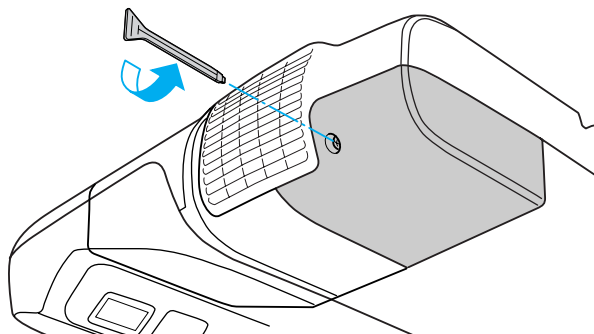

- 3 Loosen the two lamp fixing screws.

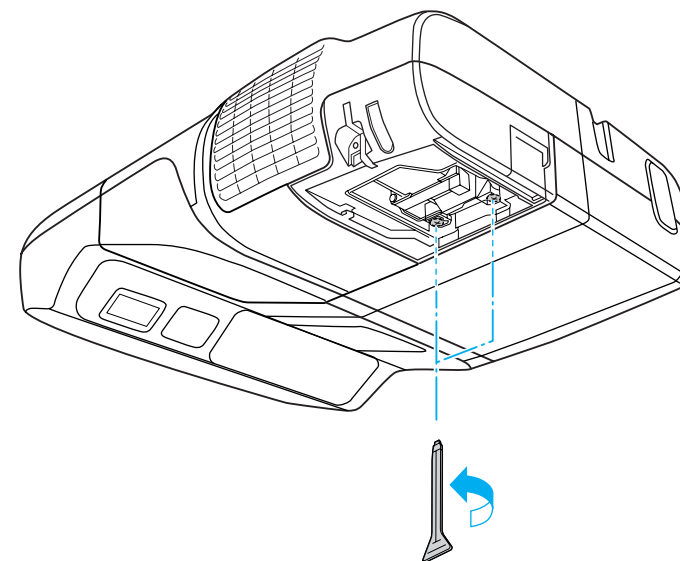

- 4 Remove the old lamp by pulling the handle.

If the lamp is cracked, replace it with a new lamp or contact your local dealer for further advice.  [Epson Projector Contact List](#)

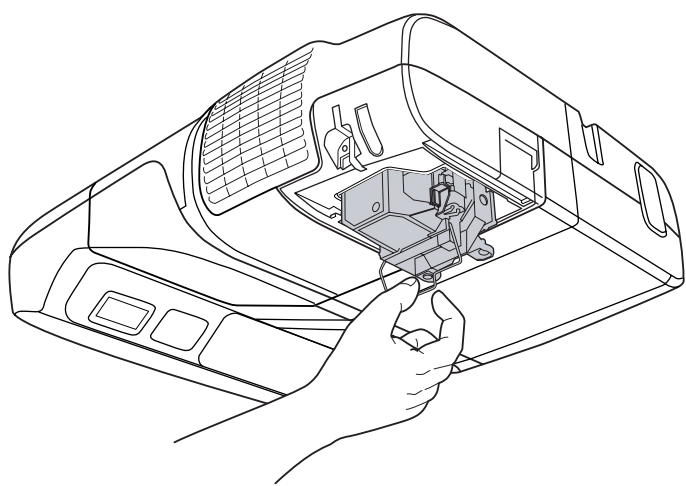

5 Install the new lamp.

Insert the new lamp along the guide rail in the correct direction so that it fits in place, push down firmly at the location marked "PUSH", and once it is fully inserted tighten the two screws. Press the replacement lamp in by the handle until it clicks into place. Push the replacement lamp inside the projector by the handle until it clicks into place.

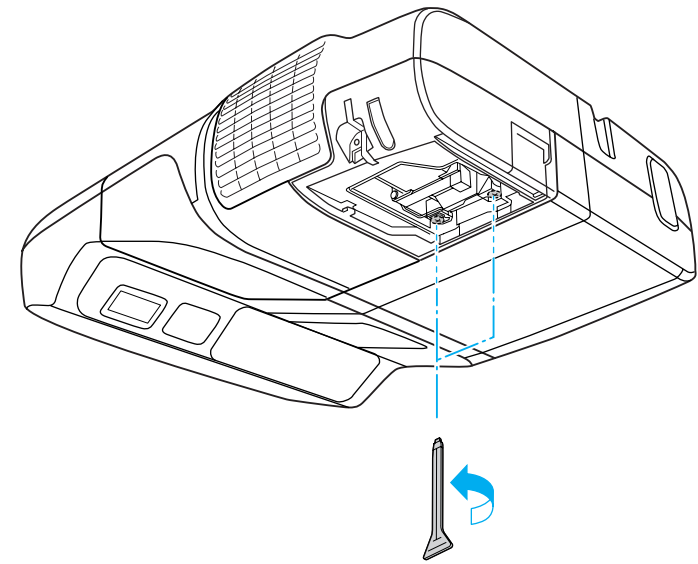
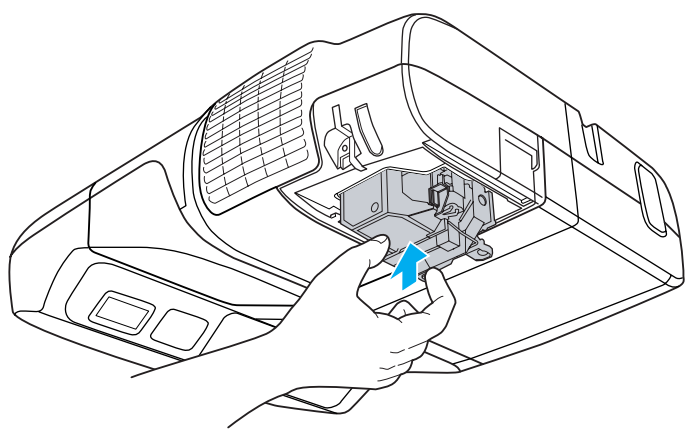

6 Attach the lamp cover.

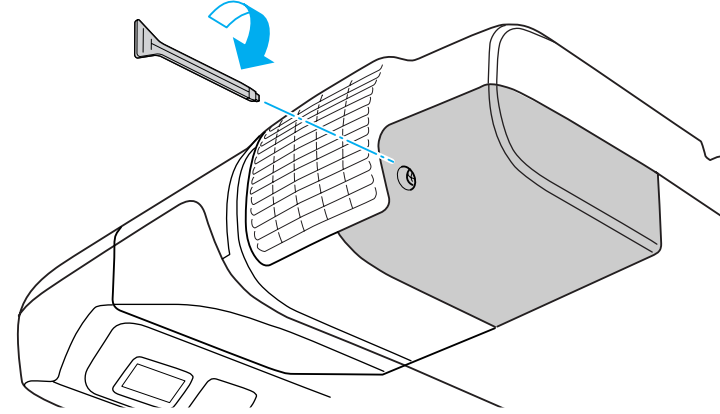

Attention

- Install the lamp securely. If the lamp cover is removed, the power turns off automatically as a safety precaution. If the lamp or the lamp cover is not installed correctly, the lamp does not turn on.
- This product includes a lamp component that contains mercury (Hg). Please consult your local regulations regarding disposal or recycling. Do not dispose of it with normal waste.

Resetting the Lamp Hours

The projector records how long the lamp is on and a message and indicator notify you when it is time to replace the lamp. After replacing the lamp, reset the time accumulated for Lamp Hours in the Configuration Menu.

☛ p.91



Only reset Lamp Hours after the lamp has been replaced. Otherwise the lamp replacement period is not indicated correctly.

Replacing the Air Filter

Air filter replacement period

It is time to replace the air filter when:

- There is a tear in the air filter.
- The message is displayed frequently even though the air filter has been cleaned.

How to replace the air filter

Procedure

- 1 After you turn off the projector's power and the confirmation buzzer beeps twice, disconnect the power cable.
- 2 Open the air filter cover.
Slide the air filter cover open/close lever horizontally, and open the air filter cover.

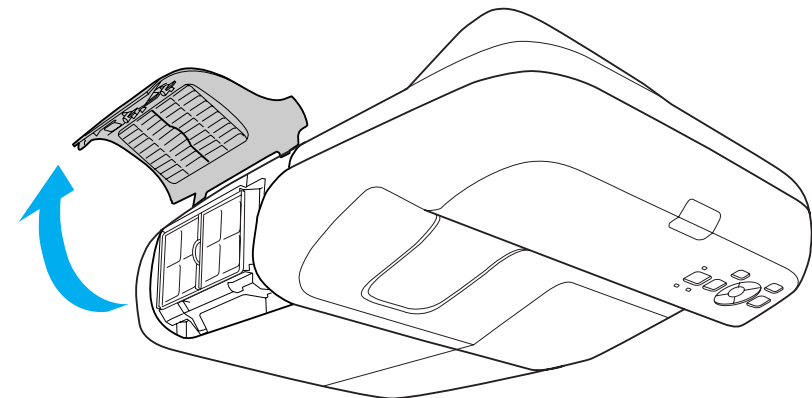
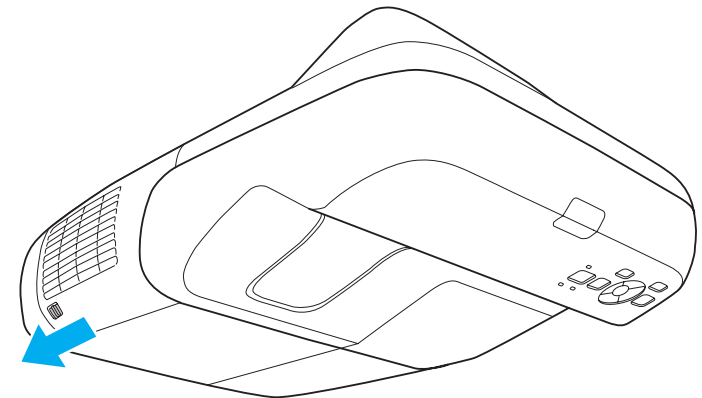

3 Remove the air filter.

Grip the tab in the center of the air filter, and pull the air filter straight out.

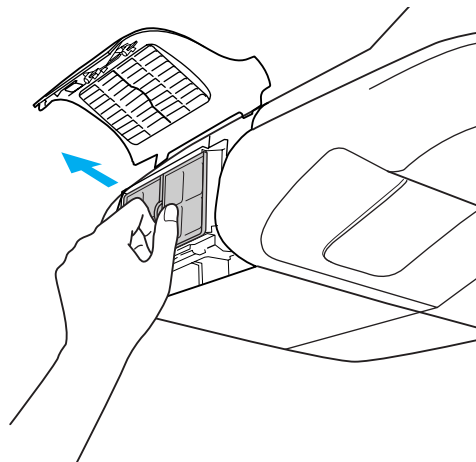

4 Install the new air filter.

Press until it clicks into place.

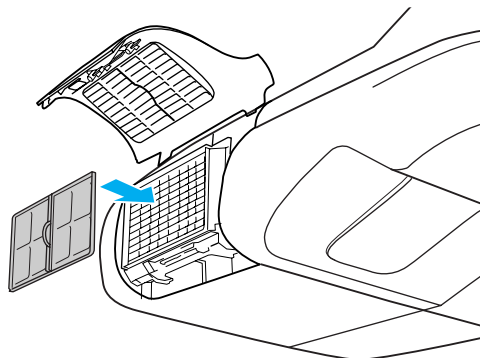

5 Close the air filter cover.



Dispose of used air filters properly in accordance with your local regulations.

Material of the frame part: ABS

Material of the filter part: Polyurethane foam

The following optional accessories and consumables are available. Please purchase these products as and when needed. The following list of optional accessories and consumables is current as of: 2010.01. Details of accessories are subject to change without notice and availability may vary depending on the country of purchase.

Optional accessories

Computer cable ELPKC02

(1.8 m - for mini D-Sub15-pin/mini D-Sub 15pin)

This is the same as the computer cable supplied with the projector.

Computer cable ELPKC09

(3 m - for mini D-Sub15-pin/mini D-Sub 15pin)

Computer cable ELPKC10

(20 m - for mini D-Sub15-pin/mini D-Sub 15pin)

These are extension cables for when the computer cable supplied with the projector is too short.

Component video cable ELPKC19

(3 m - for mini D-Sub 15-pin/RCA male×3)

Use to connect a [Component Video](#) source.

Document Camera ELPDC06

Use when projecting books, OHP documents, or slides. ["Connecting USB devices" p.34](#)

Wireless LAN unit ELPAP03

Use when connecting the projector to a computer wirelessly and projecting.

["Installing the Wireless LAN Unit" p.38](#)

Quick Wireless Connection USB Key ELPAP05

Use this key to connect to a Windows computer and project images from the computer. However, the projector needs to be connected to a network before it can be used.

Consumables

Lamp unit ELPLP57

Use as a replacement for a used lamp. ["Replacing the Lamp" p.111](#)

Air filter ELPAF27

Use as a replacement for a used air filter. ["Replacing the Air Filter" p.114](#)

To find the appropriate screen size, see the following table to setup the projector. Values are just reference.

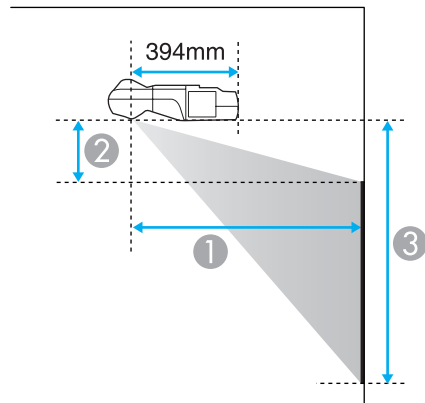

- ① Projection distance
- ② Height from the bottom edge of the projector to the top edge of the screen
- ③ Height from the bottom edge of the projector to the bottom edge of the screen

Projection Distance (EB-460i/460)

Units: cm

4:3 Screen Size		Minimum (Wide) to Maximum (Tele)		
		①	②	③
63"	128x96	47 - 63	9 - 31	105 - 127
70"	142x107	52 - 71	11 - 35	118 - 142
80"	163x122	60	13	135
90"	183x137	67	16	153
102"	207x155	76	18	174

Unit: cm

16:9 Screen Size		Minimum (Wide) to Maximum (Tele)		
		①	②	③
58"	128x72	47 - 64	21 - 31	94 - 128

16:9 Screen Size		Minimum (Wide) to Maximum (Tele)		
		①	②	③
65"	144x81	53 - 71	25 - 36	106 - 144
70"	155x87	57	27	114
80"	177x100	65	32	131
90"	199x112	73	36	148
93"	206x116	76	37	153

Unit: cm

16:10 Screen Size		Minimum (Wide) to Maximum (Tele)		
		①	②	③
60"	129x81	47 - 64	18 - 32	98 - 129
70"	151x94	55 - 75	21 - 38	116 - 151
80"	172x108	63	25	133
90"	194x121	71	29	150
96"	207x129	76	31	160

Projection Distance (EB-450Wi/450W/440W)

Unit: cm

16:10 Screen Size		Minimum (Wide) to Maximum (Tele)		
		①	②	③
60"	129x81	47 - 64	18 - 40	98 - 120
70"	151x94	55 - 75	21 - 47	116 - 141
80"	172x108	63	25	133
90"	194x121	71	29	150
96"	207x129	76	31	160

Unit: cm

4:3 Screen Size		Minimum (Wide) to Maximum (Tele)		
		①	②	③
53"	108x81	47 - 64	18 - 40	98 - 120
55"	112x84	49 - 66	18 - 41	102 - 125
60"	122x91	53 - 73	21 - 46	112 - 137
70"	142x107	63	25	132
80"	163x122	72	29	151
85"	173x130	76	31	161

Unit: cm

16:9 Screen Size		Minimum (Wide) to Maximum (Tele)		
		①	②	③
58"	128x72	47 - 64	21 - 39	94 - 120
65"	144x81	53 - 71	25 - 45	106 - 135
70"	155x87	57	27	114
80"	177x100	65	32	131
90"	199x112	73	36	148
93"	206x116	76	37	153

Supported Monitor Displays (EB-460i/460)

Computer signals (analog RGB)

Signal	Refresh Rate (Hz)	Resolution (dots)
VGA	60/72/75/85	640x480
SVGA	56/60/72/75/85	800x600
XGA	60/70/75/85	1024x768
WXGA	60	1280x768
	60	1360x768
	60/75/85	1280x800
WXGA+	60/75/85	1440x900
SXGA	70/75/85	1152x864
	60/75/85	1280x1024
	60/75/85	1280x960
SXGA+	60/75	1400x1050
UXGA	60	1600x1200
MAC13"	67	640x480
MAC16"	75	832x624
MAC19"	75	1024x768
	59	1024x768
MAC21"	75	1152x870

Images may also be projected when signals other than the above are input. However, some functions may be limited.

Component Video

Signal	Refresh Rate (Hz)	Resolution (dots)
SDTV (480i)	60	720x480
SDTV(576i)	50	720x576
SDTV(480p)	60	720x480
SDTV(576p)	50	720x576
HDTV(720p)	50/60	1280x720
HDTV(1080i)	50/60	1920x1080

Composite Video/S-Video

Signal	Refresh Rate (Hz)	Resolution (dots)
TV (NTSC)	60	720x480
TV(PAL, SECAM)	50/60	720x576

Supported Monitor Displays (EB-450Wi/450W/440W)

Computer signals (analog RGB)

Signal	Refresh Rate (Hz)	Resolution (dots)
VGA	60/72/75/85	640x480
SVGA	56/60/72/75/85	800x600
XGA	60/70/75/85	1024x768
WXGA	60	1280x768
	60	1360x768
	60/75/85	1280x800

Signal	Refresh Rate (Hz)	Resolution (dots)
WXGA+	60/75/85	1440x900
WSXGA+*	60	1680x1050
SXGA	70/75/85	1152x864
	60/75/85	1280x1024
	60/75/85	1280x960
SXGA+	60/75	1400x1050
UXGA	60	1600x1200
MAC13"	67	640x480
MAC16"	75	832x624
MAC19"	75	1024x768
	59	1024x768
MAC21"	75	1152x870

* Only compatible when **Wide** is selected as the **Resolution** from the Configuration Menu.  [p.75](#)

Images may also be projected when signals other than the above are input. However, some functions may be limited.

Component Video

Signal	Refresh Rate (Hz)	Resolution (dots)
SDTV(480i)	60	720x480
SDTV(576i)	50	720x576
SDTV(480p)	60	720x480
SDTV(576p)	50	720x576
HDTV(720p)	50/60	1280x720
HDTV(1080i)	50/60	1920x1080

Composite Video/S-Video

Signal	Refresh Rate (Hz)	Resolution (dots)
TV(NTSC)	60	720x480
TV(PAL, SECAM)	50/60	720x576

Command List

When the power ON command is transmitted to the projector, the power turns on and it enters warm-up mode. When the projector's power has turned on, a colon ":" (3Ah) is returned.

When a command is input, the projector executes the command and returns a ":", and then accepts the next command.

If the command being processed terminates abnormally, an error message is output and a ":" is returned.

Item		Command	
Power ON/OFF	On	PWR ON	
	Off	PWR OFF	
Signal selection	Computer1	Auto	SOURCE 1F
		RGB	SOURCE 11
		Component	SOURCE 14
	Computer2	Auto	SOURCE 2F
		RGB	SOURCE 21
		Component	SOURCE 24
	Video		SOURCE 41
	S-Video		SOURCE 42
	USB Display		SOURCE 51
	USB		SOURCE 52
	LAN		SOURCE 53
A/V Mute On/Off	On	MUTE ON	
	Off	MUTE OFF	
A/V Mute selection	Black	MSEL 00	
	Blue	MSEL 01	

Item	Command
Logo	MSEL 02

Add a Carriage Return (CR) code (0Dh) to the end of each command and transmit.

Cable Layouts

Serial Connection

- Connector shape: D-Sub 9-pin (male)
- Projector input port name: RS-232C

<At the projector>

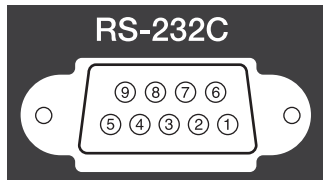

<At the computer>

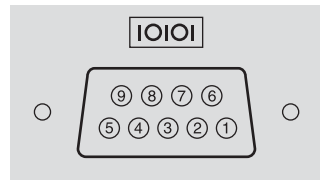

- Data length: 8 bit
- Parity: None
- Stop-bit: 1 bit
- Flow control: None

<At the projector>

(PC serial cable)

<At the computer>

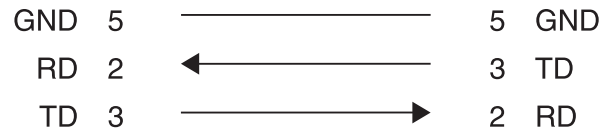

Signal Name	Function
GND	Signal wire ground
TD	Transmit data
RD	Receive data

Communications protocol

- Default baud rate setting: 9600 bps

PJLink Class1 was established by the JBMIA (Japan Business Machine and Information System Industries Association) as a standard protocol for controlling network-compatible projector's as part of their efforts to standardize projector control protocols.

The projector complies with the PJLink Class1 standard established by the JBMIA.

It complies with all commands except for the following commands defined by PJLink Class1, and agreement was confirmed by the PJLink standard adaptability verification.

URL:<http://pjlink.jbmia.or.jp/english/>

- **Non-compatible commands**

	Function	PJLink Command
Mute settings	Image muting set	AVMT 11
	Audio muting set	AVMT 21

- Input names defined by **PJLink** and corresponding projector sources

Source	PJLink Command
Computer1	INPT 11
Computer2	INPT 12
Video	INPT 21
S-Video	INPT 22
USB	INPT 41
LAN	INPT 52
USB Display	INPT 53

- Manufacturer name displayed for "Manufacture name information query"
EPSON

- Model name displayed for "Product name information query"

EB-460i
EB-460
EB-450Wi
EB-450W
EB-440W

Projector General Specifications

Product name		EB-460i	EB-460	EB-450Wi	EB-450W	EB-440W
Dimensions		369 (W) × 155 (H) × 483 (D) mm				
Panel size		0.63"		0.59" Wide		
Display method		Polysilicon TFT active matrix				
Resolution		786,432 XGA (1024 (W) × 768 (H) dots) × 3		1,024,000 pixels WXGA (1280 (W) × 800 (H) dots) × 3		
Focus adjustment		Manual				
Zoom adjustment		Digital (1-1.35)				
Lamp		UHE lamp, 230 W, Model No.: ELPLP57				
Max. audio output		10 W monaural				
Speaker		1				
Power supply		100 to 240 V AC ±10%, 50/60 Hz 3.7 to 1.6 A				
Power consumption	100 to 120 V area	Standby power consumption (Communication On): 10.0 W Standby power consumption (Communication Off): 0.3 W				
	220 to 240 V area	Standby power consumption (Communication On): 12.0 W Standby power consumption (Communication Off): 0.3 W				
Operating altitude		Altitude 0 to 2,286 m				
Operating temperature		+5 to +35° C (No condensation)				
Storage temperature		-10 to +60° C (No condensation)				
Mass	Without Slide Plate	Approx. 5.8 kg	Approx. 5.7 kg	Approx. 5.8 kg	Approx. 5.7 kg	
	With Slide Plate	Approx. 6.3 kg	Approx. 6.2 kg	Approx. 6.3 kg	Approx. 6.2 kg	

Connectors	Computer1 input port	1	Mini D-Sub 15-pin (female) blue
	Computer2 input port	1	Mini D-Sub 15-pin (female) blue
	Audio1 port	1	Stereo mini jack
	Audio2 port	1	Stereo mini jack
	Video input port	1	RCA pin jack
	S-Video input port	1	Mini DIN 4-pin
	Audio-L/R input port	1	RCA pin jack x 2 (L, R)
	Microphone (Mic) input port	1	Stereo mini jack
	Audio Output (Audio Out) port	1	Stereo mini jack
	Monitor Output (Monitor Out) port	1	Mini D-Sub 15-pin (female) black
	USB(TypeA) port* USB(TypeB) port*	1	USB connector (Type A) USB connector (Type B)
	USB port	1	USB Connector (Type A) for Optional Wireless LAN Unit
	LAN port	1	RJ-45
	RS-232C port	1	Mini D-Sub 9-pin (male)

* Supports USB 2.0. However, the operation of all USB compatible devices is not guaranteed.

This product is also designed for IT power distribution system with phase-to-phase voltage 230V.



Pixelworks DNX™ ICs are used in this projector.

Angle of tilt

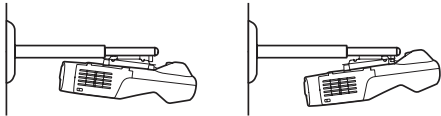

If you use the projector tilted at an angle of more than 5° it could be damaged and cause an accident.

(for Projector only)

DECLARATION of CONFORMITY

According to 47CFR, Part 2 and 15
Class B Personal Computers and Peripherals; and/or
CPU Boards and Power Supplies used with Class B Personal Computers

We: Epson America, Inc.
Located at: 3840 Kilroy Airport Way
MS: 3-13
Long Beach, CA 90806
Tel: 562-290-5254

Declare under sole responsibility that the product identified herein, complies with 47CFR Part 2 and 15 of the FCC rules as a Class B digital device. Each product marketed, is identical to the representative unit tested and found to be compliant with the standards. Records maintained continue to reflect the equipment being produced can be expected to be within the variation accepted, due to quantity production and testing on a statistical basis as required by 47CFR 2.909. Operation is subject to the following two conditions : (1) this device may not cause harmful interference, and (2) this device must accept any interference received, including interference that may cause undesired operation.

Trade Name: EPSON
Type of Product: LCD Projector
Model: H317C/H318C/H342C

(for Projector and Easy Interactive Pen)

**FCC Compliance Statement
For United States Users**

This equipment has been tested and found to comply with the limits for a Class B digital device, pursuant to Part 15 of the FCC Rules. These limits are designed to provide reasonable protection against harmful interference in a residential installation. This equipment generates, uses, and can radiate radio frequency energy and, if not installed and used in accordance with the instructions, may cause harmful interference to radio or television reception. However, there is no guarantee that interference will not occur in a particular installation. If this equipment does cause interference to radio and television reception, which can be determined by turning the equipment off and on, the user is encouraged to try to correct the interference by one or more of the following measures.

- Reorient or relocate the receiving antenna.
- Increase the separation between the equipment and receiver.
- Connect the equipment into an outlet on a circuit different from that to which the receiver is connected.
- Consult the dealer or an experienced radio/TV technician for help.

WARNING

The connection of a non-shielded equipment interface cable to this equipment will invalidate the FCC Certification or Declaration of this device and may cause interference levels which exceed the limits established by the FCC for this equipment. It is the responsibility of the user to obtain and use a shielded equipment interface cable with this device. If this equipment has more than one interface connector, do not leave cables connected to unused interfaces. Changes or modifications not expressly approved by the manufacturer could void the user's authority to operate the equipment.

(for Easy Interactive Pen only)

Since the Easy Interactive Pen is so small, FCC Statement for Verification is written in the manual.

FCC Statement for Verification

This device complies with Part 15 of the FCC Rules. Operation is subject to the following two conditions:(1) this device may not cause harmful interference, and (2) this device must accept any interference received, including interference that may cause undesired operation.

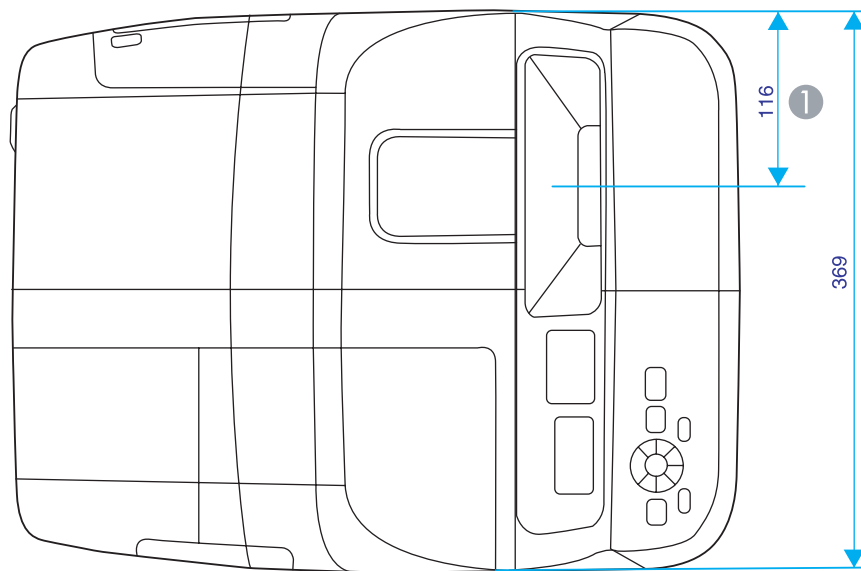
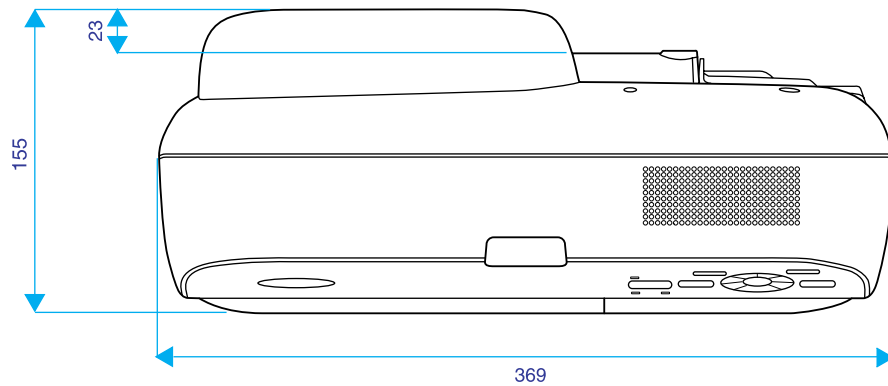

① Distance until projection center

With Slide Plate

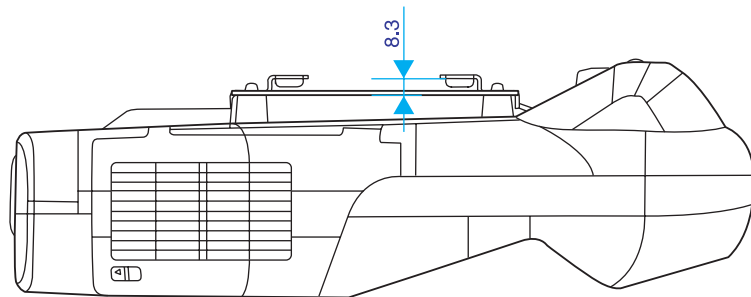
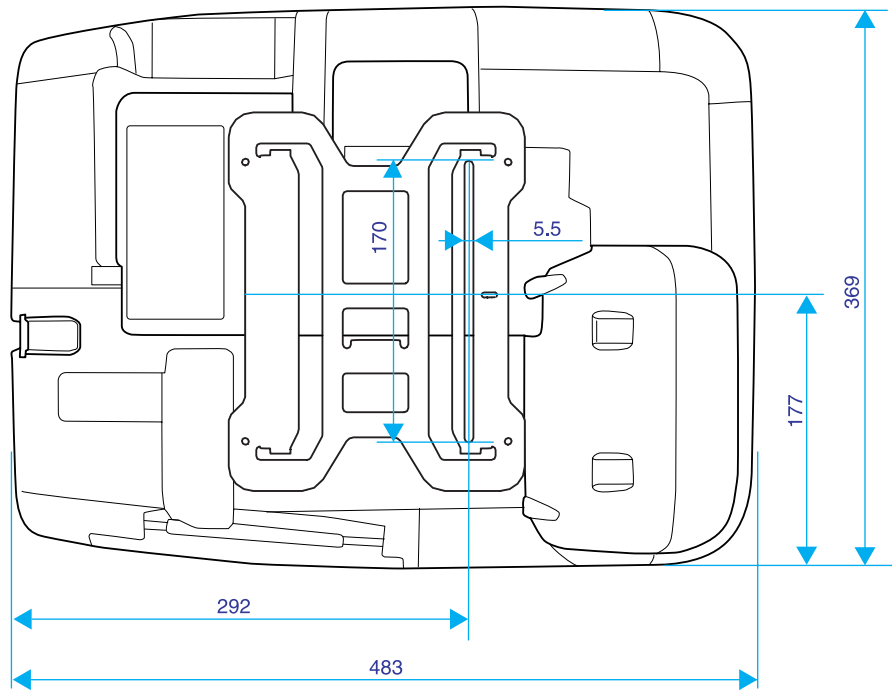

Without Slide Plate

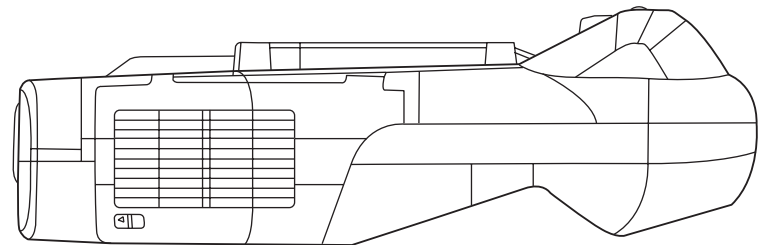
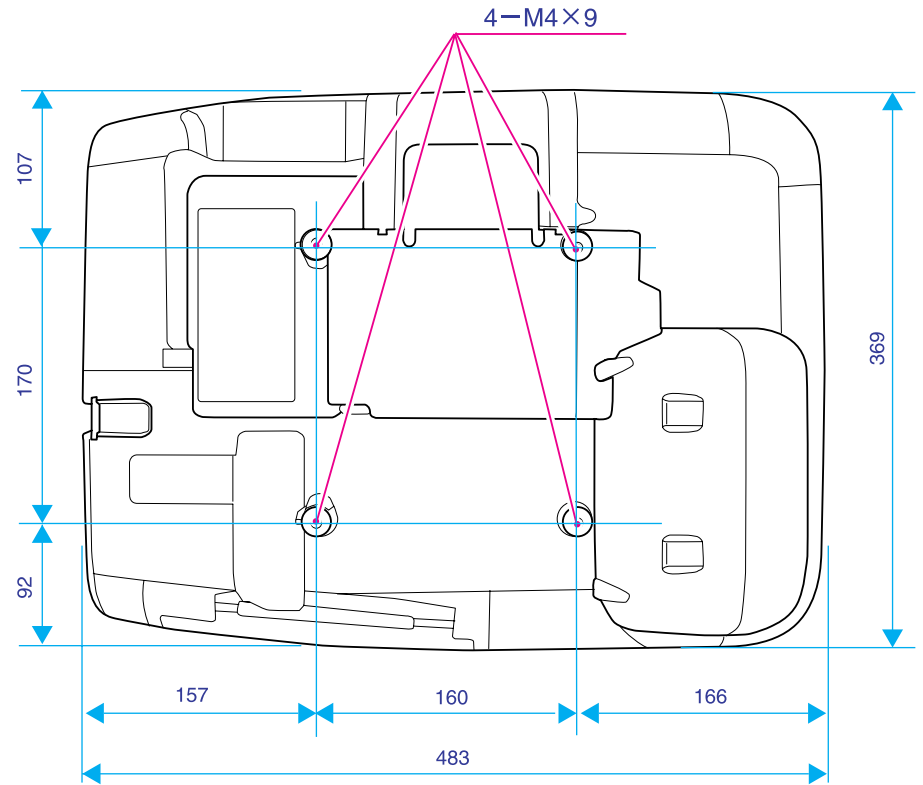

This section explains easily terms that are used with the projector and difficult terms that are not explained in the text of this guide. For details, refer to other commercially available publications.

AMX Device Discovery	AMX Device Discovery is a technology developed by AMX to facilitate AMX control systems for easy operation of the target equipment. Epson have implemented this protocol technology, and have provided a setting to enable the protocol function (ON). See the AMX Web site for more details. URL http://www.amx.com/
Aspect Ratio (Aspect Ratio)	The ratio between an image's length and its height. HDTV images have an aspect ratio of 16:9 and appear elongated. The aspect ratio for standard images is 4:3.
Component Video	A Video signal which has the luminance component and color component separated to provide better image quality. Refers to images that consist of three independent signals: Y (luminance signal), Pb and Pr (color difference signals).
Composite video	Video signals that have the video brightness signals and color signals mixed together. The type of signals commonly used by household video equipment (NTSC, PAL, and SECAM formats). The carrier signal Y (luminance signal) and chroma (color) signal that are contained in the color bar are overlapped to form a single signal.
Contrast	The relative brightness of the light and dark areas of an image can be increased or decreased to make text and graphics stand out more clearly, or to make them appear softer. Adjusting this particular property of an image is called Contrast adjustment.
DHCP	An abbreviation of Dynamic Host Configuration Protocol, this protocol automatically assigns an IP Address to equipment connected to a Network.
Dolby Digital	A sound format developed by Dolby Laboratories. Normal stereo is a 2-channel format that uses two speakers. Dolby Digital is a 6-channel (5.1-channel) system which adds to this a center speaker, two rear speakers, and a sub-woofer.
Gateway address (Gateway address)	This is a server (router) for communicating across a Network (subnet) divided according to Subnet Mask .
HDTV	An abbreviation for High-Definition Television that refers to high-definition systems which satisfy the following conditions. <ul style="list-style-type: none"> • Vertical resolution of 720p or 1080i or greater (p = Progressive, i = Interlace) • Screen Aspect Ratio of 16:9 • Dolby Digital audio reception and playback (or output)
Interlace	A method of image scanning whereby the image data is divided into fine horizontal lines that are displayed in sequence starting from left to right and then from top to bottom. The even-numbered lines and odd-numbered lines are displayed alternately.
IP Address	A number to identify a computer connected to a Network.
Progressive	A method of image scanning whereby the image data from a single image is scanned sequentially from top to bottom to create a single image.
Refresh Rate	The light-emitting element of a display maintains the same luminosity and color for an extremely short time. Because of this, the image must be scanned many times per second to refresh the light-emitting element. The number of refresh operations per second is called the Refresh Rate and is expressed in hertz (Hz).

SDTV	An abbreviation for Standard Definition Television that refers to standard television systems which do not satisfy the conditions for HDTV ▶ High-Definition Television.
SNMP	An abbreviation for Simple Network Management Protocol, which is the protocol for monitoring and controlling devices such as routers and computers connected to a TCP/IP Network.
sRGB	An international standard for color intervals that was formulated so that colors that are reproduced by video equipment can be handled easily by computer operating systems (OS) and the Internet. If the connected source has an sRGB mode, set both the projector and the connected signal source to sRGB.
SSID	SSID is identification data for connecting to another device on a Wireless LAN. Wireless communication is possible between devices with matching SSID.
Subnet mask (Subnet mask)	This is a numerical value that defines the number of bits used for the Network address on a divided network (subnet) from the IP Address.
SVGA	A type of video signal with a resolution of 800 (horizontal) × 600 (vertical) dots that is used by IBM PC/AT-compatible computers.
S-Video	A Video signal which has the luminance component and color component separated to provide better image quality. Refers to images that consist of two independent signals: Y (luminance signal) and C (color signal).
SXGA	A type of video signal with a resolution of 1,280 (horizontal) × 1,024 (vertical) dots that is used by IBM PC/AT-compatible computers.
Sync.	The signals output from computers have a specific frequency. If the projector frequency does not match this frequency, the resulting images are not of a good quality. The process of matching the phases of these signals (the relative position of the crests and the troughs in the signal) is called Synchronization. If the signals are not synchronized, flickering, blurriness, and horizontal interference occur.
Tracking	The signals output from computers have a specific frequency. If the projector frequency does not match this frequency, the resulting images are not of a good quality. The process of matching the frequency of these signals (the number of crests in the signal) is called Tracking. If Tracking is not carried out correctly, wide vertical stripes appear in the signal.
Trap IP Address	This is the IP Address ▶ for the destination computer used for error notification in SNMP.
VGA	A type of video signal with a resolution of 640 (horizontal) × 480 (vertical) dots that is used by IBM PC/AT-compatible computers.
WPS	WPS is an abbreviation of Wi-Fi Protected Setup. Wi-Fi Protected Setup has been devised by the Wi-Fi Alliance as a means of easily setting up and securing a Wireless LAN.
XGA	A type of video signal with a resolution of 1,024 (horizontal) × 768 (vertical) dots that is used by IBM PC/AT-compatible computers.