

Notice

© 2000 Compaq Computer Corporation.

COMPAQ and the Compaq logo Registered in U.S. Patent and Trademark Office.

Microsoft, Windows, and Windows NT are registered trademarks of Microsoft Corporation in the United States and/or other countries.

All other product names mentioned herein may be trademarks or registered trademarks of their respective companies.

Compaq shall not be liable for technical or editorial errors or omissions contained herein. The information in this document is subject to change without notice and is provided “as is” without warranty of any kind. The entire risk arising out of the use of this information remains with the recipient. In no event shall Compaq be liable for any direct, consequential, incidental, special, punitive, or other damages whatsoever (including without limitation, damages for loss of business profits, business interruption, or loss of business information), even if Compaq has been advised of the possibility of such damages. The limited warranties for Compaq products are exclusively set forth in the documentation accompanying such products. Nothing herein should be construed as constituting a further or additional warranty.

User's Guide

Compaq MP2800 Microportable Projector

First Edition October 2000

Published in U.S.A., U.K., Singapore, and Taiwan.

Documentation Part Number 216023-001

Using This Guide

The User's Guide includes general information about your projector, troubleshooting and diagnostics, and technical specifications.

Symbols and Conventions

The following words and symbols mark special messages throughout this guide:



Text set off in this manner presents clarifying information, specific instructions, commentary, sidelights, or interesting points of view.



WARNING: Text set off in this manner indicates that failure to follow directions could result in bodily harm or loss of life.



CAUTION: Text set off in this manner indicates that failure to follow directions could result in damage to equipment or loss of information.

Warning Messages

Before operating the projector, please read the following messages.



WARNING:

- To reduce the risk of harm to your eyes, do not look directly into the bright light of the projection lens.
 - To reduce the risk of fire or electric shock, do not expose this product to rain or moisture.
 - To reduce the risk of electric shock, do not disassemble the projector other than to replace the lamp module.
 - To reduce the risk of personal injury, allow the unit to cool down before changing the lamp, and always unplug the power cord first.
-

Chapter 1

Getting Started

Product Features

The Compaq MP2800 Microportable Projector generates crisp, clear images onto a projection screen by using Digital Light Processing (DLP) technology. The microportable projector offers the latest in portable projection technology, including:

- 1024 × 768 native XGA resolution
- Maximum resolution: 1280 x 1024
- HDTV capable 720p and 1080i via DVI port and 1080p via VGA port
- User replaceable 130 watt high-efficiency, long-life lamp
- Manual 1.2:1 zoom lens
- Electronic scaling to 32X
- Weighs 3.00 pounds (1.36 kg)
- Convenient auto-image adjustment
- 16.7 million displayable colors
- Flash ROM upgradeable
- Connector options:
 - Standard analog VGA
 - Digital DVI
 - S-video (with Multimedia Adapter) [optional use]
 - Composite video (with Multimedia Adapter) [optional use]
- Multimedia Adapter with speaker [optional use]
- Full-featured remote control with remote mouse capabilities [optional use]
- Multilingual on-screen adjustment menu
- Plug and Play capability
- Projector carrying case
- Compaq Presentation utility allows quick setup with portable computers

- Compaq Projector Display Assistant utility to adjust screen settings
- Security lock slot

Introduction

Before setting up your Compaq Microportable Projector, be sure your shipping box includes the following items:

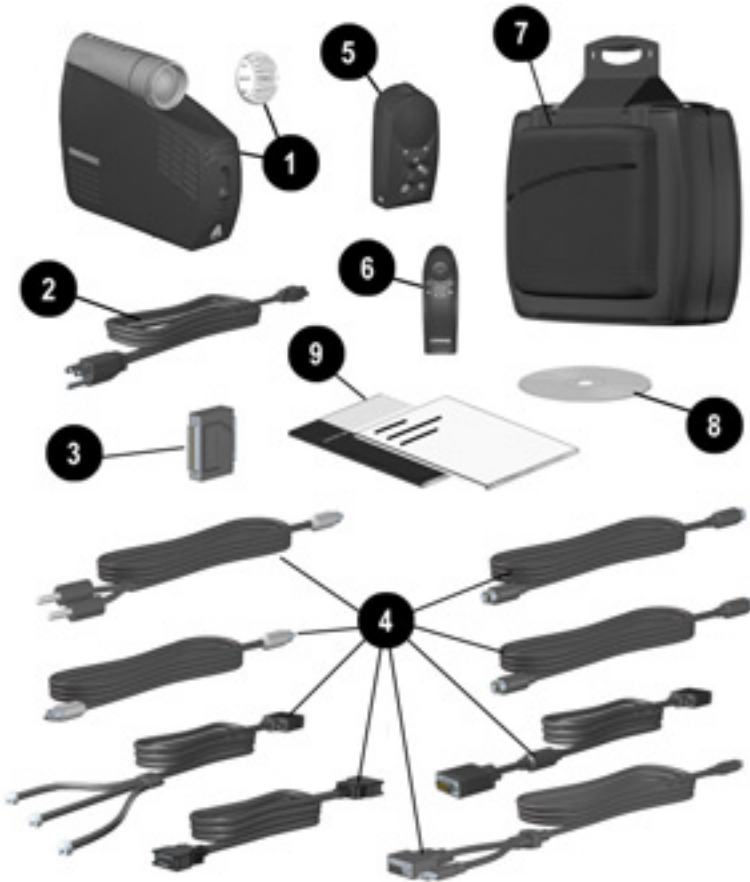

- ❶ Projector and lens cap
- ❷ 10-foot power cable
- ❸ RS232 (serial) to DVI upgrade adapter
- ❹ Eight signal cables:
 - One VGA signal cable for use with computers, portables, and some handheld products
 - One digital DVI to DVI signal cable for use with compatible digital sources
 - S-video cable (for connecting digital devices such as a DVD player, camcorder, etc.)
 - Composite video cable (for connecting to a videocassette recorder)
 - Audio cables (2; one cable has mini connectors on both ends and is used to connect the Multimedia Adapter to a computer; the other cable has two RCA connectors on one end and a mini connector on the other end and is used to connect a videocassette recorder to a computer)
 - Remote control Y-cable
8-pin to USB/RS232 Y-cable used to connect the Multimedia Adapter to a computer for use with the remote control. When using the Y-cable, do not connect both the USB and RS232 connectors to a computer at the same time. The USB connector is the preferred connector.
NOTE: The remote control Page Up and Page Down functions require an additional driver when used with the RS232 connector. This driver can be found on the CD-ROM that came with your projector.
 - Component HDTV to VGA cable (optional use)
- ❺ Compaq Multimedia Adapter (optional use)
- ❻ Remote control, including two AAA batteries (optional use)
- ❼ Carrying case
- ❽ CD-ROM containing the Compaq Presentation utility program, Compaq Projector Display Assistant utility, RS232 driver, and the *User's Guide*
- ❾ Two Quick Setup cards and the *Agency Regulatory Notices* booklet

If your shipping box does not contain all of the listed items, please contact your Compaq authorized dealer, reseller, or service provider.

Setting Up the Projector

Follow the instructions below and on the following pages to set up the projector. Separate setup instructions are described for the following products:

- Portable computers
- Desktop computers
- Compaq PC Companions with VGA capability
- Videocassette recorder, DVD, or camcorder (requires optional Multimedia Video Adapter)



The projector is hot pluggable and can be connected to any video input source while the source is in use.

IMPORTANT: Place the projector on a stable desk or table at a distance not less than 3.74 feet (1.14 meters) and not greater than 32.8 feet (10 meters) from the projection screen.



WARNING: To reduce the risk of electric shock or damage to your equipment:

- Do not disable the power cord grounding plug. The grounding plug is an important safety feature.
 - Plug the power cord into a grounded (earthed) electrical outlet that is easily accessible at all times.
 - Disconnect power from the projector by unplugging the power cord from the electrical outlet.
 - Do not place anything on power cords or cables. Arrange them so that no one may accidentally step on or trip over them. Do not pull on a cord or cable. When unplugging from the electrical outlet, grasp the cord by the plug.
-

Balancing the Projector

The projector has a built-in elevator foot used to balance and elevate the projector. Always balance the projector before connecting any device to it.

Turn the elevator foot sideways to balance the projector.



WARNING: To reduce the risk of the projector tipping or overturning, always turn the elevator foot 90° from its original position before pressing the elevator button. Refer to the “Adjusting the Projector Height” section later in this chapter.

Connecting the Projector to a Portable Computer

1. Rotate the elevator foot to balance the projector.
2. Connect one end of the projector signal cable to the projector and the other end to the VGA connector **1B** or the DVI connector **1A** on the portable computer and tighten the screws.



Be sure the signal cable aligns with the connector. Do not force the cable onto the connector or you may damage the signal cable or the projector.

3. Connect one end of the power cord **2** into the back of the projector, and the other end to an electrical outlet that is easily accessible and close to the projector. The projector will automatically be placed into Standby mode.

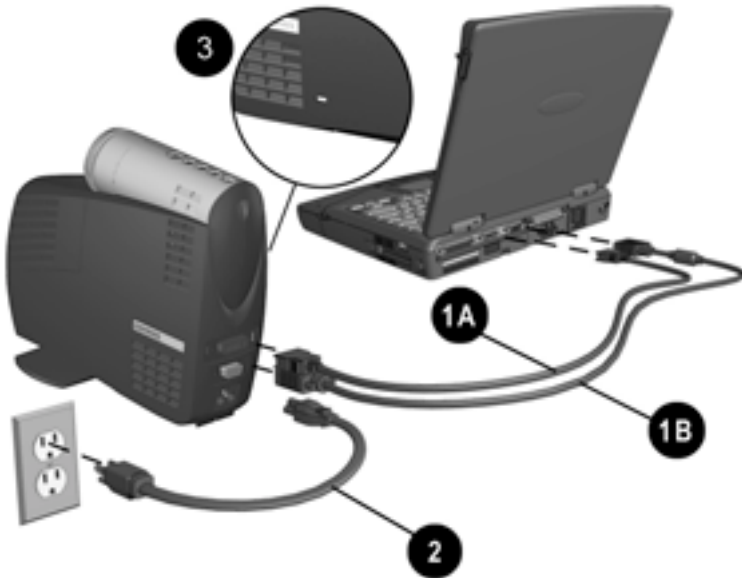

4. Press the blue Standby button on the top of the projector to turn on the projector first, then turn on the computer.



For security purposes, this projector has been fitted with a security lock slot **3** (located on the left, front side) for use with a security cable lock that can be purchased separately at most computer stores.

Connecting the Projector to a Desktop Computer

1. Rotate the elevator foot to balance the projector.
2. Connect one end of the projector signal cable **1B** to the projector and the other end to the VGA connector on the desktop computer and tighten the screws.



If your computer has a digital connector, connect one end of the DVI signal cable **1A** to the digital connector on the projector and the other end to the digital connector on the computer.



Be sure the signal cable aligns with the connector. Do not force the cable onto the connector or you may damage the signal cable or the projector.

3. Connect one end of the power cord **2** into the back of the projector, and the other end to an electrical outlet that is easily accessible and close to the projector. The projector will automatically be placed into Standby mode.

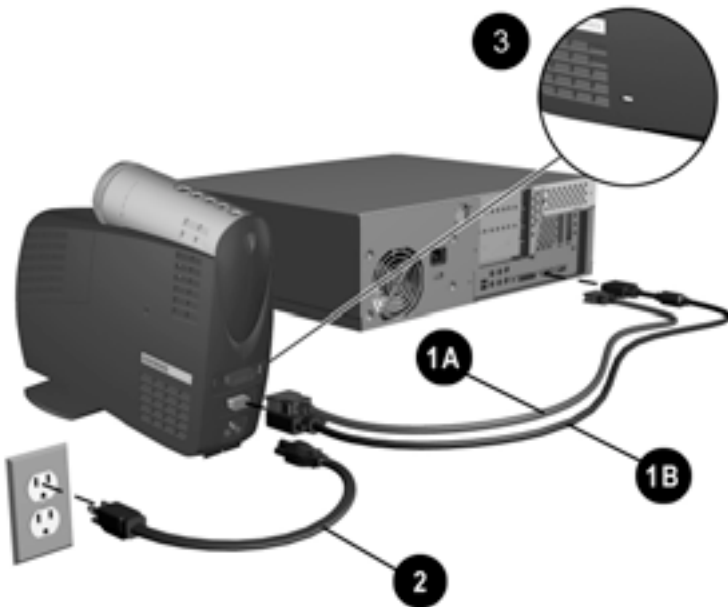

4. Press the blue Standby button on the top of the projector to turn on the projector first, then turn on the computer.



For security purposes, this projector has been fitted with a security lock slot  (located on the left, front side) for use with a security cable lock that can be purchased separately at most computer stores.

Connecting the Projector to a Compaq PC Companion

To connect the projector to a Compaq PC Companion, the PC Companion must have a male connector adapter and a VGA-out PC Card with a 15-pin connector.



The VGA-out PC Card with the 15-pin connector is not included with the Compaq PC Companion. It is sold separately. For information on purchasing this card, call your Compaq authorized dealer or reseller. To locate a reseller near you, check the “Worldwide Telephone Numbers” booklet that came with your projector or visit the Compaq website at <http://www.compaq.com>.

1. Rotate the elevator foot to balance the projector.
2. Connect one end of the signal cable  to the projector and connect the other end to the VGA-out PC Card. The VGA-out PC Card may be inserted into the PC slot on the Compaq PC Companion before or after connecting the signal cable.



Be sure the signal cable aligns with the connector. Do not force the cable onto the connector or you may damage the signal cable or the projector.

3. Connect one end of the power cord ❷ into the back of the projector, and the other end to an electrical outlet that is easily accessible and close to the projector. The projector will automatically be placed into Standby mode.



4. Press the blue Standby button on the top of the projector to turn on the projector first, then turn on the computer.



For security purposes, this projector has been fitted with a security lock slot ❸ (located on the left, front side) for use with a security cable lock that can be purchased separately at most computer stores.

Connecting the Projector to Other Video Sources

The optional Compaq Multimedia Adapter must be used to connect the projector to a camcorder, DVD player, or videocassette recorder. This adapter converts signals from the camcorder, DVD player, or videocassette recorder for compatibility with the projector.

Refer to Chapter 3, “Using the Compaq Multimedia Adapter,” for information on attaching and using the Compaq Multimedia Adapter.

Powering On the Projector

Follow these instructions to power on the projector:

1. Make sure the computer and projector power cords and the signal cable are securely connected.



Make sure the projector is perpendicular to the projection screen.

2. Remove the lens cap by squeezing the tabs ❶ and pulling the lens cap straight out ❷.
3. Press the blue Standby button ❸ on the top of the projector and allow the projector to warm up for one to two minutes.

When the projector has warmed up, the Compaq startup screen displays and the LED on the **Standby** button turns green.



4. Turn on the video source (computer, PC Companion, videocassette recorder, etc.) and launch the software application being used to display images on the projection screen. If applicable, press the Function key on the computer designated for external display.

 If there is a long delay between the time the startup screen displays and the time the presentation software is launched, the lamp may shut off and the projector will automatically go into standby mode. If this happens, press the **Standby** button to power on the lamp.

 When the startup screen disappears, the video from the attached computer displays. If there is no incoming video, the “Check Video Cable” message will display on the projection screen.

Powering Off the Projector

1. Press the **Standby** button ❶ to turn off the projector lamp.

The message “Going to Standby” displays and the LED on the **Standby** button blinks amber.

IMPORTANT: Allow the projector to cool down for about five to ten minutes before turning it off.

2. Disconnect the power cord from the electrical outlet and the projector ❷.



CAUTION: After the projector is turned off, wait at least one minute before turning the projector back on. Failure to follow this caution can result in damage to the projector.



Adjusting the Projected Image

There are three ways to adjust the projected image:

- Adjusting the projector height
- Adjusting the projector focus
- Adjusting the projector zoom

Adjusting the Projector Height

The projector has a built-in elevator foot that can raise the projector approximately 1 inch (2.54 cm). To adjust the height:

1. Ensure the foot is turned 90° to balance the projector.
2. Raise the projector to the desired display angle, then press the elevator button **1** to release the elevator foot **2**.



3. To lower the display angle, press the elevator button again and press down on the projector to lower it.



CAUTION: Failure to press the elevator button before adjusting the elevator foot can result in damage to the elevator mechanism.

Adjusting the Projector Focus

To focus the projected image, rotate the focus ring **1** until the image is clear. The projector will focus at distances from 3.74 (1.14 meters) to 32.8 feet (10 meters).

If vertical bars appear on the display after adjusting the focus, press the **Resync** button **2** to automatically synchronize and track the display. If the button does not correct the display, use the Digital Conversion feature in the on-screen menu to manually adjust the synchronization and tracking. Refer to the “Adjusting the On-Screen Menus” section in Chapter 2.



Adjusting the Projector Zoom

To adjust the size of the projected image, rotate the zoom lever until the projected image is the desired size.



Image Size Adjustment

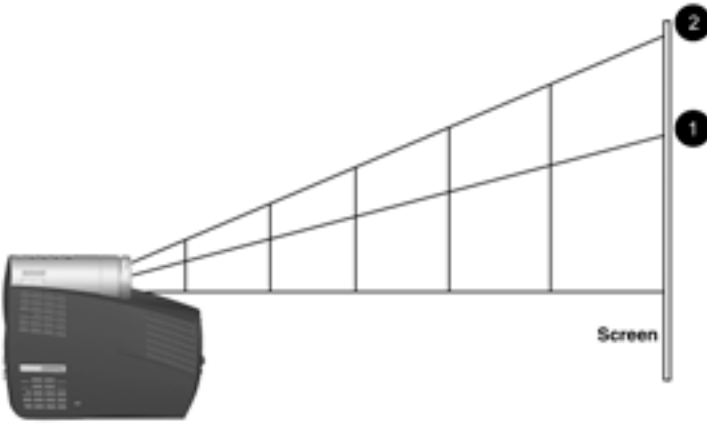

Projected image sizes at minimum zoom ①

Distance	3.74 ft. (1.14m)	6.54 ft. (2m)	9.84 ft. (3m)	13.12 ft. (4m)	16.40 ft. (5m)	19.69 ft. (6m)	22.97 ft. (7m)	26.25 ft. (8m)	29.53 ft. (9m)	32.81 ft. (10m)
Diagonal	1.87 ft. (.57m)	3.31 ft. (1.01m)	5.02 ft. (1.53m)	6.69 ft. (2.04m)	8.37 ft. (2.55m)	10.07 ft. (3.07m)	11.75 ft. (3.58m)	13.42 ft. (4.09m)	15.12 ft. (4.61m)	16.80 ft. (5.12m)
Width	1.51 ft. (.46m)	2.66 ft. (.81m)	4.00 ft. (1.22m)	5.35 ft. (1.63m)	6.69 ft. (2.04m)	8.04 ft. (2.45m)	9.38 ft. (2.86m)	10.76 ft. (3.28m)	12.11 ft. (3.69m)	13.45 ft. (4.10m)
Height	1.12 ft. (.34m)	2.00 ft. (.61m)	3.02 ft. (.92m)	4.00 ft. (1.22m)	5.02 ft. (1.53m)	6.04 ft. (1.84m)	7.05 ft. (2.15m)	8.07 ft. (2.46m)	9.06 ft. (2.76m)	10.07 ft. (3.07m)

Projected image sizes at maximum (1.2) zoom ②

Distance	3.74 ft. (1.14m)	6.54 ft. (2m)	9.84 ft. (3m)	13.12 ft. (4m)	16.40 ft. (5m)	19.69 ft. (6m)	22.97 ft. (7m)	26.25 ft. (8m)	29.53 ft. (9m)	32.81 ft. (10m)
Diagonal	2.26 ft. (.69m)	4.00 ft. (1.22m)	6.00 ft. (1.83m)	8.04 ft. (2.45m)	10.04 ft. (3.06m)	12.07 ft. (3.68m)	14.11 ft. (4.30m)	16.11 ft. (4.91m)	18.14 ft. (5.53m)	20.18 ft. (6.15m)
Width	1.80 ft. (.55m)	3.18 ft. (.97m)	4.82 ft. (1.47m)	6.43 ft. (1.96m)	8.04 ft. (2.45m)	9.65 ft. (2.94m)	11.29 ft. (3.44m)	12.89 ft. (3.93m)	14.50 ft. (4.42m)	16.14 ft. (4.92m)
Height	1.35 ft. (.41m)	2.40 ft. (.73m)	3.61 ft. (1.10m)	4.82 ft. (1.47m)	6.04 ft. (1.84m)	7.25 ft. (2.21m)	8.46 ft. (2.58m)	9.68 ft. (2.95m)	10.89 ft. (3.32m)	12.11 ft. (3.69m)



If the projector is used at the maximum distance in this chart, the display may appear to be dimmer than usual.

Using the Compaq Presentation Utility

The Compaq Presentation utility included on the CD-ROM is for use with portable computers. The purpose of the Presentation utility is to disable power management features of the portable computer while the Compaq Microportable Projector is connected to it. The utility also disables the computer's screen savers and auto-suspend feature while the utility is running.

A graphical user interface (GUI) is required to control the projector's resolution settings and the enabled/disabled status. The Compaq Presentation utility supports the following GUI operating systems: Microsoft Windows 95, Windows 98, Windows NT 4.0, and Windows 2000.

To install the Presentation utility onto a portable computer:

1. Insert the CD-ROM into the computer's CD-ROM drive. The CD-ROM menu will automatically launch on the screen.
2. From the launch menu, click "Install Software→Install Presentation Utility" and follow the on-screen instructions.
3. Select Next in the dialog box to install the program. The Presentation utility installs on the hard drive and you are prompted to restart the computer. Upon restart, a program icon (yellow beam of light containing a Q) is placed in the Windows system tray.
4. Double-click the program icon to launch the Presentation Properties dialog box.
5. Set the Presentation Mode Duration time in the dialog box.

The dialog box has default settings enabled to turn off the computer's power management features and screen saver features.

6. Select OK from the dialog box to execute the settings. The software dialog box closes and the computer is ready to continue with the presentation.

When the installation is complete, the appropriate language is installed on the computer based on the computer's operating system language. If the computer's operating system language is not included as one of the installation languages, then, by default, the English version will install on the computer.

Using the Compaq Projector Display Assistant Utility

The Compaq Projector Display Assistant utility included on the CD-ROM is an adjustment tool for improving the display quality of the projector. Adjustments need to be made when the projector is first attached to a computer or when a different display mode is selected for the first time. This utility can be run directly from the CD-ROM or copied to a directory on the computer hard drive and run from there.

To run the Projector Display Assistant utility for Microsoft Windows 95, Windows 98, Windows NT 4.0, or Windows 2000:





1. Insert the CD-ROM into the computer's CD-ROM drive. The CD-ROM menu will automatically launch on the screen.
2. From the launch menu, click "Install Software→Install Compaq's Projector Display Assistant" and follow the on-screen instructions.

Chapter 2

Using the Projector

Identifying the Projector Buttons



Symbol	Control	Function
① 	Standby button	<p>Powers the projector lamp on and off. The Standby LED changes color modes to indicate the following operating modes:</p> <ol style="list-style-type: none"> 1. Flashing amber indicates the projector is going into standby mode and cannot be restarted until the LED glows amber steadily. 2. All five LED buttons rapidly flashing amber indicate the lamp has overheated and the projector has automatically shut down.
② 	Select button	<ol style="list-style-type: none"> 1. Launches first, second, and third-level on-screen menus. 2. Exits the on-screen menus.
③ 	Minus button	Selects and adjusts the on-screen scroll down menu functions.
④ 	Plus button	Selects and adjusts the on-screen scroll up menu functions.
⑤ 	Resync button	Automatically synchronizes the projector to track the input source.

IMPORTANT: To use standby mode, press the **Standby** button and, after a six to ten-second delay, the unit enters Standby mode and the projector lamp turns off. A “Going to Standby” message appears on the screen for the duration of the six to ten-second delay. When the message disappears from the screen, there is a 45-second delay before the lamp can be turned back on. Wait 45 seconds to allow the lamp to cool before pressing the **Standby** button again.

Introducing the Analog On-Screen Menu

The adjustments for screen settings are located in the on-screen menu and can be viewed in one of the available languages.

Analog On-Screen Menu Adjustments

To display the analog on-screen menu, press the **Select** button. The following menu shows the functions at each level:

Main Menu	Menu Level 2	Menu Level 3
Brightness	Adjustment scale	
Contrast	Adjustment scale	
Position	Horizontal Position	Adjustment scale
	Vertical Position	Adjustment scale
	Save and Return	
	Cancel	
Zoom	Zoom	Adjustment scale
	Panning Left-Right	Adjustment scale
	Panning Up-Down	Adjustment scale
	Save and Return	
	Cancel	
Keystone	Adjustment scale	
Picture	Dark - Light	
	Save and Return Cancel	
Color	(Color temperature)	
	Custom Color	Adjustment scale
	Saturation	Adjustment scale
	Save and Return	
	Cancel	
Digital Conversion	Clock	Adjustment scale
	Clock Phase	Adjustment scale
	Save and Return	
	Cancel	

Continued

Analog On-Screen Menu *(continued)*

Main Menu	Menu Level 2	Menu Level 3
Language	Deutsche English Espanol Francais Italiano Nederlands Japanese S. Chinese Save and Return	
Menu Location	Up-Down Left-Right Save and Return Cancel	Adjustment scale Adjustment scale
HDTV Setup	HDTV Fill Screen HDTV Fill to Aspect Ratio Save and Return Cancel	YPrPb RGB YPrPb RGB
Management	Power Saver Lamp Hours Reset Lamp Hours Flip Image Serial Number Master Reset Save and Return Cancel	On-Off Display hours - 5 digits Confirmation Horizontal Vertical Both Save and Return Cancel Display Serial Number Confirmation
Factory Reset	Confirm Reset	
Exit		

Adjusting the On-Screen Menus

To launch and make adjustments to the Main and Video on-screen menus:

1. Press the **Select** button **1** on the projector panel or the remote control. The Main menu will display on the projection screen.
2. To select a function, press the **Minus (-)** button **2** to scroll down the Display menu. To reverse the scroll direction, press the **Plus (+)** button **3**.
3. Highlight the function to be adjusted and press the **Select** button **1** again.

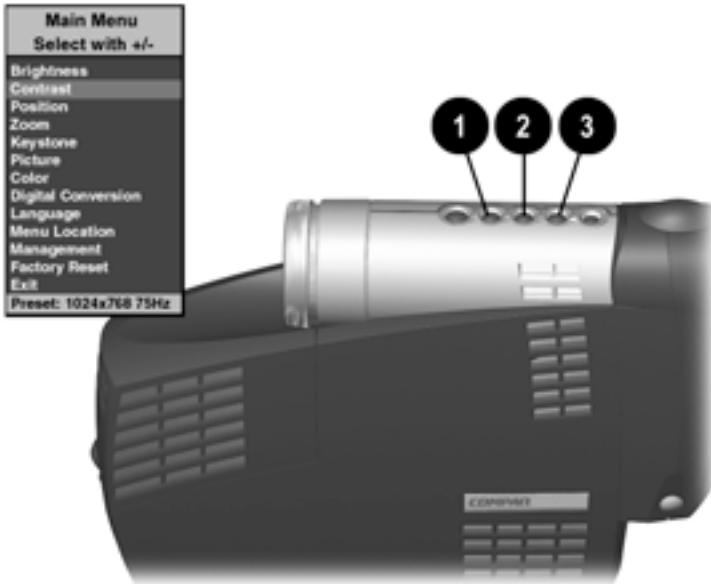

The bar on the bottom of the on-screen menu shows the current operating resolution.

For example, to select the **Position** function, press the **Minus** button **2** until **Position** is highlighted, then press the **Select** button **1** to display the level 2 menu for **Position**. The level 2 menu displays expanded menu items.

4. To make a selection from the level 2 menu, press the **Minus (-)** button to scroll down the level 2 menu, or press the **Plus (+)** button to reverse the scroll direction.
5. Highlight the selection and press the **Select** button to confirm the selection. The level 3 menu displays.
6. Level 3 for **Position** functions display the adjustment scales. Use the **Minus** button to decrease and the **Plus** button to increase the screen Horizontal and Vertical positions.



Some menu functions display adjustment scales in the level 2 menu, while others display adjustment scales in the level 3 menu.

7. After making the adjustment, select **Save and Return**. To void any changes made, select **Cancel** instead of **Save and Return**.
8. To exit from the on-screen menu, select **Exit** from the Main menu. If the display is a second or third-level menu, select **Save and Return** or **Cancel**, then select **Exit** from the Main menu.

Explaining Functions in the Analog On-Screen Menu

- **Brightness and Contrast**—Adjusts the displayed image brightness and contrast ranges from 0 to 100.



An example of a standard setting is to set the contrast level to 67 and the brightness level to 50.

- **Position**—Fine-tunes the horizontal and vertical positions of the display.
- **Zoom**—Magnifies an image up to a factor of 32 on the projection screen (zooms in to a specific area on the screen, and pans left, right, up, and down).

- **Keystone**—Adjusts image distortion at the top and bottom widths of the screen caused by tilting the projector.
- **Picture**—Adjusts the gamma value or degree of contrast of darkness or light for the projected image.
- **Color**—Adjusts color balance to compensate for ambient conditions using three submenus:
 - **Factory default.**
 - **Custom Color**—Modifies the color temperature balance.
 - **Saturation**—Magnifies the color intensity.
- **Digital Conversion**—Improves picture stability of user modes by adjusting:
 - **Clock**—Increase/decrease the value to stretch or shrink the image on the screen.
 - **Clock Phase**—Increase/decrease the value to minimize video distortion or video jitter.



If the projector image becomes distorted when adjusting the Clock and Clock Phase values, continue adjusting the values until the distortion disappears. To restore the factory settings, select **Factory Reset** in the on-screen menu, or press the **Resync** button.

- **Language**—Allows the user to change the On-Screen display to one of the languages in their native spelling. The current language is highlighted. Select another language to display all menu functions in that language.
- **Menu Location**—Positions the on-screen menu at a convenient location on the projector screen; positions the menu up or down, left or right.
- **HDTV Setup**—Allows the user to stretch the format to fill the screen or to use the original aspect ratio and fill the screen, using HDTV (High Definition Television) format. Refer to the “HDTV” section later in this chapter for more information.
- **Management**—Allows the user to control power saver characteristics of the display, or to view the cumulative lamp hours, reset the lamp hour timer, view the unit’s serial number, or perform a Master Reset.

- **Factory Reset**—Resets the current operating option to its original factory setting.

Special On-Screen Messages

Special on-screen messages will appear on the projection display to identify the following conditions:

- **Check Video Cable:** Indicates the video cable may not be plugged into the projector or the selected video input is not accurate.
- **Input Signal Out of Range**—Indicates the projector is unable to access the appropriate input signal.
- **2 Inputs Active - Remove One**—The projector has two data inputs: one is an analog D-Sub input and the other is a digital DFP input. This message indicates that both inputs are active simultaneously and the user should detach one of them.

NOTE: This message appears only when the Multimedia Adapter is not attached to the projector.

- **Going to Standby**—Indicates the projector is entering a sleep mode or is powering off the lamp.
- **Lamp May Fail Soon, Replacement Suggested**—Indicates the lamp is approaching failure. The message will remain on the screen for five seconds or until the on-screen menu **Select** button is pressed.

When the Multimedia Adapter is attached to the projector, the following messages, in addition to the previous messages, will appear on the projection display to identify the following conditions:

- **Analog, Use Source to Change Input**—Indicates analog and video inputs are connected. Since the projector will default to display analog, you must press the **Source** button to switch to video.
- **Composite Video, Use Source to Change Input**—Indicates composite video or other inputs (excluding HDTV) are present. Composite video is the default setting unless HDTV is connected. Press the **Source** button to change the setting.

- **S-video, Use Source to Change Input**—Indicates S-video with other inputs are active. Press the **Source** button to change the setting.
- **HDTV, Use Source to Change Input**—Indicates HDTV input is connected along with other inputs. If HDTV is connected, HDTV is the default setting. Press the **Source** button to switch to video.

HDTV (Optional Use)

The Compaq Microportable Projector is capable of displaying various High Definition TV display modes. The Multimedia Adapter is not required to take advantage of this functionality.

A variety of sources can be used to provide HDTV data to the projector for display. Some of these sources are:

- Digital-VHS (D-VHS) player
- HDTV-DVD player
- Satellite Dish HDTV receiver
- A variety of DTV tuners (to receive programming over the airwaves)

Most of these sources will provide an analog component video output, a standard VGA output, or a standard digital DVI output. The color information can be either in YPrPb (default) format or RGB format. The user can switch between these using the analog on-screen menu adjustments by selecting “HDTV Setup.” Refer to “Analog On-Screen Menu Adjustments” earlier in this chapter for more information.

The projector is capable of processing HDTV data provided either on the standard VGA connector or the DVI interface. Use the Component HDTV to VGA cable that came with your projector to convert component outputs to VGA format.

The following modes are supported on the DVI interface:

- HD0
 - 640 x 480p
 - 704 x 480p
 - 1280 x 720p
- HD1
 - 1920 x 1080i

When displaying HDTV content, it is recommended that you display it in its native 16:9 widescreen mode. For this, you may need to select the HDTV Fill to Aspect Ratio mode on the projector to preserve the height-to-width relationship of the material. Note that in this mode, you will have black stripes on top and bottom of the projected image, just as you see on a standard TV set when viewing widescreen content.

A desktop or portable computer can also be used to generate a HDTV video stream. Capable computers should be able to read/acquire the HDTV data and blend it into the desktop graphics. The composite image is then sent to the projector for display. In this case, the projector displays the image at the standard 4:3 aspect ratio, just as it would any other computer graphics mode. The projector processes the data as it comes from the computer.

The largest display mode available using the DVI interface is 1280 x 1024 at 75 Hz. The largest display mode available using the VGA interface is 1280 x 1024 at 75 Hz.

When displaying HDTV content in a window as part of your desktop environment, it is recommended to project it in the computer's native 4:3 mode since the computer has already embedded the HDTV video stream in widescreen format within the window. To do so, you may need to select the Fill to Screen mode on your projector to preserve the height-to-width relationship of the material.

Regardless of the source, the HDTV formats are generally of higher resolution than that of the projector (XGA, or 1024 x 768). Therefore, the projector will normally downscale the HDTV data to fit the complete image within the displayable 1024 x 768 resolution.

Using the Compaq Multimedia Adapter

The Compaq Multimedia Adapter (optional use) is specifically designed to fit the Compaq Microportable Projector. This adapter enables signals from camcorders, DVD players, or videocassette recorders to be shown through the projector. To connect the projector to an external camcorder, stand-alone DVD player, or videocassette recorder, you need to connect the Compaq Multimedia Adapter to the projector.

Identifying the Multimedia Adapter Components



Item	Component	Function
①	Infrared Receiver	Interprets signals received from the remote control
②	Volume +	Increases volume
③	Video LED	When lit, indicates video input
④	S-Video port	Connects camcorders or DVD players
⑤	8-pin connector	Connects back to the computer allowing remote mouse functionality
⑥	Release buttons	Use to release adapter from projector
⑦	Speaker	Provides audio performance
⑧	Volume –	Decreases volume
⑨	Source button	Selects between all sources
⑩	Computer LED	When lit, indicates computer input
⑪	Video/RCA port	Connects video equipment
⑫	Audio-in jack	Connects audio equipment, videocassette recorders, and DVD players, allowing sound to be played.

Attaching the Multimedia Adapter to the Microportable Projector

1. Insert the hook on top of the Multimedia Adapter into the upper slot **1** on the projector by inserting and pushing upward.
2. Insert the adapter plug into the digital connector **2** on the back of the projector.

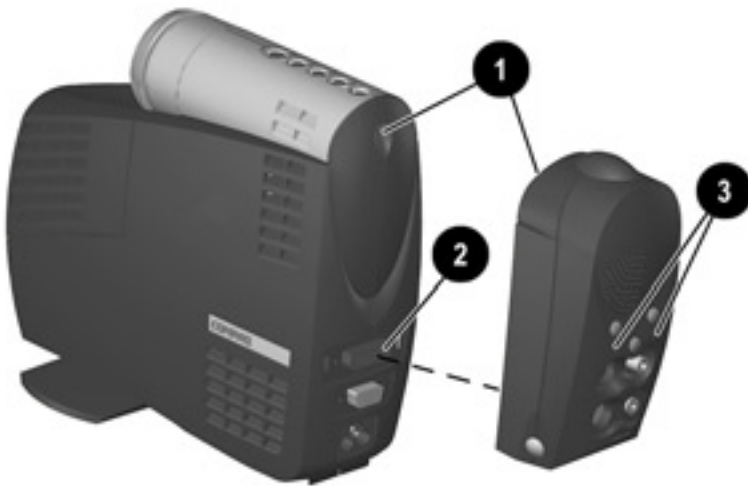

When the adapter is activated, one of the LEDs **3** on the Multimedia Adapter turns green.

Connecting a Camcorder, Videocassette Recorder, or DVD Player to the Compaq Multimedia Adapter

1. Use an RCA cable to connect a videocassette recorder to the video connector **1** on the Multimedia Adapter. To play audio through the Multimedia Adapter, connect an audio cable to the source audio-out jack and the audio-in jack on the Multimedia Adapter **2**.

Use an S-video cable to connect a camcorder or DVD player to the S-video connector **3** on the Multimedia Adapter.

2. Connect one end of the power cord **4** into the back of the projector and the other end to an electrical outlet that is easily accessible and close to the projector.
3. Press the **Source** button **5** on the Multimedia Adapter to select different input sources.

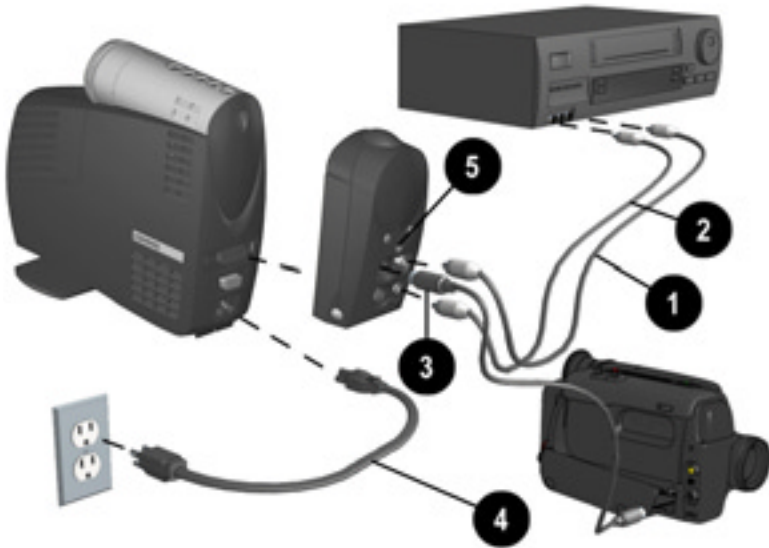

The Compaq Multimedia Adapter can remain attached to the projector, or it can be removed and stored in the carrying case.

Connecting a Video Player



If your video player uses a round, one-prong composite video connector, use the RCA video cable.

If your video player uses a round, four-prong S-video connector, use the S-video cable.

Both cables are included with the Compaq Multimedia Adapter.

1. Plug the RCA video cable into the video-out port on the video player and the video port on the video adapter. If you are using the S-video cable, connect it to the S-video out connector on the video player and the S-video port on the video adapter.
2. Turn on the projector first, then the video player.
3. Press the **Source** button on the back of the Multimedia Adapter to switch the projector signal from data to video. The data mode receives computer inputs and the video mode receives video input such as a TV tuner, videocassette recorder, or camera.

With the Compaq Multimedia Adapter attached, the projector is compatible with major video standards such as NTSC, PAL, and SECAM. Use the on-screen menu to adjust the video performance manually or press the **Resync** button to optimize it automatically.

Video On-Screen Menu Adjustments

When the Multimedia Adapter is attached to the projector and the video source is selected, an alternate video on-screen menu can be displayed on the projected screen. This menu includes some selections that are relevant to the functions of the Multimedia Adapter.

To display the video on-screen menu:

1. Attach the Multimedia Adapter to the projector.
2. Attach a video source to the projector.
3. Set the **Source** button on the adapter or remote control to video.
4. Press the **Select** button on the projector or the **Menu** button on the remote control to display the following menu:

Video Menu	Video Menu Level 2	Video Menu Level 3
Brightness	Adjustment scale	
Contrast	Adjustment scale	
Zoom	Zoom Panning left-right Panning up-down Save and return Cancel	Adjustment scale Adjustment scale Adjustment scale
Keystone	Adjustment scale	
Color	(Color temperature) Custom color Saturation Save and return Cancel	Adjustment scale Adjustment scale
Tint	Adjustment scale	
Sharpness	Adjustment scale	
Language	Deutsche English Espanol Francais Italiano Nederlands Japanese Save and Return	

Continued

Video On-Screen Menu *(continued)*

Video Menu	Video Menu Level 2	Video Menu Level 3
Audio	Mute Volume Bass Treble Cancel Save and return	On - Off Adjustment scale Adjustment scale Adjustment scale
Source	S-Video Composite Analog HDTV Save and return	
Menu Location	Up-down Left-right Save and return Cancel	Adjustment scale Adjustment scale
Management	Power saver Lamp hours Reset lamp hours Standby lamp delay Flip image Serial number Master reset Save and return Cancel	On-off Display hours - 5 digits Confirmation Delay adjustment Horizontal - vertical - both Display serial number Confirmation
Factory reset	Confirm reset	
Exit		
Current mode		

To make adjustments to the video on-screen menu, follow the steps in “Adjusting the On-Screen Menus” in Chapter 2.

Explaining Functions in the Video On-Screen Menu

In addition to the analog on-screen menu functions, the video on-screen menu includes the following additional functions:

- Tint-adjusts screen image tint.
- Sharpness-adjusts screen image sharpness.
- Audio-adjusts the audio controls for the Multimedia Adapter speaker.
- Source-selects between composite, S-video, DVI, analog, and HDTV input.

Chapter 4

Using the Remote Control

The remote control (optional use) has many convenient features. It combines the functions of the projector buttons with some of the most widely used functions of the computer mouse.

Before using the remote control, be sure steps 1 through 4 have been completed under “Powering On the Projector.”



The remote control operates only when the Compaq Multimedia Adapter is connected to the projector.



WARNING: To reduce the risk of injury to the eyes, do not look directly into the remote control laser light and do not point the laser light into anyone’s eyes. The remote control is equipped with a Class II laser that emits radiation.

Identifying the Remote Control Components

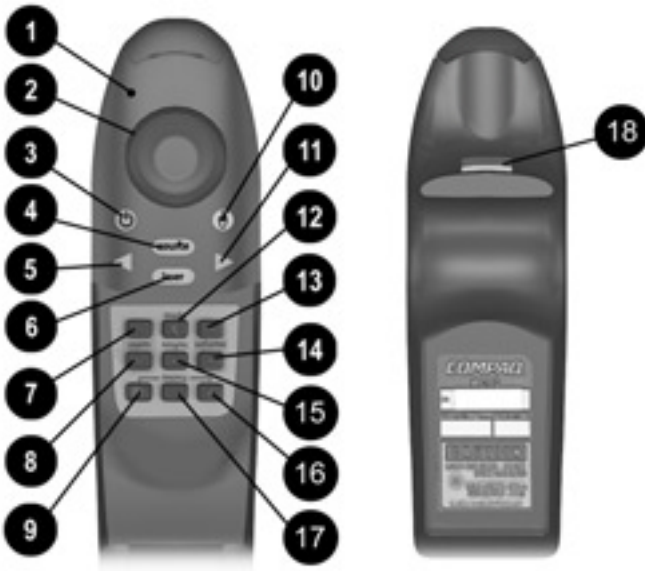

Item	Component	Function
①	LED	Glows green when the remote control is operating
②	Mouse ball	Controls the on-screen cursor and alternate left-mouse functions
③	System on/Standby button	Turns the projector on and off OR powers the projector into and out of Standby mode
④	SCE—Source button	Selects the input source
⑤	Page up button	Scrolls projected image up

Continued

Remote Control components *(continued)*

Item	Component	Function
⑥	Laser pointer 	Allows laser pointer functionality
⑦	Zoom in button	Zooms in to a specific area on the screen
⑧	Zoom out button	Zooms out to include a larger screen area
⑨	On-screen menu button	Launches the video on-screen Menu
⑩	Right mouse button	Controls right mouse functions
⑪	Page down button	Scrolls projected image down
⑫	Mute button	Mutes or silences the speaker on the Multimedia Adapter
⑬	Volume +	Increases speaker volume
⑭	Volume –	Decreases speaker volume
⑮	Resync button	Resynchronizes the projector with the input source
⑯	On-screen menu adjustments +	Adjusts the video on-screen menu up
⑰	On-screen menu adjustments -	Adjusts the video on-screen menu down
⑱	Left mouse trigger	Controls left mouse functions



Follow the instructions in the “Adjusting the On-Screen Menus” section in Chapter 2 to make adjustments to the video on-screen menu.

Remote Control Functions

The remote control performs the following functions:

- Duplicates the functions of the projector buttons including adjusting the on-screen buttons.
- Controls the computer connected to the projector by navigating through the computer directories and opening and closing files.

IMPORTANT: To operate a computer using the remote control, the remote control Y-cable (included with the Multimedia Adapter) must be used. Connect the 8-pin connector cable to the appropriate connector on the Multimedia Adapter and connect the USB connector to the USB connector on the computer (preferred) **or** the RS232 connector to the serial connector on the computer. Do not connect **both** the USB and RS232 connectors to the computer.

NOTE: The remote control Page Up and Page Down functions require an additional driver when used with the RS232 connector. This driver can be found on the CD-ROM that came with your projector.



Microsoft Windows 95 (OSR Version 2.1), Windows 98, and Windows 2000 support USB connection. Microsoft Windows NT does not currently support USB connection.

Care and Maintenance

This section explains how to care for and maintain your Compaq projector during normal everyday use.

Protecting the Projector

To protect your projector from overheating and other types of damage, follow these suggestions:

- Use only a power source and connection appropriate for this projector as indicated on the marking label.
- Do not overload an electrical outlet, power strip, or convenience receptacle. The overall system load must not exceed 80 percent of the branch circuit rating. If an extension cord or power strip is used, make sure that the cord or strip is rated for the product and that the total ampere ratings of all products plugged into the extension cord or power strip do not exceed 80 percent of the extension cord or strip ampere ratings limit.
- Install the projector near an outlet that you can easily reach. Disconnect the product by grasping the plug firmly and pulling it from the outlet. Never disconnect it by pulling the cord.
- Unplug the projector from the wall outlet before cleaning. Do not use liquid cleaners or aerosol cleaners.
- Slots and openings in the cabinet are provided for ventilation. These openings must not be blocked or covered. Never push objects of any kind into cabinet slots or other openings.
- Do not drop the projector or place it on an unstable surface.
- Do not expose this product to rain or moisture.
- Do not allow anything to rest on the power cord. Do not walk on the cord.
- Do not allow the projector to be exposed to high temperatures.

- Do not open the projector or attempt to service this product for any other reason than to replace the lamp module. Adjust only those controls that are covered by the operating instructions. If the projector is not operating properly or has been dropped or damaged, contact your Compaq authorized dealer, reseller, or service provider.

Cleaning the Lens

To minimize the risk of damaging or scratching the lens surface, this cleaning procedure has been developed. The first recommendation is to remove any dust particles from the lens by blowing them off with clean, dry, deionized air. However, this may not be a convenient method, and an alternate method is described below.

To clean the lens, use only a **clean** cloth and follow these steps:



CAUTION: Do not spray any type of fluid or cleaner directly on the lens surface. Do not use liquid cleaners.

1. Wipe the lens in a single direction with a **clean, dry** cloth. Do not wipe back and forth across the lens surface.
2. If the cloth is dirty or smears the lens, wash the cloth. If the cloth is still dirty after washing it or the fabric is damaged, replace it.



Do not use fabric softener when washing a cleaning cloth or softener sheets when drying the cloth.



CAUTION: Do not store a cleaning cloth in contact with the lens for a long time as doing so may contaminate the lens with dye from the cloth. The cloth can be contaminated if left in the open air.

Replacing the Projector Lamp Module



WARNING: When the lamp reaches its end of life, it may pop or rupture. To reduce the risk of personal injury, be careful when removing the lamp cover as broken glass may be present. Never open the lamp cover while the projector is operating or when the lamp is hot.

The projector will alert you when the lamp approaches its failure mode or end of life. When the message “Lamp May Fail Soon - Replacement Suggested” displays on the projection screen, you should change the lamp as soon as possible. Contact your local Compaq authorized dealer, seller, or reseller to purchase a spare lamp or have the lamp changed. You can also purchase a lamp directly through www.compaq.com.

Follow these steps to replace the projector lamp module:

1. Turn off the power to the projector by pressing the blue **Standby** button ❶.
2. Allow the projector to cool down for at least 30 minutes.



WARNING: The lamp assembly operates at a very high temperature. To reduce the risk of personal injury, allow the projector to cool down for at least 30 minutes before opening the lamp cover. Never open the lamp cover while the projector is operating or when the lamp is hot.

3. Disconnect the power cord ❷.



4. Use a coin to loosen the screw ❸ on the lamp module.
5. On the front of the lamp module, slide up the release latch ❹ to disengage it from the projector base.
6. Pull out the lamp module ❺.

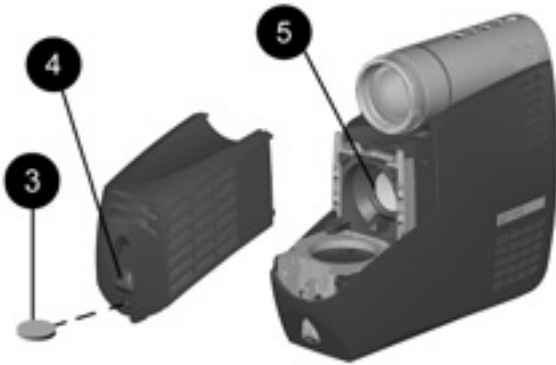

WARNING: To reduce the risk of personal injury, do not drop the lamp module or touch the glass bulb. The glass may shatter and cause an injury if it is dropped.

Reverse the previous steps to replace the lamp module.



After replacing the lamp module, remember to reset the lamp hours in the on-screen menu.



CAUTION: The lamp contains < 0.125 percent mercury by weight. If the projection lamp breaks, the mercury may be released into the atmosphere. Please follow applicable federal, state, and local regulations for disposal and/or recycling.

Chapter 6

Troubleshooting

Problem	Solution
Image does not appear on the projection screen	<ol style="list-style-type: none">1. Make sure the projector is powered on.2. Ensure the lens cap has been removed.3. Press the Standby button again.4. Ensure that the power cable is securely connected.5. Ensure the pins on the connectors are not crooked or broken.6. Turn off or disable the portable or desktop computer screen saver function.7. Ensure the projection lamp has been securely installed.8. Ensure your portable computer's external video port is turned on. Toggle the Fn + F4 function keys. Activate CRT/LCD "ON" at the same time. To identify any alternate function keys to be used, refer to your portable computer's user manual.
Scrolling, cut-off, or incorrect image displayed	<ol style="list-style-type: none">1. Press the Resync button.2. Turn everything off; then power on the projector first and power on the portable or desktop computer second.3. If the above steps do not correct the display image, adjust the resolution of the portable or desktop computer to 1024 × 768.

Continued

Troubleshooting *(continued)*

Problem	Solution
Portable computer or PC Companion screen is not displaying the presentation	<p>Portable computer:</p> <p>Most portable computers have a monitor loop-through or simultaneous viewing function. Press the Fn +F4 function keys on the portable computer to switch the image from the portable screen to the projection screen or to toggle through the following three options:</p> <ol style="list-style-type: none">1. LCD: Output displays only on the portable screen.2. CRT: Output displays only on the projection screen.3. CRT/LCD: Output displays on the portable screen and the projection screen. <p>Activate CRT/LCD "ON" at the same time. To identify any alternate function keys to be used, refer to your portable computer's user manual.</p> <p>Mac PowerBooks:</p> <ol style="list-style-type: none">1. To control video mirroring, click Control Panel→Display, then set Video Mirroring to ON for both internal and external viewing.2. Set Video Mirroring OFF for image on external monitor only or internal only, depending on monitor selection in Monitors.
Image is flickering or unstable	<p>Press the Resync button on the projector panel to adjust the tracking. If that does not stop the flickering, adjust the Clock Phase function in the analog on-screen menu.</p>

Continued

Troubleshooting *(continued)*

Problem	Solution
Image is out of focus	<ol style="list-style-type: none">1. Adjust the Focus Ring on the projection lens.2. Make sure the projection screen is within the required distance (3.74 to 32.8 feet, 1.14 to 10 meters) from the projector.3. Check the projection lens to see if it needs cleaning. Follow the "Cleaning the Lens" procedures in Chapter 5 to clean the lens.
Projected colors do not match computer or camcorder color	<ol style="list-style-type: none">1. Adjust the Brightness, Contrast, or Color functions in the analog or video on-screen menu.2. Make sure the pins on the cable connectors are not bent or broken.
Black or gray border visible outside the usable area of the projection screen	The black border surrounding the active area of the projection screen is part of the total projected image; however, it is an inactive area and cannot display any part of the image. This black border reduces the amount of extraneous light, producing a cleaner, sharper image.
Only the Compaq startup screen displays	<ol style="list-style-type: none">1. Check that the cables are connected securely.2. Verify that the proper input source is connected.3. Make sure your portable computer's external video port is activated.

Continued

Troubleshooting *(continued)*

Problem	Solution
A blue screen displays on the projection screen when a videocassette recorder is connected to the projector.	Check the videocassette recorder Play or TV/Video buttons. If that does not work, refer to your videocassette recorder manual.
Lamp shuts off	<ol style="list-style-type: none">1. If all five LEDs flash amber, the projector has overheated and will automatically shut down. Wait five to ten minutes until the LED buttons stop flashing and the Standby button turns amber before restarting the projector again.2. A minor power surge may cause the lamp to shut off. Wait a few minutes, then turn it back on.
Lamp burns out or makes a popping sound	When the lamp reaches its end of life, it will burn out and may make a loud popping sound. If this happens, the projector will not turn back on until the lamp module has been replaced. Contact your local Compaq authorized dealer, seller, or reseller to purchase a replacement lamp module. To replace the lamp, follow the procedures in the "Replacing the Projector Lamp Module" section of Chapter 5.
Multimedia Adapter speaker does not operate.	<ol style="list-style-type: none">1. Make sure the audio cable is correctly connected to the Multimedia Adapter and the audio source.2. Make sure the audio source is operating properly.3. Make sure the Mute button is off.

Continued

Troubleshooting *(continued)*

Problem	Solution
Remote control does not operate	<ol style="list-style-type: none">1. The two AAA batteries may need to be replaced.2. Verify that the batteries are installed properly.
Remote mouse does not operate computer.	<ol style="list-style-type: none">1. Make sure the Y-cable is connected to both the computer and the Multimedia Adapter. Do not connect both the USB and RS232 connectors to the computer at the same time. The USB connector is the preferred connector.2. If the RS232 connection is being used, the remote control does not function until the serial port is initialized. You may need to restart the computer to initialize the serial port. The remote control Page Up and Page Down functions require an additional driver when used with the RS232 connector. This driver can be found on the CD-ROM that came with your projector.
Compatibility issues with equipment attached to the projector.	Refer to Appendix B "Flash ROM Upgrade" for more information. If this does not resolve the problem, contact your Compaq authorized service provider or call Compaq Customer Support for help. Refer to the "Worldwide Telephone Numbers" booklet included in the projector documentation kit for a complete list of customer support numbers to call.
Image size is too small/large.	Adjust the manual zoom until the image is the desired size.

Agency Regulatory Notices

Federal Communications Commission Notice

This equipment has been tested and found to comply with the limits for a Class B digital device, pursuant to Part 15 of the FCC Rules. These limits are designed to provide reasonable protection against harmful interference in a residential installation. This equipment generates, uses, and can radiate radio frequency energy and, if not installed and used in accordance with the instructions, may cause harmful interference to radio communications. However, there is no guarantee that interference will not occur in a particular installation. If this equipment does cause harmful interference to radio or television reception, which can be determined by turning the equipment off and on, the user is encouraged to try to correct the interference by one or more of the following measures:

- Reorient or relocate the receiving antenna.
- Increase the separation between the equipment and the receiver.
- Connect the equipment into an outlet on a circuit different from the circuit that the receiver is connected.
- Consult the dealer or an experienced radio or television technician for help.

Modifications

The FCC requires the user to be notified that if any changes or modifications are made to this device, not expressly approved by Compaq Computer Corporation, this may void the user's authority to operate the equipment.

Cables

Connections to this device must be made with shielded cables with metallic RFI/EMI connector hoods to maintain compliance with FCC Rules and Regulations.

Declaration of Conformity for Products Marked with the FCC Logo—United States Only

This device complies with Part 15 of the FCC Rules. Operation is subject to the following two conditions: (1) this device may not cause harmful interference, and (2) this device must accept any interference received, including interference that may cause undesired operation.

For questions regarding your product, contact:

Compaq Computer Corporation
P.O. Box 692000, Mail Stop 530113
Houston, Texas 77269-2000

Or, call 1-800-652-6672 (1-800-OK COMPAQ)

For questions regarding this FCC declaration, contact:

Compaq Computer Corporation
P.O. Box 692000, Mail Stop 510101
Houston, Texas 77269-2000

Or, call (281) 514-3333

To identify this product, refer to the Part, Series, or Model number found on the product.

Canadian Notice

This Class B digital apparatus meets all requirements of the Canadian Interference-Causing Equipment Regulations.

Avis Canadien

Cet appareil numérique de la classe B respecte toutes les exigences du Règlement sur le matériel brouilleur du Canada.

European Notice

Products with the CE Marking comply with both the EMC Directive (89/336/EEC) and the Low Voltage Directive (73/23/EEC) issued by the Commission of the European Community.

Compliance with these directives implies conformity to the following European norms:

- EN55022 (CISPR 22) - Radio Frequency Interference
- EN50082-1 (IEC801-2, IEC801-3, IEC801-4) - Electromagnetic Immunity
- EN60950 (IEC950) - Product Safety

Japanese Notice

この装置は、情報処理装置等電波障害自主規制協議会（VCCI）の基準に基づくクラスB情報技術装置です。この装置は、家庭環境で使用することを目的としていますが、この装置がラジオやテレビジョン受信機に近接して使用されると、受信障害を引き起こすことがあります。

取扱説明書に従って正しい取り扱いをして下さい。

Power Cords

The projector power supply is provided with Automatic Line Switching (ALS). This feature allows the projector to operate on input voltages between 100-120V or 200-240V.

The power cord set (flexible cord or wall plug) received with the projector meets the requirements for use in the country where you purchased the equipment.

If you need to obtain a power cord for a different country, you should purchase a power cord that is approved for use in that country.

The power cord must be rated for the product and for the voltage and current marked on the product's electrical ratings label. The voltage and current rating of the cord should be greater than the voltage and current rating marked on the product. In addition, the diameter of the wire must be a minimum of 0.75 mm² or 18AWG, and the length of the cord must be between 6 feet (1.8 m) and 12 feet (3.6 m). If you have questions about the type of power cord to use, contact your Compaq authorized service provider.

A power cord should be routed so that it is not likely to be walked on or pinched by items placed upon it or against it. Particular attention should be paid to the plug, electrical outlet, and the point where the cord exits from the product.

Flash ROM Upgrade

The Compaq Microportable Projector can be upgraded by flashing the ROM (Read Only Memory) resident on the projector. This will be available from Compaq in the future only if necessary.

NOTE: Before attempting these steps, make sure the projector is turned off.

The Flash ROM upgrade provides the following functions:

- Implements new features on the projector
- Provides upgrades to existing features
- Resolves compatibility issues.

Locate the following items in the Compaq Microportable Projector shipping box:

- DVI to DVI signal cable
- RS232 to DVI upgrade adapter

Complete the following steps to upgrade the projector's ROM:

1. Connect one end of the cable to the DVI connector on the projector and the other end to the RS232 (serial) connector on the computer.



2. Power on the computer and monitor only (if applicable).
3. Access the Compaq website at:
<http://www.compaq.com>
4. Follow the steps outlined on the website.
5. Power on the projector.
6. Wait about two minutes to allow the Flash Upgrade program to complete the upgrade, then the projector will automatically reset and be ready to use.

Specifications

Compaq Microportable Projector		
Projection panel	XGA 1024 × 768 × 1	
Lamp type	130 watt High Brightness Lamp	
Image size	See the Image Size Adjustment table.	
Avg. lamp life in hours	1,500 hours	
Projection distance	4.92 to 32.8 feet (1.14 to 10 meters)	
Maximum weight (unpacked)	3.0 lbs (without cables)	
Maximum dimensions	2.5 in (w) × 7.1 in (h) × 8.38 in (d)	
Maximum graphics resolution	SXGA 1280 x 1024 at 75 Hz	
Displayable colors	16.7 million colors	
Horizontal frequencies	15-80 kHz Analog 15-80 kHz Digital	
Vertical frequencies	48 - 85 Hz Analog 48 - 75 Hz Digital	
Required Environmental Temperatures for the Following Altitudes:		
Sea Level		
Operating Temperature	50 to 104°F	10 to 40°C
Storage Temperature	-22 to 149°F	-40 to 65°C
2,500 - 5,000 Feet		
Operating Temperature	50 to 95°F	10 to 35°C
Storage Temperature	-22 to 149°F	-40 to 65°C
5,000 - 10,000 Feet		
Operating Temperature	50 to 82°F	10 to 28°C
Storage Temperature	-22 to 149°F	-40 to 65°C
Humidity (Non-Condensing)		
Operating	20 to 80%	
Non-Operating	5 to 95%	
Power Source	90 - 265 VAC, 50-60 Hz	
Power Consumption	< 185 watts	
Input Terminal	One 15-pin D-type VGA connector with one cable included	
	One DVI connector with one cable included	

Preset Display Resolutions Table

This projector automatically recognizes the preset display resolutions listed in the following table.

Display Resolutions	
Preset Modes	Resolutions
1. Industry Standard	640 × 350 at 31.5 kHz/70 Hz
2. VESA Standard	640 × 350 at 37.8 kHz/85 Hz
3. Industry Standard	640 × 480 at 37.8 kHz/72 Hz
4. VESA Standard	640 × 480 at 37.5 kHz/75 Hz
5. VESA Standard	640 × 480 at 43.3 kHz/85 Hz
6. Industry Standard	720 × 400 at 31.5 kHz/70 Hz
7. VESA Standard	720 × 400 at 37.9 kHz/85 Hz
8. VESA Standard	800 × 600 at 35.1 kHz/56 Hz
9. VESA Standard	800 × 600 at 37.8 kHz/60 Hz
10. VESA Standard	800 × 600 at 48 kHz/72 Hz
11. VESA Standard	800 × 600 at 46.9 kHz/75 Hz
12. VESA Standard	800 × 600 at 53.7 kHz/85 Hz
13. Macintosh-compatible	832 × 624 at 49.7 kHz/75 Hz
14. Macintosh-compatible	1152 × 870 at 68.7 kHz/75 Hz
15. VESA Standard	1024 × 768 at 35.5 kHz/43.4 Hz
16. VESA Standard	1024 × 768 at 48.4 kHz/60 Hz
17. VESA Standard	1024 × 768 at 56.4 kHz/70 Hz
18. VESA Standard	1024 × 768 at 60 kHz/75 Hz
19. VESA Standard	1024 × 768 at 68.7 kHz/85 Hz
20. VESA Standard	1280 × 1024 at 64 kHz/60 Hz
21. VESA Standard	1280 × 1024 at 80 kHz/75 Hz
22. VGA Compatibility	640 × 480 at 31.5 kHz/60 Hz
23. HDTV 720P (Progressive)	1280 x 720 at 45 kHz/60 Hz
24. HDTV 1080I (Interface)	1920 x 1080 at 33.8 kHz/30 Hz