

## Regulation & safety notices

This appendix lists the general notices of your Projector.

### *FCC notice*

This device has been tested and found to comply with the limits for a Class B digital device pursuant to Part 15 of the FCC rules. These limits are designed to provide reasonable protection against harmful interference in a residential installation. This device generates, uses, and can radiate radio frequency energy and, if not installed and used in accordance with the instructions, may cause harmful interference to radio communications.

However, there is no guarantee that interference will not occur in a particular installation. If this device does cause harmful interference to radio or television reception, which can be determined by turning the device off and on, the user is encouraged to try to correct the interference by one or more of the following measures:

- Reorient or relocate the receiving antenna.
- Increase the separation between the device and receiver.
- Connect the device into an outlet on a circuit different from that to which the receiver is connected.
- Consult the dealer or an experienced radio/television technician for help.

### *Notice: Shielded cables*

All connections to other computing devices must be made using shielded cables to maintain compliance with FCC regulations.

### *Caution*

Changes or modifications not expressly approved by the manufacturer could void the user's authority, which is granted by the Federal Communications Commission, to operate this computer.



## ***Operation conditions***

This device complies with Part 15 of the FCC Rules. Operation is subject to the following two conditions:

1. this device may not cause harmful interference, and
2. this device must accept any interference received, including interference that may cause undesired operation.

## ***Notice: Canadian users***

This Class B digital apparatus complies with Canadian ICES-003.

## ***Declaration of Conformity for EU countries***

EMC Directive 89/336/EEC (including amendments)

Low Voltage Directive 73/23/EEC (amended by 93/68/EEC)

R & TTE Directive 1999/EC (if product has RF function)





# Table of Contents

Table of Contents .....	1
Usage Notice.....	2
<i>Safety Information</i> .....	2
<i>Precautions</i> .....	3
<i>Eye Safety Warnings</i> .....	5
Introduction.....	6
<i>Product Features</i> .....	6
<i>Package Overview</i> .....	7
<i>Product Overview</i> .....	8
<i>Main Unit</i> .....	8
<i>Control Panel</i> .....	9
<i>Connection Ports</i> .....	10
<i>Remote Control with Mouse Function and Laser Pointer</i> .....	11
Installation .....	12
<i>Connecting the Projector</i> .....	12
<i>Connect the Computer/Notebook</i> .....	12
<i>Connect the Video</i> .....	13
<i>Powering On/Off the Projector</i> .....	14
<i>Powering On the Projector</i> .....	14
<i>Powering Off the projector</i> .....	15
<i>Warning Indicator</i> .....	15
<i>Adjusting the Projected Image</i> .....	16
<i>Adjusting the Projector Image Height</i> .....	16
<i>Adjusting the Projector Zoom / Focus</i> .....	17
<i>Adjusting Projected Image Size</i> .....	17
User Controls .....	18
<i>Control Panel &amp; Remote Control</i> .....	18
<i>On-Screen Display Menus</i> .....	21
<i>How to Operate</i> .....	21
<i>Menu Tree</i> .....	22
<i>Image-I</i> .....	23
<i>Image-II</i> .....	25
<i>Colour Setting</i> .....	27
<i>Language</i> .....	29
<i>Management</i> .....	30
<i>Lamp &amp; Power</i> .....	36
Appendices.....	37
<i>Troubleshooting</i> .....	37
<i>Replacing the Lamp</i> .....	41
<i>Compatibility Modes</i> .....	42
<i>RS232 Commands</i> .....	43
<i>Ceiling Mount Installation</i> .....	44
<i>Optoma Global Offices</i> .....	45



## Safety Information

	The lightning flash with arrowhead within an equilateral triangle is intended to alert the user to the presence of uninsulated "dangerous voltage" within the product's enclosure that may be of sufficient magnitude to constitute a risk of electric shock to persons.
	The exclamation point within an equilateral triangle is intended to alert the user to the presence of important operating and maintenance (servicing) instructions in the literature accompanying the appliance.

**WARNING:** TO REDUCE THE RISK OF FIRE OR ELECTRIC SHOCK, DO NOT EXPOSE THIS APPLIANCE TO RAIN OR MOISTURE. DANGEROUS HIGH VOLTAGES ARE PRESENT INSIDE THE ENCLOSURE. DO NOT OPEN THE CABINET. REFER SERVICING TO QUALIFIED PERSONNEL ONLY.

### Class B emissions limits

This Class B digital apparatus meets all requirements of the Canadian Interference-Causing Equipment Regulations.

### Important Safety Instruction

1. Read these instructions -before using this projector.
2. Keep these instructions -for future reference.
3. Follow all instructions.
4. Install in accordance with the manufacturer's instructions

#### **A. Do not block any ventilation openings**

To ensure reliable operation of the projector and to protect it from overheating, put the projector in a position and location that will not interfere with its proper ventilation. For example, do not place the projector on a bed, sofa, carpet, or similar surface that may block the ventilation openings. Do not put it in an enclosure, such as a bookcase or a cabinet that may keep air from flowing through its ventilation openings.

**B. Do not use this projector near water or moisture.** To reduce the risk of fire or electric shock, do not expose the projector to rain or moisture.

**C. Do not install near any heat sources,** such as radiators, heaters, stoves or other apparatus (including amplifiers) that produce heat.

5. Clean only with a dry cloth.
6. Only use attachments/accessories specified by the manufacturer.
7. Refer all servicing to qualified service personnel. Servicing is required when the projector has been damaged in any way:
  - Such as power supply cord or plug is damaged.
  - Liquid has been spilled or objects have fallen into the apparatus.
  - The projector has been exposed to rain or moisture, does not operate normally, or has been dropped.











Do not attempt to service this projector yourself. Opening or removing covers may expose you to dangerous voltages or other hazards. Please call Optoma to be referred to an authorized service center near you.

8. Do not let objects or liquids enter the projector -as they may touch dangerous voltage points or short-out parts that could result in a fire or electric shock.
9. See projector enclosure for safety related markings.
10. The projector should not be adjusted or repaired by anyone except properly qualified service personnel.



## Precautions

*Follow all warnings, precautions and maintenance as recommended in this user's guide to maximize the life of your unit.*

-  Warning- Do not look into the projector's lens when the lamp is on. The bright light may hurt your eyes.
-  Warning- To reduce the risk of fire or electric shock, do not expose this product to rain or moisture.
-  Warning- Please do not open or disassemble the product as this may cause electric shock.
-  Warning- When changing the lamp, please allow unit to cool down, and follow all changing instructions.
-  Warning- This product will detect the life of the lamp itself. Please be sure to change the lamp when it shows warning messages.
-  Warning- Reset the "Lamp Reset" function from the On Screen Display "Lamp Setting" menu after replacing the lamp module (Refer to page 36).
-  Warning- When switching the projector off, please ensure the projector completes its cooling cycle before disconnecting power.
-  Warning- Turn on the projector first and then the signal sources.
-  Warning- Do not use lens cap when projector is in operation.
-  Warning- When the lamp reaches the end of its life, it will burn out and may make a loud popping sound. If this happens, the projector will not turn back on until the lamp module has been replaced. To replace the lamp, follow the procedures listed under "Replacing the Lamp". (See page 41)



# Usage Notice

## *Do:*

- ❖ Turn off the product before cleaning.
- ❖ Use a soft cloth moistened with mild detergent to clean the display housing.
- ❖ Disconnect the power plug from AC outlet if the product is not being used for a long period of time.

## *Don't:*

- ❖ Block the slots and openings on the unit provided for ventilation.
- ❖ Use abrasive cleaners, waxes or solvents to clean the unit.
- ❖ Use under the following conditions:
  - In extremely hot, cold or humid environments.
  - In areas susceptible to excessive dust and dirt.
  - Near any appliance that generates a strong magnetic field.
  - In direct sunlight.



## Eye Safety Warnings



- ■ Avoid staring directly into the projector beam at all times.
- ■ Minimize standing facing into the beam. Keep your back to the beam as much as possible.
- ■ A stick or laser pointer is recommended to avoid the need for the user to enter the beam.
- ■ Ensure that projectors are located out of the line of sight from the screen to the audience; this ensures that, when presenters look at the audience, they do not also have to stare at the projector lamp. The best way to achieve this is by ceiling-mounting rather than floor or table-mounting the projector.
- ■ When projector is used in a classroom, adequately supervise students when they are asked to point out something on the screen.
- ■ In order to minimize the lamp power needed, use room blinds to reduce ambient light levels.



## Product Features

*Congratulations and Thank You for choosing Optoma projector. This product is a XGA single chip 0.7" Darkchip3 DLP® projector. Outstanding features include:*

- ◆ True XGA, 1024 x 768 addressable pixels
- ◆ Texas Instruments Single chip DLP® Technology
- ◆ NTSC/NTSC4.43/PAL/PAL-M/PAL-N/SECAM and HDTV compatible (480i/p, 576i/p, 720p, 1080i)
- ◆ Multi-Auto functions: Auto detection, Automatic saving of user adjustments
- ◆ Full function IR remote control with laser pointer
- ◆ User friendly multilingual on screen menu
- ◆ Advanced digital keystone correction and high quality full screen image re-scaling
- ◆ User friendly control panel
- ◆ Two built-in speakers with 2 Watt amplifier
- ◆ Multiple for Audio inputs
- ◆ UXGA, SXGA+, SXGA compression and SVGA, VGA re-sizing
- ◆ Mac compatible
- ◆ DVI support (HDCP compliant)
- ◆ Support Network function (LAN/RS232)





## Package Overview

*This projector comes with all the items shown below. Check to make sure your unit is complete. Contact your dealer immediately if anything is missing.*



Projector with lens cap



Power Cord 1.8m



VGA Cable 1.8m



Composite Video Cable  
1.8m



USB Cable 1.8m



RS232 Cable 1.8m



❖ Due to the difference in applications for each country, some regions may have different accessories.



S-Video Cable 1.8m



2 x AA Batteries



SCART VGA/S-Video  
Adaptor  
(Optional Accessory)



Wireless Remote  
Controller

### Documents :

- User's Guide
- Quick Start Card
- Warranty Card
- Quick Troubleshooting Guide
- WEEE Card



## Product Overview

### Main Unit

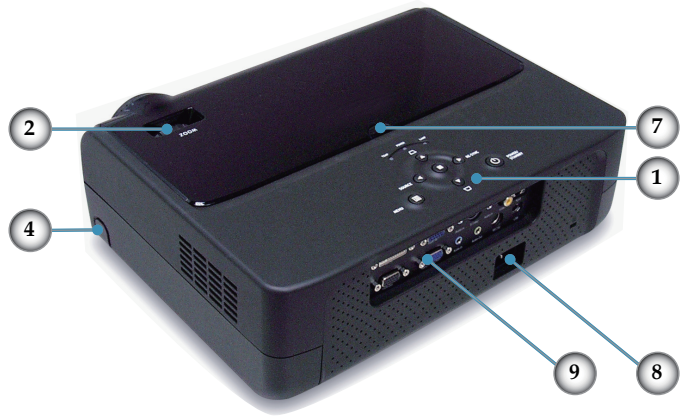

1. Control Panel
2. Zoom Lever
3. Focus Ring
4. Elevator Button (one on each side)
5. Elevator Foot (one on each side)
6. Zoom Lens
7. IR Receivers
8. Power Socket
9. Connection Ports



## Control Panel

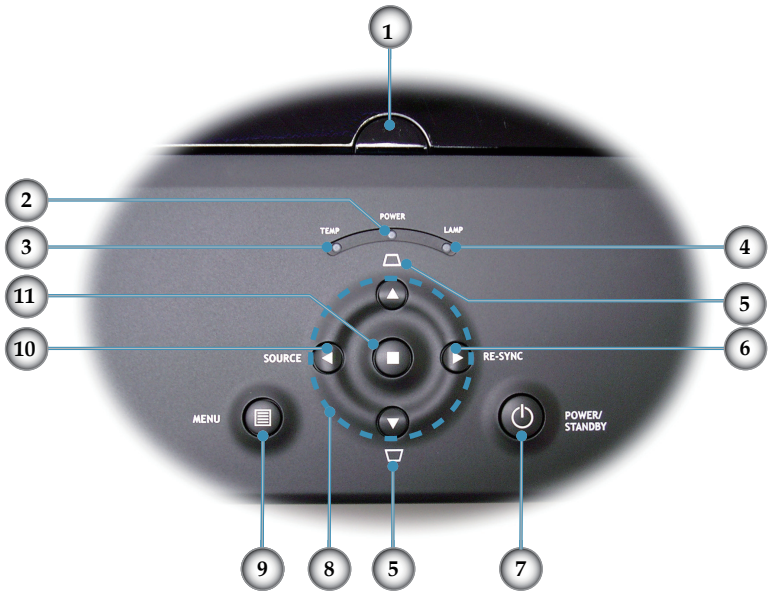

1. IR Receiver
2. Power/Standby LED
3. Temp Indicator LED
4. Lamp Indicator LED
5. Keystone +/-
6. Re-Sync
7. Power/Standby
8. Four Directional Select Keys
9. Menu (On/Off)
10. Source Select
11. Enter



## Connection Ports

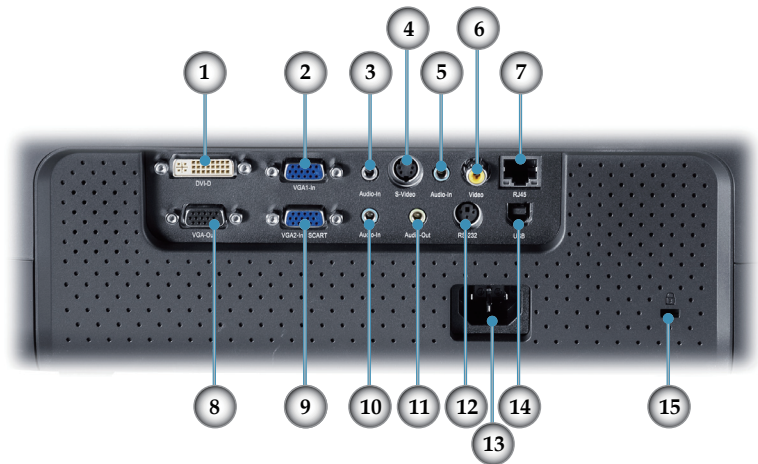

1. DVI-D Input Connector (PC Digital/HDTV/HDCP Input)
2. VGA1-In Connector (PC Analog signal/HD/Component Video Input)
3. Audio Input Connector (For DVI-D or VGA1-In)
4. S-Video Input Connector
5. Audio Input Connector (For S-Video or Composite)
6. Composite Video Input Connector
7. Networking Connector RJ45
8. Monitor Loop-through Output Connector
9. VGA2-In SCART Connector (PC Analog signal/SCART RGB/HD/Component Video Input)
10. Audio Input Connector (For VGA2-In SCART)
11. Audio Output Connector
12. RS232 Connector
13. Power Socket
14. USB Connector (Connect to PC for Remote Mouse function)
15. Kensington™ Lock Port



## Remote Control with Mouse Function and Laser Pointer

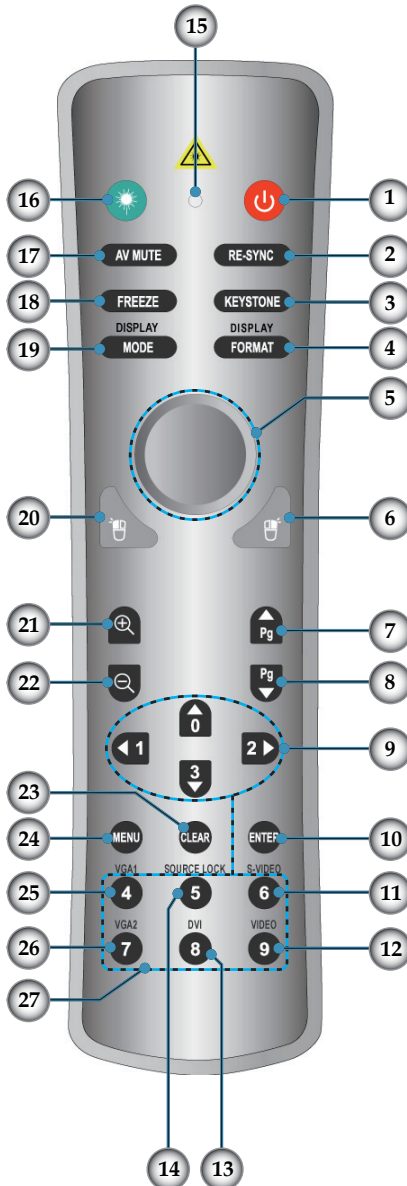
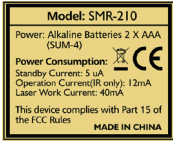

1. Power
2. Re-Sync
3. Keystone Correction
4. Display Format
5. Mouse
6. Mouse Right Click
7. Page Up
8. Page Down
9. Four Directional Select Keys
10. Enter
11. S-Video Source
12. Composite Video Source
13. DVI Source
14. Source Lock
15. Button LED
16. Laser Button
17. AV Mute
18. Freeze
19. Display Mode
20. Mouse Left Click
21. Zoom In
22. Zoom Out
23. Clear
24. Menu
25. VGA1 Source
26. VGA2 Source
27. Number Buttons



## Connecting the Projector

### Connect the Computer/Notebook

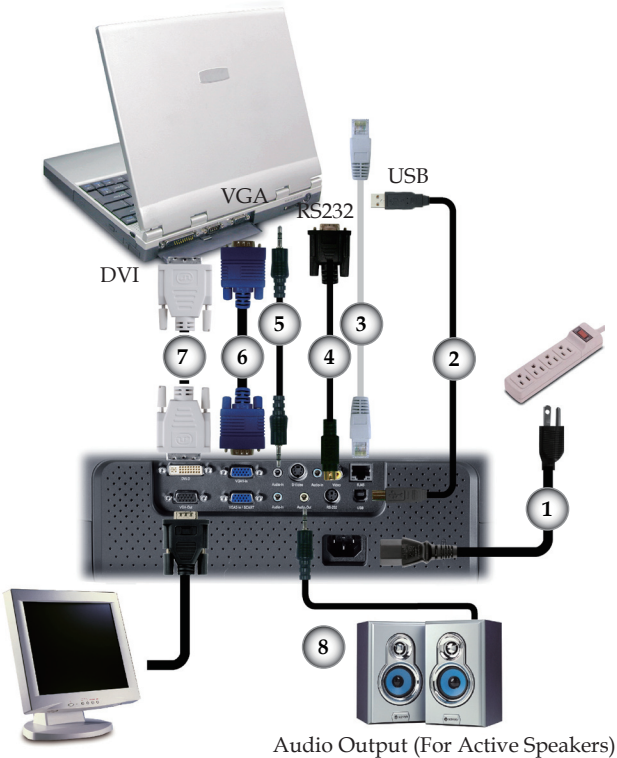

❖ Due to the difference in applications for each country, some regions may have different accessories.

- |        |                    |
|--------|--------------------|
| 1..... | Power Cord         |
| 2..... | USB Cable          |
| 3..... | Network Cable      |
| 4..... | RS232 Cable        |
| 5..... | Audio Input Cable  |
| 6..... | VGA to VGA Cable   |
| 7..... | DVI to DVI Cable   |
| 8..... | Audio Output Cable |

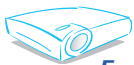

## Connect the Video

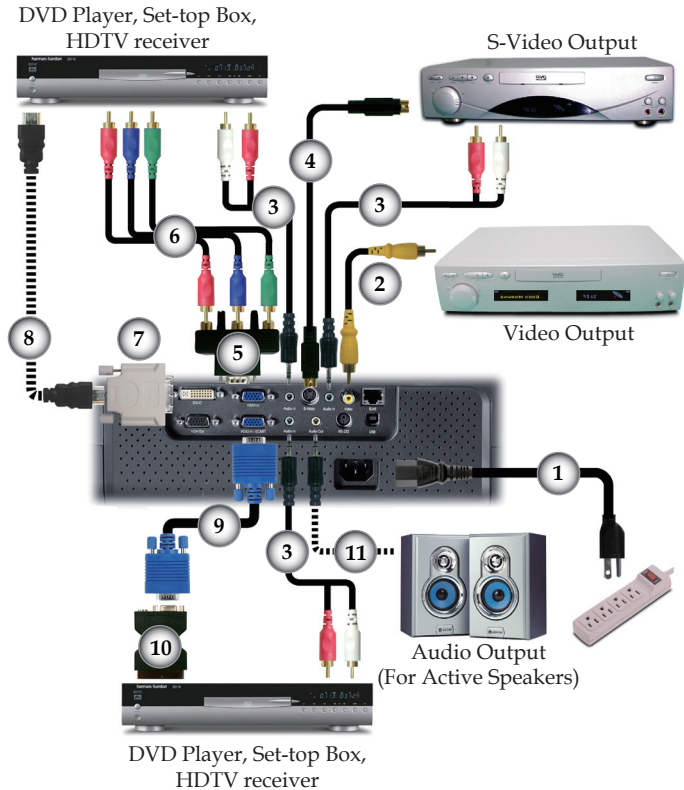

❖ Due to the difference in applications for each country, some regions may have different accessories.

- 1.....Power Cord
- 2..... Composite Video Cable
- 3..... Audio Input Cable
- 4..... S-Video Cable
- 5..... VGA to 3 RCA Component/HDTV Adapter
- 6..... RCA Component Cable for YPbPr
- 7..... HDMI to DVI Adapter
- 8.....HDMI Cable
- 9..... VGA to VGA Cable
- 10.....SCART VGA/S-Video Adapter
- 11.....Audio Output Cable

## Powering On/Off the Projector

### Powering On the Projector

1. Remove the lens cap. ❶
2. Ensure that the power cord and signal cable are securely connected. The Power LED will turn red.
3. Turn on the lamp by pressing “Power/Standby” button on the control panel. ❷ And the Power LED will turn green.
4. Turn on your source (computer, notebook, video player, etc.). The projector will detect your source automatically within “Management” menu; check that “Source Lock” has been set to “Off”.

#### Text Pattern

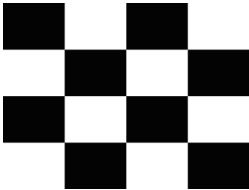

- ❖ If the screen displays “No Signal”, please make sure the signal cables are securely connected.
- ❖ To access the built-in test pattern, please press the “AV Mute” button, then up arrow.
- ❖ If you connect multiple sources at the same time, use the “Source” button on the control panel or direct source key on remote control to switch.



- ❖ Turn on the projector first and then the signal sources.



Lens Cap



Power/Standby





## Powering Off the Projector

1. Press the “Power/Standby” button to turn off the projector lamp; you will see a message

Wait 2 minutes before you can switch on again.

Press “Power” key again to confirm.

Press “Enter” key to remove this warning.

displayed on the projector’s screen. Press the “Power/Standby” button again to confirm, otherwise the message will disappear after 5 seconds.

2. The cooling fans continue to operate for about 30 seconds for cooling cycle and the Power LED will flash red. When the Power LED stops flashing, the projector has entered standby mode.

Once in standby mode, simply press “Power/Standby” button to restart the projector.

3. Disconnect the power cord from the electrical outlet and the projector.
4. Do not turn on the projector immediately following a power off procedure.

## Warning Indicator

- ❖ When the “TEMP” indicator turns red, it indicates the projector has overheated. The projector will automatically shut itself down.
- ❖ When the “LAMP” indicator turns red, it indicates a problem with the lamp. Turn off the projector and disconnect the power cord from the electrical outlet, then contact your local dealer or our service center. See page 45.
- ❖ When the “LAMP” indicator flashes red, it indicates the fan has failed. Stop using the projector and disconnect the power cord from the electrical outlet, then contact your local dealer or our service center. See page 45.



## Adjusting the Projected Image

### Adjusting the Projector Image Height

The projector is equipped with elevator feet for adjusting the image height.

To raise the image:

1. Press the elevator buttons **1**.
2. Raise the image to the desired height angle **2**, then release the button to lock the elevator feet into position.
3. Use screw in feet **3** to fine-tune the display angle.

To lower the image:

1. Press the elevator buttons.
2. Lower the image, then release the button to lock the elevator feet into position.
3. Use screw in foot **3** to fine-tune the display angle.



## Adjusting the Projector Zoom / Focus

You may turn the zoom lever to zoom in or out. To focus the image, rotate the focus ring until the image is clear. The projector will focus at distances from 3.3 to 40.0 feet (1.0 to 12.2 meters).



## Adjusting Projection Image Size

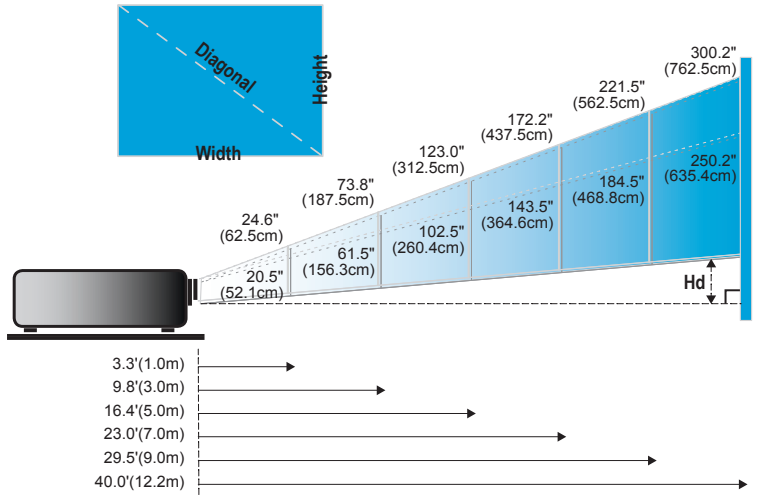

Screen (Diagonal)	Max.	24.6" (62.5cm)	73.8" (187.5cm)	123.0" (312.5cm)	172.2" (437.5cm)	221.5" (562.5cm)	300.2" (762.5cm)
	Min.	20.5" (52.1cm)	61.5" (156.3cm)	102.5" (260.4cm)	143.5" (364.6cm)	184.5" (468.8cm)	250.2" (635.4cm)
Screen Size	Max. (WxH)	19.68" x 14.76" 50.0 x 37.5cm	59.04" x 44.28" 150.0 x 112.5cm	98.4" x 73.8" 250.0 x 187.5cm	137.76" x 103.32" 350.0 x 262.5cm	177.20" x 132.90" 450.0 x 337.5cm	240.16" x 180.12" 610.0 x 457.5cm
	Min. (WxH)	16.40" x 12.30" 41.7 x 31.3cm	49.20" x 36.90" 125.0 x 93.8cm	82.0" x 61.5" 208.3 x 156.2cm	114.8" x 86.1" 291.7 x 218.8cm	147.6" x 110.7" 375.0 x 281.3cm	200.16" x 150.12" 508.3 x 381.2cm
Hd	Max.	2.21" (5.6cm)	6.64" (16.9cm)	11.07" (28.1cm)	15.50" (39.4cm)	19.94" (50.6cm)	27.02" (68.6cm)
	Min.	1.85" (4.7cm)	5.54" (14.1cm)	9.23" (23.4cm)	12.92" (32.8cm)	16.61" (42.2cm)	22.52" (57.2cm)
Distance		3.3' (1.0m)	9.8' (3.0m)	16.4' (5.0m)	22.3' (7.0m)	29.5' (9.0m)	40.0' (12.2m)

❖ This graph is for user's reference only.



## Control Panel & Remote Control

There are two ways for you to control the functions: Remote Control and Control Panel.









---

### Using the Control Panel

---



---

 <b>Power/Standby</b>	Refer to the “Power On/Off the Projector” section on pages 14-15.
 <b>Source</b>	Press “Source” to select an input signal.
<b>Menu</b>	Turns the menu On or Off.
<b>Four Directional Select Keys</b>	Use     to navigate through the menus.
 <b>Enter</b>	Confirm your item selection.
 <b>Keystone</b>	Adjusts image distortion caused by tilting the projector ( $\pm 16$ degrees).
 <b>Re-Sync</b>	Automatically synchronizes the projector to the input source.







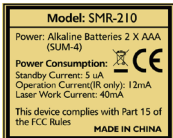



---



# User Controls



## Using the Remote Control

 <b>Power</b>	Refer to the “Power On/Off the Projector” section on pages 14-15.
<b>Re-Sync</b>	Automatically synchronizes the projector to the input source.
<b>Keystone</b>	Adjusts image distortion caused by tilting the projector ( $\pm 16$ degrees).
<b>Display Format</b>	Display the “Display Format” section of the on-screen display menu to select the desired aspect ratio.
 <b>Laser Button</b>	Aim the remote at the viewing screen, press and hold this button to activate the laser pointer.
<b>AV Mute</b>	Momentarily turns off the audio and video. Press this button again to unlock.
<b>Freeze</b>	Press “Freeze” to pause the screen image. Press this button again to unlock.
<b>Volume +/-</b>	Increases/decreases speaker volume.
<b>Display Mode</b>	Select the display mode from PC, Photo, Video, sRGB and User.
<b>Mouse Control</b>	Use this button to navigate the mouse on the page.
<b>Mouse Right Click</b>	Mouse right click.
<b>Mouse Left Click</b>	Mouse left click.
 <b>Page Up</b>	Use this button to page up.
 <b>Page Down</b>	Use this button to page down.
 <b>Zoom In</b>	Zoom in to magnify the image.
 <b>Zoom Out</b>	Zoom out to reduce the image.
<b>Four Directional Select Keys</b>	Use     to navigate through the menus.
<b>Menu</b>	Display or exits the on-screen display menus for projector.



# User Controls

<b>Clear</b>	Clear your selection.
<b>Enter</b>	Confirm your item selection.
<b>Source Lock</b>	Select auto detection all connector ports or lock current connector port. (See page 30 for more)
<b>Video</b>	Choose composite video source.
<b>S-Video</b>	Choose S-Video source.
<b>VGA1</b>	Choose primary VGA-In source.
<b>VGA2</b>	Choose secondary VGA-In or SCART source.
<b>DVI</b>	Choose DVI-D source.



## On Screen Display Menus

The Projector has multilingual On Screen Display menus that allow you to make image adjustments and change a variety of settings. The projector will automatically detect the source.

### How to Operate

1. To open the OSD menu, press “Menu” on the Remote Control or Control Panel.
2. When OSD is displayed, use ◀▶ keys to select any item in the main menu. While making a selection on a particular page, press ▼ key to enter sub menu.
3. Use ▲▼ keys to select the desired item and adjust the settings by ▶ key.
4. Select the next item to be adjusted in the sub menu and adjust as described above.
5. Press “Menu” to confirm, and the screen will return to the main menu.
6. To exit, press “Menu” again. The OSD menu will close and the projector will automatically save the new settings.

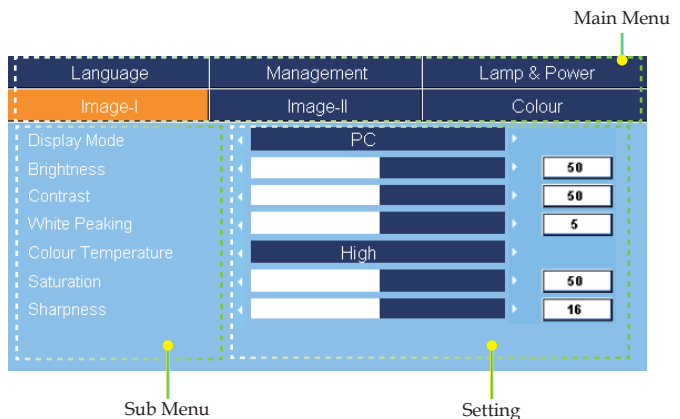

## Menu Tree

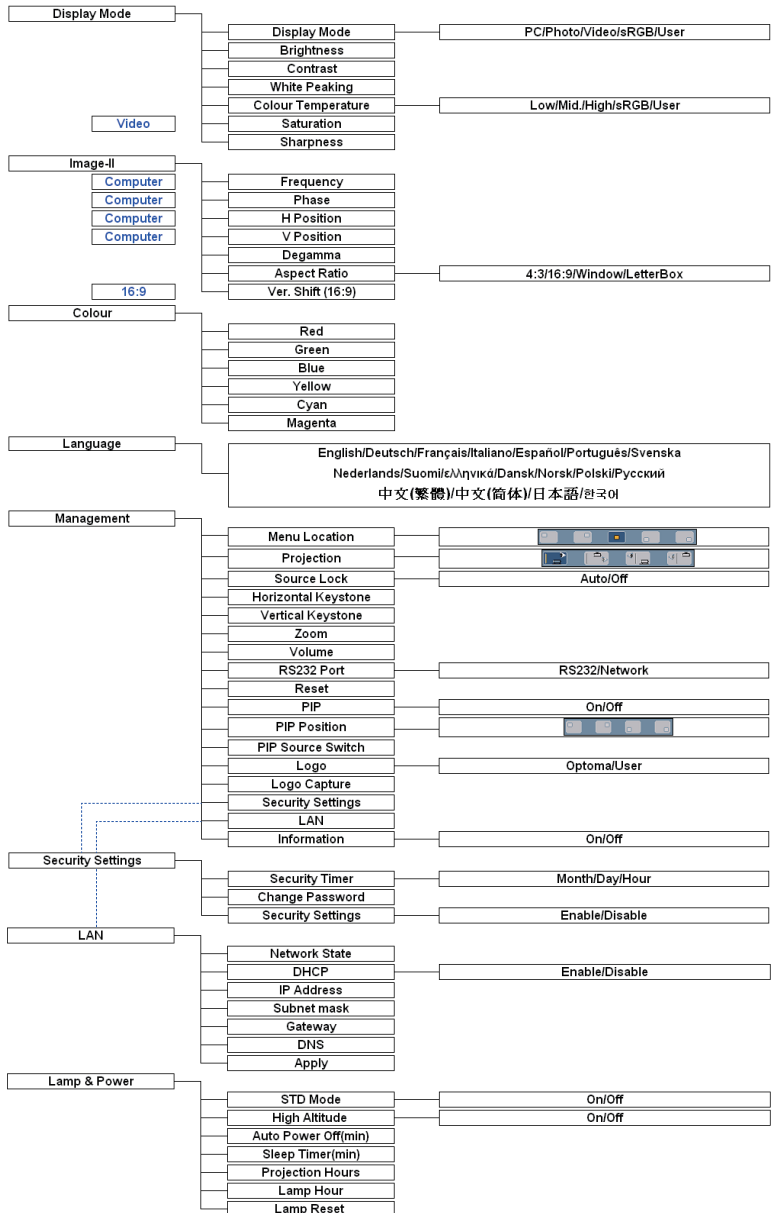



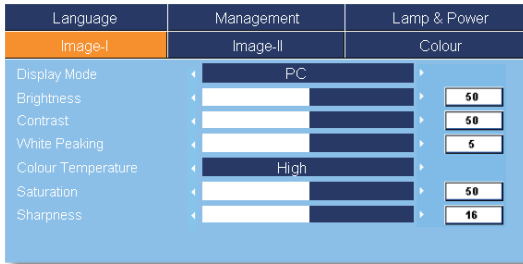

## Image-I

### Display Mode

There are many factory presets optimized for various types of images.

- ▶ PC: For computer or notebook. (brightest image)
- ▶ Photo: For optimum colour at high brightness.
- ▶ Video: For playing video in a bright environment.
- ▶ sRGB: For standard PC colour. (best colour reproduction)
- ▶ User: Memorize user's settings.

### Brightness

Adjust the brightness of the image.

- ▶ Press the ◀ to darken image.
- ▶ Press the ▶ to lighten the image.

### Contrast

The contrast controls the degree of difference between the lightest and darkest parts of the picture. Adjusting the contrast changes the amount of black and white in the image.

- ▶ Press the ◀ to decrease the contrast.
- ▶ Press the ▶ to increase the contrast.

### White Peaking

Use the white peaking control to set the white peaking level of DMD chip. 0 stands for minimal peaking, and 10 stands for maximum peaking. If you prefer a brighter image, adjust towards the maximum setting. For a smooth and more natural image, adjust towards the minimum setting.



## Colour Temperature

Adjusts the colour temperature. At higher temperature, the screen looks colder; at lower temperature, the screen looks warmer.

Each display mode has its own colour temperature and can memorize user's selection. For example:

Display mode	PC	Photo	Video	sRGB	User
Colour Temp.	sRGB	Low	User	High	Mid



- ❖ "Saturation" functions is only supported under Video mode.

When you adjust the colour setting item, the colour temperature will be set as "User" automatically. And this set "User" is the same for all display mode. (See the section of "Colour Setting" for details).

## Saturation

Adjusts a video image from black and white to fully saturated colour.

- ▶ Press the ◀ to decrease the amount of saturation in the image.
- ▶ Press the ▶ to increase the amount of saturation in the image.

## Sharpness

Adjusts the sharpness of the image.

- ▶ Press the ◀ to decrease the sharpness.
- ▶ Press the ▶ to increase the sharpness.



Language	Management	Lamp & Power
Image-I	Image-II	Colour
Frequency		50
Phase		31
H Position		50
V Position		50
Degamma		4
Aspect Ratio	4:3	
Ver. Shift (16:9)		50

## Image-II



**NOTE**

- ❖ “Frequency”, “Phase”, “H. position” and “V. position” functions are only supported under Computer mode.

### Frequency

“Frequency” changes the display data frequency to match the frequency of your computer’s graphic card. If you experience a vertical flickering bar, use this function to make an adjustment.

### Phase

“Phase” synchronizes the signal timing of the display with the graphic card. If you experience an unstable or flickering image, use this function to correct it.

### H. Position (Horizontal Position)

- ▶ Press the ◀ to move the image left.
- ▶ Press the ▶ to move the image right.

### V. Position (Vertical Position)

- ▶ Press the ◀ to move the image down.
- ▶ Press the ▶ to move the image up.

### Degamma

This allows you to choose a degamma table that has been fine-tuned to bring out the best image quality for the input.

### Aspect Ratio

Use this function to choose your desired aspect ratio.

- ▶ 4:3 : The input source will be scaled to fit the projection screen.
- ▶ 16:9 : The input source will be scaled to fit the width of the screen.
- ▶ Window: When a 4:3 image is bigger than a 16:9 screen, select the “Window” mode to fit the image onto the screen without changing the projection distance.



# User Controls

- ▶ LBX: This format is for non-16x9, letterbox source and for users who use external 16x9 lens to display 2.35:1 aspect ratio using full resolution.

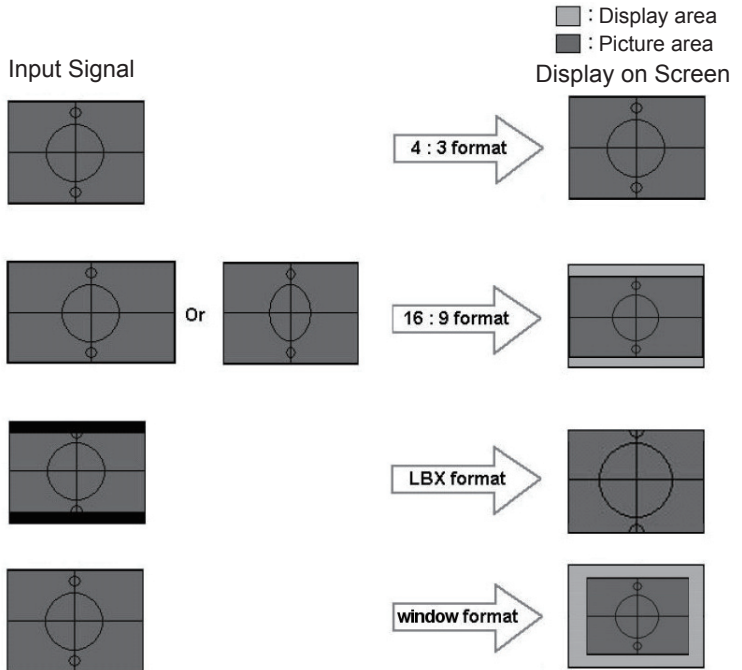

- ❖ Ver. Shift (16:9): Image Position at window mode will also be moved accordingly.

## Ver. Shift (16:9)

Adjust the image position up or down, when you select the aspect ratio of 16:9.

- ▶ Press the ◀ to move the image down.
- ▶ Press the ▶ to move the image up.





## Colour

### Colour

- f** Full Range: Adjust the Red, Green and Blue color for all screen.
- e** Enhance Individual: Adjust the Red, Green, Blue, Yellow, Cyan and Magenta colors for advanced adjustment of the individual colors.

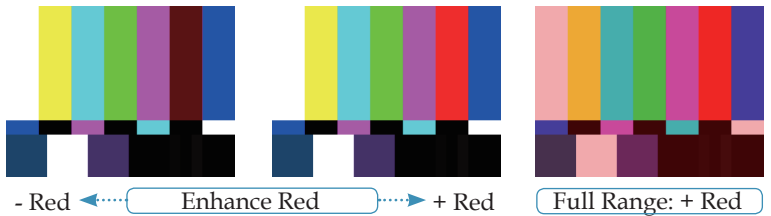

When you adjust the colour setting item, the colour temperature will be set as "User" automatically. And this set "User" is the same for all display mode. For example:

Icon	Colour Temp.
L	Low
M	Mid
H	High
S	sRGB
U	User

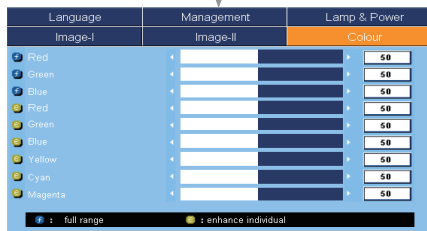
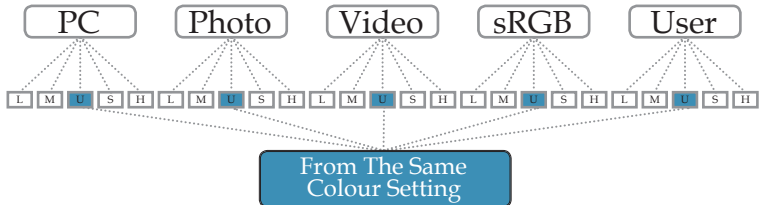

# User Controls

Different color setting will be memorized at 4 different source groups. But they will be same under same source.

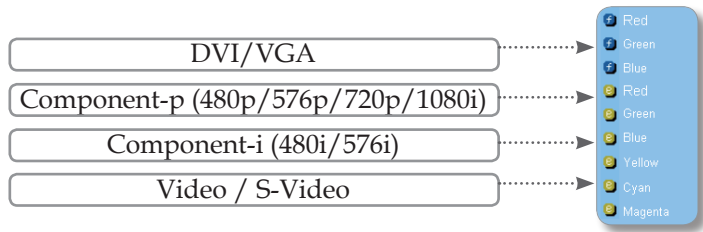

When we adjust color setting the current color temperature will be memorized before it auto switch to “User”. Because the memorized color temperature will be a base of “User”. For example:

1.) Colour temp. is High.



2.) User creates his favorite color based on “High” setting of colour temperature. So when user switches colour temperature to “User”, will find the image color temperature close to “High”.

Language	Management	Lamp & Power
Image-I	Image-II	Colour
Red		50
Green		50
Blue		50
Red		50
Green		50
Blue		50
Yellow		50
Cyan		50
Magenta		50

ⓘ : full range      Ⓢ : enhance individual



Image-I	Image-II	Colour
Language	Management	Lamp & Power
English	Nederlands	中文(简体)
Français	Suomi	中文(繁體)
Deutsch	ελληνικά	日本語
Italiano	Dansk	한국어
Español	Norsk	
Português	Polski	
Svenska	Русский	

## Language

### Language

Choose the multilingual OSD menu. Use the ▲ or ▼ key to select your preferred language.

Press “Enter” to finalize the selection.



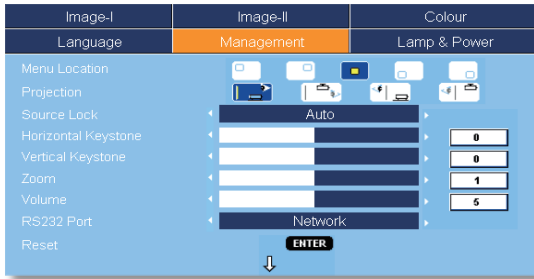





## Management

### Menu Location

Choose the menu location on the display screen.

### Projection

- ▶  Front-Desktop  
The factory default setting.
- ▶  Rear-Desktop  
When you select this function, the projector reverses the image so you can project from behind a translucent screen.
- ▶  Front-Ceiling  
When you select this function, the projector turns the image upside down for ceiling-mounted projection.
- ▶  Rear-Ceiling  
When you select this function, the projector reverses and turns the image upside down. You can project from behind a translucent screen with ceiling mounted projection.

### Source Lock

- ▶ Auto: The projector will search all connection port.
- ▶ Lock: The projector will lock connection port.

### Horizontal Keystone

Press the ◀ or ▶ to adjust image distortion horizontally and makes a squarer image.

### Vertical Keystone

Press the ◀ or ▶ to adjust image distortion vertically and makes a squarer image.

### Zoom

- ▶ Press the ◀ to reduce the size of an image.
- ▶ Press the ▶ to magnify an image on the projection screen.





## Volume

- ▶ Press ◀ to decrease the volume.
- ▶ Press ▶ to increase the volume.

## RS232 Port

- ▶ RS232: Allows RS232 control of an individual projector.
- ▶ Network: Allows LAN via web browser (Internet Explorer) to control of projector.

## Reset

Choose “Enter” to return the adjustments and settings to the factory default values.

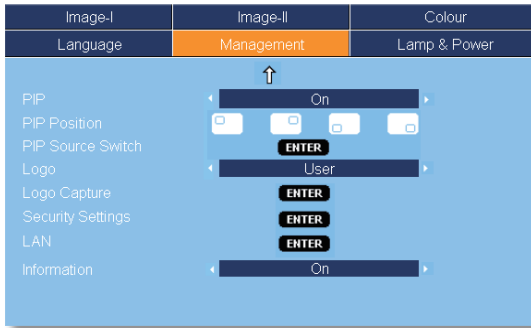

## *Management*

## PIP

Choose “On” to select on the PIP screen, Choose “Off” to select off the PIP screen.

## PIP Position

Choose the PIP screen position on the display screen.

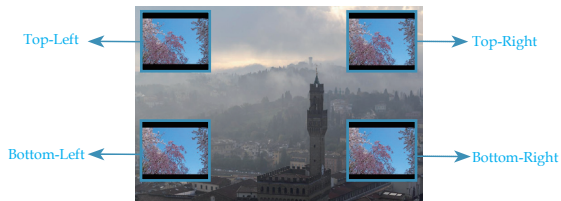

## PIP Source Switch

Press “Enter” to switch PIP screen source. (see page 32)



**PIP RULE TABLE**

Main source	Sub source				
	DVI-D	VGA	Componet-p	S-video	Video
DVI-D (digital RGB / HDCP)	×	×	×	✓	✓
VGA (analog RGB)	×	×	×	✓	✓
Componet-p (480p/576p/720p/1080i)	×	×	×	✓	✓
S-video	×	×	×	×	×
Video	×	×	×	×	×

## Logo

Use this function to select your desired startup screen. If you change the setting from one to another, when you exit the OSD menu, the new setting will take effect on next open.

- ▶ Optoma: The default startup screen of Optoma projector.
- ▶ User: Use memorize picture from “Logo Capture” function.

## Logo Capture

Press “Enter” to immediately capture a picture what on the display screen.

## Security Settings

### ■ *First Time:*

1. Press “Enter” to set password.
2. The Password is 4 digits, DEFAULT VALUE is “0000”. (first time)
3. Use number buttons on the remote to select your password, and then press “Enter” key to confirm your selection.



- ▶ **Security Timer:** Can be select the time (month/day/hour) function to set the number of hours the projector can be used. Once this time has elapsed you will be requested to enter your password again (Use number buttons on remote. To change password, follow change password instructions above).
- ▶ **Change Password:**
  1. Press “Enter” to input old password.



2. Use number button to enter current password, and then press “Enter” key again to reveal next OSD menu.
3. Scroll down to highlight Password, and then press “Enter” to activate.
4. Enter new password (4 digits in length) using the number buttons on the remote, then press “Enter” to confirm.
5. Enter new password again and press “Enter” to confirm.

▶ Security settings:

Enable: Choose “Enable” to enable security verification when turning on the projector.

Disable: Choose “Disable” to be able to switch on the projector without password verification.

## LAN

Press “Enter” to apply LAN settings. If the connection is successful, the OSD display will show the following dialogue box.

LAN	
Network State	Disconnect
DHCP	Disable
IP Address	10 . 0 . 50 . 100
Subnet mask	255 . 255 . 0 . 100
Gateway	10 . 0 . 50 . 254
DNS	0 . 0 . 0 . 0
Apply	ENTER

- ▶ Network State: To display network information.
- ▶ DHCP:
  - Enable: Assign an IP address to the projector from the DHCP server automatically.
  - Disable: Assign an IP address manually.
- ▶ IP Address: Select an IP address.
- ▶ Subnet Mask: Select subnet mask number.
- ▶ Gateway: Select the default gateway of the network connected to the projector.
- ▶ DNS: Select DNS number.
- ▶ Apply: Press “Enter” to apply the selection.

## Information

To display source information on the screen.



## How to use web browser to control your projector

1. Fill in a new IP, a subnet mask, a gateway and a DNS in the dialogue box .

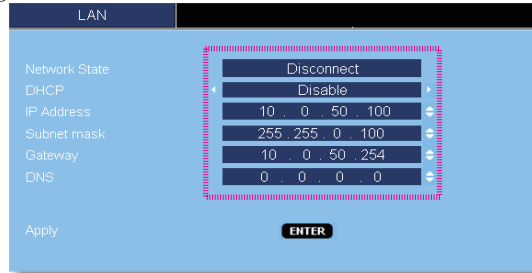

2. Then choose apply and press "Enter" button to effectuate the configuration process.
3. Open your web browser and type in from the OSD LAN screen then the web page will display as below:



**NOTE**

- ❖ When you used the projector IP address, you will can not link to your service server.



- 4: Open "Control Panel" to control your projector.

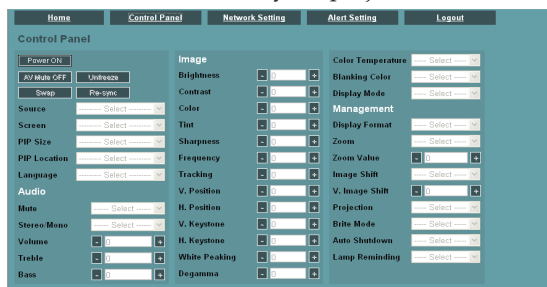

# User Controls

For example: Use Microsoft Internet Explorer (IE) web browser to control the projector, the IP address is `http://10.0.50.100`.

Step 1: Find an IP Address (10.0.50.100) from LAN function of projector.



Step 2: Select apply and press "Enter" button to submit function or press "menu" key to exit.

Step 3: To open Network Connections, click **Start**, click **Control Panel**, click **Network and Internet Connections**, and then click **Network Connections**. Click the connection you want to configure, and then, under **Network Tasks** , click **Change settings of this connection**.

Step 4: On the **General** tab, under **This connection uses the following items**, click **Internet Protocol (TCP/IP)**, and then click "Properties."

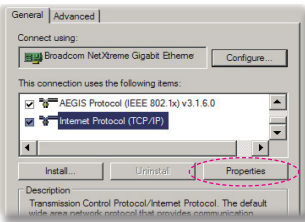

Step 7: The **Local Area Network (LAN) Setting** dialog box appears, In the **Proxy Server** area, cancel the **Use a proxy server for your LAN** check box, then click "OK" button twice.

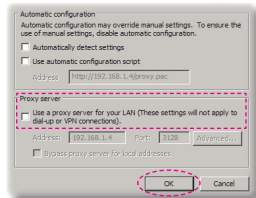

Step 5: Click **Use the following IP address**, and type in as below:

- 1) IP address: 10.0.50.XXX
- 2) Subnet mask: 255.255.0.0
- 3) Default gateway: 10.0.50.254

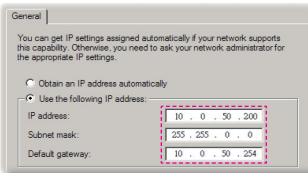

Step 8: Open your IE and type in the IP address of 10.0.50.100 in the URL, then press "Enter" key. The web page will display as below:



Step 6: To open Internet Options, click IE web browser, click Internet Options, click the **Connections** tab and click "LAN Settings."

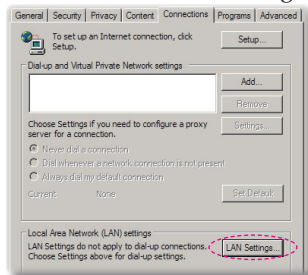

Step 9: Open "Control Panel" to control your projector.

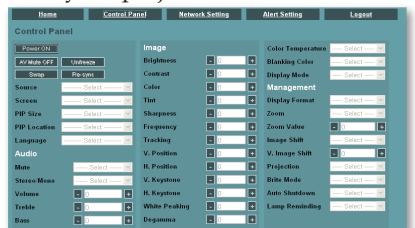



Image-I	Image-II	Colour
Language	Management	Lamp & Power
STD Mode	On	
High Altitude	On	
Auto Power Off(min)		0
Sleep Timer(min)		0
Projection Hours	9999 min	
Lamp Hour	3000 min	
Lamp Reset	ENTER	

## Lamp & Power

### STD Mode

Choose "On" to dim the projector lamp which will lower power consumption and extend the lamp life by up to 130%. Choose "Off" to return to BRIGHT mode.

### High Altitude

Choose "On" to turn on High Altitude mode. Operates the fans at full speed continuously to allow for proper high altitude cooling of the projector.

### Auto Power Off (min)

Sets the countdown timer interval. The countdown timer will start, when there is no signal being sent to the projector. Then projector will automatically power off when the countdown has finished. (In minutes)

### Sleep Timer (min)

Sets the countdown timer interval. The timer will begin, with or without a signal input. Then the projector will automatically power off then the sleep timer countdown has finished. (In minutes)

### Projection Hour

Displays the projection time.

### Lamp Hours

Displays the cumulative lamp operating time.

### Lamp Reset

Resets the lamp life hour counter after replacing the lamp.



## Troubleshooting

*If you experience trouble with the projector, refer to the following information. If the problem persists, please contact your local reseller or service center, see page 45 for details.*

### **Problem: No image appears on screen**

- ▶ Ensure all the cables and power connections are correctly and securely connected as described in the “Installation” section.
- ▶ Ensure the pins of connectors are not crooked or broken.
- ▶ Check if the projection lamp has been securely installed. Please refer to the “Replacing the lamp” section.
- ▶ Make sure you have removed the lens cap and the projector is switched on.
- ▶ Ensure that the “AV Mute” feature is not turned on.

### **Problem: Left of right edge of the image is missing or the image is unstable or noisy**

- ▶ Press “Re-Sync” on the remote control or on control panel.
- ▶ If you are using a PC:

#### For Windows 3.x:

1. In the Windows Program Manager, double click the “Windows Setup” icon in the Main group.
2. Verify that your display resolution setting is less than or equal to 1600 x 1200.

#### For Windows 95, 98, 2000, XP:

1. From the “My Computer” icon, open the “Control Panel” folder, and double click the “Display” icon.
2. Select the “Settings” tab.
3. Click on the “Advanced Properties” button.

**If the projector is still not projecting the whole image, you will also need to change the monitor display you are using. Refer to the following steps.**

4. Verify the resolution setting is less than or equal to 1600 x 1200 resolution.



5. Select the “Change” button under the “Monitor” tab.
  6. Click on “Show all devices.” Next, select “Standard monitor types” under the SP box; choose the resolution mode you need under the “Models” box.
- ▶ If you are using a Notebook:
1. First, follow the steps above to adjust resolution of the computer.
  2. Press the toggle output settings. example: [Fn]+[F4]

Compaq ⇒	[Fn]+[F4]	Packard ⇒	[Fn]+[F4]
Dell ⇒	[Fn]+[F8]	Hewlett ⇒	[Fn]+[F4]
Gateway ⇒	[Fn]+[F4]	NEC ⇒	[Fn]+[F3]
IBM ⇒	[Fn]+[F7]	Toshiba ⇒	[Fn]+[F5]
Mac Apple: System Preference ⇒ Display ⇒ Arrangement ⇒ Mirror display			

- ▶ If you experience difficulty changing resolutions or your monitor freezes, restart all equipment including the projector.

## **Problem: The screen of the Notebook or PowerBook computer is not displaying a presentation**

- ▶ If you are using a Notebook PC:
- Some Notebook PCs may deactivate their own screens when a second display device is in use. Each has a different way to be reactivated. Refer to your computer’s documentation for detailed information.

## **Problem: Image is unstable or flickering**

- ▶ Use “Phase” to correct it. (See page 25)
- ▶ Change the monitor colour setting on your computer.

## **Problem: Image has vertical flickering bar**

- ▶ Use “Frequency” to make an adjustment. (See page 25)
- ▶ Check and reconfigure the display mode of your graphic card to make it compatible with the product.

## **Problem: Image is out of focus**

- ▶ Adjust the Focus Ring on the projector lens.





- ▶ Make sure the projection screen is between distance 3.3 to 40.0 feet (1.0 to 12.2 meters) from the projector. (See page 17)

## Problem: The image is stretched when displaying 16:9 DVD

The projector automatically detects 16:9 DVD and adjusts the aspect ratio by digitizing to full screen with 4:3 default setting.

If the image is still stretched, you will also need to adjust the aspect ratio by referring to the following:

- ▶ Please select 4:3 aspect ratio type on your DVD player if you are playing a 16:9 DVD.
- ▶ If you can't select 4:3 aspect ratio type on your DVD player, please select 4:3 aspect ratio in the on screen menu.

## Problem: Image is reversed

- ▶ Select "Management→Projection" from the OSD and adjust the projection direction. (See page 30)

## Problem: Lamp burns out or makes a popping sound

- ▶ When the lamp reaches its end of life, it will burn out and may make a loud popping sound. If this happens, the projector will not turn on until the lamp module has been replaced. To replace the lamp, follow the procedures in the "Replacing the Lamp". (See page 41)

## Problem: LED lighting message

Message	Power-LED		Temp-LED	Lamp-LED
	(Green)	(Red)		
Standby State (Input power cord)	○	☀	○	○
Warming	Flashing	○	○	○
Normal Mode	☀	○	○	○
Cooling	○	Flashing	○	○
Error (Lamp failed)	○	○	○	☀
Error (Fan failed)	○	○	○	Flashing
Error (Over Temp.)	○	○	☀	○



Steady light ⇒ ☀

No light ⇒ ○



## Problem: Message Reminders

### ▶ Fan fail:

Warning! FAN LOCKED

The projector will switch off automatically

Please contact a service centre for repair

### ▶ Over temperature:

Warning! TEMPERATURE TOO HIGH

The projector will switch off automatically

Please:

1. Allow cool down for 3 minutes
2. Make sure air in and outlets are not blocked
3. Make sure the environment temperature is under 35 degree C

If the problem persists in spite of the above,  
please contact a service centre for repair.

### ▶ Power Off:

Wait 2 minutes before you can switch on again.

Press "Power" key again to confirm.

Press "Enter" key to remove this warning.

### ▶ Replace the lamp:

! Lamp life exceeded.

Remaining Security Time is 9999 mon 99 day 99 hr 99 min



## Replacing the Lamp

The projector keeps track of the lamp usage. It will show you a warning message:



**Warning:** Lamp compartment is hot! Allow 30 minutes to cool down before changing lamp!

When you see this message, change the lamp as soon as possible. Make sure the projector has cooled down for at least 30 minutes before changing the lamp.

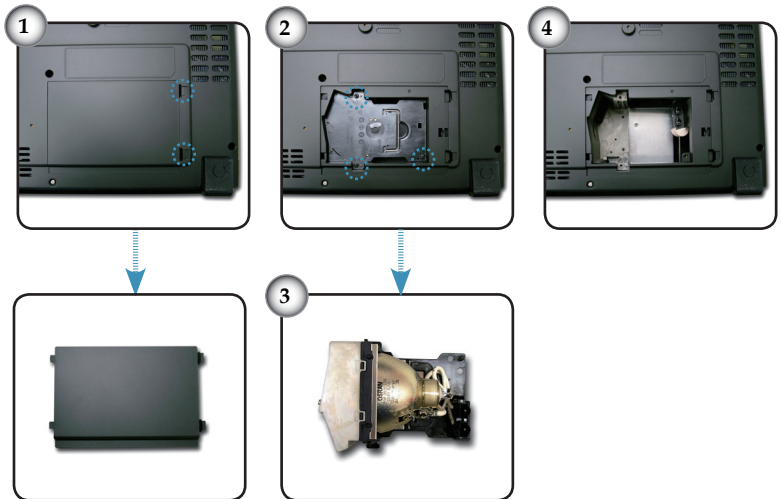

**Warning:** To reduce the risk of personal injury, do not drop the lamp module or touch the lamp bulb. The bulb may shatter and cause injury if it is dropped.

### Lamp Replacement Procedure:

1. Turn off the power by pressing the Power/Standby button.
2. Allow the projector to cool down for at least 30 minutes.
3. Disconnect the power cord.
4. Push up and remove the cover. ❶
5. Use a screwdriver to remove the 3 screws from the lamp module. ❷
6. Pull out the lamp module. ❸

To replace the lamp module, reverse the previous steps.



## Compatibility Modes

Mode	Resolution	(ANALOG)		(DIGITAL)	
		V.Frequency (Hz)	H.Frequency (kHz)	V.Frequency (Hz)	H.Frequency (kHz)
VESA VGA	640 x 350	70	31.5	70	31.5
VESA VGA	640 x 350	85	37.9	85	37.9
VESA VGA	640 x 400	85	37.9	85	37.9
VESA VGA	640 x 480	60	31.5	60	31.5
VESA VGA	640 x 480	72	37.9	72	37.9
VESA VGA	640 x 480	75	37.5	75	37.5
VESA VGA	640 x 480	85	43.3	85	43.3
VESA VGA	720 x 400	70	31.5	70	31.5
VESA VGA	720 x 400	85	37.9	85	37.9
VESA SVGA	800 x 600	56	35.2	56	35.2
VESA SVGA	800 x 600	60	37.9	60	37.9
VESA SVGA	800 x 600	72	48.1	72	48.1
VESA SVGA	800 x 600	75	46.9	75	46.9
VESA SVGA	800 x 600	85	53.7	85	53.7
VESA XGA	1024 x 768	60	48.4	60	48.4
VESA XGA	1024 x 768	70	56.5	70	56.5
VESA XGA	1024 x 768	75	60.0	75	60.0
VESA XGA	1024 x 768	85	68.7	85	68.7
* VESA SXGA	1152 x 864	70	63.8	70	63.8
* VESA SXGA	1152 x 864	75	67.5	75	67.5
* VESA SXGA	1152 x 864	85	77.1	85	77.1
* VESA SXGA	1280 x 1024	60	63.98	60	63.98
* VESA SXGA	1280 x 1024	75	79.98	75	79.98
* VESA SXGA	1280 x 1024	85	91.1	85	91.1
* VESA SXGA+	1400 x 1050	60	63.98	60	63.98
* VESA UXGA	1600 x 1200	60	75	60	75

Mode	Resolution	(ANALOG)		(DIGITAL)	
		V.Frequency (Hz)	H.Frequency (kHz)	V.Frequency (Hz)	H.Frequency (kHz)
MAC LC 13"	640 x 480	66.66	34.98	***	***
MAC II 13"	640 x 480	66.68	35	***	***
MAC 16"	832 x 624	74.55	49.725	***	***
MAC 19"	1024 x 768	75	60.24	***	***
* MAC	1152 x 870	75.06	68.68	***	***
MAC G4	640 x 480	60	31.35	***	***
i MAC DV	1024 x 768	75	60	***	***
* i MAC DV	1152 x 870	75	68.49	***	***
* i MAC DV	1280 x 960	60	60	***	***



**Note** Remark : "\*" compressed computer image.



## RS232 Commands

### RS232 Connector

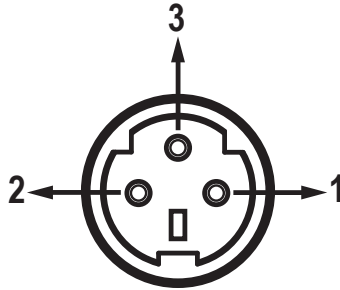

Pin no.	Name	I/O (From Projector Side)
1	TXD	OUT
2	RXD	IN
3	GND	—

### VGA-In Connector

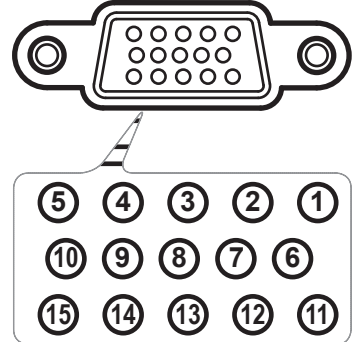

Pin no.	Spec.
1	R(REDF)/Cr
2	G(GREEN)/Y
3	B(BLUE)/Cb
4	NC
5	GND
6	GND
7	GND
8	GND
9	DDC 5V
10	HOT_DET
11	NC
12	DDC Data
13	HS/CS
14	VS
15	DDC Clock



## Ceiling Mount Installation

1. To prevent damaging your projector, please use the ceiling mount package for installation.
2. If you wish to use a third party ceiling mount kit, please ensure the screws used to attached a mount to the projector meet the following specifications:

- ▶ **Screw type: M3**
- ▶ **Maximum screw length: 10mm**
- ▶ **Minimum screw length: 8mm**



**NOTE**

❖ Please note that damage resulting from incorrect installation will invalidate the warranty.



**NOTE**

### ⚠ Warning:

1. If you buy the ceiling mount from another manufacturer, please ensure that there is at least 10cm distance between the bottom cover of the projector and the ceiling.
2. Avoid placing the projector near sources of heat such as air-conditioning units and heaters otherwise it may overheat and shut down automatically.

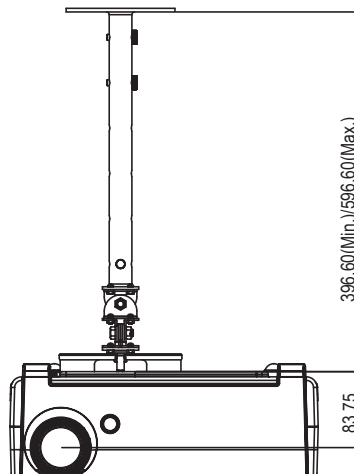
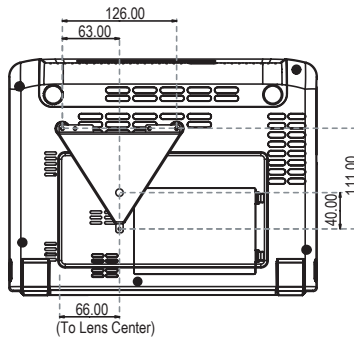

## Optoma Global Offices

*For service or support please contact your local office.*

### USA

715 Sycamore Drive  
Milpitas, CA 95035, USA  
[www.optomausa.com](http://www.optomausa.com)

Tel : 408-383-3700  
Fax: 408-383-3702  
Service : [service@optoma.com](mailto:service@optoma.com)

### Canada

5630 Kennedy Road,  
Mississauga, ON, L4Z 2A9, Canada  
Tel : 905-882-4228  
[www.optoma.com](http://www.optoma.com)

Fax: 905-882-4229

### Europe

42 Caxton Way, The Watford Business Park  
Watford, Hertfordshire, WD18 8QZ, UK  
Tel : +44 (0) 1923 691 800  
[www.optomaeurope.com](http://www.optomaeurope.com)

Fax: +44 (0) 1923 691 888

Service Tel : +44 (0)1923 691865      Service : [service@tsc-europe.com](mailto:service@tsc-europe.com)

### Taiwan

5F., No. 108, Minchiuan Rd.  
Shindian City, Taipei Taiwan 231,  
R.O.C.  
Service : [services@optoma.com.tw](mailto:services@optoma.com.tw)

Tel : +886-2-2218-2360  
Fax: +886-2-2218-2313  
[www.optoma.com.tw](http://www.optoma.com.tw)  
asia.optoma.com

### Hong Kong

Rm. 2507, 25/F., China United Plaza,  
No. 1008 Tai Nan West St., Kowloon, H.K.  
Tel : +852-2396-8968  
[www.optoma.com.hk](http://www.optoma.com.hk)

Fax: +852-2370-1222

### China

5F, No. 1205, Kaixuan Rd.,  
Changning District  
Shanghai, 200052, China

Tel : +86-21-62947376  
Fax: +86-21-62947375  
[www.optoma.com.cn](http://www.optoma.com.cn)

### Latin America

715 Sycamore Drive  
Milpitas, CA 95035, USA  
[www.optoma.com.br](http://www.optoma.com.br)

Tel : 408-383-3700  
Fax: 408-383-3702  
[www.optoma.com.mx](http://www.optoma.com.mx)

