

**BenQ**

PB8253/PB8263 Digital Projector

Installation Series

User's Manual

# Welcome

## Copyright

Copyright 2006 by BenQ Corporation. All rights reserved. No part of this publication may be reproduced, transmitted, transcribed, stored in a retrieval system or translated into any language or computer language, in any form or by any means, electronic, mechanical, magnetic, optical, chemical, manual or otherwise, without the prior written permission of BenQ Corporation.

## Disclaimer

BenQ Corporation makes no representations or warranties, either expressed or implied, with respect to the contents hereof and specifically disclaims any warranties, merchantability or fitness for any particular purpose. Further, BenQ Corporation reserves the right to revise this publication and to make changes from time to time in the contents hereof without obligation to notify any person of such revision or changes.

\*DLP, Digital Micromirror Device and DMD are trademarks of Texas Instruments. Others are copyrights of their respective companies or organizations.



# Table of contents

|   |    |
|---|----|
| Important safety instructions .....                             | 5  |
| Introduction .....  | 9  |
| Projector features .....  | 9  |
| Shipping contents .....   | 10 |
| Projector exterior view .....                                   | 11 |
| Controls and functions .....                                    | 13 |
| Positioning your projector .....                                | 17 |
| Choosing a location .....                                       | 17 |
| Safety instructions for ceiling mounting of the projector ..... | 18 |
| Obtaining a preferred projected image size .....                | 19 |
| Connection .....  | 22 |
| Connecting a computer or monitor .....                          | 22 |
| Connecting Video source devices .....                           | 25 |
| Operation .....   | 30 |
| Start up .....  | 30 |
| Switching input signal .....                                    | 31 |
| Adjusting the projected image .....                             | 31 |
| Selecting the aspect ratio .....                                | 33 |
| Optimizing the image .....                                      | 34 |
| Operating in a high altitude environment .....                  | 37 |
| Personalizing the projector menu display .....                  | 37 |
| Hiding the image .....  | 38 |
| Remote paging operations .....                                  | 38 |
| Freezing the image .....  | 38 |
| Using the laser pointer in the presentation .....               | 38 |
| PIP (Picture In Picture) operation .....                        | 39 |
| Shutting down the projector .....                               | 40 |
| On-Screen Display (OSD) menu operation .....                    | 41 |
| Maintenance .....   | 48 |
| Care of the projector .....                                     | 48 |
| Lamp information .....  | 50 |

|                                |    |
|--------------------------------|----|
| Temperature information .....  | 52 |
| Indicators.....                | 53 |
| Troubleshooting.....           | 55 |
| Specifications.....            | 57 |
| Projector specifications ..... | 57 |
| Dimensions.....                | 58 |
| Timing chart .....             | 58 |
| Warranty.....                  | 60 |
| Limited Warranty .....         | 60 |
| Regulation Statements .....    | 61 |
| FCC statement .....            | 61 |
| EEC statement .....            | 61 |
| MIC statement .....            | 61 |
| WEEE directive .....           | 61 |

# 1 Important safety instructions

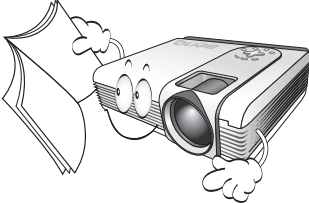
Your BenQ projector is designed and tested to meet the latest standards for safety of information technology equipment. However, to ensure safe use of this product, it is important that you follow the instructions mentioned in this manual and marked on the product.

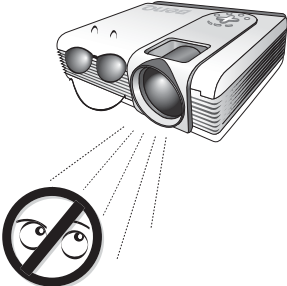
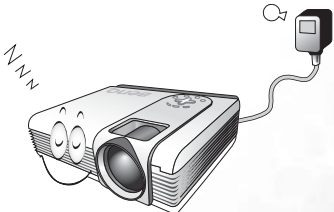
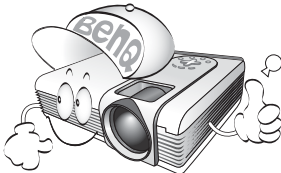
| Safety Instructions   |   |
|---|---|
| <p>1. Please read this manual before you operate your projector. Save it for future reference.</p>                     | <p>4. Always open the lens shutter or remove the lens cap when the projector lamp is on.</p>   |
| <p>2. Do not look straight at the projector lens during operation. The intense light beam may damage your eyes.</p>   | <p>5. In some countries, the line voltage is NOT stable. This projector is designed to operate safely within a mains voltage between 100 to 240 volts AC, but could fail if power cuts or surges of <math>\pm 10</math> volts occur. In areas where the mains voltage may fluctuate or cut out, it is recommended that you connect your projector through a power stabilizer, surge protector or uninterruptible power supply (UPS).</p>  |
| <p>3. When you think service or repair is required, take the projector only to a suitably qualified technician.</p>  | <p>6. Do not block the projection lens with any objects when the projector is under operation as this could cause the objects to become heated and deformed or even cause a fire. To temporarily turn off the lamp, press <b>BLANK</b> on the projector or remote control.</p>  |

## Safety Instructions (Continued)

7. The lamp becomes extremely hot during operation. Allow the projector to cool for approximately 45 minutes prior to removing the lamp assembly for replacement.

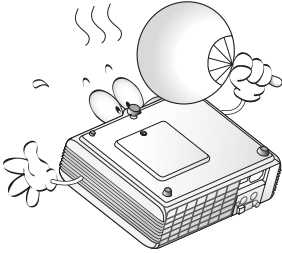

8. Do not operate lamps beyond the rated lamp life. Excessive operation of lamps beyond the rated life could cause them to break on rare occasions.

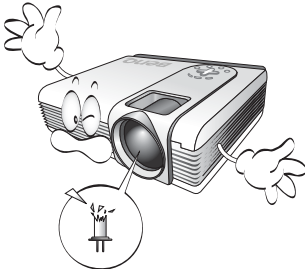

9. Never replace the lamp assembly or any electronic components unless the projector is unplugged.

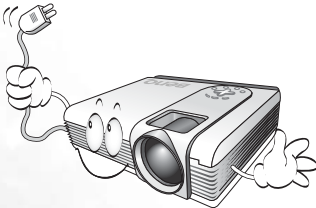

10. Do not place this product on an unstable cart, stand, or table. The product may fall, sustaining serious damage.



11. Do not attempt to disassemble this projector. There are dangerous high voltages inside which may cause death if you should come into contact with live parts. The only user serviceable part is the lamp which has its own removable cover. Under no circumstances should you ever undo or remove any other covers. Refer servicing only to suitably qualified professional service personnel.

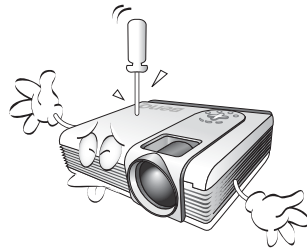

## Safety Instructions (Continued)

12. Do not place this projector in any of the following environments.

- Space that is poorly ventilated or confined. Allow at least 50 cm clearance from walls and free flow of air around the projector.
- Locations where temperatures may become excessively high, such as the inside of a car with all windows rolled up.
- Locations where excessive humidity, dust, or cigarette smoke may contaminate optical components, shortening the projector's life span and darkening the image.

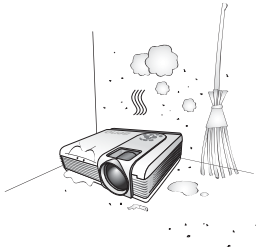

- Locations near fire alarms
- Locations with an ambient temperature above 40°C/104°F
- Locations where the altitudes are higher than 10000 feet.

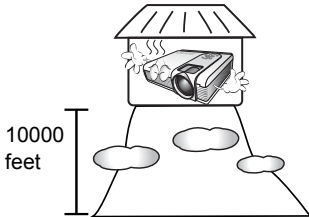

13. Do not block the ventilation holes.

- Do not place the projector on a blanket, bedding or any other soft surface.
- Do not cover the projector with a cloth or any other item.
- Do not place inflammables near the projector.



If the ventilation holes are seriously obstructed, overheating inside the projector may result in a fire.

14. Always place the projector on a level, horizontal surface during operation.

- Do not use if tilted at an angle of more than 10 degrees left to right, nor at angle of more than 15 degrees front to back. Using the projector when it is not fully horizontal may cause a malfunction of, or damage to, the lamp.

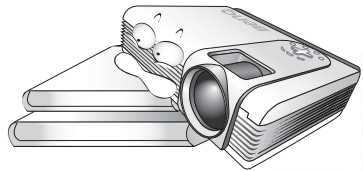

## Safety Instructions (Continued)

15. Do not store the projector on end vertically. Doing so may cause the projector to fall over, causing injury or resulting in damage.

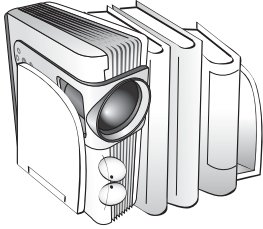

16. Do not step on the projector or place any objects upon it. Besides probable physical damage to the projector, doing so may result in accidents and possible injury.



17. Do not place liquids near or on the projector. Liquids spilled into the projector may cause it to fail. If the projector does become wet, disconnect it from the power supply's wall socket and call BenQ to have the projector serviced.



18. This product is capable of displaying inverted images for ceiling mount installation.



**Use only BenQ's Ceiling Mount Kit for mounting the projector and ensure it is securely installed.**

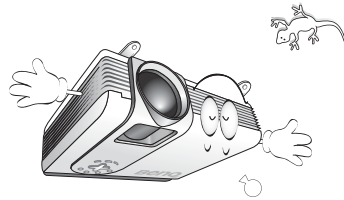

19. When the projector is under operation, you may sense some heated air and odor from its ventilation grill. It is a normal phenomenon and not a product defect.



## 2 Introduction

### Projector features

The projector integrates high-performance optical engine projection and a user-friendly design to deliver high reliability and ease of use.

The projector offers the following features:

- High quality manual zoom lens
- Full-function remote control with laser pointer
- One-key auto-adjustment to display the best picture quality
- Digital keystone correction to correct distorted images
- Adjustable color balance control for data/video display
- Ultra-high brightness projection lamp
- Ability to display 16.7 million colors
- Multi-language On-Screen Display (OSD) menus
- 8 sets of preset application mode
- Switchable normal and Economic modes to reduce the power consumption
- Built-in speakers provide stereo audio reproduction
- Component HDTV compatibility (YPbPr)
- Two PC input terminals (RGB signal input socket and a shared DVI-A connector) and one PC output terminal
- Replaceable dust filter
-  **The apparent brightness of the projected image will vary depending on the ambient lighting conditions, selected input source contrast/brightness settings, and is directly proportional to projection distance.**
- **The lamp brightness will decline over time and may vary within the lamp manufacturers specifications. This is normal and expected behavior.**

# Shipping contents

The projector is shipped with the cables required for connection to a PC and to video equipment. Carefully unpack and verify that you have all of the items shown below. If any of these items are missing, please contact your place of purchase.

## Standard accessories

 **The supplied accessories will be suitable for your region, and may differ from those illustrated.**

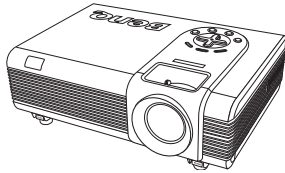

Projector



Soft carry case

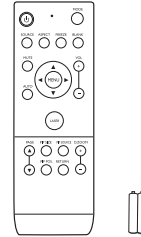

Remote control with batteries



User's manual



Quick start guide



User's manual CD

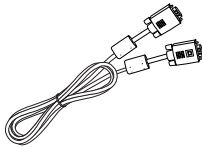

VGA cable

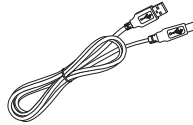

USB cable

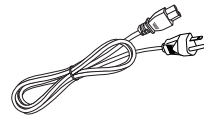

Power cord



PC audio cable



Video cable

## Optional accessories

1. Ceiling mounting kit
2. Spare lamp kit
3. Presentation Plus
4. Dust filter kit

# Projector exterior view

## Front/upper side

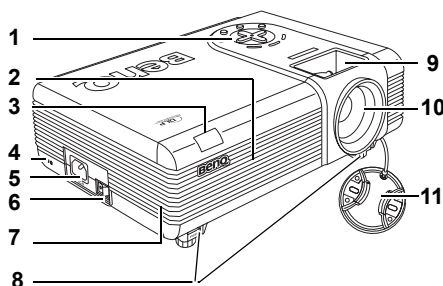

1. External control panel  
See "[Projector](#)" on page 13 for details.
2. Vent (cool air intake)
3. Front IR remote sensor
4. Kensington anti-theft lock slot
5. AC power cord inlet
6. Main power switch
7. Front filter grill
8. Quick-release buttons
9. Focus ring and Zoom ring
10. Projection lens
11. Lens cap

## Rear/side view

Refer to "[Connection](#)" on page 22 for more information on making connections to various equipment.

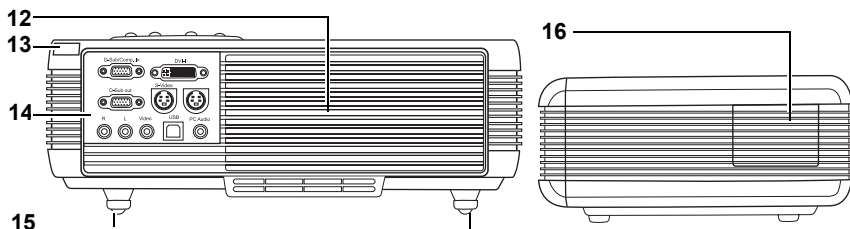

12. Vent (heated air exhaust)
13. Rear IR remote sensor
14. Connector panel
15. Rear adjuster feet
16. Side filter cover

See "[Connector panel](#)" on page 12 for details.

## Lower view

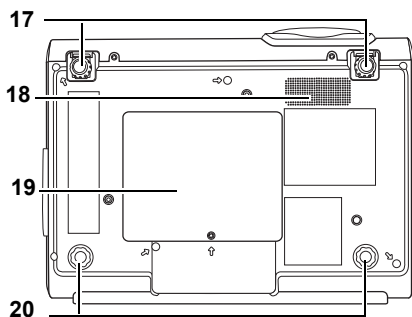

17. Front adjuster feet
18. Speaker grill
19. Lamp cover
20. Rear adjuster feet

# Connector panel

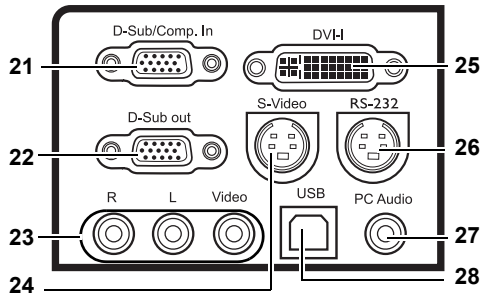

- 21. RGB (PC)/Component video (YPbPr/ YCbCr) signal input socket
- 22. RGB signal output socket
- 23. Audio (Left/ Right)/Video input sockets
- 24. S-Video input socket
- 25. DVI-I signal input socket supports DVI-D video signal and DVI-A PC signal
- 26. RS 232 control port For external control systems and used by service personnel.
- 27. PC Audio input socket
- 28. USB socket

# Controls and functions

## Projector

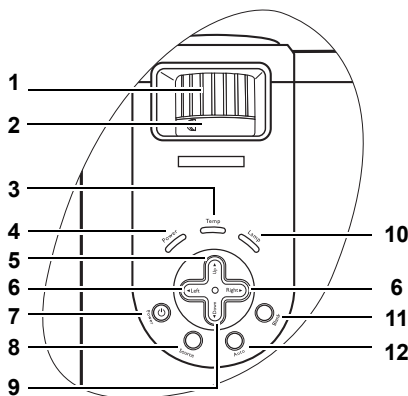

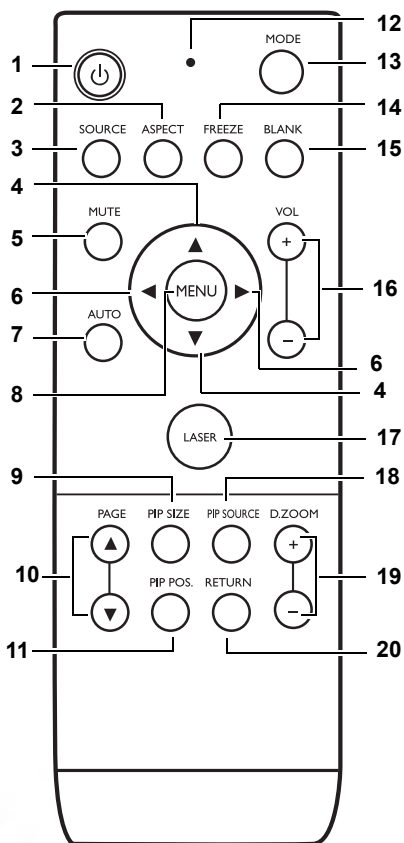

- 1. Focus ring**  
Adjusts the focus of the projected image. See ["Fine-tuning the image size and clarity" on page 32](#) for details.
- 2. Zoom ring**  
Adjusts the size of the image. See ["Fine-tuning the image size and clarity" on page 32](#) for details.
- 3. Temperature warning light**  
Lights up or flashes if the projector's temperature becomes too high. See ["Indicators" on page 53](#) for details.
- 4. Power indicator light**  
Lights up when the projector is in standby mode or under operation. See ["Indicators" on page 53](#) for details.
- 5. ▲ Exit**  
Exits and saves the menu settings.
- 6. ◀ Left/ ▶ Right**  
Correct keystone at the top or bottom of the projected image.  
When the on-screen menu is activated, moves the selection focus left or right, or make adjustments.  
See ["Correcting keystone" on page 34](#) and ["Using the menus" on page 42](#) for details.
- 7. ⏻ Power**  
Turns the projector on or off. See ["Start up" on page 30](#) and ["Shutting down the projector" on page 40](#) for details.
- 8. Source**  
Sequentially selects the input signal Analog RGB, DVI-A, DVI-D, Analog YPbPr, S-Video, or Composite Video. See ["Switching input signal" on page 31](#) for details.
- 9. ▼ Menu**  
Turns on the on-screen display control menu.  
When the on-screen menu is activated, moves the selection focus down.  
See ["Using the menus" on page 42](#) for details.
- 10. Lamp indicator light**  
Indicates the status of the lamp.  
Lights up or flashes when the lamp has developed a problem. See ["Indicators" on page 53](#) for details.
- 11. Blank**  
Used to hide the screen image. You can press **Blank** on the projector or remote control to bring the image back. See ["Hiding the image" on page 38](#) for details.
- 12. Auto**  
Automatically determines the best picture timings for the displayed image. See ["Auto-adjusting the image" on page 32](#) for details.

# Remote control



1. **Power**  
 Toggles the projector between standby mode and on.  
 When the projector is in standby mode, press once to turn the projector on.  
 When the projector is on, press twice to turn the projector to standby.  
 See ["Start up"](#) on page 30 and ["Shutting down the projector"](#) on page 40 for details.

2. **ASPECT**  
 Selects an image aspect ratio to suit the input signal. See ["Selecting a preset mode"](#) on page 35 for details.
3. **SOURCE**  
 Sequentially selects the input signal Analog RGB, DVI-A, DVI-D, Analog YPbPr, S-Video, or Composite Video. See ["Switching input signal"](#) on page 31 for details.
4. **▲ UP, ▼ DOWN**  
 When the On-Screen Display (OSD) is activated, press **▲ UP** to exit and save the menu settings.  
 Press **▼ DOWN** to open the OSD menu and move the selection focus up and down. See ["Using the menus"](#) on page 42 for details.
5. **MUTE**  
 Toggles the projector audio between on and off.
6. **◀ Left, ▶ Right**  
 Correct keystone at the top or bottom of the projected image.  
 When the on-screen menu is activated, moves the selection focus left or right, or make adjustments.  
 See ["Correcting keystone"](#) on page 34 and ["Using the menus"](#) on page 42 for details.
7. **AUTO**  
 Automatically determines the best picture settings for the displayed image. See ["Auto-adjusting the image"](#) on page 32 for details.
8. **MENU**  
 Turns the On-Screen Display (OSD) menu on. Exits and saves the menu settings. See ["Using the menus"](#) on page 42 for details.

9. **PIP SIZE**  
Selects a suitable PIP size. See "[PIP \(Picture In Picture\) operation](#)" on page 39 for details.
  10. **PAGE UP and DOWN**  
Operate your display software program (on a connected PC) which responds to page up/down commands (like Microsoft PowerPoint).  
See "[Remote paging operations](#)" on page 38 for details.
  11. **PIP POS.**  
Selects a suitable PIP position. See "[PIP \(Picture In Picture\) operation](#)" on page 39 for details.
  12. **LED indicator light**  
Lights red when any buttons on the remote control is pressed.
  13. **MODE**  
Depending upon which input signal is selected, there are several picture setup options available. See "[Selecting a preset mode](#)" on page 35 for details.
  14. **FREEZE**  
The image is frozen when **FREEZE** is pressed. An icon "  " will display in the lower right corner of the screen. To release the function, press **FREEZE** again. See "[Freezing the image](#)" on page 38 for details.
  15. **BLANK**  
Used to hide the screen image. Press **BLANK** on the projector or remote control to restore the image. See "[Hiding the image](#)" on page 38 for details.
  16. **VOLUME +/-**  
Increases or decreases the volume level.
  17. **LASER pointer**  
Emits visible laser pointer light for presentation purposes.  
The LASER Pointer is a presentation aid for professionals. It emits visible red colored light when you press it and the LED indicator lights up red.
-  **WARNING: Do not look into the laser light window or shine the laser light beam on yourself or others. See the warning messages on the back of the remote control and the attached "User Information" prior to using it.**
18. **PIP SOURCE**  
Selects a suitable PIP source.  
See "[PIP \(Picture In Picture\) operation](#)" on page 39 for details.
  19. **DIGITAL ZOOM +/-**  
Magnifies or reduces the projected image size.
  20. **RETURN**  
Restores a zoomed projected image to its original size.  
See "[Searching for details on the image](#)" on page 32 for details.

### Warning messages on the back of the remote control

The laser beam is visible. It is necessary to press and hold the LASER button for continuous output.

The laser pointer is not a toy. Parents should be mindful of the dangers of laser energy and keep this remote control out of the reach of children.

See the warning label on the back of your remote control for safe operation on the laser pointer.



## Remote control effective range

Infra-Red (IR) remote control sensors are located on the front and the back of the projector. The remote control must be held at an angle within 30 degrees perpendicular to the projector's IR remote control sensors to function correctly. The distance between the remote control and the sensors should not exceed 6 meters (~ 20 feet).

Make sure that there are no obstacles between the remote control and the IR sensors on the projector that might obstruct the infra-red beam.

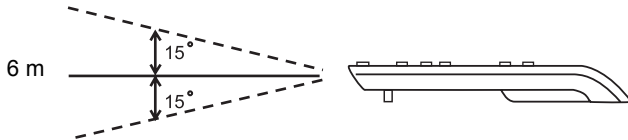

## Remote control batteries

1. To open the battery cover, turn the remote control over to view its back, push on the finger grip on the cover and slide it up in the direction of the arrow as illustrated. The cover will slide off.
2. Remove any existing batteries (if necessary) and install two AAA batteries observing the battery polarities as indicated in the base of the battery compartment. Positive (+) goes to positive and negative (-) goes to negative.
3. Refit the cover by aligning it with the base and sliding it back down into position. Stop when it clicks into place.

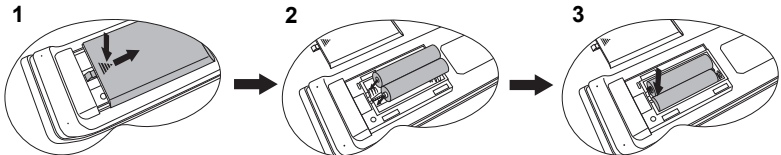

- ⚠ • **Avoid leaving the remote control and batteries in an excessive heat or humid environment like the kitchen, bathroom, sauna, sunroom or in a closed car.**
- **Replace only with the same or equivalent type recommended by the battery manufacturer.**
- **Dispose of the used batteries according to the manufacturer's instructions and local environment regulations for your region.**
- **Never throw the batteries into a fire. There may be danger of an explosion.**
- **If the batteries are dead or if you will not be using the remote control for an extended period of time, remove the batteries to avoid damage to the remote control from possible battery leakage.**



# 3 Positioning your projector

## Choosing a location

Your projector is designed to be installed in one of four possible installation locations:

1. Floor in front of screen;
2. Ceiling in front of screen;
3. Floor at rear of screen;
4. Ceiling at rear of screen.

### I. Floor front

Select this location with the projector placed near the floor in front of the screen. This is the most common way to position the projector for quick setup and portability.

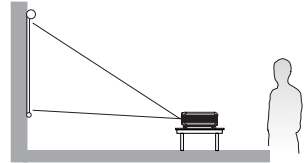

### II. Ceiling front

Select this location with the projector suspended upside-down from the ceiling in front of the screen.

Purchase the BenQ Projector Ceiling Mounting Kit from your dealer to mount your projector on the ceiling.

Set  in the **Source > Mirror** menu after you turn the projector on.

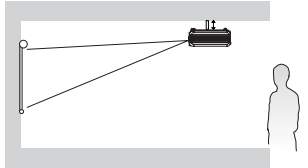

### III. Floor rear

Select this location with the projector placed near the floor behind the screen.

Note that a special rear projection screen is required.

Set  in the **Source > Mirror** menu after you turn the projector on.

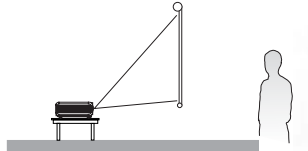

### IV. Ceiling rear

Select this location with the projector suspended upside-down from the ceiling behind the screen.

Note that a special rear projection screen and the BenQ Projector Ceiling Mounting Kit are required for this installation location.

Set  in the **Source > Mirror** menu after you turn the projector on.

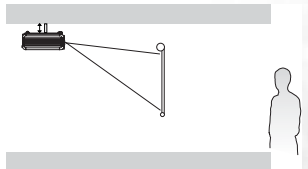

Your room layout or personal preference will dictate which installation location you select. Take into consideration the size and position of your screen, the location of a suitable power outlet, as well as the location and distance between the projector and the rest of your equipment.

# Safety instructions for ceiling mounting of the projector

We want you to have a pleasant experience using your BenQ projector, so we need to bring this safety matter to your attention to prevent damage to person and property.

If you intend to mount your projector on the ceiling, we strongly recommend that you use a proper fitting BenQ projector ceiling mount kit and that you ensure it is securely and safely installed.

If you use a non-BenQ brand projector ceiling mount kit, there is a safety risk that the projector may fall from the ceiling due to an improper attachment through the use of the wrong gauge or length screws.

You can purchase a BenQ projector ceiling mount kit from the place you purchased your BenQ projector. BenQ recommends that you also purchase a separate Kensington lock compatible security cable and attach it securely to both the Kensington lock slot on the projector and the base of the ceiling mount bracket. This will perform the secondary role of restraining the projector should its attachment to the mounting bracket become loose.

# Obtaining a preferred projected image size

The distance from the projector lens to the screen, the zoom setting, and the video format each factors in the projected image size.

The maximum (native) resolution of the projector is 1024 x 768 pixels, which is a 4 to 3 aspect ratio (expressed as 4:3). To be able to project a complete 16:9 (widescreen) aspect ratio image, the projector can resize and scale a widescreen image to the projector's native aspect width. This will result in a proportionally smaller height equivalent to 75% of the projector's native aspect height.

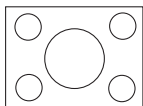

4:3 aspect image in a 4:3 aspect display area

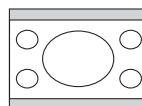

16:9 aspect image scaled to a 4:3 aspect display area

Thus, a 16:9 aspect image will not utilize 25% of the height of a 4:3 aspect image displayed by this projector. This will be seen as darkened (unlit) bars along the top and bottom (vertical 12.5% height respectively) of the 4:3 projection display area whenever displaying a scaled 16:9 aspect image in the vertical center of the 4:3 projection display area.

When determining the position of your projector, you should consider its intended use and input signal aspect ratios. All inputs (other than component Video being fed a 16:9 aspect signal) will display in a 4:3 aspect ratio (and will require an additional 33% display height than that of the scaled 16:9 aspect image projection area).

**IMPORTANT:** Do not select a permanent projector position based upon a 16:9 projection if you will ever need to select an input (other than composite Video being fed a 16:9 aspect signal). The projector should always be placed horizontally level (like flat on a table), and positioned directly perpendicular (90° right-angle square) to the horizontal center of the screen. This prevents image distortion caused by angled projections (or projecting onto angled surfaces).

The modern digital projector does not project directly forward (like older style reel-to-reel film projectors did). Instead, digital projectors are designed to project at a slightly upward angle above the horizontal plane of the projector. This is so that they can be readily placed on a table and will project forward and upwards onto a screen positioned so that the bottom edge of the screen is above the level of the table (and everyone in the room can see the screen).

If the projector is mounted on a ceiling, it must be mounted upside-down so that it projects at a slightly downward angle.

You can see from the diagram on page 21, that this type of projection causes the bottom edge of the projected image to be vertically offset from the horizontal plane of the projector. When ceiling mounted, this refers to the top edge of the projected image.

If the projector is positioned further away from the screen, the projected image size increases, and the vertical offset also increases proportionately.

When determining the position of the screen and projector, you will need to account for both the projected image size and the vertical offset dimension, which are directly proportional to the projection distance.

BenQ has provided a table of 4:3-aspect-ratio screen sizes to assist you in determining the ideal location for your projector. There are two dimensions to consider, the perpendicular horizontal distance from the center of the screen (projection distance), and the vertical offset height of the projector from the horizontal edge of the screen (offset).

## How to determine the position of the projector for a given screen size

1. Select your screen size.
2. Refer to the table and find the closest match to your screen size in the left columns labelled '4:3 Screen Diagonal'. Using this value, look across this row to the right to find the corresponding average distance from screen value in the column labelled 'Average'. This is the projection distance.
3. On that same row, look across to the right column and make note of the vertical Offset value. This will determine the final vertical offset placement of the projector in relation to the edge of the screen.
4. The recommended position for the projector is aligned perpendicular to the horizontal center of the screen, at the distance from the screen determined in step 2 above, and offset by the value determined in step 3 above.

For example, if you are using a 120 inch screen, the average projection distance is 4432 mm and with a vertical offset of 302 mm.

If you place the projector in a different position (to that recommended), you will have to tilt it down or up to center the image on the screen. In these situations, some image distortion will occur. Use the Keystone function to correct the distortion. See "[Correcting keystone](#)" on [page 34](#) for details.

## How to determine the recommended screen size for a given distance

This method can be used for situations where you have purchased this projector and would like to know what screen size will fit in your room.

The maximum screen size is limited by the physical space available in your room.

1. Measure the distance between the projector and where you want to position the screen. This is the projection distance.
2. Refer to the table and find the closest match to your measurement in the average distance from screen column labelled 'Average'. Check that your measured distance is between the min and max distances listed on either side of the average distance value.
3. Using this value, look across that row to the left to find the corresponding screen diagonal listed in that row. That is the projected image size of the projector at that projection distance.
4. On that same row, look across to the right column and make note of the vertical Offset value. This will determine the final placement of the screen in relation to the horizontal plane of the projector.

For example, if your measured projection distance was 4.8 m (4800 mm), the closest match in the Average column is 5089 mm. Looking across this row shows that a 3500 mm (3.5 m) screen is required. If you can only obtain imperial sized screens, the listed screen sizes on either side of the 3.5 m screen are the 10' and 12' screen.

Checking the min. and max. projection distance values for these screen sizes indicates that the 4.8 m measured projection distance will need to be reduced to fit the 10' size screen, or increased to fit the 12' size screen. The projector can be adjusted (using the zoom control) to display on these different screen sizes at those projection distances. Be aware that these different screens have different vertical offset values.

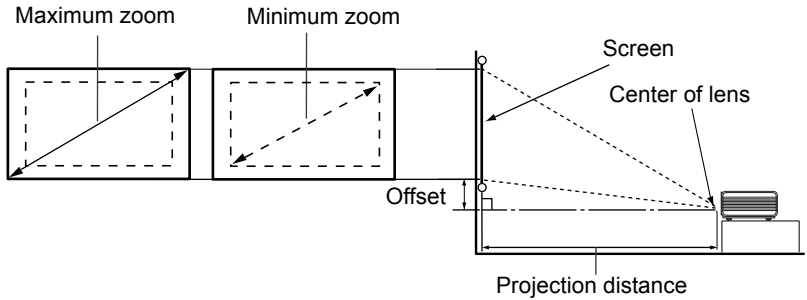

| 4:3 Screen Diagonal |        |      | Distance from Screen in mm         |         |                                    | Vertical Offset in mm |
|---------------------|--------|------|------------------------------------|---------|------------------------------------|-----------------------|
| Feet                | Inches | mm   | Min. length<br>(with max.<br>zoom) | Average | Max. length<br>(with min.<br>zoom) |                       |
| 4                   | 48     | 1219 | 1652                               | 1773    | 1893                               | 121                   |
|                     |        | 1500 | 2033                               | 2181    | 2329                               | 149                   |
| 5                   | 60     | 1524 | 2065                               | 2216    | 2367                               | 151                   |
|                     |        | 1829 | 2479                               | 2659    | 2840                               | 181                   |
| 7                   | 84     | 2134 | 2892                               | 3102    | 3313                               | 211                   |
|                     |        | 2438 | 3305                               | 3546    | 3787                               | 241                   |
| 8                   | 96     | 2500 | 3389                               | 3635    | 3882                               | 248                   |
|                     |        | 2743 | 3718                               | 3989    | 4260                               | 272                   |
| 9                   | 108    | 3000 | 4066                               | 4362    | 4659                               | 297                   |
|                     |        | 3048 | 4131                               | 4432    | 4733                               | 302                   |
| 10                  | 120    | 3500 | 4743                               | 5089    | 5435                               | 347                   |
|                     |        | 3658 | 4957                               | 5318    | 5680                               | 362                   |
| 12                  | 144    | 4000 | 5421                               | 5816    | 6212                               | 396                   |
|                     |        | 4572 | 6196                               | 6648    | 7100                               | 453                   |
| 15                  | 180    | 5000 | 6776                               | 7270    | 7765                               | 495                   |
|                     |        | 5486 | 7436                               | 7978    | 8520                               | 543                   |
| 18                  | 216    | 6000 | 8132                               | 8725    | 9317                               | 594                   |
|                     |        | 7620 | 10327                              | 11080   | 11833                              | 754                   |

☞ There is 3% tolerance among these numbers due to optical component variations. BenQ recommends that if you intend to permanently install the projector, you should physically test the projection size and distance using the actual projector in situ before you permanently install it, so as to make allowance for this projector's optical characteristics. This will help you determine the exact mounting position so that it best suits your installation location.

# 4 Connection

When connecting a signal source to the projector, be sure to:

1. Turn all equipment off before making any connections.
2. Use the correct signal cables for each source.
3. Ensure the cables are firmly inserted.

 In the connections shown below, some cables may not be included with the projector (see ["Shipping contents" on page 10](#)). They are commercially available from electronics stores.

## Connecting a computer or monitor

### Connecting a computer

The projector provides VGA and DVI input sockets that allow you to connect it to a notebook or desktop computer.

Additionally, you can also connect the projector to a computer via the USB cable so you can perform paging operations of the application on the PC or notebook. (see ["Remote paging operations" on page 38](#)).

**To connect the projector to a notebook or desktop computer (either through a VGA cable or VGA to DVI-A cable):**

| • With a VGA cable  | • With a VGA to DVI-A cable  |
|---|--|
| <ol style="list-style-type: none"><li>1. Take the supplied VGA cable and connect one end to the D-Sub output socket of the computer.</li><li>2. Connect the other end of the VGA cable to the D-Sub/Comp. In signal input socket on the projector.</li></ol>  | <ol style="list-style-type: none"><li>1. Take a VGA to DVI-A cable and connect the VGA end to the D-Sub output socket of the computer.</li><li>2. Connect the DVI end of the VGA to DVI-A cable to the DVI-I signal input socket on the projector.</li></ol> |
| <ol style="list-style-type: none"><li>3. If you wish to use the remote paging function (see <a href="#">"Remote paging operations" on page 38</a>), take the supplied USB cable and connect the larger end to the USB port of the computer, and the smaller end to the USB socket on the projector.</li><li>4. If you wish to make use of the projector speakers in your presentations, take a suitable audio cable and connect one end of the cable to the audio output socket of the computer, and the other end to the PC Audio socket of the projector.<br/>Once connected, the audio can be controlled by the remote control (Volume +/-) or projector On-Screen Display (OSD) menus. See <a href="#">"Volume"</a>, <a href="#">"Treble"</a>, <a href="#">"Bass"</a>, and <a href="#">"Mute" on page 45</a> for details.</li></ol> |  |

The final connection path should be like that shown in the following diagram:

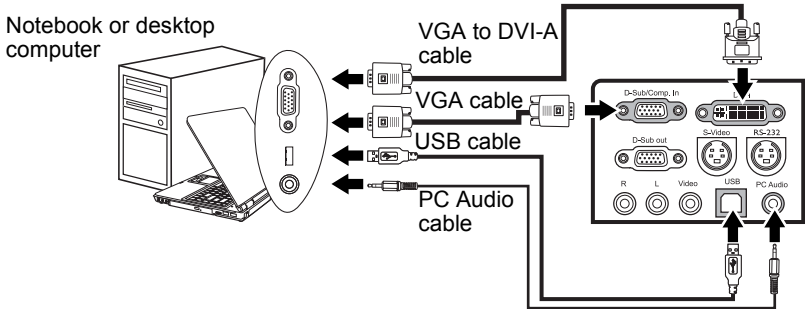

- **A Mac adapter (an optional accessory) is needed if you are connecting legacy version Macintosh computers.**
- **Many notebooks do not turn on their external video ports when connected to a projector. Usually a key combo like FN + F3 or CRT/LCD key turns the external display on/off. Locate a function key labeled CRT/LCD or a function key with a monitor symbol on the notebook. Press FN and the labeled function key simultaneously. Refer to your notebook's documentation to find your notebook's key combination.**

# Connecting a monitor

If you want to view your presentation close-up on a monitor as well as on the screen, you can connect the RGB signal output socket on the projector to an external monitor with a VGA or VGA to DVI-A cable following the instructions below:

**To connect the projector to a monitor (either through a VGA cable or VGA to DVI-A cable):**

|  |  |
|--|--|
| <ul style="list-style-type: none"> <li>With a VGA cable:</li> </ul>  | <ul style="list-style-type: none"> <li>With a VGA to DVI-A cable:</li> </ul> <p><b>Note: Your monitor must be equipped with a DVI input socket.</b></p>  |
| <ol style="list-style-type: none"> <li>1. Connect the projector to a computer as described in <a href="#">"Connecting a computer" on page 22.</a></li> </ol>   |  |
| <ol style="list-style-type: none"> <li>2. Take a suitable VGA cable (only one supplied) and connect one end of the cable to the D-Sub input socket of the video monitor.</li> <li>3. Connect the other end of the cable to the D-Sub Out socket on the projector.</li> </ol> | <ol style="list-style-type: none"> <li>2. Take a VGA to DVI-A cable and connect the DVI end of the cable to the DVI input socket of the video monitor.</li> <li>3. Connect the VGA end of the cable to the D-Sub Out socket on the projector.</li> </ol> |

The final connection path should be like that shown in the following diagram:

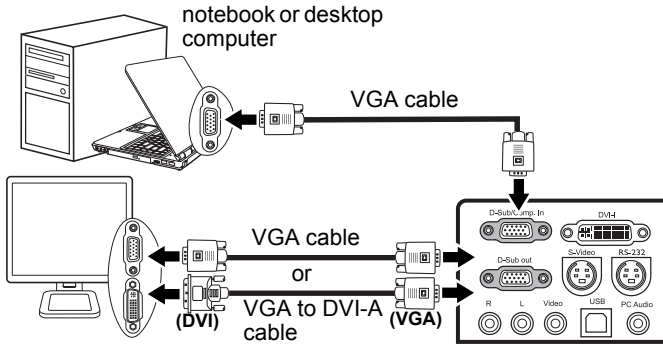

The D-Sub output only works when an appropriate D-Sub input is made to the projector. Be sure the projector is connecting with the computer using the D-Sub/Comp. In socket, not the DVI socket.



# Connecting Video source devices

You can connect your projector to various Video source devices that provide any one of the following output sockets:

- DVI
- Component Video
- S-Video
- Video (composite)

You need only connect the projector to a Video source device using just one of the above connecting methods, however each provides a different level of video quality. The method you choose will most likely depend upon the availability of matching terminals on both the projector and the Video source device as described below:

## Best video quality

The best available video connection method is DVI, if your source device is equipped with a DVI socket. Based on the type of DVI connector you have, you can enjoy a digital or high-end analog video quality.

See ["Connecting a DVI source device" on page 26](#) for how to connect the projector to a DVI source device and other details.

If no DVI source is available, the next best video signal is available by connecting your device to the projector with a Component Video (not to be confused with composite Video) cable. Digital TV tuner and DVD players output Component Video natively, so if available on your devices, they should be your connection method of choice in preference to S-Video or (composite) Video.

See ["Connecting a Component Video source device" on page 27](#) for how to connect the projector to a component video device.

## Better video quality

The S-Video method provides a better quality analog video than standard composite Video. If you have both composite Video and S-Video output terminals on your Video source device, you should elect to use the S-Video option.

See ["Connecting an S-Video source device" on page 28](#) for how to connect the projector to an S-Video device.

## Least video quality

Composite Video is an analog video and will result in a perfectly acceptable, but less than optimal result from your projector, being the least video quality of the available methods described here.

See ["Connecting a composite Video source device" on page 29](#) for how to connect the projector to a composite Video device.

## Connecting Audio

The projector has two built-in speakers which are designed to provide audio functionality accompanying data presentations for business purposes. It is not designed for, nor intended for audio reproduction use as might be expected in home theatre or home cinema applications.

If you have a separate sound system, you will most likely want to connect the audio output of your Video source device to that sound system, instead of to the projector.

The audio connections illustrated in the following sections are provided for informational purposes only. You need not connect audio to the projector if there is an alternate sound system available, or if audio is not required.

## Connecting a DVI source device

The projector provides a DVI-I input socket that allows you to connect it to a DVI source device like DVD player, or a VGA output device like notebook or desktop computer.

There are three types of DVI connector: DVI-A, DVI-D, and DVI-I. The DVI-I socket is an integrated connector which supports both formats: DVI-A, and DVI-D.

DVI-A format is used to carry a DVI signal to an analog (VGA) display, or vice-versa. Although some signal quality is lost from the signal conversion, it still transmits higher picture quality than standard VGA connection.

DVI-D format is used to directly carry a digital signal to a digital display without signal conversion. The pure digital connection provides faster and higher image quality than analog connection, due to the nature of the digital format.

DVI-A and DVI-D formats are non-interchangeable. You cannot connect a DVI-A format connector to a DVI-D equipment. Make sure what kind of format you need before you purchase the cable. Or you can purchase a DVI-I cable which will be more useful in any type of DVI connection situations.

Examine your source device to determine if it has an unused DVI or VGA (D-Sub) output socket available:

If so, you can continue with this procedure.

If not, you will need to reassess which method you can use to connect to the device.

### To connect the projector to a DVI source device through a DVI cable:

☞ For information on connecting a DVI source device to a computer through a VGA to DVI-A cable, see ["Connecting a computer" on page 22](#).

1. Take the DVI (DVI-D or DVI-I) cable and connect one end to the DVI output socket of the DVI source device.
2. Connect the other end of the cable to the DVI-I signal input socket on the projector.
3. If you wish to make use the projector speakers, take a suitable audio cable and connect one end of the cable to the audio output sockets of the video device, and the other end to the PC Audio socket or Audio L/R sockets on the projector.

Once connected, the audio can be controlled by the remote control (Volume +/-) or projector On-Screen Display (OSD) menus. See ["Volume"](#), ["Treble"](#), ["Bass"](#), and ["Mute" on page 45](#) for details.

The final connection path should be like that shown in the following diagram:

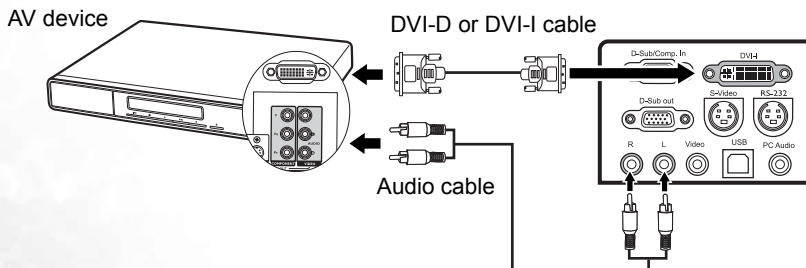

# Connecting a Component Video source device

Examine your Video source device to determine if it has a set of unused Component Video output sockets available:

- If so, you can continue with this procedure.
- If not, you will need to reassess which method you can use to connect to the device.

To connect the projector to a Component Video source device:

1. Take the (optional accessory) Component Video to VGA (D-Sub) adaptor cable and connect the end with 3 RCA type connectors to the Component Video output sockets of the Video source device. Match the color of the plugs to the color of the sockets; green to green, blue to blue, and red to red.
2. Connect the other end of the Component Video to VGA (D-Sub) adaptor cable (with a D-Sub type connector) to the D-Sub/Comp. In socket on the projector.
3. If you wish to make use of the projector speakers, take a suitable audio cable and connect one end of the cable to the audio output sockets of the video device, and the other end to the Audio L/R sockets on the projector.

Once connected, the audio can be controlled by the remote control (Volume +/-) or projector On-Screen Display (OSD) menus. See "[Volume](#)", "[Treble](#)", "[Bass](#)", and "[Mute](#)" on page 45 for details.

The final connection path should be like that shown in the following diagram:

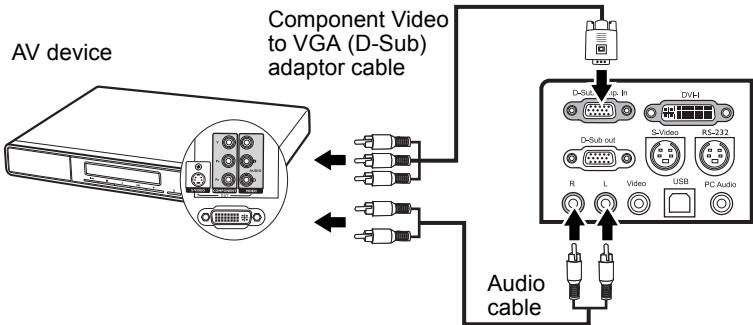

If you connect the projector to a High Definition TV (HDTV) tuner, the following standards are supported:

- |                    |                     |
|--------------------|---------------------|
| • 480i             | • 480p              |
| • 576i             | • 576p              |
| • 720p (50/ 60 Hz) | • 1080i (50/ 60 Hz) |

- **Component Video is the only video output that delivers native 16:9 aspect ratio picture.**
- **If the selected video image is not displayed after the projector is turned on and the correct video source has been selected, check that the Video source device is turned on and operating correctly. Also check that the signal cables have been connected correctly.**

## Connecting an S-Video source device

Examine your Video source device to determine if it has an unused S-Video output socket available:

- If so, you can continue with this procedure.
- If not, you will need to reassess which method you can use to connect to the device.

To connect the projector to an S-Video source device:

1. Take the (optional accessory) S-Video cable and connect one end to the S-Video output socket of the Video source device.
2. Connect the other end of the S-Video cable to the S-Video socket on the projector.
3. If you wish to make use of the projector speakers, take a suitable audio cable and connect one end of the cable to the audio output sockets of the video device, and the other end to the Audio L/R sockets on the projector.

Once connected, the audio can be controlled by the remote control (Volume +/-) or projector On-Screen Display (OSD) menus. See "[Volume](#)", "[Treble](#)", "[Bass](#)", and "[Mute](#)" on [page 45](#) for details.

The final connection path should be like that shown in the following diagram:

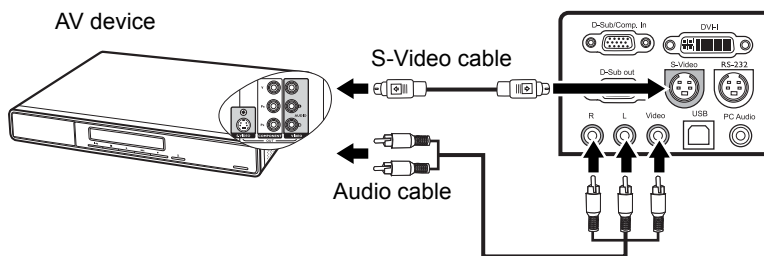

- **If the selected video image is not displayed after the projector is turned on and the correct video source has been selected, check that the Video source device is turned on and operating correctly. Also check that the signal cables have been connected correctly.**
- **If you have already made a Component Video connection between the projector and this S-Video source device using Component Video connections, you need not connect to this device using an S-Video connection as this makes an unnecessary second connection of poorer picture quality. See "[Connecting Video source devices](#)" on [page 25](#) for details.**

# Connecting a composite Video source device

Examine your Video source device to determine if it has a set of unused composite Video output sockets available:

- If so, you can continue with this procedure.
  - If not, you will need to reassess which method you can use to connect to the device.
- To connect the projector to an composite Video source device:

If you wish to make use of the projector speakers,

1. Take an Audio/Video cable and connect the 3 RCA type connectors to the Audio(R/L)/Video output sockets of the Video source device. Match the color of the plugs to the color of the sockets; green to green, blue to blue, and red to red.
2. Connect the other end of the Audio/Video cable to the Audio(R/L)/Video sockets on the projector.

Once connected, the audio can be controlled by the remote control (Volume +/-) or projector On-Screen Display (OSD) menus. See "[Volume](#)", "[Treble](#)", "[Bass](#)", and "[Mute](#)" on page 45 for details.

If you need only to use the video function of the projector,

1. Take the Video cable and connect one end to the Video output socket of the Video source device.
2. Connect the other end of the Video cable to the Video socket on the projector.

The final connection path should be like that shown in the following diagram:

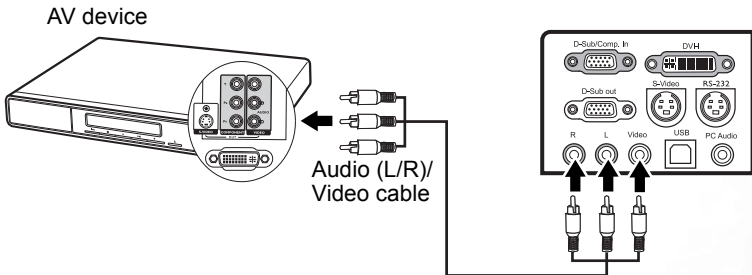

- **If the selected video image is not displayed after the projector is turned on and the correct video source has been selected, check that the Video source device is turned on and operating correctly. Also check that the signal cables have been connected correctly.**
- **You need only connect to this device using a composite Video connection if Component Video and S-Video inputs are unavailable for use. See "[Connecting Video source devices](#)" on page 25 for details.**

# 5 Operation

## Start up

1. Plug the power cord into the projector and into a wall socket. Turn on the wall socket switch (where fitted).

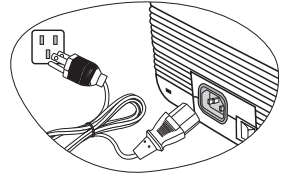

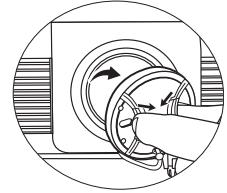

2. Remove the lens cap. If it is left on, it could become deformed due to the heat produced by the projection lamp.

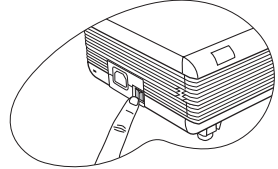

3. Turn the main power switch on. The **Power indicator** lights orange.



4. Press and hold (for 2 seconds)  **Power** on the remote control or projector to start the projector. The **Power indicator light** flashes green and stays green when the projector is on. The start up procedure takes about 30 seconds after pressing  **Power**. In the later stage of start up, a default BenQ logo is projected.

5. Switch all of the connected equipment on.
6. The projector will start to search for input signals. The current input source being scanned displays in the lower right corner of the screen. The search will continue until an input source signal is detected.

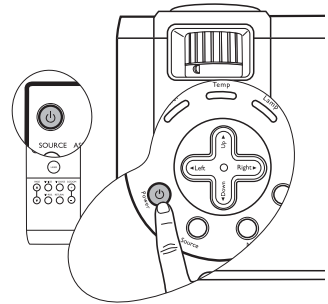

You can also press **SOURCE** on the projector or remote control to select your desired input signal. For more information, refer to "[Switching input signal](#)" on page 31.

 **If the frequency/ resolution of the input signal exceeds the projector's operating range, you will see the message "Out of Range" displayed on a blank screen. Please change to an input signal which is compatible with the projector's resolution. See "[Timing chart](#)" on page 58 for details.**

## Switching input signal

The projector can be connected to multiple devices at the same time. However, it can only display one full screen at a time. To cycle through the available input sources, press **SOURCE** on the projector or remote control. The selected source name will display in the lower right corner of the screen for 3 seconds after each button press.

The projector features PIP function which allows 2 different signals to be displayed at the same time. See "[PIP \(Picture In Picture\) operation](#)" on page 39 for details.

The brightness level of the projected image will change accordingly when you switch between different input signals. Data (graphic) "PC" presentations using mostly static images are generally brighter than "Video" using mostly moving images (movies). When switching between different signal inputs, you will need to adjust the ambient lighting conditions for the best picture quality.

The input type affects the options available for the Preset Mode. See "[Selecting a preset mode](#)" on page 35 for details.

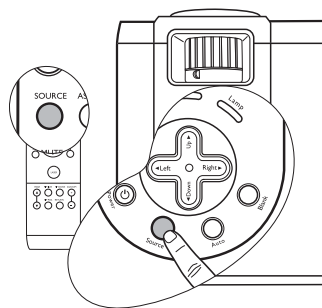

## Adjusting the projected image

### Adjusting the projection angle

The projector is equipped with 2 quick-release adjuster feet and 2 rear adjuster feet. These adjusters change the image height and projection angle. To adjust the projector:

1. Press the quick-release buttons and lift the front of the projector. Once the image is positioned where you want it, release the quick-release buttons to lock the front adjuster feet in position.

 **Do not look into the lens while the lamp is on. The strong light from the lamp may cause damage to your eyes.**

**Be careful when you press the adjuster buttons as they are close to the exhaust vent where hot air comes from.**

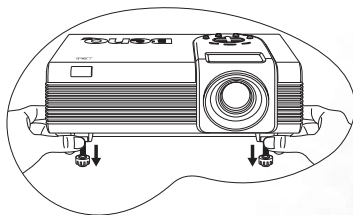

2. Screw the rear adjuster feet to fine tune the horizontal angle.

To retract the foot, hold up the projector while pressing the quick-release buttons, then slowly lower the projector. Screw the rear adjuster feet in a reverse direction.

If the screen and the projector are not perpendicular to each other, the projected image becomes vertically trapezoidal. To correct this situation, adjust the value of Keystone in the Display menu, on the projector control panel, or on the remote control. See "[Correcting keystone](#)" on page 34 for details.

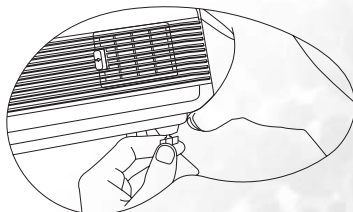

## Auto-adjusting the image

In some cases, you may need to optimize the picture quality. To do this, press **AUTO** on the projector or remote control. Within 3 seconds, the built-in Intelligent Auto Adjustment function will re-adjust the values of Frequency, and Clock to provide the best picture quality.

The current source information will be displayed at the bottom right of the screen for 3 seconds.

 **The screen will be blank while AUTO is functioning.**

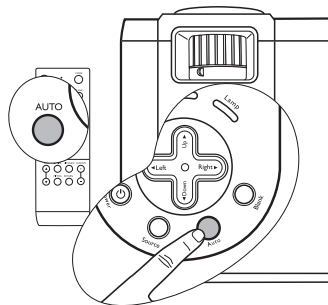

## Fine-tuning the image size and clarity

1. Adjust the projected image to the size that you need using the zoom ring.
2. Then sharpen the image by rotating the focus ring.

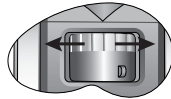
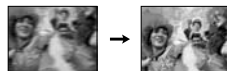
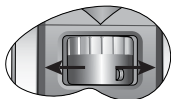

## Searching for details on the image

If you need to find the details on the projected image, press **D. ZOOM +** on the remote control, the center of the image will be magnified. When the **+** button is pressed again, the image is further magnified. Use the directional arrows (**▲**, **▼**, **◀**, **▶**) on the projector or remote control to navigate the image. Pressing **D. ZOOM -** reduces the size of the image. When the **-** button is pressed again, the image is further reduced until it is restored to the original size. You can also restore the original size by pressing **RETURN** on the remote control.

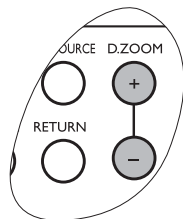

## Any problems?

If you have other display problems, see ["Troubleshooting" on page 55](#) for details.





# Selecting the aspect ratio

The "aspect ratio" is the ratio of the image width to the image height. Most analog TV and computers are in 4:3 ratio, which is the default for this projector, and digital TV is usually in 16:9 ratio.

You can change the projected image ratio (no matter what aspect the source is) by pressing **ASPECT** on the remote control. Select an aspect ratio to suit the format of the signal and your display requirements.

When the selected input source is YPbPr, YCbCr, DVI-D, S-Video, or Video, there are two aspect ratios available. You can press **ASPECT** once to show the current setting and press

again to change the current setting. Or you can go to  **Image > Auto Resize** and press **◀ Left/▶ Right** on the projector or remote control to switch between the two options.

 **In the pictures below, the grey portions are inactive areas and the white portions are active areas.**

1. **4:3:** Scales an image so that it is displayed in the center of the screen with a 4:3 aspect ratio. This is most suitable for 4:3 images like computer monitors, standard definition TV, and 4:3 aspect DVD movies, as it displays them without aspect alteration.
2. **16:9 (default):** Scales an image so that it is displayed in the center of the screen with a 16:9 aspect ratio. This is most suitable for images which are already in a 16:9 aspect, like high definition TV, as it displays them without aspect alteration.

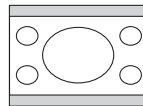
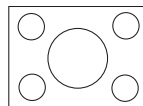

 **16:9 aspect ratio is only sourced through the Component Video input when being fed an appropriate 16:9 aspect signal. See ["Connecting a Component Video source device"](#) on page 27 and ["Obtaining a preferred projected image size"](#) on page 19 for details.**

When the selected input source is Analog RGB, DVI-A, or DVI-D, pressing **ASPECT** sets the auto-resize function on or off, or sets the image to 16:9 ratio.

You can press **ASPECT** once to show the current setting and press repeatedly to change the current setting. Or you can go to  **Image > Auto Resize** and press **◀ Left/▶ Right** on the projector or remote control to switch between the three options.

1. **On:** This is the default for the projector. The pixel resolution of the input signal is converted to the native resolution of the projector (1024 x 768). For input signals with lower resolutions, gaps in the pixels are automatically interpolated into the image before being projected. This may distort the image clarity. If the resolution of the source image is the same as the projector's (1024 x 768), setting On has no effects.
2. **Off:** The image is projected as its original resolution, with no pixel conversion. For input signals with lower resolutions, the projected image will display smaller than if resized to full screen. You could adjust the zoom setting or move the projector towards the screen to increase the image size if necessary. You may also need to refocus the projector after making these adjustments.
3. **16:9:** Scales an image so that it is displayed in the center of the screen with a 16:9 aspect ratio.

# Optimizing the image

To optimize the image, use the buttons on the projector or remote control to adjust the image settings directly, or to change the settings on the On-Screen Display (OSD) menus. For the operation of OSD menus, refer to "Using the menus" on page 42.

The following instructions are optional. You do not need to follow every step. It depends on the image quality you desire.

## Correcting keystone

Keystoning refers to the situation where the projected image is noticeably wider at either the top or bottom. It occurs when the projector is not perpendicular to the screen.







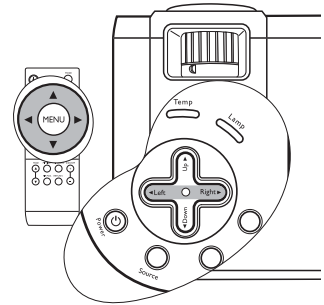

To correct this, besides adjusting the projection angle of the projector, you will need to manually correct it following ONE of these steps.

- Press **◀ Left/▶ Right** on the projector or remote control to display the status bar labelled Keystone. Press **▶ Right** to correct keystone at the top of the image. Press **◀ Left** to correct keystone at the bottom of the image.
- Press **MENU** on the projector or remote control.

Go to  **Display > Keystone** and adjust the values by pressing **◀ Left/▶ Right** on the projector or remote control.



For example,

|  |  |   |
|--|--|---|
|               | <ol style="list-style-type: none"><li>1. Press <b>▶ Right</b> on the projector or remote control or</li><li>2. Press <b>▶ Right</b> on the projector or remote control when you are in the Display &gt; Keystone menu.</li></ol> |                |
| Keystone  0  | →  | Keystone  -6  |
|             | <ol style="list-style-type: none"><li>1. Press <b>◀ Left</b> on the projector or remote control or</li><li>2. Press <b>◀ Left</b> on the projector or remote control when you are in the Display &gt; Keystone menu.</li></ol>   |              |
| Keystone  0 | →  | Keystone  +6 |

## Selecting a preset mode

The projector is preset with several predefined application modes so that you can choose one to suit your operating environment and input source picture type. To select a operation mode that suits your need, press **MODE** on the remote control. The picture modes available for different types of signals are shown below.

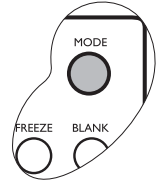

### PC/DVI-A Signal Input

- **Presentation Mode (Default):** Is designed for presentations. The brightness is emphasized in this mode to match PC and notebook coloring.
- **Vivid Mode:** Is perfect for playing games. The color saturation and brightness are well-balanced.
- **Video Mode:** Is suitable for cinematic enjoyment displaying images in their natural color.
- **Economic Mode:** Use this mode to reduce the system noise and reduce the power consumption by 20%. The lamp life is also extended with lower light output.

### YPbPr/YCbCr/DVI-D/S-Video/Video Signal Input

- **Gaming Mode:** Is suitable for playing gamebox-based video games in a normal living room lighting level environment.
- **Video Mode:** With a higher color temperature, it is suitable for enjoying TV movies.
- **Cinema Mode:** Is suitable for enjoying DVD movies best viewed in a blackened (little light) home cinema or lounge room environment.
- **Economic Mode:** Use this mode to reduce the system noise and reduce the power consumption by 20%. The lamp life is also extended with lower light output.

## Other adjustments

If you are not satisfied with the picture quality made by the preset modes, you can manually adjust some of the settings through the On-Screen Display (OSD) menus.

### Adjusting brightness

Press **MENU** on the projector or remote control. Go to  **Display > Brightness** and adjust the values by pressing **◀ Left/ ▶ Right** on the projector or remote control.

The higher the value, the brighter the image. And lower the setting, darker the image. Adjust this control so the black areas of the image appear just as black and that detail in the dark areas is visible.



### Adjusting contrast

Press **MENU** on the projector or remote control. Go to  **Display > Contrast** and adjust the values by pressing **◀ Left/ ▶ Right** on the projector or remote control.

The higher the value, the greater the contrast. Use this to set the peak white level after you have previously adjusted the Brightness setting to suit your selected input and viewing environment.



### Selecting a color temperature

Press **MENU** on the projector or remote control. Go to  **Image > Color Temp** and adjust the values by pressing **◀ Left/ ▶ Right** on the projector or remote control.

The higher the value, the more bluish white the image becomes. The lower the value, the more reddish white the image becomes.

#### About color temperatures:

There are many different shades that are considered to be “white” for various purposes. One of the common methods of representing white color is known as the “color temperature”. A white color with a low color temperature appears to be reddish white. A white color with a high color temperature appears to have more blue in it.

## Operating in a high altitude environment

We recommend you use the High Altitude Mode when your environment is higher than 3000 feet above sea level, or is hotter than 40°C, or whenever the projector will be used for extended periods of time (>10 hours) without shutdown.

To activate the High Altitude Mode, go to  **Control > High Altitude Mode**, select **On** by pressing **◀ Left/▶ Right** on the projector or remote control. A confirmation message displays. Press **AUTO**.

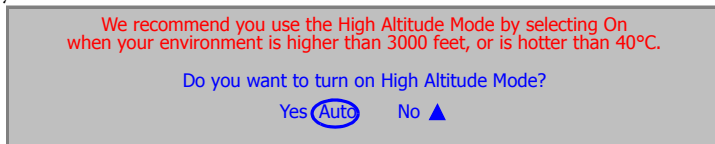

Next time you turn on the projector, it will show a message pictured below as a reminder during the start-up.

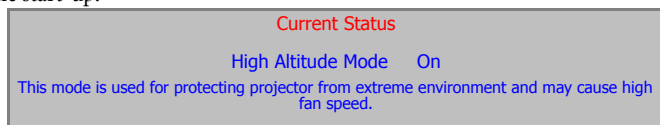

Operation under "High Altitude Mode" may cause a higher decibel operating noise level because of increased fan speed necessary to improve overall system cooling and performance.

If you use this projector under other extreme conditions excluding the above, it may display auto shut-down symptoms, which is designed to protect your projector from over-heating. In cases like this, you should switch to High Altitude mode to solve these symptoms. However, this is not to state that this projector can operate under any and all harsh or extreme conditions.

## Personalizing the projector menu display

The On-Screen Display (OSD) menus can be set according to your preferences. The following settings do not affect the projection settings, operation, or performance.

- OSD Time in the **Control > OSD** menu sets the length of time the OSD will remain active after your last button press. The time length ranges from 5 to 60 seconds in 5-second increments.
- Language in the **Control** menu sets your familiar language for the OSD menus. Use **◀ Left/▶ Right** on the projector or remote control to select your language.
- User Logo in the **Control > Setup** menu allows you to set a preferred logo screen to be displayed during projector start-up.

## Hiding the image

In order to draw the audience's full attention to the presenter or other media, you can use **BLANK** to hide the projected image when needed. The word 'BLANK' appears at the bottom right corner of the screen while the image is hidden. When this function is activated with a valid audio input connected, the audio can still be heard. Pressing any key on the projector or remote control restores the image.

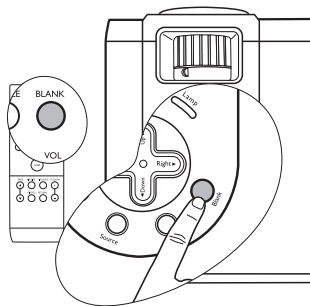

You can set the blank time in the  **Control >**

**Setup > Blank Time** menu allowing the projector to shut down automatically after a period of time when there is no action taken on the blank screen.

 **Do not block the projection lens from projecting as this could cause the blocking object to become heated and deformed or even cause a fire.**

## Remote paging operations

Connect the projector to your PC or notebook with a USB cable prior to using this function. See "[Connecting a computer](#)" on page 22 for details.

You can operate your display software program (on a connected PC) which responds to page up/down commands (like Microsoft PowerPoint) by pressing **PAGE** ▲ or ▼ on the remote control.

If remote paging function doesn't work, check if the USB connection is correctly made and the mouse driver on your computer is updated to the latest version.

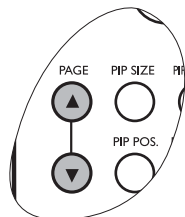

## Freezing the image

The projected image is frozen when **FREEZE** on the remote control is pressed. An icon  will display in the lower right corner of the screen. To release the function, press **FREEZE** again, **RETURN** on the remote control, or **SOURCE** on the projector or remote control. Note that pressing the **SOURCE** button will also change the input source.

Even if an image is frozen on the screen, the pictures are running on the video or other device. If the connected devices have active audio output, you will still hear the audio even though the image is frozen onscreen.

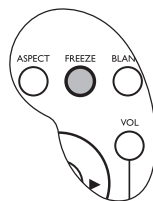

## Using the laser pointer in the presentation

The **LASER Pointer** is a presentation aid for professionals. It emits visible red colored light when you press it and the LED indicator lights up green.

 **WARNING: Do not look into the laser light window or shine the laser light beam on yourself or others. See the warning messages on the back of the remote control and the attached "User Information" prior to using it.**

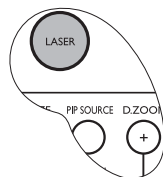

# PIP (Picture In Picture) operation

Your projector is capable of displaying images simultaneously from two input sources, which can be used to enhance your presentation in an interesting way.

These functions are available only when the input source is PC and the PIP source is Video or S-Video.

## Operation on the remote control

1. Ensure both the PC, and Video or S-Video signals are correctly connected to the projector.
2. Display the PC image on the screen.
3. Press **PIP-SOURCE** on the remote control to display the PIP frame. Press **PIP-SOURCE** a second time and wait for the PIP image to display.
4. To change the position of the PIP image, press **PIP-POS.** repeatedly until a suitable position is selected.

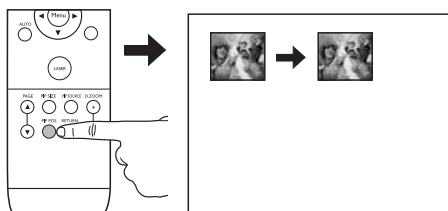

5. To resize the PIP image, press **PIP-SIZE** repeatedly. There are four options available, small, medium, large sizes, and off.

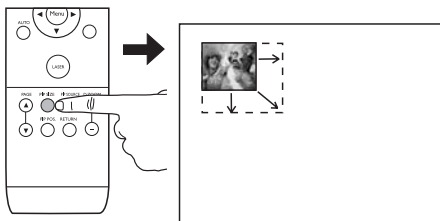

More functions are available in the On-Screen Display (OSD) menus.

## Operation in the OSD menus

1. To turn on the OSD menu, press **▼ Menu** on the projector or **MENU** on the remote control.
2. Use **◀ Left/▶ Right** on the projector or remote control to select the  **PIP** menu.
3. Use **▼ Menu** on the projector or **▼ Down** on the remote control to highlight the PIP adjustment functions. See page "PIP menu" on page 47 for details.

# Shutting down the projector

1. Press **Power** and a confirmation message will display prompting you as pictured to the right.  
If you don't respond in a few seconds, the message will disappear.
2. Press **Power** a second time to turn the projector off. The **Power indicator light** flashes orange, the projection lamp shuts down, and the fans will continue to run for approximately 90 seconds to cool down the projector.

 **To protect the lamp, the projector will not respond to any commands during the cooling process.**

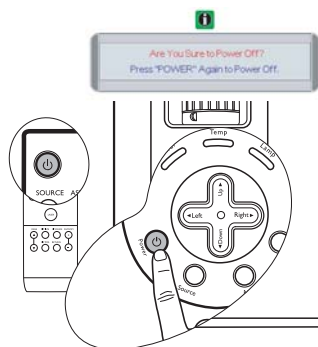

3. Turn the main power switch off.

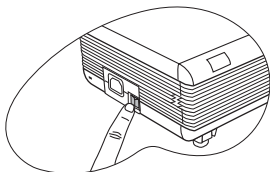

4. Disconnect the power cord from the wall socket and the projector.

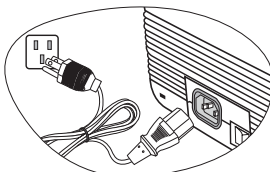





 **Do not unplug the power cord before the projector shutdown sequence is complete or during the 90-second cooling down process.**

**If the projector is not properly shut down, to protect the lamp, when you attempt to re-start the projector within hours, the fans will run for a few minutes to cool down. Press Power again to start the projector after the fans stop.**



# On-Screen Display (OSD) menu operation

## OSD menu system

| Functions available when receiving different signal types...   |   |  |  |  |
|--|---|--|--|--|
| Main Menu  | Analog RGB / DVI-A  | DVI-D  | YPbPr (480p/ 576p/ 720p/ 1080i)                                    | YCbCr (480i/ 576i) / S-Video / Video                             |
| <br><b>Display</b>  | Keystone<br>Brightness<br>Contrast<br>Phase<br>H Size<br>Lamp Hour  | Keystone<br>Brightness<br>Contrast<br>Lamp Hour                                    | Keystone<br>Brightness<br>Contrast<br>Phase<br>H Size<br>Lamp Hour | Keystone<br>Brightness<br>Contrast<br>Color<br>Tint<br>Lamp Hour |
| <br><b>Image</b>    | Auto Resize<br>H Position<br>V Position<br>Color Temp<br>Information  | Auto Resize<br>Color Temp<br>Information   | Ratio<br>H Position<br>V Position<br>Color<br>Tint<br>Color Temp   | Ratio<br>System<br>Sharpness<br>Color Temp<br>Information        |
| <br><b>Source</b>   | Mirror<br>Source<br>Volume<br>Treble<br>Bass<br>Mute  |  |  |  |
| <br><b>Control</b> | Language<br>OSD -- OSD Pos., OSD Time<br>Setup -- Source Scan, Keystone Hold, Mirror Hold, Blank Time, Auto Off, User<br>Logo<br>Preset Mode --<br>(PC/DVI-A signal input) Presentation Mode, Vivid Mode, Video Mode, Economic<br>Mode<br>(YPbPr/YCbCr/DVI-D/S-Video/Video signal input) Gaming Mode, Video Mode,<br>Cinema Mode, Economic Mode<br>Reset<br>High Altitude |  |  |  |
| <br><b>PIP</b>    | <b>Main Page:</b><br>PIP Source<br>PIP Size<br>PIP Pos.<br>H Position<br>V Position<br>More Options   | <b>Sub Page:</b><br>Brightness<br>Contrast<br>Color<br>Tint<br>Sharpness<br>System |  | N/A  |

\*When a Video or S-Video signal is connected, the function is only available with NTSC system selected.

## Using the menus

The projector is equipped with On-Screen Display (OSD) menus for making various adjustments and settings.

Please note that the on-screen display (OSD) menus vary according to the signal type selected.

There are 10 different menu languages of your choice. See "[Control menu](#)" on page 46 for details.

The following example describes the adjustment of the keystone.

1. Press **▼ Menu** on the projector or **MENU** on the remote control to turn the OSD menu on.
4. Adjust keystone values by pressing **◀ Left/▶ Right** on the projector or remote control.





2. Use **◀ Left/▶ Right** on the projector or remote control to select the  **Display** menu.
3. Press **▼ Menu** on the projector or **▼ Down** on the remote control to select **Keystone**.
5. Press **▲ Exit** on the projector or **MENU** on the remote control twice\* to leave and save the setting.

**\*The first press leads you back to the main menu and the second press closes the OSD menu.**



## Display menu

 Some picture adjustments are available only when certain input sources are in use. Unavailable adjustments are not shown on the screen.



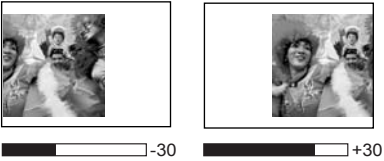
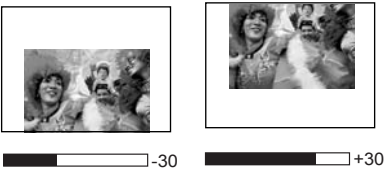

| FUNCTION<br>(default setting / value)                  | DESCRIPTION   |
|--|---|
| <b>Keystone</b><br>(0)                                 | Corrects any keystone of the image. See <a href="#">"Correcting keystone" on page 34</a> for details.   |
| <b>Brightness</b><br>(0)                               | Adjusts the brightness of the image. See <a href="#">"Adjusting brightness" on page 36</a> for details.   |
| <b>Contrast</b><br>(0)                                 | Adjusts the degree of difference between dark and light in the image. See <a href="#">"Adjusting contrast" on page 36</a> for details.                            |
| <b>Phase</b><br>(depends on the selected input source) | This function allows you to adjust the clock phase to reduce image distortion.  |
| <b>H Size</b><br>(0)                                   | Adjusts the horizontal width of the image.  |
| <b>Lamp Hour</b>                                       | Displays the number of hours the lamp has been used.  |
| <b>Color</b><br>(0)                                    | Increases or decreases the color intensity of the image.  |
| <b>Tint</b><br>(0)                                     | Adjusts the color tones of the image. The higher the value, the more reddish the image becomes. The lower the value, the more greenish the image becomes.         |

# Image menu

 Some picture adjustments are available only when certain input sources are in use. Unavailable adjustments are not shown on the screen.

| FUNCTION<br>(default setting / value)                       | DESCRIPTION  |
|---|--|
| <b>Auto Resize</b><br>(On)                                  | Automatically resizes the input signal pixel resolution to the native resolution of the projector. See <a href="#">"Selecting the aspect ratio" on page 33</a> for details.            |
| <b>H Position</b><br>(0)                                    | Adjusts the horizontal position of the projected image.<br>   |
| <b>V Position</b><br>(0)                                    | Adjusts the vertical position of the projected image.<br>   |
| <b>Color Temp</b><br>(depends on the selected input source) | Adjusts the white color. See <a href="#">"Selecting a color temperature" on page 36</a> for details.   |
| <b>Information</b>  | Shows the current image resolution.  |
| <b>Ratio</b><br>(4:3)                                       | Users have 2 options for the image ratio.<br>1. 4:3 (for a standard screen)<br>2. 16:9 (for a wide screen)<br>See <a href="#">"Selecting the aspect ratio" on page 33</a> for details. |
| <b>Color</b><br>(0)   | Increases or decreases the color intensity of the image.   |
| <b>Tint</b><br>(0)  | Adjusts the color tones of the image. The higher the value, the more reddish the image becomes. The lower the value, the more greenish the image becomes.                              |
| <b>System</b>   | Shows the Video input system format, NTSC, PAL, SECAM or YUV.  |
| <b>Sharpness</b><br>(0)                                     | Adjusts the image to make it look sharper or softer.   |

# Source menu

| FUNCTION<br>(default setting / value) | DESCRIPTION  |
|---------------------------------------|--|
| <b>Mirror</b><br>(Floor front)        | The projector can be installed on a ceiling or behind a screen, or with one or more mirrors. Contact your dealer for the ceiling mount bracket (optional accessory) if you need to install the projector on your ceiling. See <a href="#">"Choosing a location" on page 17</a> and <a href="#">"Safety instructions for ceiling mounting of the projector" on page 18</a> for details. |
| <b>Source</b>                         | Shows the current signal source.   |
| <b>Volume</b><br>(5)                  | Adjusts the volume level.<br>   |
| <b>Treble</b><br>(0)                  | Adjusts the treble level. (-5 ~ 5)<br>  |
| <b>Bass</b><br>(0)                    | Adjusts the bass level. (-5 ~ 5)<br>  |
| <b>Mute</b><br>(Off)                  | <div style="display: flex; justify-content: space-around; align-items: center;"> <div style="text-align: center;"> <b>Off</b><br/>  </div> <div style="text-align: center;"> <b>On</b><br/>  </div> </div>         |

## Control menu

| FUNCTION<br>(default setting / value)                        | DESCRIPTION (default setting / value)  |
|--|--|
| <b>Language</b><br>(English)                                 | <p>Language sets the language for the OSD control menus.</p> <p>Use ◀ <b>Left</b> / ▶ <b>Right</b> to select the desired language from among English, French, German, Italian, Spanish, Russian, Traditional Chinese, Simplified Chinese, Japanese and Korean.</p>   |
| <b>OSD</b>   | <p><b>OSD Pos.</b> (Center-bottom)<br/>Selects a desired OSD position.</p>   |
|  | <p><b>OSD Time</b> (10)<br/>Sets the length of time the OSD will remain active after your last button press. The range is from 5 to 60 seconds.</p>  |
| <b>Setup</b>   | <p><b>Source Scan</b> (On)<br/>Sets whether the projector searches automatically for input signals. If the source scan is on, the projector will search for input signals until it acquires a signal. If the function is not activated, the projector selects the last input signal.</p>   |
|  | <p><b>Keystone Hold</b> (0)<br/>When selected, preserves the last keystone correction value even when the projector is restarted.</p>  |
|  | <p><b>Mirror Hold</b> (0)<br/>When selected, preserves the last mirror correction value even when the projector is restarted.</p>  |
|  | <p><b>Blank Time</b> (0)<br/>Determines the length of time before the projector will automatically shutdown when Blank is activated.</p>   |
|  | <p><b>Auto Off</b> (0)<br/>Sets the length of time before the projector will automatically shutdown when there is no input signal detected.</p>  |
|  | <p><b>User Logo</b> (Default)<br/>Enables the user to select which logo screen will appear during projector start-up. Three modes are available: Default (BenQ logo), black screen or blue screen.</p>   |
| <b>Preset Mode</b><br>(depends on the selected input source) | <p>Preset modes are provided so you can optimize your projector image set-up to suit your program type.</p> <p>See "<a href="#">Selecting a preset mode</a>" on page 35 for details.</p>   |
| <b>Reset</b>   | <p>Returns all settings to the factory preset values.</p> <p> <b>The following settings will still remain: Phase, System, Language, Keystone hold, Mirror hold, User logo, High Altitude, PIP H Position, PIP V Position, PIP Brightness, PIP Contrast, PIP Color, PIP Tint, and PIP Sharpness.</b></p> |

|                               |  |
|-------------------------------|--|
| <b>High Altitude</b><br>(Off) | A mode for operation in areas like high altitude or high temperature. See " <a href="#">Operating in a high altitude environment</a> " on page 37 for details. |
|-------------------------------|--|

## PIP menu

This menu allows you to turn on the PIP screen and make various adjustments to the screen.

| FUNCTION                            | DESCRIPTION   |
|-------------------------------------|---|
| <b>PIP Source</b><br>(Auto)         | Selects the source for the PIP image. <b>Auto</b> is the recommended PIP source as the projector will search for a suitable signal automatically.   |
| <b>PIP Size</b><br>(Off)            | Press <b>◀ Left/▶ Right</b> to scroll through the four alternatives: Off, Small, Medium, Large.<br>Selecting <b>Off</b> closes the PIP image.<br> <b>When the resolution of the PC signal is 1280 x 1024 (SXGA), the selected Large PIP size will be reduced to the Medium size.</b> |
| <b>PIP Position</b><br>(Upper-left) | Selects a desired position for the PIP.   |
| <b>H Position</b><br>(0)            | Adjusts the horizontal position of the PIP image.   |
| <b>V Position</b><br>(100)          | Adjusts the vertical position of the PIP image.   |
| <b>More Options</b>                 | Press <b>◀ Left/▶ Right</b> to select more PIP functions including Brightness, Contrast, Color, Tint, Sharpness and System.   |
| <b>Brightness</b><br>(0)            | Adjusts the brightness of the PIP image.  |
| <b>Contrast</b><br>(0)              | Adjusts the degree of difference between dark and light in the PIP image. The higher the value, the greater the contrast.   |
| <b>Color</b><br>(0)                 | Increases or decreases the color intensity of the PIP image.  |
| <b>Tint</b><br>(0)                  | Adjusts the color tones of the PIP image. The higher the value, the more reddish the image becomes. The lower the value, the more greenish the image becomes.   |
| <b>Sharpness</b><br>(0)             | Adjusts the image to make it appear sharper or softer   |
| <b>System</b>                       | Shows Video input system format, NTSC, PAL, SECAM, or YUV.  |

# 6 Maintenance

## Care of the projector

Your projector needs little maintenance. The only thing you need to do on a regular basis is to keep the lens clean and to clean the dust filters to prevent overheating.

See "[Cleaning the lens](#)" and "[Cleaning and replacing the dust filters](#)" below for details.

Never remove any parts of the projector except the lamp and dust filter. Contact your dealer if other parts need replacing.

### Cleaning the lens

Clean the lens whenever you notice dirt or dust on the surface.

- Use a canister of compressed air to remove dust.
- If there is dirt or smears, use lens-cleaning paper or moisten a soft cloth with lens cleaner and gently wipe the lens surface.

 **Never rub the lens with abrasive materials.**

### Cleaning the projector case

Before you clean the case, turn the projector off using the proper shutdown procedure as described in "[Shutting down the projector](#)" on page 40.

- To remove dirt or dust, wipe the case with the supplied cleaning cloth.
- To remove stubborn dirt or stains, moisten a soft cloth with water and a neutral pH detergent. Then wipe the case.

 **Never use wax, alcohol, benzene, thinner or other chemical detergents. These can damage the case.**

### Storing the projector

If you need to store the projector for an extended time, please follow the instructions below:

- Make sure the temperature and humidity of the storage area are within the recommended range for the projector. Refer to "[Specifications](#)" on page 57 or consult your dealer about the range.
- Retract the adjuster feet.
- Remove the batteries from the remote control.
- Pack the projector in its original packing or equivalent.

### Transporting the projector

It is recommended that you ship the projector with its original packing or equivalent. When you carry the projector yourself, please use the original box or provided soft carry case.

### Cleaning and replacing the dust filters

It is necessary to clean the dust filters periodically. If the filters are not cleaned, they can become clogged with dust and prevent proper ventilation. This can cause overheating and a malfunction of the projector.



A warning message like the one pictured to the right will be displayed for 10 seconds every 300 hours of use to remind you to clean the filters.



**Please check if the filter is clean. Please clean the filter by using a small vacuum or brush if the filter is dirty. Press Exit to confirm.**

**IMPORTANT:** Please ensure that the projector is properly shutdown before removing the filters for cleaning or replacement.

This projector has two concealed filters. One is fitted behind the front vent grill (see item 7 on page 11), and the other is on the left side (see item 16 on page 11).

### Front filter

- 1A. Access to the front dust filter is located on the right side of the projector towards the front edge. Use your thumb or finger to pull it out from the side as illustrated in diagram 'A' below.
- 1B. If the front filter proves difficult to remove, you should use a broad flat implement (like an ice-cream stick) to gently lever the filter away from the projector case as illustrated in diagram 'B' below.
- 1C. Carefully pull the filter cartridge out from the side of the projector while keeping it parallel with the front as illustrated in diagram 'C' below

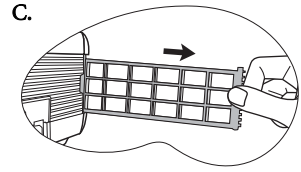
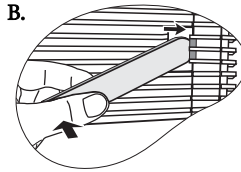
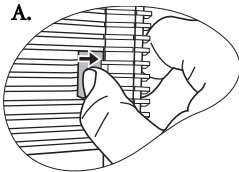

### Rear filter

2. Access to the rear dust filter is located on the left side of the projector towards the rear. Use your thumb or finger to pull it out from the side as illustrated below.

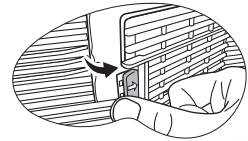

3. To clean the filters, use a small vacuum cleaner designed for computers and other office equipment, or use a soft brush (such as a clean artist's paintbrush) to gently sweep the dust away. Refit and align the filter sponge to sit snugly within the filter frame for the front filter, so that no obvious gaps are visible around the edges between the edge of the filter sponge and the plastic filter frame housing.

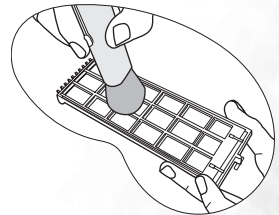

- If the dirt is difficult to remove or the filters are broken, replace them. Contact your dealer or visit BenQ website at [www.BenQ.com](http://www.BenQ.com) for more service information.
4. Carefully refit the filters to the projector then press the covers back until they click into place.

If the covers are not correctly seated in place, you will be reminded by a message displayed on the screen every three minutes. The projector will automatically shut down after 10 minutes if there has been no further action taken. Re-install the filters securely, then turn on the power again.



Please check  
Filter not well attached

## Lamp information



### Use and replacement of the lamp

When the **Lamp indicator** lights up red or a message displays suggesting it is time to replace the lamp, please install a new lamp or consult your dealer. An old lamp may cause a malfunction in the projector and in some instances the lamp may explode.

For more information on projector warnings, refer to "[Indicators](#)" on page 53.

 **The Lamp indicator light and Temperature warning light will light up if the lamp becomes too hot. Turn the power off, allow the projector to cool down before checking that the dust filters are not clogged (page 48). If the Lamp or Temp indicator still lights up after turning the power back on, please contact your dealer.**

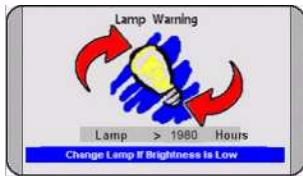
The following Lamp warning displays will remind you to change the lamp.

| Message   | Status   |
|---|--|
|    | <p>The lamp has been in operation for 1980 hours. Install a new lamp for optimal performance. If the projector is normally run with "Economic Mode" selected (see "<a href="#">Selecting a preset mode</a>" on page 35), you may continue to operate the projector until the 2980 hour lamp warning appears.</p>   |
|   | <p>The lamp has been in operation for 2980 hour, the power will shutdown in 20 hours time. A new lamp should be fitted to avoid the inconvenience when the projector runs out of lamp time.</p>  |
|  | <p>The lamp has been in operation for over 3000 hours. This message will flash in the center of the screen together with the <b>Lamp indicator</b> lighting up red for 40 seconds. The projector will shutdown after 40 seconds. The lamp <b>MUST</b> be replaced before the projector will operate normally.</p> <p>It is strongly recommended that you replace the lamp at this age. The lamp is a consumable item. With the usage time increase, the lamp brightness diminished gradually. This is normal lamp behavior. You can replace the lamp whenever you notice that the brightness level has significantly diminished. If the lamp is not replaced beforehand, it must be replaced after 3000 hours usage.</p> |

# Replacing the lamp



- To reduce the risk of electrical shock, always turn the projector off and disconnect the power cord before changing the lamp.
- To reduce the risk of severe burns, allow the projector to cool for at least 45 minutes before replacing the lamp.
- To reduce the risk of injuries to fingers and damage to internal components, use caution when removing lamp glass that has shattered into sharp pieces.
- To reduce the risk of injuries to fingers and/or compromising image quality by touching the lens, do not touch the empty lamp compartment when the lamp is removed.
- This lamp contains mercury. Consult your local hazardous waste regulations to dispose of this lamp in a proper manner.

1. Turn the power off and disconnect the projector from the wall socket.
2. Protect the projector's surface by clearing a flat open area on your desk and placing a soft item on the desk for padding.
3. Turn the projector over. Then loosen the screw and remove the lamp cover. If the lamp is hot, avoid burns by waiting for 45 minutes until the lamp has cooled.

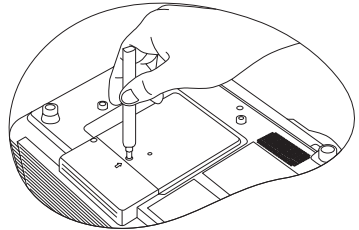

4. Loosen the screw that fixes the lamp to the projector. If the screw is not loosened completely, the lamp cannot be removed. Be careful not to lose the screw as it is needed to hold the replacement lamp in place. It is strongly recommended that you use a magnetic-head screwdriver.

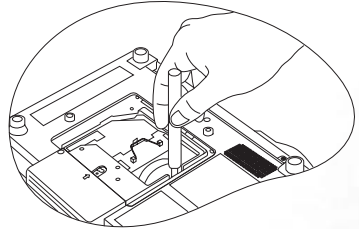

5. Lift the handle so that it stands up. Use the handle to slowly pull the lamp out of the projector.



- **Pulling too quickly may cause the lamp to break and scatter broken glass in the projector.**
- **Do not place the lamp in locations where water might splash on it, children can reach it, or near flammable materials.**
- **Do not insert your hands into the projector after the lamp is removed. If you touch the optical components inside, it could cause color unevenness and distortion of the projected images.**

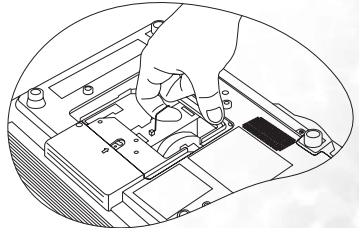

6. Insert the new lamp. Ensure the handle is fully laid flat and locked in place. Reinsert and tighten the screw firmly.



- **A Loose screw may cause a bad connection, which could result in malfunction.**
- **Do not over tighten the screw.**

7. Re-install the lamp cover and tighten the screws.
8. Make connection to a signal source to be displayed. Start up the projector. (See page "Connection" on page 22 and "Start up" on page 30 for turning the power on.)



**Do not turn the power on with the lamp cover removed. Whenever the lamp is replaced, reset the total lamp operation timer.**

- **Do not reset if the lamp is not replaced as this could cause damage.**
9. Reset the lamp counter
    - i. Press and hold **▲ Exit** on the projector for 3 seconds to display the total used lamp time.
    - ii. Press **▼ Menu** on the projector or **MENU** on the remote control to access the lamp hour timer. An adjustment message will display.
    - iii. Press **◀ Left/▶ Right** on the projector or remote control to reset lamp hours and press **▲ Exit** to leave.

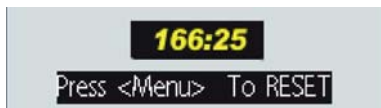
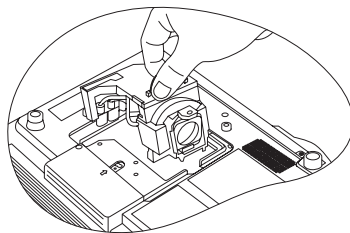

## Temperature information

When the Temperature warning light is on, it is warning you of the following possible problems.



1. The internal temperature is too high.
2. Dust filters are clogged.
3. The fans are not working.









Turn the projector off, check that the dust filters are clean. If the problem persists, contact qualified service personnel for further help.

























For more information, refer to "Indicators" on page 53

# Indicators

## Illustration

- **Blank** -: Light OFF
- : Light flashing
- : Light ON
- **O**: Orange light
- **R**: Red light
- **G**: Green light

| LED   |   |   | Status & Description   |
|---|---|---|--|
| Power   | Temp  | Lamp  |  |
| <b>Power events</b>   |   |   |  |
|    |  |    | The projector has just been connected to a power outlet.   |
|    | -   | -   | Stand-by mode.   |
|    | -   | -   | (1) The projector needs 90 seconds to cool down as it was abnormally shut down without the normal cooling down process. <b>Or</b><br>(2) The projector needs to cool for 90 seconds after the power is turned off. |
|    | -   | -   | The <b>Power indicator light</b> is flashing during powering up.   |
|  | -   | -   | The projector is under normal operation.   |
| <b>Lamp events</b>  |   |   |  |
| -   | -   | -   | The lamp counter has developed a problem.  |
| -   | -   |  | It is warning you that lamp usage has exceeded 3000 hours. Replace the projection lamp with a new one immediately.   |
| -   | -   |  | The lamp is not properly attached or the lamp is damaged. Please contact your dealer for assistance.   |

| LED   |   |   | Status & Description  |
|---|---|---|---|
| Power   | Temp  | Lamp  |   |
| Thermal events  |   |   |   |
| -   |    | -   | The projector has shutdown automatically. If you try to restart the projector, it will shutdown again. Please contact your dealer for assistance. |
| -   |    |    |   |
| -   |    |    |   |
|    |    | -   |   |
|    |    |    |   |
|    |    |    |   |
|    |    | -   |   |
|    |    |    |   |
|  |  |  |   |
|  |  |  |   |

# 7 Troubleshooting

## ? The projector does not turn on.

| Cause   | Remedy   |
|---|--|
| There is no power from the power cable.                               | Plug the power cord into the AC inlet on the projector, and plug the power cord into the power outlet. If the power outlet has a switch, make sure that it is switched on. |
| Attempting to turn the projector on again during the cooling process. | Wait until the cooling down process has completed.   |

## ? No picture

| Cause  | Remedy   |
|--|--|
| The video source is not turned on or connected correctly.            | Turn the video source on and check that the signal cable is connected correctly.               |
| The projector is not correctly connected to the input source device. | Check the connection.  |
| The input signal has not been correctly selected.                    | Select the correct input signal with the <b>SOURCE</b> key on the projector or remote control. |
| The lens cover is not open.  | Remove the lens cover.   |

## ? Blurred image

| Cause  | Remedy   |
|--|--|
| The projection lens is not correctly focused.          | Adjust the focus of the lens using the focus ring.   |
| The projector and the screen are not aligned properly. | Adjust the projection angle and direction as well as the height of the projector if necessary. |
| The lens cover is not open.                            | Remove the lens cover.   |
| There is dirt or dust on the lens.                     | Clean the lens as described in <a href="#">"Cleaning the lens" on page 48</a> .                |

## ? Remote control does not work

| Cause  | Remedy  |
|--|---|
| The batteries are out of power.                                    | Replace the batteries with new ones.                |
| There is an obstacle between the remote control and the projector. | Remove the obstacle.                                |
| You are too far away from the projector.                           | Stand within 6 meters (19.5 feet) of the projector. |

⑦ **The computer projected image is too big for the screen or appeared to be cut-off**

| Cause  | Remedy  |
|--|---|
| The computer's resolution does not match the projector's resolution. | <ol style="list-style-type: none"> <li>1. Make sure Auto Resize is set to On in the Image menu.</li> <li>2. Make sure the H Position and V Position settings are correct in the Image menu.</li> <li>3. Configure the computer's external display resolution to the projector's native resolution (1024 x 768 for PB8253/PB8263). If this option is not available, select one of the compatible listed in <a href="#">"Supported timing for PC (including DVI-I) input"</a> on page 58.</li> <li>4. Check if your presentation files are created for a different resolution.</li> </ol> |
| The computer's external monitor setting is locked in 640 x 480.      |   |

⑦ **My Window Media Player program works great on my computer, but the movie window is dark on my projector, while the Media Player tools display OK.**

| Cause  | Remedy   |
|--|--|
| The computer external display is set as a secondary display. | Change the Display settings. Click Start > Control Panel > Display > Settings > Advanced > Display. See your computer documentation for details, if you cannot find the Display settings by following the instructions above. Set the Monitor to Primary, and the Panel to Secondary. You will see the movie window on the projector image, while the Panel movie window will be dark. |

⑦ **The remote mouse function does not work.**

| Cause  | Remedy   |
|--|--|
| The USB cable is not correctly connected to the projector or computer. | Check the connection. See <a href="#">"Connecting a computer"</a> on page 22 for details. If it still doesn't work, check the mouse driver. See the mouse documentation for details. |



# 8 Specifications

## Projector specifications

 All specifications are subject to change without notice.

### Optical

|                |                              |
|----------------|------------------------------|
| Resolution     | 1024 x 768 XGA               |
| Display system | 1-CHIP DMD                   |
| Lens F/Number  | F=2.4 to 2.6, f=24.0-29.1 mm |
| Lamp           | 300W lamp                    |

### Electrical

|                   |  |
|-------------------|--|
| Power supply      | AC100–240V, 4.5A, 50/60 Hz (Automatic) |
| Power consumption | 395W (Max.)                            |

### Mechanical

|        |                  |
|--------|------------------|
| Weight | 7.9 lbs (3.6 Kg) |
|--------|------------------|

### Input terminal

#### Computer input

|             |                           |
|-------------|---------------------------|
| RGB input   | D-Sub 15-pin (female) x 1 |
| DVI-I input | (Using DVI-A signal)      |

#### Video signal input

|         |                         |
|---------|-------------------------|
| S-VIDEO | Mini DIN 4-pin port x 1 |
| VIDEO   | RCA jack x 1            |

#### SD/HDTV signal input

|  |
|--|
| Analog - D-Sub to Component RCA jack x 3 (using RGB input) |
| Digital - DVI (HDTV only)                                  |

#### Audio signal input

|           |                      |
|-----------|----------------------|
| PC Audio  | Stereo mini jack x 1 |
| Audio L/R | RCA jack x 2         |

### Output

|            |                           |
|------------|---------------------------|
| RGB output | D-Sub 15-pin (female) x 1 |
| Speaker    | (Stereo) 1 watt x 2       |

### Control

|                       |                    |
|-----------------------|--------------------|
| USB mouse control     | A/B series x 1     |
| RS-232 serial control | Mini Din 9 pin x 1 |

### Environmental Requirements

|                             |  |
|-----------------------------|--|
| Operating temperature       | 0°C ~ 40°C at sea level  |
| Operating relative humidity | 10% ~ 90% (without condensation)   |
| Operating altitude          | <ul style="list-style-type: none"><li>• 0–3000 feet at 0°C–40°C</li><li>• 3000–6000 feet at 0°C–30°C</li><li>• 6000–10000 feet at 0°C–23°C</li></ul> |

# Dimensions

320 mm (W) x 106 mm (H) x 236 mm (D)

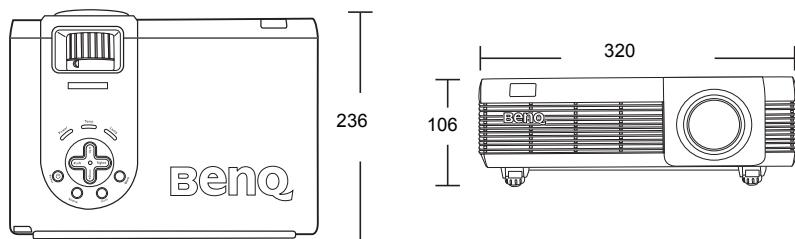

Unit: mm

# Timing chart

Supported timing for PC (including DVI-I) input

| Resolution    | Horizontal Frequency (kHz) | Vertical Frequency (Hz) | Pixel Frequency (MHz) | Mode          |
|---------------|----------------------------|-------------------------|-----------------------|---------------|
| 720 x 400     | 37.927                     | 85.039                  | 35.500                | 720 x 400_85  |
| 640 x 480     | *31.469                    | *59.940                 | *25.175               | *VGA_60       |
|               | 37.861                     | 72.809                  | 31.500                | VGA_72        |
|               | 37.500                     | 75.000                  | 31.500                | VGA_75        |
|               | 43.269                     | 85.008                  | 36.000                | VGA_85        |
| 800 x 600     | 37.879                     | 60.317                  | 40.000                | SVGA_60       |
|               | 48.077                     | 72.188                  | 50.000                | SVGA_72       |
|               | 46.875                     | 75.000                  | 49.500                | SVGA_75       |
|               | 53.674                     | 85.061                  | 56.250                | SVGA_85       |
| 1024 x 768    | 48.363                     | 60.004                  | 65.000                | XGA_60        |
|               | 56.476                     | 70.069                  | 75.000                | XGA_70        |
|               | 60.023                     | 75.029                  | 78.750                | XGA_75        |
|               | 68.667                     | 84.997                  | 94.500                | XGA_85        |
| 1280 x 1024   | 63.981                     | 60.020                  | 108.000               | SXGA_60       |
| **720 x 480   | 15.73                      | 59.94 (interlaced)      | 13.50                 | 480i          |
| **720 x 480   | 31.47                      | 59.94                   | 27.00                 | 480p          |
| **1280 x 720  | 45.00                      | 59.94                   | 74.25                 | 720p          |
| **1920 x 1080 | 28.13                      | 59.94                   | 74.25                 | 1080i (1125L) |
| **720 x 576   | 15.63                      | 50 (interlaced)         | 13.50                 | 576i          |
| **720 x 576   | 31.25                      | 50                      | 27.00                 | 576p          |
| **1280 x 720  | 37.50                      | 50                      | 74.25                 | 720p          |
| **1920 x 1080 | 28.13                      | 50                      | 74.25                 | 1080i (1125L) |

 \* denotes the timing is not available when Analog RGB or DVI-A input signal is selected

\*\* denotes the timing is not available when DVI-D input signal is selected

## Supported timing for Component-YP<sub>b</sub>P<sub>r</sub> input

| Signal Format     | Horizontal Frequency (kHz) | Vertical Frequency (Hz) |
|-------------------|----------------------------|-------------------------|
| 480i(525i)@60Hz   | 15.73                      | 59.94                   |
| 480p(525p)@60Hz   | 31.47                      | 59.94                   |
| 576i(625i)@50Hz   | 15.63                      | 50.00                   |
| 576p(625p)@50Hz   | 31.25                      | 50.00                   |
| 720p(750p)@60Hz   | 45.00                      | 60.00                   |
| 720p(750p)@50Hz   | 37.50                      | 50.00                   |
| 1080i(1125i)@60Hz | 33.75                      | 60.00                   |
| 1080i(1125i)@50Hz | 28.13                      | 50.00                   |

## Supported timing for Video and S-Video inputs

| Video mode | Horizontal Frequency (kHz) | Vertical Frequency (Hz) | Color Sub-carrier Frequency (MHz) |
|------------|----------------------------|-------------------------|-----------------------------------|
| NTSC       | 15.73                      | 60                      | 3.58                              |
| PAL        | 15.63                      | 50                      | 4.43                              |
| SECAM      | 15.63                      | 50                      | 4.25 or 4.41                      |
| PAL-M      | 15.73                      | 60                      | 3.58                              |
| PAL-N      | 15.63                      | 50                      | 3.58                              |
| PAL-60     | 15.73                      | 60                      | 4.43                              |
| NTSC4.43   | 15.73                      | 60                      | 4.43                              |

# Warranty

## Limited Warranty

BenQ warrants this product against any defects in material and workmanship, under normal usage and storage.

Proof of purchase date will be required with any warranty claim. In the event this product is found to be defective within the warranty period, BenQ's only obligation and your exclusive remedy shall be replacement of any defective parts (labor included). To obtain warranty service, immediately notify the dealer from which you purchased the product of any defects.

Important: The above warranty shall be void if the customer fails to operate the product in accordance with BenQ's written instructions, especially the ambient humidity must be in-between 10% and 90%, temperature in-between 0°C and 40°C, altitude lower than 10000 feet, and avoiding to operate the projector in a dusty environment. This warranty gives you specific legal rights, and you may have other rights which vary from country to country.

For other information, please visit [support.BenQ.com](http://support.BenQ.com).

# 10 Regulation Statements

## FCC statement

**CLASS B:** This equipment generates, uses and can radiate radio frequency energy and, if not installed and used in accordance with the instructions, may cause harmful interference to radio communications. However, there is no guarantee that interference will not occur in a particular installation. If this equipment does cause harmful interference to radio or television reception, which can be determined by turning the equipment off and on, the user is encouraged to try to correct the interference by one or more of the following measures:

- Reorient or relocate the receiving antenna.
- Increase the distance between the equipment and receiver.
- Connect the equipment into an outlet on a circuit different from that to which the receiver is connected.
- Consult the dealer or an experienced radio/TV technician for help.

## EEC statement

This machine was tested against the 89/336/EEC (European Economic Community) for EMC (Electronic Magnetic Compatibility) and fulfills these requirements.

## MIC statement

### **B class equipment (Household purpose info/telecommunications equipment)**

As this equipment has undergone EMC registration for household purpose, this product can be used in any area including residential area.

## WEEE directive

### **Disposal of Waste Electrical and Electronic Equipment by users in private households in the European Union.**

This symbol on the product or on the packaging indicates that this can not be disposed of as household waste. You must dispose of your waste equipment by handing it over to the applicable take-back scheme for the recycling of electrical and electronic equipment. For more information about recycling of this equipment, please contact your city office, the shop where you purchased the equipment or your household waste disposal service. The recycling of materials will help to conserve natural resources and ensure that it is recycled in a manner that protects human health and environment.

