

Panasonic®

LCD Projector

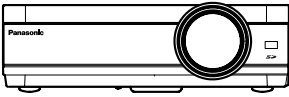

Operating Instructions

Model No. **PT-L300U**
PT-L200U



Before operating this product, please read the instructions carefully and save this manual for future use.

ProSelecta

View :: Compare :: Select - www.ProSelecta.com

Dear Panasonic Customer:

This instruction booklet provides all the necessary operating information that you might require. We hope it will help you to get the most performance out of your new product, and that you will be pleased with your Panasonic LCD projector.

The serial number of your product may be found on its back. You should note it in the space provided below and retain this booklet in case service is required.

Model number: **PT-L300U / PT-L200U**

Serial number: _____

IMPORTANT SAFETY NOTICE

WARNING: TO REDUCE THE RISK OF FIRE OR ELECTRIC SHOCK, DO NOT EXPOSE THIS PRODUCT TO RAIN OR MOISTURE.

Power Supply: This LCD Projector is designed to operate on 100 V – 240 V, 50 Hz/60 Hz AC, house current only.

CAUTION: The AC power cord which is supplied with the projector as an accessory can only be used for power supplies up to 125 V, 7 A. If you need to use higher voltages or currents than this, you will need to obtain a separate 250 V power cord. If you use the accessory cord in such situations, fire may result.



The lightning flash with arrowhead symbol, within an equilateral triangle, is intended to alert the user to the presence of uninsulated “dangerous voltage” within the product’s enclosure that may be of sufficient magnitude to constitute a risk of electric shock to persons.



The exclamation point within an equilateral triangle is intended to alert the user to the presence of important operating and maintenance (servicing) instructions in the literature accompanying the product.

CAUTION: This equipment is equipped with a three-pin grounding-type power plug. Do not remove the grounding pin on the power plug. This plug will only fit a grounding-type power outlet. This is a safety feature. If you are unable to insert the plug into the outlet, contact an electrician. Do not defeat the purpose of the grounding plug.

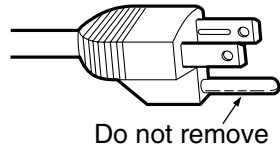

WARNING:

This equipment has been tested and found to comply with the limits for a Class B digital device, pursuant to Part 15 of the FCC Rules. These limits are designed to provide reasonable protection against harmful interference in a residential installation. This equipment generates, uses, and can radiate radio frequency energy and, if not installed and used in accordance with the instructions, may cause harmful interference to radio communications. However, there is no guarantee that interference will not occur in a particular installation. If this equipment does cause harmful interference to radio or television reception, which can be determined by turning the equipment off and on, the user is encouraged to try to correct the interference by one or more of the following measures:

- Reorient or relocate the receiving antenna.
- Increase the separation between the equipment and receiver.
- Connect the equipment into an outlet on a circuit different from that to which the receiver is connected.
- Consult the dealer or an experienced radio/TV technician for help.

CAUTION: Any unauthorized changes or modifications to this equipment will void the users authority to operate.

Declaration of Conformity

Model Number: PT-L300U / PT-L200U
Trade Name: **Panasonic**
Responsible party: Matsushita Electric Corporation of America.
Address: One Panasonic Way Secaucus New Jersey 07094
Telephone number: 1-800-528-8601 or 1-800-222-0741
Email: pbtsservice@panasonic.com

This device complies with Part 15 of the FCC Rules, Operation is subject to the following two conditions: (1) This device may not cause harmful interference, and (2) this device must accept any interference received, including interference that may cause undesired operation.

Contents

Preparation

IMPORTANT SAFETY NOTICE	2
Precautions with regard to safety	5
Accessories	9
Precautions on handling	10
Location and function of each part ...	12
Using the remote control unit	17
Inserting the batteries	17
Operating range.....	17
Connections	18
Notes on connections	18
Example of connecting to video equipment ...	18
Example of connecting to equipment compatible with YPBPr(CbCr) signals ...	19
Example of connecting to computer ...	20
Setting-up	21
Projection methods.....	21
Projector position.....	21

Basic Operation

Starting to use	22
Turning on the power.....	22
Turning off the power.....	23
On-screen menus	24
Menu screens	24
Menu operation guide	26
Unavailable on-screen menu items... ..	26
Returning to the previous screen... ..	26
Returning a setting to the factory default ...	27
Using the freeze function	27
Correcting keystone distortion	28
Setting the ASPECT	30
Selecting the picture mode	32
Using the shutter function	33
Changing the display language	33
Muting the sound	33
Adjusting the picture	34
PICTURE MODE	34
CONTRAST	34
BRIGHT	34
COLOR	34
TINT	35
SHARPNESS	35
TV SYSTEM	35
Color Hue Setting	35
WHITE BALANCE R/G/B	36
SIGNAL MODE.....	36
GAMMA ADJUST	36
MEMORY SAVE	36
MEMORY LOAD	36
Projecting sRGB compatible pictures ...	37

Adjusting the position	38
HORIZONTAL POSITION	38
VERTICAL POSITION	38
DOT CLOCK	38
CLOCK PHASE	38
ASPECT	39
AUTO SETUP	39

Advanced Operation

Option settings	39
OSD	39
NR (Noise Reduction).....	39
PC PRIORITY.....	39
BACK COLOR	39
4:3 H-POS	40
FRONT/REAR	40
DESK/CEILING	40
FAN CONTROL.....	40
LAMP POWER	40
LAMP RUNTIME	40
SD memory card	41
What is the SD memory card?	41
Data that can be played back	41
Note when using SD memory cards... ..	41
Inserting and removing the SD memory card	42
About the SD menu	43
Playing back still images	44
Slide playback of still images	45
Playing back moving images	49
Error displays	50

Others

Indicators	51
Cleaning and replacing the air filter	53
Replacing the lamp unit	54
Before calling for service	57
Specifications	59
Appendix	61
List of compatible signals	61
Connector pin wiring	62
Projection dimensions calculation methods ...	63
DCF standard	64
Dimensions	65
Trademark acknowledgements	65

Precautions with regard to safety

WARNING

If a problem occurs (such as no image or no sound) or if you notice smoke or a strange smell coming from the projector, turn off the power and disconnect the power cord from the wall outlet.

- Do not continue to use the projector in such cases, otherwise fire or electric shocks could result.
- Check that no more smoke is coming out, and then contact an Authorized Service Center for repairs.
- Do not attempt to repair the projector yourself, as this can be dangerous.

Do not look into the lens while the projector is being used.

- Strong light is emitted from the projector's lens. If you look directly into this light, it can hurt and damage your eyes.

Be especially careful not to let young children look into the lens.

In addition, turn off the power when you are away from the projector.

Do not install this projector in a place which is not strong enough to take the full weight of the projector.

- If the installation location is not strong enough, it may fall down or tip over, and severe injury or damage could result.

Installation work (such as ceiling suspension) should only be carried out by a qualified technician.

- If installation is not carried out correctly, there is the danger that injury or electric shocks may occur.

If foreign objects or water get inside the projector, or if the projector is dropped or the cabinet is broken, turn off the power and disconnect the power cord from the wall outlet.

- Continued use of the projector in this condition may result in fire or electric shocks.
- Contact an Authorized Service Center for repairs.

Do not overload the wall outlet.

- If the power supply is overloaded (for example, by using too many adapters), overheating may occur and fire may result.

Do not remove the cover or modify it in any way.

- High voltages which can cause fire or electric shocks are present inside the projector.
- For any inspection, adjustment and repair work, please contact an Authorized Service Center.

Clean the power cord plug regularly to prevent it from becoming covered in dust.

- If dust builds up on the power cord plug, the resulting humidity can damage the insulation, which could result in fire. Pull the power cord out from the wall outlet and wipe it with a dry cloth.

- If not using the projector for an extended period of time, pull the power cord plug out from the wall outlet.

Do not do anything that might damage the power cord or the power cord plug.

- Do not damage the power cord, make any modifications to it, place it near any hot objects, bend it excessively, twist it, pull it, place heavy objects on top of it or wrap it into a bundle.
- If the power cord is used while damaged, electric shocks, short-circuits or fire may result.
- Ask an Authorized Service Center to carry out any repairs to the power cord that might be necessary.

Do not handle the power cord plug with wet hands.

- Failure to observe this may result in electric shocks.

Insert the power cord plug securely into the wall outlet.

- If the plug is not inserted correctly, electric shocks or overheating could result.
- Do not use plugs which are damaged or wall outlets which are coming loose from the wall.

Do not place the projector on top of surfaces which are unstable.

- If the projector is placed on top of a surface which is sloped or unstable, it may fall down or tip over, and injury or damage could result.

Do not place the projector into water or let it become wet.

- Failure to observe this may result in fire or electric shocks.

Do not place liquid containers on top of the projector.

- If water spills onto the projector or gets inside it, fire or electric shocks could result.
- If any water gets inside the projector, contact an Authorized Service Center.

Do not insert any foreign objects into the projector.

- Do not insert any metal objects or flammable objects into the projector or drop them onto the projector, as doing so can result in fire or electric shocks.

Do not allow the + and - terminals of the battery to come into contact with metallic objects such as necklaces or hairpins.

- Failure to observe this may cause the battery to leak, overheat, explode or catch fire.
- Store the battery in a plastic bag and keep it away from metallic objects.

During a thunderstorm, do not touch the projector or the cable.

- Electric shocks can result.

Do not use the projector in a bath or shower.

- Fire or electric shocks can result.

Do not bring your hands or other objects close to the air outlet port.

- Heated air comes out of the air outlet port. Do not bring your hands or face, or objects which cannot withstand heat close to this port, otherwise burns or damage could result.

Replacement of the lamp unit should only be carried out by a qualified technician.

- The lamp unit has high internal pressure. It can easily become damaged if struck against hard objects or dropped, and injury or malfunctions may result.

When replacing the lamp, allow it to cool for at least one hour before handling it.

- The lamp cover gets very hot, and contact with it can cause burns.

Before replacing the lamp, be sure to unplug the power cord from the power outlet.

- Electric shocks or explosions can result if this is not done.

Caution

Do not cover the air inlet or the air outlet.

- Doing so may cause the projector to overheat, which can cause fire or damage to the projector.

Do not set up the projector in humid or dusty places or in places where the projector may come into contact with smoke or steam.

- Using the projector under such conditions may result in fire or electric shocks.

When disconnecting the power cord, hold the plug, not the cord.

- If the power cord itself is pulled, the cord will become damaged, and fire, short-circuits or serious electric shocks may result.

Always disconnect all cables before moving the projector.

- Moving the projector with cables still attached can damage the cables, which could cause fire or electric shocks to occur.

Do not place any heavy objects on top of the projector.

- Failure to observe this may cause the projector to become unbalanced and fall, which could result in damage or injury.

Do not short-circuit, heat or disassemble the battery or place it into water or fire.

- Failure to observe this may cause the battery to overheat, leak, explode or catch fire, and burns or other injury may result.

When inserting the battery, make sure the polarities (+ and -) are correct.

- If the battery is inserted incorrectly, it may explode or leak, and fire, injury or contamination of the battery compartment and surrounding area may result.

Use only the specified battery.

- If an incorrect battery is used, it may explode or leak, and fire, injury or contamination of the battery compartment and surrounding area may result.

Do not mix old and new batteries.

- If the batteries are inserted incorrectly, they may explode or leak, and fire, injury or contamination of the battery compartment and surrounding area may result.

Do not put your weight on this projector.

- You could fall or the projector could break, and injury may result.
- Be especially careful not to let young children climb onto the equipment.

Disconnect the power cord plug from the wall outlet as a safety precaution before carrying out any cleaning.

- Electric shocks can result if this is not done.

Ask an Authorized Service Center to clean inside the projector at least once a year.

- If dust is left to build up inside the projector without being cleaned out, it can result in fire or problems with operation.
- It is a good idea to clean the inside of the projector before the season for humid weather arrives. Ask your nearest Authorized Service Center to clean the projector when required. Please discuss with the Authorized Service Center regarding cleaning costs.

We are in effort to hold your environment clean. Please bring the non repairable unit your Dealer or a Recycling Company.

NOTICE:

- This product has a High Intensity Discharge (HID) lamp that contains a small amount of mercury. It also contains lead in some components. Disposal of these materials may be regulated in your community due to environmental considerations. For disposal or recycling information please contact your local authorities, or the Electronics Industries Alliance: <http://www.eiae.org>

Accessories

Check that all of the accessories shown below have been included with your projector.

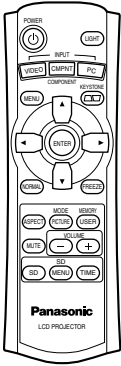
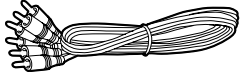
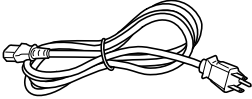
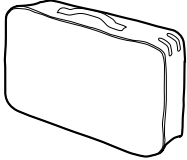
<p>Remote control unit (N2QAFA000002 x1)</p> 	<p>Video/Audio cable [3.0 m (9'10"), K2KA2FA00001 x1]</p> 	<p>AAA batteries for remote control unit (x2)</p> 
	<p>Power cord (K2CG3FR00001 x 1)</p> 	<p>Carrying bag (TPEP008 x1)</p> 

Precautions on handling

Cautions when moving the projector

Be sure to attach the lens cover before moving the projector.

The projection lens is extremely susceptible to vibration and shocks. When moving the projector, use the accessory carrying bag. When placing the projector inside the carrying bag, position it so that the lens is facing upward.

Cautions regarding setting-up

Observe the following at all times when setting up the projector.

Avoid setting up in places which are subject to vibration or shocks.

If the projector is set up in locations with strong vibration, such as near a motor, or if it is installed inside a vehicle or on board a ship, the projector may be subjected to vibration or shocks which can damage the internal parts and cause malfunctions or accidents. Accordingly, set up the projector in a place which is free from such vibrations and shocks.

Do not set up the projector near high-voltage power lines or near motors.

The projector may be subject to electromagnetic interference if it is set up near high-voltage power lines or motors.

If installing the projector to the ceiling, ask a qualified technician to carry out all installation work.

If the projector is to be suspended from the ceiling, you will need to purchase the separate installation kit (Model No.: ET-PKE300). Furthermore, all installation work should only be carried out by a qualified technician.

If using this projector at high elevations (above 1400 m), set the FAN CONTROL to HIGH. (Refer to page 40.)

Failure to observe this may result in malfunctions.

Notes on use

In order to get the best picture quality

If outside light or light from indoor lamps is shining onto the screen, the images projected will not have good contrast. Draw curtains or blinds over any windows and turn off any fluorescent lights near the screen to prevent reflection.

Do not touch the surfaces of the lens with your bare hands.

If the surface of the lens becomes dirty from fingerprints or anything else, this will be magnified and projected onto the screen. Moreover, when not using the projector, retract the lens and then cover it with the accessory lens cover.

About the SD memory card slot

Make sure that there are no foreign objects inside the slot when inserting an optional SD memory card. Failure to observe it may damage the card and the slot.

About the screen

If the screen you are using is dirty, damaged or discolored, attractive projections cannot be obtained. Do not apply any volatile substances to the screen, and do not let it become dirty or damaged.

About the lamp

The lamp may need to be replaced earlier due to variables such as a particular lamp's characteristics, usage conditions and the installation environment, especially when it is subjected to a continuous use for more than 10 hours.

About the liquid crystal panel

The liquid crystal panel of the projector is built with very high precision technology giving you fine picture details. Occasionally, a few non-active pixels may appear on the screen as a fixed point of blue, green or red. Please note that this does not affect the performance of your LCD.

Before carrying out cleaning and maintenance, be sure to disconnect the power cord plug from the wall outlet.**Wipe the cabinet with a soft, dry cloth.**

If the cabinet is particularly dirty, soak the cloth in water with a small amount of neutral detergent in it, squeeze the cloth very well, and then wipe the cabinet. After cleaning, wipe the cabinet dry with a dry cloth.

If using a chemically-treated cloth, read the instructions supplied with the cloth before use.

Do not wipe the lens with a cloth that is dusty or which produces lint. If any dust or lint gets onto the lens, such dust or lint will be magnified and projected onto the screen. Use a blower to clean any dust and lint from the lens surface, or use a soft cloth to wipe off any dust or lint.

Location and function of each part

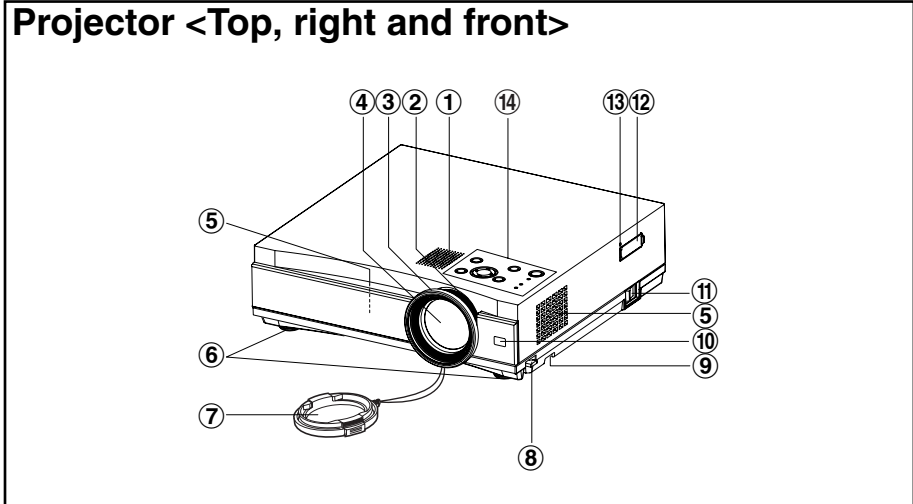

- ① **Speaker**
- ② **Zoom ring**
(page 23)
- ③ **Focus ring**
(page 23)
- ④ **Projection lens**
- ⑤ **Air inlet ports**
Do not cover this port.
- ⑥ **Front adjustable legs(L/R)**
(page 22)
- ⑦ **Lens cover**
- ⑧ **Leg adjuster buttons(L/R)**
(page 22)
This button is used to unlock the front adjustable legs. Press to adjust the angle of tilt of the projector.
- ⑨ **Air filter**
(page 53)
- ⑩ **Remote control signal receptor**
(page 17)
- ⑪ **MAIN POWER switch**
(pages 22 and 23)
- ⑫ **SD memory card slot**
(page 42)
Insert the SD memory card into here after opening the cover.
- ⑬ **Access lamp**
(page 42)
Flashes while the projector is being accessed for reading or writing the data in the SD memory card.
- ⑭ **Projector control panel**
(page 14)

Projector <Back and bottom>

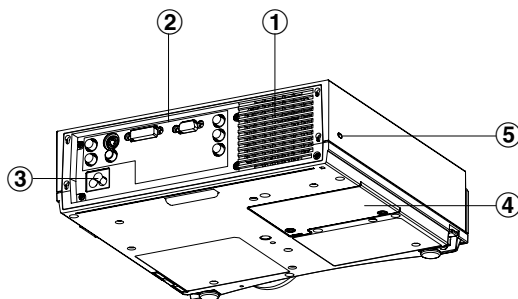

① Air outlet port

Do not cover this port.

WARNING

Do not bring your hands or other objects close to the air outlet port.

- Heated air comes out of the air outlet port. Do not bring your hands or face, or objects which cannot withstand heat close to this port, otherwise burns or damage could result.

② Connector panel

(page 16)

③ Power input socket (AC IN)

(page 22)

The accessory power cord is connected here.

Do not use any power cord other than the accessory power cord.

④ Lamp unit holder

(page 55)

NOTE:

- During projection of an image, the cooling fan will operate, emitting

a small noise as it operates.

Turning the lamp on or off will cause this noise to increase a little.

- By using the OPTION menu to set "LAMP POWER" to LOW, the operating sound of the fan can be reduced. (Refer to page 40.)

⑤ Security lock

This can be used to connect a commercially-available theft-prevention cable (manufactured by Kensington). This security lock is compatible with the Microsaver Security System from Kensington. Contact details for this company are given below.
 Kensington Technology Group
 ACCO Brands Inc.
 2855 Campus Drive
 San Mateo, CA 94403 USA
 Tel (650)572-2700
 Fax (650)572-9675
<http://www.kensington.com/>
<http://www.gravis.com/>

<Projector control panel and remote control unit>

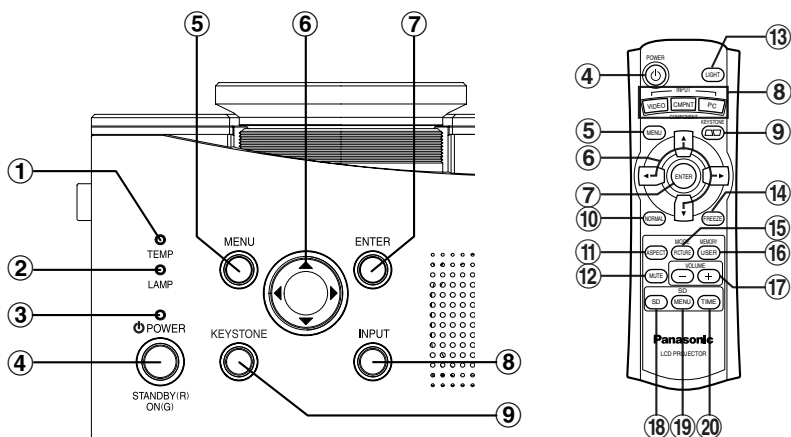

- The remote control unit and the projector itself have the same control buttons available.

① TEMP indicator

(page 51)

This indicator illuminates if an abnormally high temperature is detected inside the projector. If the temperature rises above a certain level, the power supply will be turned off automatically and the indicator will illuminate or flash.

② LAMP indicator

(page 52)

This indicator illuminates when it is time to replace the lamp unit. It flashes if a circuit abnormality is detected.

③ Power indicator

(pages 22 and 23)

This indicator illuminates red when the main power is switched on (Standby Mode), and it illuminates green when projection of an image begins.

④ POWER button

(pages 22 and 23)

⑤ MENU button

(page 24)

This button is used to display menu screens. When a menu screen is being displayed, it can be used to return to a previous screen or to clear the screen.

⑥ Arrow (▲, ▼, ◀ and ▶) buttons

(page 26)

These buttons are used to select and adjust items in the on-screen menu screens.

⑦ ENTER button

(page 26)

This button is used to accept and to activate items selected in the on-screen menus.

⑧ Input select button

(INPUT/VIDEO/COMPONENT/PC button) (page 22)

- ⑨ **KEYSTONE buttons**
(pages 28 and 29)
This button is used to correct keystone distortion of the projected image when the projector position is tilted upward or downward.
- ⑩ **NORMAL button**
(page 27)
This button is used to reset the projector adjustment values to the factory default settings.
- ⑪ **ASPECT button**
(page 30)
This button is used for aspect adjustment (vertical and horizontal proportions).
- ⑫ **MUTE button**
(page 33)
This button momentarily stops output of the projector's built-in speaker.
- ⑬ **LIGHT button**
This button is used to illuminate the buttons on the remote control unit.
- ⑭ **FREEZE button**
(page 36)
This button is used to momentarily freeze projection so that a still picture is displayed.
- ⑮ **MODE PICTURE button**
(page 32)
This button is to display the PICTURE MODE menu.
- ⑯ **MEMORY USER button**
(page 36)
This button is to display the MEMORY LOAD menu.
- ⑰ **VOLUME +/- buttons**
These buttons are used to adjust the volume of the sound output from the projector's built-in speaker.
- ⑱ **SD button**
(page 43)
This button is to select the SD CARD screen.
- ⑲ **SD MENU button**
(page 43)
This button can be used to return to a previous screen when SD CARD screen is selected.
- ⑳ **SD TIME button**
(page 49)
This button is used to display or clear the playing time when a moving picture stored on the SD card is played back.

<Connector panel>

<PT-L300U>

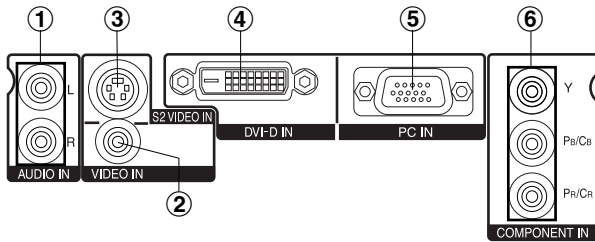

<PT-L200U>

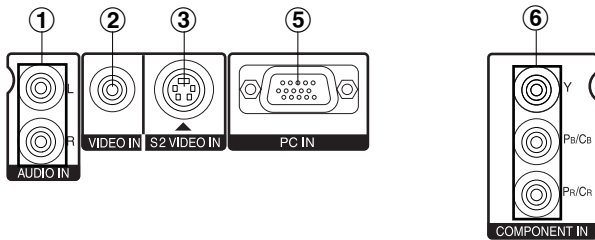

① AUDIO L-R input jacks

(page 18)

② VIDEO input jack

(page 18)

This jack is used to input video signals from a video equipment such as a video deck.

③ S2 VIDEO input connector

(page 18 and 30)

This connector is used to input signals from an S-VIDEO-compatible equipment such as a video deck. The connector is compatible with S2 and S1 signals, and projector aspect is automatically adjusted according to the type of signal received.

④ DVI-D IN connector

(page 20)

This connector is used to input DVI-D signals.

⑤ RGB input connector

(page 20)

This connector is used to input RGB signals from a PC.

⑥ YPbPr(CbCr) input jacks

(page 19)

These jacks are used to input YPbPr signals from compatible equipment such as DVD players.

Using the remote control unit

Operating range

- ① Open the cover.

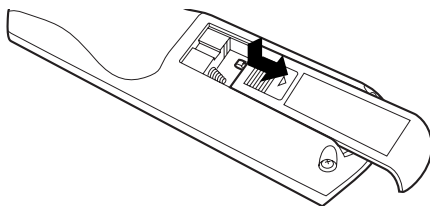

- ② Insert the batteries so that the polarities are correct, and then close the cover.

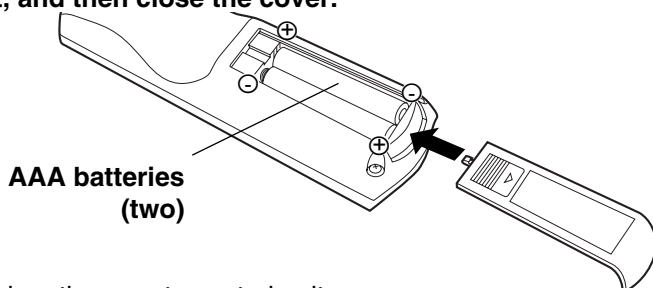

NOTE:

- Do not drop the remote control unit.
- Keep the remote control unit away from liquids.
- Remove the batteries if not using the remote control unit for long periods.
- Do not use rechargeable batteries.

Operating range

If the remote control unit is held so that it is facing directly in front of the remote control signal receptors on the front of the projector, the operating range is within approximately 7 m (23') from the surfaces of the receptors.

Furthermore, the remote control unit can be operated from an angle of $\pm 30^\circ$ to the left or right and $\pm 15^\circ$ above or below the receptors.

NOTE:

- If there are any obstacles in between the remote control unit and the receivers, the remote control unit may not operate correctly.
- If strong light is allowed to shine onto the remote control signal receiver, correct remote control operation may not be possible. Place the projector as far away from light sources as possible.
- If facing the remote control unit toward the screen to operate the projector, the operating range of the remote control unit will be limited by the amount of light reflection loss caused by the characteristics of the screen used.

Connections

Notes on connections

- Read the instruction manual for each system component carefully before connecting it.
- Turn off the power supply for all components before making any connections.
- If the cables necessary for connecting a component to the system are not included with the component or available as an option, you may need to fashion a cable to suit the connector concerned.

Example of connecting to video equipment

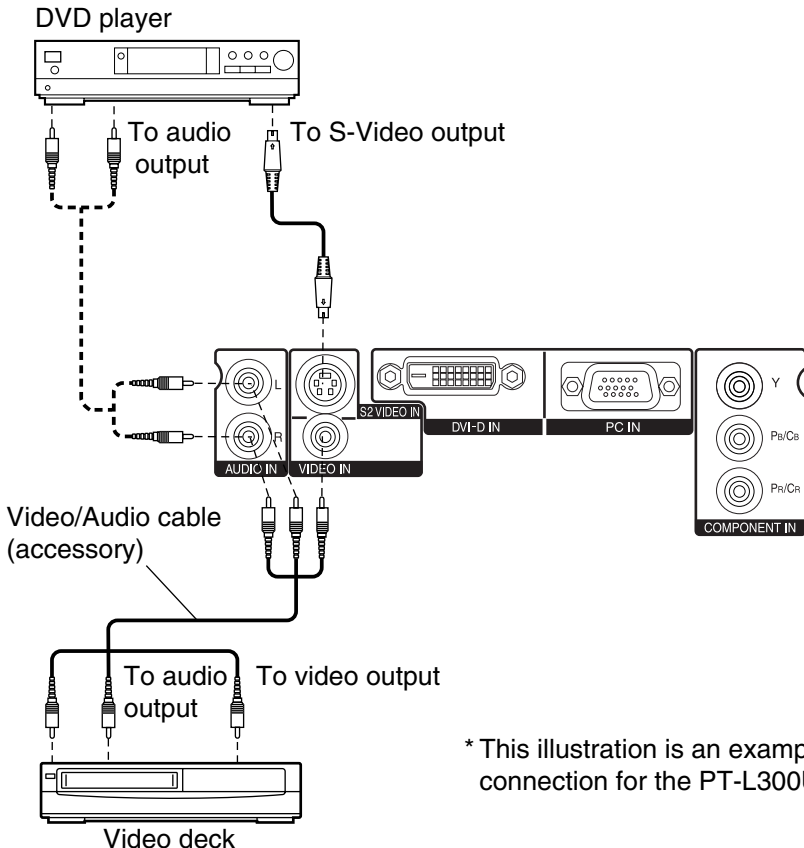

* This illustration is an example of connection for the PT-L300U.

NOTE:

- Only one audio system circuit is available for the AUDIO IN L-R jacks, so if you wish to change the audio input source, you will need to remove and insert the appropriate plugs.

Example of connecting to equipment compatible with YPBPR(CBCR) signals

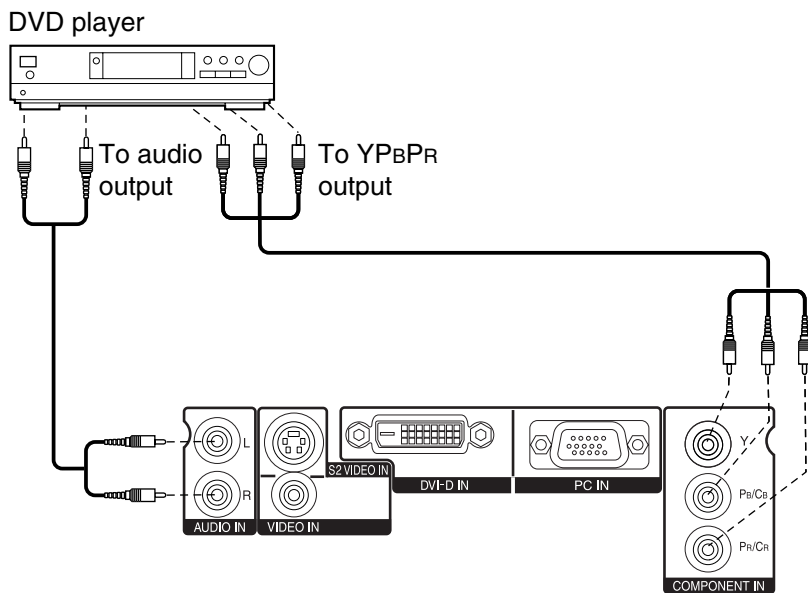

* This illustration is an example of connection for the PT-L300U.

NOTE:

- Refer to page 61 for a list of compatible YPBPR signals which can be input to the projector.
- Only one audio system circuit is available for the AUDIO IN L-R jacks, so if you wish to change the audio input source, you will need to remove and insert the appropriate plugs.

Example of connecting to computer

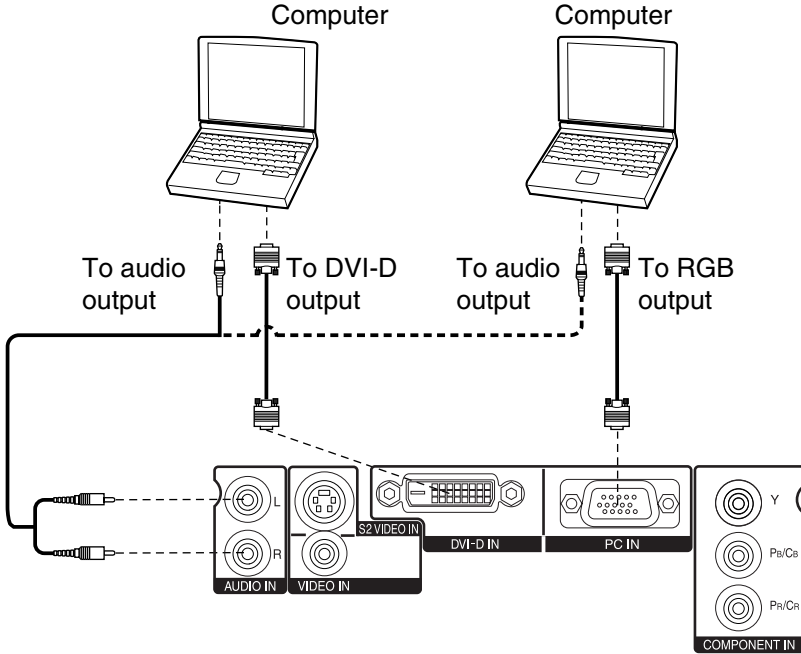

* This illustration is an example of connection for the PT-L300U.

NOTE:

- It is better to shut down the computer before turning off the MAIN POWER switch of the projector.
- Refer to the list of compatible signals on page 61 for the types of RGB signals which can be input to the projector by connecting a computer.
- Only one audio system circuit is available for the AUDIO IN L-R jacks, so if you wish to change the audio input source, you will need to remove and insert the appropriate plugs.
- The PT-L200U does not have a DVI-D input (DVI-D IN) connector.

Setting-up

Projection methods

The projector can be set up so that any one of the following four projection methods can be used. Select whichever projection method matches the setting-up method. (The projection method can be set from the OPTION menu. Refer to page 40 for details.)

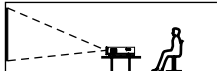
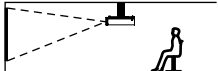
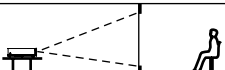
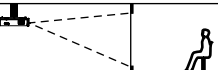
		DESK/CEILING	
		DESK	CEILING
FRONT/REAR	FRONT	 (Factory default setting)	
	REAR		

NOTE:

- You will need to purchase the separate ceiling bracket (ET-PKE300) when using the ceiling installation method.

Projector position

The projection range of this projector is 1.2 m – 7.4 m.

The lower edge of the projected image falls about 0.1 m from the center of the lens.

For details about projected image distances, refer to page 65.

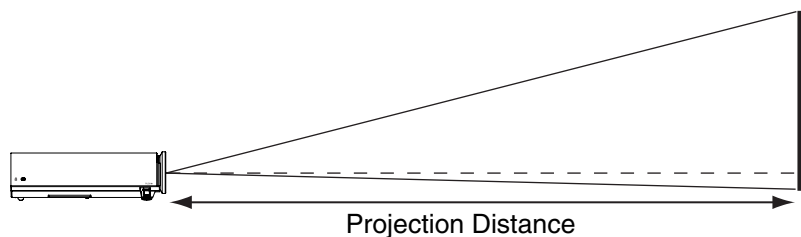

Screen Size (16:9)	Diagonal length	40"	60"	80"	100"	150"	200"
	Projection Distance	Height	0.5 m (1'7")	0.8 m (2'7")	1.0 m (3'3")	1.3 m (4'3")	1.9 m (6'2")
Width		0.9 m (2'11")	1.3 m (4'3")	1.8 m (5'10")	2.2 m (7'2")	3.3 m (10'9")	4.4 m (14'5")
Minimum Distance		1.2 m (3'11")	1.9 m (6'2")	2.5 m (8'2")	3.1 m (10'2")	4.7 m (15'5")	6.2 m (20'4")
Maximum Distance		1.4 m (4'7")	2.2 m (7'2")	2.9 m (9'6")	3.7 m (12'1")	5.6 m (18'4")	7.4 m (24'3")

Starting to use

Turning on the power

Please ensure that all preparations have been completed before turning on the power. (Refer to pages 18 – 21.)

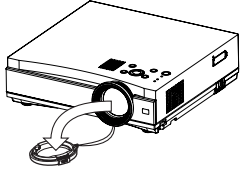
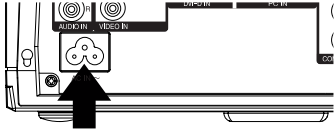
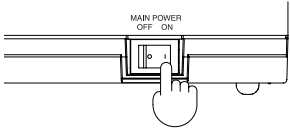
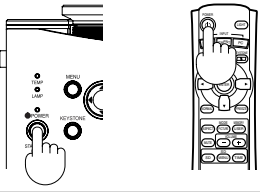
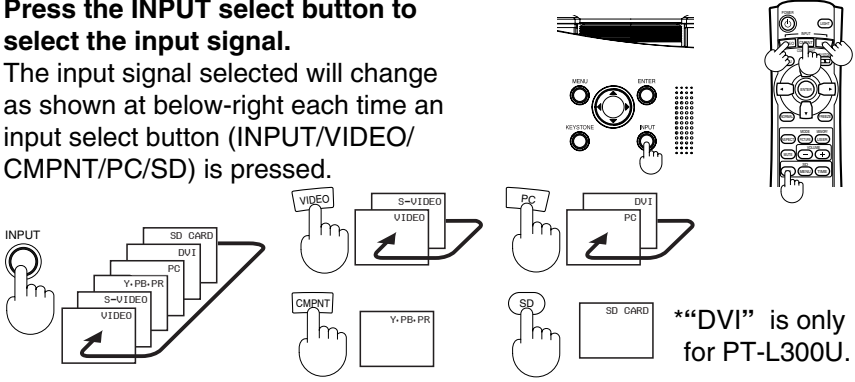
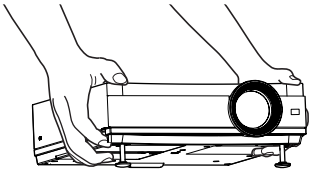
<p>① Remove the lens cover.</p>	
<p>② Connect the accessory power cord.</p>	
<p>③ Press the MAIN POWER switch to the “I” side to turn on the power. The power indicator on the projector will illuminate red.</p>	
<p>④ Press the POWER button. The power indicator on the projector will flash green. After a short period, the button will illuminate green, and a picture will be projected.</p>	
<p>⑤ Press the INPUT select button to select the input signal. The input signal selected will change as shown at below-right each time an input select button (INPUT/VIDEO/ CMPNT/PC/SD) is pressed.</p>	
<p>⑥ While pressing the adjuster buttons, adjust the forward/back angle of tilt of the projector. If there is keystone distortion in the projected images, carry out keystone correction as described on page 28.</p>	

- ⑦ Turn the focus/zoom ring to adjust the projected image focus and size.

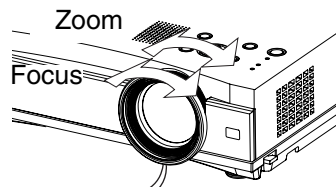

Turning off the power

- ① Press the **POWER** button. “**POWER OFF**” is displayed on the screen.
- ② Select “**OK**” using the ◀ and ▶ buttons and press the **ENTER** button.



- The lamp unit will switch off and the picture will stop being projected. (The power indicator on the projector will illuminate orange.)
- ③ Wait until the power indicator on the projector illuminates red (until the cooling fan stops).
- Do not in any way cut power to the projector while the cooling fan is still operating. Be careful not to switch off the **MAIN POWER** switch of the projector, unplug the power cord from the electrical outlet or turn off in-line switches such as tabletop power switches.
- ④ Press the **MAIN POWER** switch to the “**O**” side to turn off the power.

NOTE:

- After the power is turned off, the lamp unit will take some time to cool down. If you turn the power back on again before the lamp unit has cooled down, the lamp unit may not turn on straight away, but it will turn on automatically after a short period. (During this time, the power indicator on the projector will flash orange.)
- When the projector is in standby mode (the power indicator on the projector is illuminated red), the projector will still draw a maximum 1.5 W of power, even when the cooling fan has stopped.
- If the **MAIN POWER** switch is accidentally turned off while the projector is being used, the lamp unit may not turn on straight away after the power is turned back on. In such cases, the lamp unit will turn back on automatically after a short period. (During this time, the power indicator on the projector will flash green.)
- A tinkling sound may be heard while the power indicator is turned off, but this is not a sign of a malfunction.
- You can also turn off the power by pressing the **POWER** button twice or by holding down it for at least 0.5 seconds.

On-screen menus

Menu screens

The various settings and adjustments for this projector can be carried out by selecting the operations from on-screen menus.

The general arrangement of these menus is shown below.

MAIN MENU

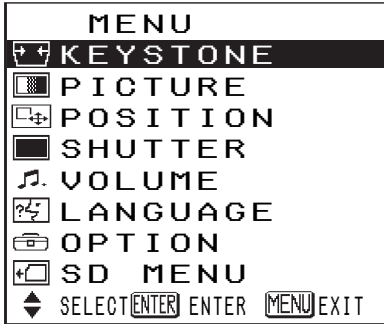

Keystone correction

(page 28)

For PT-L300U



For PT-L200U



* Only vertical keystone distortion is corrected by PT-L200U.

SD menu (page 43)



SHUTTER function

(page 33)

Volume adjustment

Press the ENTER button, and then press the ◀ and ▶ buttons to adjust the volume.

OPTION menu (page 39)

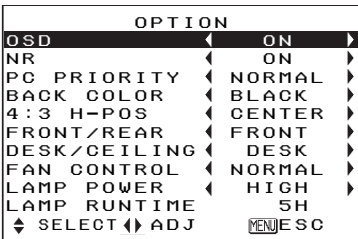

LANGUAGE menu (page 33)

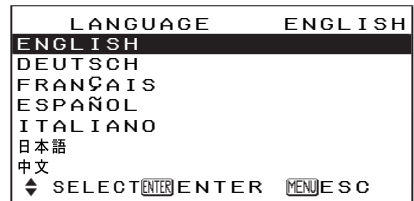

NOTE:

- Keystone distortion of the on-screen display will not be corrected. (PT-L200U only)

PICTURE menu (page 34)

When an S-VIDEO/VIDEO signal is being input

PICTURE	
PICTURE MODE ◀ NORMAL ▶	
CONTRAST	0
BRIGHT	0
COLOR	0
TINT	0
SHARPNESS	0
COLOR TEMP.	◀ 0 ▶
GAMMA ADJUST	
MEMORY SAVE	
MEMORY LOAD	
TU-SYSTEM	◀ AUTO1 ▶
◆ SELECT	▶ ADJ

When a YPBPR signal is being input or SD CARD is selected

PICTURE	
PICTURE MODE ◀ NORMAL ▶	
CONTRAST	0
BRIGHT	0
COLOR	0
TINT	0
SHARPNESS	0
COLOR TEMP.	◀ 0 ▶
GAMMA ADJUST	
MEMORY SAVE	
MEMORY LOAD	
SIGNAL MODE	525 I
◆ SELECT	▶ ADJ

When a PC/DVI signal is being input

PICTURE	
PICTURE MODE ◀ NORMAL ▶	
CONTRAST	0
BRIGHT	0
SHARPNESS	0
COLOR TEMP.	◀ 0 ▶
W-BAL R	0
W-BAL G	0
W-BAL B	0
GAMMA ADJUST	
MEMORY SAVE	
MEMORY LOAD	
SIGNAL MODE	XGA
◆ SELECT	▶ ADJ

* "GAMMA ADJUST" is not displayed by PT-L200U.

* "W-BAL R", "W-BAL G" and "W-BAL B" are not displayed when DVI signal is being input.

POSITION menu (page 38)

When an S-VIDEO/VIDEO/YPBPR/DVI signal is being input or SD CARD is selected

POSITION	
H-POSITION	0
V-POSITION	0
ASPECT	◀ 16:9 ▶
◆ SELECT	ENTER ENTER

When a PC signal is being input

POSITION	
H-POSITION	0
V-POSITION	0
DOT CLOCK	0
CLOCK PHASE	0
ASPECT	◀ 4:3 ▶
AUTO SETUP	
◆ SELECT	ENTER ENTER

* "ASPECT" can be adjusted only when a DVI signal is being input or when "SD CARD" is selected.

Menu operation guide

① Press the MENU button.

The MAIN MENU screen will be displayed.

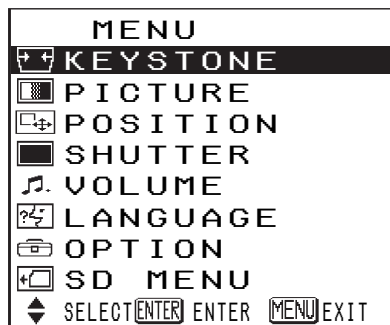

② Press the ▲ or ▼ arrow buttons to select an item.

Selected items will be displayed in blue.

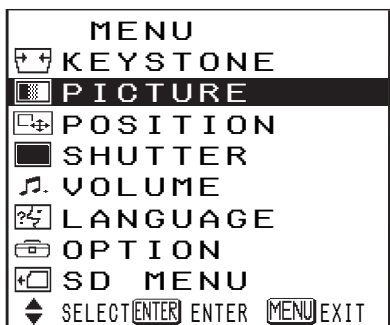

③ Press the ENTER button to accept the selection.

The selected menu screen or adjustment screen will then be displayed.

(Example: PICTURE menu)

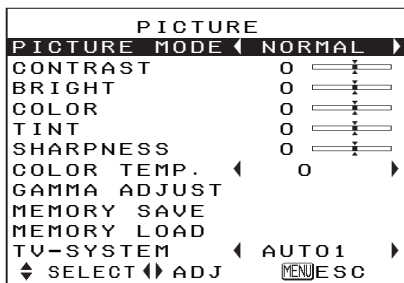

④ Press the ▲ or ▼ buttons to select an item, and then press the ◀ or ▶ buttons to change or adjust the setting.

An individual adjustment screen such as the one shown below will be displayed for bar-scale items.



The bar scale will turn green when any adjustment changes the setting from the factory set value.

For items without any selective arrow or bar-scale, press the ENTER button. The menu screen for the item will then be displayed.

Unavailable on-screen menu items

This projector has unadjustable items and unusable functions depending on the signal being input. When an item cannot be adjusted or a function cannot be used, the corresponding on-screen menu display does not appear, and the item or function will not work even if the ENTER button is pressed.

Returning to the previous screen

If you press the MENU button while a menu screen is being displayed, the display will return to the previous screen.

If you press the MENU button while the MAIN MENU screen is being displayed, the MAIN MENU screen will be cleared.

Correcting keystone distortion

When either the projector or the screen is tilted, the keystone distortion will affect the image. You can correct the image proportions by the following procedure.

For PT-L300U

Horizontal and vertical keystone distortion can be corrected by following procedures.

- ① Press the KEYSTONE button to display the KEYSTONE menu.



- ② To correct vertical keystone distortion

Select “V-KEYSTONE” by pressing the ▲ or ▼ buttons and then press the ENTER button.



Picture condition		
Operation	Press the ► button.	Press the ◀ button.

- ③ To correct the horizontal keystone distortion

Select “H-KEYSTONE” by pressing the ▲ or ▼ buttons and then press the ENTER button.



Picture condition		
Operation	Press the ► button.	Press the ◀ button.

- ④ Press the MENU button.
The display will then return to the previous screen.

For PT-L200U

Vertical keystone distortion can be corrected by following procedures.

- ① Use the **KEYSTONE** button to obtain image balance.

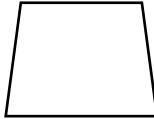

Picture condition		
Operation	Press the ► button.	Press the ◀ button.

- ② Press the **MENU** button to return to the previous screen.

NOTE:

- You can also correct keystone distortion by selecting the **KEYSTONE** item in the **MAIN MENU** and pressing **ENTER**.
- Vertical and horizontal keystone distortion can be corrected to $\pm 30^\circ$ of the angle of tilt by PT-L300U. Vertical keystone distortion can be corrected to $\pm 30^\circ$ of the angle of tilt by PT-L200U. However, the greater the correction amount, the more the picture quality will deteriorate, and the harder it will become to achieve a good level of focus. To obtain the best picture quality, set up the projector and screen in such a way that the amount of keystone correction required is as minimal as possible.
- The picture size will also change when correction of keystone distortion is carried out.

Setting the ASPECT

This projector allows you to change the aspect ratio to match the type of input signal. Pressing the ASPECT button will change the aspect ratio according to the successive settings shown below.

(You can also change the aspect ratio by selecting the POSITION item in the MAIN MENU and pressing ENTER.)

S-VIDEO	S1/S2→4:3→16:9→JUST→ZOOM→*S4:3→*S16:9
VIDEO/YPbPr	4:3→16:9→JUST→ZOOM→*S4:3→*S16:9
PC	4:3→16:9→V SCROLL
DVI	4:3→16:9
SD CARD	4:3→16:9→JUST→ZOOM

* "S4:3" or "S16:9" can be selected when NTSC, M-NTSC, PAL-M, PAL60, 525p and 525i signals are being input to the PT-L300U.

Illustrations for aspect ratio settings are shown on the next page. Refer to this illustration for assistance in selecting a suitable aspect ratio.

About S1/S2 video signals:

- S1/S2 video signals are for 16:9 images and include a notification signal when being played by devices such as a DVD player.
- When the projector is set to the "S1/S2" setting shown above, it will detect those notification signals and automatically switch to the correct aspect ratio for projection.

NOTE:

- This projector is equipped with an aspect ratio selection function. However, if a mode which does not match the aspect ratio of the input signal is selected, it may affect the quality of viewing of the original picture. Keep this in mind when selecting the aspect ratio.
- If using this projector in places such as cafes or hotels with the aim of displaying programmes for viewing for a commercial purpose or for public presentation, note that if the aspect ratio (16:9) selection function is used to change the aspect ratio of the screen picture, you may be infringing the rights of the original copyright owner for that program under copyright protection laws.
- If a normal (4:3) picture which was not originally intended for wide-screen viewing is projected onto a wide screen, distortion may occur around the edges of the picture so that part of the picture is no longer visible. Such programmes should be viewed in 4:3 mode to give proper consideration to the aims and intentions of the original program's creator.
- The following signals have resolutions that are 16:9 image sizes. The aspect ratios for these signals cannot be changed while being played because they are already established. (Refer to page 61.)
HDTV60, HDTV50, 750p, WIDE 400/480/600/720/768
- Image sizes such as Cinema-Vision that project wider than the 16:9 ratio will have narrow black fields at the top and bottom.

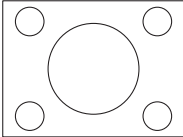
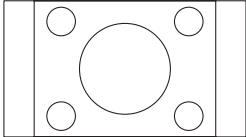
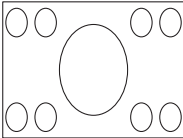
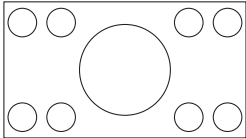
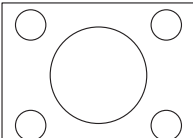
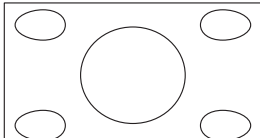
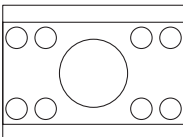
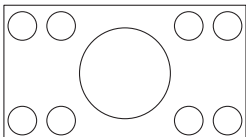
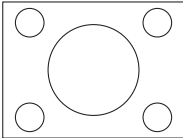
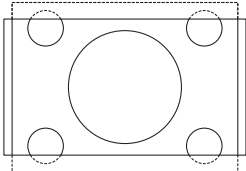
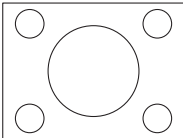
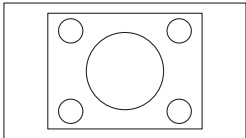
ASPECT	Input signal	Projected Image
4:3	4:3 Input signal 	4:3 
16:9	Squeezed signal (image contracted horizontally) 	Horizontal expansion of projected image 
JUST	4:3 Input signal 	Horizontal expansion of projected image (Center of image is less distorted) 
ZOOM	Letter box signal 	Expansion preserves original ratio 
V SCROLL	4:3 Input signal 	Enlarges image approximately 1.2 times (Vertical position can be adjusted by the ▼ and ▲ buttons) 
S4:3 S16:9 (PT-L300U only)	4:3 Input signal 	Image which is projected at an aspect ratio of 4:3 or 16:9 without being expanded vertically. 

Selecting the picture mode

You can select the appropriate picture mode for the type of projected image by the following procedure.

(The picture mode can be also selected in the PICTURE menu.)

- ① Press the **MODE PICTURE** button to display the **PICTURE** menu.

PICTURE MODE ◀ NORMAL ▶

- ② Select an item by pressing the ◀ or ▶ buttons.

When S-VIDEO/VIDEO/YPbPr is being input or when SD CARD is selected

When PC/DVI is being input

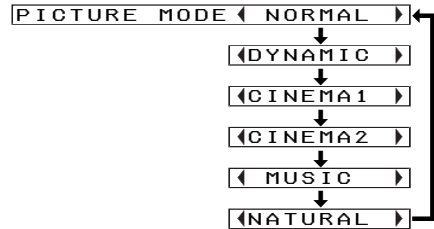
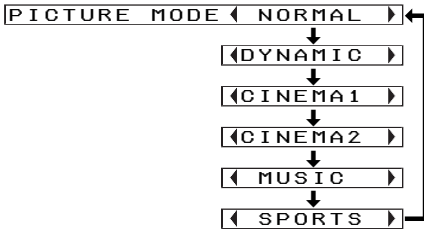

NORMALWhen the brightness of the room is at a standard level.

DYNAMICWhen the room is brighter.

CINEMA1When watching movies.

CINEMA2When watching movies with lighter and clearer pictures.

MUSICWhen watching music programs such as concerts or live performances.

SPORTSWhen watching sports programs such as baseball or soccer games.

NATURALTo project the image faithfully from the image source.

Using the shutter function

The shutter function can be used to momentarily turn off the picture and sound from the projector when the projector is not being used for short periods of time, such as during breaks in meetings or when carrying out preparation. The projector uses less power in shutter mode than it does in normal projection mode.

- ① Select **SHUTTER** from the **MAIN MENU** screen and then press the **ENTER** button.
- ② Press any button on either the projector or remote control unit to return to normal operating mode.

Changing the display language

- ① Select **LANGUAGE** from the **MAIN MENU** screen and then press the **ENTER** button.
- ② Use the **▲▼** buttons to select a language and then press the **ENTER** button.

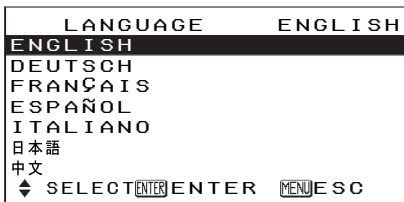

Indicates the language which is currently set

Muting the sound

The sound can be muted for temporary interruptions such as telephone calls. Press the **MUTE** button once to turn off sound, and press **MUTE** again to regain sound.

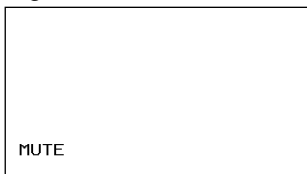

NOTE:

- If the power is turned off or the **VOLUME +/-** buttons are pressed, the mute will be canceled.

TINT

(NTSC/NTSC 4.43/YPbPr /SD CARD only)

This adjusts the flesh tones in the picture. Press the ► button to make flesh tones more greenish, and press the ◀ button to make the flesh tones more reddish.

SHARPNESS

Press the ► button to make the picture details sharper, and press the ◀ button to make the picture details softer.

TV SYSTEM

(S-VIDEO/VIDEO only)

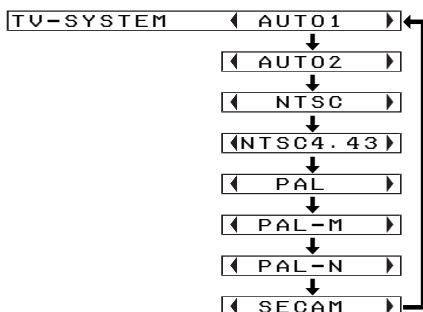

AUTO1 The projector automatically distinguishes between NTSC/NTSC 4.43/PAL/PAL60/SECAM signals.

AUTO2 The projector automatically distinguishes between NTSC/PAL-M/PAL-N signals.

This should normally be set to "AUTO1" or "AUTO2". If the signal is of such poor quality that the correct format cannot be automatically distinguished, change the setting manually to the required TV system.

Color Hue Setting (color temperature)

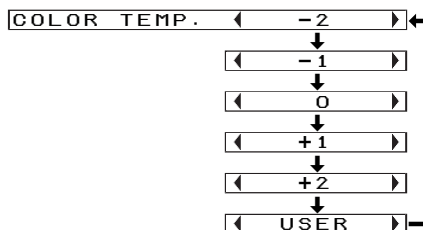

* "USER" will not be displayed by PT-L200U.

This is used to adjust the white areas of the picture if they appear bluish or reddish.

USER (PT-L300U only)

This item lets you make fine adjustments to the color temperature.

① Press the ◀ or ► buttons to select the "USER" and press the ENTER button.

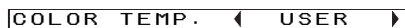

② Press the ▲ or ▼ buttons to select an item and adjust the setting by pressing the ◀ or ► buttons.

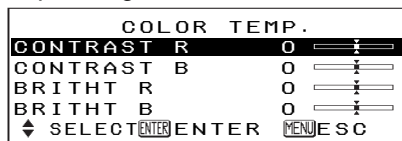

If the white area of the picture appears bluish, adjust CONTRAST B or BRIGHT B to a lower setting or adjust the CONTRAST R or BRIGHT R to a higher setting.

If it appears reddish, adjust CONTRAST R or BRIGHT R to a lower setting or adjust the CONTRAST B or BRIGHT B to a higher setting.

Adjust settings using CONTRAST R or CONTRAST B under normal conditions.

When adjusting the black or neutral color area of the picture, adjust it using BRIGHT R or BRIGHT B.

WHITE BALANCE R/G/B

(PC only)

This is used to adjust the white areas of the picture if they appear coloured.

Press the ◀ button to make the selected color lighter.

Press the ▶ button to make the selected color stronger.

SIGNAL MODE

(PC/DVI/YPbPr only)

This displays the type of signal which is currently being projected.

Refer to the table on page 61 for details on each type of signal.

GAMMA ADJUST

(PT-L300U only)

Press the ENTER button to display the GAMMA ADJUST menu.

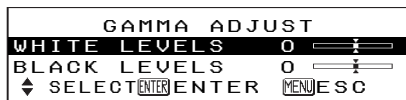

WHITE LEVELS

This is used for correcting the gradation of a bright projected image. To correct a white jump in the picture, press the ◀ buttons. To raise the contrast ratio, press the ▶ buttons.

BLACK LEVELS

This is used for correcting gradation of a dark projected image.

To correct black crushing, press the ▶ buttons. To raise the contrast ratio, press the ◀ buttons.

MEMORY SAVE

Press the ENTER button to display the MEMORY SAVE menu.

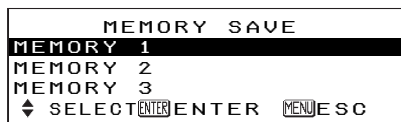

Up to 3 settings can be saved in the PICTURE menu.

Select the number in which you wish to save the setting by pressing the ▲ or ▼ buttons and then press the ENTER button.

The confirmation screen will then be displayed. Select "OK" by pressing the ◀ or ▶ buttons and press the ENTER button.

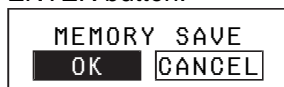

MEMORY LOAD

Press the ENTER button to display the MEMORY LOAD menu.

(If any setting is not saved in the MEMORY SAVE menu, the MEMORY LOAD menu will not be displayed.)

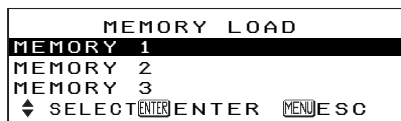

A setting saved in the MEMORY SAVE menu can be retrieved using MEMORY LOAD. Select the number which you wish to retrieve by pressing the ▲ or ▼ buttons and then press the ENTER button.

NOTE:

- The MEMORY LOAD menu can also be displayed by pressing the MEMORY USER button.
- The number with which some settings are saved using MEMORY SAVE will only be displayed in the MEMORY LOAD menu.

Projecting sRGB-compatible pictures

sRGB is an international color reproduction standard (IEC61966-2-1) established by the International Electrotechnical Commission (IEC).

If you would like the colours in sRGB-compatible pictures to be reproduced more faithfully, make the following settings.

- ① Press the ▲ or ▼ button to select “PICTURE MODE”, and then use the ◀ or ▶ button to select “NATURAL”.
- ② Press the NORMAL button on the remote control unit.
- ③ Select the LAMP POWER item in the OPTION menu by pressing the ▲ or ▼ buttons and set to “HIGH” by pressing the ◀ or ▶ buttons.

NOTE:

- sRGB is only enabled when RGB signals are being input .

Adjusting the position

When the input signal is from a PC, first select AUTO SETUP and then press the ENTER button to initiate automatic positioning. If the optimum setting is not obtained when AUTO SETUP is carried out, adjust by the following procedure.

Use the ▲ and ▼ buttons to select an item, and then use the ◀ and ▶ buttons to change the setting for that item.

For items with bar scales, press the ENTER button or the ◀ or ▶ buttons to display the adjustment screen, and then use the ◀ or ▶ buttons to make the adjustment.

When an S-VIDEO/VIDEO/YPbPr/DVI signal is being input or SD CARD is selected.

POSITION	
H-POSITION	0 ◀▶
V-POSITION	0 ◀▶
ASPECT	◀ 16:9 ▶
SELECT	ENTER ENTER MENU ESC

- “ASPECT” can be adjusted only when a DVI signal is being input or when “SD CARD” is selected.

When an PC signal is being input

POSITION	
H-POSITION	0 ◀▶
V-POSITION	0 ◀▶
DOT CLOCK	0 ◀▶
CLOCK PHASE	0 ◀▶
ASPECT	◀ 4:3 ▶
AUTO SETUP	
SELECT	ENTER ENTER MENU ESC

HORIZONTAL POSITION

(S-VIDEO/VIDEO/YPbPr/PC only)

Press the ◀ button to move the picture to the left, and press the ▶ button to move the picture to the right.

VERTICAL POSITION

(S-VIDEO/VIDEO/YPbPr/PC only)

Press the ◀ button to move the picture down, and press the ▶ button to move the picture up.

DOT CLOCK

(PC only)

Periodic striped pattern interference (noise) may occur when a striped pattern such as the one below is

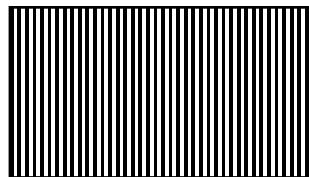

projected. If this happens, use the ◀ and ▶ buttons to adjust so that any such noise is minimised.

CLOCK PHASE

(PC only)

Adjust the DOT CLOCK setting first before carrying out this adjustment. Use the ◀ and ▶ buttons to adjust so that the noise level is least noticeable.

NOTE:

- If signals with a dot clock frequency of 100 MHz or higher are being input, interference may not be completely eliminated when the DOT CLOCK and CLOCK PHASE adjustments are carried out.

ASPECT

Refer page 30.

AUTO SETUP

(PC only)

HORIZONTAL POSITION, VERTICAL POSITION, DOT CLOCK and CLOCK PHASE are

matched to the input signal and are automatically adjusted.

NOTE:

- When the ASPECT is set to V-SCROLL (page 30), AUTO SETUP cannot be performed.

Option settings

Use the ▲ and ▼ buttons to select an item, then press the ◀ or ▶ buttons to change the setting.

OPTION	
OSD	ON
NR	ON
PC PRIORITY	NORMAL
BACK COLOR	BLACK
4:3 H-POS	CENTER
FRONT/REAR	FRONT
DESK/CEILING	DESK
FAN CONTROL	NORMAL
LAMP POWER	HIGH
LAMP RUNTIME	5H
◀ SELECT ▶ ADJ	MENU ESC

Reduction) feature, set it to “OFF”.

PC PRIORITY

(PC only)

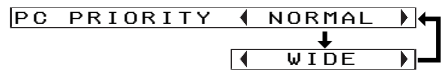

NORMAL displays the PC screen data in a 4:3 aspect ratio. WIDE displays the PC screen data in a 16:9 aspect ratio.

OSD

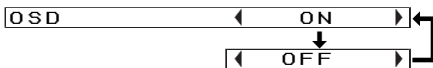

- ON** The signal name is displayed in the top-right corner of the screen when the input signal is changed.
- OFF** Use this setting when you do not want the signal name to be displayed.

BACK COLOR

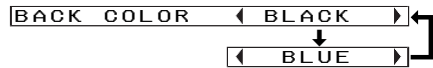

This sets the color which is projected onto the screen when no signal is being input to the projector. This sets the background color for the left/right margins when the 4:3 aspect ratio is selected. (Refer to page 31.)

NR (Noise Reduction)

(S-VIDEO/VIDEO/YPbPr only)



If noise occurs from the projector because of a poor input signal, set NR to “ON”. To turn off the NR (Noise

4:3 H-POS

(4:3 aspect mode only)

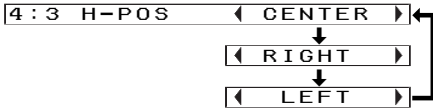

This sets the horizontal positioning of the projected image when the 4:3 aspect ratio is selected. (Refer to page 31.)

FRONT/REAR

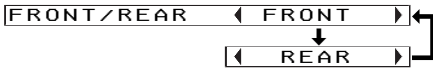

This setting should be changed in accordance with the projector setting-up method.

Set to “FRONT” when using a normal reflective screen with the projector positioned in front of the screen, and set to “REAR” when using a translucent screen with the projector positioned behind the screen.

DESK/CEILING

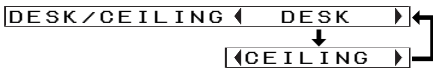

This setting should be changed in accordance with the projector setting-up method.

Set to “DESK” when setting up the projector on a desk or similar, and set to “CEILING” when suspending the projector from the ceiling using the ceiling bracket which is sold separately.

FAN CONTROL

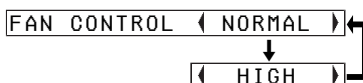

If using of this projector at high

elevations (above 1 400 m), set FAN CONTROL to “HIGH”.

LAMP POWER

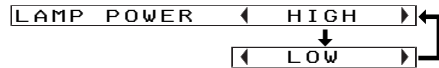

This setting changes the lamp brightness. When set to “LOW”, the luminance of the lamp is reduced, but the projector uses less power, and the operating noise is also reduced.

The LOW position is recommended for narrow rooms where a high picture luminance is not essential or for watching movies.

LAMP RUNTIME

This setting displays the usage time for the lamp unit which is currently being used.

NOTE:

- The lamp’s operating life varies depending on the usage conditions (such as the LAMP POWER setting and the number of times the power is turned on and off).

SD memory card

What is the SD memory card (option)?

The SD memory card is a semiconductor memory which at 24 mm x 32 mm x 2.1 mm is about the size of a postage stamp. It is a next-generation recording medium which can be used instead of conventional storage devices such as MDs (mini discs), CDs (compact discs) and cassette tapes. In addition, it allows data to be repeatedly recorded, played and erased. The projector can be used to play computer image files, video images (still pictures) and moving pictures using the SD memory card.

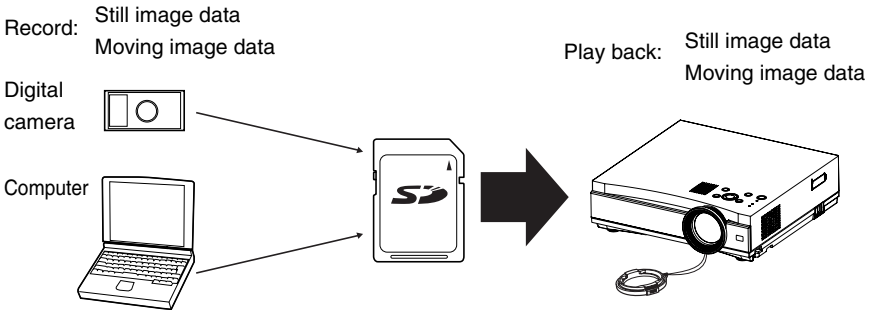

Data that can be played back

Still image data

- DCF compliant still image data (See page 64 for details on DCF compliance.)

Moving image data

- MPEG4 movie data (audio: G.726 compliant)
However, only files in ASF format can be played back.

Note when using SD memory cards

Do not turn off the projector's power or remove an SD memory card from the projector while the SD memory card is in use (while the access indicator is flashing). (See page 42.) If this is not observed, corruption of the data on the SD memory card may occur.

Inserting and removing the SD memory card

Inserting the SD memory card

Insert the SD memory card so that it is facing the correct way.

- ① Open the slot cover at the side of the projector.

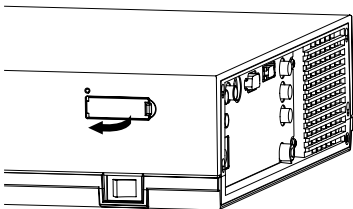

- ② Insert the SD memory card as shown in the illustration below.

Insert the SD memory card with the label side facing upward and so that the cut-away corner is inserted first. Push the SD memory card in as far as it will go.

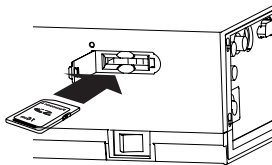

NOTE:

- If you try to force the SD memory card to go in the wrong way, it may damage the SD memory card and the card slot.

- ③ Close the slot cover.

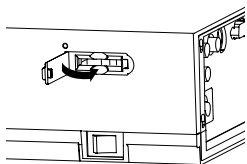

Removing the SD memory card

- ① Open the slot cover.
- ② Check that the access indicator at the upper-left corner of the card slot is not flashing (the SD memory card is not being accessed).

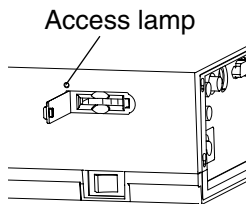

NOTE:

- Always be sure to check that the access indicator is not flashing before removing the SD memory card. If the SD memory card is removed while the access indicator is flashing, the data stored on the SD memory card may become corrupted.

- ③ Push in the middle of the SD memory card. (The SD memory card will protrude slightly.)
- ④ Remove the card.

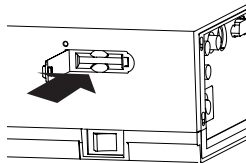

- ⑤ Close the slot cover.

About the SD menu

The still image data and moving image data that is stored on SD memory cards can be played back using the SD menu.

Displaying the SD menu

Press the SD button to change the display to the SD CARD screen.

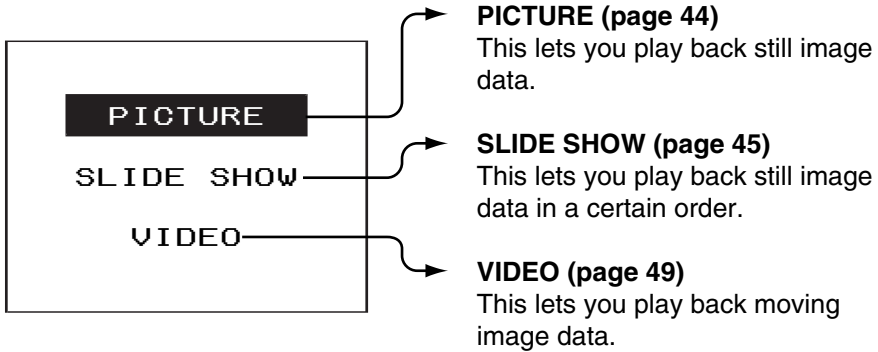

- If the SD menu is not displayed when the SD button is pressed,
—press the SD MENU button repeatedly until it is displayed or
—the previous menu screen or image on an SD CARD screen may be displayed or played back.

NOTE:

- When the SD CARD screen is selected, the SD MENU button can be used to return to a previous screen (up to the SD menu shown above).

Playing back still images

The PICTURE option lets you play back still image data.

- Use the ▲ and ▼ buttons to select “PICTURE”, and then press the ENTER button.



- If there is no still image data that can be played back, the following screen is not displayed.
- Use the ▲ and ▼ buttons to select the folder that contains the still image data that you would like to play back, and then press the ENTER button.

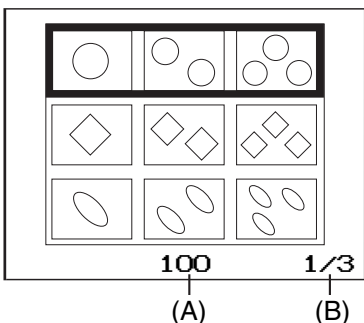

- (A) Number of selected folder
 (B) Folder number/Total number of folders

- Up to a maximum of three still images that are saved in the folder can be displayed in a single row. If there are four or more folders, use the ▲ and ▼ buttons to scroll through the pages.

- Use the ▲, ▼, ◀ and ▶ buttons to select the still image to be enlarged, and then press the ENTER button.

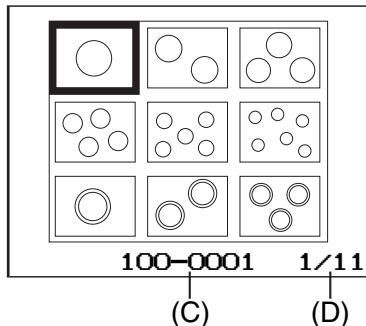

- (C) File name of selected still image
 (D) Number of selected still image/Total number of still images

- If there are 10 or more still images in a folder, use the ▲ and ▼ buttons to scroll through the pages.

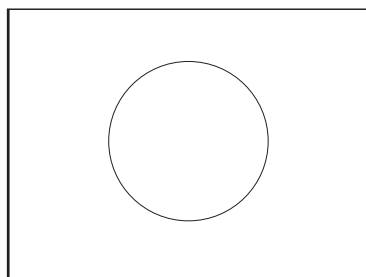

- <Button functions during still image playback>
- Play back next image ... ▶ button
 - Play back previous image ◀ button
 - Rotate images ▲ and ▼ buttons
 - Return to still image selection screen SD MENU button

Slide playback of still images

“SLIDE SHOW” lets you play back still images in a certain order using one of three available playback methods. Use the ▲ and ▼ buttons to select an item, and then press the ENTER button. Use the ◀ and ▶ buttons to change the setting for the selected item.

Use the ▲ and ▼ buttons to select “SLIDE SHOW”, and then press the ENTER button.

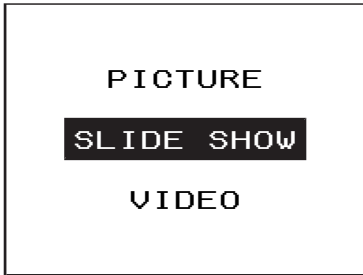

The still image that will be the first image to be played back for the selected item will be displayed.

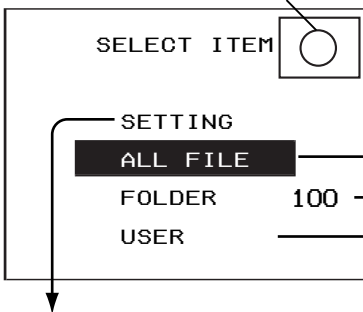

ALL FILE

If you press the ENTER button, all still images that are stored on the SD memory card are played back in order.

FOLDER

If you use the ◀ and ▶ buttons to select the folder to be played back and then press the ENTER button, all still images in the selected folder are played back in order.

USER

If the user selects the desired still images, the still images that were selected by the user can be played back in order. When using user playback, you must select the still images to be played back using the “USER” command in the “SETTING” screen. When “USER” is selected, use the ◀ and ▶ buttons to select the user settings, and then press the ENTER button to start user playback.

SETTING (page 46)

This lets you set whether the slide playback is to be automatically continuous (automatic playback) or whether it can be switched manually (manual playback), and also lets you edit the user settings for “USER”.

<Button functions during slide playback>

- **Pause/cancel automatic playback** ENTER button
- The following buttons can be used while manual playback or automatic playback is paused.
- **Play back next image** ▶ button
- **Play back previous image** ◀ button
- **Rotate images** ▲ and ▼ buttons
- **Return to still image selection screen** SD MENU button

SETTING

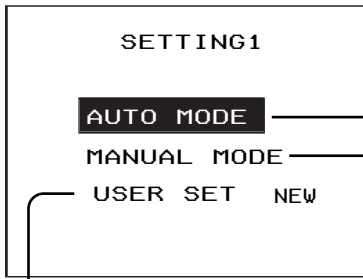

USER SET

If adding settings for a new user, use the ◀ and ▶ buttons to select “NEW” and then press the ENTER button. The user setting edit screen will then be displayed. If you would like to change the settings for an existing user, use the ◀ and ▶ buttons to select the user setting file (0 - 9) that you would like to change, and then press the ENTER button.

User setting edit screen

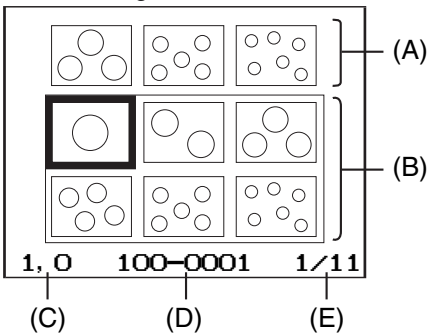

- (A) Still images set by user (this row is blank for new users)
- (B) Still images that are available for setting by the user
- (C) Playback time and rotation angle for selected still image
- (D) File name of selected still image
- (E) Number of selected still image/Total number of still images

See the next page for details on how to edit user settings.

AUTO MODE

The still images are played back automatically in order according to the following setting.

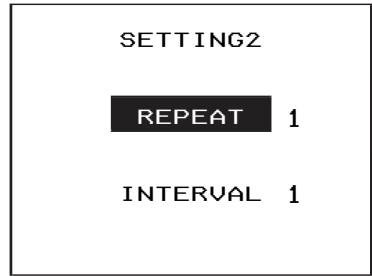

“REPEAT”

ENTER button

Use the ◀ and ▶ buttons to select how many times automatic playback is to be repeated.

“INTERVAL”

Use the ◀ and ▶ buttons to select the time interval (seconds) between playback of each still image.

* Once you have made the required settings, press the ENTER button.

MANUAL MODE

During slide playback, press the ◀ button to play back the next still image, and press the ▶ button to play back the previous still image.

NOTE:

- When editing the user settings, slide playback settings that have not been created using this projector cannot be edited.

Editing user settings

You can use the user setting edit screen that is displayed when you select “SETTING” during slide playback on the previous page to add, move and delete still images from the list of images for slide playback and also to change playback settings.

Adding and moving images

You can select still images that are saved on the SD memory card and add them to the user settings, and also change the order of the still images that have been selected in the user settings.

- ① Use the ▲, ▼, ◀ and ▶ buttons to select the still images to be added or moved, and then press the ENTER button.

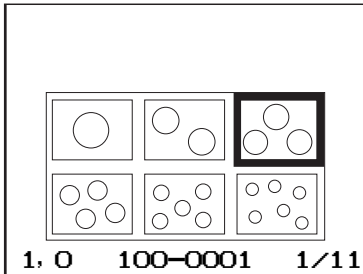

- When moving images, only images that have already been added to the user settings can be moved.
- ② Select “ADD” or “MOVE” and then press the ENTER button.



- ③ Use the ▲, ▼, ◀ and ▶ buttons to move the cursor (I) to the place where the image is to be added or moved, and then press the ENTER button.

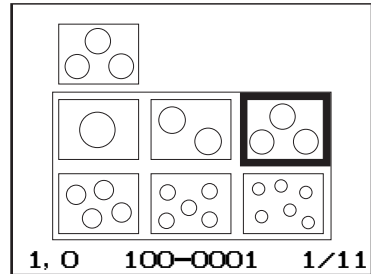
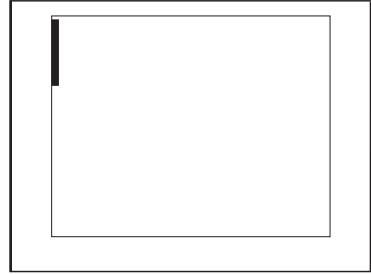

Repeat the procedure from step ① to add or move additional images.

See the following page for details on how to change settings and delete images.

SETUP

This describes how to set the playback interval and angle of rotation for still images in the user settings.

- ① Use the ▲, ▼, ◀ and ▶ buttons to select a still image from the user settings, and then press the ENTER button.
- ② Select “SETTING” and then press the ENTER button.

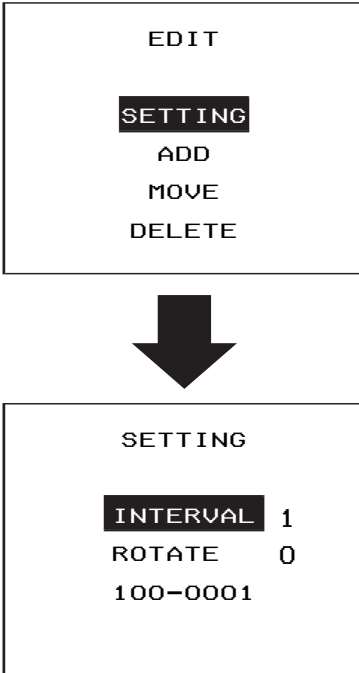

“INTERVAL”

Use the ◀ and ▶ buttons to select the time interval (seconds) between playback of each still image.

“ROTATE”

Use the ◀ and ▶ buttons to select the angle of rotation for the still image during playback. This lets you correct the position of sideways images during playback.

* Once you have made the required settings, press the ENTER button.

NOTE:

- If no setting value for the playback interval is displayed, the still images

will be played back at the interval set for automatic playback on page 46.

- The setting screen can also be displayed by selecting a still image and then pressing and holding the ENTER button for one second or more.

DELETE

This describes how to delete images from the user settings.

- ① Use the ▲, ▼, ◀ and ▶ buttons to select the still image to be deleted from the user settings, and then press the ENTER button.
- ② Select “DELETE” and then press the ENTER button.

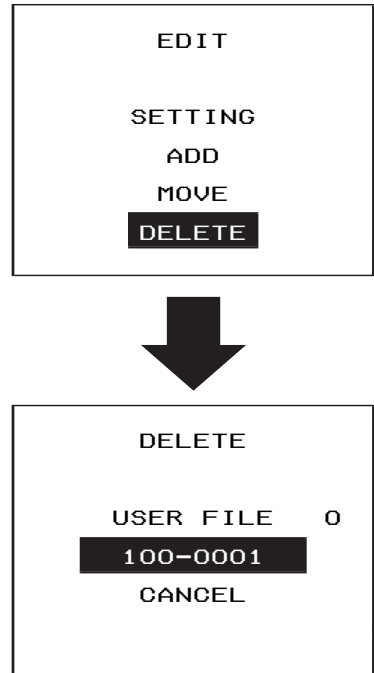

“USER FILE”

This deletes the user settings that are currently being edited.

“100-0001” (File name of selected still image)

This lets you delete only the selected still image.

“CANCEL”

This cancels the delete operation.

Playing back moving images

- ① Use the ▲ and ▼ buttons to select VIDEO and then press the ENTER button.



- If there is no moving image data that can be played back, the following screen is not displayed.

- ② Use the ▲ and ▼ buttons to select the moving image data that you would like to play back, and then press the ENTER button.

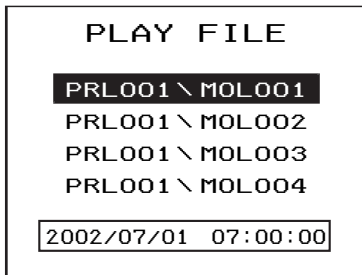

The moving image data will then be played back.

<Button functions during moving image playback>

- Fast-forward playback...▶ button
- Fast-rewind playback◀ button
- Play back next movie.....▼ button
- Play back previous movie....▲ button
- Pause/cancel pause...ENTER button
- Stop playback

...Press the ENTER button for 1 second or more

Display/hide playback time

.....SD TIME button



Playback time display

Select moving image file

.....SD MENU button

If you press the ◀ button during movie playback, then playback will start again from the beginning of the current movie.

NOTE:

- Images containing fast movement may appear to pause momentarily (frame dropout) or they may appear as mosaic patterns, but this is normal.
- If the projector has been used to enlarge the images, some movie data may appear lower in resolution, but this is normal.
- During fast-forward playback and rewind playback, each still image is played back in the same order.

Error displays

Errors may be displayed while using an SD memory card. If an error occurs, check the following table for a description of the error.

Error display	Details
NO CARD	<ul style="list-style-type: none">● There is no SD memory card inserted.
NO DATA	<ul style="list-style-type: none">● The SD memory card does not contain any data that can be played back by the projector.
UNFORMAT	<ul style="list-style-type: none">● The inserted card does not match the required specifications, for example the format is different.
DATA ERROR	<ul style="list-style-type: none">● The data is not compatible and cannot be played back.
READ ERROR	<ul style="list-style-type: none">● The data cannot be read from the card.
WRITE ERROR	<ul style="list-style-type: none">● The data could not be saved onto the card. Check if the SD memory card is write-protected, or if it has enough free space available.
ERROR	<ul style="list-style-type: none">● If “ERROR” is displayed instead of a thumbnail image, it means that the image cannot be displayed because there is no data or the data is incompatible.
?	<ul style="list-style-type: none">● If “?” is displayed instead of a thumbnail image, it means that only the thumbnail data cannot be found.
UNEXPECTED ERROR	<ul style="list-style-type: none">● An error occurred during an operation. If the problem cannot be reset by pressing the SD MENU button, turn off the projector’s power while referring to “Turning off the power” on page 23, and then turn the power back on again.

NOTE:

- Press the SD MENU button to clear an error display.
- A 2-digit error code will be displayed with an error display.
You may need the error code when asking for service.

Indicators

There are two indicators on the control panel of the projector which give information about the operating condition of the projector. These indicators illuminate or flash to warn you about problems that have occurred inside the projector, so if you notice that one of the indicators is on, turn off the power and check the table below for the cause of the problem.

TEMP indicator			
Indicator display	Illuminated (red) (Lamp unit on)	Flashing (red) (Lamp unit on)	Flashing (red) (Lamp unit off)
Problem	The surrounding temperature or the temperature inside the projector has become unusually high.	The temperature inside the projector has become dangerously high, or the temperature has suddenly changed.	The surrounding temperature or the temperature inside the projector has become dangerously high, causing the lamp unit to be automatically shut off.
Possible cause	<ul style="list-style-type: none"> ● The ventilation holes may be covered. ● The ambient temperature in the place of use may be too high. ● The air filter may be blocked. 		
Remedy	<ul style="list-style-type: none"> ● Uncover the ventilation holes. ● Set up the projector in a place where the temperature is between 0 °C (32 °F) and 40 °C (104 °F) and the humidity is between 20% and 80% (with no condensation). [If you set the FAN CONTROL to “HIGH” (page 40), set up the projector in a place where the temperature is between 0 °C (32 °F) and 35 °C (95 °F) and the humidity is between 20% and 80% (with no condensation).] ● Turn off the MAIN POWER switch by following the procedure on page 23, and then clean the air filter (refer to page 53). 		

LAMP indicator			
Indicator display	ILLuminated (red)	Flashing (red)	
Problem	It is nearly time to replace the lamp unit.	An abnormality has been detected in the lamp circuit.	
Possible cause	<ul style="list-style-type: none"> • Does “REPLACE LAMP” appear on the screen after the projector is turned on? 	<ul style="list-style-type: none"> • The power may have been turned on straight away after it was turned off. 	<ul style="list-style-type: none"> • There may be an abnormality in the lamp circuit.
Remedy	<ul style="list-style-type: none"> • This occurs when the operation time for the lamp unit is nearing 1800 hours. (when LAMP POWER has been set to “HIGH”) Ask your dealer or an Authorised Service Center to replace the lamp unit. 	<ul style="list-style-type: none"> • Wait for a while until the lamp unit cools down before turning the power back on again. 	<ul style="list-style-type: none"> • Turn off the MAIN POWER switch by following the procedure given on page 23, and then contact an Authorised Service Center.

NOTE:

- Be sure to turn off the MAIN POWER switch by following the procedure given in “Turning off the power” on page 23 before carrying out any of the procedures in the “Remedy” column.
- If the main power turns off after the TEMP indicator starts flashing, it means that an abnormality has occurred. Please contact an Authorised Service Center so that the necessary repairs can be made.

Cleaning and replacing the air filter

If the air filter becomes clogged with dust, the internal temperature of the projector will rise, the TEMP indicator will flash and the projector power will turn off. **The air filter should be cleaned every 100 hours of use,** depending on the location where the projector is being used.

Cleaning procedure

- ① **Turn off the MAIN POWER switch and disconnect the power cord plug from the wall outlet.**

Turn off the MAIN POWER switch according to the procedure given in “Turning off the power” on page 23 before disconnecting the plug from the wall outlet.

- ② **Gently turn the projector upside down.**

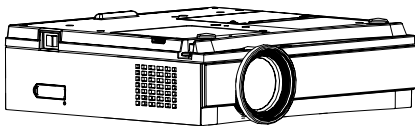

NOTE:

- Place the projector on top of a soft cloth so that it will not become scratched.

- ③ **Remove the air filter.**
Put your fingernails under the air filter and pull the air filter out of the projector.

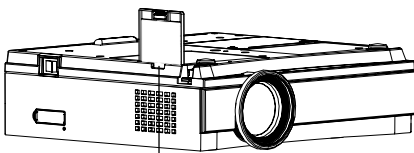

Air filter

- ④ **Clean the air filter.**

Use a vacuum cleaner to clean off any accumulated dust.



NOTE:

- Be careful not to let the air filter get sucked into the vacuum cleaner.

- ⑤ **Install the air filter.**

NOTE:

- Be sure to install the air filter cover before using the projector. If the projector is used without the air filter cover installed, dust and other foreign particles will be drawn into the projector, and malfunctions will result.
- If the dust cannot be removed by cleaning, it is time to replace the air filter. Please consult your dealer. Furthermore, if the lamp unit is being replaced, replace the air filter at this time also.

Replacing the lamp unit

Warning

The lamp unit should only be replaced by a qualified technician.

When replacing the lamp, allow it to cool for at least one hour before handling it.

- The lamp cover gets very hot, and contact with it can cause burns.

Notes on replacing the lamp unit

- The light generating lamp is made of glass, so dropping it or allowing it to hit hard objects may cause it to burst. Be careful when handling the lamp.
- After having removed the old lamp, carelessly discarding it can cause the lamp to burst. Dispose of the lamp with the same care that would be taken with a fluorescent light.
- A Phillips screwdriver is necessary for removing the lamp unit. Make sure that your hands are not slippery when using the screwdriver.

NOTE:

- The projector is not supplied with a replacement lamp unit. Please ask your dealer for details. Lamp unit product no.: **ET-LAE100**

CAUTION:

- Do not use any lamp unit other than the one with the product number indicated above.

Lamp unit replacement period



The lamp is a consumable product. Even when the full life of the bulb has not been exhausted, the brightness of the light will gradually decline. Therefore periodic replacement of the lamp is necessary.

The intended lamp replacement interval is 2000 hours, but it is possible that the lamp may need to be replaced earlier due to variables such as a particular lamp's characteristics, usage conditions and the installation environment. Early preparation for lamp replacement is encouraged.

A lamp that has exceeded 2000 hours of use has a much greater chance of exploding. In order to prevent the lamp from exploding, the lamp will be automatically shut off when 2000 hours of use have been reached.

NOTE:

- The usage hours explained above are for use when the HIGH setting has been selected for LAMP POWER in the OPTION menu. If the LOW setting is selected, the brightness of the lamp will be less and life of the lamp can be extended.
- While 2000 hours is the intended replacement interval, it is not a period of time covered by warranty.

	<p>On-screen display</p> 	<p>Lamp indicator warning light</p> 
<p>More than 1800 hours</p>	<p>Displayed for 30 seconds. Pressing any button will clear the display.</p>	<p>The lamp indicator illuminates red even if the projector is in standby mode.</p>
<p>More than 2000 hours (The lamp will turn off automatically about 10 minutes after turning on the power.)</p>	<p>This display cannot be cleared at all, no matter which button is pressed.</p>	

Lamp unit replacement procedure

NOTE:

- If the lamp usage time has passed 2000 hours (when LAMP POWER has been set to “HIGH”), the projector will switch to standby mode after approximately 10 minutes of operation. The steps ⑧ to ⑾ on the next page should thus be completed within 10 minutes.

① Turn off the MAIN POWER switch according to the procedure given in “Turning off the power” on page 23, and then disconnect the power cord plug from the wall outlet and check that the area around the lamp unit has cooled down.

② Use a Phillips screwdriver to turn the lamp unit cover fixing screws at the bottom of the projector, and then remove the lamp unit cover from the projector.

Lamp unit cover

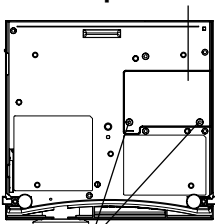

Lamp unit cover fixing screws

③ Use a Phillips screwdriver to loosen the two lamp unit fixing screws until the screws turn freely. Then hold the handle of the lamp unit and gently pull it out from the projector.

Lamp unit fixing screws

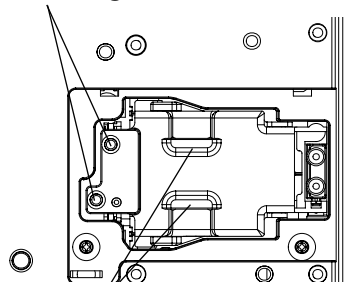

Handle

④ Insert the new lamp unit while making sure that the direction of insertion is correct, and then use a Phillips screwdriver to securely tighten the lamp unit fixing screws.

- ⑤ Install the lamp unit cover, and then use a Phillips screwdriver to securely tighten the lamp unit cover fixing screws.

NOTE:

- Be sure to install the lamp unit and the lamp unit cover securely. If they are not securely installed, it may cause the protection circuit to operate so that the power cannot be turned on.

- ⑥ Insert the power cord plug into the wall outlet and then press the MAIN POWER switch.

NOTE:

- If the POWER button on the projector does not illuminate red when the MAIN POWER switch is turned on, turn the MAIN POWER switch off again and check that the lamp unit and the lamp unit cover are securely installed. Then turn the MAIN POWER switch back on.

- ⑦ Press the POWER button so that a picture is projected onto the screen.

- ⑧ Press the MENU button to display the MAIN MENU screen, and then press the ▲ and ▼ buttons to move the cursor to select “OPTION”.

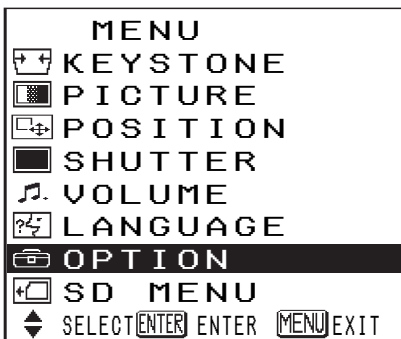

- ⑨ Press the ENTER button to display the OPTION screen, and then use the ▲ and ▼ buttons to select LAMP RUNTIME.

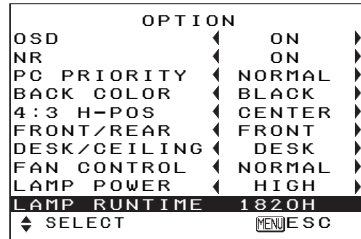

- ⑩ Press and hold the ENTER button for approximately 3 seconds.

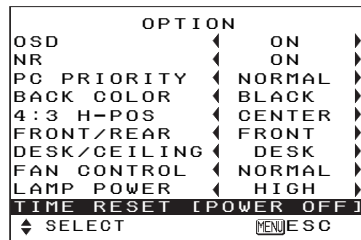

The “LAMP RUNTIME” will change to “TIME RESET [POWER OFF]”.

NOTE:

- If the MENU button is pressed, the lamp time resetting screen will be cancelled.

- ⑪ Turn off the power.

This will reset the cumulative usage time for the lamp unit to zero.

Refer to page 23 for details on how to turn off the power.

Before calling for service

Before asking for service, check the following points.

Problem	Possible cause
Power does not turn on.	<ul style="list-style-type: none"> ● The power cord may not be connected. ● The MAIN POWER switch is turned off. ● The main power supply is not being supplied to the wall outlet. ● TEMP indicator is illuminated or flashing. (Refer to page 51.) ● LAMP indicator is illuminated or flashing. (Refer to page 52.) ● The lamp unit cover has not been securely installed.
No picture appears.	<ul style="list-style-type: none"> ● The video signal input source may not be connected properly. ● The input selection setting may not be correct. (Refer to page 22.) ● The BRIGHT adjustment setting may be at the minimum possible setting. (Refer to page 34.) ● The shutter function may be in use. (Refer to page 33.)
The picture is fuzzy.	<ul style="list-style-type: none"> ● The lens cover may still be attached to the lens. ● The lens focus may not have been set correctly. (Refer to page 23.) ● The projector may not be at the correct distance from the screen. (Refer to page 21.) ● The lens may be dirty. ● The projector may be tilted too much. (Refer to page 23.)
COLOR is too light or TINT is poor	<ul style="list-style-type: none"> ● COLOR or TINT adjustment may be incorrect. (Refer to pages 34 and 35.) ● The input source which is connected to the projector may not be adjusted correctly.
No sound can be heard.	<ul style="list-style-type: none"> ● The audio signal source may not be connected properly. ● The volume adjustment may be at the lowest possible setting. (Refer to page 15.) ● Make sure that the MUTE function is not activated. (Refer to page 33.)

Problem	Possible cause
Remote control unit does not operate.	<ul style="list-style-type: none"> ● The battery may be weak. ● The battery may not be inserted correctly. (Refer to page 17.) ● The remote control signal receptor on the projector may be obstructed. (Refer to page 17.) ● The remote control unit may be out of the operation range. (Refer to page 17.)
The picture does not display correctly.	<ul style="list-style-type: none"> ● The correct input signal may not be selected. (Refer to page 22.) ● The signal format (TV system) may not be set correctly. (Refer to page 35.) ● There may be a problem with the video tape or other signal source. ● A signal which is not compatible with the projector may be being input. (Refer to page 61.)
Picture from computer does not appear	<ul style="list-style-type: none"> ● The cable may be too long. ● The external video output for the laptop computer may not be set correctly. (You may be able to change the external output settings by pressing the [Fn]+[F3] or [Fn]+[F10] keys simultaneously. The actual method varies depending on the type of computer, so refer to the documentation provided with your computer for further details.)

Specifications

Power supply:	100 V–240 V ~, 50 Hz/60 Hz
Power consumption:	180 W (During standby (when fan is stopped): Approx. 1.5 W)
Amps:	2.2 A–0.8 A
LCD panel:	
Panel size (diagonal):	0.7 type (17.78 mm)
Aspect ratio:	16:9
Display method:	3 transparent LCD panels (RGB)
Drive method:	Active matrix method
Pixels:	
PT-L300U:	518 400 (960 x 540) x 3 panels
PT-L200U:	415 272 (858 x 484) x 3 panels
Lens:	Manual zoom (1 - 1.2) / focus lens F 2.0 - 2.3, f 22.0 mm - 26.2 mm UHM lamp (120 W)
Lamp:	
Luminosity:	
PT-L300U:	800 lm (ANSI)
PT-L200U:	700 lm (ANSI)
Scanning frequency:	(for RGB signals):
Horizontal scanning frequency:	30 kHz–70 kHz
Vertical scanning frequency:	50 Hz–87 Hz
Dot clock frequency:	Less than 100 MHz
YPbPr signals:	525i (480i), 625i, 525p (480p), 750p (720p), 1125i (1080i)
Color system:	7 (NTSC/NTSC 4.43/PAL/PAL-M/PAL-N/PAL60/SECAM)
Projection size:	1016 mm - 5080 mm (40" - 200")
Throw distance:	1.2 m - 7.4 m (3'11" - 24'3")
Optical axis shift:	17:1 (fixed)
Screen aspect ratio:	16:9
Installation:	Front/Rear/Ceiling/Desk (Menu selection method)
Speaker:	4 cm x 3 cm oval x 1
Max. useable volume output:	2 W (mono)
Connectors	
VIDEO IN:	
S2 VIDEO:	Single-line, Mini DIN 4-pin Y 1.0 V [p-p], C 0.286 V [p-p], 75 Ω
VIDEO:	Single-line, RCA pin jack 1.0 V [p-p], 75 Ω
PC IN:	
RGB:	Single-line D-SUB HD 15-pin (female)
R.G.B.:	0.7 V [p-p], 75 Ω
G.SYNC:	1.0 V [p-p], 75 Ω
HD/SYNC:	TTL high impedance, automatic plus/minus polarity compatible
VD:	TTL high impedance, automatic

	plus/minus polarity compatible
COMPONENT IN:	
Y:	1.0 V [p-p], 75 Ω
PB,PR (CB,CR):	0.7 V [p-p], 75 Ω
DVI-D IN (PT-L300U only):	Single-line, DVI-D, 24-pin
AUDIO IN:	Single-line 0.5 V [rms], RCA pin jack x2 (L-R)
SD memory card slot:	For SD memory cards Compatible with DCF-standard still image data Compatible with MPEG4 moving picture data (audio: G.726 compliant) Moulded plastic (ABS/PC)
Cabinet:	
Dimensions:	
Width:	280 mm (11")
Height:	85.2 mm (3-11/32")
Length: PT-L300U	279.7 mm (11") (including lens)
PT-L200U	278.5 mm (10-15/16") (including lens)
Weight:	2.9 kg (6.4 lbs.)
Operating environment:	
Temperature:	0 °C–40 °C (32 °F–104 °F) [When the FAN CONTROL is set to "HIGH" (page 40); 0 °C–35 °C (32 °F–95 °F)]
Humidity:	20%–80% (no condensation)
Certifications:	UL60950, C-UL FCC Class B
<Remote control unit>	
Power supply:	3 V DC (AAA battery x2)
Operating range:	Approx. 7 m (23') (when operated directly in front of signal receptor)
Weight:	73.5 g (2.6 ozs.) (including battery)
Dimensions:	
Width:	43 mm (1-11/16")
Height:	22.3 mm (7/8")
Length:	135 mm (5-5/16")
<Options>	
Ceiling bracket	ET-PKE300
Projection Screen	ET-SR90CT(width: 1 800 mm(70')) ET-SR70CT(width: 1 400 mm(55'))

*Specifications are subject to change without notice.

Appendix

List of compatible signals

Mode	Display resolution (dots)*1	Scanning frequency		Dot clock frequency (MHz)	Picture quality*2		Format
		H (kHz)	V (Hz)		L300	L200	
NTSC/M-NTSC/PAL-M/PAL60	720 x 480i	15.734	59.940		A	A	Video/S-Video
PAL/PAL-N/SECAM	720 x 576i	15.625	50.000		AA	A	Video/S-Video
525i	720 x 480i	15.734	59.940	13.500	A	A	YPbPr
625i	720 x 576i	15.625	50.000	13.500	AA	A	YPbPr
525p	720 x 483	31.469	59.940	27.000	A	A	YPbPr
HDTV60	1 920 x 1 080i	33.750	60.000	74.250	AA	A	YPbPr/PC
HDTV50	1 920 x 1 080i	28.125	50.000	74.250	AA	A	YPbPr/PC
750P	1 280 x 720	45.000	60.000	74.250	A	A	YPbPr
VGA400	640 x 400	31.469	70.086	25.175	A	A	PC
	640 x 400	37.861	85.081	31.500	A	A	PC
VGA480	640 x 480	31.469	59.940	25.175	A	AA	PC/DV1
	640 x 480	35.000	66.667	30.240	A	AA	PC
	640 x 480	37.861	72.809	31.500	A	AA	PC
	640 x 480	37.500	75.000	31.500	A	AA	PC
	640 x 480	43.269	85.008	36.000	A	AA	PC
WIDE400	720 x 400	37.927	85.038	35.500	A	A	PC
WIDE480	856 x 480	30.057	60.114	31.500	A	AA	PC/DV1
SVGA	800 x 600	35.156	56.250	36.000	A	A	PC
	800 x 600	37.879	60.317	40.000	A	A	PC/DV1
	800 x 600	48.077	72.188	50.000	A	A	PC
	800 x 600	46.875	75.000	49.500	A	A	PC
	800 x 600	53.674	85.061	56.250	A	A	PC
MAC16	832 x 624	49.725	74.550	57.283	A	A	PC
WIDE600	1 072 x 600	37.287	59.947	51.382	A	A	PC/DV1
WIDE720	1 280 x 720	45.106	60.141	76.500	A	A	PC
XGA	1 024 x 768	48.363	60.004	65.000	A	A	PC/DV1
	1 024 x 768	56.476	70.069	75.000	A	A	PC
	1 024 x 768	60.023	75.029	78.750	A	A	PC
	1 024 x 768	68.678	84.997	94.500	A	A	PC
	1 024 x 768i	35.520	86.952	44.897	A	A	PC
WIDE768	1 280 x 768	45.327	56.518	76.150	A	A	PC/DV1
MXGA	1 152 x 864	63.995	71.184	94.200	A	A	PC
	1 152 x 864	67.500	74.917	108.000	B	B	PC
MAC21	1 152 x 870	68.681	75.062	100.000	B	B	PC

*1 The “i” appearing after the resolution indicates an interlaced signal.

*2 The following symbols are used to indicate picture quality.

AA Maximum picture quality can be obtained.

A Signals are converted by the image processing circuit before picture is projected

B Some loss of data occurs to make projection easier.

Connector pin wiring

- The pin layout and signal names for the S2 VIDEO input connector are shown below.

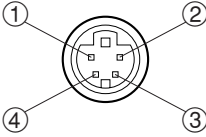

External view

Pin No.	Signal
①	Earth (Luminance signal)
②	Earth (Color signal)
③	Luminance signal
④	Color signal

- The pin layout and signal names for the RGB input connector are shown below.

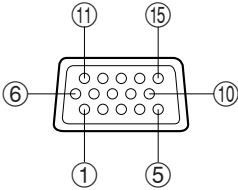

External view

Pin No.	Signal
①	R
②	G/G-SYNC
③	B
⑫	SDA
⑬	HD/SYNC
⑭	VD
⑮	SCL

Pin ⑨ is spare.

Pins ④—⑧, ⑩ and ⑪ are for earth.

Pins ⑫ and ⑮ functions are only valid when supported by the computer

- The pin assignments on the DVI-D input connector are as follows (interface with TMDS connector on a personal computer)

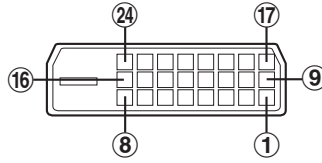

View from mating side

Pin No.	Signal	Pin No.	Signal
①	T.M.D.S data 2-	⑬	T.M.D.S data 3+
②	T T.M.D.S data 2+	⑭	+5 V
③	T.M.D.S data 2/4 shield	⑮	Ground
④	T.M.D.S data 4-	⑯	Hot plug sense
⑤	T.M.D.S data 4+	⑰	T.M.D.S data 0-
⑥	DDC clock	⑱	T.M.D.S data 0+
⑦	DDC data	⑲	T.M.D.S data 0/5 shield
⑧	—	⑳	T.M.D.S data 5-
⑨	T.M.D.S data 1-	㉑	T.M.D.S data 5+
⑩	T.M.D.S data 1+	㉒	T.M.D.S clock shield
⑪	T.M.D.S data 1/3 shield	㉓	T.M.D.S clock+
⑫	T.M.D.S data 3-	㉔	T.M.D.S clock-

Projection dimensions calculation methods

The following methods will allow you to calculate dimensions such as screen diagonal length and projection distances. Units in all calculations are metre.

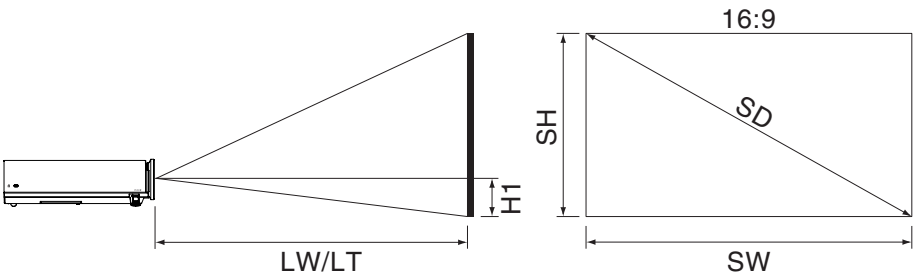

Screen Width: $SW=SD \times 0.872$

Screen Height: $SH=SD \times 0.490$

Minimum Projection Distance: $LW=1.229 \times SD - 0.0381$

Maximum Projection Distance: $LT=1.481 \times SD - 0.0381$

Image Lower Edge from Lens Center: $H1=SW/32$

DCF standard

This projector can only play back image files which comply with the DCF specification. The DCF specification imposes the following conditions. Image files or folders which do not conform to these conditions cannot be recognised by the projector.

Limits on folder names

Folders must be created as sub-folders of the DCIM folder on the SD memory card.

- Data which is contained within any folder other than the DCIM folder cannot be recognised.

Folder names must consist of three numerals (folder number) followed by five alphanumeric characters. (Example: 100abcde)

- The three numerals must make up a number between 100 and 999, and the alphanumeric characters can be taken from the following set of 37 characters: 0123456789abcdefghijklmnopqrstuvwxyz_ (No distinction is made between upper-case and lower-case alphabetic characters. Doublebyte characters cannot be used.)

Multiple folders using the same three-digit combination (folder number) cannot be created.

- For example, if two folders exist named "100abcde" and "100fghij" respectively, the projector will not recognise them.

Folder sub-hierarchies are not supported.

- For example, if a folder called "323fghij" is created as a sub-folder of the "102abcde" folder, the projector will not be able to recognise the sub-folder.

File names

File names must consist of four alphanumeric characters followed by four numerals (file number), followed by ".jpg". (Example: abcd0001.jpg)

- The four numerals must make up a number between 0001 and 9999, and the alphanumeric characters can be taken from the following set of 37 characters: 0123456789abcdefghijklmnopqrstuvwxyz_ (No distinction is made between upper-case and lower-case alphabetic characters. Doublebyte characters cannot be used.)

Multiple file names using the same four-digit combination (file number) cannot be created.

- For example, if two files exist named "abcd0001.jpg" and "efgh0001.jpg" respectively, the projector cannot recognise them normally.

File format

- Only JPEG image files which comply with the Exif 2.2 standard are recognised.

Dimensions

<Units: mm (")>

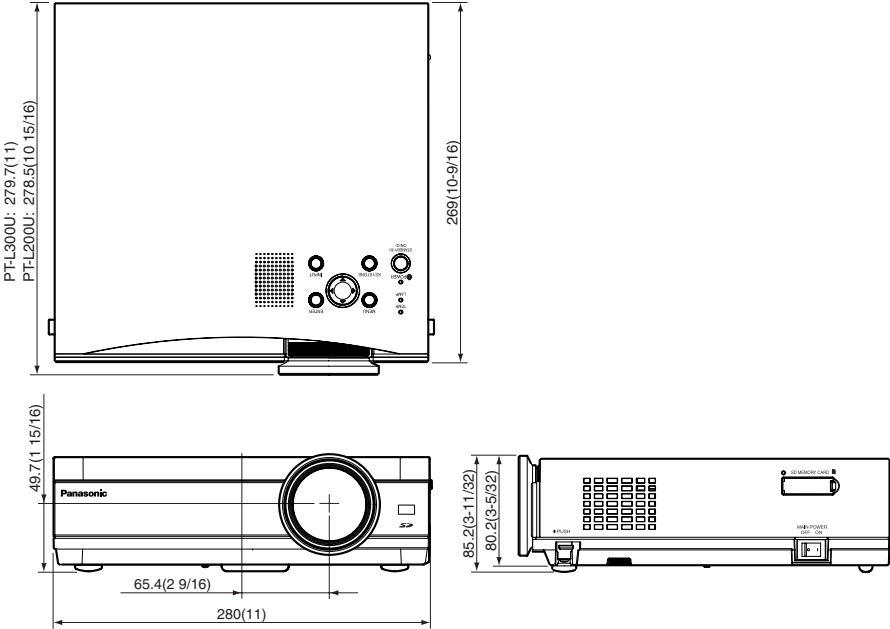

Trademark acknowledgements

- The SD logo is a trademark.
- VGA and XGA are trademarks of International Business Machines Corporation.
- Macintosh is a registered trademark of Apple Computer, Inc.
- S-VGA is a registered trademark of the Video Electronics Standards Association.

All other trademarks are the property of the various trademark owners.

NOTES IMPORTANTES CONCERNANT LA SÉCURITÉ

AVERTISSEMENT: POUR REDUIRE LES RISQUES DE FEU OU DE CHOC ÉLECTRIQUE, NE PAS EXPOSER CE PRODUIT À L'EAU OU À L'HUMIDITÉ

Alimentation: Ce projecteur LCD est conçu pour fonctionner sur secteur de 100 V - 240 V, 50 Hz/60 Hz seulement.

ATTENTION: Le cordon d'alimentation secteur fourni avec le projecteur peut être utilisé uniquement pour une alimentation électrique de 125 V, 7 A maximum. Si on veut l'utiliser avec une tension ou un courant plus forts, on doit se procurer un autre cordon d'alimentation de 250 V. Si on utilise le cordon fourni sous ces conditions, risque de provoquer un incendie.



WARNING
RISK OF ELECTRIC
SHOCK. DO NOT OPEN



MISE EN GARDE-RISQUE DE CHOC ÉLECTRIQUE.
NE PAS OUVRIR.
WARNUNG- ZUR VERMEIDUNG EINES ELEKTRISCHEN
SCHLAGES GERÄT NICHT ÖFFNEN.



Le symbole de la flèche en forme d'éclair, dans un triangle, avertit l'utilisateur de la présence de "tensions dangereuses" à l'intérieur du produit qui peuvent être de force suffisante pour constituer un risque de choc électrique aux personnes.



Le point d'exclamation dans un triangle avertit l'utilisateur de la présence d'instructions importantes concernant l'utilisation et l'entretien (réparation) dans la littérature accompagnant le produit.

ATTENTION: Cet appareil est équipé d'une fiche de courant à trois broches avec mise à la terre. Ne pas retirer la broche de mise à la masse de la fiche.

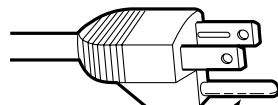

Ne pas retirer

Cette fiche ne pourra être utilisée que dans une prise avec mise à la terre. Ceci est une précaution sécuritaire. S'il est impossible d'insérer la fiche dans la prise, s'adresser à un électricien. Ne pas annuler la protection de la fiche à mise à la terre.

Précautions concernant la sécurité

AVERTISSEMENT

En cas de problème (pas d'image ou de son), ou si le projecteur dégage de la fumée ou une odeur étrange, éteindre l'appareil et débrancher immédiatement la fiche d'alimentation de la prise de courant.

- Ne pas continuer d'utiliser le projecteur dans ces cas, autrement cela peut entraîner un incendie ou des chocs électriques.
- Après s'être assuré que de la fumée ne se dégage plus, s'adresser à un centre technique agréé et demander que les réparations nécessaires soient faites.
- Le fait de réparer le projecteur soi-même est très dangereux, et ne doit jamais être fait.

Ne pas regarder directement dans la lentille pendant que le projecteur fonctionne.

- Une lumière intense est émise par la lentille du projecteur. Si l'on regarde directement dans cette lumière, elle risque de causer des blessures et de graves lésions aux yeux.
- Veiller particulièrement à ce que les enfants ne regardent pas dans l'objectif.
En outre, éteindre le projecteur si on le laisse sans surveillance.

Ne pas installer ce projecteur dans un endroit qui n'est pas assez résistant pour supporter le poids du projecteur.

- Si l'emplacement d'installation n'est pas assez résistant, le projecteur risque de tomber et causer de graves blessures et (ou) des dommages.

Demander à un technicien qualifié d'installer le projecteur par exemple s'il est installé au plafond.

- Si l'installation n'est pas faite correctement, cela peut entraîner des blessures ou des chocs électriques.

Si de l'eau ou des objets étrangers entrent dans le projecteur, si le projecteur tombe, ou si le boîtier est endommagé, éteindre l'appareil et débrancher immédiatement la fiche d'alimentation de la prise de courant.

- Si l'on continue d'utiliser le projecteur dans cette condition, cela peut entraîner un incendie ou des chocs électriques.
- S'adresser à un centre technique agréé pour que les réparations nécessaires puissent être faites.

Ne pas surcharger la prise de courant.

- Si l'alimentation est surchargée (par exemple, par l'utilisation de trop d'adaptateurs), cela risque de faire surchauffer le projecteur et peut entraîner un incendie.

Ne pas retirer le capot ou le modifier.

- Des hautes tensions qui peuvent causer de graves blessures sont

présentes à l'intérieur du projecteur.

- Pour toute inspection, réglage ou réparation, s'adresser à un centre technique agréé.

Nettoyer la fiche du cordon d'alimentation régulièrement afin d'éviter toute accumulation de poussière.

- Si de la poussière s'accumule sur la fiche du cordon d'alimentation, l'humidité peut endommager l'isolant et entraîner un incendie. Débrancher le cordon d'alimentation de la prise de courant et l'essuyer avec un chiffon sec.
- Si le projecteur n'est pas utilisé pendant une période prolongée, débrancher le cordon d'alimentation de la prise de courant.

Faire attention de ne pas endommager le cordon d'alimentation.

- Ne pas endommager le cordon d'alimentation, ne pas le modifier, ne pas placer sous des objets lourds, ne pas le chauffer, ne pas le placer près d'objets chauffants, ne pas le tordre, ne pas le plier ou le tirer excessivement et ne pas le rouler en boule.
- Si le cordon d'alimentation est endommagé, cela peut entraîner un incendie et des chocs électriques.
- Si le cordon d'alimentation est endommagé, le faire réparer par un centre technique agréé.

Ne pas manipuler le cordon d'alimentation avec les mains mouillées.

- Cela peut entraîner des chocs électriques.

Brancher la fiche du cordon d'alimentation fermement dans la prise de courant.

- Si la fiche n'est pas complètement insérée, cela peut entraîner des chocs électriques ou la faire surchauffer.
- Si la fiche est endommagée ou la plaque de la prise est desserrée, elles ne devraient pas être utilisées.

Ne pas placer le projecteur sur des surfaces instables.

- Si le projecteur est placé sur une surface qui est inclinée ou instable, il risque de tomber ou de se renverser et cela peut causer des blessures ou des dommages.

Ne pas placer le projecteur dans l'eau ou ne pas le laisser se mouiller.

- Sinon cela peut causer un incendie ou des chocs électriques.

Ne pas placer des récipients de liquide sur le projecteur.

- Si de l'eau se renverse sur le projecteur, s'adresser à un centre technique agréé.
- Si de l'eau entre à l'intérieur du projecteur, entrer en contact avec un centre technique agréé.

Ne pas mettre d'objets étrangers dans le projecteur.

- Ne pas insérer d'objets métalliques ou inflammables dans les orifices de ventilation ou les faire tomber sur le projecteur, car cela peut causer un

incendie ou des chocs électriques.

Ne pas laisser les bornes + et - de la pile entrer en contact avec des objets métalliques tels que des colliers ou des épingles à cheveux.

- Cela peut faire que la pile fuit, surchauffe, éclate ou prenne feu.
- Garder la pile dans un sachet en plastique et la maintenir éloignée des objets métalliques.

Pendant un orage, ne pas toucher le projecteur ou le câble.

- Il y a risque d'électrocution.

Ne pas utiliser l'appareil dans un bain ou une douche.

- Il y a risque d'incendie ou d'électrocution.

Ne pas placer ses mains ou autres objets près de la sortie d'air.

- De l'air chaud sort par l'ouverture de sortie d'air. Ne pas placer les mains ou la figure, ou d'autres objets qui ne peuvent résister à la chaleur près de cette sortie d'air, sinon cela peut causer des blessures ou des dommages.

Le remplacement de l'unité de lampe ne devrait être effectué que par un technicien qualifié.

- L'unité de lampe a une pression interne élevée. Elle peut facilement s'endommager si cognée contre des objets durs ou si elle tombe, cela peut causer des blessures ou des mauvais fonctionnements.

Lors du remplacement de la lampe, la laisser refroidir pendant au moins une heure avant de la manipuler.

- Le couvercle de la lampe devient très chaud, et on risque de se brûler si on le touche.

Avant de remplacer la lampe, veiller à débrancher le cordon d'alimentation de la prise de courant.

- Il y a risque d'électrocution ou d'explosion.

Attention

Ne pas obstruer les orifices d'entrée et de sortie d'air.

- Cela risque de faire surchauffer le projecteur, et causer un incendie ou endommager le projecteur.

Ne pas installer le projecteur dans des endroits humides ou poussiéreux ou dans des endroits où le projecteur peut entrer en contact avec de la fumée ou la vapeur.

- L'utilisation du projecteur dans de telles conditions peut causer un incendie ou des chocs électriques.

Pour débrancher le cordon d'alimentation, tenir la fiche et non pas le cordon.

- Si le cordon d'alimentation est tiré, le cordon sera endommagé et cela peut causer un incendie, des courts-circuits ou des chocs électriques sérieux.

Débrancher toujours tous les câbles avant de déplacer le projecteur.

- Le fait de déplacer le projecteur avec des câbles branchés peut endommager les câbles, ce qui pourraient causer un incendie ou des chocs électriques.

Ne pas placer d'objets lourds sur le projecteur.

- Cela peut déséquilibrer le projecteur et le faire tomber, ce qui peut entraîner des dommages ou des blessures.

Ne pas court-circuiter, chauffer ou démonter la pile et ne pas la placer dans l'eau ou le feu.

- Cela peut faire que la pile fuit, surchauffe, éclate ou prenne feu et causer des brûlures ou autres blessures.

Lors de l'insertion de la pile, s'assurer que les polarités (+ et -) sont correctes.

- Si la pile est insérée incorrectement, elle peut éclater ou fuir et cela peut causer un incendie, des blessures ou la contamination du compartiment des piles.

N'utiliser que la pile indiquée.

- Si une pile incorrecte est utilisée, elle peut éclater ou fuir et cela peut causer un incendie, des blessures ou la contamination du compartiment des piles.

Ne pas mélanger des piles usées et des piles neuves.

- Si l'on insère les piles incorrectement, elles risqueront d'exploser ou de fuir, ce qui peut causer un incendie, des blessures ou une contamination du logement des piles et de la zone environnante.

Ne pas peser de tout son poids sur ce projecteur.

- On risque de tomber ou de casser l'appareil, ce qui peut causer des blessures.
- Veiller tout particulièrement à ce que des enfants ne montent pas sur l'appareil.

Débrancher la fiche du cordon d'alimentation de la prise de courant comme mesure de sécurité avant d'effectuer tout nettoyage.

- Sinon cela peut causer des chocs électriques.

Demander à un centre technique agréé de nettoyer l'intérieur du projecteur au moins une fois par an.

- S'il n'est pas nettoyé et que la poussière s'accumule à l'intérieur du projecteur, cela peut causer un incendie ou des problèmes de fonctionnement.
- Il est recommandé de nettoyer l'intérieur du projecteur avant que la saison humide n'arrive. Demander au centre technique agréé plus proche de nettoyer le projecteur lorsque cela est requis. Se renseigner auprès du centre technique agréé pour le coût du nettoyage.

Nous faisons tous les efforts possibles afin de préserver l'environnement. Prière d'apporter l'appareil, s'il n'est pas réparable, à votre revendeur ou à un centre de recyclage.

Précautions concernant la manipulation

Précautions à prendre lors du déplacement du projecteur

Veiller à bien mettre le capuchon d'objectif en place avant de déplacer le projecteur.

L'objectif de projection est très sensible aux vibrations et aux chocs. Lorsqu'on déplace le projecteur, utiliser la sacoche de transport fournie. Lorsqu'on place le projecteur dans la sacoche de transport, le placer de façon que l'objectif soit orienté vers le haut.

Avertissements concernant l'installation

Toujours observer les points suivants lors de l'installation du projecteur.

Éviter de l'installer dans les endroits sujets à des vibrations ou à des chocs.

Si le projecteur est installé dans les endroits sujets à de fortes vibrations, comme près d'un moteur, ou s'il est installé à l'intérieur d'un véhicule ou à bord d'un bateau, le projecteur peut être soumis à une vibration ou à des chocs qui peuvent endommager les pièces internes et causer des mauvais fonctionnements ou des accidents. Dès lors, installer le projecteur dans un endroit qui n'est pas soumis à des vibrations ou des chocs.

Ne pas installer le projecteur près de lignes d'alimentation électrique à haute tension ou de moteurs.

Le projecteur peut être sujet à une interférence électromagnétique s'il est installé près de lignes d'alimentation électrique à haute tension ou de moteurs.

Si le projecteur est installé au plafond, demander à un technicien qualifié de faire tous les travaux d'installation.

Si le projecteur doit être suspendu au plafond, il faut acheter le kit d'installation séparé (numéro de modèle: ET-PKE300). De plus, tous les travaux d'installation ne devraient être faits que par un technicien qualifié.

Si l'on utilise ce projecteur à un endroit élevé (au-dessus de 1400 m), régler le VENTILATEUR à HAUTE. (Se référer à la page 40.)

Sinon, des anomalies pourront se produire.

Notes sur l'utilisation

Afin d'obtenir la meilleure qualité d'image

Si la lumière extérieure ou la lumière des lampes intérieures brille sur l'écran, les images projetées n'auront pas un bon contraste. Tirer les rideaux ou les stores de toutes les fenêtres et éteindre toutes les lumières fluorescentes près de l'écran pour empêcher la réflexion.

Ne pas toucher aux surfaces de la lentille avec les mains nues.

Si la surface de la lentille est salie par des empreintes digitales ou autre, ceci sera agrandi et projeté sur l'écran. D'ailleurs, lorsque le projecteur n'est pas utilisé, rétracter la lentille, puis la couvrir à l'aide du capuchon d'objectif fourni.

À propos de la fente de carte mémoire SD

S'assurer qu'il n'y ait aucun objet étranger dans la fente lorsqu'on insère une carte mémoire SD en option. Ces objets risqueraient d'endommager la carte et la fente.

À propos de l'écran

Si l'écran utilisé est sale, endommagé ou décoloré, des projections de bonne qualité ne peuvent pas être obtenues. N'appliquer aucune substance volatile à l'écran et ne pas le laisser se salir ou s'endommager.

A propos de la lampe

Il est possible qu'il faille remplacer la lampe plus tôt en raison de facteurs variables tels que des caractéristiques de la lampe, des conditions d'utilisation et un environnement d'installation particuliers, en particulier si elle est utilisée de façon continue pendant plus de 10 heures.

À propos de l'affichage à cristaux liquides

L'affichage à cristaux liquides du projecteur est fabriqué en utilisant une technologie de très haute précision permettant d'obtenir des images très détaillées. Parfois, il est possible que des pixels non actifs apparaissent sur l'écran sous forme de points fixes bleus, verts ou rouges.

Bien noter que ceci n'affecte pas le fonctionnement du LCD.

Avant de faire le nettoyage et l'entretien, s'assurer de débrancher la fiche du cordon d'alimentation de la prise de courant.

Essuyer le boîtier avec un tissu doux et sec.

Si le boîtier est très sale, imbiber le chiffon dans de l'eau avec un peu de détergent neutre, bien essorer le chiffon, puis essuyer le boîtier. Après le nettoyage, sécher le boîtier à l'aide d'un chiffon sec.

Si un chiffon traité chimiquement est utilisé, lire les directives fournies avec le chiffon avant de l'utiliser.

Ne pas essuyer la lentille avec un chiffon poussiéreux ou pelucheux.

Si de la poussière ou de la peluche se dépose sur la lentille, elle sera agrandie et projetée sur l'écran. Utiliser une poire à air pour nettoyer toute poussière et peluche de sur la surface de la lentille, ou utiliser un chiffon doux pour retirer toute poussière ou peluche.

Remplacement du bloc de lampe

AVERTISSEMENT

Le bloc de lampe ne devrait être remplacé que par un technicien qualifié.

Lors du remplacement de la lampe, la laisser refroidir pendant au moins une heure avant de la manipuler.

- Le couvercle de la lampe devient très chaud, et on risque de se brûler si on le touche.

Notes sur le remplacement du bloc de lampe

- Faire très attention en manipulant le bloc de lampe retiré, car il contient du gaz sous haute pression et peut facilement s'endommager s'il est cogné contre des objets durs ou s'il tombe.
- La lampe produisant la lumière est en verre; elle risque donc d'éclater si on la laisse tomber ou si elle heurte des objets durs. Faire bien attention en manipulant la lampe.
- La lampe usagée qu'on a retirée risque d'éclater si on la jette sans prendre de précautions. Jeter la lampe de la même manière qu'une lampe fluorescente.

REMARQUE:

- Le projecteur n'est pas fourni avec un bloc de lampe de rechange. Demander les détails au revendeur. Numéro de produit du bloc de lampe: **ET-LAE100**

ATTENTION:

- Ne pas utiliser un bloc de lampe avec un numéro de pièce autre que celui indiqué ci-dessus.



Période de remplacement du bloc de lampe

La lampe est un produit qui doit être remplacé. Même si la durée de vie complète de l'ampoule n'est pas encore épuisée, la luminosité de la lampe diminuera progressivement. Il faut donc remplacer périodiquement la lampe.

L'intervalle de remplacement de la lampe prévu est de 2000 heures; il est toutefois possible qu'il faille remplacer la lampe avant ce délai en raison d'éléments variables tels que les caractéristiques particulières de la lampe, les conditions d'utilisation et l'environnement d'installation. Il est recommandé de toujours avoir un bloc de lampe de rechange prêt à l'emploi. Une lampe qui a dépassé la limite de 2000 heures d'utilisation risque beaucoup plus d'exploser. Afin d'éviter que la lampe explose, celle-ci est éteinte automatiquement lorsque la limite de 2000 heures d'utilisation est atteinte.

REMARQUE:

- Les heures d'utilisation expliquées ci-dessus concernent l'utilisation effectuée lorsque le réglage **CHAUDE** a été sélectionné pour **PUIS LAMPE** dans le menu **OPTION**. Si le réglage **FROIDE** est sélectionné, la luminosité de la lampe sera moindre et la durée de vie de la lampe sera allongée.
- Bien que le délai de 2000 heures soit l'intervalle de remplacement prévu, l'obtention de cette durée n'est pas couverte par la garantie.

	Affichage à l'écran 	Témoin d'alarme de l'indicateur de la lampe 
Plus de 1800 heures	Affiché pendant 30 secondes. L'affichage disparaît si l'on appuie sur n'importe quelle touche.	Le témoin s'allume en rouge même si le projecteur est en mode d'attente.
Plus de 2000 heures (Le témoin s'éteint automatiquement environ dix minutes après qu'on ait allumé l'appareil.)	L'affichage ne peut pas être effacé, quelle que soit la touche sur laquelle on appuie.	

Méthode de remplacement du bloc de lampe

REMARQUE:

- Si le temps d'utilisation de la lampe a dépassé 2000 heures (lorsque PUIS LAMPE a été mis sur "CHAUDE"), le projecteur passe en mode d'attente après environ dix minutes de fonctionnement. Dès lors, faire les étapes ⑧ à ⑪ à la page suivante dans les 10 minutes.

- ① Mettre hors circuit l'interrupteur d'alimentation principale (MAIN POWER) suivant la méthode donnée dans "Mise hors circuit de l'alimentation" à la page 23, puis débrancher la fiche du cordon d'alimentation de la prise de courant et vérifier que les pièces autour du bloc de lampe se sont refroidies.
- ② Utiliser un tournevis Phillips pour desserrer les vis de fixation du couvercle du bloc de lampe sur le fond du projecteur, puis enlever le couvercle du bloc de lampe.

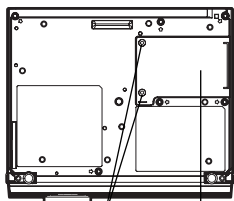

Vis de fixation du couvercle du bloc de lampe

Couvercle de l'unité de lampe

- ③ Utiliser un tournevis Phillips pour desserrer les deux vis de fixation du bloc de lampe jusqu'à ce que les vis tournent librement. Tenir la poignée du bloc de lampe et tirer doucement pour le sortir du projecteur.

Vis de fixation du bloc de lampe

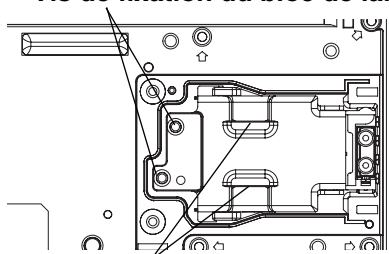

Poignée

- ④ Insérer le nouveau bloc de lampe tout en s'assurant que la direction de l'insertion est correcte, puis utiliser un tournevis Phillips pour resserrer fermement les vis de fixation du bloc de lampe.

- ⑤ Installer le couvercle du bloc de lampe, puis utiliser un tournevis Phillips pour resserrer fermement les vis de fixation du couvercle du bloc de lampe.

REMARQUE:

- S'assurer de bien installer le bloc de lampe et le couvercle du bloc de lampe. S'ils ne sont pas bien installés, cela peut déclencher le circuit de protection et le projecteur ne pourra pas être allumé.

- ⑥ Insérer la fiche du cordon d'alimentation dans la prise de courant, puis appuyer sur l'interrupteur d'alimentation principale (MAIN POWER).

REMARQUE:

- Si la touche d'alimentation (POWER) sur le projecteur ne s'allume pas en rouge quand l'interrupteur d'alimentation principale (MAIN POWER) est mis en circuit, remettre hors circuit l'interrupteur d'alimentation principale (MAIN POWER) et vérifier que le bloc de lampe et le couvercle du bloc de lampe sont bien installés. Remettre ensuite l'interrupteur d'alimentation principale (MAIN POWER) en circuit.

- ⑦ Appuyer sur la touche d'alimentation (POWER) pour projeter une image sur l'écran.
- ⑧ Appuyer sur la touche de menu (MENU) pour afficher l'écran de MENU PRINCIPAL, puis appuyer sur les touches ▲ et ▼ pour déplacer le curseur et sélectionner "OPTION".

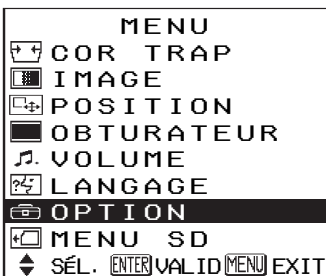

- ⑨ Appuyer sur la touche d'entrée (ENTER) pour afficher le menu OPTION, puis utiliser les touches ▲ et ▼ pour sélectionner DURÉE LAMPE.

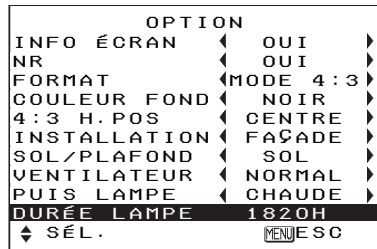

- ⑩ Maintenir la touche d'entrée (ENTER) enfoncée pendant environ 3 secondes.

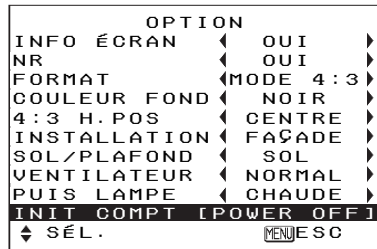

"DURÉE LAMPE" changera à "INIT COMPT [POWER OFF]".

REMARQUE:

- Si la touche de menu (MENU) est pressée, l'écran de remise à zéro de la durée de lampe sera annulé.
- ⑪ Couper l'alimentation électrique. Le temps d'utilisation total du bloc de lampe est alors remis à zéro. Pour plus de détails concernant la mise hors tension, se reporter à la page 23.

These Operating Instructions are printed on recycled paper.

Panasonic[®]

Professional/Industrial Video

Panasonic Broadcast & Television Systems Company
Division of Matsushita Electric Corporation of America

One Panasonic Way 4E-7 Secaucus, NJ 07094 (201) 392-4443
3330 Cahuenga Blvd West Los Angeles, CA 90068 (323) 436-3500

Technical Support:

(800) 524-1448

(800) 526-6610

FAX: (201) 392-6514

E-Mail: pbtssupport@panasonic.com

Printed in Japan
S1202-1023B