

HP vp6300 Series

Digital Projector

User's Guide



© Copyright 2005 Hewlett-Packard Development Company, L.P.

The only warranties for HP products and services are set forth in the express warranty statements accompanying such products and services. Nothing herein should be construed as constituting an additional warranty. HP shall not be liable for technical or editorial errors or omissions contained herein.

Hewlett-Packard Company
Digital Projection and Imaging
1000 NE Circle Blvd.
Corvallis, OR 97330

First Edition, January 2005

Contents

1 Setting Up

Safety precautions	7
What's in the box?	8
Identifying common features.	9
Projector at a glance	9
Projector buttons and lights	11
Back panel	12
Remote control	14
Accessories.	15
Setting up the projector	16
Positioning the projector	16
Connecting power	19
Connecting a computer	20
Connecting a handheld organizer	21
Connecting a video source	22
Turning the projector on and off	26
Turning the projector on	26
Turning the projector off	27
Moving the projector	27
Making basic adjustments	28
Aiming the projector	28
Adjusting the focus and zoom	28
Using the remote control	29

2 Showing Presentations

Showing a computer screen	31
Selecting a different source	31
Hiding or showing the picture	31

3 Adjusting the Projector

Adjusting the picture and sound	33
Choosing the best picture mode.	33
Adjusting the shape of the picture	34
Adjusting a slanted picture	35
Adjusting the picture for best color.	36
Adjusting other picture settings	36
Adjusting the volume	37
Adjusting other sound settings	37

Adjusting the projector setup	37
Preventing unauthorized use	37
Using the on-screen menu	38
Changing settings using the on-screen menu	38
Input menu	39
Picture menu	40
Sound menu	41
Setup menu	41
Help menu	42

4 Maintaining the Projector

Performing routine maintenance	43
Getting the projector status	43
Cleaning the projector lens	43
Replacing the lamp module	44
Replacing the battery in the remote control	46
Upgrading the projector	47
Updating the firmware	47

5 Installing Permanently

Installing the projector	49
Choosing cables	49
Installing on a table	49
Installing on the ceiling	49
Installing for rear projection	50
Locking the projector	50
Controlling an external accessory	51
Connecting to a room controller	52
Serial connections	52
Examples of room controller commands	52
Room controller commands	54

6 Fixing Problems

Troubleshooting suggestions	59
Warning light problems	59
Start-up problems	60
Picture problems	60
Sound problems	63
Interruption problems	63
Remote control problems	63
Testing the projector	64
Running the projector diagnostics	64

7 Reference

Specifications	65
Safety information.	68
LED safety	68
Mercury safety	68
Regulatory information	69
U.S.A.	69
Canada	69
Japan	70
Korea	70
International	70

1 Setting Up

Safety precautions



WARNING! Read and observe these precautions and all others in this manual to reduce the risk of injury and equipment damage.

- Do not look directly into the lens when the lamp is on.
- Do not expose the projector to rain or moisture, and do not use it near water.
- Keep paper, plastic, and combustible material at least 0.5 m (2 ft) away from the projector lens and exhaust vents.
- Do not allow liquid, food, or small objects to get inside the projector. If material gets inside the projector, contact HP for assistance.
- Do not put anything on top of the projector. Do not place any liquids where they might spill on the projector.
- Do not block any vents on the projector. Do not place the projector near any source of heat, such as a radiator or amplifier.
- Use only an approved power cord rated for the voltage and current marked on the product label. Do not overload any outlet or extension cord. Do not circumvent the grounding prong on the power cord.
- Route all cables so they are not located where people can step on them or trip on them.
- Place the projector flat on its base on a sturdy surface or on an HP ceiling mount. Do not stand the projector on its front surface.
- Do not touch the lens with your fingers. See “Cleaning the projector lens” on page 43. Use a soft, dry cloth to clean the projector case.
- Do not open the projector except as instructed by this manual, and only after allowing the projector to cool down.
- If the projector is damaged in any way, contact HP for assistance.

What's in the box?

Before setting up your projector, be sure your shipping box includes the following items. If the shipping box does not contain any of the following items, contact HP.



TIP: After you open the box and remove the contents, save the box in case you must ship the projector.

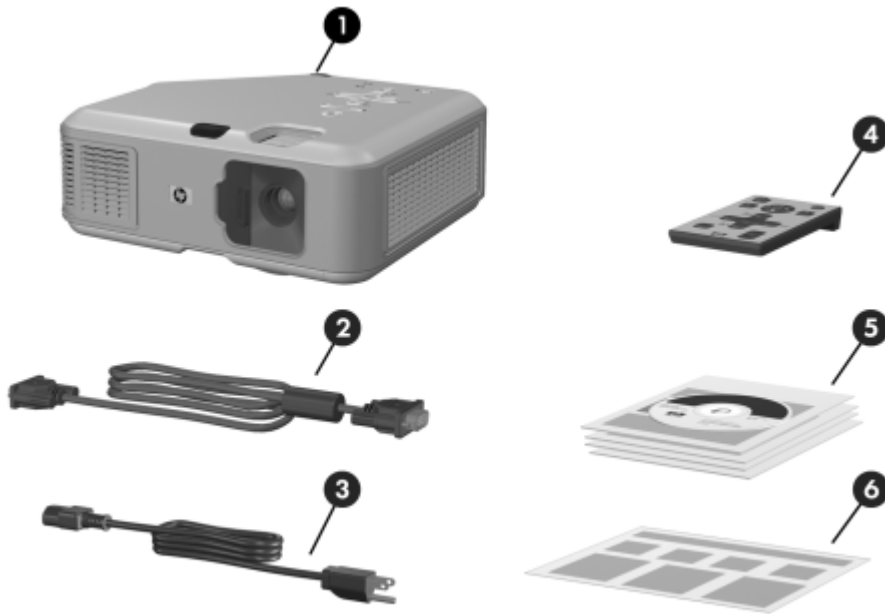

Identifying the contents of the box

Item	Function
1 Projector	Displays images.
2 VGA cable	Connects computer video output to the projector.
3 Power cord	Connects projector to power source.
4 Remote control	Controls projector.

Identifying the contents of the box (continued)

Item	Function
⑤ Literature package	Contains documentation for the setup and use of the projector, plus support and warranty information.
⑥ <i>Quick Setup Guide</i>	Provides instructions to help get started.

Identifying common features

Projector at a glance

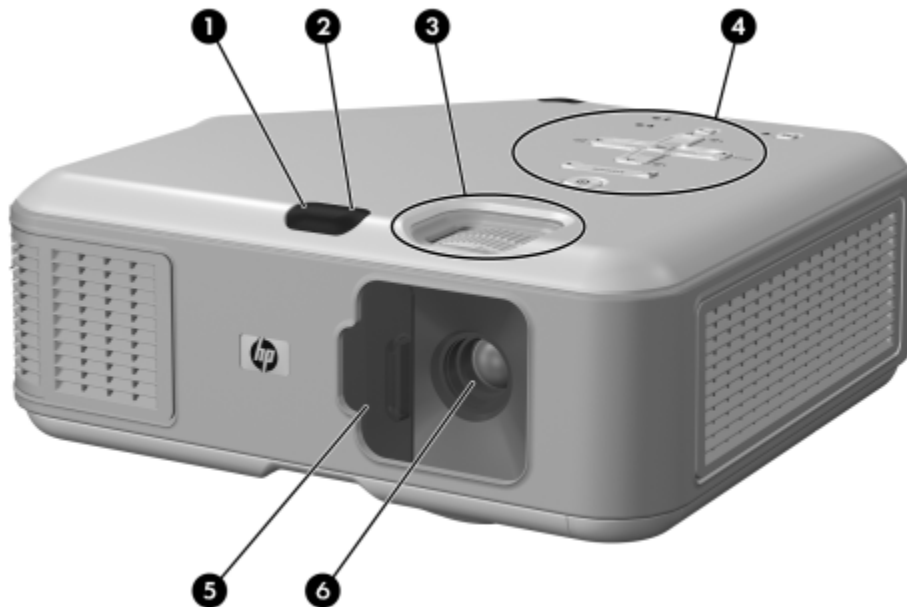

Identifying major components

Item	Function
① Infrared port	Receives signals from the remote control. Also works as a button to adjust the height.
② Height adjustment button	Adjusts the height of the picture.

Identifying major components (continued)

Item	Function
③ Focus and zoom rings	Focus ring: focuses at distance of 1 to 10 m (3 to 33 ft). Zoom ring: enlarges picture size from 100% to 116%.
④ Button panel	Contains control buttons and indicator lights.
⑤ Lens cover	Protects the lens.
⑥ Lens	Projects the image.

Projector buttons and lights

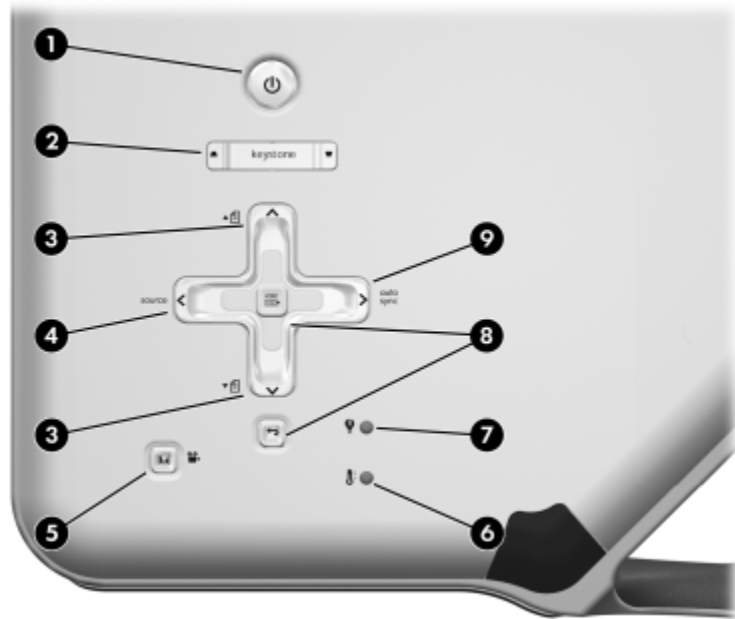

Identifying the projector buttons and lights

Item	Function
❶ Power button	Turns the projector on or off.
❷ Keystone adjustment	Adjusts picture to eliminate slanted sides.
❸ Page-up and Page-down buttons	Scroll up and down through pages on a connected computer.
❹ Source button	Displays picture from the next input port.
❺ Picture mode button	Selects the next picture and color combination—can be customized.
❻ Temperature warning light	Warns if the projector is too hot.
❼ Lamp warning light	Warns if the lamp is bad.
❽ Menu buttons	Change settings using the on-screen menu.
❾ Auto sync button	Resynchronizes the projector to the input signal from a computer.

Back panel

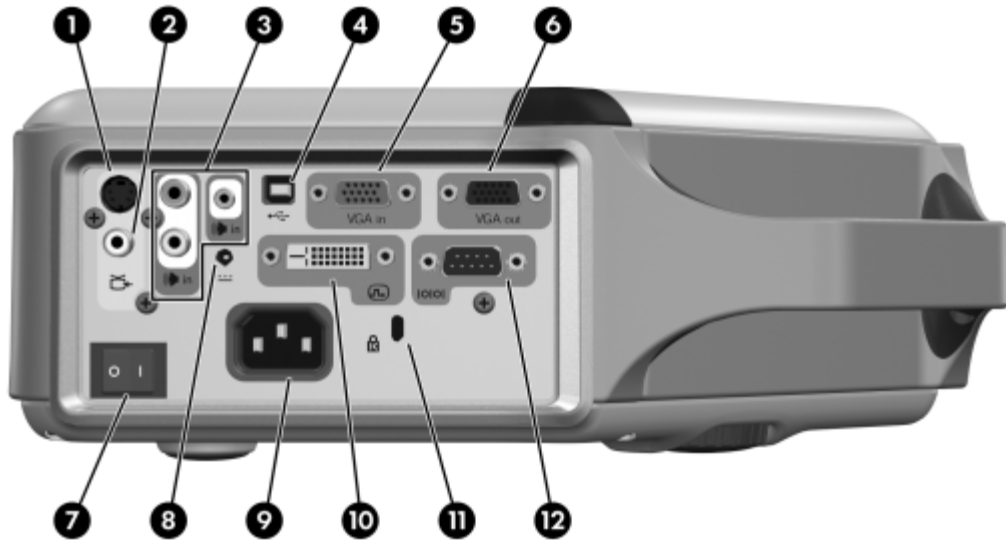

Identifying back panel components

Item	Function
❶ S-video input port	Connects S-video source.
❷ Composite-video input port	Connects composite-video source.
❸ Audio-in ports	Connect stereo audio source using either RCA plugs or stereo mini-phone plug.
❹ USB port	Connects to computer and controls the mouse.
❺ VGA-in port	Connects video input from computer or component-video source.
❻ VGA-out port	Sends the VGA-in signal to a monitor.
❼ Main disconnect switch	Disconnects power. Turn off when unplugging power cord. CAUTION: Do not use this switch to turn off the projector. Use the power button on top of the projector.

Identifying back panel components (continued)

Item	Function
⑧ 12-Vdc trigger output	Controls a motorized screen or similar accessory device. NOTE: Available only on certain models.
⑨ Power cord socket	Connects power cord to projector.
⑩ DVI input port	Connects DVI-D digital video source. NOTE: Available only on certain models.
⑪ Lock slot	Locks the projector to a stationary object with the use of a cable and lock.
⑫ Serial port	Connects a room controller. NOTE: Available only on certain models.

Remote control



TIP: Before using the remote control, remove the battery protector by pulling the plastic tab until it comes out of the remote control.

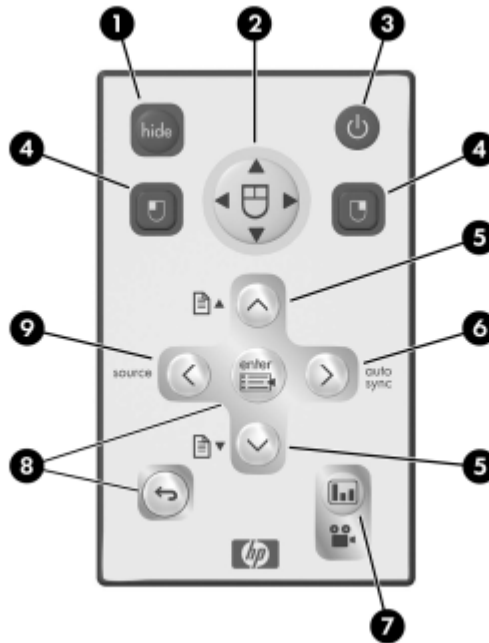

Identifying components of the remote control

Item	Function
❶ Hide button	Blanks picture, mutes speaker.
❷ Mouse pad	Moves the mouse pointer on a connected computer.
❸ Power button	Turns the projector on or off.
❹ Left-click and right-click mouse buttons	Perform left-click and right-click mouse functions on a connected computer.
❺ Page-up and Page-down buttons	Scroll up and down through pages on a connected computer.

Identifying components of the remote control (continued)

Item	Function
⑥ Auto sync button	Resynchronizes the projector to the input signal from a computer.
⑦ Picture mode button	Selects the next picture and color combination—can be customized.
⑧ Menu buttons	Change settings using the on-screen menu.
⑨ Source button	Displays picture from the next input port.

Accessories

Get more from your presentations with HP projector accessories. You can purchase accessories at <http://www.hp.com> or through your projector dealer.

- **HP ceiling mount kit**—enables you to simply and discreetly install your projector on the ceiling.
- **HP projection screens**—mobile screens that are easy to carry and set up anywhere, and fixed screens for even greater convenience.
- **HP premium remote control**—allows you to control every aspect of your presentations.
- **HP power cables**—allow you to connect in any region.
- **HP cables**—allow you to connect all audio-video equipment.
- **HP replacement lamp**—brings your projector up to factory-fresh brightness.

Setting up the projector

Positioning the projector

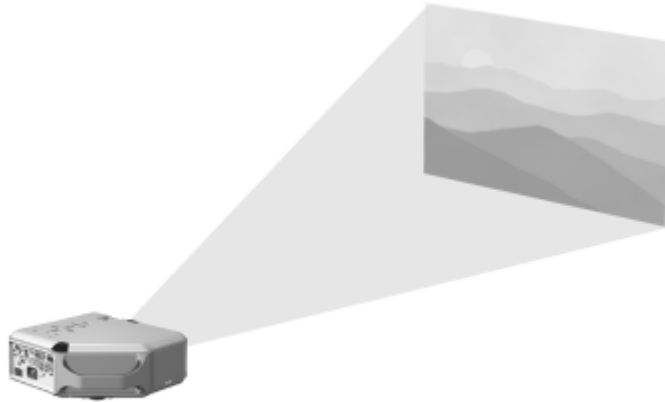

The following tables show you where to position the projector in relation to the screen.



TIP: For best picture quality, place the projector 1.5 to 5 m (5 to 16 ft) from the screen

Image size relative to distance from the screen—vp6310 series

Image size (diagonal)		Image size (width)		Distance (lens to screen)	
(inches)	(meters)	(inches)	(meters)	(inches)	(meters)
30	0.8	24	0.6	41 to 48	1.1 to 1.2
40	1.0	32	0.8	55 to 64	1.4 to 1.6
60	1.5	48	1.2	83 to 96	2.1 to 2.4
80	2.0	64	1.6	110 to 128	2.8 to 3.3
100	2.5	80	2.0	138 to 160	3.5 to 4.1
120	3.0	96	2.4	166 to 192	4.2 to 4.9
150	3.8	120	3.0	207 to 240	5.3 to 6.1
180	4.6	144	3.7	248 to 288	6.3 to 7.3
200	5.1	160	4.1	276 to 320	7.0 to 8.1
240	6.1	192	4.9	331 to 384	8.4 to 9.8
270	6.9	216	5.5	372 to 396	9.5 to 10.0

Image size relative to distance from the screen—vp6320 series

Image size (diagonal)		Image size (width)		Distance (lens to screen)	
(inches)	(meters)	(inches)	(meters)	(inches)	(meters)
30	0.8	24	0.6	43 to 50	1.1 to 1.3
40	1.0	32	0.8	58 to 67	1.5 to 1.7
60	1.5	48	1.2	87 to 101	2.2 to 2.6
80	2.0	64	1.6	116 to 134	2.9 to 3.4
100	2.5	80	2.0	145 to 168	3.7 to 4.3
120	3.0	96	2.4	174 to 202	4.4 to 5.1
150	3.8	120	3.0	217 to 252	5.5 to 6.4
180	4.6	144	3.7	261 to 302	6.6 to 7.7
200	5.1	160	4.1	290 to 336	7.4 to 8.5
240	6.1	192	4.9	348 to 400	8.8 to 10.0
270	6.9	216	5.5	391 to 400	9.9 to 10.0

If you do not want to use the distance table, you can use the following equations to help determine where to install the projector relative to the screen.

Calculating projection distances

distance from lens to screen = $A \times$ width of screen

minimum and maximum distance from screen = B

width of screen = $0.8 \times$ diagonal of screen (for 3:4 screen)

projector lens below bottom of screen = $C \times$ width of screen (for 4:3 screen)

vp6310 series

$A = 1.7$ to 2.0

$B = 1$ to 10 m (3 to 33 ft)

$C = 0.11$ to 0.41

vp6320 series

$A = 1.8$ to 2.1

$B = 1$ to 10 m (3 to 33 ft)

$C = 0.11$ to 0.43

Connecting power

1. Place the projector on a stable platform located 1 to 10 m (3 to 33 ft) in front of the screen. Ideally, the platform should be lower than the bottom of the screen.
2. Connect one end of the power cord to the back of the projector ❶ and the other end to a grounded electrical outlet ❷.
3. Turn on the main disconnect switch ❸ on the back of the projector.



If you want to permanently install the projector on the ceiling or behind the screen, see “Installing the projector” on page 49.

Connecting a computer

Requires:

- VGA cable ❶
- USB cable ❷ (optional)
- Audio cable, mini-phone ❸ (optional)

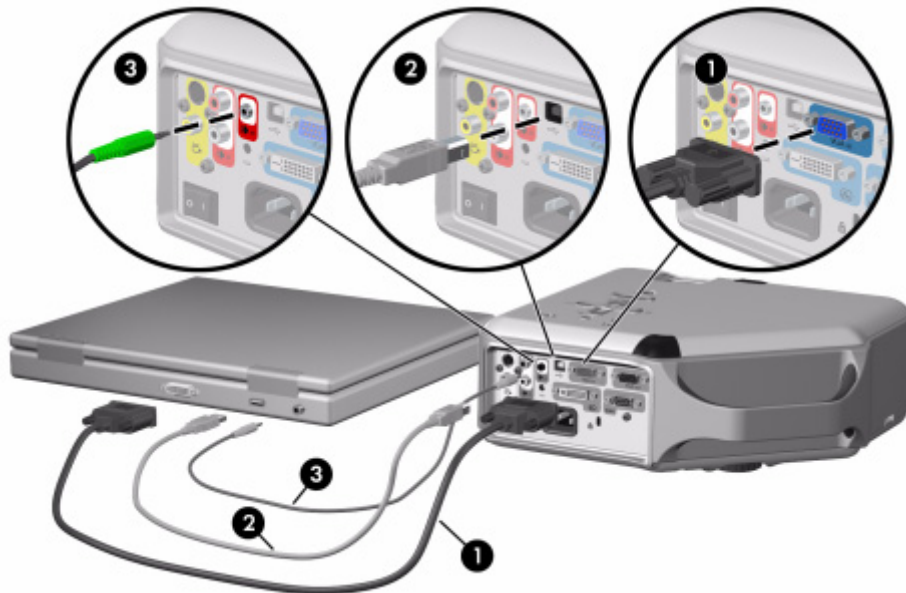

The optional USB connection allows you to use the mouse and page up/down features on the remote control.

See “Showing a computer screen” on page 31.



TIP: If the computer display does not appear on the projector, you might have to press a combination of keys on the computer to turn on the computer’s VGA output. For example, on some computers you must press FN+F4 or FN+F5. For instructions, refer to the user documentation provided with your computer.

TIP: You can connect an external computer monitor to the VGA-out port on the projector. The monitor displays the signal connected to the VGA-in port—even if the projector is turned off or showing a different input.

Connecting a handheld organizer

Not all handhelds come with VGA-out ports. For example, an iPAQ Pocket PC may require a VGA-out PC Card with 15-pin connector. If necessary, install a VGA-out accessory card into the organizer.

Requires:

- VGA cable ❶
- VGA-out accessory card ❷ (in some cases)



Connecting a video source

Many video devices have more than one type of output port. When you connect the device to the projector, choose the connection that provides the best picture quality. This list shows video connections in order with highest picture quality at the top:

- DVI connection (highest quality)
- Component-video connection
- S-video connection
- Composite-video connection

The video and audio cables shown in the following sections are available from HP.

If you want to connect a SCART video device to the projector, you will need a SCART adapter (available from HP).

Connecting a DVI source

The DVI port is available only on certain models. It supports only DVI digital sources.

Examples: Cable boxes, satellite receivers, and some computers

Requires:

- DVI-D cable ❶
- Audio cable, RCA ❷ (optional)

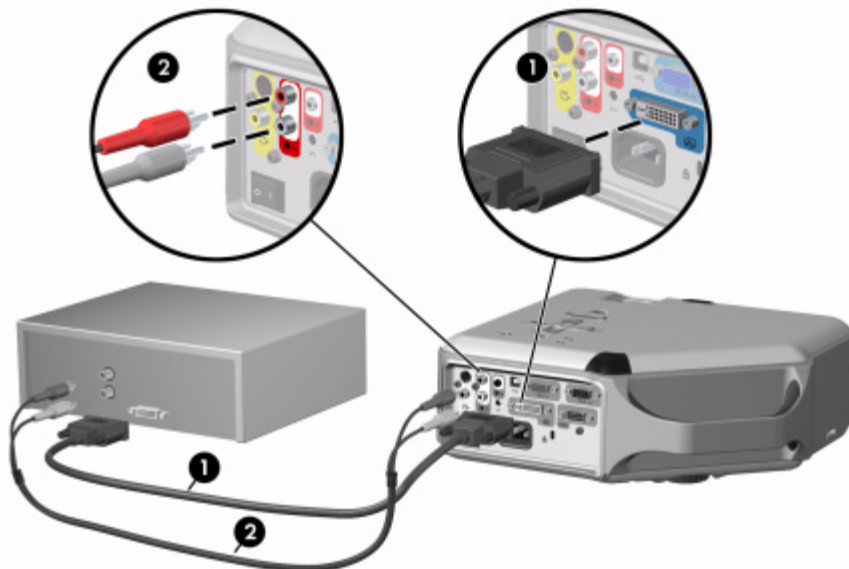

Connecting a component-video source

Examples: Cable boxes, DVD players, satellite receivers, and audio-video receivers

Requires:

- Component-to-VGA cable ❶
- Audio cable, RCA ❷ (optional)



TIP: Many DVD players and other high-quality video devices provide component video output. The three RCA connectors might be labeled YPbPr or YCbCr.

If possible, configure the video source to use progressive scan output, such as 480p, 575p, or 720p. For additional information, refer to the user documentation provided with the video source.

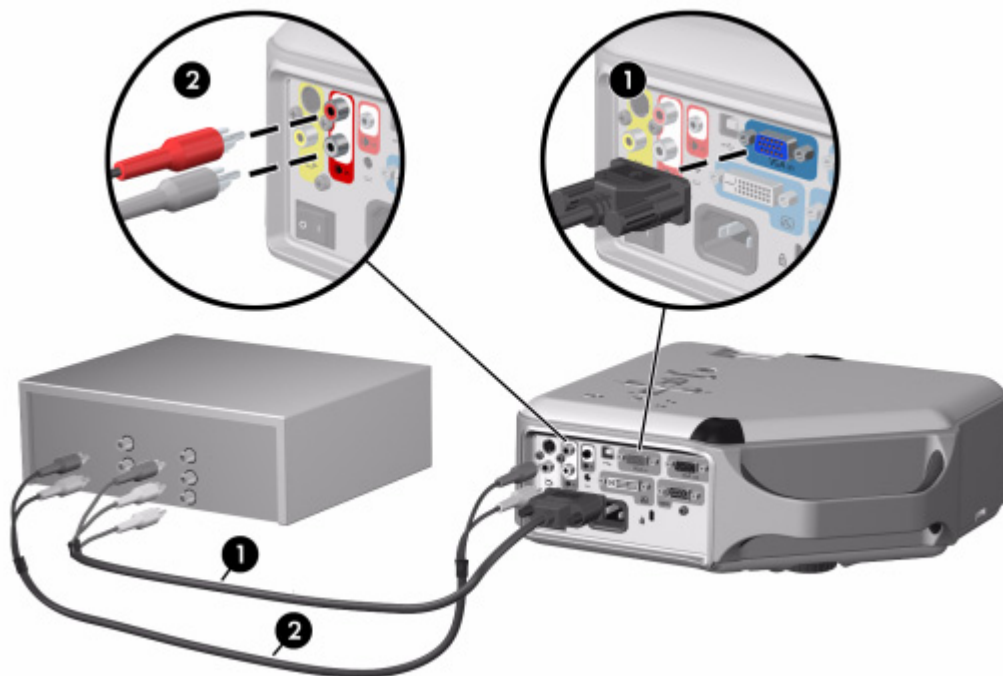

Connecting an S-video source

Examples: DVD players, VCRs, cable boxes, camcorders, and video gaming devices

Requires:

- S-video cable ❶
- Audio cable, RCA ❷ (optional)

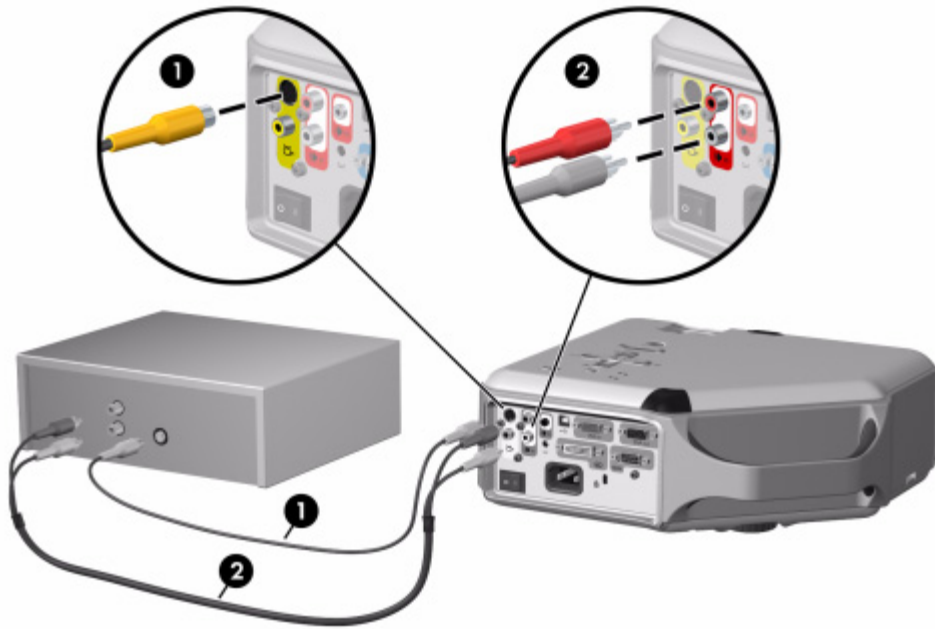

Connecting a composite-video source

Examples: VCRs, DVD players, audio-video receivers, and video gaming devices

Requires:

- Composite-video cable **1**
- Audio cable, RCA **2**, or combined video-audio cable (optional)

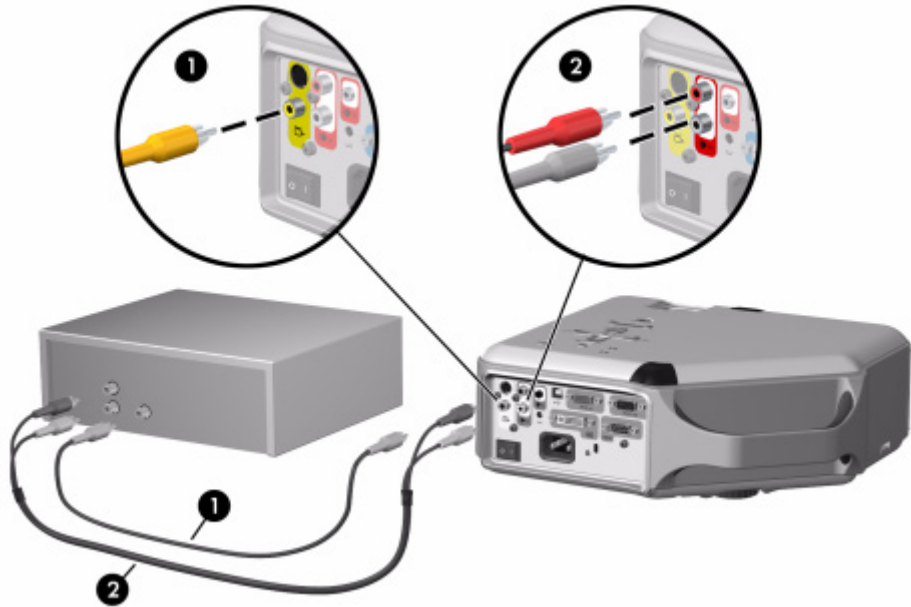

Turning the projector on and off

Turning the projector on

1. Be sure the power cord is connected and the main disconnect switch is on.
2. Open the lens by sliding the lens cover **1** to the left.
3. Press the power button **2** on the projector or on the remote control.

The projector takes a minute or so to warm up. The power button blinks during warm-up.



TIP: If the picture does not appear on the screen, try the following:

- If you are using a computer, press the key combination that turns on its video output. For example, press FN+F4 or FN+F5 on some computers.
- On the projector, press the **source** button one or more times to select the correct input port.

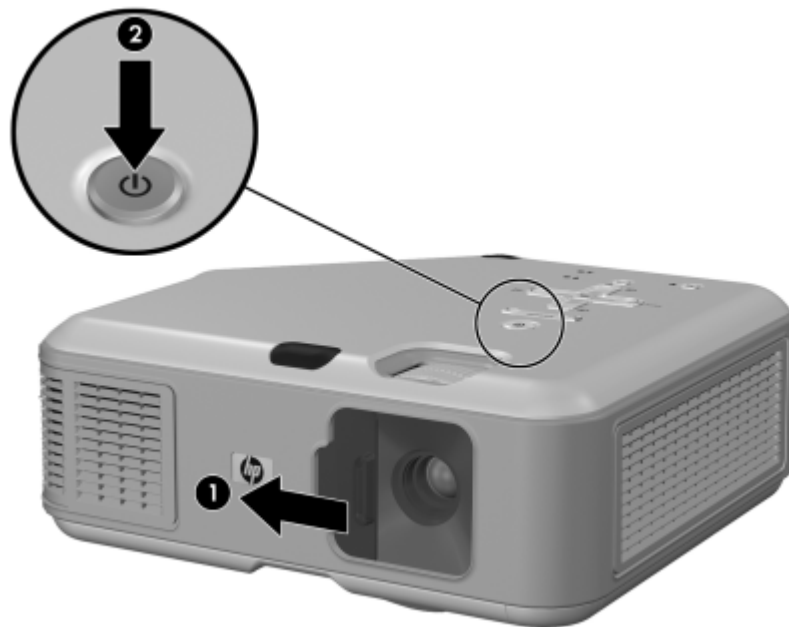



NOTE: It is normal for parts of the projector and the air coming out of the projector to be very warm. If the projector starts to overheat, the temperature warning light will turn on and the projector will shut down.

Turning the projector off

1. Press the power button on the projector or remote control to turn off the projector. Do not hold the button down.

The power button blinks during the cool-down period, then the projector turns off. Even though the projector is off, it uses a small amount of power internally.

2. If you want, disconnect video and audio equipment from the projector during the cool-down period or after the power button stops blinking.



CAUTION: Do not disconnect power or turn off the main disconnect switch until the projector has cooled down (the fan stops) and the power button stops blinking. Otherwise, you might shorten the life of the lamp.

3. If you must unplug or remove the projector, wait until the power light stops blinking, then unplug the power cord.

If you try to turn on the projector again during the cool-down period, it will not turn on. Wait until the cool-down period ends and the power button stops blinking.

Moving the projector

When moving the projector:

- Allow the projector to cool down before moving it. Then disconnect all cables.
- Avoid bumps and jolts. Use a carrying case or padded container when possible.
- Observe temperature and humidity limits (see “Specifications” on page 65). If the projector is cold, allow it to warm gradually to avoid condensation.

Making basic adjustments

This section provides instructions for making basic adjustments to the projector.

Aiming the projector

- To raise or lower the projected picture on the screen, press the height adjustment button **1** and raise or lower the front of the projector **2**. Release the button to lock the adjustment.
- To level the picture on the screen, turn the adjustable foot **3** to lengthen or shorten the foot.

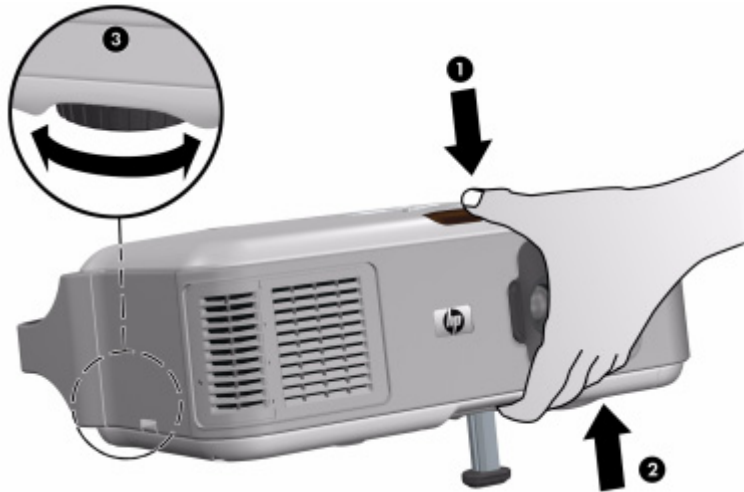

Adjusting the focus and zoom

1. Rotate the focus ring until the image becomes clear. The projector can be focused at distances of 1 to 10 m (3 to 33 ft).
2. Rotate the zoom ring to adjust the picture size from 100 to 116%.

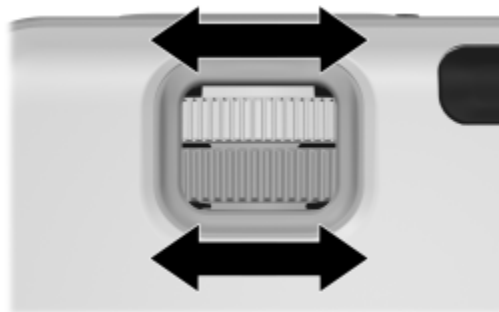

If the picture does not fit the screen, you might have to move the projector closer to or farther away from the screen.

Using the remote control

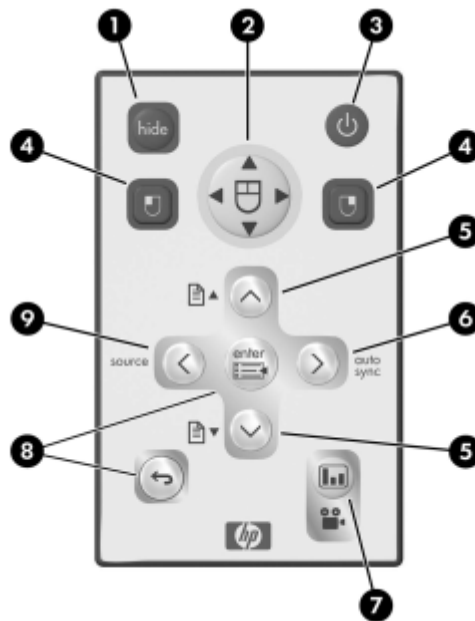

To do this...**Press this...**

Hide or unhide the picture

hide button **1**.

Move mouse pointer on computer

Edge of the mouse pad **2** in the direction you want the pointer to move. This feature requires a USB connection between the projector and computer.

Turn the projector on or off

Power button **3**.

Click mouse button on computer

Left-click or right-click button **4**. This feature requires a USB connection between the projector and computer.

Page up or page down on computer

Page-up or page-down button **5**. This feature requires a USB connection between the projector and computer.

Readjust picture of computer screen

auto sync button **6**.

To do this...	Press this...
Change picture settings for different type of input signal	Picture mode button 7 one or more times.
Change settings using on-screen menu	enter and navigation buttons 8 . See "Using the on-screen menu" on page 38.
Exit from any on-screen menu or adjustment	Exit ↩ button 8 .
Switch to next input source	source button 9 one or more times.



TIP: From within the distance of 9 m (30 ft), aim the remote control at the screen or at the front or back of the projector.

2 Showing Presentations

Showing a computer screen

1. Be sure the computer is connected to the projector and turned on. See “Connecting a computer” on page 20.
2. Be sure the projector is set up, turned on, and adjusted. See “Making basic adjustments” on page 28.
3. If a different input source is shown on the projector, press the **source** button on the projector or remote control one or more times to select the VGA-in port.
4. If the computer display is not shown on the projector, you might have to turn on the computer’s video output port. For example, some computers require you to press a key combination, such as FN+F4 or FN+F5. Refer to the user documentation provided with your computer.

If you want to adjust the picture, see “Adjusting the picture and sound” on page 33.

Selecting a different source

If the picture from your video source does not appear on the screen, you can quickly select the correct source.

- ▲ Press the **source** button one or more times—until you see the picture or you see the name of the video port where the source is connected.

You should also be sure the video source is turned on and playing video.

Hiding or showing the picture

1. Press the **hide** button on the projector or remote control to blank the picture and turn off the projector speakers. This does not affect the video source, which continues playing.
2. Press any button to show the picture again and turn on the projector speakers.

3 Adjusting the Projector

Adjusting the picture and sound

Choosing the best picture mode

You can quickly choose a different picture mode to make adjustments to the picture. Picture modes can control properties such as color and size. They let you easily choose the best settings for ambient lighting and the type of video content (see “Adjusting the picture and sound” on page 33).

- ▲ Press the picture mode  button one or more times to select the picture mode that gives the best picture.

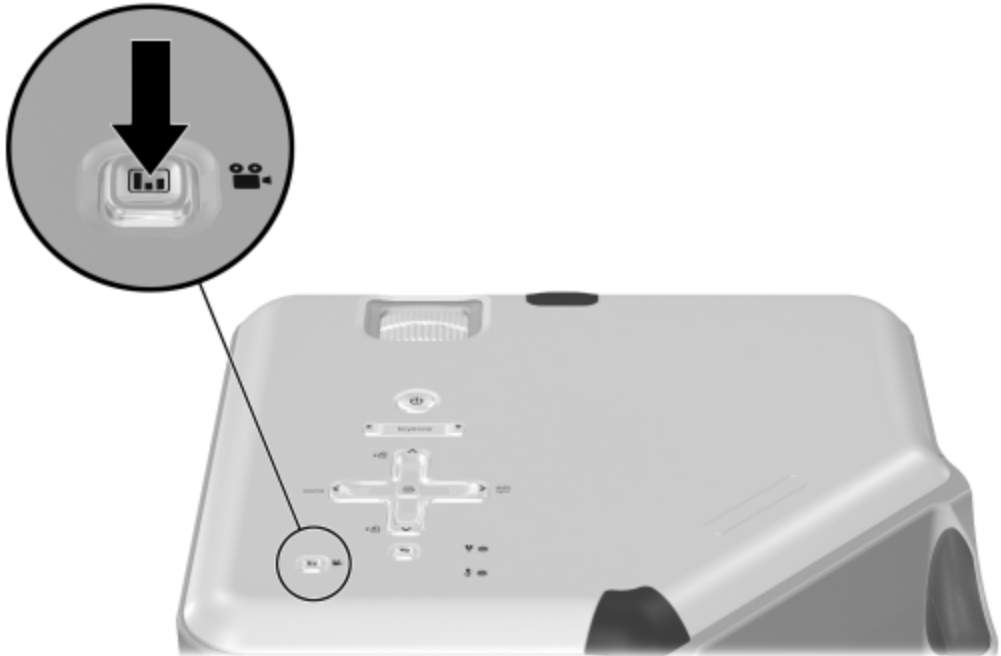

You can also customize the picture modes so they are best for your video sources:

1. Press the picture mode  button to select the picture mode you want to adjust.
2. Press **enter** and go to **Picture > Customize picture mode**.
3. Adjust the settings until you are satisfied with the picture.



TIP: To exit from any on-screen menu or adjustment, press the exit  button.

Adjusting the shape of the picture

Depending on the type of video source you are viewing, the picture might or might not always look correct or fit on the screen:

- If the active video device sends widescreen output to the projector, press **enter**, go to **Input**, and set **Widescreen input** to **Yes**. See ❶ in the following diagram.
- If the video device sends standard output, set **Widescreen input** to **No**.



TIP: If you show widescreen pictures on a wide projection screen, a standard picture might not fit on the screen. One solution is to change the current picture mode so it makes a smaller picture. Press **enter**, go to **Picture > Customize picture mode**, and set **Stretch** to **Reduced**. See ❷ in the following diagram.

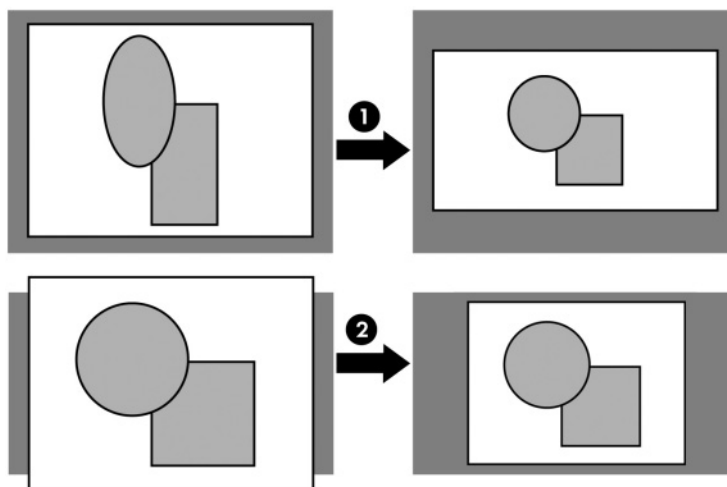

Adjusting a slanted picture

If the projector is tilted up or down, the sides of the picture on the screen might slant in or out, even though the top and bottom are level. The keystone adjustment corrects this problem.

▲ Press the **keystone** adjustment on the projector until the picture looks correct.

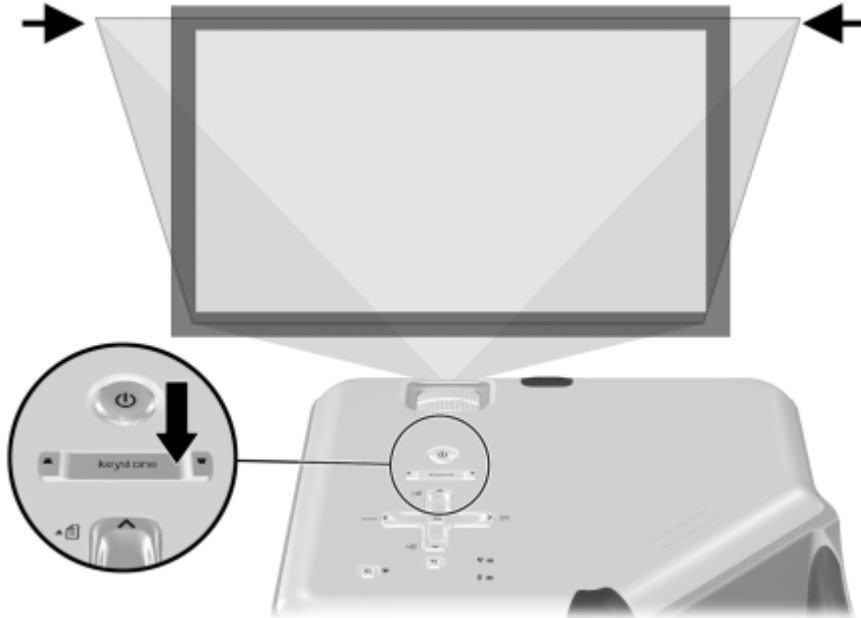

You can also make the keystone adjustment in the on-screen menu. Press **enter**, and go to **Setup > Keystone** to adjust the picture.



TIP: If the top and bottom of the picture slant in different directions, move the projector until it is straight in front of the screen, not off to one side.

Adjusting the picture for best color

You can fine tune the picture settings on your projector to get the best color and image quality. You should perform these steps for each input source device and each input port that you use. Do them in the order shown. For some input ports, some of these settings may not be available.

1. Press the picture mode  button and select the picture mode you want to use for the current source.
2. Press **enter** and go to the **Picture** menu.
3. Go to **Color settings > Brightness**. Adjust to the highest setting that still gives the darkest black for black areas. If you temporarily set a large keystone adjustment, you can view the black areas at the sides of the picture.
4. Go to **Color settings > Contrast**. Adjust to the highest setting that does not wash out fine detail in bright areas. You can view bright clouds or textured white areas.
5. Go to **Customize picture mode > Picture enhancement**. Adjust to the setting that gives the best overall mid-range brightness. This should have minimal effect on blacks and whites.
6. Go to **Customize picture mode > Color temperature**. Adjust to the setting where whites and colors look best.
7. Go to **Color settings > Color saturation**. Adjust to the setting where colors look most natural.
8. Go to **Color settings > Tint**. Adjust to the setting where colors look most natural.
9. Go to **Customize picture mode > White intensity**. Adjust this setting above 0 as needed to brighten the picture but not affect colors.
10. Repeat all steps if necessary.

Adjusting other picture settings

The on-screen menu provides many settings that allow you to fine-tune the picture.

1. Press **enter**, and go to **Picture**.
2. Change the picture adjustments as needed.

From the **Picture** menu, you can change many picture options, such as brightness, contrast, and picture shape, as well as customize the picture modes.

To get descriptions for all available picture adjustments, see “Picture menu” on page 40.

Adjusting the volume

You can control the volume of the projector's speakers:

- To change the volume of the projector's speakers, press **enter**, go to **Sound > Volume**, and change the setting.
- To turn the sound on or off temporarily, press **enter**, go to **Sound > Mute**, and mute the sound.

Adjusting other sound settings

1. Press **enter**, and go to **Sound**.
2. Set the sound adjustments.

From the **Sound** menu, you can adjust sound settings, such as mute, volume, and speaker operation.

To get descriptions for all available audio adjustments, see "Sound menu" on page 41.

Adjusting the projector setup

1. Press **enter**, and go to **Setup**.
2. Set the setup adjustments as needed.

From the **Setup** menu, you can select settings, such as menu language, projector position, and menu timeout.

To get descriptions for all available setup adjustments, see "Setup menu" on page 41.

Preventing unauthorized use

You can prevent unauthorized people from using the projector by creating a secret button sequence that is required for the projector to turn on. The unlock sequence is a series of 4 to 8 arrow buttons. If the buttons are not pressed in the order you specify, the projector does not turn on. Use the following steps to set or clear an unlock sequence.

1. Press **enter**, go to **Setup > Advanced setup > Projector lock**, and press **enter**.
2. If an old unlock sequence is set, press the buttons according to the old sequence when prompted, and then press **enter**.
3. To set a new unlock sequence, press the arrow buttons for the new sequence, and then press **enter**.

To clear the unlock sequence and remove this protection, press only **enter**.

4. When prompted, confirm the new sequence and press **enter**.



NOTE: If you set an unlock sequence, you must press the sequence every time you turn on the projector. The sequence protects the projector only when the projector is turning on, not at any other time.

If you forget the unlock sequence, you must call HP support to unlock the projector. You must have the projector and your proof of purchase.

Using the on-screen menu

Changing settings using the on-screen menu

You can change the on-screen menu settings with the buttons on either the projector or the remote control.

1. Press **enter** on the projector or remote control. This displays the on-screen menu.
2. Press up ▲ or down ▼ to highlight the desired menu icon, then press right ► to move into that menu.
3. Press up ▲ or down ▼ to highlight a setting, then press **enter** to begin adjusting the setting.
4. Press left ◀ or right ▶, or press up ▲ or down ▼, to adjust the setting, as prompted.
5. Press **enter** to return to the menu.
6. To go to a different menu, press left ◀ and select a menu.
7. To close the on-screen menu, press the exit ↵ button.

If you do nothing for a period of time, the on-screen menu closes. To change the amount of time until the on-screen menu closes, press **enter** and select **Setup > Timeout for menu**.



TIP: To exit from any on-screen menu or adjustment, press the exit ↵ button.

Input menu

For a visual aid, see “Back panel” on page 12.

Input menu

VGA	Shows the source connected to the VGA-in port.
S-video	Show the source connected to the S-video port.
Composite	Shows the source connected to the composite-video port.
DVI	Shows the source connected to the DVI port (available only on certain models).
Scan inputs	Sets whether the projector automatically searches for input signals and displays the next one found.
Widescreen input	Sets whether a widescreen (16:9) input device is in use. Adjusts the height of the picture accordingly.

Picture menu

Some picture adjustments are available only when certain input ports are in use. Unavailable adjustments are shown in gray in the on-screen menu.

Picture menu

Color settings...	Adjusts the picture and colors.
Brightness	Brightens or darkens the picture.
Contrast	Sets the difference between light and dark areas.
Sharpness	Sharpens or softens the picture.
Color saturation	Adjusts the intensity of colors.
Tint	Shifts colors toward red or green.
Color space	For certain component inputs, selects the type of color standard used by the source.
Reset color settings	Restores these color settings to the default settings.
VGA settings...	Adjusts settings for a computer input.
Auto-sync	Resynchronizes the projector to the input signal. This can compensate for any change in the signal.
Frequency	Adjusts the timing of the projector relative to the computer.
Tracking	Adjusts the phase of the projector relative to the computer.
Vertical offset	Adjusts the picture up or down within the projection area.
Horizontal offset	Adjusts the picture left or right within the projection area.
Picture mode	Adjusts color and picture settings to one of several combinations designed for different types of viewing situations. You can use a different picture mode for each source or each viewing environment. You can also customize each picture mode.
Customize picture mode...	Changes settings associated with the current picture mode.
Picture enhancement	Refines the color, lightness, and other characteristics of the picture.
White intensity	Increases the brightness of white areas.

Picture menu (continued)

Color temperature	Shifts color toward red or blue.
Stretch	Selects how the picture fits on the screen: <ul style="list-style-type: none">• Best fit automatically fits the picture without stretching it.• 1-to-1 shows each picture dot as one projected dot.• Reduced fits a standard-shape picture onto a widescreen projection screen.
Picture shift	Moves the picture within the projection area. This is useful if you are viewing a picture that is smaller than the full projection area, such as a widescreen movie.
Reset picture shift	Resets the picture shift to zero (centered).
Reset this picture mode	Restores the current picture mode to its default settings.

Sound menu

Sound menu

Mute	Temporarily turns off the projector's speakers.
Volume	Adjusts the loudness of the speakers.
Internal speakers	Sets whether the internal speakers are turned on.
Reset sound settings	Restores sound settings to their default settings.

Setup menu

Setup menu

Language	Selects the language used by the on-screen menu.
Keystone	Corrects the slanted sides of the picture. This compensates for a projector that is too high or low relative to the screen.
Reset keystone	Resets the keystone correction to zero (no correction).
Lamp saver	Sets a lower power level for the lamp.
Timeout for menu	Sets how many seconds the on-screen menu waits for input before it closes.

Setup menu (continued)

Advanced setup...	Adjusts additional setup settings.
Power timeout	Sets the length of time the projector waits for an input signal before automatically shutting down.
Projector position	Adjusts the picture to match the orientation of the projector: upright or upside-down, in front of or behind the screen. Inverts or reverses the image accordingly.
Projector lock	Sets or cancels a secret button sequence that must be entered for the projector to operate.
Reset lamp hours	For a new lamp, resets the hours of use.
Reset all settings	Restores all menu settings to factory default settings.

Help menu

Help

	Displays information and status of the projector.
Diagnostics...	Show tests for checking the operation of the projector and the remote control.

4 Maintaining the Projector

Performing routine maintenance

Getting the projector status

To get the projector status:

- ▲ Press the **enter** button on the projector or remote control and go to **Help**.

This screen shows information and status for the projector.

Cleaning the projector lens

You can clean the front lens of the projector using the following recommendations. You cannot clean any of the internal surfaces.

- To minimize the risk of damaging or scratching the lens surface, blow dust particles off the lens with clean, dry, deionized air.
- If this method does not work, use the following method:
 - a. Wipe the lens in a single direction with a clean, dry cloth. Do not wipe back and forth across the lens.
 - b. If the cloth is dirty or smears the lens, wash the cloth. If the cloth is still dirty after washing it or the fabric is damaged, replace it.



CAUTION: Cleaning requires special consideration:

- Do not spray any type of fluid or cleaner directly on the lens surface. Cleaners might damage the lens.
 - Do not use fabric softener when washing a cleaning cloth or softener sheets when drying the cloth. Chemicals on the cloth might damage the surface of the lens.
 - Do not store a cleaning cloth in contact with the lens for a long time because doing so contaminates the lens with dye from the cloth. The cloth can be contaminated if left in the open air.
-

Replacing the lamp module

As the projector operates over time, the brightness of the projector lamp gradually decreases and the lamp becomes more susceptible to breakage. You can install a new lamp at any time to bring the projector up to factory-fresh brightness. We recommend replacing the lamp if a warning message is displayed.



WARNING! Replacing the lamp module requires special consideration:

- To reduce the risk of injury, be careful when removing the lamp module as broken glass might be present. For a ceiling installation, wear goggles and gloves when removing the lamp module. If the lamp is broken, contact HP about repairs that might be required due to glass fragments.
- The lamp contains a small amount of mercury. If the lamp breaks, adequately ventilate the area where the breakage occurred. Disposal of this lamp might be regulated due to environmental considerations. For disposal or recycling information, contact your local authorities or the Electronic Industries Alliance at <http://www.eiae.org>.
- Because the lamp assembly operates at a very high temperature, wait 30 minutes before removing the lamp module.

1. Turn off the projector and allow it to cool for 30 minutes.
2. Unplug the power cord.
3. Press the release latch ❶ on the lamp cover and remove the cover ❷.
4. Press the release latch on the lamp connector and unplug the connector ❸.

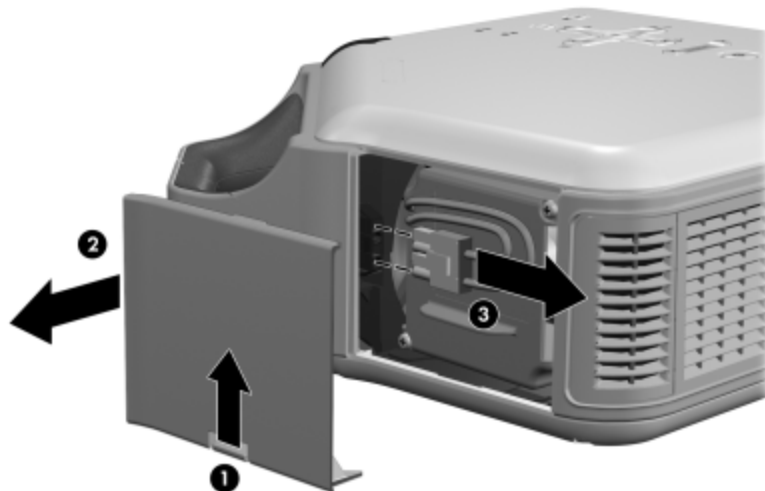

5. Loosen the two screws ④ on the lamp module, and pull out the module ⑤.

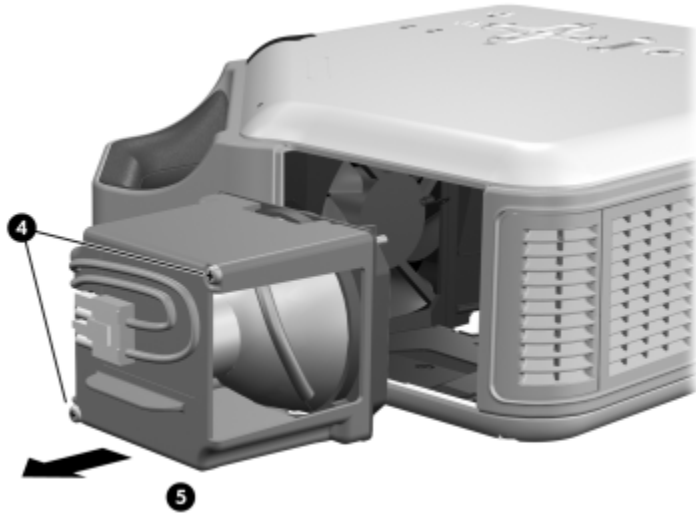

6. Insert the new lamp module into the projector and tighten the two screws.
7. Plug in the lamp connector.
8. Snap the lamp cover into place.
9. Turn on the projector. If the lamp does not turn on after the warm-up period, try reinstalling the lamp.
10. Press **enter**, go to **Setup > Advanced setup > Reset lamp hours**, and press **enter**.

Replacing the battery in the remote control

1. Use a ballpoint pen to hold the battery latch toward the center, then pull out the battery holder ❶.
2. Insert the new battery ❷ in the holder.
3. Push the holder ❸ into the remote control.

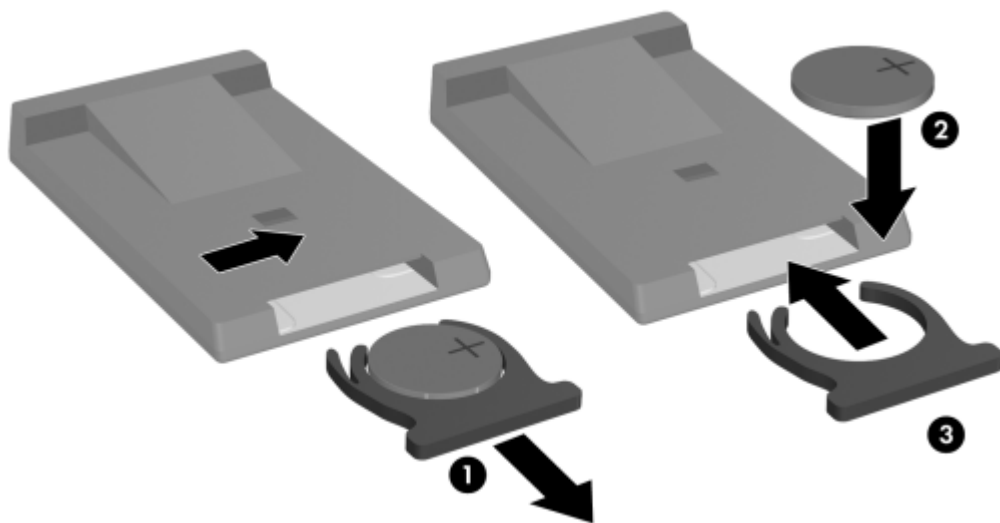

When discarding old batteries, contact your local waste-disposal provider regarding local restrictions on the disposal or recycling of batteries.



Upgrading the projector

Updating the firmware

HP might periodically release updated versions of the projector firmware to enhance the projector performance. The projector firmware version is shown in the on-screen menu at **Help**. Check for updated versions at http://www.hp.com/go/proj_firmware.

USB method

1. On a computer with a USB port, go to the HP projector upgrade website (see introduction for this section) and download the latest file intended for a USB upgrade.
2. Connect a USB cable (available from HP) between the USB port on the projector and the USB port on the computer.
3. On the computer, run the file you downloaded by double-clicking the file. Follow the on-screen instructions.

5 Installing Permanently

Installing the projector

Choosing cables

If you are permanently installing the projector or using it with long cables, consider the following suggestions when planning the installation:

- Use high-quality cables. Use only video cables that are made with 75-ohm coaxial cable and connectors. For high-resolution video, use low-loss video cables. For standard audio, use audio cables that are shielded. For digital audio, use 75-ohm coaxial cables.
- Minimize cable length as much as possible. For video cables longer than 6 m (20 ft), use low-loss coaxial cables. For standard audio cables longer than 6 m (20 ft), use 12-gauge wire.
- Do not run audio or video cables next to power or network cables. If they must cross, cross them at 90 degrees.
- If you are installing cables in walls, use cables with necessary approvals, such as Underwriters Laboratories (UL) approval.
- If you are running cables above a dropped ceiling, you must use plenum-rated cables if the space above the ceiling is open to the space above other rooms. You must use plenum-rated cables if you are running cables in a duct.
- Before installing cables permanently, check the setup with the final cables in the open.

Installing on a table

This installation is covered in detail in Chapter 1. See “Setting up the projector” on page 16 for more information.

Installing on the ceiling



WARNING! To minimize the risk of injury from improperly installed equipment, it is recommended that a professional installer performs the ceiling installation.

1. Attach the projector to the ceiling using an HP ceiling mount kit. Refer to the installation instructions provided with the ceiling mount kit.
2. After the projector is mounted on the ceiling, adjust the projector settings to match this setup. Press **enter**, go to **Setup > Advanced setup > Projector position**, and select **Front Ceiling**.

Installing for rear projection

1. Place the projector 1 to 10 m (3 to 33 ft) behind a translucent screen that is designed for rear projection.
See “Setting up the projector” on page 16 or “Installing on the ceiling” on page 49 for more instructions.
2. Press **enter**, go to **Setup > Advanced setup > Projector position**. Then select **Rear Table** or **Rear Ceiling**.

Locking the projector

The projector includes a built in slot to secure the projector with a cable and lock (such as the Kensington MicroSaver lock system, available at many computer stores).

1. Wrap the cable around a secure object, such as a table leg. Loop the cable to create a slip knot around the stationary object, and be sure it cannot slip off.
2. Insert the lock ❶ into the hole and twist the key ❷.





TIP: As an alternative, you can loop a cable or bracket around the projector handle to secure the projector in place.

Controlling an external accessory

If your projector has a 12-volt trigger output port, the projector can automatically control one or more accessories. Certain types of accessories can use a 12-volt signal to trigger their actions, such as a motorized screen lowering and raising the screen. The output provides a 12-volt dc signal whenever the projector is on (200 mA maximum current output).

Requires:

- Two-wire cable with 3.5-mm × 1.3-mm barrel connector (12 V on inner contact)

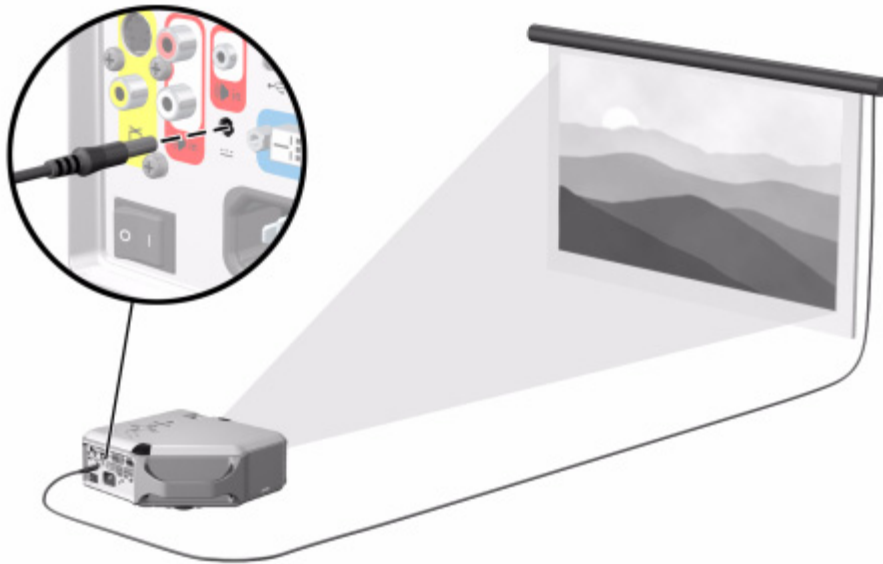

Connecting to a room controller

If your projector has a serial port, you can connect the projector to a room controller using a serial (RS-232) cable. After you program the room controller using the following commands, you can use the room controller to operate the projector and other components of your installation.

Serial connections

The serial port on the projector uses a standard serial (RS-232) cable:

- Pin 2: data sent to the projector (RxD)
- Pin 3: data sent from the projector (TxD)
- Pin 5: ground

The room controller must use the following serial (RS-232) settings:

- 9600 baud
- 1 start bit + 8 data bits (D0=LSB, D7=MSB) + 1 stop bit
- No parity
- Full duplex communication channels (no flow control)
- No handshaking

Examples of room controller commands

In the following examples, "<CR>" and "<LF>" represent a carriage return and line feed, respectively.

Commands are sent to the projector as "requests" which consist of an asterisk (*) prefix, the command name, any needed parameter, and a carriage return <CR> as a terminator:

* command = parameter <CR>

Requests can contain only ASCII alphanumeric characters. Blanks (spaces) are allowed, except within keywords and numbers. Line feeds <LF> are ignored.

The following table shows the specific syntax to use for various requested tasks.

To perform this task...	Use this request syntax...
Change a setting to a specified value	*command=value<CR>
Ask the current setting	*command=?<CR>
Increment a setting	*command=+<CR>
Decrement a setting	*command=-<CR>
Invoke an action (no parameter needed)	*command<CR>

In general, every request sent to the projector generates one or more notification messages, which are sent to the room controller. Actions initiated by the projector can also generate notifications.

The projector always sends notifications whenever a setting changes, whether as the result of a request from a controller, or as the result of an action, such as a button press or menu change. Some requested setting changes take time to perform, or are carried out in stages. Because of this, requests might produce delayed notifications.

The following table lists the types of notifications generated in various situations.

This type of request...	Generates this type of notification...
Modify a setting	Echoes the request command and shows the resulting value: Request: *BRT=65<CR> Notification: *BRT=65<CR><LF>
Query a setting	Echoes the request command and shows the resulting value: Request: *CON=?<CR> Notification: *CON=40<CR><LF>
Execute an action	Echoes the request command: Request: *NXT<CR> Notification: *NXT<CR><LF>

Incorrect commands cause the following types of notifications:

- No asterisk at start of command—no response
- Unrecognized command name—command with “?” added

- Command that is currently unavailable—command with “?” added
- Invalid parameter—command with current value
- Action command with unnecessary parameter—action command
- Action command that is unavailable—action command

The following simplified example shows how the projector typically responds to a request to change the active input source. Note that the three latter notifications are delayed.

Request: *RSRC=4<CR>
Notification: *RSRC=4<CR><LF> (acknowledges request)
 *SRC=0<CR><LF> (projector is attempting to acquire source 4, and in the interim has no valid source)
 *SRC=4<CR><LF> (source 4 is now active)
 *BRT=60<CR><LF> (brightness has been modified for source 4)
 *CSPC=?<CR><LF> (color space is not supported for this input)

Room controller commands

In the following tables, if the parameter listing for a particular command is “None,” that command requires no parameter. Some commands are valid only when the projector is turned on, STAT=1. Some commands are available only when specific input sources are active.

Source function

Command	Parameters	Description
SRC	?	Queries the current active input source: 0=no active source, 1=VGA-in, 3=composite video, 4=S-video, 8=DVI.
RSRC	1, 3, 4, 8, ?	Attempts to use the specified source as the active input source, or queries the last source requested: 1=VGA-in, 3=composite video, 4=S-video, 8=DVI.
NXT	None	Switches to the next input source.
AUTO	0, 1, ?	Sets or queries automatic searching inputs for signal: 0=no searching, 1=searching.

Video functions

Command	Parameters	Description
CSPC	0 to 2, ?	Sets or queries the active color space: 0=RGB, 1=YCbCr, 2=YCbCr.
PMOD	0,1,5,?	Sets or queries the picture mode: 0=graphics, 1=video, 5=custom.
VSHF	<i>value</i> , +, -, ?	Sets or queries the vertical shift of the projected image: usable range is determined by the active input source.
HSHF	<i>value</i> , +, -, ?	Sets or queries the horizontal shift of the projected image: usable range is determined by the active input source.
WHIT	0 to 10, +, -, ?	Sets or queries the white intensity.
BRT	0 to 100, +, -, ?	Sets or queries the brightness.
CON	0 to 100, +, -, ?	Sets or queries the contrast.
SAT	0 to 100, +, -, ?	Sets or queries the color saturation.
TNT	-45 to 45, +, -, ?	Sets or queries the tint.
CTMP	0 to 2, ?	Sets or queries the color temperature: 0=warm, 1=neutral, 2=cool.
SHRP	0 to 12, +, -, ?	Sets or queries the sharpness.
PENH	0 to 6, +, -, ?	Sets or queries the picture enhancement setting.
KEYV	-50 to 50, +, -, ?	Sets or queries the vertical keystone: 0=no keystone adjustment, 1 to 50=shrinks the top of the display, -1 to -50=shrinks the bottom of the display.
ASPT	0, 1, 4, ?	Sets or queries the aspect ratio: 0=1-to-1, 1=Best Fit, 4=Reduced.
SYNC	None	Automatically resynchronizes the projector to the active computer input source.
FREQ	-50 to 50, +, -, ?	Sets or queries the projector's timing relative to the active computer input source.
TRK	<i>value</i> , +, -, ?	Sets or queries the synchronization of the projector to the active computer input source.

Video functions (continued)

Command	Parameters	Description
VPOS	<i>value</i> , +, -, ?	Sets or queries the vertical positioning of the projected image: usable range is the maximum and minimum allowed by the active computer input source.
HPOS	<i>value</i> , +, -, ?	Sets or queries the horizontal positioning of the projected image: usable range is the maximum and minimum allowed by the active computer input source.
HIDE	0, 1, ?	Sets or queries picture blanking: 0=not hidden, 1=hidden.
WIDE	0, 1, ?	Sets or queries wide screen mode: 0=normal, 1=wide.
KEYR	None	Resets keystone to zero.

Audio functions

Command	Parameters	Description
MUTE	0, 1, ?	Sets or queries audio muting: 0=not muted, 1=muted.
VOL	0 to 31, +, -, ?	Sets or queries audio volume: 0=off, 31=maximum.
INTSP	0, 1, ?	Sets or queries usage of the internal speakers: 0=disabled, 1=enabled.

Setup functions

Command	Parameters	Description
LANG	0 to 10, ?	Sets or queries the language used by the projector: 0=English, 1=French, 2=Italian, 3=German, 4=Portuguese, 5=Spanish, 6=Traditional Chinese, 7=Simplified Chinese, 8=Korean, 9=Japanese, 10=Czech.
LSAV	0, 1, ?	Sets or queries low-power operating mode: 0=normal power, 1=low power.
LHRS	?	Queries the time (in tenths of hours) that the lamp has been in use.

Setup functions (continued)

Command	Parameters	Description
THRS	?	Queries the total time (in tenths of hours) that the projector has been in use.
POS	0 to 3, ?	Sets or queries the projector's position: 0=front table, 1=front ceiling, 2=rear table, 3=rear ceiling.
TMO	5 to 20, ?	Sets or queries the menu timeout setting (seconds)
PTMO	0, 3 to 6, ?	Sets or queries the power timeout: 0=never, 3=15 min, 4=30 min, 5=60 min, 6=120 min.
VERS	?	Queries the projector model number and firmware version. The notification takes this form: *VERS="proj_model:proj_fw"
SNUM	?	Queries the projector's serial number.

Power and status functions

Command	Parameters	Description
SHDN	None	Puts the projector into cool-down state, and later into standby state. The projector sends a notification when it enters cool-down state (STAT=3), and another when it enters standby state (STAT=0). This keyword requires the projector to be in its on state (STAT=1). Do not send any requests other than STAT in the time between the cool-down and standby state notifications. Otherwise, unexpected results can occur.
W or WAKE	None	Puts the projector into warm-up state, and later into on state. The projector sends a notification when it enters warm-up state (STAT=2), and another when it enters the on state (STAT=1). This keyword requires the projector to be in standby state (STAT=0). Do not send any requests other than STAT in the time between the warm-up and on state notifications. Otherwise, unexpected results can occur.

Power and status functions (continued)

Command	Parameters	Description
STAT	?	Queries the projector's current state: 0=standby state (off), 1=on, 2=warm-up state, 3=cool-down state.
ALERT	Not a request	Notifies when a system alert condition occurs: 0=lamp life warning, 1=lamp life reached, 2=lamp faulty, 3=lamp problem, 4=internal temperature too high, 5=fan problem, 6=ambient temperature too high, 7=color wheel problem, 8=lamp cover open. ALERT is sent only by the projector, and cannot be used in requests.

Simulated key presses

Command	Parameters	Description
BACK	None	Simulates pressing the Exit Arrow key on keypad
ENTER	None	Simulates pressing the ENTER key on keypad
LEFT	None	Simulates pressing the Left Arrow key on keypad
RIGHT	None	Simulates pressing the Right Arrow key on keypad
UP	None	Simulates pressing the Up Arrow key on keypad
DOWN	None	Simulates pressing the Down Arrow key on keypad

6 Fixing Problems

Troubleshooting suggestions

If you have a problem with your projector, check the following statement that most closely matches the nature of the problem, then look in that section of this chapter:

- “Warning light problems” on page 59
- “Start-up problems” on page 60
- “Picture problems” on page 60
- “Sound problems” on page 63
- “Interruption problems” on page 63
- “Remote control problems” on page 63



TIP: If these suggestions do not solve your problem, go to <http://www.hp.com/support> for additional information. To contact HP, refer to the support guide included with the projector.

Warning light problems

If both red warning lights are blinking:

- Allow the projector to cool down after it turns off. If this condition occurs after you restart the projector, an internal component has failed. Contact HP for assistance.

If the red temperature light is on or blinking:

- Allow the projector to cool down after it turns off. Be sure that nothing is near or blocking the vents on the projector, and that the vents are free of lint and other objects. Remove any sources of excess heat in the room. Observe temperature and altitude limits (see “Specifications” on page 65). If the warning light turns on or blinks after you restart the projector, contact HP for assistance.

If the red lamp light is on or blinking:

- Allow the projector to cool down after it turns off. If the warning light turns on or blinks after you restart the projector, install a new lamp. If this occurs after you install a new lamp module, remove and reinstall the lamp module. If a new lamp does not fix the problem, contact HP for assistance.

If the red lamp light is flickering quickly:

- Check that the cover over the lamp at the side of the projector is correctly installed and fully attached. Check the tab at the top of the cover and latch at the bottom.

Start-up problems

If no lights or sounds turn on:

- Be sure that the power cable is securely connected to the projector and the other end is plugged into an outlet with power.
- Be sure the main disconnect switch is turned on.
- Press the power button again.
- Unplug the power cord for 15 seconds, then plug it in and press the power button again.

Picture problems

If a “scanning” or “waiting” message is displayed on a blank screen:

- Press the **source** button on the projector or remote control one or more times until the correct source name is selected.
- Be sure the external source is turned on and connected.
- For a computer connection, ensure your notebook computer’s external video port is turned on. Refer to the computer manual. On some notebooks, for example, press the FN+F4 or FN+F5 function keys to turn on the external video port.

If the wrong input source is displayed:

- Press the **source** button on the projector or the remote control one or more times to select another active input source.

If the image is out of focus:

- Be sure the lens cover is open.
- While displaying the on-screen menu, adjust the focus ring. (The image size should not change; if it does, you are adjusting the zoom, not the focus.)
- Ensure the projection screen is 1 to 10 m (3 to 33 ft) from the projector.
- Check the projection lens to see if it needs cleaning.

- For a computer connection, set the display resolution as the computer to the same resolution as the projector, 800 × 600 or 1024 × 768 (see “Specifications” on page 65). If the computer has multiple monitors, adjust the resolution of the monitor assigned to the projector.
- For a computer connected to the S-video port, the picture cannot be as high resolution as what you see on the computer display.

If an upside-down or reversed image is displayed:

- The projector has been set to the wrong position setting. Press **enter**, go to **Setup > Advanced Setup > Projector position**, and select the correct setting.

If the image is too small or too large:

- Adjust the zoom ring on top of the projector.
- Move the projector closer to or farther from the screen.
- On the projector or remote control, press the picture mode  button one or more times to see if one of the picture modes makes the image the correct size.
- Press **enter**, go to **Picture > Customize picture mode > Stretch**. Try the different settings.
- If the source device sends wide-screen output, press **enter**, go to **Input**, and try setting **Widescreen input** to **Yes**. Otherwise, set it to **No**.

If the image has slanted sides:

- As much as possible, reposition the projector so that it is centered on the screen and below the bottom or above the top of the screen.
- On the projector, press the **keystone** button until the sides are vertical.

If the image is stretched:

- On the projector or remote control, press the picture mode  button one or more times to see if one of the picture modes makes the image the correct size.
- Press **enter**, go to **Picture > Customize picture mode > Stretch**. Try the different settings.
- If the source device sends wide-screen output, press **enter**, go to **Input**, and try setting **Widescreen input** to **Yes**. Otherwise, set it to **No**.

If the projected colors seem slightly wrong:

- See “Adjusting the picture for best color” on page 36.
- Press **enter**, go to **Help > Diagnostics**, and run the color test.

If the projected colors seem completely wrong:

- Be sure the pins on the cable connectors are not bent or broken.
- Press **enter**, go to **Picture > Color settings > Color space**. Try the different settings.

- Press **enter**, go to **Help > Diagnostics**, and run the color test.
- Press **enter**, go to **Picture > Color settings > Reset color settings**, and press **enter**.
- Press **enter**, go to **Setup > Reset all settings**, and press **enter**.

If the picture is not clear (ghost images, smearing, poor quality):

- Be sure the video cable you are using is coaxial cable rated at 75 ohms. Any other cable or impedance rating can reduce picture quality.
- The video cable connecting the video source to the projector probably must be higher quality. See “Choosing cables” on page 49.

If several picture settings seem completely wrong and you cannot fix them:

- Press **enter**, go to **Picture > Color settings > Reset color settings**, and press **enter**.
- Press **enter**, go to **Setup > Reset all settings**, and press **enter**.

If a scrolling or cut-off image is displayed for a computer connection:

- Press the **auto sync** button on the projector or remote control.
- Turn everything off. Then power on the projector first and power on the notebook or desktop computer second.
- If the previous steps do not correct the display image, adjust the resolution of the notebook or desktop computer to the same resolution as the projector, 800 × 600 or 1024 × 768 (see “Specifications” on page 65). If the computer has multiple monitors, adjust the resolution of the monitor assigned to the projector.

If the image is flickering or unstable for a computer connection:

- Press the **auto sync** button on the projector or remote control.
- Press **enter**, go to **Picture > VGA settings**, and adjust **Frequency** or **Tracking**.

If the image disappears from the computer screen:

- For a notebook computer, you might be able to turn on both the external VGA port and the built-in screen. Refer to the computer manual.
- Connect a monitor to the VGA-out port.

If text or lines from a computer display seem rough or uneven:

- Check the focus adjustment.
- Press **enter**, go to **Setup > Reset keystone**, and press **enter**.

Sound problems

If no sound is coming out of the projector:

- Be sure you have an audio cable securely connected between the projector and the source device.
- Press **enter**, go to **Sound**, and check that **Mute** is turned off and **Volume** is correct.
- Press **enter**, go to **Sound > Internal speakers**, and be sure the speakers are turned on.
- Press **enter**, go to **Help > Diagnostics**, and run the sound test.
- Be sure that the mute and volume settings are correct on the source device, such as a VCR, camcorder, or computer.

Interruption problems

If the projector stops responding to all controls:

- If possible, turn off the projector, then unplug the power cord and wait at least 15 seconds before reconnecting power.

If the lamp shuts off during a show:

- A minor power surge might cause the lamp to shut off. This is normal. Wait a few minutes, then power on the projector.
- If a red warning light is on or blinking, see “Warning light problems” on page 59.

If the lamp burns out or makes a popping sound:

- If the lamp burns out and makes a popping sound, the projector will not turn back on until the lamp module has been replaced.
- If the lamp breaks, contact HP about repairs that might be required due to glass fragments.

Remote control problems

If the remote control does not operate:

- Be sure nothing is blocking the remote control receiver on the front or back of the projector. Move to within 9 m (30 ft) of the projector.
- Aim the remote control at the screen or at the front or back of the projector.
- Move the remote control so it is more directly in front of or behind the projector and not as far to the side.
- Press **enter**, go to **Help > Diagnostics**, and run the remote control test.
- Replace the battery in the remote control.

Testing the projector

Running the projector diagnostics

The on-screen menu contains diagnostic tests you can use to verify the proper operation of the projector and the remote control.

1. Press **enter** and go to **Help > Diagnostics**.
2. Select a test and press **enter**.
3. Follow the displayed instructions.

7 Reference

This chapter lists the specifications, safety information, and regulatory information for the projector.

Specifications

Because HP continually improves its products, the following specifications are subject to change. For the latest specifications, visit the HP website at <http://www.hp.com>.

Projector Specifications

Size	280 × 255 × 102 mm (11.0 × 10.1 × 4.0 in.)
Weight	3.5 kg (7.7 lb)
Resolution	vp6310 series: SVGA (800 × 600) vp6320 series: XGA (1024 × 768)
Technology	DLP
Video connectors	VGA-in (D-sub) with optional cable for component-video input VGA-out (D-sub) S-video (mini-DIN) Composite video (RCA) DVI-D (vp6320 series)
Audio connectors	Stereo-in (2 RCA and mini-phone)
Other connectors	USB 1.1 type B RS-232 control (vp6320 series) 12-Vdc trigger output (vp6320 series)
Video compatibility	NTSC 3.58 MHz and 4.43 MHz PAL B, D, G, H, I, M, N SECAM B, D, G, K, K1, L HDTV (480i/p, 575i/p, 720p, 1080i) DVI with HDCP (vp6320 series) PC video up to SXGA

Projector Specifications (continued)

IR receivers	Front and back of projector
Lamp	210-watt lamp 4000-hour average lamp life (to half of original brightness) Lamp saver mode reduces lamp power to 168 watts Replacement lamp: L1695A
Optics	1 to 10 m (3 to 33 ft) focus range 1.16:1 optical zoom vp6310 series: 1.7 to 2.0 throw ratio (distance/width) 128% offset (relative to half-height) vp6320 series: 1.8 to 2.1 throw ratio (distance/width) 125% offset (relative to half-height)
Light engine	vp6310 series: 0.55-in. 12° DDR DMD vp6320 series: 0.7-in. 12° DDR DMD
Audio	Monaural speaker, 6-watt peak output
Noise level	less than 36 dBA
Vertical tilt	0° to 9°
Vertical keystone correction	±20%
Remote control	USB mouse
Mounting options	Ceiling and tabletop, front and rear projection
Security	Kensington lock compatible Unlock sequence protects against unauthorized use
Power	100 to 240 V at 50 to 60 Hz

Projector Specifications (continued)

Environment

Operating:

Temperature: 10 to 35 °C (50 to 95 °F)

Humidity: 80% RH max, non-condensing

Altitude: up to 3,000 m (10,000 ft), up to 25 °C (77 °F)

Storage:

Temperature: -20 to 55 °C (-4 to 131 °F)

Humidity: 80% RH max, non-condensing

Altitude: up to 12,000 m (40,000 ft)

Video mode compatibility

Compatibility	Resolution	Refresh rates (Hz)
Analog		
VGA	640 × 350	70, 85
	640 × 400	85
	640 × 480	60, 66.66, 66.68, 72, 75, 85
	720 × 400	70, 85
SVGA	800 × 600	56, 60, 72, 75, 85
	832 × 624	74.55
XGA	1024 × 768	60, 70, 75, 85
	1152 × 870	75, 75.06
	1280 × 960	75
SXGA	1280 × 1024	60, 75
SXGA+	1400 × 1050	60
Digital (vp6320 series)		
VGA	640 × 350	70, 85
	640 × 400	85

Video mode compatibility (continued)

Compatibility	Resolution	Refresh rates (Hz)
	640 × 480	60, 72, 75, 85
	720 × 400	70, 85
SVGA	800 × 600	56, 60, 72, 75, 85
XGA	1024 × 768	60, 70, 75
SXGA	1280 × 1024	60, 75
SXGA+	1400 × 1050	60

Safety information

LED safety

The infrared ports located on the digital projector and remote control are classified as Class 1 LED devices according to International Standard IEC 825-1 (EN60825-1). This device is not considered harmful, but the following precautions are recommended:

- If the unit requires service, contact an authorized HP service center.
- Do not attempt to make any adjustment to the unit.
- Avoid direct eye exposure to the infrared LED beam. Be aware that the beam is invisible light and cannot be seen.
- Do not attempt to view the infrared LED beam with any type of optical device.

Mercury safety



WARNING! This digital projector lamp contains a small amount of mercury. If the lamp breaks, adequately ventilate the area where the breakage occurred. Disposal of the lamp might be regulated due to environmental considerations. For disposal or recycling information, contact your local authorities or the Electronic Industries Alliance at <http://www.eiae.org>.

Regulatory information

This section presents information that shows how your digital projector complies with regulations in certain regions. Any modifications to your digital projector not expressly approved by HP could void the authority to operate the digital projector in these regions.

U.S.A.

This digital projector has been tested and found to comply with the limits for a Class B digital device, pursuant to Part 15 of the FCC Rules. These limits are designed to provide reasonable protection against harmful interference in a residential installation.

This digital projector generates, uses, and can radiate radio frequency energy. If not installed and used in accordance with the instructions, it can cause harmful interference to radio communications. However, there is no guarantee that interference will not occur in a particular installation. If this digital projector does cause harmful interference to radio or television reception (which can be determined by unplugging the unit), try the following:

- Reorienting or relocating the receiving antenna.
- Relocating the digital projector with respect to the receiver.
- Connecting the digital projector's power cord to another power outlet.

Connections to peripheral devices

To maintain compliance with FCC Rules and Regulations, use properly shielded cables with this device.

For more information, consult your dealer, an experienced radio/television technician, or, prepared by the Federal Communications Commission, How to Identify and Resolve Radio-TV Interference Problems. This booklet is available from the U.S. Government Printing Office, Washington, DC 20402, Stock Number 004-000-00345-4. At the first printing of this manual, the telephone number was 202-512-1800.

Canada

This Class B digital apparatus complies with Canadian ICES-003.

Japan

この装置は、情報処理装置等電波障害自主規制協議会（VCCI）の基準に基づくクラスB情報技術装置です。この装置は、家庭環境で使用することを目的としていますが、この装置がラジオやテレビジョン受信機に近接して使用されると受信障害を引き起こすことがあります。

取り扱い説明書に従って正しい取り扱いをして下さい。

製品には、同梱された電源コードをお使い下さい。
同梱された電源コードは、他の製品では使用出来ません。

Korea

사용자 안내문 : **B** 급 기기

이 기기는 비업무용으로 전자파적합등록을 받은 기기이오니, 주거지역에서는 물론, 모든 지역에서 사용하실 수 있습니다.

International

For regulatory identification purposes, your product is assigned a regulatory model number. The regulatory model number for your product is listed in the declaration of conformity. This regulatory number is different from the marketing name and product number.

Regulatory model number: CRVSB-05CE

Declaration of conformity

According to ISO/IEC Guide 22 and EN 45014
Manufacturer's name: Hewlett Packard Company
Manufacturer's address: Hewlett Packard Company
Digital Projection & Imaging
1000 NE Circle Blvd.
Corvallis, OR 97330-4239

Declares, that the product(s):

Product name: Digital Projector
Model numbers: vp6310/vp6320 series
Regulatory model: CRVSB-05CE

Conforms to the following product specifications:

Safety:

IEC 60950:1999/ EN 60950:2000
IEC 60825-1:1993 +A1 / EN 60825-1:1994 +A11 Class 1 LED
GB4943-1995

EMC:

EN 55022 +A1 Class B: 1998 [1]
CISPR 24:1997 / EN 55024 +A1:2001
IEC 61000-3-2:1995 / EN 61000-3-2:2000
IEC 61000-3-3:1994 / EN 61000-3-3:1995+A1:2001
GB9254-1998
FCC Title 47 CFR, Part 15 Class B/ANSI C63.4:1992
AS/NZS 3548:1995 Rules and Regulations of Class B
VCCI

Supplementary information:

The product herewith complies with the requirements of following Directives and carries the CE marking accordingly:

-Low Voltage Directive: 73/23/EEC

-EMC Directive: 89/336/EEC

[1] The product was tested in a typical configuration with Hewlett Packard Personal Computer peripherals.

This device complies with Part 15 of the FCC Rules. Operation is subject to the following two conditions: (1) this device may not cause harmful interference, and (2) this device must accept any interference received, including interference that may cause undesired operation.

Corvallis, Oregon, January 15, 2005



A handwritten signature in black ink, appearing to read 'Steve Brown'.

Steve Brown, General Manager

European Contact for regulatory topics only: Hewlett Packard GmbH, HQ-TRE, Herrenberger Straße 140, 71034 Boeblingen, Germany. (FAX:+49-7031-143143).

USA Contact: Hewlett Packard Co., Corporate Product Regulations Manager, 3000 Hanover Street, Palo Alto, CA 94304. Phone: (650) 857-1501.

Index

A

- accessories 15
- adjusting
 - color 36
 - picture 33
 - setup 37
 - shape of picture 34
 - slanted picture 35
 - sound 33
- aiming projector 28
- analog video mode
 - compatibility 67
- audio
 - adjusting 33
 - ports 12
 - troubleshooting 63

B

- buttons
 - location 11
 - opening menu 38

C

- cables
 - choosing 49
 - connections 22
- ceiling installation 49
- choosing cables 49
- cleaning 7, 43
- component-video
 - connecting source 23
 - port 12
- composite-video
 - connecting source 25
 - port 12
- computer screen, showing 31
- computer, connecting 20

connecting

- component-video source 23
 - composite-video source 25
 - computer 20
 - DVI source 22
 - external accessory 51
 - handheld organizer 21
 - power 19
 - SCART source 22
 - S-video source 24
- ## controlling external accessory 51

D

- diagnostics 64
- digital video mode
 - compatibility 67
- DVI video
 - connecting source 22
 - port 12

E

- external accessory 51

F

- firmware, updating 47
- focus 28

H

- handheld organizer,
 - connecting 21
- hiding picture 31

I

- image. See picture
- installing projector 16, 49

L

- lamp, replacing 44
- LED safety 68
- lens, cleaning 43
- lights. See lamp; warning lights
- locking projector 37, 50

M

- menu
 - language 41
 - listing 38
 - using 38
- mercury safety 68
- moving projector 27

O

- on-screen menu. See menu

P

- PC. See computer
- picture
 - focus 28
 - hiding and showing 31
 - quality of 16, 22, 62
 - troubleshooting 60
 - zoom 28
- picture mode, choosing 33
- power
 - connecting 19
 - turning off 27
 - turning on 26
- presentations, showing 31
- projector, locking 37

Q

- quality of picture 16, 22, 62

R

- rear projection installation 50
- regulatory information 69
- remote control
 - buttons 14
 - installing batteries 46
 - opening menu 38
 - troubleshooting 63
 - using 29
- replacing lamp 44
- room controller 52
- room layout 16
- RS-232 52

S

- safety information 7, 68
- SCART 22
- screen
 - controlling 51
 - positioning 17
- security
 - locking cable 50
 - security code 37
- selecting video source 31
- serial port 52
- setting up 16
- shape, adjusting 34
- showing picture 31
- showing presentations 31
- slanted picture, adjusting 35
- specifications 65
- S-video
 - connecting source 24
 - port 12

T

- table installation 16, 49
- triggering external accessory 51

- troubleshooting
 - audio 63
 - interruptions 63
 - picture 60
 - remote control 63
 - start-up 60
 - warning lights 59
- turning on and off 26

U

- unlocking projector 37
- updating firmware 47
- upgrading projector 47
- USB, connecting 20
- using remote control 29

V

- VGA
 - connecting source 20, 21
 - port 12
- video mode compatibility 67
- video source, selecting 31

W

- warning lights
 - location 11
 - meanings 59
 - troubleshooting 59

Y

- YPbPr. See component-video

Z

- zoom 28

Mercury Safety

WARNING: This digital projector lamp contains a small amount of mercury. If the lamp breaks, adequately ventilate the area where the breakage occurred, discard any nearby food and drink, and thoroughly clean the table surface around the projector. Wash your hands after cleaning the area or handling a broken lamp. Disposal of this lamp may be regulated due to environmental considerations. For disposal or recycling information, please contact your local authorities or the Electronic Industries Alliance (www.eiae.org). You can find safety information about the lamp at www.hp.com/hpinfo/globalcitizenship/environment/productdata.