

**SANYO**

---

**Multimedia Projector**

**MODEL PLC-SU33**

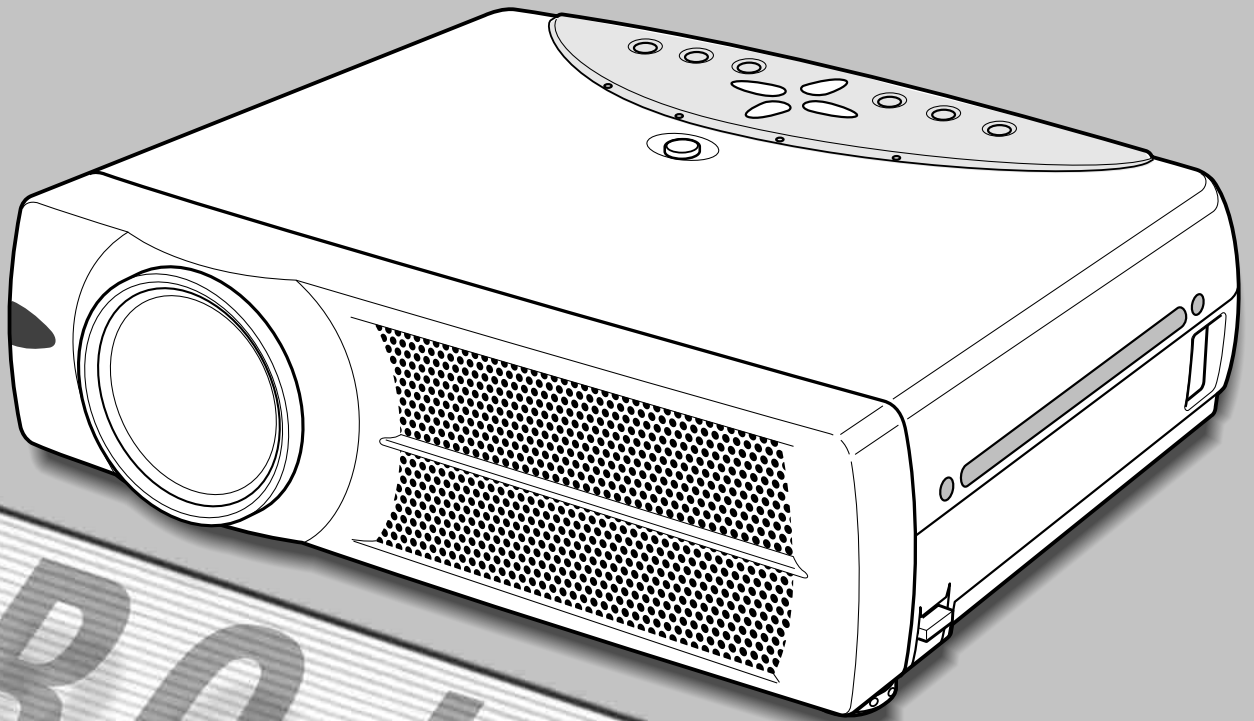

**Owner's Manual**

**ProSelecta**

View :: Compare :: Select - [www.ProSelecta.com](http://www.ProSelecta.com)

# TO THE OWNER

Before operating this projector, read this manual thoroughly and operate the projector properly. This projector provides many convenient features and functions. Operating the projector properly enables you to manage those features and maintains it in better condition for a considerable time. Improper operation may result in not only shortening the product-life, but also malfunctions, fire hazard, or other accidents. If your projector seems to operate improperly, read this manual again, check operations and cable connections and try the solutions in the "TROUBLESHOOTING" section at the end of this booklet. If the problem still persists, contact the sales dealer where you purchased the projector or the service center.



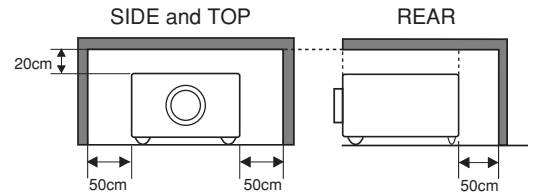

## SAFETY PRECAUTIONS

**WARNING : TO REDUCE THE RISK OF FIRE OR ELECTRIC SHOCK, DO NOT EXPOSE THIS APPLIANCE TO RAIN OR MOISTURE.**

- This projector produces intense light from the projection lens. Do not stare directly into the lens as possible. It could damage your eyes. Be especially careful that children do not stare directly into the beam.
- This projector should be set in the way indicated. If not, it may result in a fire hazard.
- Take appropriate space on the top, sides and rear of the projector cabinet for allowing air circulation and cooling the projector. Minimum distance should be taken. If the projector is to be built into a compartment or similarly enclosed, the minimum distances must be maintained. Do not cover the ventilation slot on the projector. Heat build-up can reduce the service life of your projector, and can also be dangerous.
- Do not put any flammable object or spray can near the projector, hot air is exhausted from the ventilation holes.
- If the projector is not to be used for an extended time, unplug the projector from the power outlet.



**READ AND KEEP THIS OWNER'S MANUAL FOR LATER USE.**

	<b>CAUTION</b> <b>RISK OF ELECTRIC SHOCK</b> <b>DO NOT OPEN</b>	
<b>CAUTION : TO REDUCE THE RISK OF ELECTRIC SHOCK, DO NOT REMOVE COVER (OR BACK). NO USER-SERVICEABLE PARTS INSIDE EXCEPT LAMP REPLACEMENT. REFER SERVICING TO QUALIFIED SERVICE PERSONNEL.</b>		
 THIS SYMBOL INDICATES THAT DANGEROUS VOLTAGE CONSTITUTING A RISK OF ELECTRIC SHOCK IS PRESENT WITHIN THIS UNIT.	 THIS SYMBOL INDICATES THAT THERE ARE IMPORTANT OPERATING AND MAINTENANCE INSTRUCTIONS IN THE OWNER'S MANUAL WITH THIS UNIT.	

# SAFETY INSTRUCTIONS

All the safety and operating instructions should be read before the product is operated.

Read all of the instructions given here and retain them for later use. Unplug this projector from AC power supply before cleaning. Do not use liquid or aerosol cleaners. Use a damp cloth for cleaning.

Follow all warnings and instructions marked on the projector.

For added protection to the projector during a lightning storm, or when it is left unattended and unused for long periods of time, unplug it from the wall outlet. This will prevent damage due to lightning and power line surges.

---

Do not expose this unit to rain or use near water... for example, in a wet basement, near a swimming pool, etc...

Do not use attachments not recommended by the manufacturer as they may cause hazards.

Do not place this projector on an unstable cart, stand, or table. The projector may fall, causing serious injury to a child or adult, and serious damage to the projector. Use only with a cart or stand recommended by the manufacturer, or sold with the projector. Wall or shelf mounting should follow the manufacturer's instructions, and should use a mounting kit approved by the manufacturers.

An appliance and cart combination should be moved with care. Quick stops, excessive force, and uneven surfaces may cause the appliance and cart combination to overturn.



---

Slots and openings in the back and bottom of the cabinet are provided for ventilation, to insure reliable operation of the equipment and to protect it from overheating.

The openings should never be covered with cloth or other materials, and the bottom opening should not be blocked by placing the projector on a bed, sofa, rug, or other similar surface. This projector should never be placed near or over a radiator or heat register.

This projector should not be placed in a built-in installation such as a book case unless proper ventilation is provided.

Never push objects of any kind into this projector through cabinet slots as they may touch dangerous voltage points or short out parts that could result in a fire or electric shock. Never spill liquid of any kind on the projector.

This projector should be operated only from the type of power source indicated on the marking label. If you are not sure of the type of power supplied, consult your authorized dealer or local power company.

Do not overload wall outlets and extension cords as this can result in fire or electric shock. Do not allow anything to rest on the power cord. Do not locate this projector where the cord may be damaged by persons walking on it.

Do not attempt to service this projector yourself as opening or removing covers may expose you to dangerous voltage or other hazards. Refer all servicing to qualified service personnel.

Unplug this projector from wall outlet and refer servicing to qualified service personnel under the following conditions:

- a. When the power cord or plug is damaged or frayed.
- b. If liquid has been spilled into the projector.
- c. If the projector has been exposed to rain or water.
- d. If the projector does not operate normally by following the operating instructions. Adjust only those controls that are covered by the operating instructions as improper adjustment of other controls may result in damage and will often require extensive work by a qualified technician to restore the projector to normal operation.
- e. If the projector has been dropped or the cabinet has been damaged.
- f. When the projector exhibits a distinct change in performance-this indicates a need for service.

When replacement parts are required, be sure the service technician has used replacement parts specified by the manufacturer that have the same characteristics as the original part. Unauthorized substitutions may result in fire, electric shock, or injury to persons.

Upon completion of any service or repairs to this projector, ask the service technician to perform routine safety checks to determine that the projector is in safe operating condition.

---

## Voor de klanten in Nederland



Bij dit product zijn batterijen geleverd. Wanneer deze leeg zijn, moet u ze niet weggooien maar inleveren als KCA.

# COMPLIANCES

## Federal Communication Commission Notice

Note : This equipment has been tested and found to comply with the limits for a Class B digital device, pursuant to part 15 of the FCC Rules. These limits are designed to provide reasonable protection against harmful interference in a residential installation. This equipment generates, uses and can radiate radio frequency energy and, if not installed and used in accordance with the instructions, may cause harmful interference to radio communications. However, there is no guarantee that interference will not occur in a particular installation. If this equipment does cause harmful interference to radio or television reception, which can be determined by turning the equipment off and on, the user is encouraged to try to correct the interference by one or more of the following measures :

- Reorient or relocate the receiving antenna.
- Increase the separation between the equipment and receiver.
- Connect the equipment into an outlet on a circuit different from that to which the receiver is connected.
- Consult the dealer or an experienced radio/TV technician for help.

Use of shielded cable is required to comply with class B limits in Subpart B of Part 15 of FCC Rules.

Do not make any changes or modifications to the equipment unless otherwise specified in the instructions. If such changes or modifications should be made, you could be required to stop operation of the equipment.

Model Numbers : PLC-SU33  
Trade Name : Sanyo  
Responsible party : SANYO FISHER COMPANY  
Address : 21605 Plummer Street, Chatsworth, California 91311  
Telephone No. : (818)998-7322

## AC POWER CORD REQUIREMENT

The AC Power Cord supplied with this projector meets the requirement for use in the country you purchased it.

### AC Power Cord for the United States and Canada :

AC Power Cord used in the United States and Canada is listed by the Underwriters Laboratories (UL) and certified by the Canadian Standard Association (CSA).

AC Power Cord has a grounding-type AC line plug. This is a safety feature to be sure that the plug will fit into the power outlet. Do not try to defeat this safety feature. Should you be unable to insert the plug into the outlet, contact your electrician.



### AC Power Cord for the United Kingdom :

This cord is already fitted with a moulded plug incorporating a fuse, the value of which is indicated on the pin face of the plug. Should the fuse need to be replaced, an ASTA approved BS 1362 fuse must be used of the same rating, marked thus  $\diamond$ . If the fuse cover is detachable, never use the plug with the cover omitted. If a replacement fuse cover is required, ensure it is of the same colour as that visible on the pin face of the plug (i.e. red or orange). Fuse covers are available from the Parts Department indicated in your User Instructions.

If the plug supplied is not suitable for your socket outlet, it should be cut off and destroyed.

The end of the flexible cord should be suitably prepared and the correct plug fitted. (See Over)

**WARNING : A PLUG WITH BARED FLEXIBLE CORD IS HAZARDOUS IF ENGAGED IN A LIVE SOCKET OUTLET.**

The Wires in this mains lead are coloured in accordance with the following code:

Green-and-yellow ..... Earth  
Blue ..... Neutral  
Brown ..... Live

As the colours of the wires in the mains lead of this apparatus may not correspond with the coloured markings identifying the terminals in your plug proceed as follows:

The wire which is coloured green-and-yellow must be connected to the terminal in the plug which is marked by the letter E or by the safety earth symbol  $\perp$  or coloured green or green-and-yellow.

The wire which is coloured blue must be connected to the terminal which is marked with the letter N or coloured black.

The wire which is coloured brown must be connected to the terminal which is marked with the letter L or coloured red.

**WARNING : THIS APPARATUS MUST BE EARTHED.**

**THE SOCKET-OUTLET SHOULD BE INSTALLED NEAR THE EQUIPMENT AND EASILY ACCESSIBLE.**

# TABLE OF CONTENTS

## FEATURES AND DESIGN 6

## PREPARATION 7

NAME OF EACH PART OF PROJECTOR	7
SETTING-UP PROJECTOR	8
CONNECTING AC POWER CORD	8
POSITIONING PROJECTOR	9
ADJUSTABLE FEET	9
MOVING PROJECTOR	10

## CONNECTING PROJECTOR 11

TERMINALS OF PROJECTOR	11
CONNECTING TO COMPUTER	12
CONNECTING TO VIDEO EQUIPMENT	13

## BEFORE OPERATION 14

OPERATION OF REMOTE CONTROL UNIT	14
REMOTE CONTROL BATTERIES INSTALLATION	15
TOP CONTROLS AND INDICATORS	16
OPERATING ON-SCREEN MENU	17
HOW TO OPERATE ON-SCREEN MENU	17
FLOW OF ON-SCREEN MENU OPERATION	17
MENU BAR	18

## BASIC OPERATION 19

TURNING ON / OFF PROJECTOR	19
ADJUSTING SCREEN	20
ZOOM ADJUSTMENT	20
FOCUS ADJUSTMENT	20
KEystone ADJUSTMENT	20
PICTURE FREEZE FUNCTION	20
NO SHOW FUNCTION	21
P-TIMER FUNCTION	21
SOUND ADJUSTMENT	21

## COMPUTER INPUT 22

SELECTING INPUT SOURCE	22
SELECTING COMPUTER SYSTEM	22
COMPATIBLE COMPUTER SPECIFICATIONS	23
PC ADJUSTMENT	24
AUTO PC ADJUSTMENT	24
MANUAL PC ADJUSTMENT	25
PICTURE IMAGE ADJUSTMENTS	27
IMAGE LEVEL SELECT	27
IMAGE LEVEL ADJUSTMENT	28
PICTURE SCREEN ADJUSTMENT	29

## VIDEO INPUT 30

SELECTING INPUT SOURCE	30
SELECTING VIDEO SYSTEM	31
PICTURE IMAGE ADJUSTMENTS	32
IMAGE LEVEL SELECT	32
IMAGE LEVEL ADJUSTMENT	33
PICTURE SCREEN ADJUSTMENT	34

## SETTING 35

SETTING MENU	35
--------------	----

## APPENDIX 37

LAMP REPLACEMENT	37
LAMP REPLACE	37
LAMP REPLACE COUNTER	38
OPERATING WIRELESS MOUSE	39
MAINTENANCE	40
WARNING TEMP. INDICATOR	40
AIR FILTER CARE AND CLEANING	40
CLEANING PROJECTION LENS	40
TROUBLESHOOTING	41
TECHNICAL SPECIFICATIONS	43
CONFIGURATIONS OF TERMINALS	44
OPTIONAL PARTS	45

### TRADEMARKS

- Apple, Macintosh, and PowerBook are trademarks or registered trademarks of Apple Computer, Inc.
- IBM, VGA, XGA, and PS/2 are trademarks or registered trademarks of International Business Machines, Inc.
- Windows and PowerPoint are registered trademarks of Microsoft Corporation.
- Each name of corporations or products in the owner's manual is a trademark or a registered trademark of its respective corporation.

# FEATURES AND DESIGN

This Multimedia Projector is designed with the most advanced technology for portability, durability, and ease of use. This projector utilizes built-in multimedia features, a palette of 16.77 million colors, and matrix liquid crystal display (LCD) technology.

## ◆ Compact Design

---

This projector is extremely compact in size and weight. It is designed to carry and work anywhere you wish to use.

## ◆ Short Zoom Lens

---

Short Zoom Lens allows you to enjoy a larger screen even in the limited space.

## ◆ Compatibility

---

This projector widely accepts various video and computer input signals including;

- **Computers**  
IBM-compatible or Macintosh computer up to 1280 x 1024 resolution.
- **6 Color Systems**  
NTSC, PAL, SECAM, NTSC 4.43, PAL-M or PAL-N color system can be connected.
- **Component Video**  
Component video signal, such as a DVD player output high definition TV signals including 480i, 480p, 575i, 575p, 720p, 1035i or 1080i, can be connected.
- **S-Video**  
S-Video signal, such as a S-VHS VCR output signal, can be connected.

## ◆ High Resolution Image

---

This projector provides 800 x 600 dots resolution for computer input and 750 horizontal TV lines. Resolution from a computer between SVGA (800 x 600) and SXGA (1280 x 1024) is compressed into 800 x 600 dots. This projector cannot display image of over 1280 x 1024 dots. When resolution of your computer is over than 1280 x 1024, reset a computer output for lower resolution.

## ◆ Multi-Scan System

---

This projector has Multi-Scan System to conform to almost all computer output signals quickly. There is no need for troublesome manual adjustment of frequency and other settings.

## ◆ One-Touch Auto PC Adjustment

---

Incoming computer video signals are recognized and the best adjustment is automatically set by Auto PC Adjustment. No complicated setup is necessary and projection is always precise.

## ◆ Digital Zoom (for Computer)

---

Digital Zoom function adjusts the image size to approx. 1/4 ~ 49 times of original image size, allowing you to focus on crucial information at a presentation.

## ◆ Keystone Correction

---

Positioning height of a projector may result in a distorted image being displayed in a trapezoid shape. Keystone Correction solves this problem by digitally altering projection to produce undistorted images.

## ◆ Power Management

---

Power Management function is provided to reduce power consumption while a projector is not in use. This Power Management function operates to turn Projection Lamp off when a projector detects signal interruption and any button is not pressed over 5 minutes. Projection Lamp is automatically turned on again when a projector detects signal or any operation button is pressed. This projector is shipped with this function ON.

## ◆ Digital Visual Interface

---

This projector is equipped with DVI 29-pin terminal for connecting DVI output from a computer.

## ◆ Wireless Mouse

---

Remote Control Unit supplied with this projector has Wireless Mouse function for a connected computer. This function enables you to operate both projector and computer with Remote Control Unit only.

## ◆ Multilanguage Menu Display

---

Operation menu is displayed in; English, German, French, Italian, Spanish, Portuguese, Dutch, Swedish, Chinese, Korean or Japanese.

## ◆ Media Card Imager (Optional)

---

Optional Media Card Imager is available for this projector. For the Media Card Imager, contact the dealer where you purchased this projector.

## ◆ Wireless Imager (Optional)

---

This projector can be operated through Wireless LAN by attaching Wireless imager that is optionally supplied. For the Wireless Imager, contact the dealer where you purchased the projector.

# PREPARATION

## NAME OF EACH PART OF PROJECTOR

### FRONT

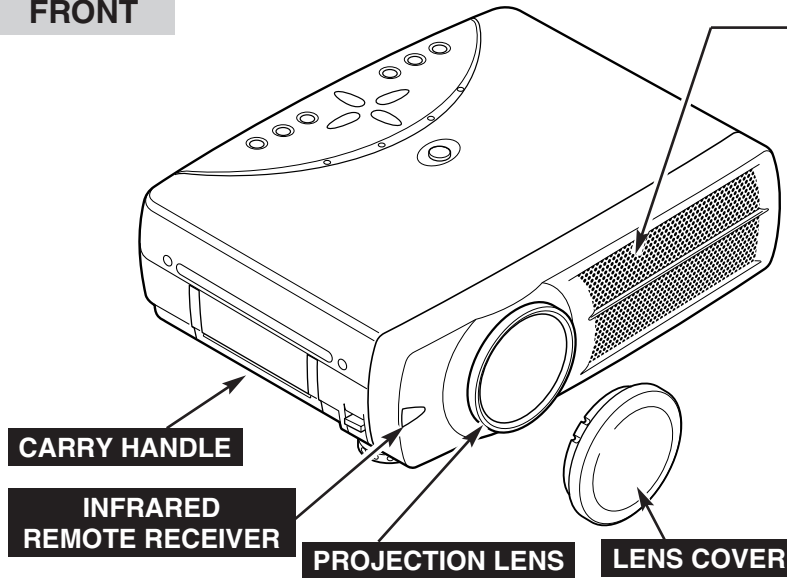

### EXHAUST VENTS



### HOT AIR EXHAUSTED !

Air blown from Exhaust Vents is hot. When using or installing projector, following precautions should be taken.

- Do not put any flammable object near these vents.
- Keep front grills at least 3'(1m) away from any object, especially heat-sensitive object.
- Do not touch this area, especially screw and metallic part. This area will become hot while a projector is used.

This projector detects internal temperature and automatically controls operating power of Cooling Fans.

### BACK

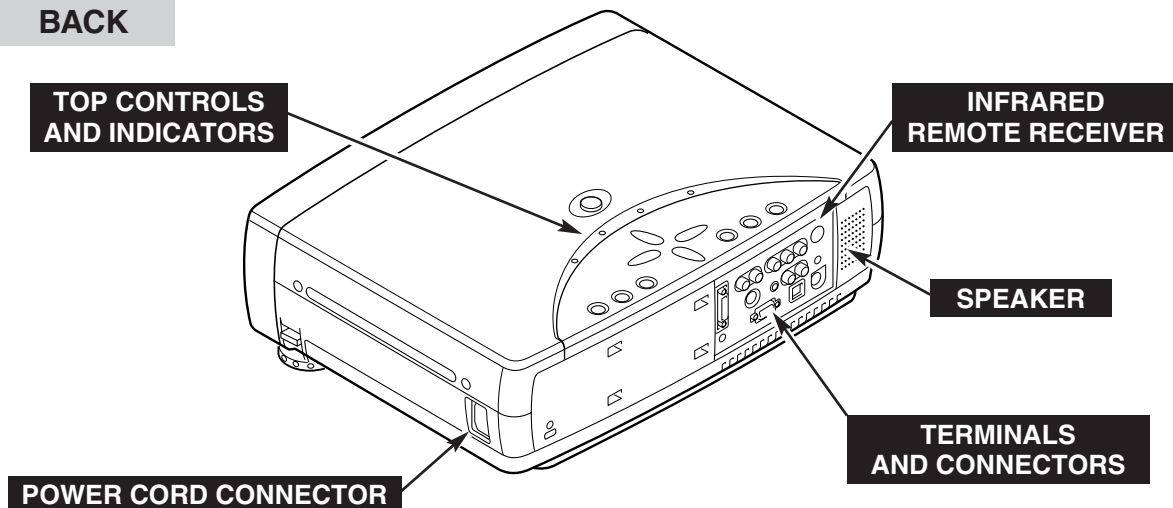

### BOTTOM

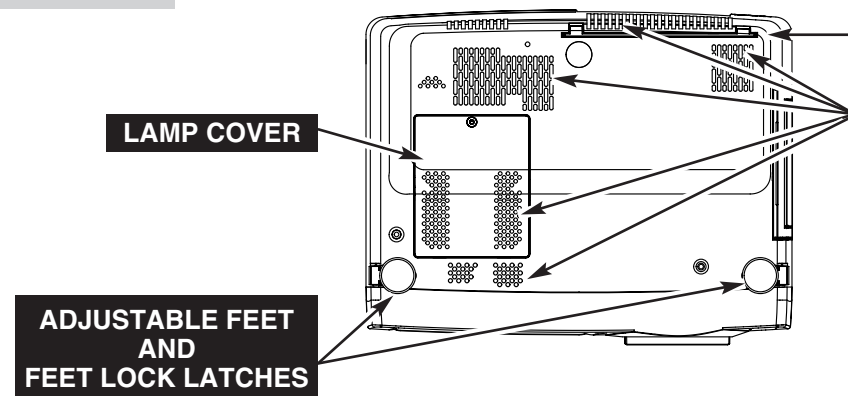

### AIR FILTER

### AIR INTAKE VENTS (Back and Bottom)

This projector is equipped with Cooling Fans for protection from overheating. Pay attention to the following to ensure proper ventilation and avoid a possible risk of fire and malfunction.

- Do not cover vent slots.
- Keep back and bottom clear of any object. Obstructions may block cooling air.

# SETTING-UP PROJECTOR

## CONNECTING AC POWER CORD

This projector uses nominal input voltages of 100-120 V or 200-240 V AC. This projector automatically selects the correct input voltage. It is designed to work with single-phase power systems having a grounded neutral conductor. To reduce risk of electrical shock, do not plug into any other type of power system. Consult your authorized dealer or service station if you are not sure of the type of power supply being in use. Connect a projector with a peripheral equipment before turning a projector on. (Refer to pages 11 ~ 13 for connection.)

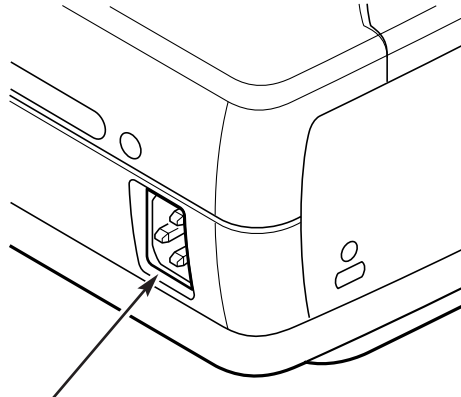

Connect AC Power Cord (supplied) to a projector. The AC outlet must be near this equipment and must be easily accessible.



### CAUTION

For safety, unplug AC Power Cord when an appliance is not used. When this projector is connected to the outlet with AC Power Cord, an appliance is in Stand-by Mode and consumes a little electric power.

### NOTE ON THE POWER CORD

AC Power Cord must meet requirement of the country where you use a projector. Confirm an AC plug type with the chart below and proper AC Power Cord must be used. If supplied AC Power Cord does not match your AC outlet, contact your sales dealer.

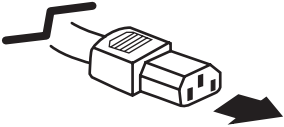
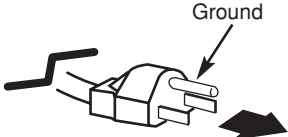
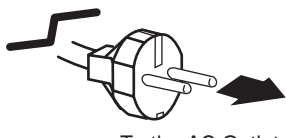
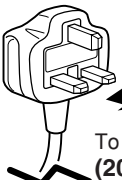
Projector side	AC Outlet side		
 <p data-bbox="240 1373 456 1444">To POWER CORD CONNECTOR on your projector.</p>	<p data-bbox="493 1171 797 1199">For the U.S.A. and Canada</p>  <p data-bbox="623 1381 792 1436">To the AC Outlet. (120 V AC)</p>	<p data-bbox="828 1171 1131 1199">For Continental Europe</p>  <p data-bbox="948 1394 1133 1449">To the AC Outlet. (200 - 240 V AC)</p>	<p data-bbox="1230 1171 1382 1199">For the U.K.</p>  <p data-bbox="1279 1373 1464 1428">To the AC Outlet. (200 - 240 V AC)</p>



## POSITIONING PROJECTOR

- This projector is designed to project on a flat projection surface.
- The projector can be focused from 3.0'(0.9m) ~ 22.6'(6.9m).
- Refer to the figure below to adjust a screen size.

H1 : H2 = 9 : 1

### ROOM LIGHT

The brightness in a room has a great influence on picture quality. It is recommended to limit ambient lighting in order to provide the best image.

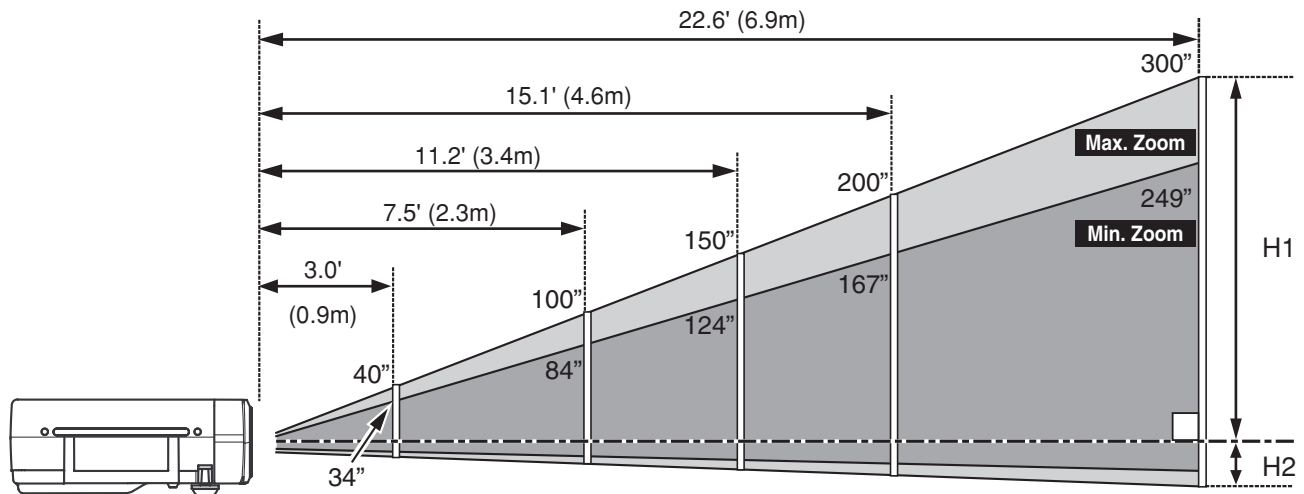

Screen Size (W x H) mm	34"	40"	100"	150"	200"	300"
Zoom (min)	3.0' (0.9m)	3.6' (1.1m)	8.9' (2.7m)	13.5' (4.1m)	18.0' (5.5m)	—
Zoom (max)	—	3.0' (0.9m)	7.5' (2.3m)	11.2' (3.4m)	15.1' (4.6m)	22.6' (6.9m)

## ADJUSTABLE FEET

Picture tilt and projection angle can be adjusted by rotating ADJUSTABLE FEET. Projection angle can be adjusted up to 15.6 degrees.

- 1 Lift the front of the projector and pull FEET LOCK LATCHES on the both sides of the projector.
- 2 Release FEET LOCK LATCHES to lock ADJUSTABLE FEET and rotate ADJUSTABLE FEET to adjust the position and tilt.
- 3 To retract ADJUSTABLE FEET, lift the front of the projector and pull and undo FEET LOCK LATCHES. Keystone distortion of the projected image can be adjusted by Menu Operation. (Refer to P20 and 35.)



### CAUTION

Avoid positioning a projector with the angle of more than 20 degrees. Projection Lamp may malfunction.

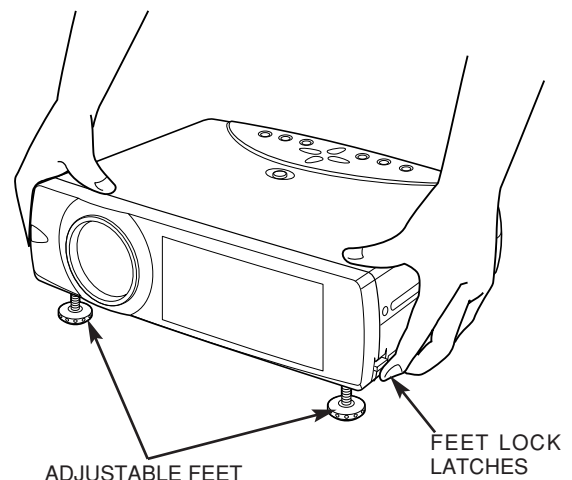

## MOVING PROJECTOR

Use Carry Handle when moving a projector.  
When moving a projector, replace Lens Cover and retract Adjustable Feet to prevent damage to the lens and cabinet.  
When a projector is not in use for an extended period, put it into the case (carrying bag) supplied with a projector.



### CAUTION

Carrying Bag (supplied) is intended for protection from dust and scratches on the surface of a cabinet, and it is not designed to protect an appliance from external forces. Do not transport a projector through a courier or transport services with this bag. The projector can be damaged. When handling a projector, do not drop, bump, subject it to strong forces or put other things on the cabinet.

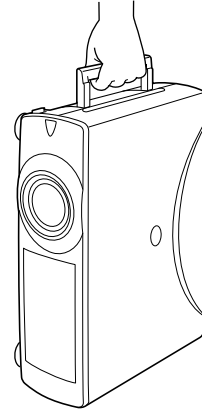

### CAUTION IN CARRYING OR TRANSPORTING THE PROJECTOR

- Do not drop or bump a projector, otherwise damages or malfunctions may result.
- When carrying a projector, use a suitable carrying case.
- Do not transport a projector by using a courier or transport service in an unsuitable transport case. This may cause damage to a projector. To transport a projector through a courier or transport service, consult your dealer for best way.

# CONNECTING PROJECTOR

## TERMINALS OF PROJECTOR

This projector has input and output terminals on its back for connecting computers and video equipment. Refer to figures on pages 11 to 13 and connect properly.

### S-VIDEO INPUT JACK

Connect the S-VIDEO output from video equipment to this jack. (Refer to P13.)

### AUDIO INPUT JACKS

Connect the audio output from video equipment to these jacks. (Refer to P13.)

● When the audio output is monaural, connect it to L (MONO) jack.

### VIDEO INPUT JACKS

Connect the composite video output from video equipment to VIDEO/Y jack or connect the component video outputs to VIDEO/Y, Pb/Cb and Pr/Cr jacks. (Refer to P13.)

### AUDIO OUTPUT JACKS

Connect an external audio amplifier to these jacks. (Refer to P12, 13.)

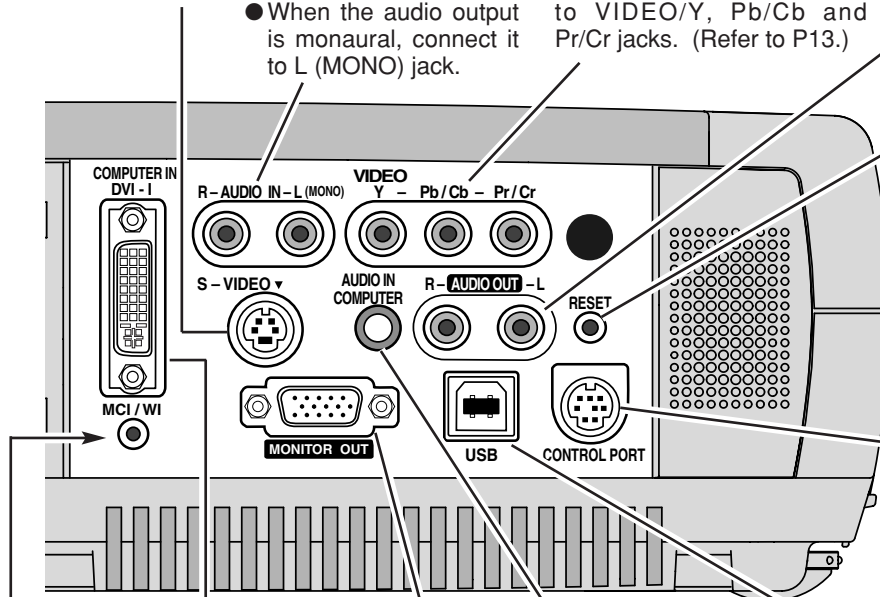

### RESET BUTTON

This projector uses a micro processor to control this unit, and occasionally, this micro processor may malfunction and need to be reset. This can be done by pressing RESET button with a pen, which will shut down and restart the unit. Do not use RESET function excessively.

### CONTROL PORT CONNECTOR

When controlling the computer with Remote Control Unit of this projector, connect the mouse port of your personal computer to this connector. (Refer to P12.)

### MONITOR OUTPUT TERMINAL

Connect a monitor to this terminal. This terminal outputs a computer input signal. (Refer to P12.)

### COMPUTER AUDIO INPUT JACK

Connect the audio output (stereo) from computer to this jack. (Refer to P12.)

### USB CONNECTOR (Series B)

When controlling the computer with Remote Control Unit of this projector, connect USB port of your personal computer to this connector. (Refer to P12.)

### COMPUTER INPUT (DIGITAL/ANALOG) Media Card Imager / Wireless Imager TERMINAL

Connect computer output (Digital / Analog DVI-I type), Media Card Imager\*, or Wireless Imager\* to this terminal.

\*optional accessories

\* Do not press this button. This button is used for our optional accessories.

# CONNECTING TO COMPUTER

**Cables used for connection** (\* = Cable or adapter is not supplied with this projector.)

- VGA Cable (HDB 15 pin)
- Control Cable for PS/2 Port
- DVI-Digital Cable (for Single Link T.M.D.S.) \*
- Control Cable for Serial Port \*, or ADB Port \*
- USB Cable \*
- MAC Adapter (When connecting to Macintosh computer) \*
- DVI/VGA Adapter
- Audio Cables (RCA x 2 and Mini Plug (stereo) x 1) \*

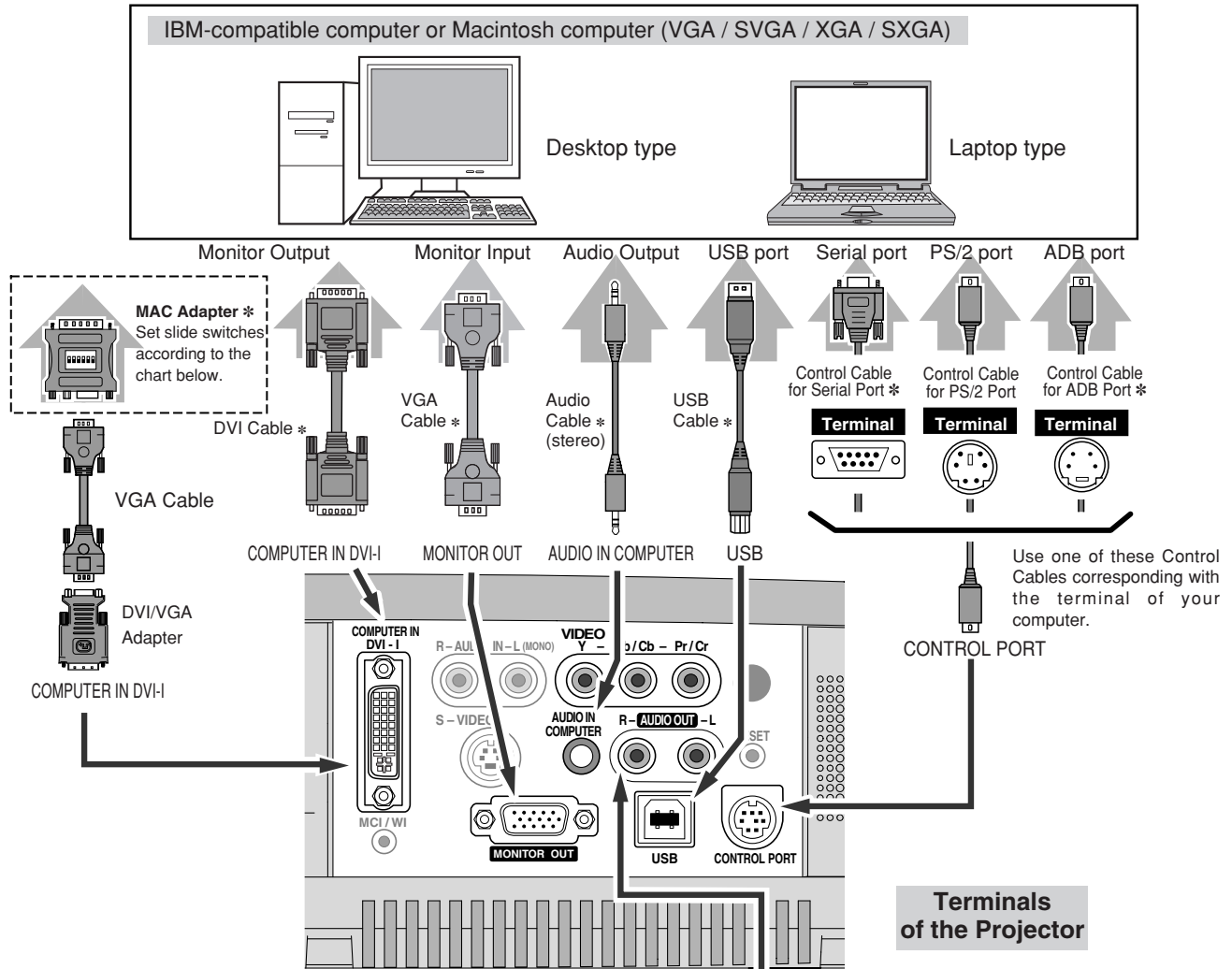

**NOTE :**  
When connecting the cable, the power cords of both the projector and the external equipment should be disconnected from AC outlet. Turn the projector and peripheral equipment on before the computer is switched on.

**◆ MAC ADAPTER (Not supplied)**  
Set switches as shown in the table below depending on RESOLUTION MODE that you want to use before you turn on projector and computer.

	1	2	3	4	5	6
13" MODE (640 x 480)	ON	ON	OFF	OFF	OFF	OFF
16" MODE (832 x 624)	OFF	ON	OFF	ON	OFF	OFF
19" MODE (1024 x 768)	OFF	ON	ON	OFF	OFF	OFF
21" MODE (1152 x 870)	ON	ON	ON	ON	OFF	OFF

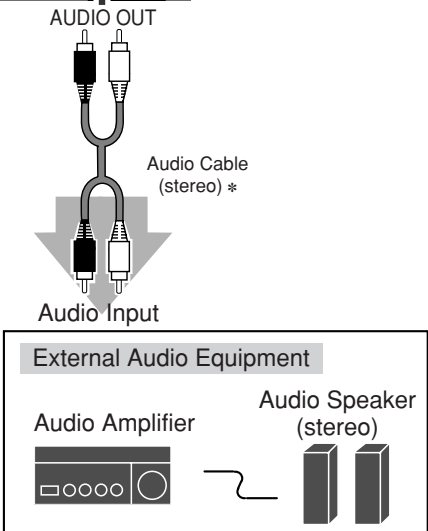

# CONNECTING TO VIDEO EQUIPMENT

**Cables used for connection** (\* = Cable is not supplied with this projector.)

- Video Cable (RCA x 1 or RCA x 3) \*
- S-VIDEO Cable \*
- Audio Cable (RCA x 2) \*

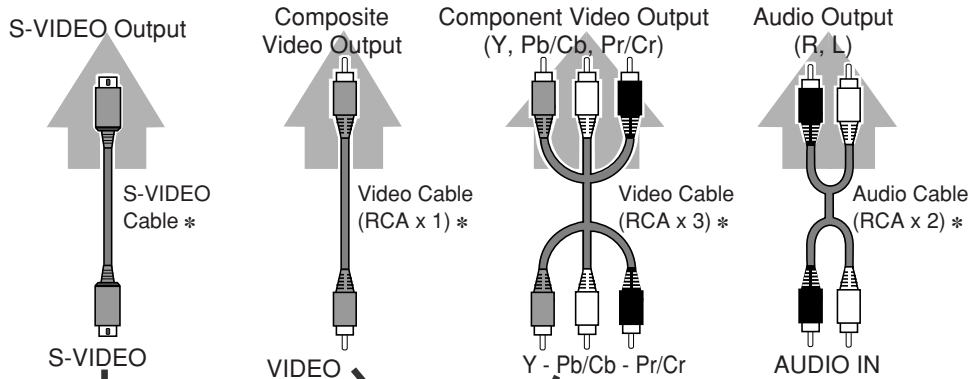

Use any of VIDEO jack, S-VIDEO jack, or Y-Pb/Cb-Pr/Cr jacks.

- When both VIDEO jack and S-VIDEO jack are connected, S-VIDEO jack has priority over VIDEO jack.
- When both Y-Pb/Cb-Pr/Cr jacks and S-VIDEO jack are connected, Y-Pb/Cb-Pr/Cr jacks has priority over S-VIDEO jack.

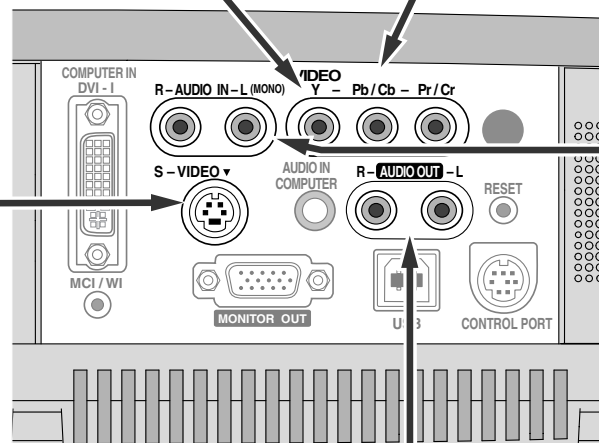

**Terminals of the Projector**

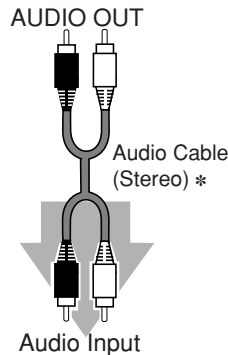

**NOTE :** When connecting the cable, the power cords of both the projector and the external equipment should be disconnected from AC outlet.

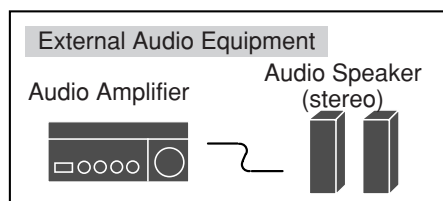

# BEFORE OPERATION

## OPERATION OF REMOTE CONTROL UNIT

### Left Side

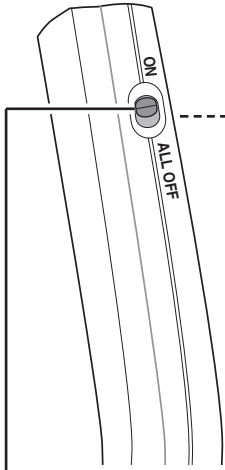

#### ALL-OFF SWITCH

When using Remote Control Unit, turn this switch to "ON." And turn it to "ALL OFF" when it is not used.

#### MENU BUTTON

Used to select MENU operation. (P17, 18)

#### SELECT BUTTON

Used to execute the item selected, or to expand or compress the image in DIGITAL ZOOM +/- mode. (P29)  
It is also used as a PC mouse in Wireless Mouse Operation. (P39)

#### POWER ON-OFF BUTTON

Used to turn projector on or off. (P19)

#### INPUT BUTTON

Used to select input source. (P22, 30)

#### POINT BUTTON

Used to move a pointer on ON-SCREEN MENU, adjust each item, or pan image in DIGITAL ZOOM +/- mode. (P29)

It is also used as a PC mouse in Wireless Mouse Operation. (P39)

\* When pressing the center of this button, it works as SELECT button.

#### RIGHT CLICK BUTTON

Used as a PC mouse in Wireless Mouse Operation. (P39)

#### P-TIMER BUTTON

Used to operate P-TIMER function. (P21)

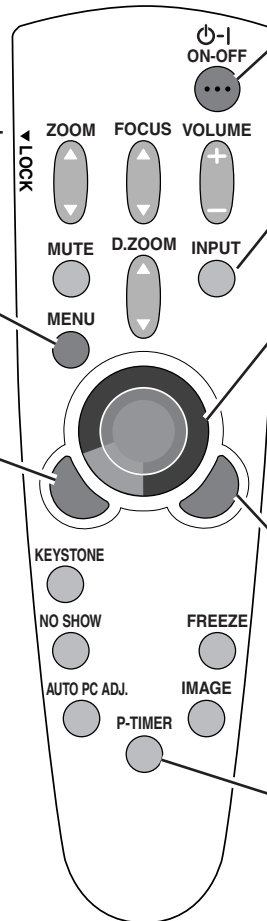

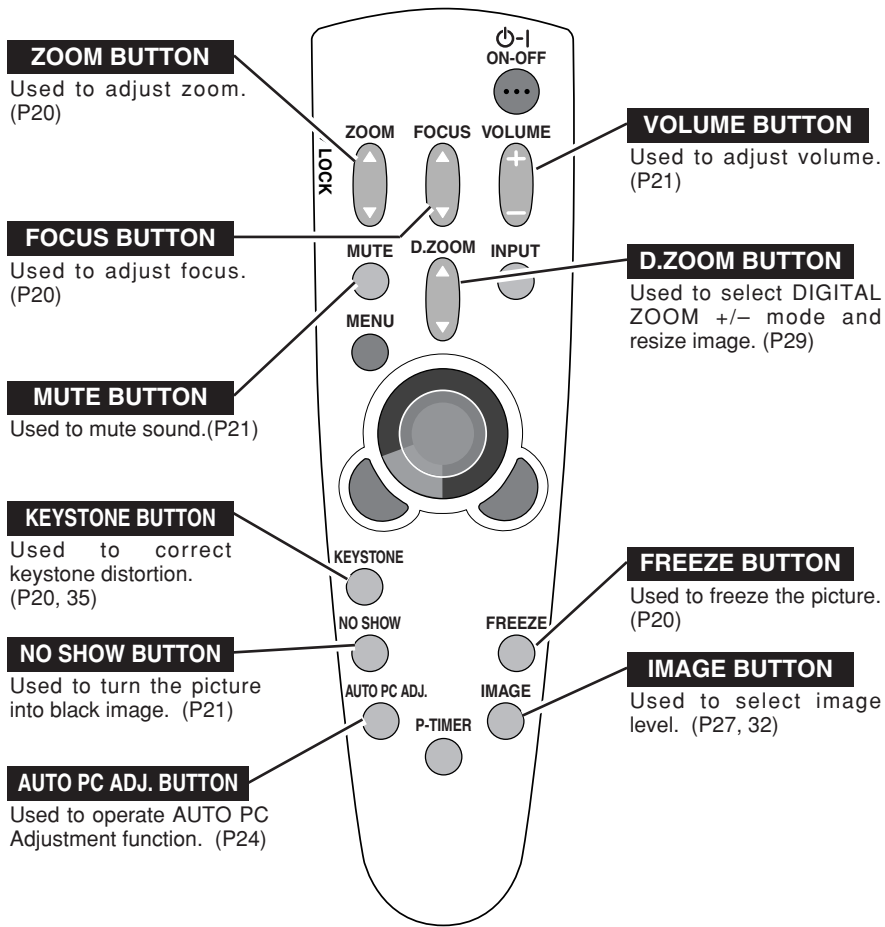

**Operating Range**

Point Remote Control Unit toward projector (Receiver Window) whenever pressing any button. Maximum operating range for Remote Control Unit is about 16.4' (5m) and 60° in front and rear of the projector.

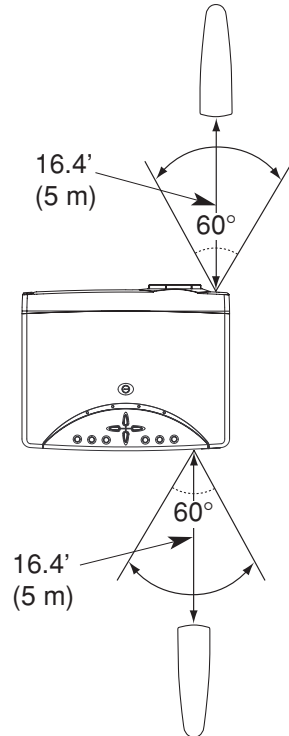

**REMOTE CONTROL BATTERIES INSTALLATION**

**1** Remove the battery compartment lid.

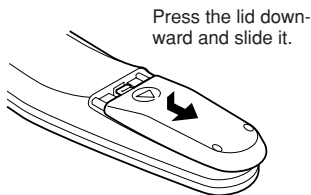

**2** Slide the batteries into the compartment.

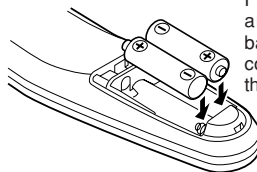

**3** Replace the compartment lid.

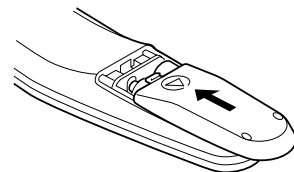

To insure safe operation, please observe the following precautions :

- Use (2) AA, UM3 or R06 type alkaline batteries.
- Replace two batteries at the same time.
- Do not use a new battery with an used battery.
- Avoid contact with water or liquid.
- Do not expose Remote Control Unit to moisture, or heat.
- Do not drop Remote Control Unit.
- If a battery has leaked on Remote Control Unit, carefully wipe the case clean and load new batteries.
- Danger of explosion if battery is incorrectly replaced.
- Dispose of used batteries according to battery manufacturer's instructions and local rules.

# TOP CONTROLS AND INDICATORS

This projector has CONTROL BUTTONS (TOP CONTROLS) and INDICATORS on its top.

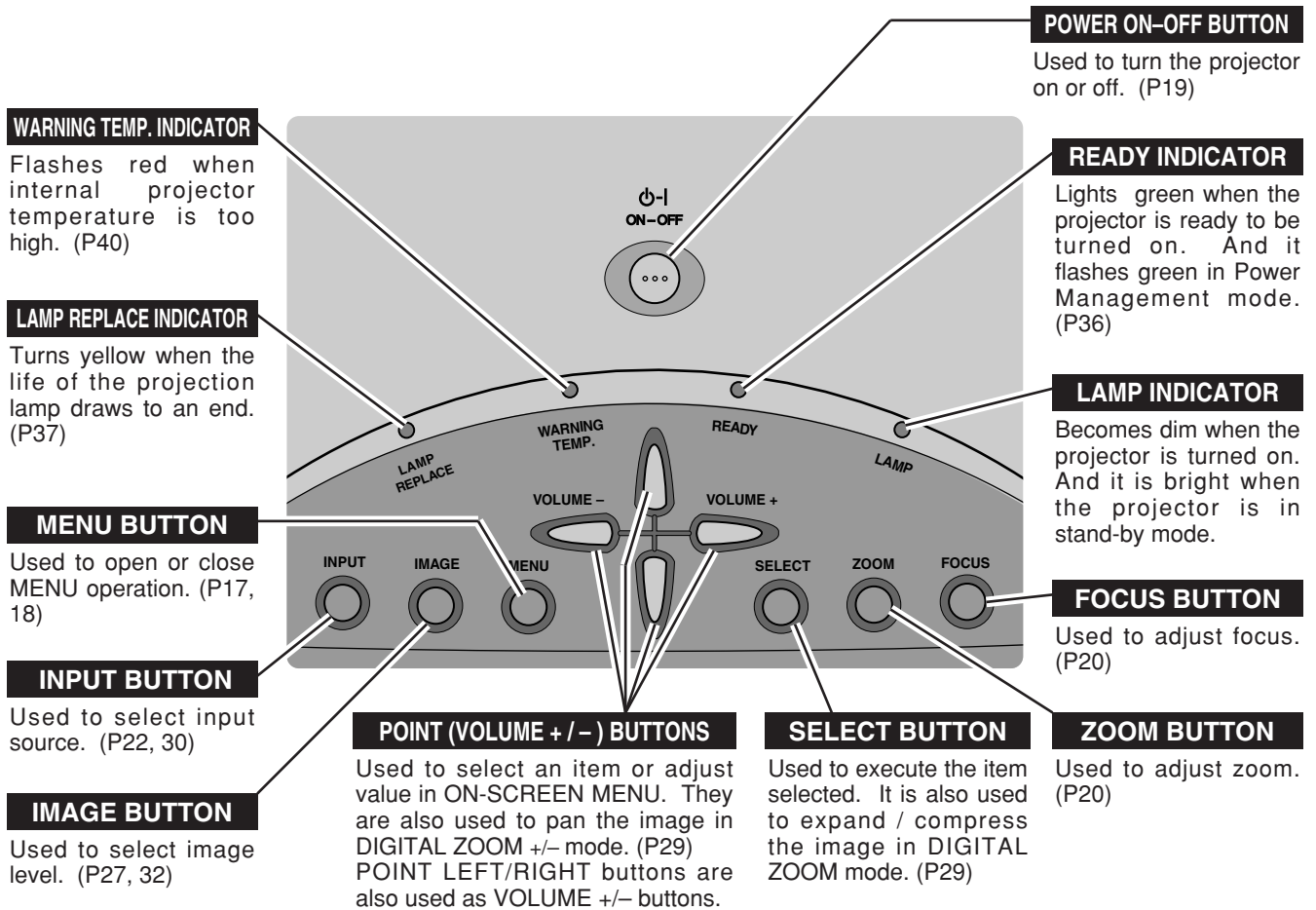



# OPERATING ON-SCREEN MENU

## HOW TO OPERATE ON-SCREEN MENU

You can control and adjust this projector through ON-SCREEN MENU. Refer to the following pages to operate each adjustment on ON-SCREEN MENU.

### 1 DISPLAY MENU

Press MENU button to display ON-SCREEN MENU.

### 2 MOVING POINTER

Move the pointer (\* see below) or adjust the value of item by pressing POINT button(s) on Top Control or on Remote Control Unit.

\* Pointer is the icon on ON-SCREEN MENU to select the item. See the figures on the section "FLOW OF ON-SCREEN MENU OPERATION" below.

### 3 SELECT ITEM

Select the item or set the selected function by pressing SELECT button.

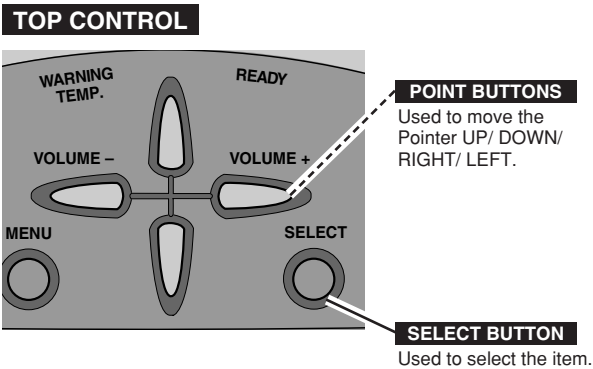
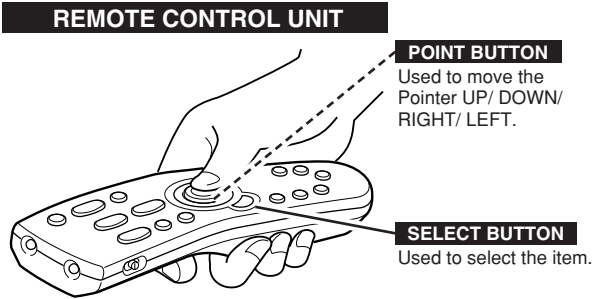

## FLOW OF ON-SCREEN MENU OPERATION

### Display ON-SCREEN MENU

1 Press MENU button to display ON-SCREEN MENU (MENU BAR). A red frame is POINTER.

### Select Menu to be adjusted

2 Move POINTER (red frame) to MENU ICON that you want to select by pressing POINT RIGHT / LEFT buttons.

### Control or adjust item through ON-SCREEN MENU

3 Press POINT DOWN button and move POINTER (red frame or red arrow) to ITEM that you want to adjust, and then press SELECT button to show ITEM DATA.

4 Adjust ITEM DATA by pressing POINT RIGHT / LEFT buttons. Refer to the following pages for details of respective adjustments.

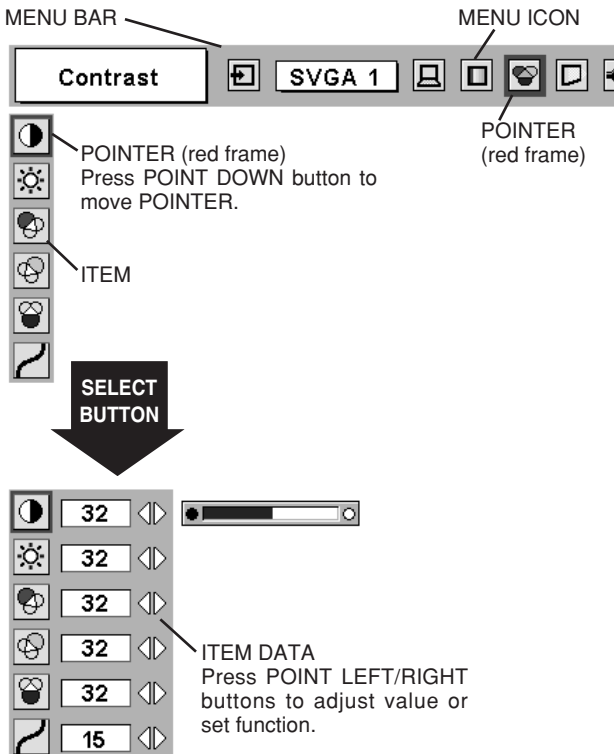

**MENU BAR**

**FOR PC SOURCE**

Press MENU BUTTON while connecting to PC input source.

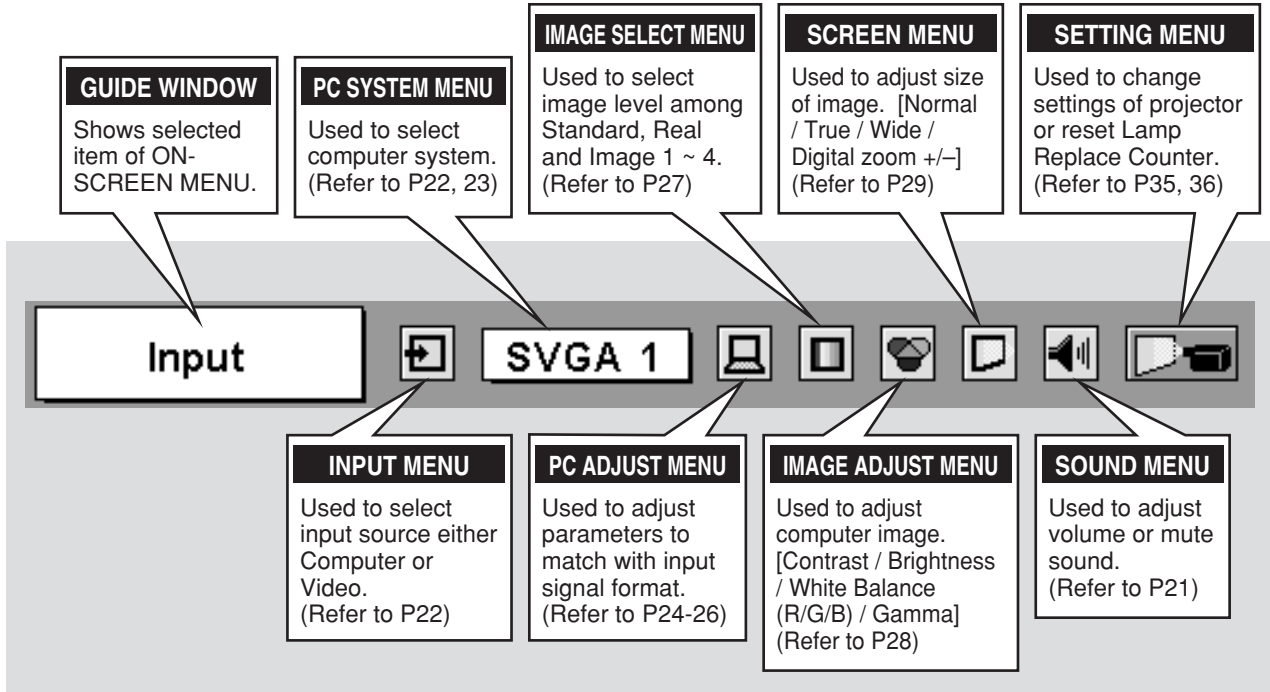

**FOR VIDEO SOURCE**

Press MENU BUTTON while connecting to VIDEO input source.

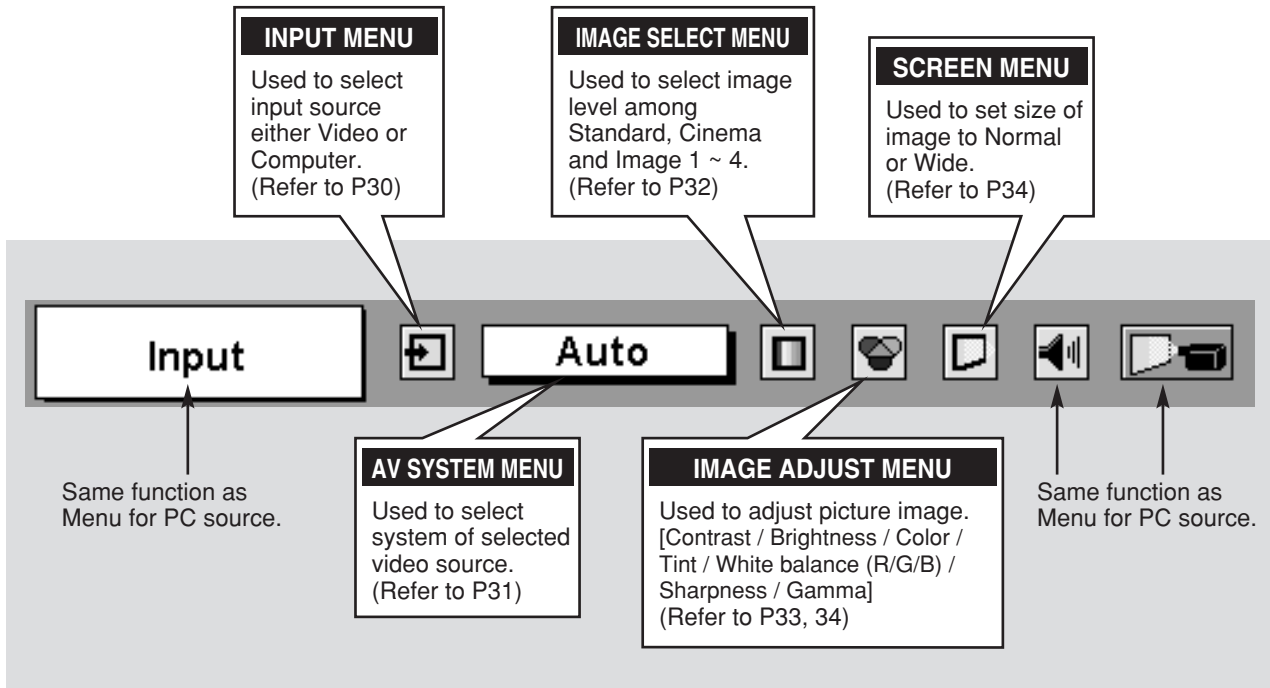

# BASIC OPERATION

## TURNING ON / OFF PROJECTOR

### TURNING ON PROJECTOR

- 1** Complete peripheral connections (with Computer, VCR, etc.) before turning on projector. (Refer to "CONNECTING PROJECTOR" on pages 11~13 for connecting the equipment.)
- 2** Connect the projector's AC Power Cord into an AC outlet. LAMP Indicator lights RED, and READY Indicator lights GREEN.  
  
NOTE : When "On start" function is ON, this projector is turned on automatically by connecting AC Power Cord to an AC outlet. (Refer to pages 35, 36.)
- 3** Press POWER ON-OFF button on Top Control or on Remote Control Unit to ON. LAMP Indicator dims, and Cooling Fans start to operate. Preparation Display appears on a screen and the count-down starts. The signal from PC or Video source appears after 30 seconds.

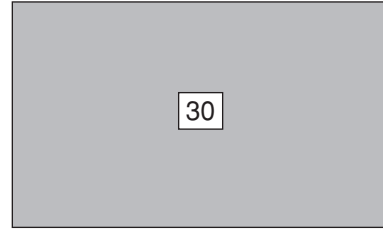

Preparation Display disappears after 30 seconds.

### TURNING OFF PROJECTOR

- 1** Press POWER ON-OFF button on Top Control or on Remote Control Unit, and a message "Power off?" appears on a screen.
- 2** Press POWER ON-OFF button again to turn off the projector. LAMP Indicator lights bright and READY Indicator is turned off. After projector is turned off, Cooling Fans operate (for 90 seconds). During this "Cooling Down" period, this appliance cannot be turned on.
- 3** When the projector has cooled down, READY Indicator lights GREEN again and you can turn the projector on. After cooling down completely, disconnect AC Power Cord.

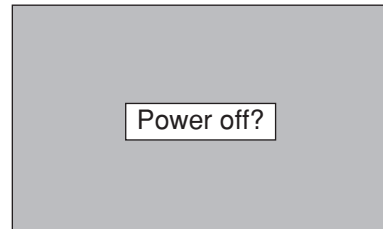

Message disappears after 4 seconds.



TO MAINTAIN THE LIFE OF LAMP, ONCE YOU TURN PROJECTOR ON, WAIT AT LEAST 5 MINUTES BEFORE TURNING IT OFF.

When "Power Management" function is ON, the projector detects signal interruption and turns off Projection Lamp automatically. Refer to "Power management" on page 36.

When WARNING TEMP. Indicator flashes red, the projector is automatically turned off. Wait at least 5 minutes before turning on projector again.

When WARNING TEMP. Indicator continues to flash, follow the procedures below:

1. Press POWER ON-OFF button to turn the projector off and disconnect AC Power Cord from an AC outlet.
2. Check Air Filters for dust accumulation.
3. Clean Air Filters. (See "AIR FILTER CARE AND CLEANING" section on page 40.)
4. Turn the projector on again.

If WARNING TEMP. Indicator should still continue to flash, contact the sales dealer where you purchased this projector or service center.

## ADJUSTING SCREEN

### ZOOM ADJUSTMENT

- 1** Press ZOOM button on Top Control or ZOOM ▲/▼ button on Remote Control Unit. The message "Zoom" is displayed.
- 2** Press ZOOM ▲ button or POINT UP button to make image larger, and press ZOOM ▼ button or POINT DOWN button to make image smaller.

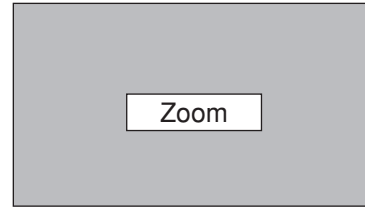

Message disappears after 4 seconds.

### FOCUS ADJUSTMENT

- 1** Press FOCUS button on Top Control or FOCUS ▲/▼ button on Remote Control Unit. The message "Focus" is displayed.
- 2** Adjust focus of image by pressing FOCUS ▲/▼ button or POINT UP/DOWN button(s).

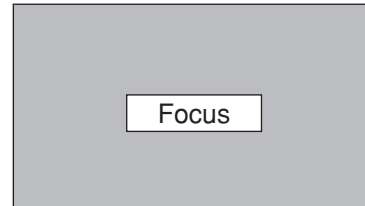

Message disappears after 4 seconds.

### KEYSTONE ADJUSTMENT

If a projected picture has keystone distortion, correct the image with KEYSTONE adjustment.

- 1** Press KEYSTONE button on Remote Control Unit or select Keystone on SETTING menu. (Refer to page 35.) Keystone dialog box appears.
- 2** Correct keystone distortion by pressing POINT UP/DOWN/LEFT/RIGHT button(s). Press POINT UP button to reduce the upper part of the image, and press POINT DOWN button to reduce the lower part. Press POINT LEFT button to reduce the left part, and press POINT RIGHT button to reduce the right part.



- Arrows are white in no correction.
- Arrow(s) of direction being corrected turn(s) red.
- Arrow(s) disappear(s) at the maximum correction.

Reduce the upper width with POINT UP button.

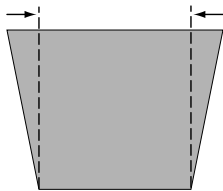

Reduce the lower width with POINT DOWN button.

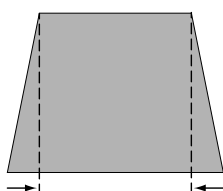

Reduce the left part with POINT LEFT button.

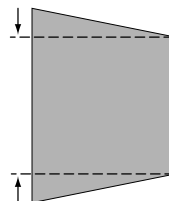

Reduce the right part with POINT RIGHT button.

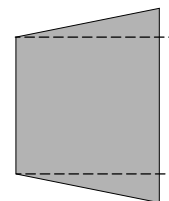

### PICTURE FREEZE FUNCTION

Press FREEZE button on Remote Control Unit to freeze the picture on-screen. To cancel FREEZE function, press FREEZE button again or press any other button.

## NO SHOW FUNCTION

Press NO SHOW button on Remote Control Unit to black out the image. To restore to normal, press NO SHOW button again or press any other button.

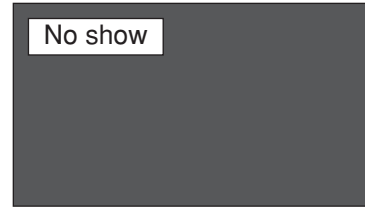

Message disappears after 4 seconds.

## P-TIMER FUNCTION

Press P-TIMER button on Remote Control Unit. The timer display "00 : 00" appears on the screen and the timer starts to count time (00 : 00 ~ 59 : 59).

To stop P-TIMER display, press P-TIMER button. And then, press P-TIMER button again to cancel P-TIMER function.



# SOUND ADJUSTMENT

## DIRECT OPERATION

### Volume

Press VOLUME (+/-) button(s) on Top Control or on Remote Control Unit to adjust volume. Volume dialog box appears on the screen for a few seconds.

(+) button to increase volume, and (-) button for decreasing.

### Mute

Press MUTE button on Remote Control Unit to cut off sound. To restore sound to its previous level, press MUTE button again or press Volume (+/-) button(s).

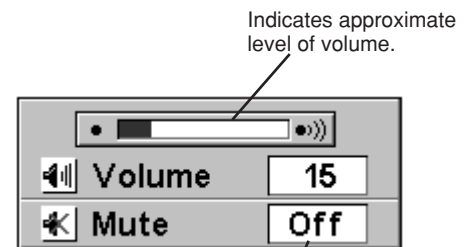

The display disappears after 4 seconds.

## MENU OPERATION

**1** Press MENU button and ON-SCREEN MENU will appear. Press POINT LEFT/RIGHT buttons to move a red frame pointer to SOUND Menu icon.

**2** Press POINT DOWN button to move a red frame pointer to the item that you want to select, and then press SELECT button.

### Volume

To increase volume, press POINT RIGHT button, and press POINT LEFT button to decrease volume.

### Mute

Press POINT LEFT/RIGHT button(s) to cut off sound. Dialog box display is changed to "On" and sound is cut off. To restore sound to its previous level, press POINT LEFT/RIGHT button(s) again.

## SOUND MENU

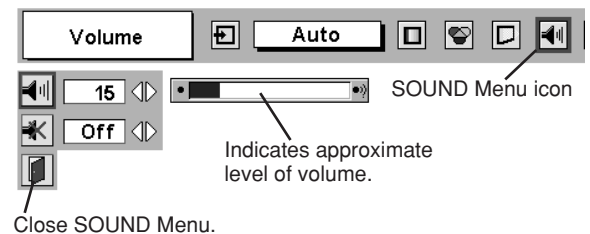

# COMPUTER INPUT

## SELECTING INPUT SOURCE

### DIRECT OPERATION

Choose Computer by pressing INPUT button on Top Control or on Remote Control Unit.

If projector cannot reproduce proper image, select correct input source through MENU OPERATION (see below).

### MENU OPERATION

- 1 Press MENU button and ON-SCREEN MENU will appear. Press POINT LEFT/RIGHT button to move a red frame pointer to INPUT Menu icon.
- 2 Press POINT DOWN button to move a red arrow pointer to Computer and then press SELECT button. Source Select Menu will appear.
- 3 Move a pointer to either RGB (Digital) or RGB (Analog) and then press SELECT button.

**RGB (Digital)** When digital signal is connected to DVI terminal, select Digital.

**RGB (Analog)** When analog signal is connected to DVI terminal, select Analog.

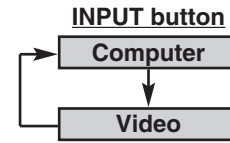

### INPUT MENU

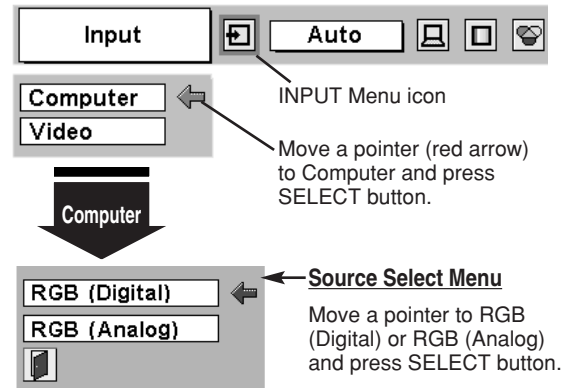

## SELECTING COMPUTER SYSTEM

This projector automatically tunes to most different types of computers based on VGA, SVGA, XGA or SXGA (refer to "COMPATIBLE COMPUTER SPECIFICATIONS" on page 23). When selecting Computer, this projector automatically tunes to incoming signal and projects proper image without any special setting. (Some computers need setting manually.)

Note : Projector may display one of the following messages.

**Auto** When projector cannot recognize connected signal as PC system provided in this projector, Auto PC Adjustment function operates to adjust projector and the message "Auto" is displayed on SYSTEM Menu icon. (Refer to P24.) When image is not provided properly, manual adjustment is required. (Refer to P25 and 26.)

**—** There is no signal input from computer. Make sure the connection of computer and a projector is set correctly. (Refer to TROUBLESHOOTING on page 41.)

### PC SYSTEM MENU

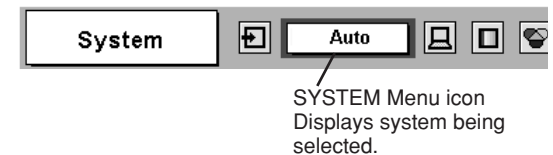

### SELECT COMPUTER SYSTEM MANUALLY

This projector automatically selects PC system among those provided in this projector and PC system can be also selected manually.

- 1 Press MENU button and ON-SCREEN MENU will appear. Press POINT LEFT/RIGHT buttons to move a red frame pointer to PC SYSTEM Menu icon.
- 2 Press POINT DOWN button to move a red arrow pointer to the system that you want to set, and then press SELECT button.

### PC SYSTEM MENU

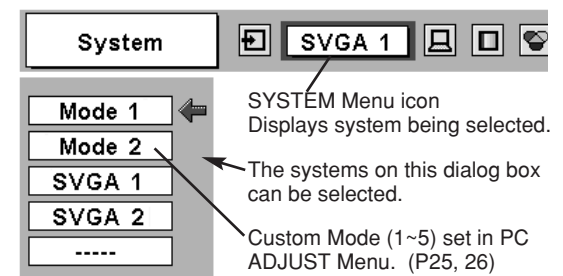

**COMPATIBLE COMPUTER SPECIFICATIONS**

Basically this projector can accept the signal from all computers with the V, H-Frequency below mentioned and less than 100 MHz of Dot Clock.

ON-SCREEN DISPLAY	RESOLUTION	H-Freq. (kHz)	V-Freq. (Hz)	ON-SCREEN DISPLAY	RESOLUTION	H-Freq. (kHz)	V-Freq. (Hz)
VGA 1	640 x 480	31.47	59.88	XGA 3	1024 x 768	60.023	75.03
VGA 2	720 x 400	31.47	70.09	XGA 4	1024 x 768	56.476	70.07
VGA 3	640 x 400	31.47	70.09	XGA 5	1024 x 768	60.31	74.92
VGA 4	640 x 480	37.86	74.38	XGA 6	1024 x 768	48.50	60.02
VGA 5	640 x 480	37.86	72.81	XGA 7	1024 x 768	44.00	54.58
VGA 6	640 x 480	37.50	75.00	XGA 8	1024 x 768	63.48	79.35
VGA 7	640 x 480	43.269	85.00	XGA 9	1024 x 768	36.00	87.17 (Interlace)
MAC LC13	640 x 480	34.97	66.60	XGA 10	1024 x 768	62.04	77.07
MAC 13	640 x 480	35.00	66.67	XGA 11	1024 x 768	61.00	75.70
RGB	————	15.625	50 (Interlace)	XGA 12	1024 x 768	35.522	86.96 (Interlace)
RGB	————	15.734	60 (Interlace)	XGA 13	1024 x 768	46.90	58.20
SVGA 1	800 x 600	35.156	56.25	XGA 14	1024 x 768	47.00	58.30
SVGA 2	800 x 600	37.88	60.32	XGA 15	1024 x 768	58.03	72.00
SVGA 3	800 x 600	46.875	75.00	MAC 19	1024 x 768	60.24	75.08
SVGA 4	800 x 600	53.674	85.06	MAC 21	1152 x 870	68.68	75.06
SVGA 5	800 x 600	48.08	72.19	SXGA 1	1152 x 864	64.20	70.40
SVGA 6	800 x 600	37.90	61.03	SXGA 11	1152 x 900	61.20	65.20
SVGA 7	800 x 600	34.50	55.38	SXGA 13	1280 x 1024	50.00	86.00 (Interlace)
SVGA 8	800 x 600	38.00	60.51	SXGA 14	1280 x 1024	50.00	94.00 (Interlace)
SVGA 9	800 x 600	38.60	60.31	SXGA 17	1152 x 900	61.85	66.00
SVGA 10	800 x 600	32.70	51.09	SXGA 18	1280 x 1024	46.43	86.70 (Interlace)
SVGA 11	800 x 600	38.00	60.51	720p (HDTV)	————	45.00	60.00
MAC 16	832 x 624	49.72	74.55	1035i (HDTV)	————	33.75	60.00 (Interlace)
XGA 1	1024 x 768	48.36	60.00	1080i60 (HDTV)	————	33.75	60.00 (Interlace)
XGA 2	1024 x 768	68.677	84.997	1080i50 (HDTV)	————	28.125	50.00 (Interlace)

When a input signal is digital from DVI terminal, refer to the chart below.

ON-SCREEN DISPLAY	RESOLUTION	H-Freq. (kHz)	V-Freq. (Hz)	ON-SCREEN DISPLAY	RESOLUTION	H-Freq. (kHz)	V-Freq. (Hz)
D-VGA	640 x 480	31.469	59.940	D-SXGA 2	1280 x 1024	60.276	58.069
D-SVGA	800 x 600	37.879	60.317	D-SXGA 3	1280 x 1024	31.65	29.8
D-XGA	1024 x 768	48.363	60.004				

NOTE : Specifications are subject to change without notice.

# PC ADJUSTMENT

## AUTO PC ADJUSTMENT

Auto PC Adjustment function is provided to automatically adjust Fine sync, Total dots and Picture Position to conform to your computer. Auto PC Adjustment function can be operated as follows.



### Auto PC Adj.

- 1 Press MENU button and ON-SCREEN MENU will appear. Press POINT LEFT/RIGHT button to move a red frame pointer to PC ADJUST Menu icon.
- 2 Press POINT DOWN button to move a red frame pointer to AUTO PC Adj. icon and then press SELECT button twice. This Auto PC Adjustment can be also executed by pressing AUTO PC ADJ. button on Remote Control Unit.

Store adjustment parameters.

Adjustment parameters from Auto PC Adjustment can be memorized in this projector. Once parameters are memorized, the setting can be done just by selecting Mode in PC SYSTEM Menu (P22). Refer to step 3 of MANUAL PC ADJUSTMENT section (P26).

### NOTE

- Fine sync, Total dots and Picture Position of some computers can not be fully adjusted with this Auto PC Adjustment function. When the image is not provided properly through this function, manual adjustments are required. (Refer to page 25, 26.)
- Auto PC Adjustment function cannot be operated when "RGB," "720p (HDTV)," "1035i (HDTV)" or "1080i (HDTV)" is selected on PC SYSTEM Menu (P22).

### PC ADJUST MENU

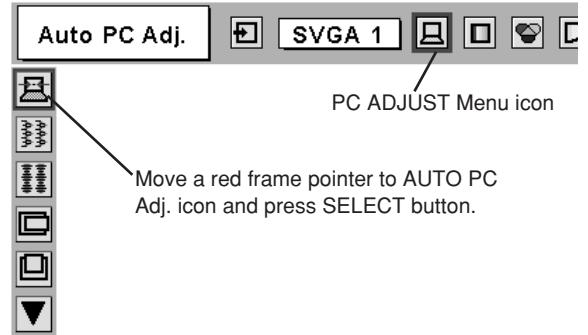



## MANUAL PC ADJUSTMENT

This projector can automatically tune to the display signals from most personal computers currently distributed. However, some computers employ special signal formats which are different from the standard ones and may not be tuned by Multi-Scan system of this projector. If this happens, projector cannot reproduce a proper image and the image may be recognized as a flickering picture, a non-synchronized picture, a non-centered picture or a skewed picture.

This projector has a Manual PC Adjustment to enable you to precisely adjust several parameters to match with those special signal formats. This projector has 5 independent memory areas to memorize those parameters manually adjusted. This enables you to recall the setting for a specific computer whenever you use it.

Note : This PC ADJUST Menu cannot be operated when the input signal is digital or "RGB" is selected on PC SYSTEM MENU (P22).

- 1 Press MENU button and ON-SCREEN MENU will appear. Press POINT LEFT/RIGHT button to move a red frame pointer to PC ADJUST Menu icon.
- 2 Press POINT DOWN button to move a red frame pointer to the item that you want to adjust and then press SELECT button. Adjustment dialog box will appear. Press POINT LEFT/RIGHT button to adjust value.

 **Fine sync**

Adjusts an image as necessary to eliminate flicker from the display. Press POINT LEFT/RIGHT button to adjust value.(From 0 to 31.)

 **Total dots**

The number of total dots in one horizontal period. Press POINT LEFT/RIGHT button(s) and adjust number to match your PC image.

 **Horizontal**

Adjusts horizontal picture position. Press POINT LEFT/RIGHT button(s) to adjust the position.

 **Vertical**

Adjusts vertical picture position. Press POINT LEFT/RIGHT button(s) to adjust the position.

 **Current mode**

Press SELECT button to show the information of computer selected.

 **Clamp**

Adjusts clamp level. When the image has a dark bar(s), try this adjustment.

### PC ADJUST MENU

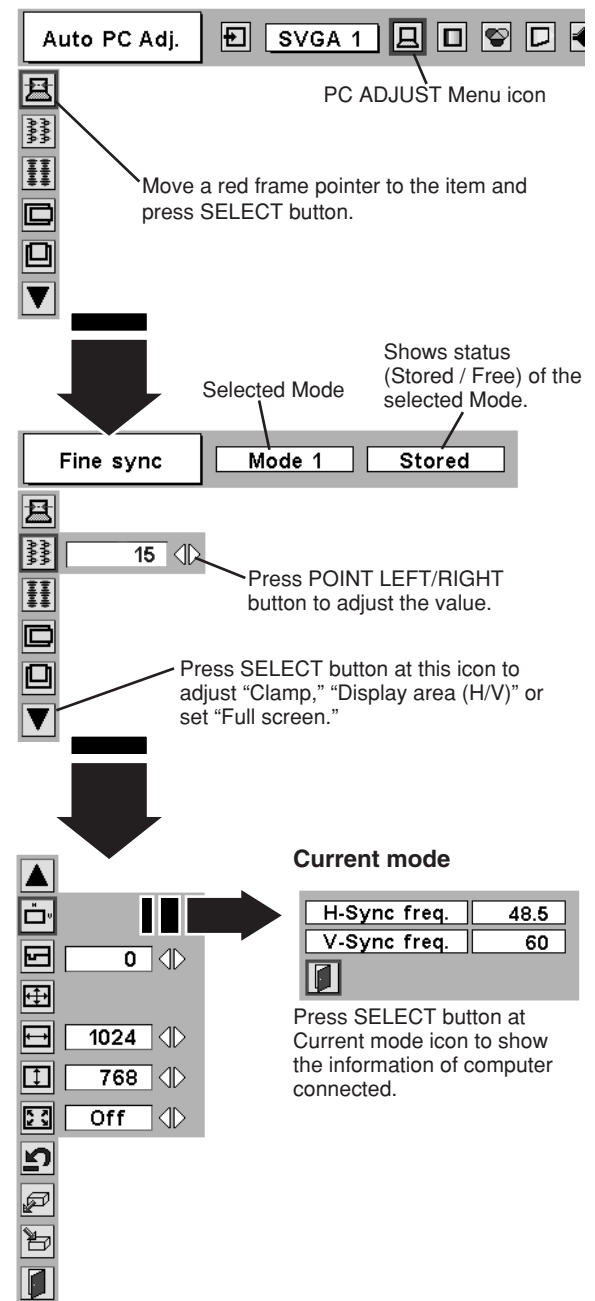

Auto PC Adj. SVGA 1 

PC ADJUST Menu icon

Move a red frame pointer to the item and press SELECT button.

**Fine sync** Mode 1 Stored

Shows status (Stored / Free) of the selected Mode.

15

Press POINT LEFT/RIGHT button to adjust the value.

Press SELECT button at this icon to adjust "Clamp," "Display area (H/V)" or set "Full screen."

**Current mode**

H-Sync freq.	48.5
V-Sync freq.	60

Press SELECT button at Current mode icon to show the information of computer connected.

## Display area

Selects area displayed with this projector. Select the resolution at Display area dialog box.

## Display area H

Adjustment of horizontal area displayed with this projector. Press POINT LEFT/RIGHT button(s) to decrease/increase value and then press SELECT button.

## Display area V

Adjustment of vertical area displayed with this projector. Press POINT LEFT/RIGHT button(s) to decrease/increase value and then press SELECT button.

## Full screen

Press POINT LEFT/RIGHT button(s) to switch Full screen function to "On" or "Off." Set "On" to resize the image with 4 x 3 aspect ratio to fit the screen.

NOTE : Fine sync, Total dots, Display area (H/V) and Full screen cannot be adjusted when "1035i (HDTV)" or "1080i (HDTV)" is selected on PC SYSTEM Menu (P22).

## 3 Store

To store adjustment parameters, move a red frame pointer to Store icon and then press SELECT button. Move a red arrow pointer to any of Mode 1 to 5 that you want to store to and then press SELECT button.

## Mode free

To clear adjustment parameters previously set, move a red frame pointer to Mode free icon and then SELECT button. Move a red arrow pointer to the Mode that you want to clear and then press SELECT button.

Other icons operate as follows.

## Reset

Reset all adjust parameters on adjustment dialog box to previous figure.

## Quit

Closes PC ADJUST MENU.

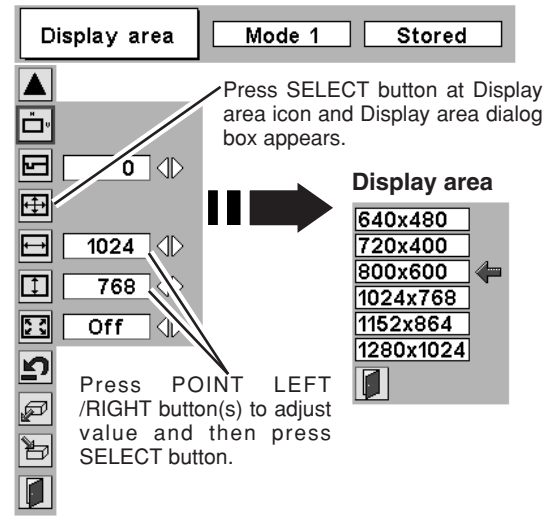

## To store adjustment data.

This Mode has parameters being stored.

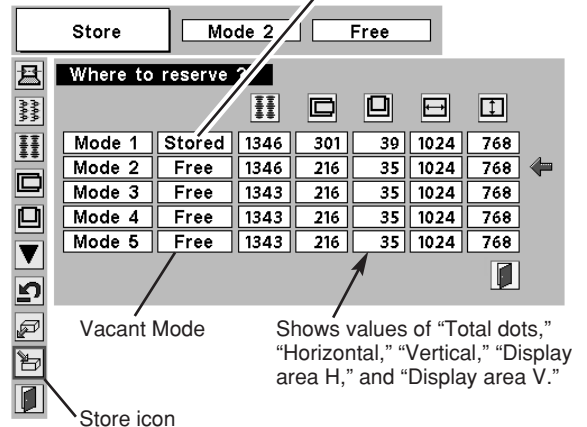

## To clear adjustment data.

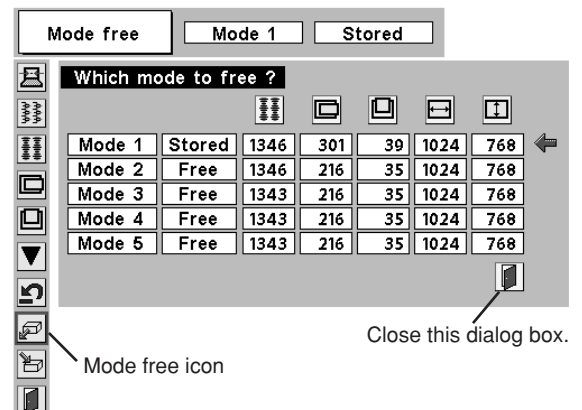

# PICTURE IMAGE ADJUSTMENTS

## IMAGE LEVEL SELECT (DIRECT)

Select image level among Standard, Real, Image 1, Image 2, Image 3 and Image 4 by pressing IMAGE button on Top Control or on Remote Control Unit.

**Standard**

Normal picture level preset on this projector.

**Real**

Picture level with improved halftone for graphics.

**IMAGE 1~4**

User preset picture adjustment in IMAGE ADJUST Menu (P28).

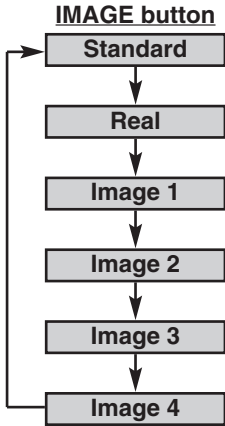

## IMAGE LEVEL SELECT (MENU)

- 1 Press MENU button and ON-SCREEN MENU will appear. Press POINT LEFT/RIGHT button to move a red frame pointer to IMAGE SELECT Menu icon.
- 2 Press POINT DOWN button to move a red frame pointer to the level that you want to set and then press SELECT button.

**IMAGE SELECT MENU**

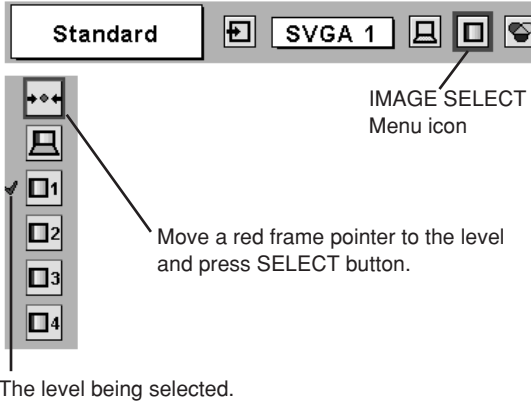

**Standard**

Normal picture level preset on this projector.

**Real**

Picture level with improved halftone for graphics.

**IMAGE 1~4**

User preset picture adjustment in IMAGE ADJUST Menu (P28).

## IMAGE LEVEL ADJUSTMENT

- 1 Press MENU button and ON-SCREEN MENU will appear. Press POINT LEFT/RIGHT buttons to move a red frame pointer to IMAGE ADJUST Menu icon.
- 2 Press POINT DOWN button to move a red frame pointer to the item that you want to adjust, and then press SELECT button. The level of each item is displayed. Adjust each level by pressing POINT LEFT/RIGHT button(s).

### Contrast

Press POINT LEFT button to decrease contrast, and POINT RIGHT button to increase contrast. (From 0 to 63.)

### Brightness

Press POINT LEFT button to adjust image darker, and POINT RIGHT button to adjust brighter. (From 0 to 63.)

### White balance (Red)

Press POINT LEFT button to lighten red tone and POINT RIGHT button to deeper tone. (From 0 to 63.)

### White balance (Green)

Press POINT LEFT button to lighten green tone and POINT RIGHT button to deeper tone. (From 0 to 63.)

### White balance (Blue)

Press POINT LEFT button to lighten blue tone and POINT RIGHT button to deeper tone. (From 0 to 63.)

### Gamma

Press either POINT LEFT button or POINT RIGHT button to obtain better balance of contrast. (From 0 to 15.)

### 3 Store

To store manually preset image, move a red frame pointer to Store icon and press SELECT button. Image Level Menu will appear. Move a red frame pointer to the Image 1 to 4 where you want to set and then press SELECT button.

Other icons operate as follows.

### Reset

Reset all adjustment to previous figure.

### Quit

Closes IMAGE MENU.

### IMAGE ADJUST MENU

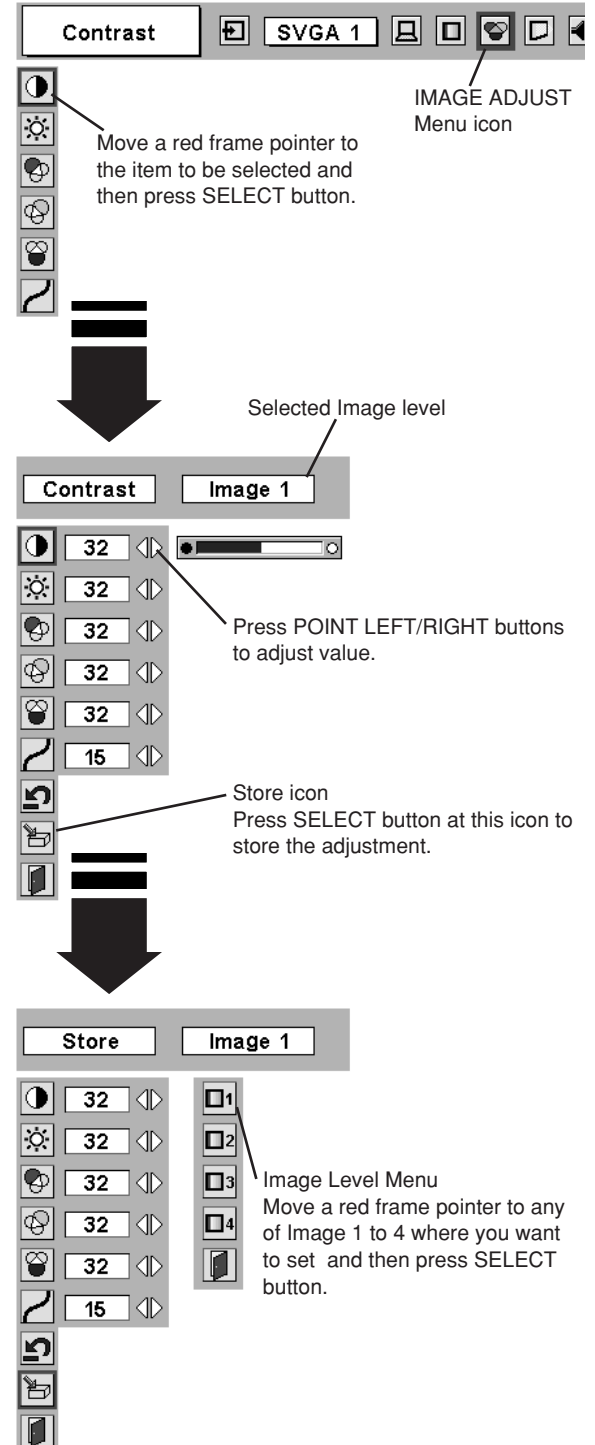

## PICTURE SCREEN ADJUSTMENT

This projector has a picture screen resize function, which enables you to display the desirable image size.

- 1 Press MENU button and ON-SCREEN MENU will appear. Press POINT LEFT/RIGHT button(s) to move a red frame pointer to SCREEN Menu icon.
- 2 Press POINT DOWN button and move a red frame pointer to the function that you want to select and then press SELECT button.



**Normal**

Provides image to fit screen size.



**True**

Provides image in its original size. When the original image size is larger than screen size (800 x 600), this projector enters "Digital zoom +" mode automatically.



**Wide**

Provides image to fit wide video aspect ratio (16 : 9) by expanding image width uniformly. This function can be used for providing a squeezed video signal at 16 : 9.



**Digital zoom +**

When Digital zoom + is selected, ON-SCREEN MENU disappears and the message "D. Zoom +" is displayed. Press SELECT button to expand image size. And press POINT UP/DOWN/LEFT/RIGHT button(s) to pan the image. Panning function can work only when the image is larger than screen size.

A projected image can be also expanded by pressing D.ZOOM ▲ button on Remote Control Unit.



**Digital zoom -**

When Digital zoom - is selected, ON-SCREEN MENU disappears and the message "D. Zoom -" is displayed. Press SELECT button to compress image size.

A projected image can be also compressed by pressing D.ZOOM ▼ button on Remote Control Unit.

To cancel Digital Zoom +/- mode, press any button except D.ZOOM ▲/▼, SELECT, and POINT buttons.

### SCREEN MENU

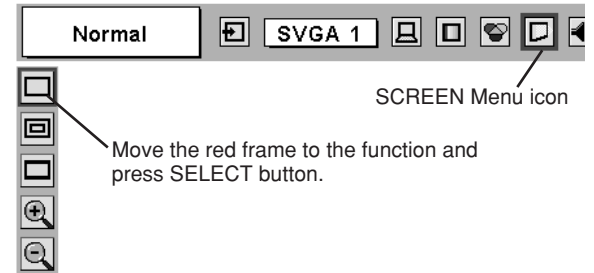

### NOTE

- This SCREEN Menu cannot be operated when "1035i (HDTV)" or "1080i (HDTV)" is selected on PC SYSTEM Menu (P22).
- Wide cannot be selected when "720p (HDTV)" is selected on PC SYSTEM Menu (P22).
- True and Digital zoom +/- cannot be selected when "RGB" is selected on PC SYSTEM Menu (P22).
- This projector cannot display any resolution higher than 1280 X 1024. If your computer's screen resolution is higher than 1280 X 1024, reset the resolution to the lower before connecting projector.
- The image data in other than SVGA (800 x 600) is modified to fit the screen size in initial mode.
- Panning function may not operate properly if the computer system prepared on PC ADJUST Menu is used.

## SELECTING INPUT SOURCE

### DIRECT OPERATION

Choose Video by pressing INPUT button on Top Control or on Remote Control Unit.

If projector cannot reproduce proper video source, select correct input source through MENU OPERATION (see below).

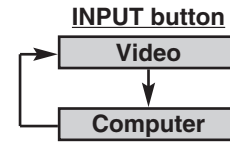

### MENU OPERATION

- 1 Press MENU button and ON-SCREEN MENU will appear. Press POINT LEFT/RIGHT button to move a red frame pointer to INPUT Menu icon.
- 2 Press POINT DOWN button to move a red arrow pointer to Video and then press SELECT button. Source Select Menu will appear.
- 3 Move a pointer to the source that you want to select and then press SELECT button.

#### Auto

Projector automatically detects incoming Video signal, and adjusts itself to optimize its performance.

- When both VIDEO jack and S-VIDEO jack are connected, S-VIDEO jack has priority over VIDEO jack.
- When both Y-Pb/Cb-Pr/Cr jacks and S-VIDEO jack are connected, Y-Pb/Cb-Pr/Cr jacks have priority over S-VIDEO jack.

#### Video

When video input signal is connected to VIDEO jack, select Video.

#### S-Video

When video input signal is connected to S-VIDEO jack, select S-Video.

#### Y,Pb/Cb,Pr/Cr

When video input signal is connected to Y-Pb/Cb-Pr/Cr jacks, select Y, Pb/Cb, Pr/Cr.

### INPUT MENU

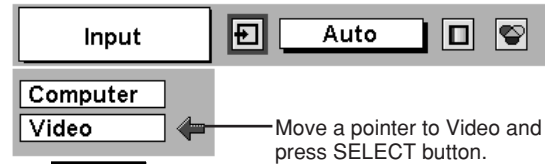

### VIDEO

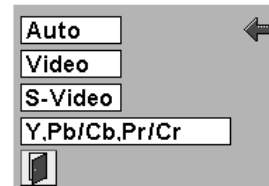

### Source Select Menu (VIDEO)

Move a pointer to the source and press SELECT button.

## SELECTING VIDEO SYSTEM

- 1 Press MENU button and ON-SCREEN MENU will appear. Press POINT LEFT/RIGHT buttons to move a red frame pointer to AV SYSTEM Menu icon.
- 2 Press POINT DOWN button to move a red arrow pointer to the system that you want to select and then press SELECT button.

### VIDEO JACK OR S-VIDEO JACK

#### Auto

Projector automatically detects incoming Video system, and adjusts itself to optimize its performance.

When Video System is PAL-M or PAL-N, select system manually.

#### PAL / SECAM / NTSC / NTSC4.43 / PAL-M / PAL-N

If projector cannot reproduce proper video image, it is necessary to select a specific broadcast signal format among PAL, SECAM, NTSC, NTSC 4.43, PAL-M, and PAL-N.

#### AV SYSTEM MENU (VIDEO OR S-VIDEO)

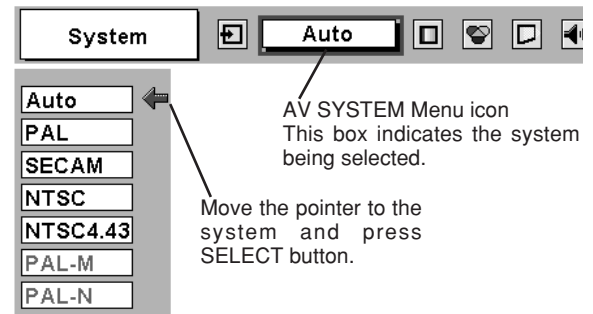

### Y, Pb/Cb, Pr/Cr JACKS

#### Auto

Projector automatically detects incoming Video signal, and adjusts itself to optimize its performance.

#### COMPONENT VIDEO SIGNAL FORMAT

If projector cannot reproduce proper video image, it is necessary to select a specific component video signal format among 480i, 575i, 480p, 575p, 720p, 1035i and 1080i.

#### AV SYSTEM MENU (COMPONENT VIDEO)

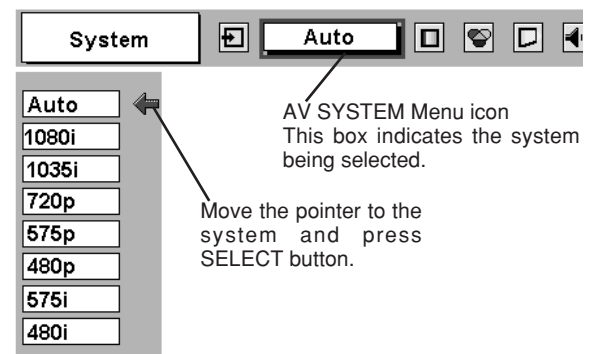

# PICTURE IMAGE ADJUSTMENTS

## IMAGE LEVEL SELECT (DIRECT)

Select image level among Standard, Cinema, Image 1, Image 2, Image 3 and Image 4 by pressing IMAGE button on Top Control or on Remote Control Unit.

**Standard**

Normal picture level preset on this projector.

**Cinema**

Picture level adjusted for the picture with fine tone.

**IMAGE 1~4**

User preset picture adjustment in IMAGE ADJUST Menu (P33, 34).

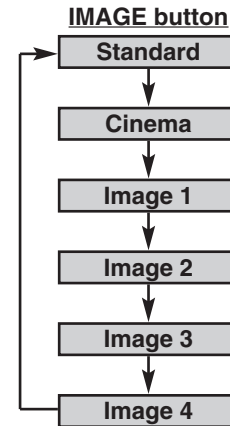

## IMAGE LEVEL SELECT (MENU)

**1** Press MENU button and ON-SCREEN MENU will appear. Press POINT LEFT/RIGHT button to move a red frame pointer to IMAGE SELECT Menu icon.

**2** Press POINT DOWN button to move a red frame pointer to the level that you want to set and then press SELECT button.

 **Standard**

Normal picture level preset on this projector.

 **Cinema**

Picture level adjusted for the picture with fine tone.

 **IMAGE 1~4**

User preset picture adjustment in IMAGE ADJUST Menu (P33, 34).

**IMAGE SELECT MENU**

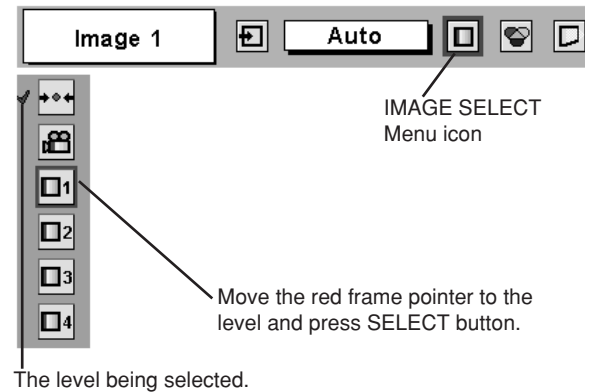



## IMAGE LEVEL ADJUSTMENT

- 1 Press MENU button and ON-SCREEN MENU will appear. Press POINT LEFT/RIGHT button(s) to move a red frame pointer to IMAGE ADJUST Menu icon.
- 2 Press POINT DOWN button to move a red frame pointer to the item that you want to adjust and then press SELECT button. The level of each item is displayed. Adjust each level by pressing POINT LEFT/RIGHT button(s).

### Contrast

Press POINT LEFT button to decrease contrast, and POINT RIGHT button to increase contrast. (From 0 to 63.)

### Brightness

Press POINT LEFT button to adjust image darker, and POINT RIGHT button to adjust brighter. (From 0 to 63.)

### Color

Press POINT LEFT button to lighten color, and POINT RIGHT button to deeper color. (From 0 to 63.)

### Tint

Press POINT LEFT button or POINT RIGHT button to obtain proper color. (From 0 to 63.)

### White balance (Red)

Press POINT LEFT button to lighten red tone and POINT RIGHT button to deeper tone. (From 0 to 63.)

### White balance (Green)

Press POINT LEFT button to lighten green tone and POINT RIGHT button to deeper tone. (From 0 to 63.)

### White balance (Blue)

Press POINT LEFT button to lighten blue tone and POINT RIGHT button to deeper tone. (From 0 to 63.)

### Sharpness

Press POINT LEFT button to soften the image, and POINT RIGHT button to sharpen the image. (From 0 to 31.)

### Gamma

Press either POINT LEFT button or POINT RIGHT button to obtain better balance of contrast. (From 0 to 15.)

NOTE : Tint cannot be adjusted when the video system is PAL, SECAM, PAL-M or PAL-N.

### IMAGE ADJUST MENU

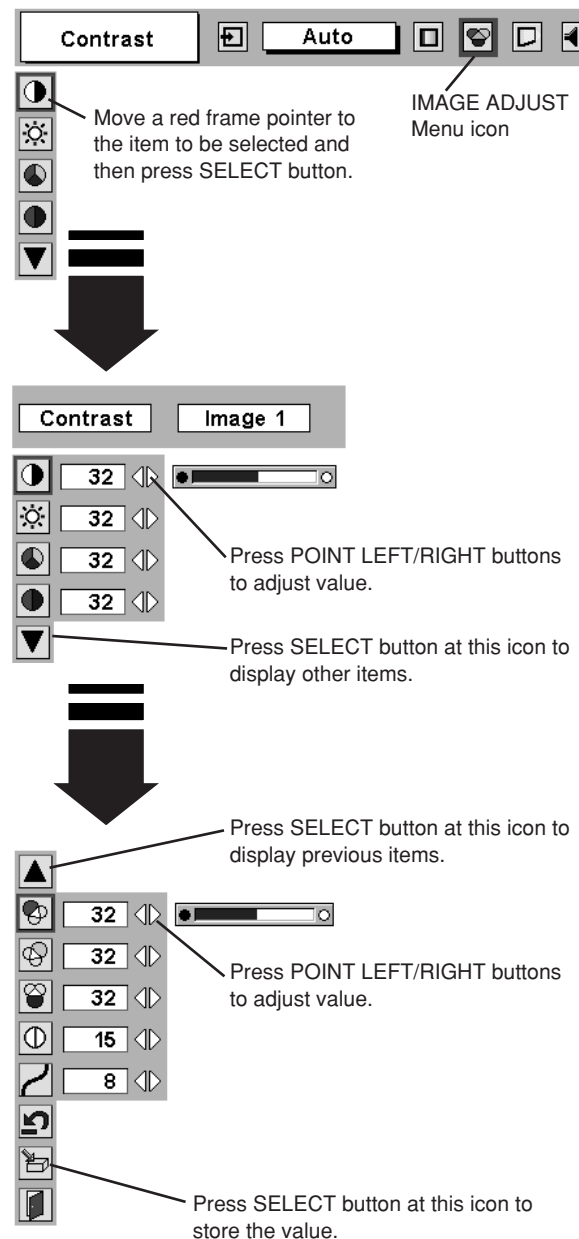

## 3 Store

To store the adjustment data, move a red frame pointer to Store icon and press SELECT button. Image Level Menu will appear. Move a red frame pointer to the Image Level 1 to 4 and then press SELECT button.

Other icons operate as follows.

## Reset

Reset all adjustment to previous figure.

## Quit

Closes IMAGE MENU.

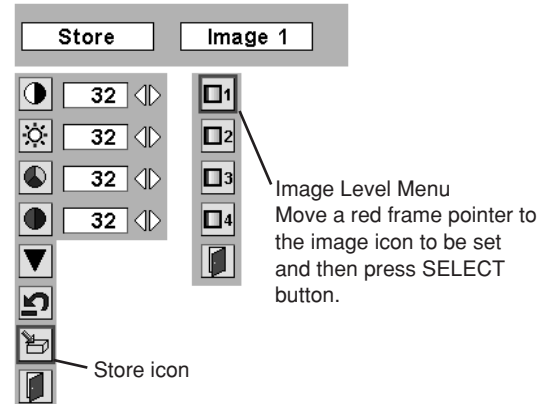

# PICTURE SCREEN ADJUSTMENT

This projector has a picture screen resize function, which enables you to display the desirable image size.

- 1 Press MENU button and ON-SCREEN MENU will appear. Press POINT LEFT/RIGHT button(s) to move a red frame pointer to SCREEN Menu icon.
- 2 Press POINT DOWN button and move a red frame pointer to the function that you want to select and then press SELECT button.

## Normal

Provides image at a normal video aspect ratio of 4 : 3.

## Wide

Provides image at a wide screen ratio of 16 : 9.

## SCREEN MENU

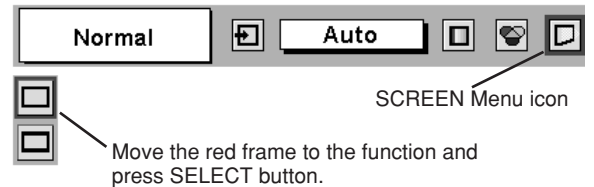

NOTE : SCREEN Menu cannot be operated when "720p," "1035i," or "1080i" is selected on AV SYSTEM Menu (P31).

## SETTING MENU

- 1 Press MENU button and ON-SCREEN MENU will appear. Press POINT LEFT/RIGHT button(s) to move a red-frame pointer to SETTING icon.
- 2 Press POINT DOWN button to move a red-frame pointer to the item that you want to set and then press SELECT button. Setting dialog box appears.

### Language

Language used in ON-SCREEN MENU is selectable from among English, German, French, Italian, Spanish, Portuguese, Dutch, Swedish, Chinese, Korean and Japanese.

### Keystone

When the image is distorted, select Keystone. ON-SCREEN MENU disappears and Keystone dialog box is displayed. Correct keystone distortion by pressing POINT UP/DOWN/LEFT/RIGHT button(s). Refer to KEYSTONE ADJUSTMENT on page 20.

### Blue back

When this function is "On," this projector will produce a blue image instead of the video noise on the screen when any input source is unplugged or turned off.

### Display

This function decides whether to display On-Screen Displays.

- On ... shows all the On-Screen Displays.
- Off ... sets On-Screen Displays disappeared except;
  - ON-SCREEN MENU
  - "Power off?" message

### Logo

When this function is "On," projector displays our logo when starting up.

### Ceiling

When this function is "On," picture is top / bottom and left / right reversed. This function is used to project the image from a ceiling mounted projector.

### Rear

When this function is "On," picture is left / right reversed. This function is used to project the image to a rear projection screen.

### SETTING MENU

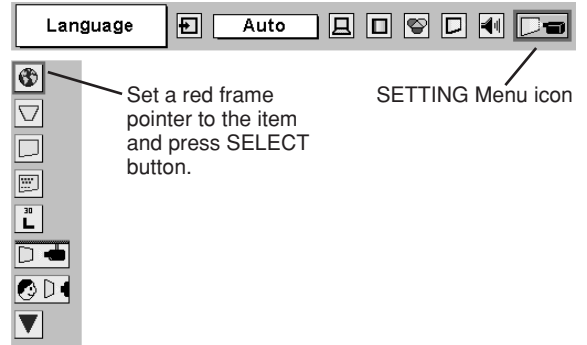

When pressing SELECT button at Language, Language Menu appears.

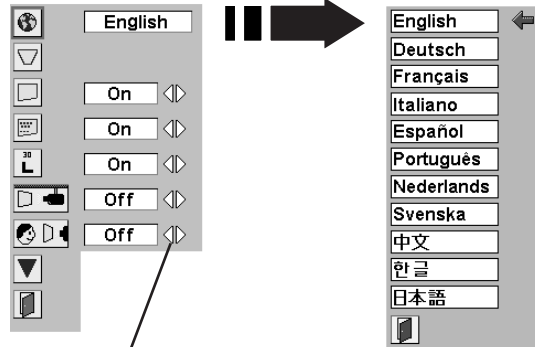

### Ceiling function

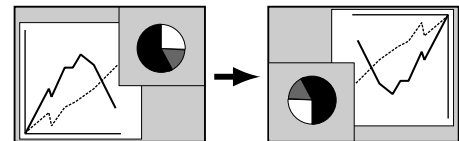

### Rear function

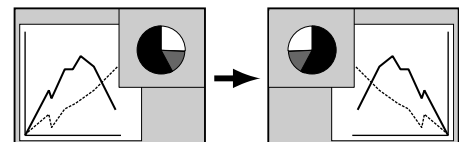



## Power management

This function turns Projection Lamp off when this projector detects signal interruption and is not used for a certain period in order to reduce power consumption and maintain the Lamp-life. (This projector is shipped with this function ON.)

Power Management function operates to turn Projection Lamp off when the input signal is interrupted and any button is not pressed over 5 minutes. This function operates as follows;

1. When any input signal is interrupted, "No signal" and the counting down display appears (for 5 minutes).
2. After counting down for 5 minutes, Projection Lamp and READY Indicator are turned off. (Cooling Fans keep running.)
3. READY Indicator starts to flash after cooling down Projection Lamp about for 90 seconds (Power Management mode).  
In this Power Management mode, Projection Lamp is automatically turned on when the input signal is connected or projector is operated with any button on Top Control or on Remote Control Unit again.



## On start

When this function is "On," projector is automatically turned on just by connecting AC Power cord to a wall outlet.

Note ; Be sure to turn projector off properly (refer to the section "TURNING OFF PROJECTOR" on P19). If projector is turned off in the wrong steps, On Start function does not operate properly.



## Remote control

This projector has two different remote control codes; the factory-set normal code (Code 1) and the secondary code (Code 2). This switching function prevents remote control operation mixture (jam) when operating several projectors or video equipment together. When operating projector in "Code 2," both projector and Remote Control Unit must be switched to "Code 2."

### To change the code of Projector;

Set Remote control in the SETTING MENU to "Code 2."

### To change the code of the Remote Control Unit;

Press both MENU and IMAGE buttons on Remote Control Unit together for over 10 seconds.

After changing the code, make sure Remote Control Unit operates properly.

To return to the normal code (Code 1), operate both projector and Remote Control Unit in the ways above again.

NOTE : When batteries of Remote Control Unit are replaced or ALL-OFF switch is turned to "ALL-OFF," the remote transmit code automatically returns to the normal code (Code 1).



## Lamp counter reset

This function is used to reset Lamp Replace Counter. When replacing Projection Lamp, reset Lamp Replace Counter by using this function. Refer to page 38 for operation.



Time left until Lamp off.

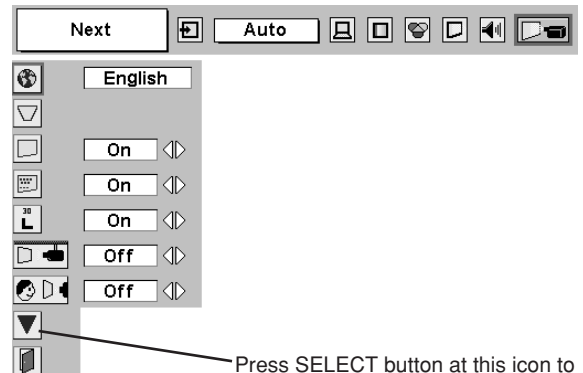

Press SELECT button at this icon to display other items.

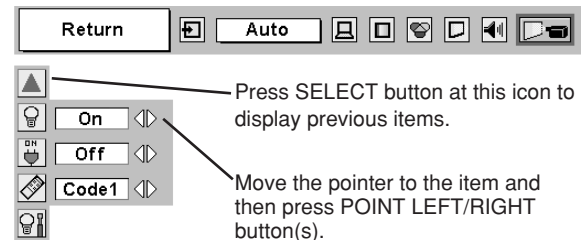

Press SELECT button at this icon to display previous items.

Move the pointer to the item and then press POINT LEFT/RIGHT button(s).

## LAMP REPLACEMENT

### LAMP REPLACE

When the life of the Projection Lamp of this projector draws to an end, the LAMP REPLACE indicator lights yellow. If this indicator lights yellow, replace the projection lamp with a new one promptly.

#### TOP CONTROL

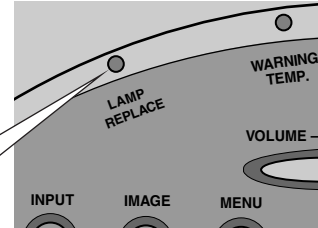

This indicator lights yellow when the life of the projection lamp draws to an end. Replace the Projection Lamp with a new one promptly.



Allow a projector to cool, for at least 45 minutes before you open Lamp Cover. The inside of a projector can become very hot.



### CAUTION

For continued safety, replace with a lamp assembly of the same type.

Do not drop a lamp assembly or touch a glass bulb! The glass can shatter and may cause injury.

Follow these steps to replace the lamp assembly.

- 1** Turn off the projector and disconnect the AC plug. Allow the projector to cool for at least 45 minutes.
- 2** To remove Lamp Cover, remove the screw with a screwdriver.
- 3** Loosen 3 screws with a screwdriver and pull out Lamp Assembly by grasping Handle.
- 4** Replace Lamp Assembly with a new one and tighten 3 screws back into position. Make sure that Lamp Assembly is set properly. Replace Lamp Cover and tighten the screw.
- 5** Connect AC Power Cord to the projector and turn on the projector.
- 6** **Reset the Lamp Replace Counter.**  
Refer to "LAMP REPLACE COUNTER" on the next page .

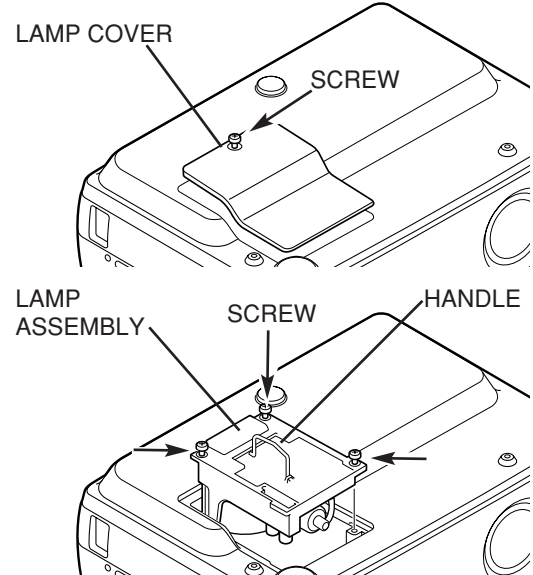

### ORDER REPLACEMENT LAMP

Replacement Lamp can be ordered through your dealer. When ordering a Projection Lamp, give the following information to the dealer.

- **Model No. of your projector** : **PLC-SU33**
- **Replacement Lamp Type No.** : **POA-LMP35**

(Service Parts No. 610 293 2751)

## LAMP REPLACE COUNTER

Be sure to reset the Lamp Replace Counter after the Lamp Assembly is replaced. When the Lamp Replace Counter is reset, the LAMP REPLACE Indicator stops lighting.

- 1 Turn projector on, press MENU button and ON-SCREEN MENU will appear. Press POINT LEFT/RIGHT button(s) to move a red frame pointer to SETTING Menu icon (refer to page 35, 36).
- 2 Press POINT DOWN button to move a red frame pointer to "Lamp counter reset" and then press SELECT button. The message "Lamp replace counter reset?" is displayed. Move the pointer to [Yes] and then press SELECT button.
- 3 Another confirmation dialog box appears and select [Yes] to reset Lamp Replace Counter.

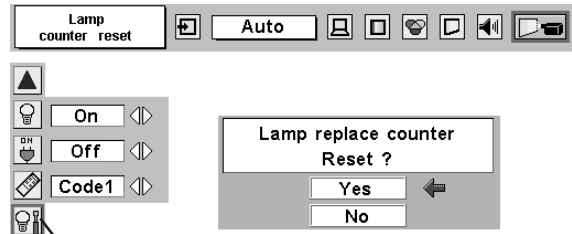

Move the pointer to Lamp counter reset and then press SELECT button. The message "Lamp replace counter reset?" is displayed.

**NOTE : Do not reset the Lamp Replace Counter until after the Projection Lamp is replaced.**



## LAMP HANDLING PRECAUTIONS

This projector uses a high-pressure lamp which must be handled carefully and properly. Improper handling may result in accidents, injury, or create a fire hazard.

- Lamp lifetime may differ from lamp to lamp and according to the environment of use. There is no guarantee of the same lifetime for each lamp. Some lamps may fail or terminate their lifetime in a shorter period of time than other similar lamps.
- If the projector indicates that the lamp should be replaced, i.e., if the LAMP REPLACE INDICATOR lights up, replace the lamp with a new one IMMEDIATELY after the projector has cooled down. ( Follow carefully the instructions in the LAMP REPLACEMENT section of this manual. ) Continuous use of the lamp with the LAMP REPLACE INDICATOR lighted may increase the risk of lamp explosion.
- A Lamp may explode as a result of vibration, shock or degradation as a result of hours of use as its lifetime draws to an end. Risk of explosion may differ according to the environment or conditions in which the projector and lamp are being used.

### IF A LAMP EXPLODES, THE FOLLOWING SAFETY PRECAUTIONS SHOULD BE TAKEN.

If a lamp explodes, disconnect the projector's AC plug from the AC outlet immediately. Contact an authorized service station for a checkup of the unit and replacement of the lamp. Additionally, check carefully to ensure that there are no broken shards or pieces of glass around the projector or coming out from the cooling air circulation holes. Any broken shards found should be cleaned up carefully. No one should check the inside of the projector except those who are authorized trained technicians and who are familiar with projector service. Inappropriate attempts to service the unit by anyone, especially those who are not appropriately trained to do so, may result in an accident or injury caused by pieces of broken glass.

## OPERATING WIRELESS MOUSE

The Wireless Remote Control Unit is not only able to operate this projector but is also usable as a Wireless Mouse for most Personal Computers. The POINT button and two CLICK buttons are used for wireless mouse operation.

This Wireless Mouse function is available only when PC mouse pointer is displayed on a projected screen. When ON-SCREEN MENU or any message / dialog box is displayed on the screen instead of PC mouse pointer, the POINT and CLICK buttons control the projector, rather than the computer.

## INSTALLATION

To use the Wireless Remote Control Unit as Wireless Mouse, a mouse driver must be already installed on your computer. No mouse driver is supplied with this projector: instead, the Wireless Remote Control Unit becomes the pointing device for your computer's existing mouse driver. Make sure that the mouse driver is properly installed in your computer, and that the appropriate port (PS/2, DB9, ADB, or USB port) is activated. Note that only a PS/2 mouse cable is supplied with the projector: for other mouse cables, contact your dealer.

- 1 With the projector and computer both OFF, connect the mouse port (or USB port) of your computer to Control Port (or USB connector) of this projector with the appropriate cable. (Refer to page 11, 12 for connection.)
- 2 Turn the projector ON first, and then turn ON your computer. When the computer is switched on first, Wireless Mouse may not work properly.

## OPERATING WIRELESS MOUSE

When controlling a mouse pointer, operate Wireless Mouse with the POINT button, SELECT button, and RIGHT CLICK button on the Wireless Remote Control Unit.

### POINT button

Used to move mouse pointer. The pointer is moved in a direction corresponding to the direction you are pressing.

### SELECT (LEFT CLICK) button

This button has the same function as the left button in a PC mouse.

### RIGHT CLICK button

This button has the same function as the right button in a PC mouse.

POINT button (Move the pointer)

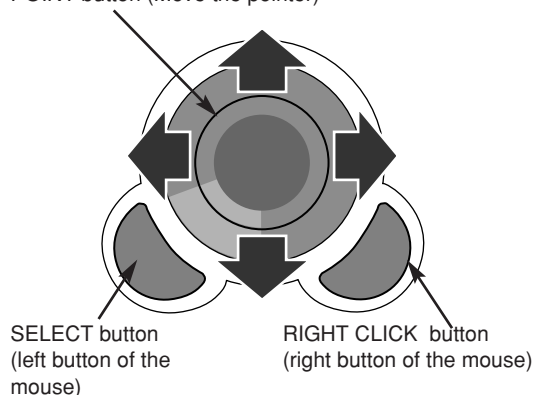

## MAINTENANCE

### WARNING TEMP. INDICATOR

WARNING TEMP. Indicator flashes red when an internal temperature of a projector exceeds the normal temperature. This Indicator stops flashing when the temperature of a projector returns to normal.

When WARNING TEMP. Indicator continues to flash, check the items listed below.

- 1 Ventilation Slots of the projector may be blocked. In such an event, reposition the projector so that Ventilation Slots are not obstructed.
- 2 Air Filter may be clogged with dust particles. Clean Air Filter by following the section AIR FILTER CARE AND CLEANING below.
- 3 If WARNING TEMP. Indicator remains on after performing the above checks, Cooling Fans or the Internal Circuits may be malfunctioning. Contact service personnel from an authorized dealer or a service station.

### AIR FILTER CARE AND CLEANING

Removable Air Filter prevents dust from accumulating on the surface of Projection Lens and Projection Mirror. Should Air Filter become clogged with dust particles, it will reduce Cooling Fans' effectiveness and may result in internal heat build up and adversely affect the life of the projector. Clean Air Filter following the steps below:

- 1 Turn off the projector, and disconnect AC power cord from the AC outlet.
- 2 Turn the projector upside down and remove Air Filter by pulling the latches upward.
- 3 Clean Air Filter with a brush or wash out dust and particles.
- 4 Replace Air Filter properly. Make sure that Air Filter is fully inserted.



**CAUTION**

Do not operate the projector with Air Filter removed. Dust may accumulate on LCD Panel and Projection Mirror degrading picture quality.

Do not put small parts into Air Intake Vents. It may result in malfunction of the projector.

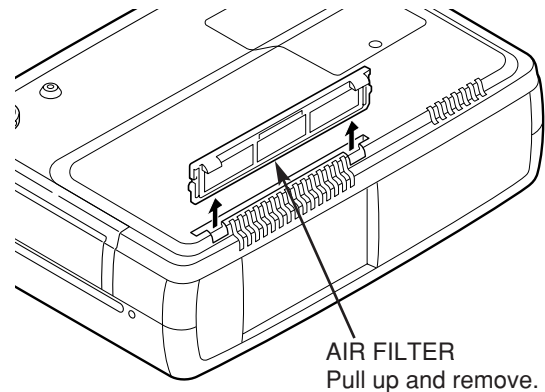

**RECOMMENDATION**

**We recommend avoiding dusty/smoky environments when operating a projector. Usage in these environments may cause poor image quality.**

When using under dusty or smoky conditions, dust may accumulate on a lens, liquid crystal panels, or optical elements inside the projector. This condition may degrade the quality of a projected image.

When the above symptoms are noticed, contact your authorized dealer or service station for proper cleaning.

### CLEANING PROJECTION LENS

Follow these steps to clean Projection Lens:

- 1 Apply a non-abrasive camera lens cleaner to a soft, dry cleaning cloth. Avoid using an excessive amount of cleaner. Abrasive cleaners, solvents or other harsh chemicals might scratch a surface.
- 2 Lightly wipe a cleaning cloth over Projection Lens.
- 3 When the projector is not in use, replace Lens Cover.



## TROUBLESHOOTING

Before calling your dealer or service center for assistance, check the items below once again.

1. Make sure you have connected a projector to your computer or video equipment as described in the section "CONNECTING PROJECTOR" on pages 11 ~ 13.
2. Check cable connection. Verify that all computer, video and power cord are properly connected.
3. Verify that all power is switched on.
4. If the projector still does not produce an image, re-start your computer.
5. If an image still does not appear, unplug the projector from your computer and check your computer monitor's display. The problem may be with your graphics controller rather than with the projector. (When you reconnect the projector, be sure to turn the computer and monitor off before you power up the projector. Turn the projector on, and then the computer.)
6. If the problem still exists, check the following chart.

Problem:	Try these Solutions
<b>No power.</b>	<ul style="list-style-type: none"> <li>● Plug the projector into your AC outlet.</li> <li>● Make sure READY Indicator lights.</li> <li>● Wait 90 seconds after the projector is turned OFF when turning the projector back on.</li> </ul> <p>NOTE : After pressing Power ON-OFF button to OFF, make sure the projector works as follows:</p> <ol style="list-style-type: none"> <li>1. LAMP indicator lights bright, and READY indicator is turned off.</li> <li>2. After 90 seconds, READY indicator lights green again and the projector can be turned on by pressing Power ON-OFF button.</li> </ol> <ul style="list-style-type: none"> <li>● Check WARNING TEMP. indicator. If the indicator flashes red, the projector cannot be turned on. (See "TURNING ON/OFF PROJECTOR" section on page 19.)</li> <li>● Check Projection Lamp. (Refer to page 37.)</li> </ul>
<b>Image is out of focus.</b>	<ul style="list-style-type: none"> <li>● Adjust focus of the projector.</li> <li>● Make sure the projection screen is at least 3.0' (0.9m) from the projector.</li> <li>● Check Projection Lens to see if it needs cleaning.</li> </ul> <p>NOTE : Moving the projector from a cool temperature location to a warm temperature location may result in moisture condensation on Projection Lens. In such an event, leave the projector OFF and wait until condensation disappears.</p>
<b>Picture is Left/Right reversed.</b>	<ul style="list-style-type: none"> <li>● Check Ceiling / Rear feature. (See "SETTING" section on page 35.)</li> </ul>
<b>Picture is Top/Bottom reversed.</b>	<ul style="list-style-type: none"> <li>● Check Ceiling feature. (See "SETTING" section on page 35.)</li> </ul>
<b>Some displays are not seen during the Operation.</b>	<ul style="list-style-type: none"> <li>● Check Display feature.(See "SETTING" section on page 35.)</li> </ul>
<b>No image.</b>	<ul style="list-style-type: none"> <li>● Check the connection between your computer or video equipment and a projector.</li> <li>● When turning a projector on, it takes about 30 seconds to display an image.</li> <li>● Check the system that you select is corresponding with your computer or video equipment.</li> <li>● Make sure the temperature is not out of Operating Temperature (5°C ~ 35°C).</li> </ul>
<b>No sound.</b>	<ul style="list-style-type: none"> <li>● Check audio cable connection from audio input source.</li> <li>● Adjust the audio source.</li> <li>● Press VOLUME (+) button.</li> <li>● Press MUTE button.</li> </ul>

<b>Problem:</b>	<b>Try these Solution</b>
<b>Remote Control Unit does not work.</b>	<ul style="list-style-type: none"> <li>● Check the batteries.</li> <li>● Check ALL-OFF switch on Remote Control Unit is set to "ON."</li> <li>● Make sure nothing is between Infrared Remote Receiver and Remote Control Unit.</li> <li>● Make sure you are not too far from a projector when using Remote Control Unit. Maximum operating range is 16.4' (5m).</li> <li>● Make sure the code of Remote Control Unit is set to conform to projector. (See "SETTING" section on page 35, 36.)</li> </ul>
<b>Wireless Mouse function does not work.</b>	<ul style="list-style-type: none"> <li>● Check cable connection between a projector and your computer.</li> <li>● Check the mouse setting on your computer.</li> <li>● Turn a projector on before turning on a computer.</li> </ul>

**WARNING :**

**High voltages are used to operate this projector. Do not attempt to open the cabinet.**

If the problem still persists after following all operating instructions, contact the sales dealer where you purchased the projector or the service center. Give the model number and explain about the problem. We will advise you how to obtain service.



This symbol on the nameplate means the product is Listed by Underwriters Laboratories Inc. It is designed and manufactured to meet rigid U.L. safety standards against risk of fire, casualty and electrical hazards.

## TECHNICAL SPECIFICATIONS

<b>Projector Type</b>	Multi-media Projector
<b>Dimensions (W x H x D)</b>	13.11" x 3.52" x 9.96" (333mm x 89.5mm x 253mm) (not including Adjustable Feet)
<b>Net Weight</b>	9.7 lbs (4.4 kg)
<b>LCD Panel System</b>	0.9" TFT Active Matrix type, 3 panels
<b>Panel Resolution</b>	800 x 600 dots
<b>Number of Pixels</b>	1,440,000 (800 x 600 x 3 panels)
<b>Color System</b>	PAL, SECAM, NTSC, NTSC4.43, PAL-M and PAL-N
<b>High Definition TV Signal</b>	480i, 480p, 575i, 575p, 720p, 1035i, and 1080i
<b>Scanning Frequency</b>	H-sync. 15 ~ 80 KHz, V-sync. 50 ~ 100 Hz
<b>Projection Image size (Diagonal)</b>	Adjustable from 34" to 300"
<b>Horizontal Resolution</b>	750 TV lines
<b>Projection Lens</b>	F 1.9 ~ 2.1 lens with f 21.3 mm ~ 25.6 mm with motor zoom and focus
<b>Throw Distance</b>	3.0' ~ 22.6' (0.9 m ~ 6.9 m)
<b>Projection Lamp</b>	200 W
<b>Video Input Jacks</b>	RCA Type x 3 (Video/Y, Pb/Cb, Pr/Cr) and Mini DIN 4 pin x 1 (S-Video)
<b>Audio Input Jacks</b>	RCA Type x 2
<b>Computer Input Terminal</b>	DVI-I Terminal (Digital/Analog)
<b>Monitor Out Terminal</b>	(VGA) HDB 15 Terminal x 1
<b>Computer Audio Input Jack</b>	Mini Jack (stereo) x 1
<b>Control Port Connector</b>	Mini DIN 8 pin x 1
<b>USB Connector</b>	USB Series B receptacle x 1
<b>Audio Output Jacks</b>	RCA Type x 2
<b>Internal Audio Amp</b>	1.0 W RMS
<b>Built-in Speaker</b>	1 speaker, 1.18" x 1.57" (30mm x 40mm)
<b>Feet Adjustment</b>	0° to 15.6°
<b>Voltage and Power Consumption</b>	AC 100 ~ 120 V (3.6 A Max. Ampere), 50 / 60 Hz (The U.S.A and Canada) AC 200 ~ 240 V (1.8 A Max. Ampere), 50 / 60 Hz (Continental Europe and The U.K.)
<b>Operating Temperature</b>	41 °F ~ 95 °F (5 °C ~ 35 °C)
<b>Storage Temperature</b>	14 °F ~ 140 °F (-10 °C ~ 60 °C)
<b>Remote Control Unit</b>	Power Source : AA, UM3 or R06 Type x 2 Operating Range : 16.4' (5m) / ±30° Dimensions : 2.2" x 1.3" x 7.6" (55mm x 34mm x 192mm) Net Weight : 0.35 lbs (160 g) (including batteries)
<b>Accessories</b>	Owner's Manual AC Power Cord Remote Control Unit and Batteries VGA Cable Control Cable for PS/2 port DVI/VGA Adapter Carrying Bag Lens Cover

- The specifications are subject to change without notice.
- LCD panels are manufactured to the highest possible standards. Even though 99.99% of the pixels are effective, a tiny fraction of the pixels (0.01% or less) may be ineffective by the characteristics of the LCD panels.

## CONFIGURATIONS OF TERMINALS

### MONITOR OUT TERMINAL (ANALOG)

Terminal : HDB15-PIN

#### Pin Configuration

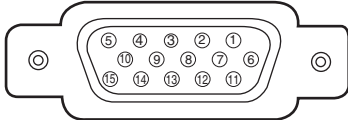

1	Red Input	9	+5V Power
2	Green Input	10	Ground (Vert.sync.)
3	Blue Input	11	Sense 0
4	Sense 2	12	DDC Data
5	Ground (Horiz.sync.)	13	Horiz. sync.
6	Ground (Red)	14	Vert. sync.
7	Ground (Green)	15	DDC Clock
8	Ground (Blue)		

### DVI-I TERMINAL (DIGITAL/ANALOG)

#### Pin Configuration

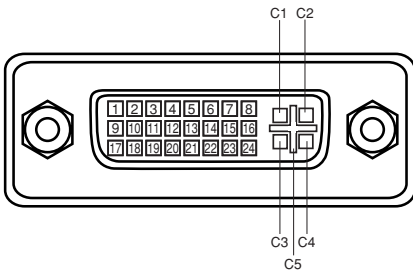

<b>C1</b>	Analog Red Input
<b>C2</b>	Analog Green Input
<b>C3</b>	Analog Blue Input
<b>C4</b>	Analog Horiz. sync
<b>C5</b>	Analog Ground (R/G/B)

1	T.M.D.S. Data2-	9	T.M.D.S. Data1-	17	T.M.D.S. Data0-
2	T.M.D.S. Data2+	10	T.M.D.S. Data1+	18	T.M.D.S. Data0+
3	T.M.D.S. Data2/4 Shield	11	T.M.D.S. Data1/3 Shield	19	T.M.D.S. Data0/5 Shield
4	+3.3V MCI	12	+5V MCI	20	Viewer RXD
5	W-LAN	13	Card In	21	Viewer TXD
6	DDC Clock	14	+5V Power	22	T.M.D.S. Clock Shield
7	DDC Data	15	Ground (for +5V)	23	T.M.D.S. Clock+
8	Analog Vert. sync	16	Hot Plug Detect	24	T.M.D.S. Clock-

**CONTROL PORT CONNECTOR**

Terminal : Mini DIN 8-PIN

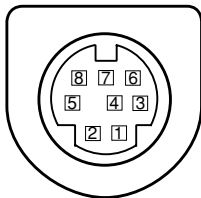
**Pin Configuration**

	PS/2	Serial	ADB
1	-----	R X D	-----
2	CLK	-----	ADB
3	DATA	-----	-----
4	GND	GND	GND
5	-----	RTS / CTS	-----
6	-----	T X D	-----
7	GND	GND	-----
8	-----	GND	GND

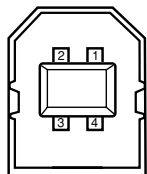
**USB CONNECTOR (Series B)****Pin Configuration**

1	Vcc
2	- Data
3	+ Data
4	Ground

**OPTIONAL PARTS**

The parts listed below are optionally supplied. When ordering those parts, give the name and Type No. to the sales dealer.

- **Control Cable (Serial Port)**                      **Type No. : POA-MCSRL**
- **Control Cable (ADB Port)**                      **Type No. : POA-MCMAC**
- **MAC Adapter**                                      **Type No. : POA-MACAP**
- **Media Card Imager Kit**                          **Type No. : POA-MD07MCI**
- **Wireless Imager Kit**                            **Type No. :** Available models are different in each country. Contact the sales dealer for details.

When using Wireless Imager, set the following model name to PJ Controller.

**Model Name : 09-1-1**





