

BenQ
PB6240 Digital Projector
Portable Series
User's Manual

Welcome

Copyright

Copyright 2005 by BenQ Corporation. All rights reserved. No part of this publication may be reproduced, transmitted, transcribed, stored in a retrieval system or translated into any language or computer language, in any form or by any means, electronic, mechanical, magnetic, optical, chemical, manual or otherwise, without the prior written permission of BenQ Corporation.

Disclaimer

BenQ Corporation makes no representations or warranties, either expressed or implied, with respect to the contents hereof and specifically disclaims any warranties, merchantability or fitness for any particular purpose. Further, BenQ Corporation reserves the right to revise this publication and to make changes from time to time in the contents hereof without obligation to notify any person of such revision or changes.

*DLP, Digital Micromirror Device and DMD are trademarks of Texas Instruments. Others are copyrights of their respective companies or organizations.

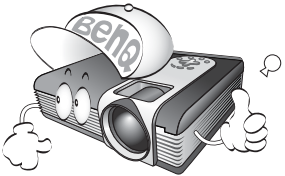
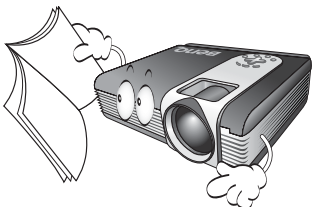

Table of contents

Important safety instructions	1
Introduction	5
Projector features	5
Shipping contents	6
Projector exterior view	7
Controls and functions	9
Positioning your projector	12
Choosing a location	12
Obtaining a preferred projected image size	13
Connection	15
Connecting a computer	15
Connecting Component Video devices	15
Connecting Video or S-Video devices	16
Connecting display devices	16
Operation	17
Start up	17
Utilizing the password function	17
Adjusting the image	19
Switching input signal	21
Hiding the image	21
Slide operation	21
Freezing the image	21
Shutdown	22
Menu operation	23
Maintenance	31
Care of the projector	31
Lamp information	32
Service information	36
Troubleshooting.....	37
Specifications.....	38

Projector specifications	38
Timing chart	39
Dimensions	40
Warranty.....	41
Limited Warranty	41
Regulation Statements	42
FCC statement	42
EEC statement	42
MIC statement	42

1 Important safety instructions

Your BenQ projector is designed and tested to meet the latest standards for safety of information technology equipment. However, to ensure safe use of this product, it is important that you follow the instructions mentioned in this manual and marked on the product.

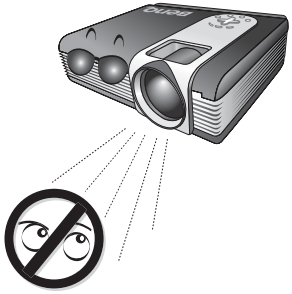
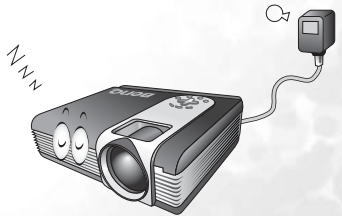
Caution	
<ul style="list-style-type: none">• To prevent shock, do not open the cabinet. There are no user serviceable parts inside. 	<ul style="list-style-type: none">• Refer servicing to qualified service personnel. 
<ul style="list-style-type: none">• Please read this user's manual before you operate your projector. Save this user's manual for future reference. 	<ul style="list-style-type: none">• Always open the lens shutter or remove the lens cap when the projector lamp is on. 
<ul style="list-style-type: none">• Do not look straight at the projector lens during operation. The intense light beam may damage your eyes. 	<ul style="list-style-type: none">• In some countries, the line voltage is NOT stable. This projector is designed to operate safely within a mains voltage between 100 to 240 volts AC, but could fail if power cuts or surges of ± 10 volts occur. In areas where the mains voltage may fluctuate or cut out, it is recommended that you connect your projector through a power stabilizer, surge protector or uninterruptible power supply (UPS). 

Safety Instructions

1. The lamp becomes extremely hot during operation. Allow the projector to cool for approximately 45 minutes prior to removing the lamp assembly for replacement.

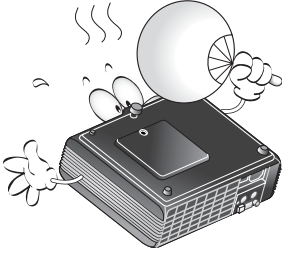

2. Do not operate lamps beyond the rated lamp life. Excessive operation of lamps beyond the rated life could cause them to break on rare occasions.



3. Never replace the lamp assembly or any electronic components unless the projector is unplugged.

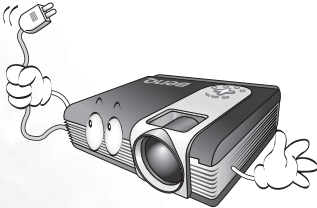

4. Do not place this product on an unstable cart, stand, or table. The product may fall, sustaining serious damage.



5. To reduce the risk of electric shock, do not disassemble this appliance. Take it to a qualified technician when service or repair is required. Incorrect reassembly can cause malfunction of the projector or electric shock when the appliance is subsequently used.



6. This product is capable of displaying inverted images for ceiling mount installation. Please use BenQ's Ceiling Mounting Kit for mounting the unit and ensure it is securely installed.

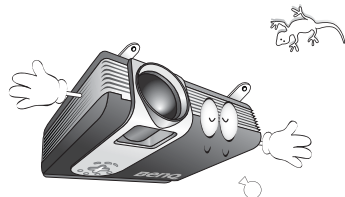

Safety Instructions (Continued)

7. Do not place this projector in any of the following environments.

- Space that is poorly ventilated or confined. Allow at least 50 cm clearance from walls and free flow of air around the projector.
- Locations where temperatures may become excessively high, such as the inside of a car with all windows rolled up.
- Locations where excessive humidity, dust, or cigarette smoke may contaminate optical components, shortening the projector's life span and darkening the image.



- Locations near fire alarms
- Locations with an ambient temperature above 35°C / 95°F
- Locations where the altitudes are higher than 10000 feet.

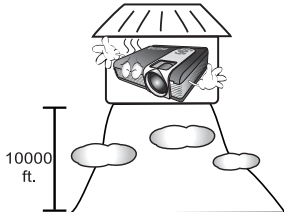

8. Do not block the ventilation holes.

- Do not place this unit on a blanket, bedding or any other soft surface.
- Do not cover this unit with a cloth or any other item.
- Do not place inflammables near the projector.



If the ventilation holes are seriously obstructed, overheating inside the unit may result in a fire.

9. Always place the unit on a level, horizontal surface during operation.

- Do not use if tilted at an angle of more than 10 degrees left to right, nor at angle of more than 15 degrees front to back. Using the unit when it is not fully horizontal may cause a malfunction of, or damage to, the lamp.

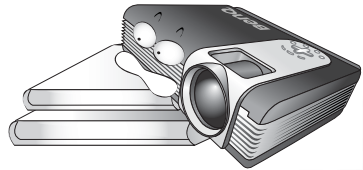

10. Do not stand the unit on end vertically.

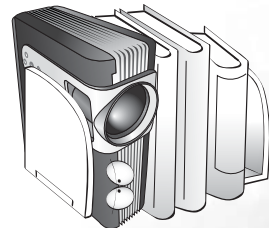

Doing so may cause the unit to fall over, causing injury or resulting in damage to the unit.

Safety Instructions (Continued)

11. Do not step on the projector or place any objects upon it.



Besides probable physical damage to the projector, doing so may result in accidents and possible injury.

12. Do not block the projection lens with any objects when the projector is under operation as this could cause the objects to become heated and deformed or even cause a fire. To temporarily turn off the lamp, press **Blank** on the projector or remote control.

13. Do not place liquids near or on the projector. Liquids spilled into the projector may cause it to fail. If the projector does become wet, disconnect it from the power supply's wall socket and call BenQ to have the projector serviced.



2 Introduction

Projector features

The projector integrates high-performance optical engine projection and a user-friendly design to deliver high reliability and ease of use.

The projector offers the following features:

- Selectable password protected function
- Compact and portable unit
- High quality manual zoom lens
- One-key auto-adjustment to display the best picture quality
- Digital keystone correction to correct distorted images
- Adjustable color balance control for data/video display
- Ultra-high brightness projection lamp
- Ability to display 16.7 million colors
- On-screen menus in 10 languages: English, French, German, Italian, Spanish, Russian, Traditional Chinese, Simplified Chinese, Japanese, and Korean.
- Switchable normal and Economic modes to reduce the power consumption
- Powerful AV function to provide high quality AV picture
- HDTV compatibility (YPbPr)



- **The apparent brightness of the projected image will vary depending on the ambient lighting conditions and contrast/brightness settings.**
- **The lamp brightness will decline over time and may vary within the lamp manufacturers specifications. This is normal and expected behavior.**

Shipping contents

The projector is shipped with the cables required for connection to a PC and to video equipment. Carefully unpack and verify that you have all of the items shown below. If any of these items are missing, please contact your place of purchase.

 **The supplied accessories will be suitable for your region, and may differ from the illustrated.**

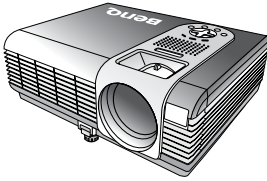

Projector



Soft carry case



User's manual



Quick start guide

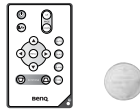

Remote control and battery

 **Pull the tab before using the remote control.**

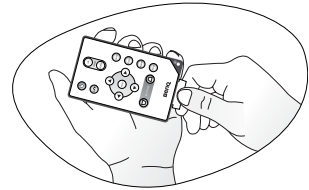

User's manual CD



Warranty booklet



S-Video cable



Video cable



VGA cable



Audio cables



USB cable



3-2 power adaptor



Power cord

Optional accessories

1. Macintosh adapter
2. 250W lamp module
3. Ceiling mount kit
4. Wireless Pro
5. Presentation Plus
6. Component Video cable
7. RS232 connector

Projector exterior view

Front / upper side

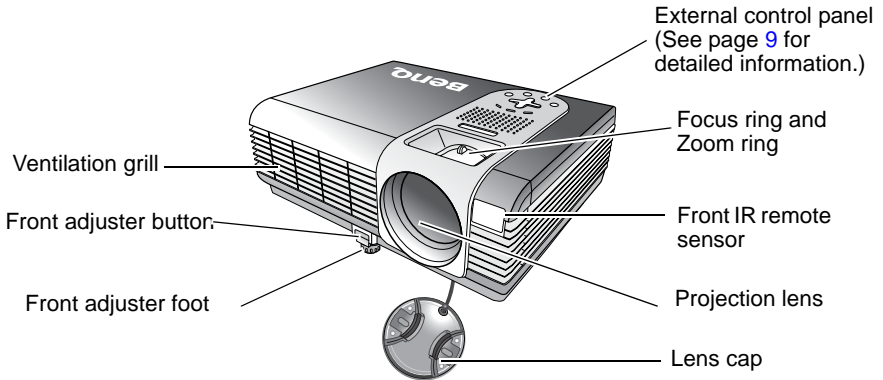

Rear side

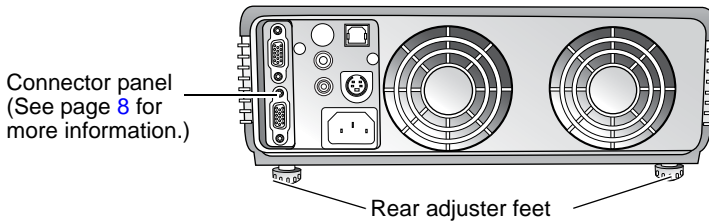

Bottom side

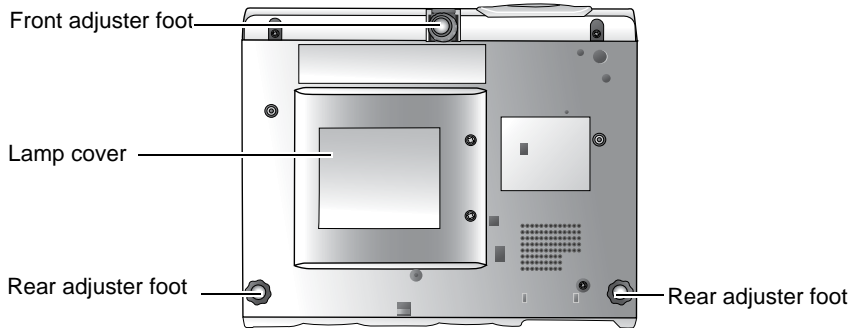

Connector panel

Refer to page 12 for more information on making connections to various equipment.

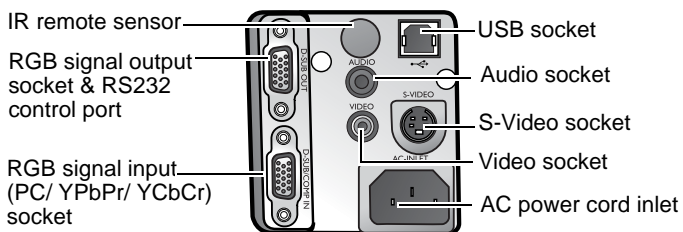

Controls and functions

External control panel

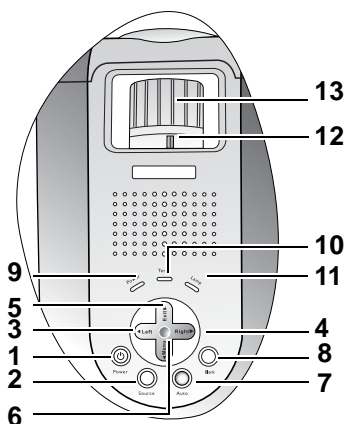

- 1. Power (Refer to pages 17 and 22 for more information.)**
Turns the projector on or off.
- 2. Source (Refer to page 21 for more information.)**
Sequentially selects the input signal RGB/YPbPr, Video or S-Video.
- 3. ◀ Left**
- 4. Right ▶**
When the on-screen menu is not activated, #3 and #4 function as **Keystone -/+** hot keys.
Refer to page 20 for more information.
- 5. ▲ Exit**
Exits and saves the menu settings.
- 6. ▼ Menu**
Turns the on-screen display control menu on.
When the on-screen menu is activated, the #3 to #6 buttons are used as directional arrows to select the desired menu items and to make adjustments.
Refer to page 24 for more information.
- 7. Auto (Refer to page 19 for more information.)**
Automatically determines the best picture timings for the displayed image.
- 8. Blank (Refer to page 21 for more information.)**
Used to hide the screen image. You can press **Blank** again to bring the image back.
- 9. Power indicator light (Refer to page 34 for more information.)**
Lights up or flashes when the projector is under operation.
- 10. Temperature warning light (Refer to page 34 for more information.)**
Flashes red if the projector's temperature becomes too high.
- 11. Lamp indicator light (Refer to page 32 for more information.)**
Indicates the status of the lamp. Lights up or flashes when the lamp has developed a problem.
- 12. Zoom ring (Refer to page 19 for more information.)**
Adjusts the size of the image.
Rotate clockwise to enlarge the image or rotate counter-clockwise to make the image smaller.
- 13. Focus ring (Refer to page 19 for more information.)**
Adjusts the focus of the projected image.

Remote Ccontrol

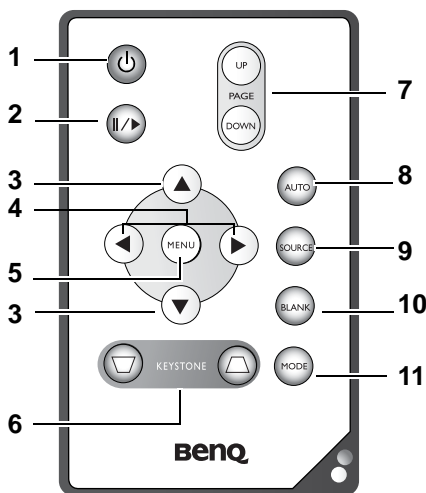

1. **Power** (Refer to pages 17 and 22 for more information.)
Turns the projector on or off.
2. **Freeze**
The image is frozen when **Freeze** is pressed. An icon “ **|||** ” will display in the lower right corner of the screen. To release the function, press **Freeze** again.
3. **Up, Down**
4. **Left / Right** ,
5. **Menu** (Refer to page 24 for more information.)
Used to select the desired menu items and to make adjustments.
6. **Keystone** **Keystone** (Refer to page 20 for more information.)
Manually corrects distorted images resulting from the angles of projection.
7. **Page Up and Down**
Connect the projector to your PC or notebook with a USB cable prior to using this function. You can operate your Microsoft® PowerPoint® presentation moving forwards and backwards.
8. **Auto** (Refer to page 19 for more information.)
Automatically determines the best picture timings for displayed image.
9. **Source** (Refer to page 21 for information.)
Sequentially select the input signal RGB, Component Video, S-Video or Video.
10. **Blank** (Refer to page 21 for more information.)
Used to hide the screen image. Press **Blank** again to restore the image.
11. **Mode** (Refer to page 25 for more information.)
According to the selected input signal, there are several picture setup options available.

Remote control effective range

Infra Red (IR) remote control sensors are located on the front and the back of the projector. The remote control must be held at an angle within 30 degrees of the projector's IR remote control sensors to function correctly. The distance between the remote control and the sensors should not exceed 6 meters (~ 20 feet).

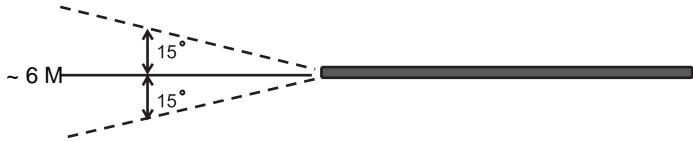

Notes on Remote Control Operation:

Make sure that there are no obstacles between the remote control and the IR sensors on the projector that might obstruct the infra-red beam.

Installing or replacing the remote control battery

1. Pull out the battery holder.
2. Insert the new battery in the holder.
3. Push the holder into the remote control.



- **Avoid excessive heat and humidity. There may be danger of an explosion if the battery is incorrectly replaced.**
- **Replace only with the same or equivalent type recommended by the battery manufacturer.**
- **Dispose of the used battery according to the manufacturer's instructions.**
- **Never throw a battery into a fire.**
- **If the battery is dead or if you will not be using the remote control for a long time, remove the battery to prevent damage to the remote control from possible battery leakage.**

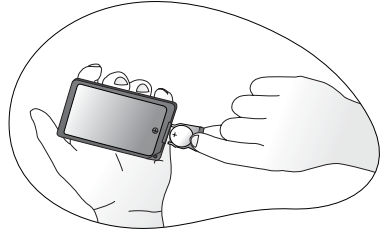

3 Positioning your projector

Choosing a location

Your projector is designed to be installed in one of four possible installation locations:

1. Floor in front of screen;
2. Ceiling in front of screen;
3. Floor at rear of screen;
4. Ceiling at rear of screen.

Your room layout or personal preference will dictate which installation location you select. Take into consideration the size and position of your screen, the location of a suitable power outlet, as well as the location and distance between the projector and the rest of your equipment.

I. Floor front

Select this location with the projector placed near the floor in front of the screen. This is the most common way to position the projector for quick setup and portability.

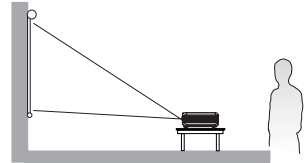

II. Ceiling front

Select this location with the projector suspended from the ceiling in front of the screen.

Purchase the BenQ Projector Ceiling Mounting Kit from your dealer to mount your projector on the ceiling.

Set in the **Advance > Mirror** menu after you turn the projector on.

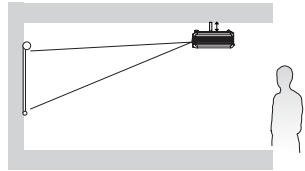

III. Floor rear

Select this location with the projector placed near the floor behind the screen.

Note that a special rear projection screen is required.

Set in the **Advance > Mirror** menu after you turn the projector on.

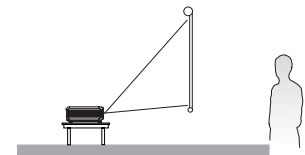

IV. Ceiling rear

Select this location with the projector suspended from the ceiling behind the screen.

Note that a special rear projection screen and the BenQ Projector Ceiling Mounting Kit are required for this installation location.

Set in the **Advance > Mirror** menu after you turn the projector on.

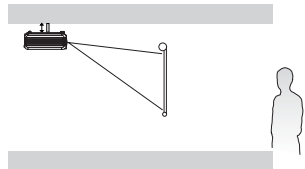

Obtaining a preferred projected image size

The distance from the projector lens to the screen, the zoom setting, and the video format each factors in the projected image size. BenQ has provided separate tables of dimensions for both 16:9 and 4:3 screen ratios to assist you in determining the ideal location for your projector.

1. Determine the aspect ratio of your screen (4:3 or 16:9).
2. Determine the projection distance allowed in your room. Install the projector at a proper distance from the screen.
3. Refer to the table of 4:3 or 16:9 Screen Size depending on your screen ratio. Locate the suitable value in the column of "Distance from Screen". In the same row, you will find the maximum and minimum projected image sizes.
4. Determine the preferred height of your projector.

For example, if you are using a 4:3 screen with 2.5 meters projection distance, the maximum image size is close to 1.91 meters diagonal.

If you place the projector above or below the screen, you have to tilt it down or up to center the image on the screen after turning the projector on. In these situations, some image distortion will occur. Use the Keystone function to correct the distortion. See page 20 for keystone correction.

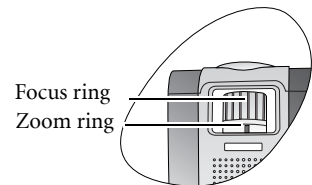
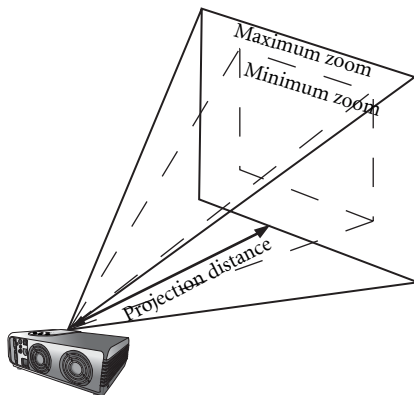

Screen size chart (4:3 aspect ratio)

Distance from screen		Diagonal measurement			
		Minimum zoom		Maximum zoom	
feet	inch	feet	inch	feet	inch
4	48	2.49	29.9	3.05	36.6
6	72	3.73	44.8	4.57	54.9
8	96	4.98	59.7	6.10	73.2
10	120	6.22	74.7	7.62	91.4
12	144	7.47	89.6	9.14	109.7
14	168	8.71	104.5	10.67	128.0
16	192	9.96	119.5	12.19	146.3
18	216	11.20	134.4	13.72	164.6
20	240	12.45	149.4	15.24	182.9
22	264	13.69	164.3	16.76	201.2
24	288	14.94	179.2	18.29	219.5
26	312	16.18	194.2	19.81	237.7
28	336	17.42	209.1	21.34	256.0
30	360	18.67	224.0	22.86	274.3
32	384	19.91	239.0	24.38	292.6
34	408	21.16	253.9	25.91	310.9

Distance from screen		Diagonal measurement			
		Minimum zoom		Maximum zoom	
meter	cm	meter	cm	meter	cm
1	100	0.62	62.2	0.76	76.2
1.5	150	0.93	93.3	1.14	114.3
2	200	1.24	124.5	1.52	152.4
2.5	250	1.56	155.6	1.91	190.5
3	300	1.87	186.7	2.29	228.6
3.5	350	2.18	217.8	2.67	266.7
4	400	2.49	248.9	3.05	304.8
4.5	450	2.80	280.0	3.43	342.9
5	500	3.11	311.2	3.81	381.0
5.5	550	3.42	342.3	4.19	419.1
6	600	3.73	373.4	4.57	457.2
6.5	650	4.04	404.5	4.95	495.3
7	700	4.36	435.6	5.33	533.4
7.5	750	4.67	466.7	5.72	571.5
8	800	4.98	497.8	6.10	609.6
8.5	850	5.40	539.8	6.48	647.7

Screen size chart (16:9 aspect ratio)

Distance from screen		Diagonal measurement			
		Minimum zoom		Maximum zoom	
feet	inch	feet	inch	feet	inch
4	48	2.29	27.5	2.80	33.6
6	72	3.44	41.3	4.20	50.4
8	96	4.59	55.1	5.60	67.2
10	120	5.74	68.8	7.00	84.0
12	144	6.88	82.6	8.40	100.8
14	168	8.03	96.4	9.80	117.6
16	192	9.18	110.1	11.20	134.4
18	216	10.32	123.9	12.60	151.2
20	240	11.47	137.7	14.00	167.9
22	264	12.62	151.4	15.39	184.7
24	288	13.77	165.2	16.79	201.5
26	312	14.91	179.0	18.19	218.3
28	336	16.06	192.7	19.59	235.1
30	360	17.21	206.5	20.99	251.9
32	384	18.35	220.3	22.39	268.7

Distance from screen		Diagonal measurement			
		Minimum zoom		Maximum zoom	
meter	cm	meter	cm	meter	cm
1	100	0.57	57.4	0.70	70.0
1.5	150	0.86	86.0	1.05	105.0
2	200	1.15	114.7	1.40	140.0
2.5	250	1.43	143.4	1.75	179.4
3	300	1.72	172.1	2.10	209.9
3.5	350	2.01	200.8	2.45	244.9
4	400	2.29	229.4	2.80	279.9
4.5	450	2.58	258.1	3.15	314.9
5	500	2.87	286.8	3.50	349.9
5.5	550	3.15	315.5	3.85	384.9
6	600	3.44	344.1	4.20	419.9
6.5	650	3.73	372.8	4.55	454.9
7	700	4.02	401.5	4.90	489.8
7.5	750	4.30	430.2	5.25	524.8
8	800	4.59	458.9	5.60	559.8

- The recommended focus range is from 1.5 ~ 8 meters (6 ~ 32 feet).
- There is 3% ~ 5% tolerance among these numbers due to optical component variations.

* 1 m = 3.28 feet, 1 foot = 0.305 m

4 Connection

When connecting a signal source to the projector, be sure to:

1. Turn all equipment off before making any connections.
2. Use the correct signal cables for each source.
3. Ensure the cables are firmly inserted.

 **In the connections shown below, some cables are not included with the projector (see page 6). They are commercially available from electronics stores.**

Connecting a computer

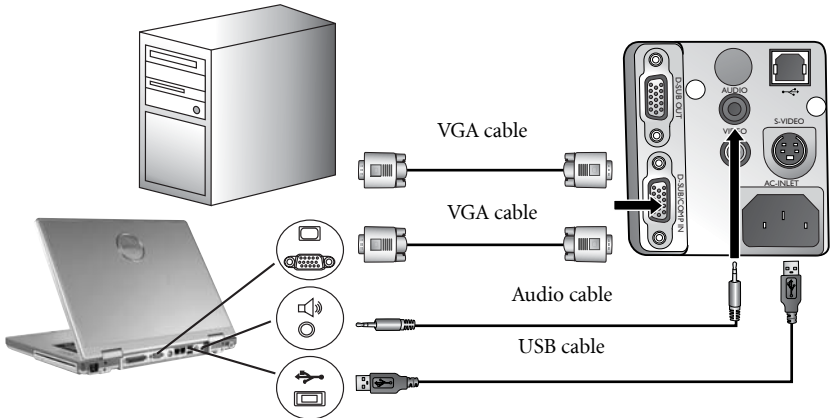

-  • **A Mac adapter (an optional accessory) is needed if you are connecting to Macintosh computers.**
- **Many laptops do not turn on their external video ports when connected to a projector. Usually a key combo like FN + F3 or CRT/LCD key turns the external display on/off. Locate a function key labeled CRT/LCD or a function key with a monitor symbol on the laptop. Press FN and the labeled function key simultaneously. Refer to your laptop's documentation to learn your laptop's key combination.**

Connecting Component Video devices

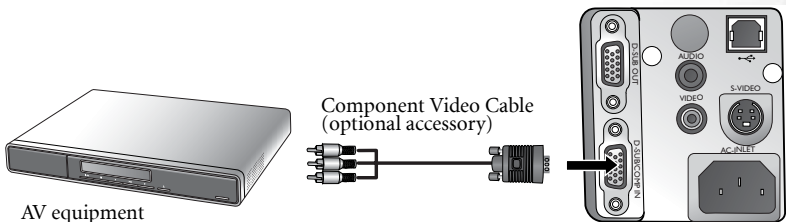

AV equipment

The projector is capable of accepting a Component Video signal. Use a Component Video-VGA (D-sub) cable (an optional accessory) to display these images.

The following standards are supported in the digital TV function:

- 480i
- 576i
- 720p (50/ 60 Hz)
- 480p
- 576p
- 1080i (50/ 60 Hz)

Connecting Video or S-Video devices

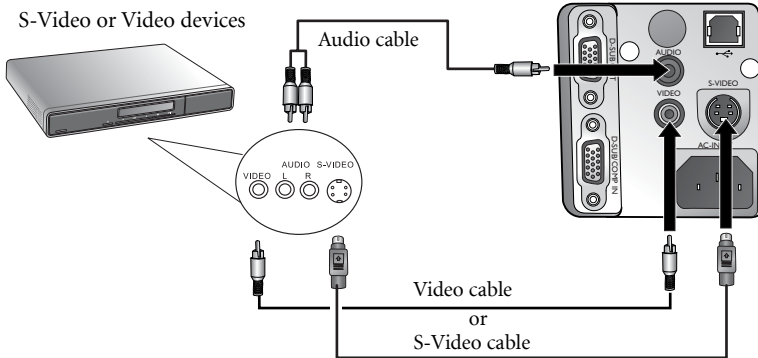

 If the selected video image is not displayed after the projector is turned on and the correct video source has been selected, check that the video source is turned on and operating correctly. Also check that the signal cables have been connected correctly.

Connecting display devices

If you want to monitor your presentation close-up on a monitor as well as on the screen, you can connect the RGB signal output port on the projector to an external monitor with a VGA cable.

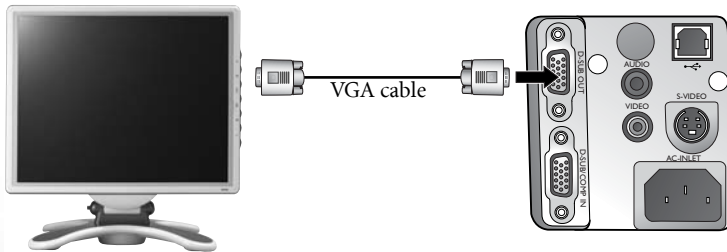

5 Operation

Start up

1. Switch all of the connected equipment on.
2. Plug the power cord into the projector and into a wall socket. Turn on the wall socket switch (where fitted). Check that the **Power indicator** on the projector lights orange after power has been applied.
3. Remove the lens cap. If it is left on, it could become deformed due to heat.
4. Press and hold (for 2 seconds) the **Power** button on the remote control or projector to start the unit. The **Power indicator light** flashes green and stays green when the unit is on.
5. The start up procedure takes about 30 seconds after pressing **Power**. In the later stage of start up, a default BenQ logo is projected.
6. If you are prompted for a password, press the arrow buttons to select the four password digits, then press **Auto**. For information about the password function, refer to page 17.
7. The projector will start to search for input signals. The projector screen displays the current input source being scanned at the bottom right corner of the screen. If no input source signal is detected, the search will continue until an input source signal is detected..
8. You can also press **Source** on the projector or remote control to select your desired input signal. For more information, please refer to page 21.

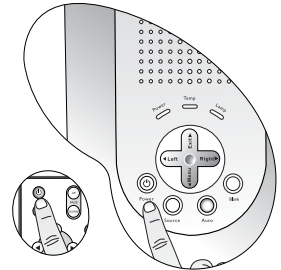
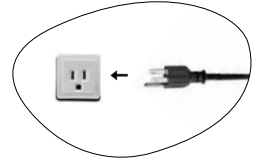

 **If the frequency/ resolution of the input signal exceeds the projector's operating range, you will see the message "Out of Range" displayed on a blank screen.**





Utilizing the password function

For security purposes and to help prevent unauthorized use, the projector includes an option for setting up password security. The password can be set through the on-screen menu. For details of the on-screen menu operation, please refer to page 24 for information.

 **WARNING: You will be inconvenienced if you activate the password functionality and subsequently forget the password. Write the password you used in this manual, and keep the manual in a safe place for later recall.**

To set a password:

 **CAUTION: Once a password has been set, the projector cannot be used unless the correct password is entered every time the projector is started.**

1. Open the on-screen menu and go to  **Setting > Password**. Select  by pressing  or .

2. When the function is activated for the first time, a prompt will display on the screen. Use the **▲** or **▼** button to select a number for each digit of the password. Use the **◀** or **▶** button to move between the digits of the password..
3. When all digits are entered and the password is ready, press **Auto** to confirm. A confirmation message displays.

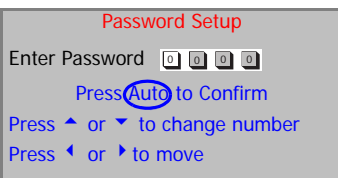

IMPORTANT: Write your selected password down here in this manual so that it is available to you should you ever forget it.

Password: _ _ _ _ _

Keep this manual in a safe place.

- i. Press **Auto** to continue. The set-up is finished when the message “Password setup completed” displays.
- ii. Press **▲** to go back to the previous screen and re-enter four digits.
- iii. Press **▼** to cancel the password set-up and return to the on-screen menu.

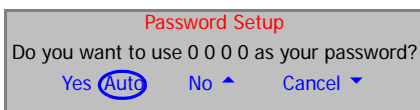

If you forget the password:

You will be asked to enter the four digit password every time you turn on the projector. If you enter the wrong password, the password error message displays. You can retry by turning off the projector (by pressing **Power**) and start again, or if you did not record the password in this manual, and you absolutely do not remember it, you can use the password recall procedure.

To enter the password recall procedure:

Press and hold **▶** for 5 seconds. The projector will display a coded number on the screen. Seek help from the local BenQ service center to decode the number. You may be required to provide proof of purchase documentation to verify that you are an authorized user of the projector.

To change the password:

1. Open the on-screen menu and go to  **Setting > Change Password.**
2. Press **◀** or **▶**. A “Change Password” message displays.
3. Enter the old password.
 - i. If the password is correct, you can go on to enter new password.

IMPORTANT: Write your selected password down here in this manual so that it is available to you should you ever forget it.

Password: _ _ _ _ _

Keep this manual in a safe place.

4. Check the new password.
 - i. Pressing **Auto** completes the procedure.
 - ii. Press **▲** to try again.
 - iii. Press **▼** to cancel the set-up and return to the on-screen menu.

Adjusting the image

Adjusting the height

The projector is equipped with 1 quick-release adjuster foot and 2 rear adjuster feet. These adjusters change the image height and projection angle. To adjust the projector:

1. Lift the projector up and press the adjuster button to release the adjuster. The adjuster will drop into position and be locked.

 **Do not look into the lens while the lamp is on. The strong light from the lamp may cause damage to your eyes.**

2. Screw the rear adjuster feet to fine tune the horizontal angle.

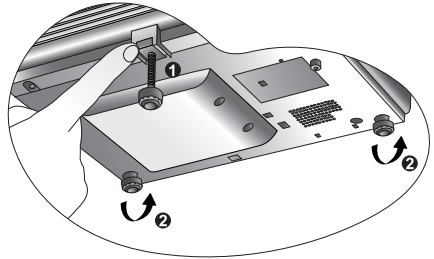

To retract the feet, hold up the projector while pressing the front adjuster button, then slowly lower the projector. Screw the rear adjuster feet in a reverse direction.

 **If the screen and the projector are not perpendicular to each other, the projected image becomes vertically trapezoidal. To correct this situation, adjust the value of Keystone in the Picture menu, on the projector control panel, or on the remote control.**

Auto-adjusting the image

In some cases, you may need to optimize the picture quality. To do this, press **Auto** on the control panel of the projector or on the remote control. Within 3 seconds, the built-in Intelligent Auto Adjustment function will re-adjust the values of Frequency and Clock to provide the best picture quality.

The current source information will be displayed at the bottom right of the screen for 3 seconds, as below.

 **The screen will be blank while Auto is functioning.**

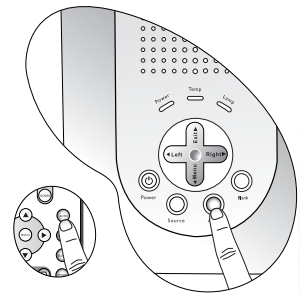

Fine-tuning the image size and clarity

1. Adjust the projected image to the size that you need using the zoom ring.
2. Then sharpen the image by rotating the focus ring.

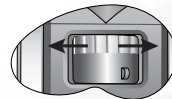
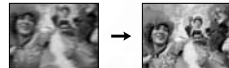
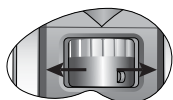





Refer to the screen size tables on page 14.

Correcting keystone

Keystoning refers to the situation where the projected image is noticeably wider at either the top or bottom. It occurs when the projector is not perpendicular to the screen.

To correct this, besides adjusting the height of the projector, you will need to manually correct it following ONE of these steps.

1. Press **Left/ Right** (hot key) on the control panel of the projector to display the status bar labelled Keystone. Press **Left** to correct keystoning at the top of the image. Press **Right** to correct keystoning at the bottom of the image.



2. Press  /  on the remote control to display the status bar labelled Keystone, then press  to correct keystoning at the top of the image or press  to correct keystoning at the bottom of the image.

3. Press **Menu** on the projector or **Menu** on the remote control. Go to  **Picture** --> **Keystone** and adjust the values by pressing **Left/ Right** on the projector or **Left/ Right** on the remote control.

For example,



Keystone  0



1. Press **Left** on the projector or
2. Press  on the remote control or
3. Press **Left** on the projector or  on the remote control when you are in Picture --> Keystone menu.



Keystone  -6



Keystone  0

1. Press **Right** on the projector or
2. Press  on the remote control or
3. Press **Right** on the projector or  on the remote control when you are in Picture -> Keystone menu.



Keystone  +6

Selecting a picture mode

The projector is preset with several picture modes so that you can choose one to suit your program type. To select a operation mode that suits your need, press **Mode**. The picture modes available for different types of signals are shown below.

PC Signal Input			
Presentation (default)	sRGB/Photo	Gaming	Video
YPbPr / S-Video / Video Signal Input			
Photo (default)	Movie	Cinema	Gaming

Refer to page 25 for more information.

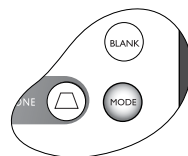
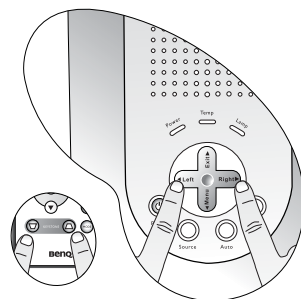

Switching input signal

The projector can be connected to multiple devices at the same time. To sequentially select input sources, press the **Source** button on the projector control panel or the remote control. The selected source will be displayed at the bottom right of the screen for 3 seconds.

For a quick search, you can also press the button repeatedly until your desired signal is displayed.

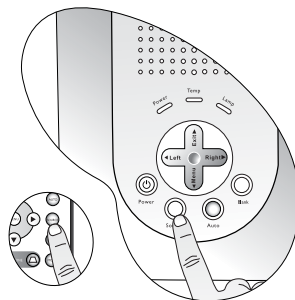

Hiding the image

In order to draw the audience's full attention to the presenter, you can use **Blank** to hide the screen image. Press **Blank** again to restore the image. A word "**BLANK**" appear at the bottom right corner of the screen when the image is hidden. When this function is activated with video/ S-video signal connected, the background sound still can be heard.

You can set the blank time in the  **Advance** -> **Blank Time** menu to let the projector shut down automatically after a period of time when there is no action taken on the blank screen.

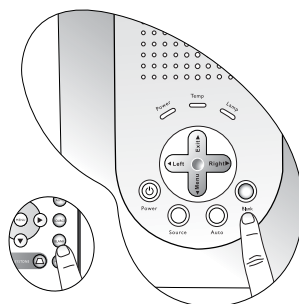

 **Do not block the projection lens from projecting as this could cause the blocking object to become heated and deformed or even cause a fire.**

Slide operation

You can operate your Power Point presentation moving forwards and backwards by pressing Page Up and Page Down.

 **Connect the projector to your PC or notebook with a USB cable prior to using this function.**

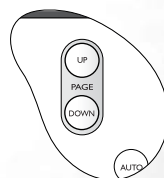

Freezing the image

The image is frozen when **Freeze** is pressed. An icon  will display in the lower right corner of the screen. To release the function, press **Freeze**, **Source** (this will change the input source and release the pause function).

Even if an image is frozen on the screen, the pictures are running on the video or other device. If the connected devices have active audio output, you will still hear the audio even though the image is frozen.

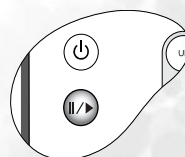

Shutdown

1. Press **Power** and a warning message appears. Press **Power** a second time to turn the projector off.
2. The **Power indicator light** flashes orange and the lamp shuts down, the fans continue to run for approximately 110 seconds to cool down the projector.

 **To protect the lamp, the projector will not respond to any commands during the cooling process.**

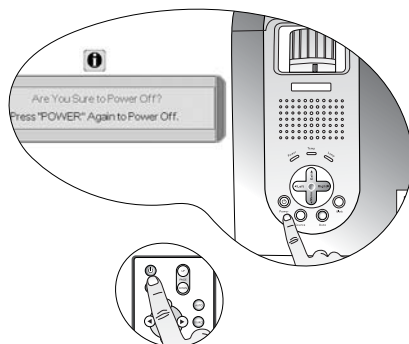

3. Disconnect the power cord from the wall socket.

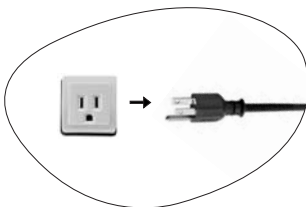





 **Do not unplug the power cord before the projector shutdown sequence is complete or during the 110-second cooling down process.**
If the projector is not properly shut down, to protect the lamp, when you attempt to re-start the projector within hours, the fans will run for a few minutes to cool down. Press Power again to start the projector after the fans stop.

Menu operation

Menu system

Please note that the OSD menus vary according to the signal type selected.

Functions available when receiving different signal types...			
Sub-Menu	PC	Video / S-Video	Component Video
 Picture	Application Mode Color Temp Keystone Brightness Contrast	Application Mode Color Temp Keystone Brightness Contrast Color Tint*	
 Pro-Picture	Auto Resize Aspect Ratio H Position V Position Phase H. Size	Auto Resize Aspect Ratio Sharpness	
 Setting	Mute Volume OSD Time Reset Password Change Password		
 Advance	Mirror Blank Time Source Scan Language Splash Screen High Altitude Mode Economic Mode		
 Information	Source Resolution Application Mode Lamp Hour	Source System Application Mode Lamp Hour	Source Resolution Application Mode Lamp Hour

*When a Video or S-Video signal is connected, the function is only available with NTSC system selected.

Using the menus

The projector is equipped with on-screen display (OSD) menus for making various adjustments and settings.

There are 10 different menu languages. (Refer to page 29 for more details.)

The following example describes the adjustment of the keystone.

1. Press **▼ Menu** on the projector or **Menu** on the remote control to turn the on-screen menu on.
4. Adjust keystone values by pressing **◀ Left / Right ▶** on the projector or **◀ / ▶** on the remote control.

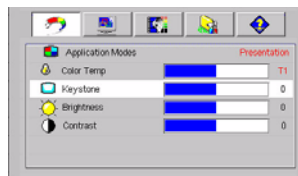
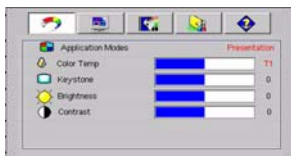

2. Use **◀ Left/ Right ▶** on the projector or **◀ / ▶** on the remote control to select the  **Picture** menu.
3. Press **▲ Exit** or **▼ Menu** on the projector or **▼ / ▲** on the remote control to select **Keystone**.
5. Press **▲ Exit** on the projector or press **Menu** twice* on the remote control to leave and save the setting.



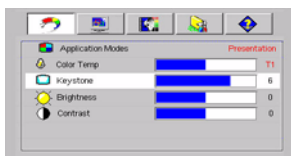



*The first press leads you back to the submenu and the second press closes the on-screen menu.



1. Picture menu



 Some picture adjustments are available only when certain input ports are in use. Unavailable adjustments are not shown on the screen.

FUNCTION	DESCRIPTION
Application Mode	<p>Application modes are provided so you can optimize your projector image set-up to suit your program type.</p> <p>PC Signal Input</p> <ol style="list-style-type: none"> 1. Presentation Mode: Is designed for presentations. The brightness is emphasized in this mode. 2. sRGB/Photo Mode: Maximizes the purity of RGB colors to provide true-to-life images. It is suitable for photo viewing. 3. Gaming Mode: Is suitable for playing video games in a bright living room. 4. Video Mode: Is appropriate for playing movies, video clips from digital cameras or DVs in an extensive space. <p>YPbPr/ S-Video/ Video Signal Input</p> <ol style="list-style-type: none"> 1. Photo Mode: Is perfect for viewing photos. The color saturation and brightness are well-balanced. 2. Movie Mode: Is suitable for enjoying colorful movies in a home theater. 3. Cinema Mode: Is suitable for enjoying darker movies in a home theater. 4. Gaming Mode: Is suitable for playing video games in a bright living room.
Color Temp	<p>4 color temperature* settings are available.</p> <ol style="list-style-type: none"> 1. T1: With the highest color temperature, T1 makes the image appear the most bluish white than other settings. 2. T2: Makes images appear bluish white. 3. T3: Maintains normal colorings for white. 4. T4: Makes images appear reddish white. <p>*About color temperatures:</p> <p>There are many different shades that are considered to be “white” for various purposes. One of the common methods of representing white color is known as the “color temperature”. A white color with a low color temperature appears to be reddish white. A white color with a high color temperature appears to have more blue in it.</p>
Keystone	<p>Corrects any keystone of the image. Refer to page 20 for more information.</p>



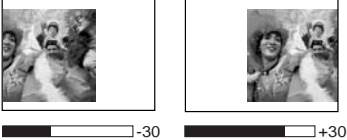
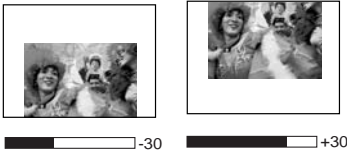

<p>Brightness</p>	<p>Adjusts the brightness of the image. The higher the value, the brighter the image. And lower the setting, darker the image. Adjust this control so the black areas of the image appear just as black and that detail in the dark areas is visible.</p> <div style="display: flex; justify-content: space-around; align-items: center;"> <div style="text-align: center;">  <p>-30</p> </div> <div style="text-align: center;">  <p>50</p> </div> <div style="text-align: center;">  <p>+70</p> </div> </div>
<p>Contrast</p>	<p>Adjusts the degree of difference between dark and light in the image. The higher the value, the greater the contrast.</p> <div style="display: flex; justify-content: space-around; align-items: center;"> <div style="text-align: center;">  <p>-30</p> </div> <div style="text-align: center;">  <p>50</p> </div> <div style="text-align: center;">  <p>+70</p> </div> </div>
<p>Color</p>	<p>Increases or decreases the color intensity of the image.</p>
<p>Tint</p>	<p>Adjusts the color tones of the image. The higher the value, the more reddish the image becomes. The lower the value, the more greenish the image becomes.</p> <p>*When a Video or S-Video signal is connected, the function is only available with NTSC system selected.</p>

2. Pro-Picture menu

 Some picture adjustments are available only when certain input ports are in use. Unavailable adjustments are not shown on the screen.

FUNCTION	DESCRIPTION
Auto Resize	Makes the best fit of the image to the screen. 1. On 2. Off
Aspect Ratio	There are two aspect ratio settings. 1. 4 : 3 (for a standard screen) 2. 16 : 9 (for a wide screen)
H Position	Adjusts the horizontal position of the projected image. 
V Position	Adjusts the vertical position of the projected image. 
Phase	This function allows you to adjust the clock phase to reduce image distortion. 
H Size	Adjusts the horizontal width of the image.
Sharpness	Adjusts the image to make it look sharper or softer.

3. Setting menu

FUNCTION	DESCRIPTION
Mute	<div style="display: flex; justify-content: space-around; align-items: center;"> <div style="text-align: center;"> <p>Off</p>  </div> <div style="text-align: center;"> <p>On</p>  </div> </div>
Volume	<p>Adjusts the volume level.</p> 
OSD Time	<p>Sets the length of time the OSD will remain active after your last button press. The range is from 5 to 100 seconds.</p>
Reset	<p>Returns all settings to the factory preset values.</p>
Password	<p>This is a selectable function. Selecting  limits use of the projector to only those who know the correct password. When the function is activated for the first time, you have to set a password for it. For more information, refer to page 17. Once the password is set and this function is selected, the projector is password-protected. Users who do not know the correct password can not use the projector.</p> <p> WARNING: You will be inconvenienced if you activate the password functionality and subsequently forget the password. Write the password you used in this manual, and keep the manual in a safe place for later recall.</p> <p>The password can be entered by using either the buttons on the projector or the remote control.</p>
Change Password	<p>You will be asked to enter the current password before changing to a new one. For more information, refer to page 17.</p>

4. Advance menu

FUNCTION	DESCRIPTION
Mirror	The projector can be installed on a ceiling or behind a screen, or with one or more mirrors. Contact your dealer for the ceiling mount bracket (optional accessory) if you need to install the projector on your ceiling. Refer to page 12 for more information.
Blank Time	Sets the image blank time when the Blank feature is activated, once elapsed the image will return to the screen.
Source Scan	Sets whether the projector searches automatically for input signals. If the source scan is on (✓), the projector will scan for input signals until it acquires a signal. If the function is not activated, the projector selects the last used input signal.
Language	Language sets the language for the OSD control menus. Use ◀ Left/ Right ▶ on the projector or ◀ / ▶ on the remote control to select your desired language from among English, French, German, Italian, Spanish, Russian, Traditional Chinese, Simplified Chinese, Japanese and Korean.
User Logo	Enables the user to select which logo screen will appear during projector start-up. Three modes are available: Default (BenQ logo), black screen or blue screen.
High Altitude Mode	<p>A mode for extreme environments like high altitude and high temperature. We recommend you use the High Altitude Mode when your environment is higher than 3000 feet above sea level, and is hotter than 40°C.</p> <p>To activate the High Altitude Mode, select ✓ by pressing ◀ or ▶ on the projector or remote control. A confirmation message displays. Press Auto.</p> <div data-bbox="352 890 1016 1026" style="border: 1px solid gray; padding: 5px; margin: 5px 0;"> <p style="text-align: center; color: red;">We recommend you use the High Altitude Mode by selecting ✓ when your environment is higher than 3000 feet, and is hotter than 40°C.</p> <p style="text-align: center; color: blue;">Do you want to turn on High Altitude Mode?</p> <p style="text-align: center;">Yes Auto No ▲</p> </div> <p>Next time you turn on the projector, it will show a message pictured below as a reminder during the start-up.</p> <div data-bbox="352 1091 1016 1212" style="border: 1px solid gray; padding: 5px; margin: 5px 0;"> <p style="text-align: center; color: red;">Current Status</p> <p style="text-align: center; color: blue;">High Altitude Mode On</p> <p style="text-align: center; color: blue;">This mode is used for protecting projector from extreme environment and may cause high fan speed.</p> </div> <p>Operation under "High Altitude Mode" may cause a higher decibel operating noise level because of increased fan speed necessary to improve overall system cooling and performance.</p> <p>If you use this projector under other extreme environments excluding the above, it may display auto shut-down symptoms, which is designed to protect your projector from over-heating. In cases like this, you should switch to High Altitude mode to solve these symptoms. However, this is not to state that this projector can operate under any and all harsh or extreme environments.</p>

Economic Mode	Use this mode to reduce system noise and reduce power consumption by 20%. The lamp life is also extended with lower light output.
----------------------	---

5. Information menu

This menu shows you the current operating status of the projector.

 **Some picture adjustments are available only when certain input ports are in use. Unavailable adjustments are not shown on the screen.**

FUNCTION	DESCRIPTION
Source	Shows the current signal source.
Resolution	Shows the native resolution of the input signal.
Application Mode	Shows the selected mode in the  Picture menu.
Lamp Hour	Displays the number of hours the lamp has been used.
System	Shows the Video input system format, NTSC, SECAM or PAL.

6 Maintenance

Care of the projector

Your projector needs little maintenance. The only thing you need to do on a regular basis is to keep the lens clean.

Never remove any parts of the projector except the lamp. Contact your dealer if other parts need replacing.

Cleaning the lens

Clean the lens whenever you notice dirt or dust on the surface.

- Use a canister of compressed air to remove dust.
- If there is dirt or smears, use lens-cleaning paper or moisten a soft cloth with lens cleaner to gently wipe the lens surface.

 **Never rub the lens with abrasive materials.**

Cleaning the projector case

Before you clean the case, turn the projector off and unplug the power cord.

- To remove dirt or dust, wipe the case with a soft, dry, lint-free cloth.
- To remove stubborn dirt or stains, moisten a soft cloth with water and a neutral detergent. Then wipe the case.

 **Never use wax, alcohol, benzene, thinner or other chemical detergents. These can damage the case.**

Storing the projector

If you need to store the projector for an extended time, please follow the instructions below.

- Make sure the temperature and humidity of the storage area are within the recommended range for the projector. Please refer to the Spec. page in the manual or consult your dealer about the range.
- Retract the adjuster feet.
- Remove the batteries from the remote control.
- Pack the projector in its original packing or equivalent.

Transporting the projector

It is recommended that you ship the projector with its original packing or equivalent. When you carry the projector yourself, please use the provided soft carry case.

Lamp information

Warning message

When the **Lamp indicator** lights up red or a message appears suggesting it is time to replace the lamp, please install a new lamp or consult your dealer. An old lamp may cause a malfunction in the projector and in some instances the lamp may break.

For more detailed information on lamp warnings, please refer to page 34.

 **The Lamp indicator light and Temperature warning light will light up if the lamp becomes too hot. Turn the power off and let the projector cool for 45 minutes. If the Lamp or Temp indicator still lights up after turning the power back on, please contact your dealer.**

The following Lamp warning displays will remind you to change the lamp.

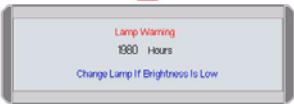
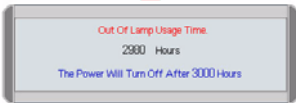
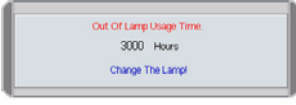
Message	Status
	The lamp has been in operation for 1980 hours. Install a new lamp for optimal performance. If the projector is normally run with Preset "Economic Mode" selected (page 25), you may continue to operate the projector until the 2980 hour lamp warning appears.
	The lamp has been in operation for 2980 hours, the power will shutdown in 20 hours time. A new lamp should be fitted to avoid the inconvenience when the projector runs out of lamp time.
	The lamp has been in operation for over 3000 hours. This message will flash in the center of the screen together with the Lamp indicator lighting up red for 40 seconds. The projector will shutdown after 40 seconds. The lamp MUST be replaced before the projector will operate normally.

Replacing the lamp

-  • **To reduce the risk of electrical shock, always turn the projector off and disconnect the power cord before changing the lamp.**
- **To reduce the risk of severe burns, allow the projector to cool for at least 45 minutes before replacing the lamp.**
- **To reduce the risk of injuries to fingers and damage to internal components, use caution when removing lamp glass that has shattered into sharp pieces.**
- **To reduce the risk of injuries to fingers and/or compromising image quality by touching the lens, do not touch the empty lamp compartment when the lamp is removed.**
- **This lamp contains mercury. Consult your local hazardous waste regulations to dispose of this lamp in a proper manner.**

Step 1. Turn the power off and disconnect the projector from the wall socket.

Step 2. Turn the projector over. Then loosen the screws and remove the lamp cover. If the lamp is hot, avoid burns by waiting for 45 minutes until the lamp has cooled.

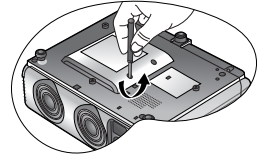

Step 3. Slide the latch to release the lamp as shown in the picture.

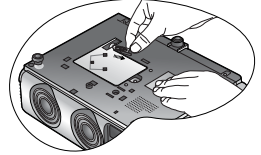

Step 4. Loosen the screw that holds the lamp to the projector. If the screw is not loosened completely, they could injure your fingers. It is strongly recommended that you use a magnetic-head screwdriver.

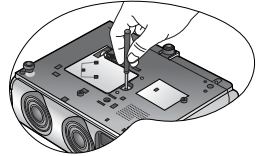

Step 5. Lift the handle so that it stands up. Use the handle to slowly pull the lamp out of the projector.

☞ • **Pulling it too quickly may cause the lamp to break and scatter broken glass in the projector.**

• **Do not place the lamp in locations where water might splash on it, children can reach it, or near flammable materials.**

• **Do not insert your hands into the projector after the lamp is removed. If you touch the optical components inside, it could cause color unevenness and distortion of the projected images.**

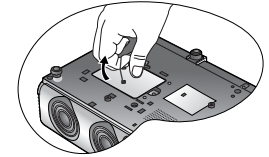

Step 6. Insert a new lamp. Make sure the handle is fully locked, move the latch back, and tighten the screw firmly.

☞ • **Loose screw may cause a bad connection, which could result in malfunction.**

• **Do not over tighten the screw.**

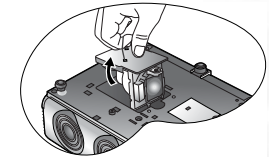

Step 7. Re-install the lamp cover and tighten the screw. **Do not turn the power on with the lamp cover removed.**

Step 8. Restart the projector.

☞ **Do not turn the power on with the lamp cover removed.**

Step 9. Resetting the lamp counter

 **Do not reset if the lamp is not replaced as this could cause damage.**

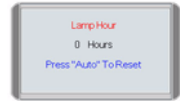

- i. Press and hold the Exit  button on the projector for 5 seconds to display the total used lamp time.
- ii. Press **Auto** on the projector or on the remote control to reset the lamp hour to “0”.
- iii. Wait about 5 seconds to let the OSD disappear.

Temperature information

When the Temperature warning light is on, it is warning you of the following possible problems:

1. The internal temperature is too high.
2. The fans are not working.

Turn the projector off and contact qualified service personnel for further help.

For more detailed information, please refer to "Indicators" on page 34.

Indicators

Illustration

1. Blank - : Light OFF





2.  : Light flashing











3.  : Light ON

4. **O** : Orange light

5. **R** : Red light

6. **G** : Green light

Light			Status & Description
Power	Temp	Lamp	
Power events			
	-	-	(1) The projector needs 110 seconds to cool down as it was abnormally shut down without the normal cooling down process. Or (2) The projector needs to cool for 110 seconds after the power is turned off.
	-	-	Stand-by mode.
	-	-	The Power indicator light is flashing during powering up.
	-	-	The projector is under normal operation.

Light			Status & Description
Power	Temp	Lamp	
Lamp events			
-	-		(1) The projector needs 110 seconds to cool down. Or (2) Please contact your dealer for assistance.
Thermal events			
-		-	The projector has shutdown automatically. If you try to re-start the projector, it will shutdown again. Please contact your dealer for assistance.
-			The projector has shutdown automatically. If you try to re-start the projector, it will shutdown again. Please contact your dealer for assistance.
-			The projector has shutdown automatically. If you try to re-start the projector, it will shutdown again. Please contact your dealer for assistance.
		-	The projector has shutdown automatically. If you try to re-start the projector, it will shutdown again. Please contact your dealer for assistance.
		-	The projector has shutdown automatically. If you try to re-start the projector, it will shutdown again. Please contact your dealer for assistance.

Service information

Accessories (included in the standard package)

Description	Part Number
Power cord (US)	27.01818.000
Power cord (EU)	27.82718.281
Power cord (UK)	27.01018.000
VGA cable	50.J0508.503
Video cable	50.J1303.501
S-Video cable	50.72920.011
RCA R/W audio cable	50.J1311.001
PC - PC audio cable	50.L4302.501
Soft carry case	47.J9610.001
USB mouse cable	50.73213.501
Remote control	56.26J98.011
3-2 power converter	22.91008.001

Optional accessories (not included in the standard package)

Description of parts	Partnumber
Mac adapter (switchable)	20.20118.A15
250W lamp module	59.J9901.CG1
Ceiling mount kit	60.J7683.001
Wireless Pro (EU)	59.J8201.001
Wireless Pro (US)	59.J8201.002
Presentation Plus	65.J9306.001
Component Video cable	50.J2401.001
RS 232 connector	50.J0Y01.501

Ordering parts or getting information

For product information, product assistance, service information, or to order accessories, please visit the BenQ Corporation website at <http://www.BenQ.com>.

7 Troubleshooting

② THE PROJECTOR DOES NOT TURN ON.

Cause	Remedy
There is no power from the power cable.	Plug the power cord into the AC inlet on the projector, and plug the power cord into the power outlet. If the power outlet has a switch, make sure that it is switched on.
Attempting to turn the projector on again during the cooling process.	Wait until the cooling down process has completed.

② NO PICTURE

Cause	Remedy
The video source is not turned on or connected correctly.	Turn the video source on and check that the signal cable is connected correctly.
The projector is not correctly connected to the input source device.	Check the connection.
The input signal has not been correctly selected.	Select the correct input signal with the Source key on the projector or remote control.
The lens cap is still attached to the lens.	Remove the lens cap.

② BLURRED IMAGE

Cause	Remedy
The projection lens is not correctly focused.	Adjust the focus of the lens using the focus ring.
The projector and the screen are not aligned properly.	Adjust the projection angle and direction as well as the height of the unit if necessary.
The lens cap is still attached to the lens	Remove the lens cap.

② REMOTE CONTROL DOES NOT WORK

Cause	Remedy
The battery is out of power.	Replace the battery with a new one.
There is an obstacle between the remote control and the projector.	Remove the obstacle.
You are too far away from the projector.	Stand within 6 meters (19.5 feet) of the projector.

8 Specifications

Projector specifications

 All specifications are subject to change without notice.

General

Product name	Digital Projector
Model name	PB6240 1024 x 768 XGA

Optical

Display system	1-CHIP DMD
Lens F/Number	PB6240 F=2.4 to 2.6, f= 24.0 to 29.1 mm
Lamp	250W lamp

Electrical

Power supply	AC100 ~ 240V, 3.2A, 50/60 Hz (Automatic)
Power consumption	350W (Max)

Mechanical

Dimensions	262 mm (W) x 91.2 mm (H) x 215.5 mm (D)
Weight	6.38 lbs (2.9 Kg)

Input terminal

Computer input	
RGB input	D-sub 15-pin (female)
Video signal input	
S-VIDEO	Mini DIN 4-pin port x 1
VIDEO	RCA jack x1
HDTV signal input	D-sub <--> YPbPr RCA jack x3, through RGB input
Audio signal input	
Audio in	Mini jack stereo port

Output

RGB output	D-sub 15-pin (female)
USB mouse connector	A/B series x 1
Speaker	1 watt x 1

Environmental Requirements

Operating temperature	0°C ~ 40°C at sea level
Operating relative humidity	10% ~ 90% (without condensation)
Operating altitude	6000 feet at 30°C
	6000 ~ 10000 feet at 23°C

Timing chart

Supported timing for PC input

Resolution	Horizontal Frequency (kHz)	Vertical Frequency (Hz)	Pixel Frequency (MHz)	Mode
640 x 400	31.47	70.089	25.176	640 x 400_70
640 x 480	31.469	59.940	25.175	VGA_60
	37.861	72.809	31.500	VGA_72
	37.500	75.000	31.500	VGA_75
	43.269	85.008	36.000	VGA_85
800 x 600	37.879	60.317	40.000	SVGA_60
	48.077	72.188	50.000	SVGA_72
	46.875	75.000	49.500	SVGA_75
	53.674	85.061	56.250	SVGA_85
1024 x 768	48.363	60.004	65.000	XGA_60
	56.476	70.069	75.000	XGA_70
	60.023	75.029	78.750	XGA_75
	68.667	84.997	94.500	XGA_85
1280 x 1024	63.981	60.020	108.000	SXGA_60

Supported timing for Component-YPbPr input

Signal Format	Horizontal Frequency (kHz)	Vertical Frequency (Hz)
480i(525i)@60Hz	15.73	59.94
480p(525p)@60Hz	31.47	59.94
576i(625i)@50Hz	15.63	50.00
576p(625p)@50Hz	31.25	50.00
720p(750p)@60Hz	45.00	60.00
720p(750p)@50Hz	37.50	50.00
1080i(1125i)@60Hz	33.75	60.00
1080i(1125i)@50Hz	28.13	50.00

Supported timing for Video and S-Video inputs

Video mode	Horizontal Frequency (kHz)	Vertical Frequency (Hz)	Color sub-carrier Frequency (MHz)
NTSC	15.73	60	3.58
PAL	15.63	50	4.43
SECAM	15.63	50	4.25 or 4.41
PAL-M	15.73	60	3.58
PAL-N	15.63	50	3.58
PAL-60	15.73	60	4.43
NTSC4.43	15.73	60	4.43

Dimensions

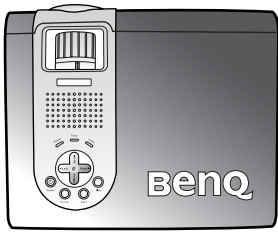

215

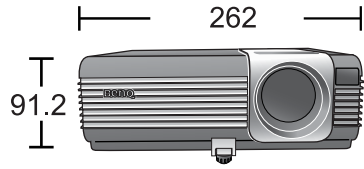

Unit: mm

Warranty

Limited Warranty

BenQ warrants this product against any defects in material and workmanship, under normal usage and storage.

Proof of purchase date will be required with any warranty claim. In the event this product is found to be defective within the warranty period, BenQ's only obligation and your exclusive remedy shall be replacement of any defective parts (labor included). To obtain warranty service, immediately notify the dealer from which you purchased the product of any defects.

Important: The above warranty shall be void if the customer fails to operate the product in accordance with BenQ's written instructions, especially the ambient humidity must be in-between 10% and 90%, temperature in-between 0°C and 40°C, altitude lower than 10000 feet, and avoiding to operate the projector in a dusty environment. This warranty gives you specific legal rights, and you may have other rights which vary from country to country.

For other information, please refer to BenQ Warranty Information Book.

10 Regulation Statements

FCC statement

CLASS B: This equipment generates, uses and can radiate radio frequency energy and, if not installed and used in accordance with the instructions, may cause harmful interference to radio communications. However, there is no guarantee that interference will not occur in a particular installation. If this equipment does cause harmful interference to radio or television reception, which can be determined by turning the equipment off and on, the user is encouraged to try to correct the interference by one or more of the following measures:

- Reorient or relocate the receiving antenna.
- Increase the distance between the equipment and receiver.
- Connect the equipment into an outlet on a circuit different from that to which the receiver is connected.
- Consult the dealer or an experienced radio/TV technician for help.

EEC statement

This machine was tested against the 89/336/EEC (European Economic Community) for EMC (Electronic Magnetic Compatibility) and fulfills these requirements.

MIC statement

B class equipment (Household purpose info/telecommunications equipment)

As this equipment has undergone EMC registration for household purpose, this product can be used in any area including residential area.