

LPTM1200

USER'S
GUIDE

InFocus[®]



ENGLISH

FRANÇAIS

DEUTSCH

ITALIANO

ESPAÑOL

APPENDIX

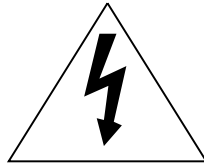
**CAUTION**

RISK OF ELECTRIC SHOCK
DO NOT OPEN



CAUTION: TO REDUCE THE RISK OF ELECTRIC SHOCK,
DO NOT REMOVE COVER (OR BACK)
NO USER-SERVICEABLE PARTS INSIDE
REFER SERVICING TO QUALIFIED
SERVICE PERSONNEL.

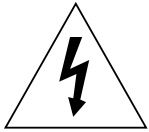

The lightning flash with arrowhead symbol, within an equilateral triangle, is intended to alert the user to the presence of uninsulated “dangerous voltage” within the product’s enclosure that may be of sufficient magnitude to constitute a risk of electric shock.



The exclamation point within an equilateral triangle is intended to alert the user to the presence of important operating and maintenance (servicing) instructions in the literature accompanying the appliance.

WARNING:

TO PREVENT FIRE OR SHOCK HAZARD, DO NOT EXPOSE THIS APPLIANCE TO RAIN OR MOISTURE.

CAUTION:

TO PREVENT ELECTRIC SHOCK DO NOT USE THIS (POLARIZED) PLUG WITH AN EXTENSION CORD, RECEPTACLE OR OTHER OUTLET UNLESS THE BLADES CAN BE FULLY INSERTED TO PREVENT BLADE EXPOSURE.

NOTE:

SINCE THIS PROJECTOR IS PLUGGABLE EQUIPMENT, THE SOCKET-OUTLET SHALL BE INSTALLED NEAR THE EQUIPMENT AND SHALL BE EASILY ACCESSIBLE.

WARNING

Use the attached specified shielded power supply cord. If you use another power-supply cord, it may cause interference with radio and television reception.

Use the attached VGA cable, RS-232C cable with this equipment so as to keep interference within the limit of a Class A device.

This apparatus must be grounded.

The projector automatically shuts off when the lamp is used up in about 1,300 hours and cannot be used until lamp replacement.

DO NOT LOOK DIRECTLY INTO THE LENS WHEN PROJECTOR IS IN THE POWER ON MODE.

**When using the projector in Europe
COMPLIANCE NOTICE**

This LCD - Video Projector complies with the requirements of the EC Directive 89/336/EEC “EMC Directive” and 73/23/EEC “Low Voltage Directive” as amended by Directive 93/68/EEC.

The electro-magnetic susceptibility has been chosen at a level that gains proper operation in residential areas, on business and light industrial premises and on small-scale enterprises, inside as well as outside by their connection to the public low voltage power supply system.

WARNING

Use the attached RGB cable or RS-232C cable with this equipment so as to keep interference within the limits of a EN55022 Class A. Please follow WARNINGS instructions.

This is a Class A product. In a domestic environment this product may cause radio interference in which case the user may be required to take adequate measures.

Important safeguards	4
Overview of the projector	6
Overview of the remote control	8
Battery installation	9
Preparing the projector for operation	10
Basic connections	12
Projector + AV equipment	12
Cables and adapters	12
Projector + IBM PC or IBM PC compatibles	13
Projector + Macintosh	14
Projector + NEC PC-98 series	15
To operate projector power ON	16
Menu operation	18
Picture adjustment	22
Advanced feature for presentation	25
Cursor operation	25
Still	25
Super impose	26
Expand	26
PC-CARD	27
Advanced feature with PC	29
PCV	29
PCGC	35
SpacePointer	37
Replacing the lamp	40
Maintenance	42
Troubleshooting	43
Indicators	44
Specifications	45
Replacement parts list	45

Trademark, Registered trademark

Apple, Macintosh are registered trademarks of Apple Computer Inc.

IBM, VGA, PS/2, OS/2 are trademarks or registered trademarks of International Business Machines Corporation.

Microsoft®, Windows®, Windows® 95, Windows NT® are registered trademarks of Microsoft in the U.S. and other countries.

SpacePointer® is a registered trademark of ALPS ELECTRIC CO., LTD.

Other brand or product names are trademarks or registered trademarks of their respective holders.

Important safeguards

PLEASE READ ALL THESE INSTRUCTIONS REGARDING YOUR LCD PROJECTOR AND RETAIN THEM FOR FUTURE REFERENCE. FOLLOW ALL WARNINGS AND INSTRUCTIONS MARKED ON THE LCD PROJECTOR.

1. **Read instructions**
All the safety and operating instructions should be read before the appliance is operated.
2. **Retain instructions**
The safety and operating instructions should be retained for future reference.
3. **Warnings**
All warnings on the appliance and in the operating instructions should be adhered to.
4. **Instructions**
All operating instructions must be followed.
5. **Cleaning**
Unplug this projector from the wall outlet before cleaning it. Do not use liquid aerosol cleaners. Use a damp cloth for cleaning.
6. **Attachments and equipment**
Never add any attachments and/or equipment without the approval of the manufacturer as such additions may result in the risk of fire, electric shock or other personal injury.
7. **Water and moisture**
Do not use this projector near water or in contact with water.
8. **Accessories**
Do not place this projector on an unstable cart, stand, tripod, bracket or table. Use only with a cart, stand, tripod bracket, or table recommended by the manufacturer or sold with the projector. Any mounting of the appliance should follow the manufacturer's instructions and should use a mounting accessory recommended by the manufacturer.

An appliance and cart combination should be moved with care. Quick stops, excessive force and uneven surfaces may cause the appliance and cart combination to overturn.



9. **Ventilation**
Slots and openings in the cabinet are provided for ventilation, ensuring reliable operation of the projector and to protect it from overheating. Do not block these openings or allow them to be blocked by placing the projector on a bed, sofa, rug, or bookcase. Ensure that there is adequate ventilation and that the manufacturer's instructions have been adhered to.

10. **Power sources**
This projector should be operated only from the type of power source indicated on the marking label. If you are not sure of the type of power supplied to your office, consult your appliance dealer or local power company.
11. **Power-cord protection**
Power-supply cords should be routed so that they are not likely to be walked on or pinched by items placed upon or against them. Pay particular attention to cords at plugs, convenience receptacles, and points where they exit from the appliance.
12. **Overloading**
Do not overload wall outlets and extension cords as this can result in a fire or electric shock.
13. **Object and liquid entry**
Never push objects of any kind through openings of this projector as they may touch dangerous voltage points or short-out parts that could result in a fire or electric shock. Never spill liquid of any kind on the projector.
14. **Servicing**
Do not attempt to service this projector yourself as opening or removing covers may expose you to dangerous voltage or other hazards. Refer all servicing to qualified service personnel.
15. **Damage requiring service**
Unplug this projector from the wall outlet and refer servicing to qualified service personnel under the following conditions:
 - (a) If the power-supply cord or plug is damaged.
 - (b) If liquid has been spilled, or objects have fallen into the projector.
 - (c) If the projector does not operate normally after you follow the operating instructions. Adjust only those controls that are covered by the operating instructions. An improper adjustment of other controls may result in damage and may often require extensive work by a qualified technician to restore the projector to its normal operation.
 - (d) If the projector has been exposed to rain or water.
 - (e) If the projector has been dropped or the cabinet has been damaged.
 - (f) If the projector exhibits a distinct change in performance - this indicates a need for service.
16. **Replacement parts**
When replacement parts are required, be sure that the service technician has used replacement parts specified by the manufacturer or parts having the same characteristics as the original part. Unauthorized substitutions may result in fire, electric shock or other hazards.
17. **Safety check**
Upon completion of any service or repair to this projector, ask the service technician to perform safety checks determining that the projector is in a safe operating condition.

WARNING:**Unplug immediately if there is something wrong with your projector.**

Do not operate if smoke, strange noise or odor comes out of your projector. It might cause fire or electric shock. In this case, unplug immediately and contact your dealer.

Never remove the cabinet.

This projector contains high voltage circuitry. An inadvertent contact may result in an electric shock. Except as specifically explained in the Owner's Guide, do not attempt to service this product yourself. Please contact your dealer when you want to fix, adjust or inspect the projector.

Do not modify this equipment.

It can lead to fire or electric shock.

If you break or drop the cabinet.

Do not keep using this equipment if you break or drop it. Unplug the projector and contact your dealer for inspection. It may lead to fire if you keep using the equipment.

Do not face a lens to the sun.

It can lead to fire.

Use correct voltage.

If you use incorrect voltage, it can lead to fire.

Do not place the projector on uneven surface. Level stable surface only.

Please do not place equipment on unstable surfaces. Do not look into the lens when it is operating. It may hurt your eyes.

Never let children look into the lens when it is on.

Do not turn off the main power abruptly or unplug the projector during operation.

It can lead to lamp breakage, fire, electric shock or other trouble.

Place of installation

Refrain from setting the projector at any place subjected to high temperature and high humidity. Precision devices are built into the projector. Please maintain an operating temperature, humidity, and altitude as specified below for safety's sake.

- Operating temperature: between +41°F (+5°C) and +95°F (+35°C)
- Operating humidity: between 30 and 90%
- Never put any heat-producing device under the projector so that the projector does not overheat.
- Do not attach the projector to a place that is unstable or subject to vibration.
- Do not install the projector near any equipment that produces a strong magnetic field. Also refrain from installing near the projector any cable carrying a large current.
- Place the projector on a solid, vibration free surface: otherwise it may fall, causing serious injury to a child or adult, and serious damage to the product.
- Do not stand the projector on and it may fall, causing serious injury and damage to the projector.
- Place the projector within a slope of $\pm 15^\circ$. Slanting the projector more than $\pm 15^\circ$ may cause trouble or explosion of the lamp.
- Do not place the projector near air-conditioning unit or heater to avoid hot air to the exhaust and ventilation hole of the projector.

COMPLIANCE NOTICE OF FCC

This equipment has been tested and found to comply with the limits for a Class A digital device, pursuant to Part 15 of the FCC Rules. These limits are designed to provide reasonable protection against harmful interference when the equipment is operated in a commercial environment. This equipment generates, uses, and can radiate radio frequency energy and, if not installed and used in accordance with the instruction manual, may cause harmful interference to radio communications. Operation of this equipment in a residential area is likely to cause harmful interference in which case the user will be required to correct the interference at his own expense.

This digital apparatus does not exceed the Class A limits for radio noise emissions from digital apparatus as set out in the interference-causing equipment standard entitled "Digital Apparatus", ICES-003 of the Department of Communications.

Changes or modifications not expressly approved by InFocus could void the user's authority to operate this equipment.

COMPLIANCE NOTICE OF INDUSTRY CANADA

This Class [A] digital apparatus meets all requirements of the Canadian Interference-Causing Equipment Regulations.

Overview of the projector

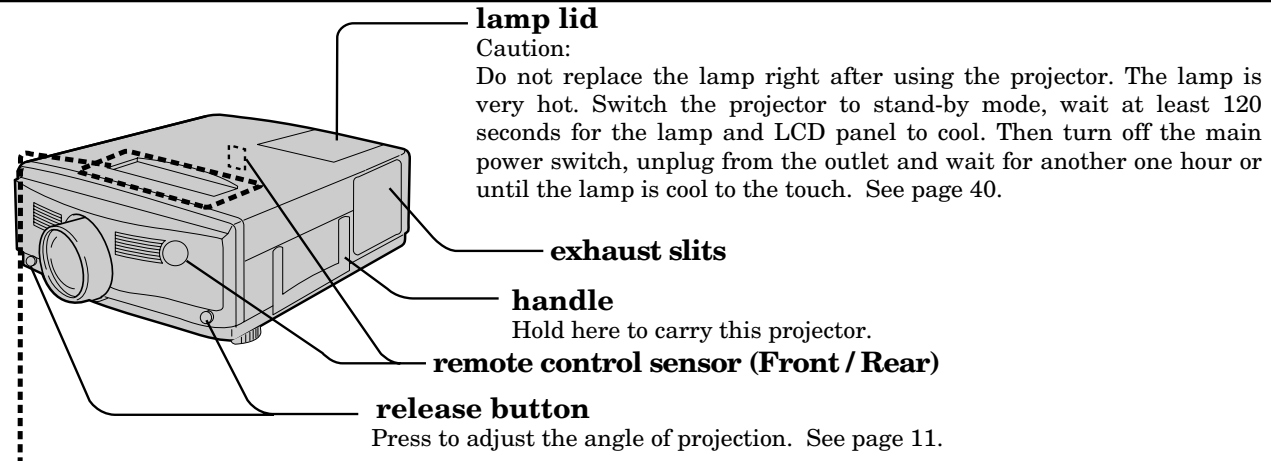

power indicator
When the main power switch is on in stand-by mode, this indicator lights up red. When the projector is fully "ON", the indicator lights up green. See page 44.

lamp indicator
This informs you of the status of the light source lamp and its service life. When the projector lamp is lit, the indicator lights up in green. When operation time of the light source lamp has exceeded 1,000 hours, the indicator will flash alternately between red and green (while the lamp is in use). When the lamp is exhausted, the indicator will show red only. When the lamp is used up to 1,300 hours, the projector automatically shuts off. See pages 40 and 44.

temperature indicator
This informs you of the thermal condition inside the projector. When the inside temperature is extremely high, the power automatically shuts off while the indicator blinks red. See page 44.

PC card indicator
When the PC card is inserted, these indicators light up. See page 27.

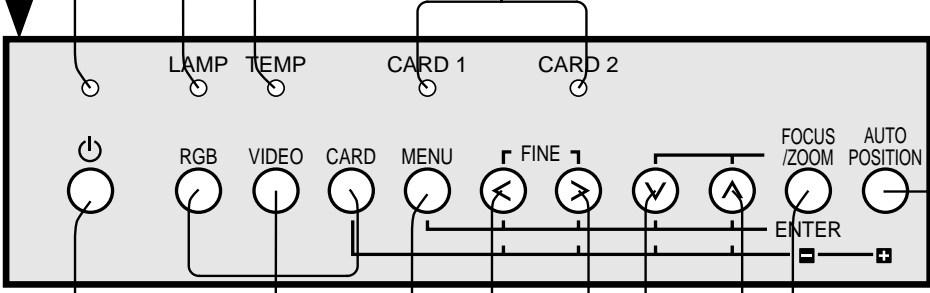

input source (RGB, VIDEO, CARD)
Use to select the input source you wish to watch.

menu
Use to project menu display.

fine (<, >)
Use to make FINE adjustment etc. See the table as shown below.

power
Use to turn the projector on or off when MAIN POWER is on. To turn the projector off, press this button twice.

Important:
When the lamp indicator lights up in green, the power switch cannot be used to switch "ON" and "OFF." Begin operation only after the indicator has stopped blinking.

auto position
Use to adjust the position of Personal computer image. See page 16.

focus / zoom
Use to change the mode of the adjust buttons, focus or zoom etc. See the table as shown below.

^, v
Use to make FOCUS or ZOOM adjustments etc. See the table as shown below.

FINE, v, ^, FOCUS/ZOOM and AUTO POSITION buttons

The operations of these buttons vary as follows depending on the modes selected:

	FINE (<)	FINE (>)	v	^	FOCUS / ZOOM	AUTO POSITION
Normal	Adjust FINE (-)	Adjust FINE(+)	Adjust FOCUS or ZOOM (-)	Adjust FOCUS or ZOOM (+)	FOCUS or ZOOM setting	Adjust position when incorrect
On Menu	Select the setting item (Left)	Select the setting item (Right)	Set the setting item	Set the setting item	Enter the layer setting	-
On PC card Menu	Select previous image (Left)	Select next image (Right)	Select INDEX or FILE	Select INDEX or FILE	Select the group (-)	Select the group (+)

PC card eject
Press to eject the PC card. See page 27.

PC card insert slot
This is where you insert the PC card.
See page 27.

PC analog RGB input (mini D-SUB 15P)
Use to input RGB signal for PC. See pages 13 - 15.

PC audio input (stereo mini jack)
Use to input PC audio signals. See pages 13 - 15.

video/audio input
Use to input video and audio. See page 12.

MAIN power
I : ON
O : OFF

power jack

PC analog RGB output (mini D-SUB 15P)
Use to output RGB signal from RGB1 OR RGB2 input. See pages 13 - 15.

RS-232 1 input (D-SUB 9P)
Connects to personal computer when using SpacePointer (RGB1 IN), accessory PCGC and so on. See pages 35 and 37.

RS-232 2 input (Mini DIN 8P)
Connects to personal computer when using SpacePointer (RGB2 IN). See page 37.

line output
Use to output PC audio if PC audio in, or Audio input 1 or 2 is connected. See pages 12 - 15.

PC analog RGB input
Use to input video signals (analog RGB) of a personal computer.

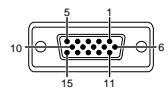

(Pin assignment of Mini D-SUB 15P jack)

PIN NO.	SPEC	PIN NO.	SPEC
1	R(RED)/C _R	9	-
2	G(GREEN)/Y	10	GROUND
3	B(BLUE)/C _B	11	GROUND
4	GROUND	12	-
5	GROUND	13	HD/CS
6	GROUND	14	VD
7	GROUND	15	-
8	GROUND		

(Pin assignment of D-SUB 9P)

PIN NO.	CODE	NAME	I/O	NOTE
1	CD	Carrier Detect	IN	not connected
2	RD	Receive Data (RXD)	IN	connected to inner circuit
3	SD	Send Data (TXD)	OUT	connected to inner circuit
4	ER	Equipment Ready(DTR)	OUT	not connected
5	SG	Signal Ground		connected to inner circuit
6	DR	Data Set Ready(DSR)	OUT	not connected
7	RS	Request to Send(RTS)	OUT	not connected
8	CS	Clear to Send (CTS)	IN	not connected
9	RI	Ring Indicator	IN	not connected

RS-232C 2 input (Mini DIN 8P)

- Please use RS-232C crossover cable and MAC adaptor for RS-232C cable provided.

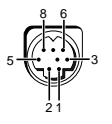

RS-232C input

Connect here when you control this Projector with a personal computer using PCGC (personal computer graphic controller) or with a remote controller using SpacePointer function.

RS-232C 1 input (D-SUB 9P)

- The Pin assignment is DTE (Data Terminal Equipment) type.
- Please use RS-232C crossover cable provided.

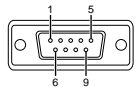

PIN NO.	CODE	NAME	I/O	NOTE
1	RS	Request to Send(RTS)	OUT	not connected
2	CS	Clear to Send (CTS)	IN	not connected
3	SD	Send Data (TXD)	OUT	connected to inner circuit
4	SG	Signal Ground		connected to inner circuit
5	RD	Receive Data (RXD)	IN	connected to inner circuit
6	-			not connected
7	-			not connected
8	-			not connected

Overview of the remote control

operation indicator

When the operation button is pressed, this indicator blinks. It also illuminates when the projector is in the personal computer mode or drawing mode which is able to have a cursor operation. See pages 25, 38.

select

This operates in the same way as the left button on the computer mouse. By pressing this button during the drawing mode can set the start and end point of the figure. See pages 25, 38.

double click

This operates in the same way as double clicking the left button on the computer mouse. See pages 25, 38.

input source (RGB, VIDEO, CARD)

Use to select the input source you wish to watch. If this button is pressed during PinP mode, the input signal of sub image will be changed. See page 16.

menu

Press to display MENU selection bar. Exit the menu system by pressing the MENU button during displaying MENU display. See page 18.

volume (-)

Press to turn the volume down. See the table as shown below.

PinP

Press to turn on the PinP (Picture in Picture) image, or to cancel it. See page 26.

expand

Use to expand the image. See page 26.

card auto play

Press to start auto play function of the PC CARD. See page 28.

PC card release

Press this button to be able to eject PC card. Make sure to press this button all the time to eject the PC card. See page 27.

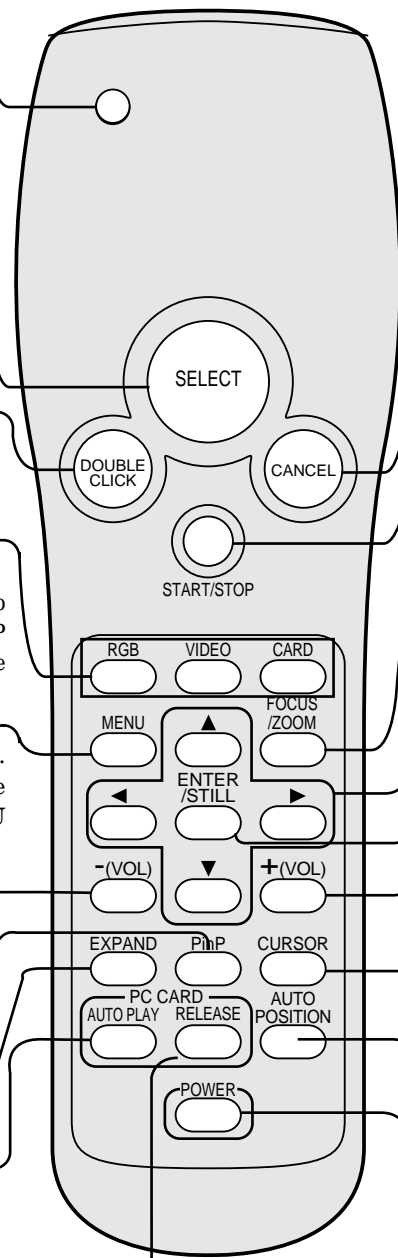

cancel

This operates in the same way as the right button on the computer mouse. If this button is pressed during drawing mode, the figure will disappear. See pages 25, 38.

start/stop

Use to turn the PC control mode or cursor operation mode on or off. See pages 25, 38.

focus / zoom

Use to change FOCUS or ZOOM mode. See page 17.



Used for MENU setting. See the table as shown below.

enter/still

Used for MENU setting. Also, use to freeze the image. See pages 18 and 25.

volume (+)

Press to turn the volume up. See the table as shown below.

cursor

Press to display the cursor. Also used to change the mode of PC control or cursor operation, when the projector is connected to a personal computer with RS-232C. See pages 25 and 38.

auto position

Use to adjust the position of Personal computer image. See page 16.

power

Use to turn the projector on or off when MAIN POWER is on. To turn the projector off, press this button twice. See page 22.

The operations of these buttons varies as follows depending on the modes selected:

	◀	▶	▼	▲	- (VOL)	+ (VOL)
Normal	Adjust FINE (-)	Adjust FINE(+)	Adjust FOCUS or ZOOM (-)	Adjust FOCUS or ZOOM (+)	Volume down	Volume up
On Menu	Select the setting item (Left)	Select the setting item (Right)	Set the setting item	Set the setting item	-	-
On PC card Menu	Select previous image (Left)	Select next image (Right)	Select INDEX or FILE	Select INDEX or FILE	Select the group (-)	Select the group (+)
PinP	Exchange the image (main or sub)	Exchange the image (main or sub)	Switch still pictures (main or sub)	Switch still pictures (main or sub)	Recapture of the still picture	Recapture of the still picture
EXPAND	Expand different area (Left)	Expand different area (Right)	Expand different area (Down)	Expand different area (Up)	Set the expand rate (-)	Set the expand rate (+)

Important:

- To save battery power, turn off the operation indicator by pressing the START/STOP button when not in use.
- To save battery power, the operation indicator will turn off if the remote control is not operated for a period of 5 minutes.

Battery installation

Use two AA size batteries.

1. Remove the back cover of the remote control by pushing the battery compartment door in the direction of the arrow.
2. Load the batteries making sure that they are positioned correctly (+ to +, and - to -).
3. Replace the back cover.

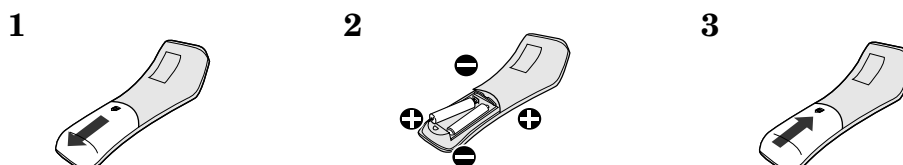
**Important:**

- Do not use a new battery with an old one.
- Load batteries in the correct position.
- Do not heat, take apart, or throw batteries into fire.
- Do not try to recharge batteries. Do not use rechargeable batteries.
- If the alkaline solution of alkaline batteries comes in contact with your skin or clothes, rinse with water. If the solution comes in contact with your eyes, rinse them with water and then consult your doctor.

Operation area

The range for operation is about 10m when the remote points to the projector. When using the remote control for SpacePointer, the range for operation is about 7m. The distance to the screen back to the projector must be less than 7m.

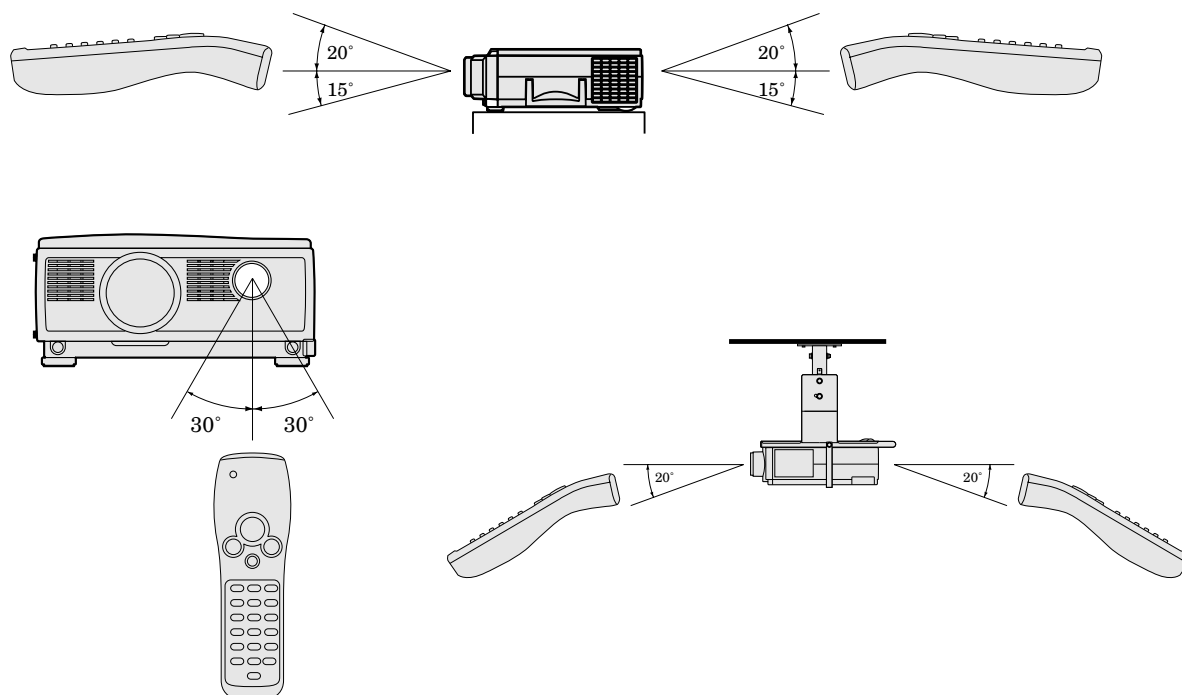
**Important:**

Avoid the direct sunlight or fluorescent light to the remote control sensor. Also keep the distance of more than 2 m between the remote control sensor and fluorescent lamp. The remote may not work correctly.

Preparing the projector for operation

Orientation of the projector

Picture size can be set by changing the distance between the screen and the projector.

Front projection

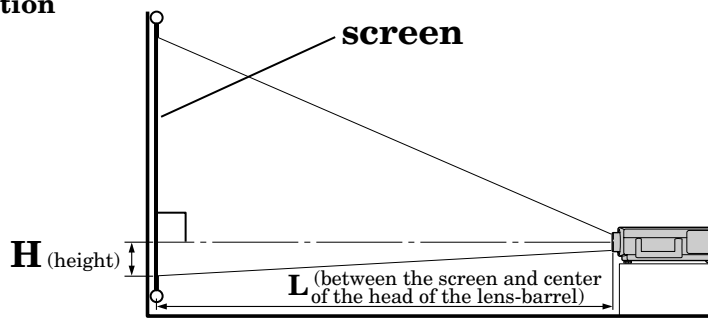

To find the approximate distance between the projector and screen:
 Multiply the width of the screen x 1.875 - 1.975 (max.) ,
 Multiply the width of the screen x 2.468 - 2.57 (min.) ,

- Refer to the chart to recommended distances in maximum zoom and minimum zoom.

Screen			Distance from screen (L) / (approximate)				Height projected image (H) / (approximate)	
Diagonal size (inch)	Height inches (inch)	Width feet (inch)	Maximum zoom (min.)		Minimum zoom (max.)		(mm)	(inch)
			(mm)	(inch)	(mm)	(inch)		
40 "	24 "	32 "	1527	60.12"	2012	79.21"	76	3.0"
60 "	36 "	48 "	2335	91.93"	3062	120.55"	114	4.49"
80 "	48 "	64 "	3143	123.74"	4112	161.89"	152	5.98"
100 "	60 "	80 "	3951	155.55"	5162	203.23"	191	7.52"
120 "	72 "	96 "	4758	187.32"	6213	244.61"	229	9.02"
140 "	84 "	112 "	5566	219.13"	7263	285.94"	267	10.51"
160 "	96 "	128 "	6374	250.94"	8313	327.28"	305	12.0"
180 "	108 "	144 "	7182	282.75"	9363	368.62"	343	13.5"
200 "	120 "	160 "	7990	314.57"	10413	409.96"	381	15.0"
300 "	180 "	240 "	12029	473.58"	-	-	572	22.52"

Front projection, ceiling mount

For ceiling mount, you need the ceiling mount metal etc. Also ask specialist for installation. For more detail, ask your dealer.

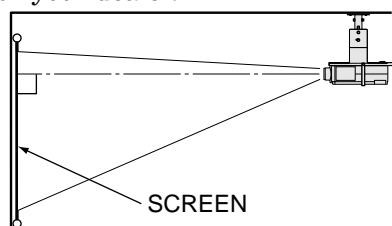

- When the use of ceiling mount, set IMAGE REVERSE in INSTALLATION menu to INVERT. You can not use KEYSTONE when IMAGE REVERSE is INVERT. See Page 20.
- Projected images may appear darker when the unit is used as a ceiling installation than when it is used in the tabletop position. This does not signify a product malfunction.

Rear projection

Also ask specialist for installation. For more detail, ask your dealer.

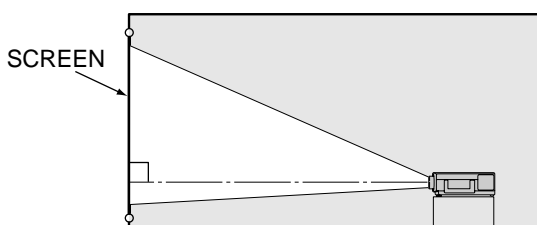

- For rear projection, set IMAGE REVERSE in INSTALLATION menu to MIRROR. See Page 20.

Caution:

- Placing the projector on a carpet reduces ventilation from the fan on the bottom and might cause problems. Place a hard board or similar item under the projector to facilitate ventilation of the unit.
- Place the projector more than 20 in. from the wall to prevent blocking the intake, exhaust slots and ventilation of this projector because hot air comes out of it.
- Do not use the projector under the following circumstances, which may cause fire or electric shock.
 - in a dusty or humid place
 - while the projector is lying sideways or upside down.
 - near a heater
 - in a kitchen or oily, smoky or damp place
 - in direct sunlight
 - where the temperature is lower than 41°F or higher than 95°F

Important:

- Do not put stress on the lens or focus ring, as this may damage them.
- Keep your room dark while using the projector. The image cannot be seen clearly in a bright place.

Adjusting the angle of projection

Screen on a flat wall with a 90 degree angle to the floor by adjusting two foot adjustments on the bottom of the projector. If the angle cannot be corrected by them, adjust the height and angle of screen.

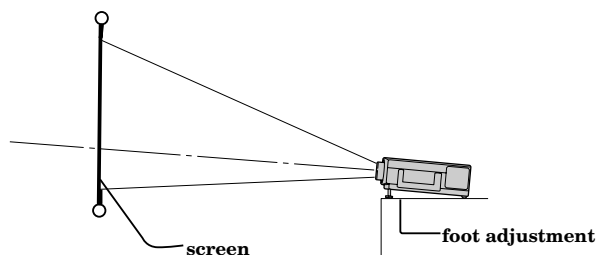

1. Lift the projector to the right angle.

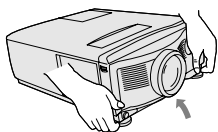

2. Press the release button for angle adjustment to take the adjustment feet out of the projector.
3. Release the button and keep your hands away from the projector.

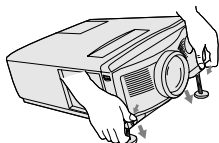

4. Turn the both feet to right or left to adjust for proper angle.

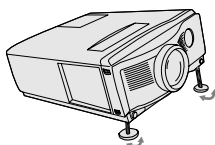

After using the projector

5. Press the release button to take the projector down slowly while holding it.

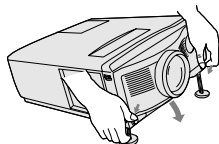

Important:

The image becomes trapezoid shape when the screen or projector is not level. Use **KEYSTONE** in **INSTALLATION** menu to adjust, however, the circumference of the image may not be focused. See page 20.

- Screen on a flat wall with a 90° angle to the floor.
- Align projector to produce a full screen display as illustrated on page 10.
- Distance from projector to screen must be compatible with screen size chart on page 10. Note distance from screen chart.
- If image is not square on screen, try adjusting the front feet of the projector for proper angle.

Getting ready for projection

1. Connect the power cord provided to this projector with the power jack of the projector.
2. Connect the power cord to the wall outlet.
3. Take off the lens cap.
4. Do not look directly into the lens when projector is "ON".

Warning:

- The lens cap is for protecting the lens. If you leave the power on with the cap on, the cap may be warped. Please remove the lens cap when you turn the power on.
- Use the appropriate power cord for your country.
- A three-pin grounding type power plug is used with the projector. Do not remove the grounding pin on the power plug. If you are unable to insert the plug into the outlet, contact your electrician to replace your obsolete outlet.
- Use 100-240V AC 50/60Hz correct voltage otherwise it may lead to fire or electric shock.
- Do not place an object on the power cord and keep the projector away from heat source to avoid breaking the power cord. A broken of power cord can cause fire or electric shock.
- Do not revise or alter the power cord otherwise it may cause fire or electric shock. Contact your dealer if the cord is broken.

Caution:

- Plug in firmly and unplug by holding the plug, not by pulling the cable out.
- Do not plug in or out with wet hands. It may cause an electric shock.

Basic connections

The projector can be connected to equipment such as VCRs, video cameras, videodisc players, and personal computers having analog RGB input.

ENGLISH

Important:

- Make sure that your equipment is turned off before connection.
- Match the color of video and audio plugs on the AV cable with each terminal.
- Plug in firmly and unplug by holding the plug, not by pulling the cable out.
- If connected units are set too close to one another, the image may be affected. Setting connected units too close to one another affects the image.
- Refer to the owner's guide of each component for details of connections, .

Projector + AV equipment

Make sure that your equipment is turned off before connection.

Important:

- S-video signals take priority over video signals. If you input both S-video signals and normal video signals at the same time, the normal video input automatically shuts off.

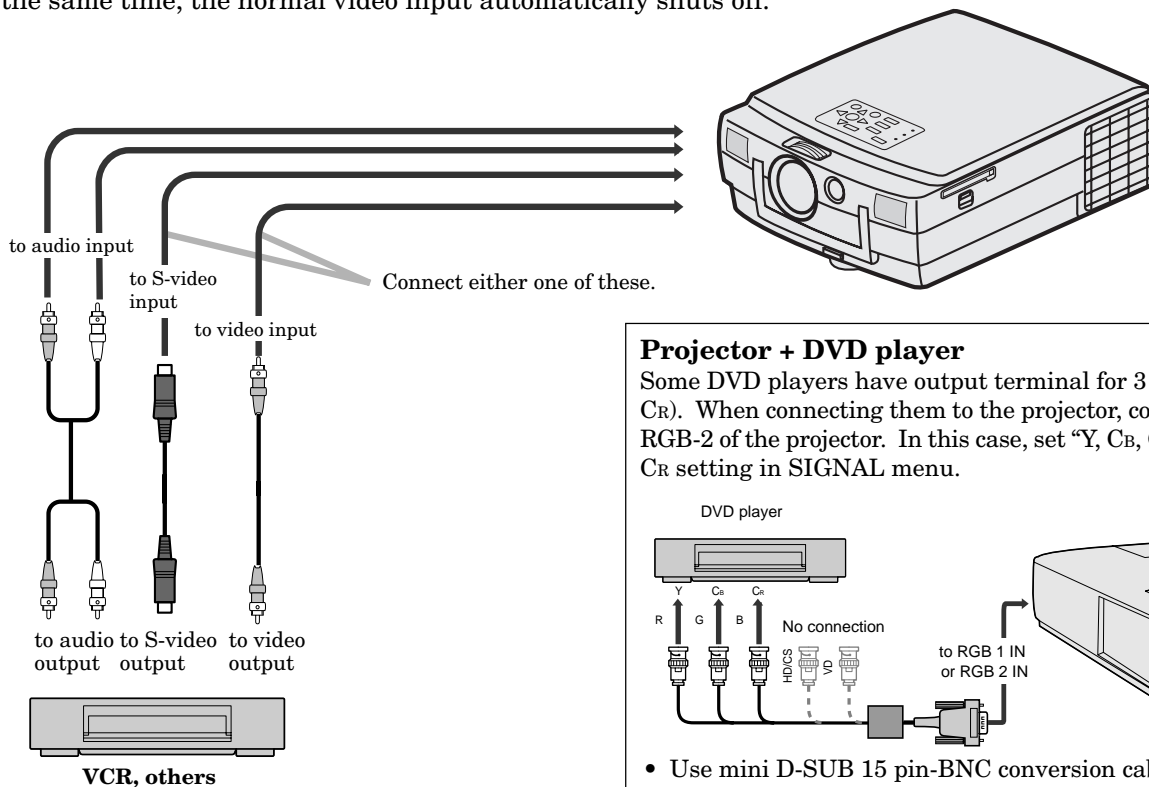

Cables and adapters

To connect personal computers to this projector, the following cables and adapters are necessary. The overview might be different from the picture below.

RGB cables (mini D-SUB 15P plug)

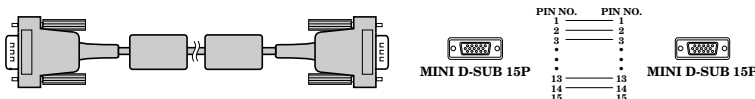

Note: The pins numbered 5, 9, 12 and 15 are not connected.

RGB Conversion adapter for NEC PC (Option) (mini D-SUB 15P plug - D-SUB 15P plug)

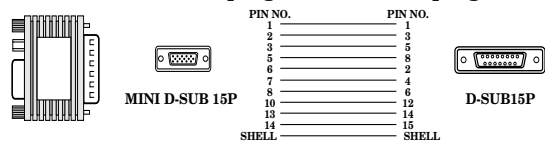

RGB Conversion adapter for MAC

(mini D-SUB 15P plug - D-SUB 15P plug)

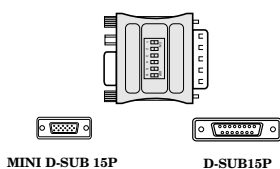

Note: Set the dip switch to the appropriate position.

Display mode	Resolution	Dip switch					
		1	2	3	4	5	6
13 inch	640 X 480	ON	OFF	OFF	ON	OFF	ON
16 inch	832 X 624	ON	OFF	ON	OFF	OFF	ON
19 inch	1024 X 768	ON	ON	OFF	OFF	OFF	ON
21 inch	1152 X 870	ON	ON	ON	ON	OFF	ON

Projector + IBM PC or IBM PC compatibles

Make sure that your equipment is turned off before connection.

Important:

- Connectors or analog RGB output adapters may be necessary depending on the personal computer connected to this projector. Please contact your dealer.
- The audio input for a personal computer is the stereo mini-jack. There are some personal computers that have different types of audio outputs or none at all. Please ask your dealer for details.
- For connection details, refer to the owner's guide of each component.

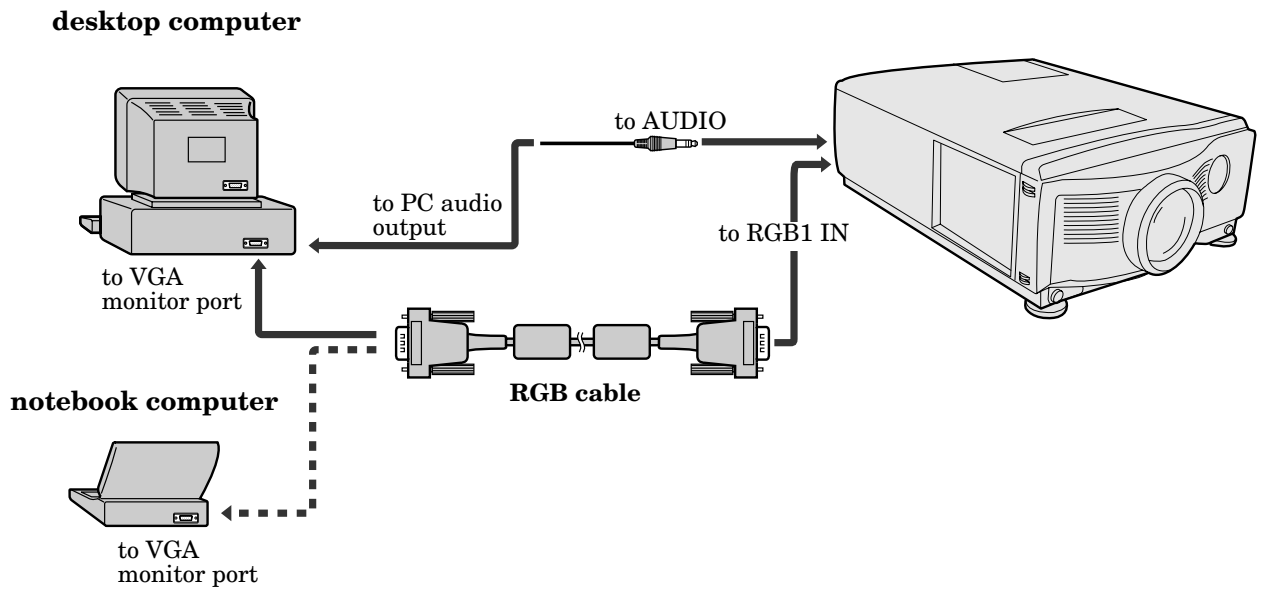

When outputting to both a PC monitor and the projector

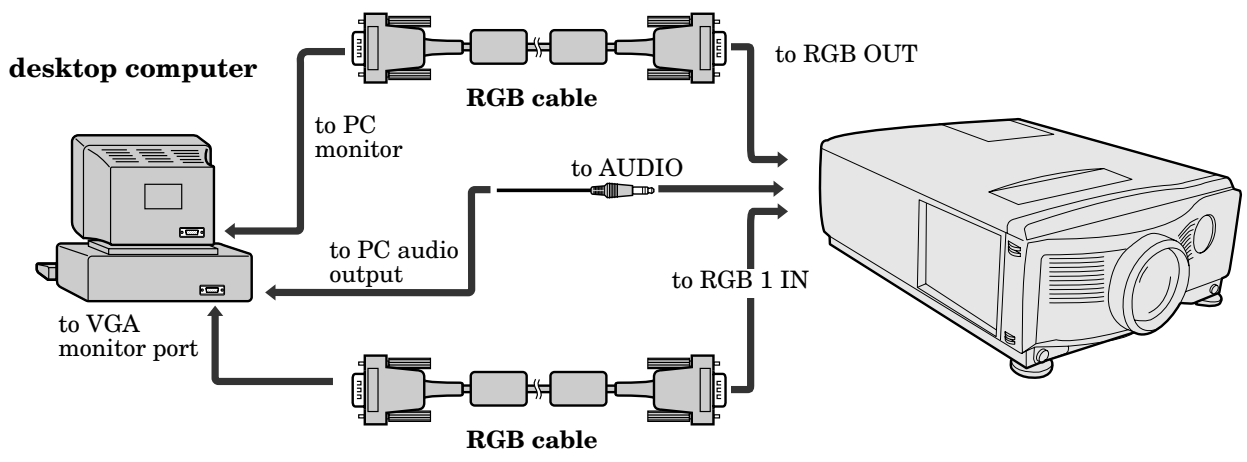

Basic connections (continue)

ENGLISH

Projector + Macintosh

Make sure that your equipment is turned off before connection.

Important:

- A monitor output adapter is necessary for a Macintosh if it has no video port. Contact your dealer.
- If you use the RGB conversion adapter provided, set the dip switch to the appropriate position. See page 12.
- Connectors or analog RGB output adapters may be necessary depending on the personal computer connected to this projector. Please contact your dealer.
- The audio input for a personal computer is the stereo mini jack. There are some personal computers that have different types of audio outputs or none at all. Please ask your dealer for details.
- For connection details, refer to the owner's guide for each component.
- When outputting to both a PC monitor and the projector, use an Apple Macintosh monitor or multiscan monitor corresponding to Composite Sync.

desktop computer

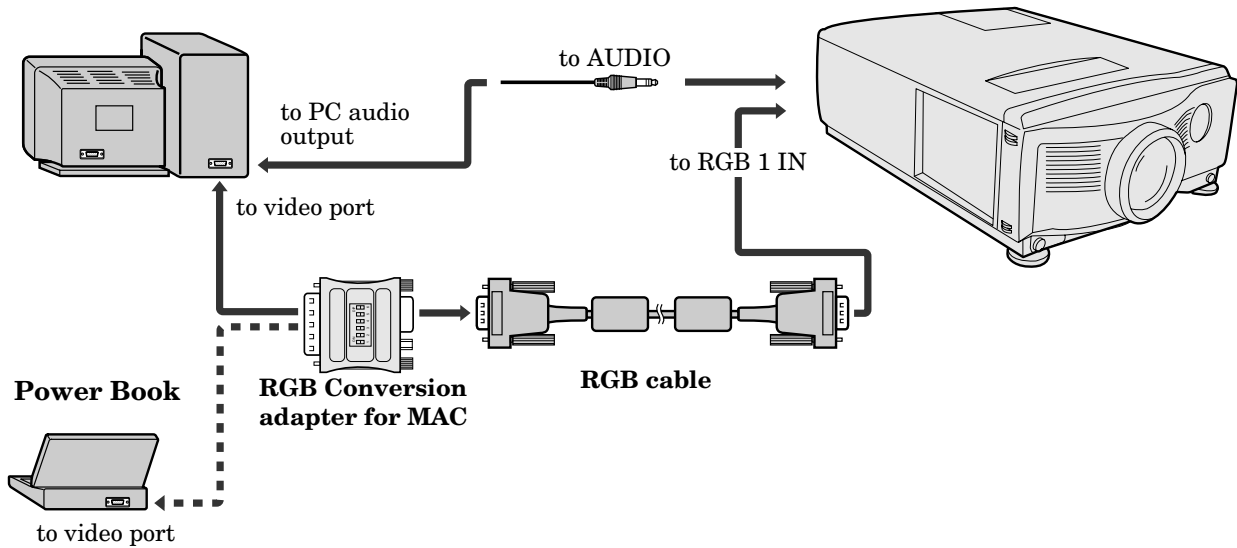

When outputting to both a PC monitor and the projector

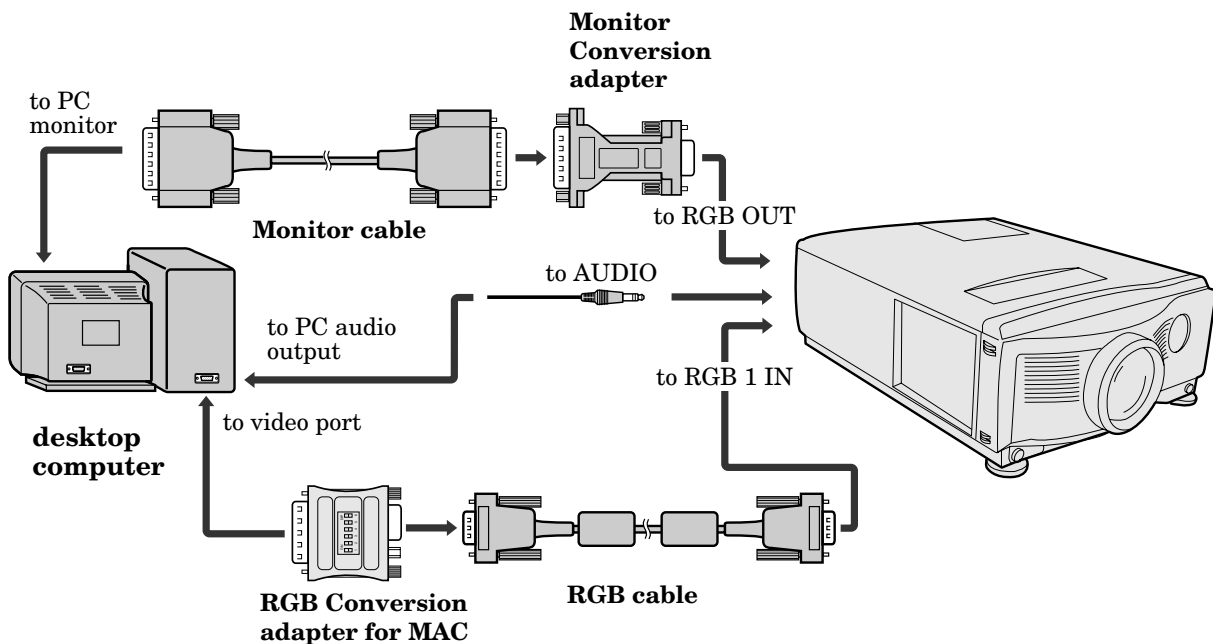

Projector + NEC PC-98 series

Make sure that your equipment is turned off before connection.

Important:

- Connectors or analog RGB output adapters may be necessary depending on the personal computer connected to this projector. Please contact your dealer.
- The audio input for a personal computer is the stereo mini jack. There are some personal computers that have different type or no audio outputs. Please ask your dealer for details.
- For connection details, refer to the owner's guide of each component.

desktop computer

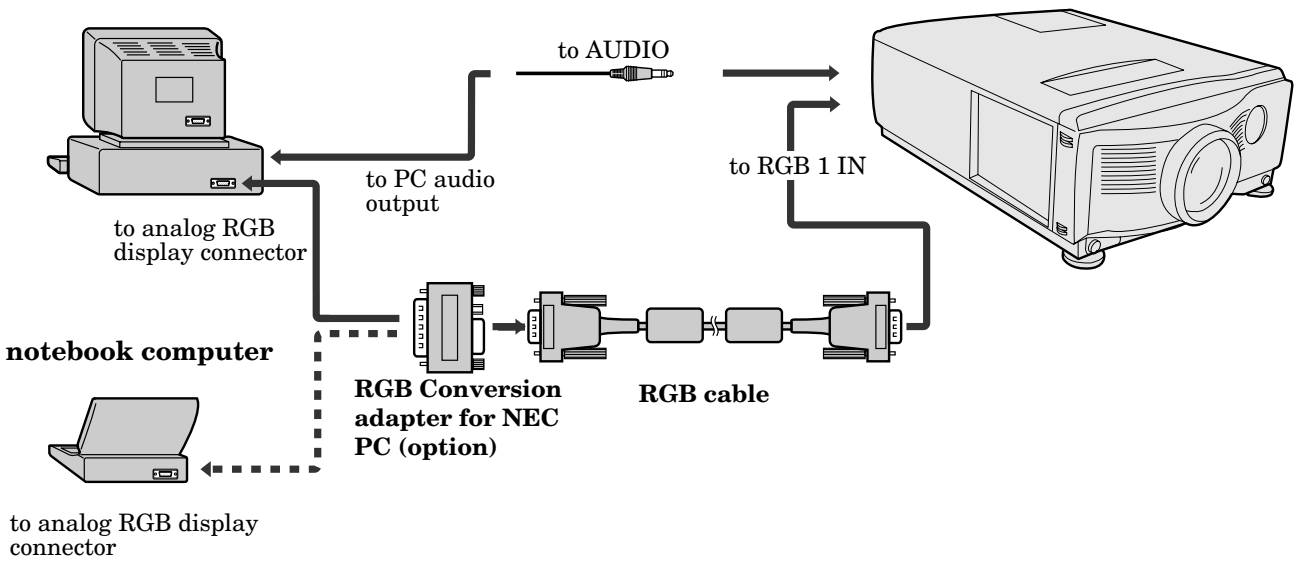

When outputting to both a PC monitor and the projector

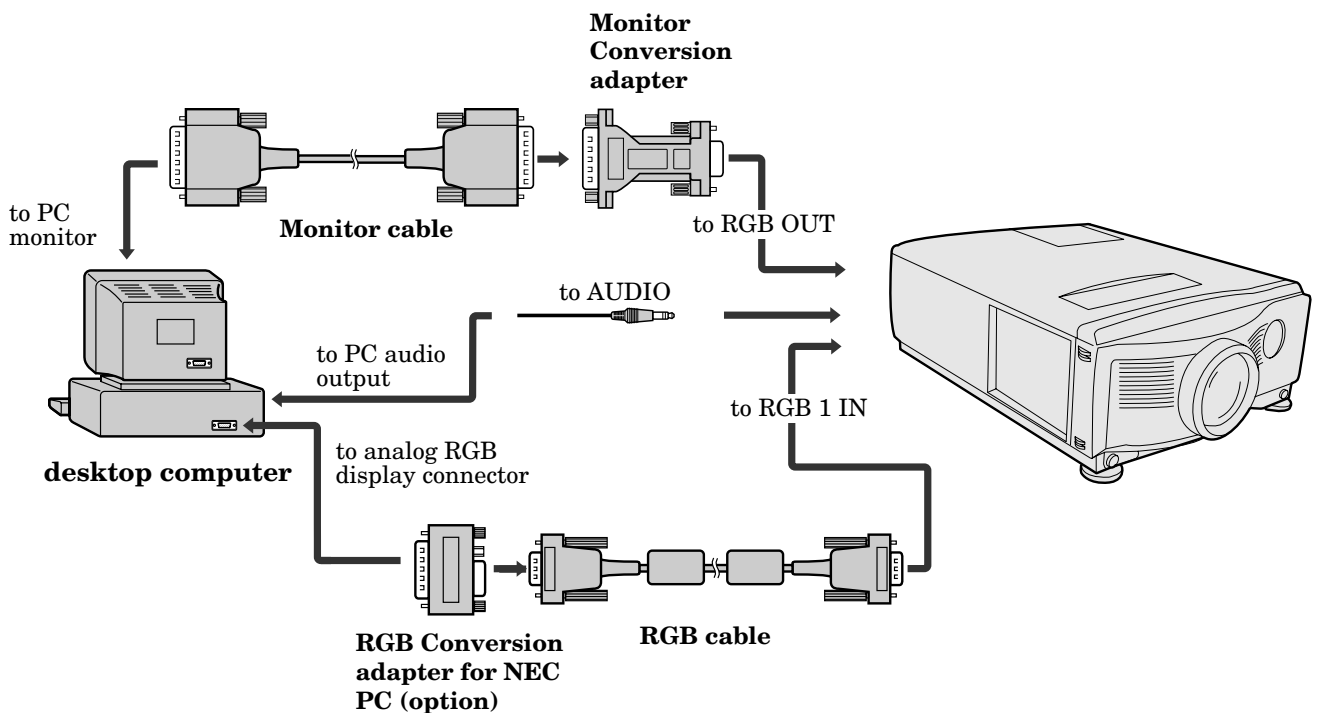

To operate projector power ON

Numbers 1 - 9 correspond to the instruction numbers below.

ENGLISH

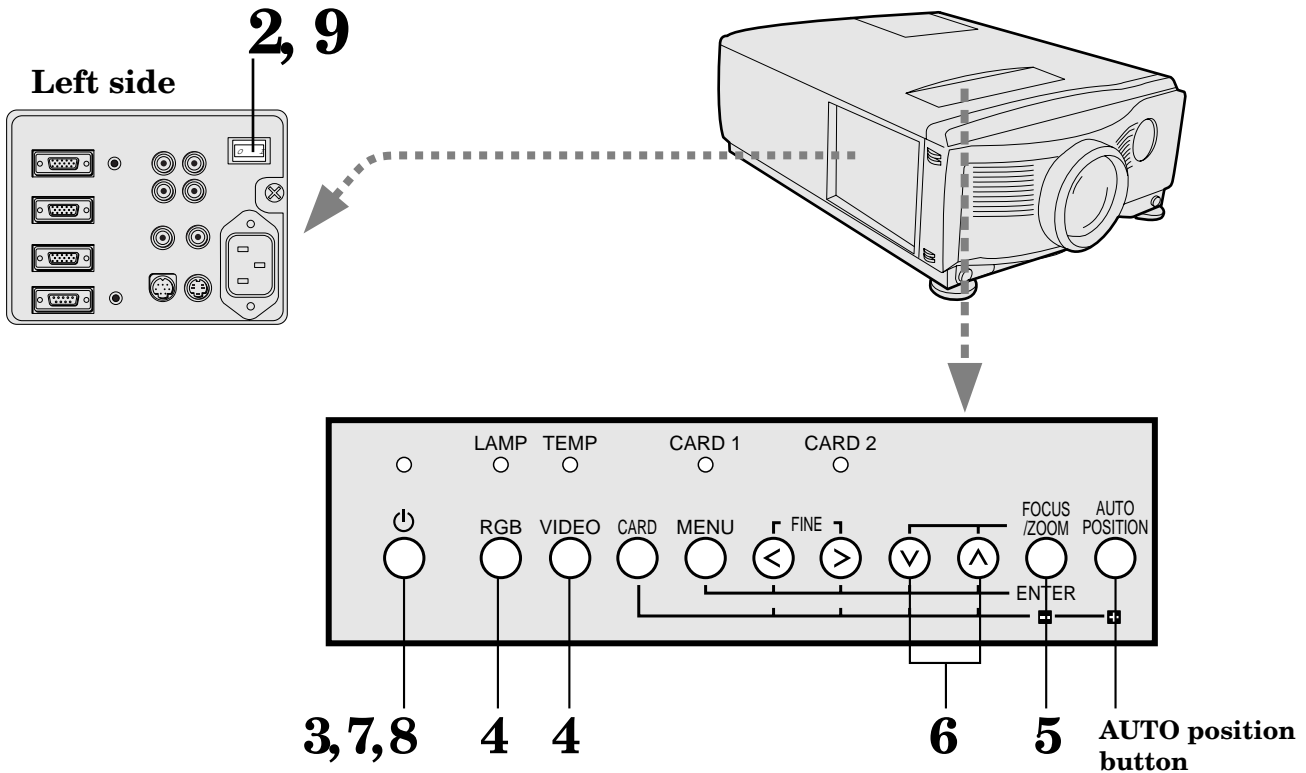

1. Put the projector into standby mode by pressing the main power switch. The POWER indicator lights up red.
2. Turn on the equipment connected to the projector.
3. Turn the projector on by pressing the POWER button. The light source lamp starts warming up, eventually turning on. In cases where light source lamp does not come on, wait for one minute before switching power on again.
 - If power to the main unit is turned off within two minutes of turning off the light source lamp, power will not be introduced to the lamp for one minute the next time the main unit power switch is turned on. When this happens, the indicator lamp will blink for one minute.

Important:

- A darkened image may be seen right after pressing the POWER button due to warming up of this projector. When warming up, no other commands can be accepted.
 - When the lamp indicator is blinking red, the service life of the lamp is about to end. Replace the lamp. See pages 40 and 44.
 - The picture might not be of optimum performance in extreme hot or cold conditions. (The projector is not malfunctioning.)
4. Select the desired external input source by using the RGB or VIDEO button.
 - The projector automatically selects the appropriate signal system. The selected signal system is displayed on the SIGNAL menu.
 - When selecting the RGB1 or RGB2 input, the image may be flickered. Press the FINE buttons to adjust the image.
 - Press CARD button to see the PC CARD images. (You cannot select it when CARD 1 or CARD 2 indicator is not lighting up.)

condition	indicator	LAMP	POWER
stand-by		-	red
when light source lamp is on		green	green
when light source lamp does not light up		-	red

AUTO POSITION button

When the source is selected to RGB1 or RGB2 and the image is not in the right place, set to display as blightest signal as possible, then press the AUTO POSITION button. If the image is still not in the right place.

- Set screen to the brightest display possible (e.g., full-screen display of the “Trash” window) before deploying the automatic adjustment function.
 - If the screen saver is running, turn off the screen saver before using the automatic adjustment button.
5. Press the FOCUS/ZOOM button to FOCUS. “FOCUS” will appear on the display.
 6. Adjust with the \wedge or \vee buttons on the control panel (or \blacktriangle or \blacktriangledown buttons on the remote control) to get a fine picture.
 - Focus and zoom adjustment by using the buttons on the control panel or the remote control is possible in the normal picture mode only. In PinP, EXPAND or cursor operation mode, the adjustment is impossible.

The volume from the speaker

Press the VOLUME buttons on the remote control to change the volume from the speaker. You can also change it by selecting the volume in AUDIO menu. When setting “ON” for MUTE in AUDIO menu, you can stop the sound momentary.

- The volume button does not work when MENU selecting bar or MENU is displayed.

Turning off the projector

7. Press the POWER button.
The message “POWER OFF? YES : PRESS AGAIN” appears on the screen.
 - To exit from this mode, press any button except POWER button.
8. Press the POWER button again.
The light source lamp will be turned off.
By pressing the POWER button again, shuts off the light source lamp, but the exhaust fan continues to operate for 120 seconds to cool down the light source lamp and LCD panels. In this time, the lamp indicator will be turned off from flashing.
9. Turn off the main power switch. When turning off the main switch, the POWER indicator turns off.
 - In cases where the main power switch is accidentally turned off when either the intake/exhaust fan or the power source lamp is in operation, allow the unit to cool down for 10 minutes with the power turned off. Repeat step 3 when turning on the power source lamp. If the lamp does not turn on immediately, repeat this step two or three times. Replace the lamp if it should still fail to turn on.

Caution:

- When you have finished using this equipment, wait 120 seconds for the exhaust fans to stop. Then turn off the main switch and unplug the power cable from the wall outlet, for safety purposes.
- After the lamp is turned off, the lamp cannot be switched on again for 60 seconds as a precautionary measure. It will take another 60 seconds before the lamp indicator goes off. If you wish to turn on the projector again, wait until the indicator is off then press the POWER button.
- The exhaust fans faster automatically when the temperature around the projector becomes high.
- When the temperature around the projector becomes much higher, the sign of “TEMP!!” blinks red on the screen. If the temperature stays in high, the lamp will be shut off automatically .

The projector automatically shuts off when the lamp is used up in about 1,300 hours and not used until lamp replacement.

Menu operation

Basic operation

Several settings can be adjusted using Menu.

EXAMPLE: Brightness adjustment

1. Press the MENU button.

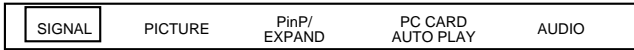

2. Press the < or > buttons on the control panel (or ◀ or ▶ buttons on the remote control) to select PICTURE.

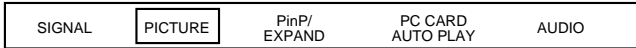

3. Press the ^ or v buttons on the control panel (or ▲ or ▼ buttons on the remote control).

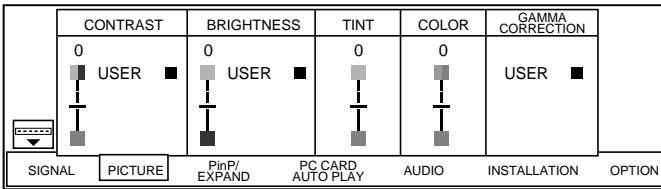

4. Press the < or > buttons on the control panel (or ◀ or ▶ buttons on the remote control) to select BRIGHTNESS.

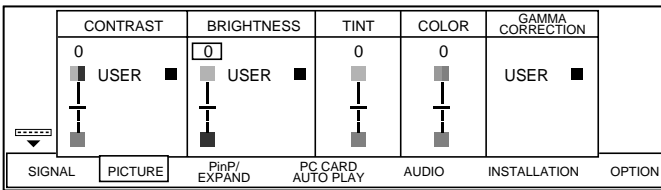

5. Press the ^ or v buttons on the control panel (or ▲ or ▼ buttons on the remote control) to adjust brightness.

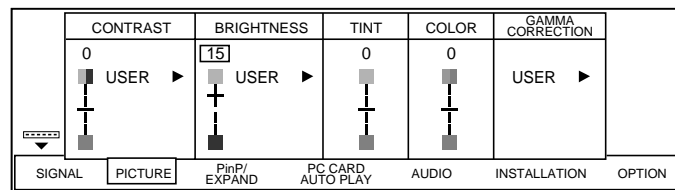

If you wish to change the color balance, follow the steps below.

6. Press the < or > buttons on the control panel (or ◀ or ▶ buttons on the remote control) to select USER and press the ENTER button.

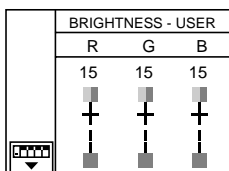

7. Press the < or > buttons on the control panel (or ◀ or ▶ buttons on the remote control) to select the desired color R, G or B.

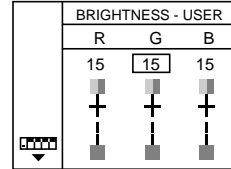

8. Press the ^ or v buttons on the control panel (or ▲ or ▼ buttons on the remote control) to adjust brightness of the desired color.

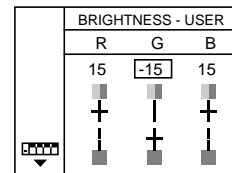

9. Exit the menu system by pressing the MENU button several times.

- If the menu operation is not working, simultaneously press the MENU and POWER button.
- To switch back to the factory preset of each menu, select RESET and press the ENTER button.
- When selecting RESET, the buttons cannot be operated for 2 to 18 seconds.

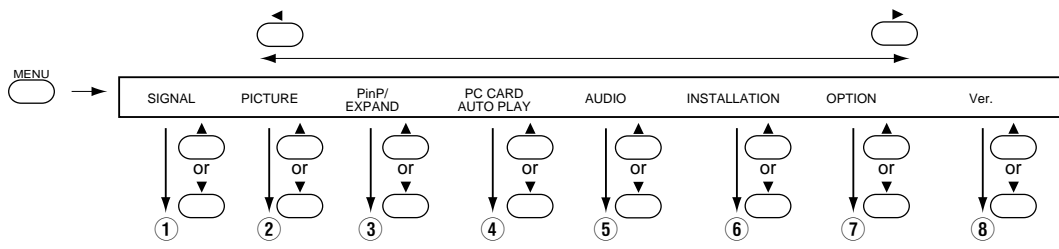

① SIGNAL

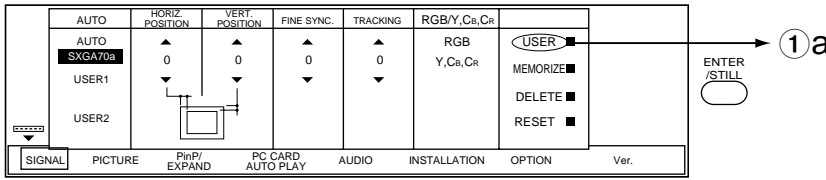

- AUTO Use to select AUTO, USER 1 or USER 2.
- HORIZ. POSITION Use to adjust the horizontal position of the image.
- VERT. POSITION Use to adjust the vertical position of the image.
- FINE SYNC. Use to synchronize the projector with PC input signals so that the image is not blurred.
- TRACKING Use to avoid image noise such as wide stripes.
- RGB/Y, CB, CR ... The unit adjusts itself automatically when connected to either DVD players with a component video output terminal (Y, CB, CR or Y, PB, PR) or equipment with HDTV signal output capabilities. In cases where the unit is connected to equipment that include an RGB output terminal and which output HDTV signals, adjust the unit to RGB mode.

① a SIGNAL - USER (Normally, there is no need for adjustments.)

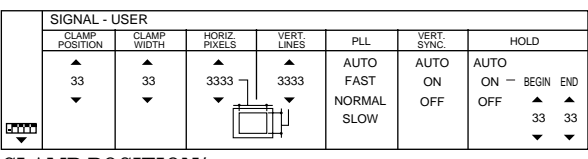

- CLAMP POSITION/
CLAMP WIDTH If you use a PC video card or something similar, the lighter colors of the projected image may become blurred. In this case, adjust CLAMP POSITION or CLAMP WIDTH.
- HORIZ. PIXELS Use to adjust the height of the image. The image size grows higher as the number increases. (Adjust to the horizontal pixels of inputting signal for normal setting.)
- VERT. LINES Use to adjust the width of the image. The image size grows wider as the number increases. (Adjust to the vertical lines of inputting signal for normal setting.)
- PLL Use to adjust the image which upper right side is awry. Select AUTO for normal setting.
- VERT. SYNC. Use to adjust the image when its motion does not run naturally. Select AUTO for normal setting.
- HOLD Adjusts the image which upper right side is awry.

② PICTURE

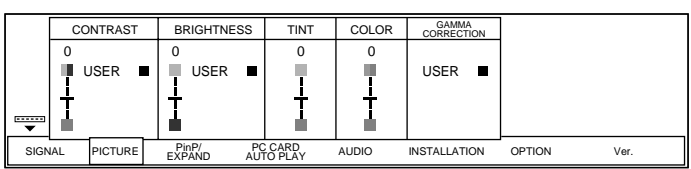

- CONTRAST Adjusts the picture contrast. The contrast becomes higher as the number increases.
- BRIGHTNESS Adjusts image brightness. The image becomes brighter as the number increases.
- TINT Adjusts the color balance in the image. The color balance of the image shifts green as the number increases and shifts to purple as the number decreases (only when NTSC or 4.43 NTSC is selected).
- COLOR Adjusts the color intensity of the image (only when NTSC, PAL, SECAM or 4.43 NTSC is selected).
- GAMMA CORRECTION ... Corrects the proportion of the brightness of input signals to that of output signals. Also corrects the contrast of projected images.

Menu operation (continue)

③ PinP/EXPAND

This menu appears when either the display enlargement or PinP functions are used.

		ZOOM MODE	POSITION	SIZE	AUTO PIP	
		1	1	1	ON	
		2	2	2	OFF	
		3	3	3		
		4	4			
		5	5			
SIGNAL	PICTURE	PinP/EXPAND	PC CARD AUTO PLAY	AUDIO	INSTALLATION	OPTION Ver.

ZOOM MODE Selects the desired type of expand mode, type1, 2, 3 or 4 (actual size display).

POSITION Selects the desired position of the sub image in expand or PinP mode.

SIZE Selects the desired size of the sub image in expand or PinP mode.

AUTO PIP Sets to move the position of PinP pictures automatically or not, when it appears on the red frame which shows the PinP part.

④ PC CARD AUTO PLAY

		AUTO SLIDE TIME	REPEAT	ICON	
		33 sec.	ON	ON	
			OFF	OFF	
SIGNAL	PICTURE	PinP/EXPAND	PC CARD AUTO PLAY	AUDIO	INSTALLATION OPTION Ver.

AUTO SLIDE

TIME Sets the length of time before the image switches to the next image in PC CARD automatic playback mode.

REPEAT Sets to repeatedly playback the PC CARD presentation or not in PC CARD automatic playback mode.

ICON Select whether to addition of card icon of PC card. Even the setting is OFF, if you press the PC card end button on the remote control, the card icon will automatically appear.

⑤ AUDIO

		VOLUME	MUTE	
		30	ON	
			OFF	
SIGNAL	PICTURE	PinP/EXPAND	PC CARD AUTO PLAY	AUDIO INSTALLATION OPTION Ver.

VOLUME Adjusts the volume of sound. The volume becomes louder as the number increases.

MUTE Use to set MUTE on or off. Select ON to switch off the sound. Select OFF to switch the sound back on.

⑥ INSTALLATION

		IMAGE REVERSE	KEystone	AUTO POWER ON	TEST SIGNAL
		OFF <input type="checkbox"/>	0° <input type="checkbox"/>	ON	OFF
		MIRROR <input type="checkbox"/>	3° <input type="checkbox"/>	OFF	1
		INVERT <input type="checkbox"/>	6° <input type="checkbox"/>		2
			9° <input type="checkbox"/>		3
			12° <input type="checkbox"/>		4
		MIRROR, INVERT <input type="checkbox"/>	15° <input type="checkbox"/>		
SIGNAL	PICTURE	PinP/EXPAND	PC CARD AUTO PLAY	AUDIO	INSTALLATION OPTION Ver.

IMAGE REVERSE Use to reverse or invert the projected image. MIRROR is used for rear projection. INVERT is effective when the projector is ceiling-mounted.

KEystone Adjusts keystone correction of the image. If the image becomes keystone distortion, select the approximate setting. For normal use, select 0°. You can use it only when IMAGE REVERSE is OFF.

AUTO POWER ON To select whether to boot up automatically when the power is turned on by a breaker. In this case, the main power of the projector has to be ON. Set this when the projector is hanging on the ceiling.

- The projector is in stand-by mode when the lamp does not come on. In this case, use the remote control to turn on the lamp.

TEST SIGNAL Use to display the built-in test pattern on the screen.

- The display will disappear when the setting is OFF or press the button except MENU, ZOOM/FOCUS, \wedge , \vee , \blacktriangle , \blacktriangledown and START/STOP.

⑦ **OPTION**

	MOTION / STILL	SQUEEZE	MENU POSITION	AUTO POWER OFF	REMOTE POSITION	VIDEO SIGNAL	RGB OUTPUT	LANGUAGE
	MOTION STILL	ON OFF	1 <input type="checkbox"/> 2 <input type="checkbox"/>	ON — 5 min. OFF	AUTO FRONT REAR	AUTO NTSC PAL SECAM 4.43NTSC PAL-M PAL-N	AUTO RGB1 RGB2	日本語 English Español Deutsch Français Italiano 中文
SIGNAL	PICTURE	PinP / EXPAND	PG CARD / AUTO PLAY	AUDIO	INSTALLATION	OPTION	Ver.	

MOTION/STILL . Select MOTION when motion images are mainly projected. Select STILL when still images such as PC-CARD images are mainly projected. It works only when inputting personal computers of SXGA signals or inputting video signal.

SQUEEZE Set to switch the normal image (4:3) and HDTV (16:9) automatically or not, depending on the image signals.

MENU POSITION . Use to select the position where the menu is displayed (top or bottom on the screen).

AUTO POWER OFF .. Use to select the length of time before the projector switches to standby when there is no input signal selected source. Select OFF to cancel this function.

REMOTE POSITION Select either FRONT or REAR to receive the infrared signal from the remote control. Select AUTO for normal setting.

Note: When the remote position is changed with AUTO setting, the buttons cannot be operated for about 3 seconds.

SIGNAL When AUTO is set, the appropriate video standard is automatically selected according to the input signal. If the image does not appear correctly, select the desired video standard manually. Adjust the unit to the appropriate format when the unit either is not projecting normally in auto mode or is inputting PAL-M/PAL-N signals.

RGB OUTPUT Use to select the output image from the personal computer terminal (RGB OUT). When selecting AUTO, the terminal images which signals are input are projected. When a video signal or PC card is displayed, the unit will project the image sent from the PC input terminal last displayed.

LANGUAGE Use to select the language for the projector display such as menu.

⑧ **Ver.**

							Ver. 3.3
INITIALISATION	IMAGE	2 SOURCES / ZOOM	LECT AUTO CARTES PC	AUDIO	INSTALLATION	OPTION	Ver.

Ver. Displays the version of the installed software.

Picture adjustment

Adjustment from personal computer

Although this projector sets proper signal systems automatically for the image signal from personal computers, it cannot be applied to some of personal computers. In this case, press AUTO POSITION button. If the images are still not projected correctly, use MENU display to adjust the projected images from personal computers. Also available to memorize the setting.

Adjusting the images form personal computers in MENU display

Adjust as below for the following symptoms.

AUTO	HORIZ. POSITION	VERT. POSITION	FINE SYNC.	TRACKING	RGB/Y,Ca,Cr	USER								
AUTO	0	0	0	0	RGB	USER ■								
SXGA70a					Y,Ca,Cr	MEMORIZE ■								
USER1						DELETE ■								
USER2						RESET ■								
<table border="1"> <tr> <td>SIGNAL</td> <td>PICTURE</td> <td>PinP/EXPAND</td> <td>PC CARD/AUTO PLAY</td> <td>AUDIO</td> <td>INSTALLATION</td> <td>OPTION</td> <td>Ver.</td> </tr> </table>							SIGNAL	PICTURE	PinP/EXPAND	PC CARD/AUTO PLAY	AUDIO	INSTALLATION	OPTION	Ver.
SIGNAL	PICTURE	PinP/EXPAND	PC CARD/AUTO PLAY	AUDIO	INSTALLATION	OPTION	Ver.							

Image moves to right or left :

Adjust HORIZ. POSITION in SIGNAL menu. Press the ∨ button on the control panel (or ▼ button on the remote control) to move the image to left. Press the ∧ button on the control panel (or ▲ button on the remote control) to move the image to right.

Image moves to up or down :

Adjust VERT. POSITION in SIGNAL menu. Press the ∨ button on the control panel (or ▼ button on the remote control) to move the image to upward. Press the ∧ button on the control panel (or ▲ button on the remote control) to move the image to down.

Image flickers / Image is out of focus :

Adjust FINE SYNC. in SIGNAL menu.

SIGNAL - USER							
CLAMP POSITION	CLAMP WIDTH	HORIZ. PIXELS	VERT. LINES	PLL	VERT. SYNC.	HOLD	
33	33	3333	3333	AUTO	AUTO	AUTO	ON - BEGIN END
▼	▼	▼	▼	FAST	ON	OFF	▲ ▲
				NORMAL	OFF		33 33
				SLOW			▼ ▼

Wide stripes appear :

Adjust CLAMP POSITION or CLAMP WIDTH of each menu in SIGNAL - USER menu.

Noise etc. appears on right or left side of image:

Adjust HORIZ. PIXELS of the menu in SIGNAL - USER menu.

Noise etc. appears on top or bottom part of image :

Adjust VERT. LINES of the menu in SIGNAL - USER menu.

Top part of image curves :

Change the setting of PLL or HOLD of the menu in SIGNAL - USER menu.

PLL Select FAST, NORMAL, or SLOW for image which top part is the least curved. Select AUTO for normal setting.

HOLD ... Select ON, and adjust BEGIN or END for image which top part is the least curved.

Image does not move naturally :

Adjust VERT. SYNC. of the menu in SIGNAL - USER menu. Select AUTO for normal setting.

- Do not change each menu setting in SIGNAL - USER menu for normal setting.

Memorizing the setting

- Select MEMORIZE in SIGNAL menu, and press ENTER button.
- Press the > button on the control panel (or ► button on the remote control).
- Press the ∧ or ∨ buttons on the control panel (or ▲ or ▼ buttons on the remote control) to select the memory which you wish to record (USER 1 or USER 2)
- Press ENTER button.

Initializing the setting which has been changed

Select RESET in SIGNAL menu, and press ENTER button.

- While initializing, buttons do not work about 2 - 18 seconds. Use them to operate after initializing is finished.

Seeing images in recorded setting.

Select AUTO in SIGNAL menu, and press the ∧ or ∨ buttons on the control panel (or ▲ or ▼ buttons on the remote control) to select the memory (USER1 or USER2).

Resetting the recorded setting

- Select DELETE in SIGNAL menu, and press ENTER button.
- Press the > button on the control panel (or ► button on the remote control).
- Press the ∧ or ∨ buttons on the control panel (or ▲ or ▼ buttons on the remote control) to select the memory which you wish to reset (USER 1 or USER 2).
- Press ENTER button
The recorded setting will be deleted.

The simple way of adjustment

- Horizontal position:
Adjust the start position (the left end) using HORIZ. POSITION, and adjust the end position (the right end) using TRACKING. Then repeat these steps.
- Vertical position:
Adjust the start position using VERT. POSITION.

Specification of RGB signals in each computer mode of the projector

Signal mode	resolution (H x V)	horizontal frequency (kHz)	Vertical frequency (Hz)	Normal (H x V)	Native (H x V)
TV60	–	15.73	59.94	1024 x 768	(640 x 480)
TV50	–	15.63	50.00	1024 x 768	(640 x 480)
HiVision	–	33.75	60.00	1024 x 576	(882 x 496)
PC98	640 x 400	24.82	56.42	1024 x 640	640 x 400
CGA70	640 x 400	31.47	70.09	1024 x 640	640 x 400
CGA84	640 x 400	37.86	84.13	1024 x 640	640 x 400
CGA85	640 x 400	37.86	85.08	1024 x 640	640 x 400
VGA60	640 x 480	31.47	59.94	1024 x 768	640 x 480
VGA72	640 x 480	37.86	72.81	1024 x 768	640 x 480
VGA75	640 x 480	37.50	75.00	1024 x 768	640 x 480
VGA85	640 x 480	43.27	85.01	1024 x 768	640 x 480
SVGA56	800 x 600	35.16	56.25	1024 x 768	800 x 600
SVGA60	800 x 600	37.88	60.32	1024 x 768	800 x 600
SVGA72	800 x 600	48.08	72.19	1024 x 768	800 x 600
SVGA75	800 x 600	46.88	75.00	1024 x 768	800 x 600
SVGA85	800 x 600	53.67	85.06	1024 x 768	800 x 600
XGA43i	1024 x 768	35.52	86.96	1024 x 768	1024 x 768
XGA60	1024 x 768	48.36	60.00	1024 x 768	1024 x 768
XGA70	1024 x 768	56.48	70.07	1024 x 768	1024 x 768
XGA75	1024 x 768	60.02	75.03	1024 x 768	1024 x 768
XGA85	1024 x 768	68.68	85.00	1024 x 768	1024 x 768
SXGA70a	1152 x 864	63.85	70.01	1024 x 768	1024 x 768
SXGA75a	1152 x 864	67.50	75.00	1024 x 768	1024 x 768
SXGA85a	1152 x 864	77.49	85.06	1024 x 768	1024 x 768
SXGA60a	1280 x 960	60.00	60.00	1024 x 768	1024 x 768
SXGA75a	1280 x 960	75.00	75.00	1024 x 768	1024 x 768
SXGA43i	1280 x 1024	46.43	86.87	960 x 768	1024 x 768
SXGA60	1280 x 1024	63.98	60.02	960 x 768	1024 x 768
SXGA75	1280 x 1024	79.88	74.94	960 x 768	1024 x 768
SXGA85	1280 x 1024	91.15	85.02	960 x 768	–
UXGA48i	1600 x 1200	62.50	96.08	1024 x 768	–
UXGA60	1600 x 1200	75.00	60.00	1024 x 768	–
UXGA65	1600 x 1200	81.25	65.00	1024 x 768	–
UXGA70	1600 x 1200	87.50	70.00	1024 x 768	–
UXGA75	1600 x 1200	93.75	75.00	1024 x 768	–
UXGA80	1600 x 1200	100.00	80.00	1024 x 768	–
UXGA85	1600 x 1200	106.25	85.00	1024 x 768	–
MAC13	640 x 480	35.00	66.67	1024 x 768	640 x 480
MAC16	832 x 624	49.72	74.55	1024 x 768	832 x 624
MAC19	1024 x 768	60.15	74.91	1024 x 768	1024 x 768
MAC21	1152 x 870	68.59	74.96	1024 x 768	1024 x 768
HP75	1024 x 768	62.94	74.92	1024 x 768	1024 x 768
HP72	1280 x 1024	78.13	72.00	960 x 768	1024 x 768
SUN66a	1152 x 900	61.85	66.00	984 x 768	1024 x 768
SUN76a	1152 x 900	71.81	76.64	984 x 768	1024 x 768
SUN66	1280 x 1024	71.68	66.68	960 x 768	1024 x 768
SUN76	1280 x 1024	81.13	76.11	960 x 768	1024 x 768
SGI72	1280 x 1024	76.92	72.30	960 x 768	1024 x 768
SGI76	1280 x 1024	82.00	76.00	960 x 768	1024 x 768
IBM60	1280 x 1024	63.42	60.00	960 x 768	1024 x 768

- *1 : As a result of line reduction in the projection process with the computer models listed above, lines and portions of characters found in the original data may be missing from the projected image.
- When the ZOOM MODE of PinP/EXPAND menu is set to 4, by pressing the EXPAND button on the remote control, it will switch to the screen displaying the picture as its original size (real screen display). In the real screen display, pictures will be black-framed when picture resolution is lower than 1,024 x 768.

Important:

- Some computers may not be compatible with the projector.
- The projector's maximum resolution is 1,024 x 768 pixel. It may not be displayed correctly for the pictures of higher resolutions than 1,024 x 768.
- The picture with a SYNC on G (Green) signal may vibrate.
- The picture with a SYNC on G (Green) signal may be tinged with green.

Picture adjustment (continue)

GAMMA CORRECTION menu

The proportion of the brightness of input signals to that of output signals can be corrected effectively by adjusting GAMMA.

1. Select GAMMA CORRECTION of PICTURE menu and then press the ENTER button. (The GAMMA CORRECTION menu appears on-screen display.)

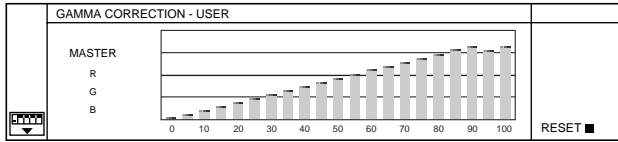

Horizontal axis: brightness of the input signals
Vertical axis: brightness of the output signals
Inclination: GAMMA

2. Press the < or > buttons on the control panel (or ◀ or ▶ buttons on the remote control) to select MASTER.

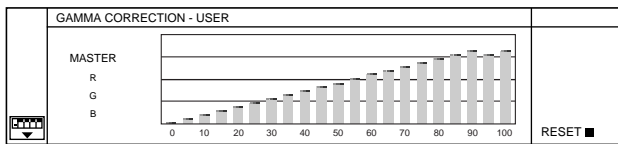

3. Press the < or > buttons on the control panel (or ◀ or ▶ buttons on the remote control) to select the points brightness of the input signals.

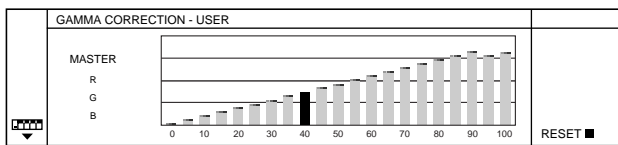

4. Press the ^ or v buttons on the control panel (or ▲ or ▼ buttons on the remote control) to adjust the brightness of the output signals.

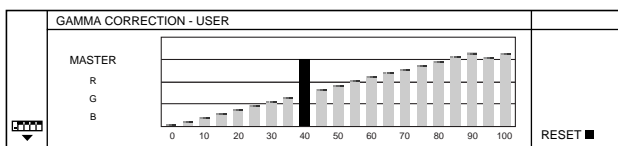

5. Repeat steps 3 and 4 for another point setting.

If you wish to change the color balance, follow the steps below.

6. Press the < or > buttons on the control panel (or ◀ or ▶ buttons on the remote control) to select MASTER, and then press the ^ or v buttons on the control panel (or ▲ or ▼ buttons on the remote control) to select the desired color R, G or B.

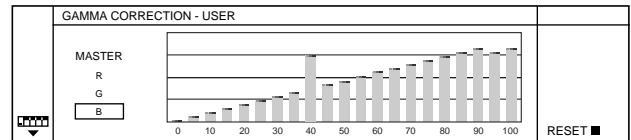

7. Press the < or > buttons on the control panel (or ◀ or ▶ buttons on the remote control) to select the points brightness of the input signals.

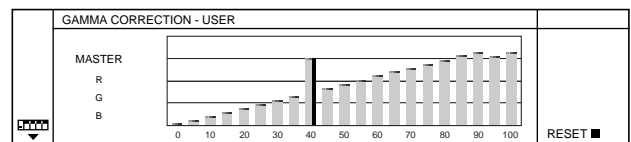

8. Press the ^ or v buttons on the control panel (or ▲ or ▼ buttons on the remote control) to adjust the brightness of the output signals.

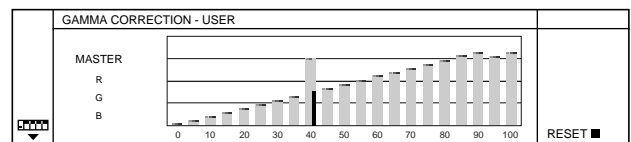

9. Repeat steps 7 and 8 for another point setting.

10. Press the ENTER button.

11. Exit the menu system by pressing the MENU button several times.

- To switch back to the default condition of GAMMA CORRECTION, select RESET and press the ENTER button when the GAMMA CORRECTION display appears.
- When selecting RESET, the buttons cannot be operated for 2 to 18 seconds.

Advanced feature for presentation

Cursor operation

1. Press the CURSOR button.
The cursor appears on the screen.
2. Press the START/STOP button to ON.
The operation indicator will be illuminated.
(The operation indicator will turn off if the remote control is not used for a period of five minutes.)
3. Move the cursor by using the remote control.

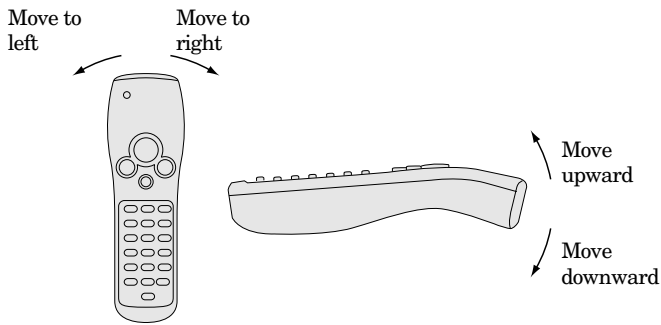

4. Press the START/STOP button to momentarily freeze the cursor movement. Press again to resume moving.
 5. Press the CURSOR button to cause the cursor to disappear.
- When using the EXPAND mode, a red frame will not appear if the cursor is selected.

To change the cursor size or the cursor moving speed

1. Press the CURSOR button.
The cursor appears on the screen.
2. Press the START/STOP button to ON.
The operation indicator will be illuminated.
3. Press the DOUBLE CLICK button.
The tool icon appear on the screen.

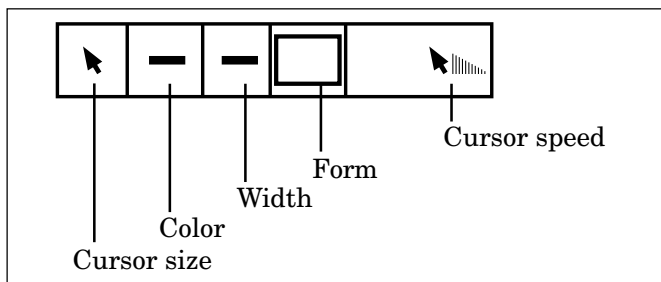

4. Move the cursor to where the point of cursor size icon.
5. Press the SELECT button until the desired size is appeared.
6. Move the cursor to where the point of cursor speed icon.
7. Press the SELECT button until the desired speed is appeared.



8. Press the DOUBLE CLICK button.

To draw line or frame

1. Press the CURSOR button.
The cursor appears on the screen.
2. Press the START/STOP button to ON.
The operation indicator will be illuminated.
3. Press the DOUBLE CLICK button.
The tool icon appear on the screen.
4. Move the cursor to where the point of form icon.
5. Press the SELECT button until the desired form is appeared.

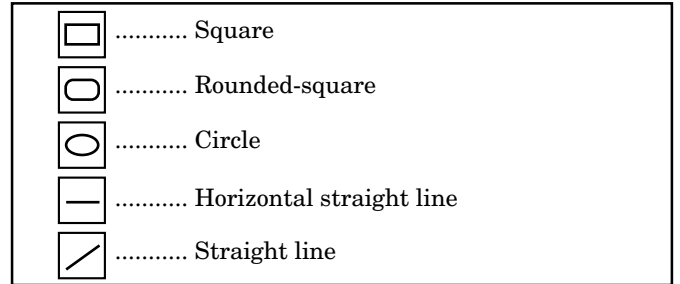

6. Move the cursor to where the point of Width icon.
7. Press the SELECT button until the desired width of the line is appeared.
8. Move the cursor to where the point of Color icon.
9. Press the SELECT button until the desired color of the line is appeared. (Red, Yellow, Green, Blue, Purple, Black or White)
10. Press the DOUBLE CLICK button.
11. Position the cursor where you want the path to begin and press the SELECT button.
A red frame appears on the screen..
 - The red frame will be disappeared by pressing the CANCEL button.
12. Move the cursor to where you want the point of the opposite corner and press the SELECT button again.

- By pressing the CANCEL button, the line or frame will disappear.
- When the MENU appears, the cursor will disappear.
- When the cursor appears, the source ID will disappear.
- You can not adjust the zoom/focus in the cursor operation mode.
- When using the EXPAND mode, a red frame will not appear if the cursor is selected.
- The currently projected image will disappear in the following cases: when PC card images are updated, when alternating PinP or EXPAND mode, or when display size is enlarged or otherwise altered.

Still

How to stop the picture temporarily (still picture)

1. Press the ENTER/STILL button on the remote control.
The picture will stop temporarily.

To stop still picture.

2. Press the ENTER/STILL button on the remote control again.
- To release the still picture, Cursor, SELECT, DOUBLE CLICK, CANCEL, and START/STOP buttons also can be used.

Super impose (Picture in Picture)

One of the special features of this unit is the picture-in-picture (PinP) mode. PinP allows you to view different sources at the same time. The sub image will become a still picture.

1. Press the PinP button on the remote control.
 - Pressing the PinP button repeatedly will select on and off.
2. Select the desired external input source of the sub image by using the RGB, VIDEO or CARD button.
 - You can change the frame position and the frame size by using the on-screen menu.

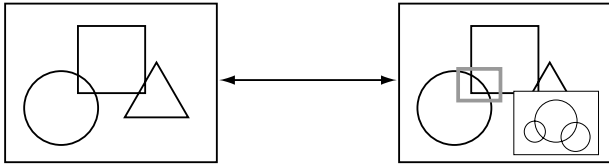

To recapture the picture of sub screen

- 3 Press the - or + button.
 - By each press of the button will recapture the picture of sub screen.

To switch Main image and sub image

- 4 Press the < or > buttons on the control panel (or ◀ or ▶ buttons on the remote control).

To switch still picture and playback picture between Main image and Sub image

- 5 Press the ^ or v buttons on the control panel (or ▲ or ▼ buttons on the remote control) .

6. Press the PinP button on the remote control. The sub image will be disappear.

- In PinP mode, the sub image will become still pictures. When the main image is set to PC1 or PC2, the sub image will become moving pictures.
- In PinP mode, the sound of the moving pictures will be heard.
- The sub image may vibrate. If this is the case, select the image again by pressing the '-' button.
- In PinP mode you cannot adjust the zoom/focus.
- Adjusting contrast, brightness, tint or color isn't available in PinP mode.
- To use different PC card (PC card 1, PC card 2) on both Main image and Sub image is not available.
- When the main and sub images are set to PC1 or PC2, images can be selected only from the same group of the same PC-CARD.
- By setting the AUTO PIP on the PinP/EXPAND menu to ON, the position of the sub image will move automatically when the red frame indicating the EXPAND area overlap with the sub image.

Expand

By pressing the EXPAND button on the remote control, you can view the detailed image of the picture.

Setting the Expand mode

1. Press the MENU button once to display the on-screen menu.
2. Press the < or > buttons on the control panel (or ◀ or ▶ buttons on the remote control) to select PinP/EXPAND.
3. Press the ^ or v buttons on the control panel (or ▲ or ▼ buttons on the remote control).
4. Press the < or > buttons on the control panel (or ◀ or ▶ buttons on the remote control) to select ZOOM MODE, POSITION or SIZE.
5. Press the ^ or v buttons on the control panel (or ▲ or ▼ buttons on the remote control) to set the ZOOM MODE, POSITION or SIZE.

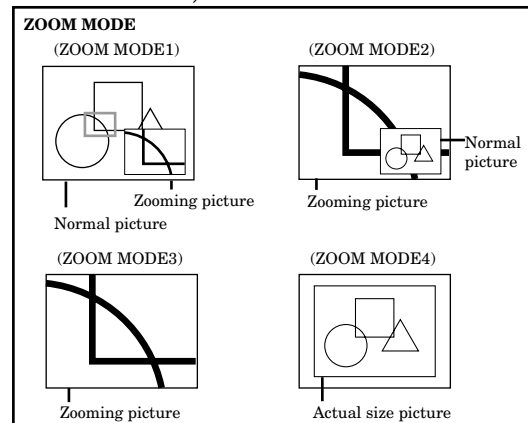

6. Press the MENU button twice to exit the menu system.

Using the Expand mode

1. Press the EXPAND button.
 - A red frame indicating EXPAND area will appear.
 - You can magnify different areas of the active picture by pressing the ^, v, < or > buttons on the control panel (or ▲, ▼, ◀ or ▶ buttons on the remote control).
 - You can change the magnification of the zoomed area by pressing the + or - buttons.
2. Press the EXPAND button again.

- In EXPAND mode, do not display the test pattern.
- In EXPAND mode (except in type 4 mode) you cannot adjust the zoom/focus.
- Display enlargement does not work with video input or S-video input.
- The red frame indicating EXPAND area will disappear when the cursor is selected.

Indication Mode 4 (actual size display)

- Pressing the ^, v, <, > buttons on the control panel (or ▲, ▼, ◀, ▶ buttons on the remote control) is for adjusting fine adjust, zoom or focus.
- The expanding rate cannot be changed either pressing + or - button.

PC-CARD

The projector can play back an image by using the PC-CARD.

Using the PC-CARD

Use only the flash memory card of PCMCIA•ATA compatible type II.

- Due to PC-CARD type, some images can not be properly recorded. Please contact your dealer.

Setting up the PC-CARD

1. Set the projector into standby mode by pressing the main power switch. The POWER indicator lights up red.
2. Open PC-CARD cover on the left side of the projector.
3. Make sure the PC card is going to be inserted in right side. The PC card indicator of the PC card which has been inserted will illuminate.
4. Close the cover.

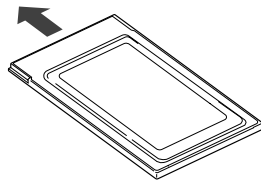

When the input source is set to PC1 or PC2, or during recording to the PC card, do not remove the PC card. The projector may not work correctly.

Release the PC-CARD

1. Press the RELEASE button on the remote control. PC card eject icon will be displayed on the right end of the screen. The PC card indicator will turned off on the projector.
 2. Open PC-CARD cover on the left side of the projector.
 3. Press the eject button to take the card out.
 4. Close the cover.
- Upon removing a PC card, wait at least 2 seconds before inserting another.
 - When the input source is set to PC1 or PC2, or during recording to the PC card, do not remove the PC card. The projector may not work correctly.
 - When having an access of PC card, PC card eject prohibit icon will be displayed on the right end of the screen.
 - If you do not wish this icon to be indicated, turn ICON on PC CARD menu to OFF. In this case, the icon appears when the RELEASE button is pressed even the setting is OFF.
 - PC card eject icon will be indicated till the card is ejected. If you press the RELEASE button when PC cards are inserted, you need to either take both out or change one of the cards to the icon to disappear.
 - PC-CARD of the following manufacturers has been confirmed of operation; EPSON, TDK, Logitech, Panasonic, Verbatim, I-O DATA.

Play back

1. Insert the prerecorded PC-card.
2. Press the CARD button repeatedly until PC-1 (or PC-2) appear on the screen.
The PC-CARD index display appears on the screen.
3. Press the < or > buttons on the control panel (or ◀ or ▶ buttons on the remote control) to select the desired image.
 - If the PC-CARD is recorded by using the personal computer, select the desired group by pressing the + or - button.
4. Press the ^ or v button on the control panel (or ▲ or ▼ button on the remote control) to enter the image display mode.
5. Press the < or > buttons on the control panel (or ◀ or ▶ buttons on the remote control) to display another image.
6. Press the VIDEO or RGB buttons to quit the PC-CARD playback function.
7. Press the RELEASE button on the remote control.
8. Press the eject button to take the card out.

- During PC-CARD playback, the sound is switched off.
- Noise may occur momentarily when images are updated via PC card.
- The images recorded in BMP (not compressed) will take a long time to playback.
- It takes about 10 seconds to playback JPEG compressed data.
- When having an access of PC card as you want to exchange images on PC card, there will be four red line indicated at the edge of the screen.
- When the main and sub images are set to PC1 or PC2, images can be selected only from the same group of the same PC-CARD. Other group or other card will not be able to indicate simultaneously.
- If the PC card is ejected when playing back PC card, the image will be switched to Video 1 picture automatically.
- During PC-CARD playback, if the incorrect display appears, release and re-insert the PC-CARD.

Playback picture taken by the digital camera

- The image which has been recorded in PCMCIA/ATA card, smart media or compact flash can be playback. The PC card adapter is required to playback smart media and compact flash.
- Depending on the type of the digital camera, picture will not appear correctly. Please contact your dealer.
- PC card recorded by Digital Camera, the picture will not be displayed on PC-CARD index display.

PC-CARD (Continue)

To automatically change the image, follow the steps as shown below.

1. Press the MENU button.

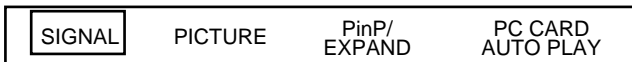

2. Press the < or > buttons on the control panel (or ◀ or ▶ buttons on the remote control) to select PC CARD AUTO PLAY.

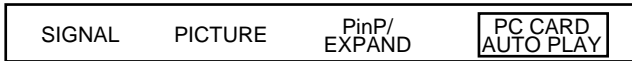

3. Press the ^ or v buttons on the control panel (or ▲ or ▼ buttons on the remote control).

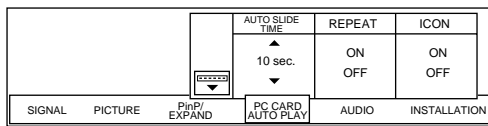

4. Press the < or > buttons on the control panel (or ◀ or ▶ buttons on the remote control) to select AUTO SLIDE TIME.

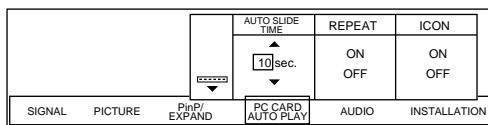

5. Press the ^ or v buttons on the control panel (or ▲ or ▼ buttons on the remote control) to set the time for auto playback.

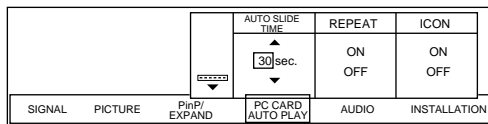

6. Press the < or > buttons on the control panel (or ◀ or ▶ buttons on the remote control) to select REPEAT.

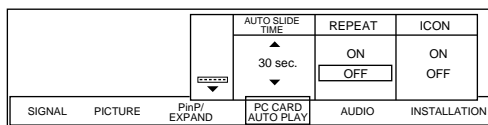

7. Press the ^ or v buttons on the control panel (or ▲ or ▼ buttons on the remote control) to select ON or OFF.

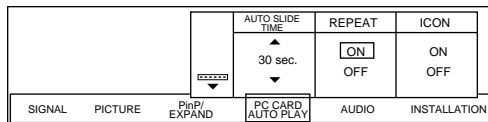

8. Press the MENU button twice to exit the menu system.

9. Press the CARD button repeatedly until PC-1 (or PC-2) appear on the screen.

10. Press the < or > buttons on the control panel (or ◀ or ▶ buttons on the remote control) to select the desired image.

11. Press the AUTO PLAY button on the remote control.

The image automatically changes according your setting.

12. Press the AUTO PLAY button on the remote control to quit the PC-CARD automatic playback function.

- A gray frame will appear during auto play.
- Button operation will only work when the gray frame appears on screen. Button operation is not possible while the red frame is on-screen.
- When projecting images in 2-screen display mode, the screen will momentarily go black when images inputted via PC card are updated.
- Auto play can be stopped by pressing any button (including SELECT, DOUBLE CLICK, CANCEL, and START/STOP).
- Auto play cannot be used either during image enlargement or when menus are displayed.

Advanced feature with PC

There are three types of application software provided.

1. PCV (PC Card Viewer)
2. PCGC (Personal Computer Graphic Controller)
3. SpacePointer (Driver for PC control by the remote controller)

Environment

The following system software and hardware are necessary to use the projector.

When you use Macintosh

- Macintosh series loading more than 68030 in CPU and a video card with which more than 256 colors are available
- System7.1 or newer
- 8MB of Random-access memory (RAM) space

When you use Microsoft® Windows®

- Microsoft® Windows® 95 Operating System (Windows 95) or Microsoft® Windows NT® Operating System Version 4.0 (Windows NT) or Microsoft® Windows® Operating System Version 3.1 (Windows 3.1) with the CPU loading more than 80486SX and a display card with more than 256 colors are available
- 16MB or more of RAM available
- We recommend the following hardware.
 - 32MB or more of RAM available
 - A video display card with full colors are available

EXPORT LAW ASSURANCES

You acknowledge and agree that the SOFTWARE is subject to restrictions and controls imposed by the United States Export Administration Act (the "Act") and the regulations thereunder. You agree and certify that neither the SOFTWARE nor any direct product thereof is being or will be acquired, shipped, transferred or reexported, directly or indirectly, into any country prohibited by the Act and the regulations thereunder or will be used for any purpose prohibited by the same.

LIMITATIONS OF REMEDIES

Regardless of whether any remedy set forth herein fails of its essential purpose, in no event will InFocus be liable to you for any special, consequential, indirect or similar damages, including any lost profits or lost data arising out of the use or inability to use the SOFTWARE or any data supplied therewith even if InFocus or anyone else has been advised of the possibility of such damages, or for any claim by any other party.

Some states do not allow the limitation or exclusion of liability for incidental or consequential damages so the above limitation or exclusion may not apply to you.

In no case shall InFocus's liability exceed the price for the SOFTWARE.

A. PCV (PC Card Viewer)

PC-CARD viewer (PCV) is a utility software that lets you record and project an image to a PC-CARD by using a personal computer.

Installation of software

For Windows 95 or Windows NT

1. Start up Windows.
2. Insert the Projector driver CD-ROM into your CD-ROM drive.
3. Start up Program Manager.
Click the [Start] button and select the [Run (R)] command. Then the [Run] dialog box is displayed.
4. If you inserted the CD-ROM to drive D, type [D: Win95\Pcv\Us\Setup95] (Windows 95) or [D: Winnt40\Pcv\Us\Setupnt] (Windows NT) in the "command line" text box and click the "OK" button. The letter [D] may be different according to the drive you use.
5. When the setup program starts up, follow the on-screen instructions.
6. When the message "Completed" appears on screen, click the [Finish] button to complete the installation.
 - Installation of Microsoft Internet Explorer 3.02 (or later) is required for optimum unit operation. Use the Jaaxdist.exe command should the unit appear to not be performing normally.

For Windows 3.1

1. Start up Windows.
2. Insert the Projector driver CD-ROM into your CD-ROM drive.
3. Select the [Run (R)] command on the icon menu so that the dialog box [Run] is displayed.
4. If you inserted the CD-ROM to drive D, type [D:Win31\Pcv\Us\Setup] in the "command line" text box and click the "OK" button. The letter [D] may be different according to the drive you use.
5. When the setup program starts up, follow the on-screen instructions.
6. When the message "completed" appears on screen, click the [OK] button to complete the installation.

For Macintosh

1. Start up Macintosh.
2. Insert the Projector driver CD-ROM into your CD-ROM drive.
3. Copy "PCV for Mac" file in the "PCV" folder to anywhere on the hard disk.

Starting up PCV (For Windows)

For Windows 95 or Windows NT

1. Start up Windows.
2. Insert the PC card to the PC Card slot on the personal computer.
3. Start up Program Manager.
Click the [Start] button and select the [Program (P)]→[Pcv]→[PCV]command.

For Windows 3.1

1. Start up Windows.
2. Insert the PC card to the PC Card slot on the personal computer.
3. Double click the [PCV] icon in the PCV folder.

Command reference (For Windows 95 or Windows NT)

The command references are as shown below:

File

- New presentation Create a new presentation.
- Open presentation... Opens an existing presentation.
- Close presentation ... Closes an opened presentation.
- Save presentation Saves an opened presentation using the same name.
- Save presentation As... Saves an opened presentation to a specified name.
- Delete presentation . Delete an opened presentation.
- Exit Exits PCV.

Edit

- Cut Deletes selected image from the presentation and moves it to the clipboard.
- Copy Copies selected image data from the presentation to the clipboard.
- Paste Pastes image data from the clipboard into the presentation.

Image

- Add image
- Image file... Inserts image file to an opened presentation.
- Screen capture... .. Captures screen and inserts it to an opened presentation.
- Delete image... Deletes the selected image from an opened presentation.
- Image information... Displays information of the selected image.

View

- Tool Bar Shows or hides the toolbar.
- Drive Bar Shows or hides the drivebar.
- Status Bar Shows or hides the status bar.

Window

- Cascade Arranges windows in an overlapped fashion.
- Tile Horizontal Arranges windows in non-overlapped horizontal tiles.
- Tile Vertical Arranges windows in non-overlapped vertical tiles.
- Arrange Icons Arranges icons of closed windows.
- Windows 1, 2, Goes to specified window.

Help

- Help Topics Offers you an index to topics on which you can get help.
- Advanced settings Displays a detail setting of this application.
- About PCV... Displays the version information of this application.

Command reference (For Windows 3.1)

The command references are as shown below:

File

- New presentation Create a new presentation.
- Open presentation... Opens an existing presentation.
- Close presentation... Closes an opened presentation.
- Save presentation... . Saves an opened presentation using the same name.
- Delete presentation... Delete an opened presentation.
- Open image file... Import an image from a file.
- Exit Exits PCV.

Edit

- Cut Deletes selected image from the presentation and moves it to the clipboard.
- Copy Copies selected image data from the presentation to the clipboard.
- Paste Pastes image data from the clipboard into the presentation.

Tool

- Capture Captures screen and inserts it to an opened presentation.
- Delete image... Deletes the selected image from an opened presentation.

View

- Tool Bar Shows or hides the toolbar.
- Status Bar Shows or hides the status bar.

Option

- Select card drive... .. Select (or change) the PC-CARD drive.
- Card drive info... Display the information of the selected PC-CARD drive.
- Index image size... .. Select the size of index image.

Help

- About PCV... Displays the version information of this application.

Recording the image (For Windows)

When you wish to record the image of the display to a PC-CARD.

1. Choose the PC-CARD drive using the drive bar under the status bar.

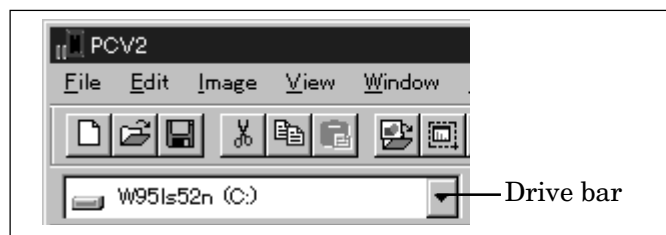

- If you are using Windows 3.1, select 'Select card drive' in Option menu of PCV main window.
2. Choose [New presentation...] under the [File] menu.
The new presentation window will open.
 3. Choose [Add image] under the [Image] menu and then choose [Screen capture...].
 - The PCV windows disappear and the capture dialog box appears.

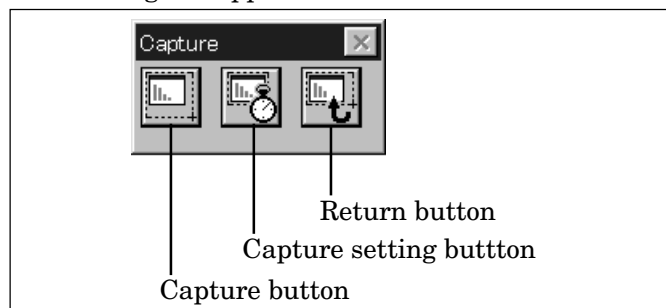

- If you are using Windows 3.1, select 'Image capture...' in TOOL of PCV main window.
4. Display the image you wish to record on the screen.
 5. Click the capture button.
The Compress setting window appears.



6. Select the compress type.
 - You can confirm the compressed image by clicking the Preview button.
 - If the command [Preserving the setting] is checked, you don't need to set the style of save by each images (Not Windows 3.1).
7. Click OK button.
8. Repeat steps 4 to 7 for other images.

9. Click the return button.
The presentation window will open. The recorded image appears on the presentation window.



- Depending on the personal computer, the recorded image can appear incorrectly. In this case, set the delay time longer by using the Capture setting dialog box.
10. Choose [Save presentation...] under the [File] menu.
 - A presentation which has been recorded already, Select "Save As..." to save as.
 11. Choose [Exit] under the [File] menu to quit from PCV.

When you wish to record the image from existing files.

1. Choose the PC-CARD drive using the drive bar under the status bar.
 - If you are using Windows 3.1, select 'Select card drive' in Option menu of PCV main window.
2. Choose [New presentation...] under the [File] menu.
The new presentation window will open.
3. Choose [Add image] under the [Image] menu and then choose [Image file...].
 - If you are using Windows 3.1, select 'Open image file' in File menu of PCV main window.
4. Select the image you wish to record.
5. Click OK button.
The recorded image appears on the presentation window.

- The maximum number of group (presentation) that can be recorded to a PC card is 160.
- The maximum number of the images that can be recorded to a group is 99.

6. Repeat steps 3 to 5 for other images.
7. Choose [Save presentation...] under the [File] menu.
8. Choose [Exit] under the [File] menu to quit from PCV.

Editing the presentation (For Windows)

Delete the image

1. Select the image to be deleted.
2. Choose [Delete image...] under the [Image] menu.
 - If you are using Windows 3.1, choose [Delete image...] under the [Tool] menu.

Sequencing

A. Exchange images

You can exchange the images among images next to each other.

1. Select an image to be exchanged.
2. Drag the image and drop on the next or previous image.

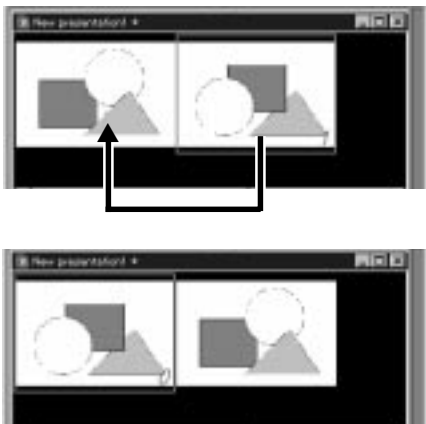

B. Move images

You can move images to another position.

1. Select an image to be moved.
2. Drag the image and drop it on the other image (except next or previous image).
The image will be moved to the previous position of the dropped image.

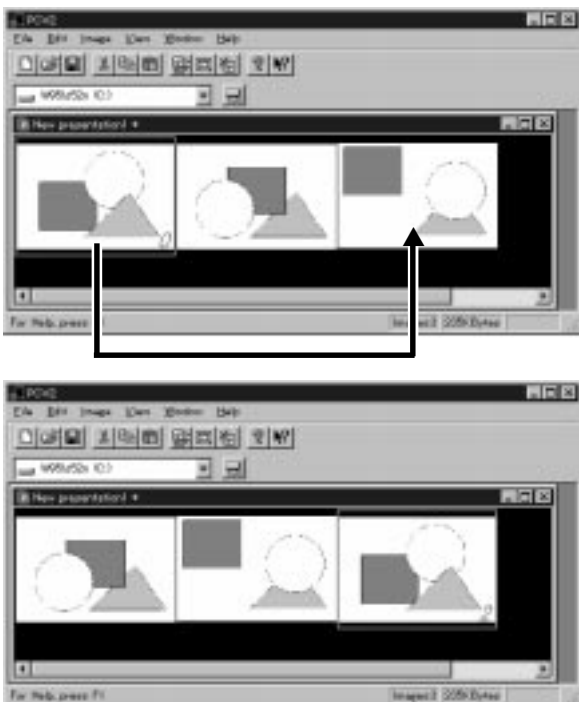

Preview an image

1. Double click the image.
The preview image appears on the displays.
2. Click the image by using the left button of the mouse.



Display image information

1. Choose [Image information] under the [Image] menu.
The image information window appears.
 - If you are using Windows 3.1, choose click the image by using the right button of the mouse.



2. Choose OK to close the image information window.

How to save a file which has been made by a presentation software (For Windows 95 only)

1. Make up a presentation by the presentation software.
2. Choose [Print] under the [File] menu.
3. Set to PCV driver for printing name.

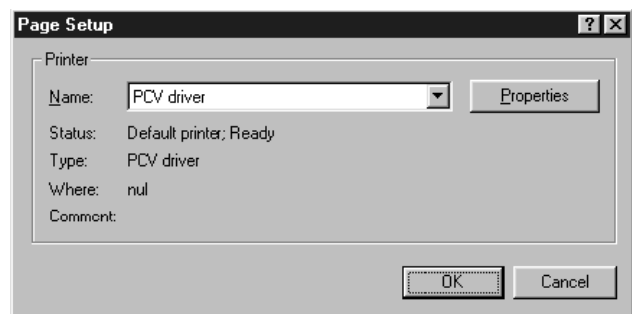

- PCV drive will automatically be installed in the system of the personal computer when PCV is installed.

- Click the properties button.



- If necessary, set the Resolution, Expand, File Format or JPEG Quality.
- Click OK button on the PCV driver Properties dialog box.
- Click OK button.
- Choose the PC-CARD drive.
- Click OK button.
 - The presentation data will be saved as PCVdrv on PC card.
 - PCVdrv is a temporary file. If you record presentation continuously, the previous data will be erased. Please follow as below to re-name the file.
- Boot up PCV's programme.
- Choose [Open presentation...] under the [File] menu.
- Select PCVdrv file

The presentation window will open and the recorded image appears on the presentation window.
- Choose [Save presentation As...] under the [File] menu.
- Choose [Exit] under the [File] menu to quit from PCV.

Starting up PCV (For Macintosh)

- Start up Macintosh.
- Insert the PC card to the PC Card slot on the personal computer.
- Double click the [PCV for Mac] icon.

Command reference

The command references are as shown below:

File

- Create New presentation . Create a new presentation.
- Open presentation... Opens an existing presentation.
- Close presentation ... Closes an opened presentation.
- Save presentation Saves an opened presentation using the same name.
- Delete presentation . Delete an opened presentation.
- Open image file... Import an image from a file.
- Done Exits PCV.

Edit

- Cut Deletes selected image from the presentation and moves it to the clipboard.
- Copy Copies selected image data from the presentation to the clipboard.
- Paste Pastes image data from the clipboard into the presentation.
- Clear... Deletes the selected image from an opened presentation.

Option

- Preference... Select the format BMP or JPEG.
- Get Screen Shot Image Captures screen and inserts it to a presentation.

Recording the image (For Macintosh)

When you wish to record the image of the display to a PC-CARD.

- Display the image you wish to record on the screen.
- Press the shift button, command button and number 3 button simultaneously.
- Repeat steps 1 and 2 for other images.
- Choose [Get Screen Shot Image] under the [Option] menu.

The presentation window will open. The recorded image appears on the presentation window..

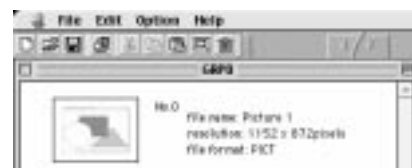

- The file type to be recorded are BMP or JPEG. To change file type, select [Preference] under the [Option] menu then change setting. Reboot PCV.
- Choose [Save presentation...] under the [File] menu.
 - Choose [Done] under the [File] menu to quit from PCV.

Advanced feature with PC (Continue)

When you wish to record the image from existing files.

1. Choose [Create New presentation...] under the [File] menu.
The new presentation window will open.
2. Select 'Open image file' in File menu of PCV main window.
3. Select the image you wish to record.
4. Click OK button.
The recorded image appears on the presentation window.
5. Choose [Save presentation...] under the [File] menu.
6. Choose [Done] under the [File] menu to quit from PCV.

Editing the presentation (For Macintosh)

Delete the image

1. Select the image to be deleted.
2. Choose [Clear] under the [File] menu.

Sequencing

A. Exchange images

You can exchange the images among images next to each other.

1. Select an image to be exchanged.
2. Drag the image and drop on the next or previous image.



B. Move images

You can move images to another position.

1. Select an image to be moved.
2. Drag the image and drop it on the other image (except next or previous image).
The image will be moved to the previous position of the dropped image.

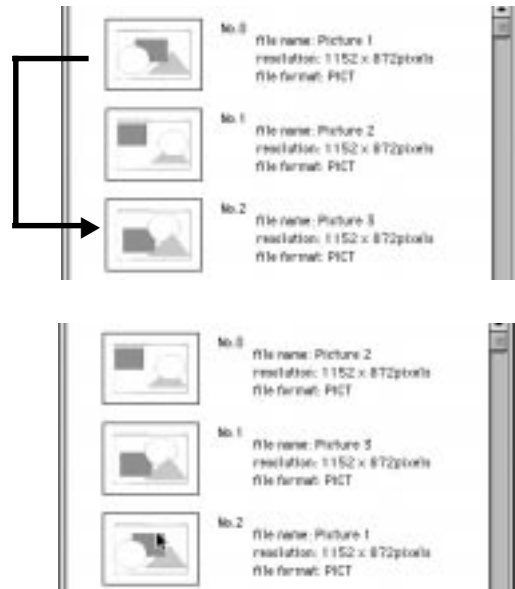

Preview an image

1. Select an image to be previewed.
2. Double click the image.
The preview image appears on the displays.

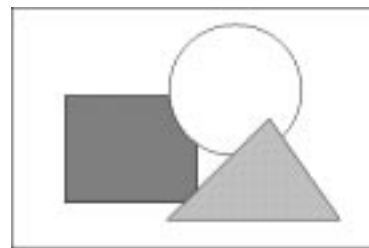

B. PCGC (Personal Computer Graphic Control)

By connecting to personal computer is RS-232C port, you can operate your computer with the projector remote control. Also you can set the menu setting of the projector by computer.

Connection

Projector + IBM PC or IBM PC compatibles (DOS/V)

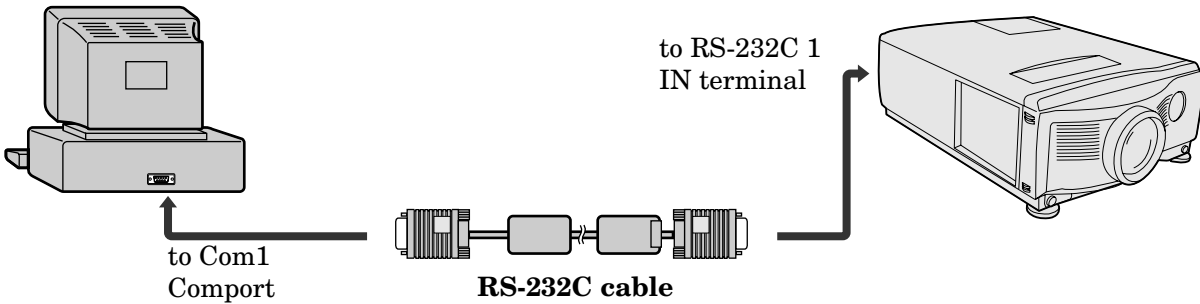

Note: If your PC (IBM or IBM compatible) is equipped only with a 25-pin serial port connector, a 25-pin serial port adapter is required. Contact your dealer for details.

Projector + Macintosh

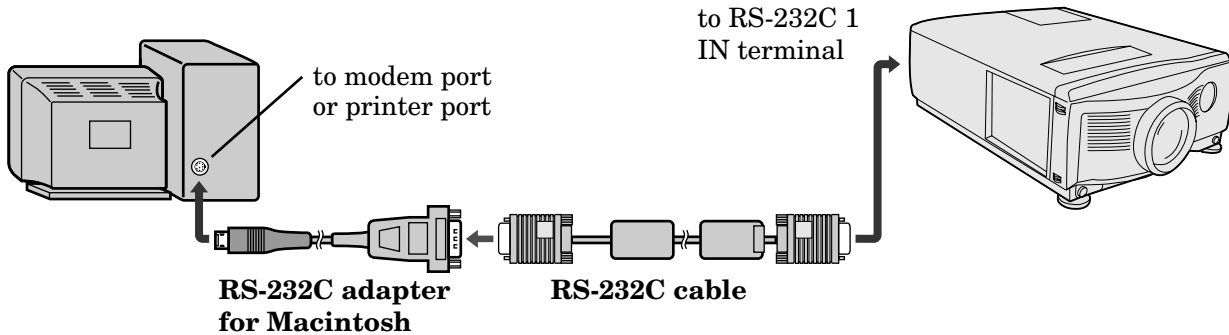

Note: If the only serial port is a "modem/printer", use it.

Projector + NEC PC 98 series

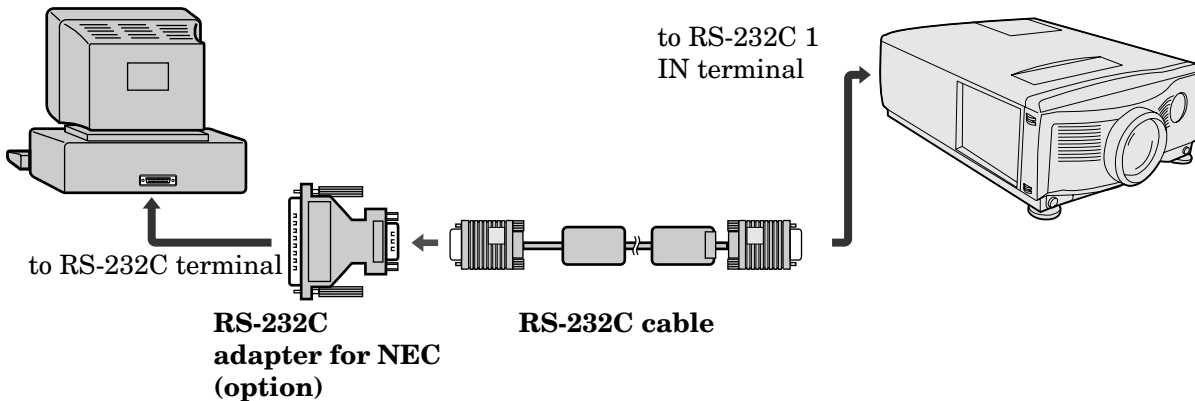

C. SpacePointer

The remote control provides remote PC operation for presentation from PC.

Connection

Projector + IBM PC or IBM PC compatibles (DOS/V)

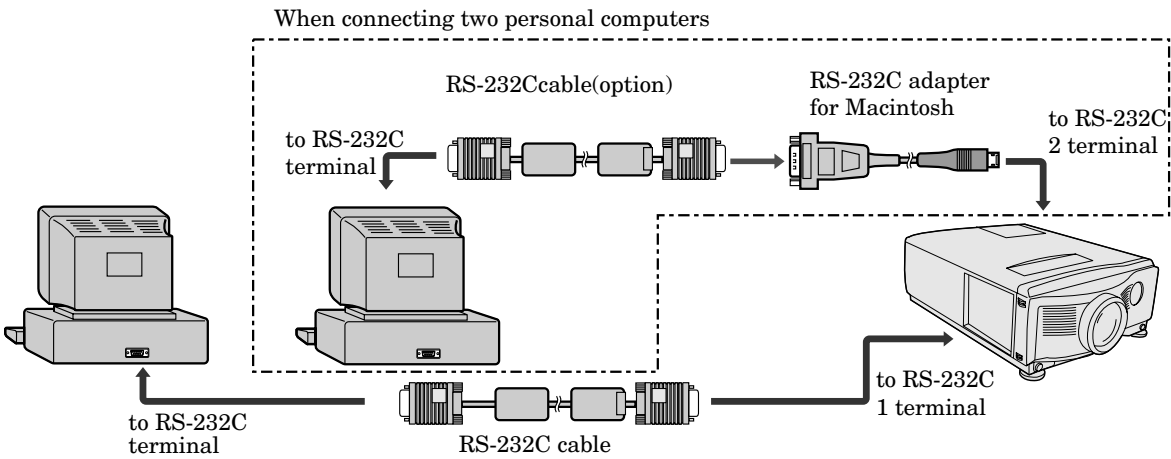

Note: If your PC (IBM or IBM compatible) is equipped only with a 25-pin serial port connector, a 25-pin serial port adapter is required. Contact your dealer for details.

Projector + Macintosh

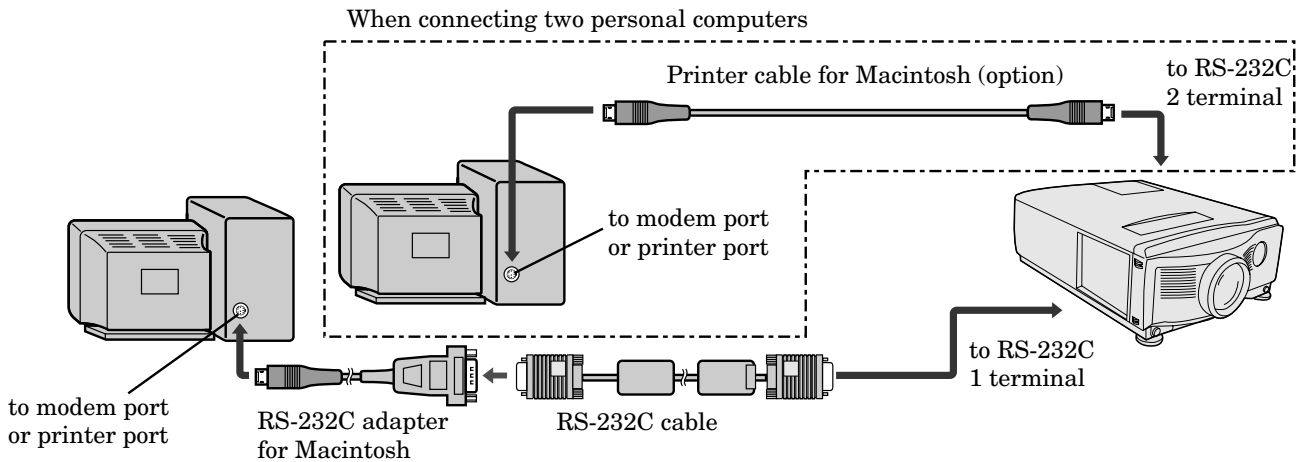

Note: If the only serial port is a “modem/printer”, use it.

Projector + NEC PC 98 series

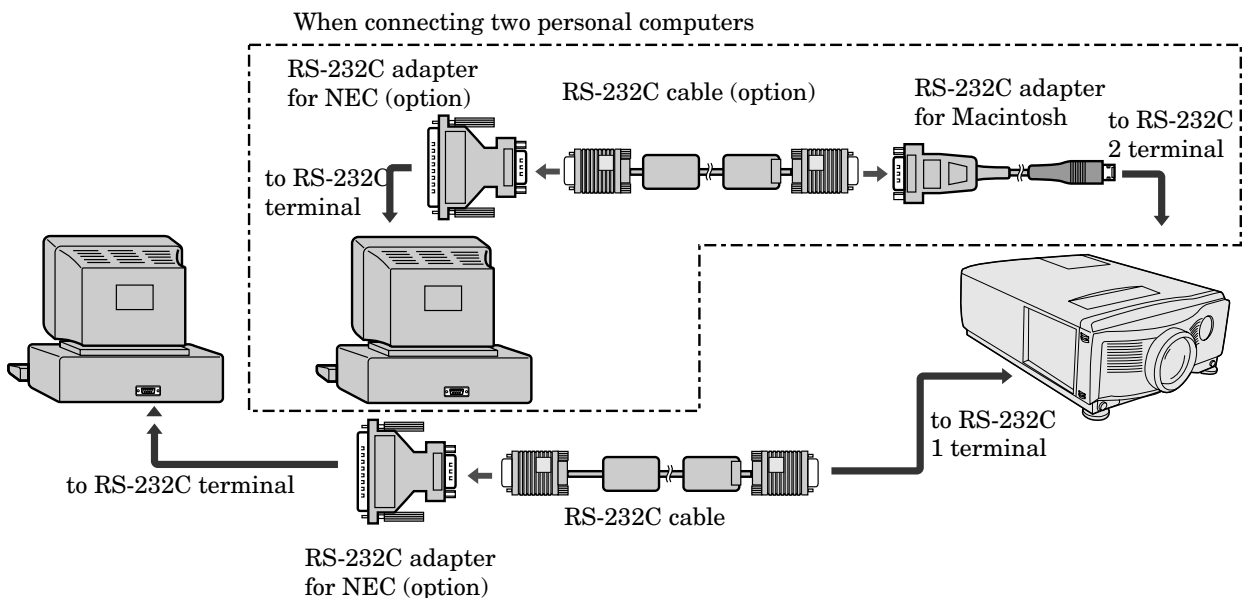

Installation of software

For Windows 95

1. Start up Windows.
2. Insert the Projector driver CD-ROM into your CD-ROM drive.
3. Start up Program Manager.
Click the [Start] button and select the [Run (R)] command. Then the [Run] dialog box is displayed.
4. If you inserted the CD-ROM to drive D, type [D:\Win95\Sp\Setup] in the "command line" text box and click the "OK" button. The letter [D] may be different according to the drive you use.
5. When the setup program starts up, follow the on-screen instructions.
6. When the message "Completed" appears on screen, click the [Finish] button to complete the installation.

For Windows 3.1

1. Start up Windows.
2. Insert the Projector driver CD-ROM into your CD-ROM drive.
3. Select the [Run (R)] command on the icon menu so that the dialog box [Run] is displayed.
4. If you inserted the CD-ROM to drive D, type [D:\Win31\Sp\install] in the "command line" text box and click the "OK" button. The letter [D] may be different according to the drive you use.
5. Select the [Installation (I)] command on the installation menu.
6. When the setup program starts up, follow the on-screen instructions.
7. When the message "completed" appears on screen, click the [OK] button to complete the installation.

For Macintosh

1. Start up Macintosh.
2. Insert the Projector driver CD-ROM into your CD-ROM drive.
3. Copy "Alps RSSPointer" file in the "US" folder of the "SpacePointer" folder to the system folder.
4. Restart the Macintosh.

Operation of PC by remote control

The remote control provides remote PC operation for presentation from PC.

1. Press the RGB button to select RGB1 or RGB2.
 2. Press the START/STOP button to ON.
The operation indicator will be illuminated.
 3. Confirm that the cursor of the projector does not appear on the screen. If the cursor does appear, press the CURSOR button to OFF.
You can use the SELECT, CANCEL and DOUBLE CLICK button in the same way as the button on the mouse. You can also move the cursor of PC by using the remote control. For cursor moving, see page 25.
 4. Press the START/STOP button to exit from PC control mode.
- Depending on the personal computer, SpacePointer may not work after leaving from the suspended mode. In this case, click the Apply button on the control panel. See below.

Setting of SpacePointer

For Windows

You can set the several settings in the SpacePointer control panel in the control panel folder.

- Mouse cursor size and color cannot be adjusted in the Windows 3.1.

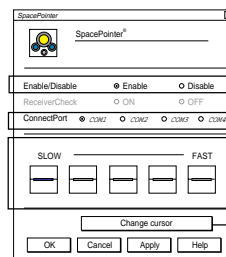

Enable/Disable

For normal use set to Enable. If you do not use SpacePointer, set to Disable.

Port selection

Used to select the port connected to the projector.

Tracking speed

If you click Fast, the cursor moves more than twice as fast as you move the space pointer. When you first try the remote control, set it to slow.

Size/color

Changes the size and color of the mouse cursor.

For Macintosh

You can set the several settings in the Alps RSSPointer control panel in the control panel folder.

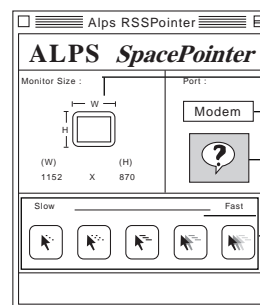

Monitor size

Port selection

Used to select the port connected to the projector.

Help

Tracking speed

If you click Fast, the cursor moves more than twice as fast as you move the space pointer. When you first try the remote control, set it to slow.

Uninstallation of software

For Windows 95

1. Start up Windows.
2. Insert the Projector driver CD-ROM into your CD-ROM drive.
3. Start up Program Manager.
Click the [Start] button and select the [Run (R)] command. Then the [Run] dialog box is displayed.
4. If you inserted the CD-ROM to drive D, type [D:Win95\Sp\Spuninst] in the "command line" text box and click the "OK" button. The letter [D] may be different according to the drive you use.
5. When the installation program starts up, follow the on-screen instructions.
6. When the message "Completed" appears on screen, click the [Finish] button to complete the installation.

If you use the Windows 3.1

1. Start up Windows.
2. Insert the Projector driver CD-ROM into your CD-ROM drive.
3. Select the [Run (R)] command on the icon menu so that the dialog box [Run] is displayed.
4. If you inserted the CD-ROM to drive D, type [D:Win31\Sp\install] in the "command line" text box and click the "OK" button. The letter [D] may be different according to the drive you use.
5. Select the [Uninstallation (U)] command on the installation menu.
6. When the setup program starts up, follow the on-screen instructions.
7. When the message "completed" appears on screen, click the [OK] button to complete the uninstallation.

For Macintosh

1. Start up Macintosh.
2. Move "Alps RSSPointer" in the control panel folder in the system folder to "Trash".
3. Restart the Macintosh.

Replacement of a light source lamp

The light source lamp is designed to project the image on the LCD panel. When the light source lamp no longer functions, replace it with a new one to ensure optimum performance.

Caution:

- Do not remove the light source lamp from inside of this equipment immediately after using the projector, you may get burned because of the high temperature of the light source lamp.
- When you replace the light source lamp, press the power button to power off, then wait for 120 seconds in stand-by mode to cool down the lamp and LCD panels. Turn off the main switch, unplug the power cord from the outlet and wait one hour so that the lamp is cool to the touch.
- Do not remove the light source lamp except for replacement. Careless treatment can cause injury or fire.
- Do not touch the lamp directly. It may be broken and may cause you to injure or burn yourself.
- Be sure not to drop the lamp lid screw into the projector. Also be sure also not to insert metal or any flammable objects, it may cause fire or an electric shock. If any objects are inserted, please unplug and contact your dealer.
- Install the lamp securely, failure to do so it may cause a fire.

1. Loosen the screw of the lamp lid on the top cover using a screwdriver (+), and remove the lid.

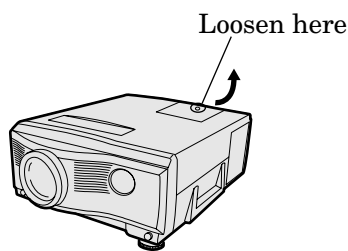

Important:

Be careful not to damage the electric wire connected to this equipment.

2. Loosen a screw (a) of fixing metal using a screwdriver (+), and remove them. Do not lose the fixing metal and screws.

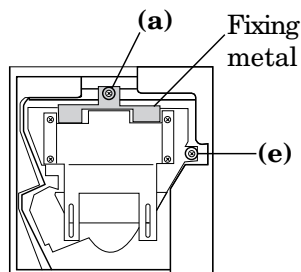

3. Set Lamp exchanging metal into the projector.
 - 1) Insert metal fittings for lamp replacement in the following positions: on the front face of the lamp (2 positions), between the lamp, and on the bottom edges (4 positions).
 - 2) Align screw holes (c) with node (d).
 - 3) Fasten the piece into place using the two screws included (b, b').

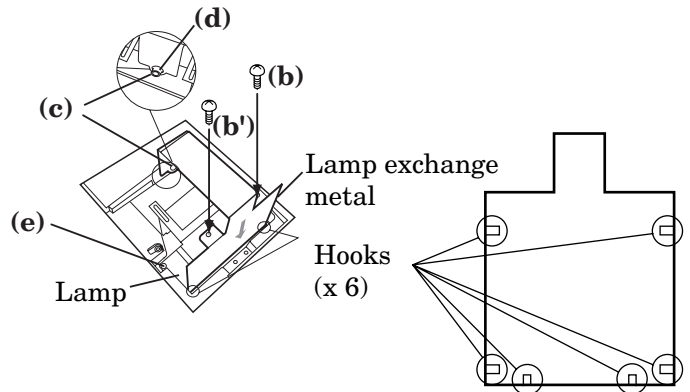

4. Loosen the lamp fixing screw (e) using a screwdriver (+), and remove it.

5. Hold onto the projector by the handle as you pull out the lamp.

For the lamp you have removed, do not spill liquid on it, place it near flammable objects or where children can touch it. Otherwise, it will cause injury or fire.

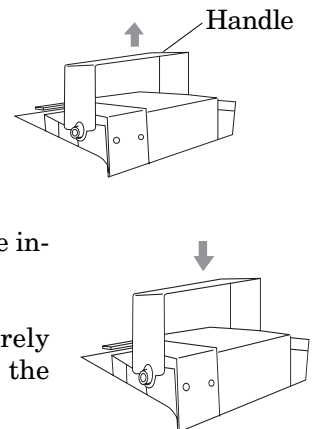

6. Insert the new lamp securely into the projector body in the right direction.

7. Tight up the screws (e) which have been removed in 4 using a screwdriver (+).

8. Loosen the two screws (f), (f') of lamp exchanging metal using a screwdriver, and remove them with the metal.

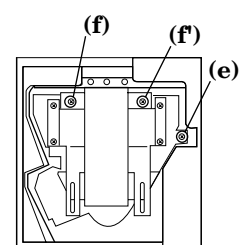

9. Remove the holes from the lamp replacement metal fittings (c) from the node (d).

10. Insert the fixed metal pieces from step 2 into the screw holes (f) and (f'), and use one screw (a) to hold the piece in place.

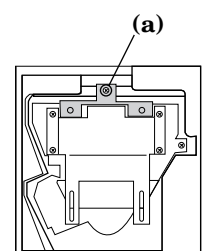

11. Tighten up the screw of the lamp lid using a screwdriver (+).

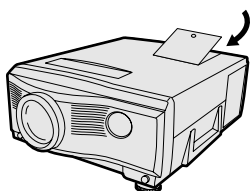

How to reset the operation time meter

Plug in the power cord, switch on the projector and reset lamp time by pressing the <, > and POWER buttons simultaneously.

- Lamp cannot be removed from the projector unless setting the lamp exchanging metal.
- If you do not have the lamp exchanging metal, remove the metal from the new lamp and use it. Do not touch the lamp directly. It may be broken and may cause you to injure or burn or yourself.

Caution:

- For the lamp you have removed, do not spill liquid on it, place it near flammable objects or where children can touch it. Otherwise, it will cause injury or fire.
- Be sure that the projector guide is firmly inserted between the right and left lamp guides. Do not touch the lamp directly, place a cloth over the replacement lamp.

Important:

- The projector will not turn on if you do not secure the lamp lid.
- The operation time meter must be reset after the lamp has been replaced.
- Do not reset the operation time meter unless the lamp has been replaced.

The life of the lamp

The average life of the lamp for the projector is about 1,000 hours of consecutive use. Life span may differ according to operating environment, and may be shorter than 1000 hours. Decreases in luminescence and/or color brightness will indicate that the light source lamp is in need of replacement. When lamp operation time exceeds 1,000 hours, the indicator will flash alternately between green and red (while the lamp is in operation; when the lamp is not in operation, the indicator will appear red only). When the lamp has been used for about 1,250 hours, the message “LAMP!!.” will appear on the screen. When the lamp has been used for about 1,300 hours, the projector will automatically shut off for the safety of the lamp and the power indicator light up in red. The projector cannot be used until the lamp has been replaced.

Caution:

- The light source lamp is fragile. Be careful not to cut yourself with the fragments.
- The lamp life depends on the environment. For replacement lamps, please contact your dealer.

The projector automatically shuts off when the lamp is used up in about 1,300 hours and not used until lamp replacement.

Maintenance

Caution:

Be sure to turn off the projector and unplug the power cord from the wall outlet before you perform any maintenance on the projector.

Cleaning the air-filter

Clean the air-filter frequently. If the filter or ventilation slots become clogged with dirt or dust, the temperature inside of the projector may rise and shut off the power (the thermal indicator starts to blink red).

1. Press and raise the air-filter cover with a screwdriver (-).

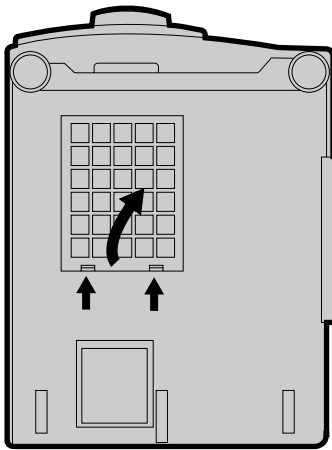

2. Wash the air-filter.

Use water or a mild detergent diluted with water to clean the filter. Rinse the filter thoroughly and let it dry completely. If the filter is damaged or becomes extremely dirty, contact your dealer for replacement information.

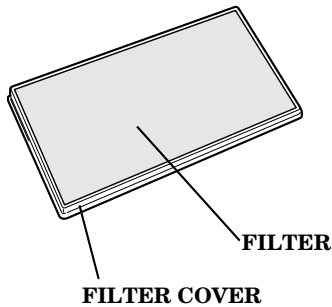

3. Attach the air filter to the cover.
4. Reinstall the air-filter cover.

Note: The power will not turn on if the air-filter cover is improperly installed.

Caution:

Be sure to use the projector with an air-filter. If not, dust may get inside the projector, causing a fire or a breakdown.

Cleaning the projector and the ventilation slots

Use a soft cloth to clean the projector and the ventilation slots. When the slots become dirty, wipe them with a soft cloth dampened with a diluted mild detergent, and then wipe them with a dry cloth.

To protect the surface of the projector from fading or deteriorating:

- Do not spray insecticide on or inside the projector.
- Do not use benzine or thinner to clean it.
- Do not let rubber or plastic materials come into contact with the projector.

Cleaning the lens

Use a standard lens-cleaning brush or a piece of lens tissue dampened with lens cleaning fluid. The lens surface is fragile. Use only recommended, nonabrasive lens-cleaning materials. Do not touch the lens with your fingers.

Troubleshooting

The following offers solutions to some of the common problems you may encounter. We suggest that you consult this chart before contacting your dealer.

PROBLEMS	CAUSE	POSSIBLE SOLUTIONS
The power is off.	<ul style="list-style-type: none"> The air intake vents, exhaust vents or air filter is clogged with dust or some object. <p>Power indicator does not light up.</p> <ul style="list-style-type: none"> Power cord is unplugged from the outlet. Power cord is disconnected from the projector. The main switch is turned off. The lamp lid is open. <p>Power indicator blinks red.</p> <ul style="list-style-type: none"> The projector has been turned on again too soon after having been turned off. When the power switch was turned off while the fan was running, during or after lamp operation. The room temperature is too high. (Does the lamp indicator show an unusual condition?) Lamp is no longer working. <p>Power indicator blinks between red and green.</p> <ul style="list-style-type: none"> The filter cover is not closed. When the power source lamp indicator or the temperature indicator is either on or blinking, the main unit requires repairs. 	<ul style="list-style-type: none"> Remove the object. Plug the power cord into the outlet. Insert the power cord into the projector. Turn the main switch on. Close the lamp lid. Wait for the lighting sequence. Turn the power switch on and off several times. Refer to "Indicators" on page 44. Replace the lamp with a new one. Close the cover correctly. Contact your dealer.
No picture appears on the screen.	<ul style="list-style-type: none"> Lens is covered by lens cap. When the power source lamp indicator or the temperature indicator is either on or blinking, the main unit requires repairs. The equipment connected to this projector is not turned on. Hookup is not made correctly with other equipment. The input source is not selected correctly. 	<ul style="list-style-type: none"> Take the lens cap off. Replace the lamp with a new one. Turn on the connected equipment. Confirm the hookup. Select the correct source according to the equipment connected to this projector.
The image is distorted.	<ul style="list-style-type: none"> The projector is not at a right angle to the screen. 	<ul style="list-style-type: none"> Adjust the angle of the projector to make a right angle to the screen. See page 11.
The image is dark.	<ul style="list-style-type: none"> Brightness, tint and color are not adjusted correctly. 	<ul style="list-style-type: none"> Adjust brightness, tint and color correctly.
The image is blurred.	<ul style="list-style-type: none"> The projecting distance is beyond the focused area. Lens is dirty. Screen size exceeds screen size specifications. Brightness, contrast are not adjusted correctly. FINE adjustment is not made correctly. Tracking is not adjusted. The projector is not at a right angle to the screen. 	<ul style="list-style-type: none"> Adjust the projecting distance. See page 10. Clean lens. Reduce screen size to within 40" to 300". Adjust brightness, contrast. Make FINE adjustment. Adjust tracking. Adjust the angle of the projector to make a right angle to the screen. See page 11.
The image remains blurred.	<ul style="list-style-type: none"> When you see the stationary image for a long time, it may remain on the screen if you change the image. It is not a breakdown. The blurred image will disappear in a few minutes. 	
Red, blue or green dots are viewed on the text of image.	<ul style="list-style-type: none"> It is normal. 	
The image is distorted on the screen and noise is heard.	<ul style="list-style-type: none"> The cable for connection with other equipment is not plugged securely into the terminal. The projector is installed too close to other equipment. 	<ul style="list-style-type: none"> Plug the connecting cable securely into the terminal. See pages 12-15. Install the projector far away from other equipment.
No sound is heard.	<ul style="list-style-type: none"> Volume is not turned up. Mute function on PCGC is on. Connection to other equipment is not made correctly. 	<ul style="list-style-type: none"> Turn up the volume. Cancel the mute function. See page 20. Check connections. See pages 12-15.
Nothing is displayed on the PC monitor.	<ul style="list-style-type: none"> The PC monitor is not turned on. 	<ul style="list-style-type: none"> Turn on the monitor.
Warm air comes out of the exhaust vents.	<ul style="list-style-type: none"> This is typical of the LCD projector. 	
Adjustments cannot be made.	<ul style="list-style-type: none"> The operation is incorrectly made due to noise or interference. 	<ul style="list-style-type: none"> Press the MENU and POWER buttons simultaneously. See page 18.

Indicators

The projector has three indicators each of which shows the working condition of the projector.

The following offers solutions to possible problems. If a problem persists, turn the projector off and consult your dealer.

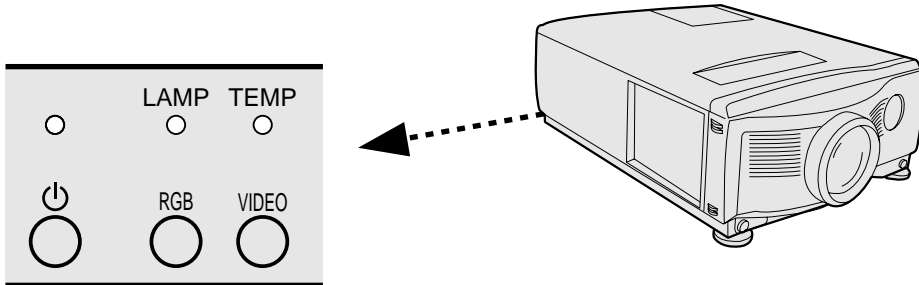

INDICATOR	SHOWS	CONDITION	POSSIBLE SOLUTIONS
TEMP INDICATOR	blinking red	<ul style="list-style-type: none"> Unusual temperature The power is turned off and the POWER indicator lights up red. The ventilation slots or air filter is clogged with dust or debris. The fan has stopped due to an impediment. 	<ul style="list-style-type: none"> Remove the object from the ventilation slot. Pull out the power plug and remove the object. If you cannot, consult your dealer. Relocate the projector to a cooler place. Clean the filter.
		<ul style="list-style-type: none"> The location temperature is too high. The filter is dirty. 	
LAMP INDICATOR	Steady green	Normal	-
	Blinking red/green or Blinking red	Lamp is almost used up.	Replace the lamp. Exchange with a new lamp if the same problem recurs.
	Steady red	<ul style="list-style-type: none"> Lamp is used up. The power is not turned on. (Power indicator lights up red.) 	
POWER INDICATOR	Steady red	Standby	-
	Steady green	Power-on	-
	Blinking red/green or Blinking red	<ul style="list-style-type: none"> The filter cover is not closed. (When the TEMP indicator and the LAMP indicator are off.) Abnormal (When the TEMP indicator or the LAMP indicator steady on or blinking.) 	<ul style="list-style-type: none"> Close the cover correctly. Contact your dealer.

Specifications

Type	LCD projector
Model	LP1200
Rated power supply	AC100 ~ 240V, 50 / 60Hz
Rated input	5.0A
LCD panels	1.3-inch LCD panel: 3 pieces (for R, G, B) Pixels 1,024 × 768 = 786,432 pixels Total 2,359,296 pixels Active pixel rate: 99.99 % or more (each panel)
Projection lens	F 2.3~2.7 f = 53.3 ~ 69.3 mm
Light source lamp	330 W DC metal halide lamp
Picture size	aspect ratio 4:3 40~300 inch
Audio output	1 W + 1 W stereo
Speakers	6 cm round type (8Ω 1W) × 2 pcs.
S-video input	Luminance signal: 1.0 Vp-p 75Ω (negative sync.) Chroma signal: 0.286 Vp-p 75Ω (burst signal)
Video input	1.0 Vp-p 75Ω (negative sync.)
Audio inputs	350 mVrms, 10kΩ or more
Analog RGB input (mini D-SUB 15P)	RGB: 0.7Vp-p 75Ω (positive sync.) YC _B CR: Y:1.0Vp-p (negative sync.) C _B CR:0.7Vp-p HD/CS : TTL level (positive) VD : TTL level (positive)
PC audio inputs	350 mVrms, 10kΩ or more ø3.5mm stereo mini jack
Control connector	Serial (D-SUB 9 pin male connector) RS-232C standards Serial (Mini DIN 8 pin female connector) RS-232C standards
Outside dimensions	330 × 145 × 398 mm Legs and lenses are not included. (width × height × depth)
Weight	21.5 lb (9.8kg)
Length of power code	114 inch (2.9m)
Temperature, humidity (performance guarantee)	+41°F (+5°C) ~ +95°F (+35°C), 30~90%

Replacement parts list

What's included in the box

1 RCA video cable	246C323-10	1 MAC adaptor for RS-232C cable	246C321-10
1 Audio cable	242C938-10	1 Remote control	939P746-40
1 RCA/BNC adaptor	452C036-30	1 User's manual	871D219-90
1 RGB cable for PC	246C318-10	1 Software (CD-ROM)	919P095-10
1 MAC adaptor for RGB cable	246C319-20	2 Battery for remote	–
1 RS-232C cable	246C320-10	1 AC power cable	246C346-10

Limited warranty

In Focus, Inc. (“In Focus”) warrants that each LP1200 (“the Product”) sold hereunder will conform to and function in accordance with the written specifications of In Focus. Said limited warranty shall apply only to the first person or entity that purchases the Product for personal or business use and not for the purpose of distribution or resale. The product may contain recycled components that are in new condition. Said warranty shall continue for a period of two (2) years from the date of such purchase. The standard limited warranty excludes the lamps in projectors after 90 days and the accessories after one year. In Focus does not warrant that the Product will meet the specific requirements of the first person or entity that purchases the Product for personal or business use. In Focus’ liability for the breach of the foregoing limited warranty is limited to the repair or replacement of the Product or refund of the purchase price of the Product, at In Focus’ sole option.

To exercise the Purchaser’s rights under the foregoing warranty, the Product must be returned at the Purchaser’s sole cost and expense, to In Focus or to any authorized In Focus service center provided, however, that the Product must be accompanied by a written letter explaining the problem and which includes (i) proof of date of purchase; (ii) the dealer ‘s name; and (iii) the model and serial number of the Product. When sending your unit in for repair, please ship your unit in its original packing material or an In Focus approved ATA Shipping Case, or have a professional packaging company pack the unit. Please insure your shipment for its full value. A return authorization number, issued by the In Focus customer service department, must also be clearly displayed on the outside of the shipping carton containing the Product.

WARRANTY LIMITATION AND EXCLUSION

In Focus shall have no further obligation under the foregoing limited warranty if the Product has been damaged due to abuse, misuse, neglect, accident, unusual physical or electrical stress, unauthorized modifications, tampering, alterations, or service other than by In Focus or its authorized agents, causes other than from ordinary use or failure to properly use the Product in the application for which said Product is intended.

DISCLAIMER OF UNSTATED WARRANTIES

THE WARRANTY PRINTED ABOVE IS THE ONLY WARRANTY APPLICABLE TO THIS PURCHASE. ALL OTHER WARRANTIES, EXPRESS OR IMPLIED, INCLUDING, BUT NOT LIMITED TO, THE IMPLIED WARRANTIES OF MERCHANTABILITY AND FITNESS FOR A PARTICULAR PURPOSE ARE DISCLAIMED. THERE ARE NO WARRANTIES THAT EXTEND BEYOND THE FACE HEREOF AND THE FOREGOING WARRANTY SHALL NOT BE EXTENDED, ALTERED OR VARIED EXCEPT BY WRITTEN INSTRUMENT SIGNED BY IN FOCUS. LIMITATION OF LIABILITY IT IS UNDERSTOOD AND AGREED THAT IN FOCUS’ LIABILITY WHETHER IN CONTRACT, IN TORT, UNDER ANY WARRANTY, IN NEGLIGENCE OR OTHERWISE SHALL NOT EXCEED THE RETURN OF THE AMOUNT OF THE PURCHASE PRICE PAID BY PURCHASER AND UNDER NO CIRCUMSTANCES SHALL IN FOCUS BE LIABLE FOR SPECIAL, INDIRECT OR CONSEQUENTIAL DAMAGES OR LOST PROFITS, LOST REVENUES OR LOST SAVINGS. THE PRICE STATED FOR THE PRODUCT IS A CONSIDERATION IN LIMITING IN FOCUS’ LIABILITY. NO ACTION, REGARDLESS OF FORM, ARISING OUT OF THE AGREEMENT TO PURCHASE THE PRODUCT MAY BE BROUGHT BY PURCHASER MORE THAN ONE YEAR AFTER THE CAUSE OF ACTION HAS ACCRUED.

LPTM1200

USER'S
GUIDE

InFocus[®]



APPENDIX

Control this projector by using a personal computer

This projector can be controlled by connecting a personal computer with RS-232C terminal.

Functions can be controlled by a personal computer:

- Turn the ON or OFF
- Changing input signals
- PCGC (button input by remote control)
- Reading warning data

By making a programme, you can also control this projector by a personal computer automatically.

[EXAMPLE]

Time	Movement	Commands to be used (ASCII code)
8:40 a.m.	Turn the power ON	00! <input type="checkbox"/>
	Change input to RGB1	00_r1 <input type="checkbox"/>
0:20 p.m.	Turn the power OFF	00' <input type="checkbox"/>
1:00 p.m.	Turn the power ON	00! <input type="checkbox"/>
3:00 p.m.	Change input to VIDEO1	00_v1 <input type="checkbox"/>
5:20 p.m.	Turn the power OFF	00' <input type="checkbox"/>

- This projector can be controlled by connected equipment (ex. personal computer) if it is connected to RS-232C 1 IN terminal. If the equipments connected to RS-232C 2 IN terminal, this cannot be controlled.

1) Interface

PROTOCOL	RS-232C
BAUD RATE	9600 [bps]
DATA LENGTH	8 [bits]
PARITY BIT	NONE
STOP BIT	1 [bits]

This projector uses RXD, TXD and GND lines for RS-232C control.

For RS-232C cable, the reverse cable should be used.

2) Control command diagram

The command is structured by the address code, function code, data code and end code. The length of the command is different by each function.

	Address code	Function code	Data code	End code
HEX	30h 30h	Function	Data	0Dh
ASCII	'0' '0'	Function	Data	<input type="checkbox"/>

[Address code] 30h 30h (In ASCII code, '0' '0') fixed.

[Function code] A code of each fixed control move

[Data code] A code of each fixed control data (number) and not always indicated.

[End code] 0Dh (In ASCII code, '') fixed.

3) Control sequence

- (1) The command from a personal computer to the projector will be sent in 400ms.
- (2) The projector will send a return command 400ms after it has received an encode. if the command isn't received correctly, the projector will not send the return command.
- (3) The personal computer checks the command and confirms that if the command which has been sent has been executed or not.
- (4) This projector sends various codes, other than the return code. When having a control sequence by RS-232C, reject other codes by the personal computer side.

[Example] Turn the power ON (' is for ASCII code)

Sending commands from the PC etc.	Status code from projector	Meaning
30 30 21 0D '0' '0' '!' '␣'		Command for POWER ON
	30 30 21 0D '0' '0' '!' '␣'	Command received (Command echo back)

4) Operation commands

The operation commands execute the basic operation setting of this projector. It may not operate when changing the signal.

	ASCII	HEX
POWER ON	!	21h
POWER OFF	"	22h
INPUT RGB1	_r1	5Fh 72h 31h
INPUT RGB2	_r2	5Fh 72h 32h
INPUT VIDEO1	_v1	5Fh 76h 31h
INPUT VIDEO2	_v2	5Fh 76h 32h
INPUT CARD1	_c1	5Fh 63h 31h
INPUT CARD2	_c2	5Fh 63h 32h

[Example] Set the input signal to RGB1 (' is for ASCII code)

Sending commands from the PC etc.	Status code from projector	Meaning
30 30 5F 72 31 0D '0' '0' '_' 'r' '1' '␣'		Command for setting the input signal to RGB 1
	30 30 5F 72 31 0D '0' '0' '_' 'r' '1' '␣'	Command received (Command echo back)

5) PCGC commands

The remote control operation can be done by PCGC command codes.

Button's name on remote	ASCII	HEX
POWER	r3c	72h 33h 63h
+ VOLUME	r06	72h 30h 36h
- VOLUME	r07	72h 30h 37h
EXPAND	r02	72h 30h 32h
PinP	r04	72h 30h 34h
▲	r53	72h 35h 33h
▼	r2b	72h 32h 62h
◀	r4f	72h 34h 66h
▶	r59	72h 35h 39h
MENU	r54	72h 35h 34h
ENTER/STILL	r10	72h 31h 30h
FOCUS/ZOOM	r0f	72h 30h 66h
AUTO PLAY	r32	72h 33h 32h
RELEASE	r22	72h 32h 32h
AUTO POSITION	r09	72h 30h 39h

[Example] Display MENU selection bar. (' is for ASCII code)

Sending commands from the PC etc.	Status code from projector	Meaning
30 30 72 35 34 0D '0' '0' 'r' '5' '4' '␣'		Command as same as MENU button
	30 30 72 35 34 0D '0' '0' 'r' '5' '4' '␣'	Command received (Command echo back)

Control this projector by using a personal computer (Continue)

6) Warning commands

Read the recent warning data and the past warning data. The personal computer doesn't attach the data code onto the warning commands to send. On the other hand, the projector which has received a command, attach the warning data as the data code to reply.

	ASCII	HEX
Recent data	En	45h 6Eh
past data	Ep	45h 70h
clear past data	Ec	45h 63h

The recent warning data*

EN* (* is 2 digits, hexadecimal notation)

*(MBS)b1,b2,b3,b4,b5,b6,b7,0(LSB)

b1=Malfunction of the projector.

b2=The lamp is not illuminating.

b3=The lamp cover is not closed.

b4=The filter cover is not closed.

b5=Abnormal temperature (Outside)

b6=Abnormal temperature (the lamp)

b7=Abnormal temperature (Outside)

The past data

Ep* (* is 6 digits, hexadecimal notation)

*(MBS)b1,b2,b3,b4,b5,b6,b7,0(LSB)

b1=Operation time (during boot up '0' / when the power is ON, '1')

b2=Standby power short

b3=Switch power short

b4=Exhausting fan (under the lamp) is stopped.

b5=Inhalation fan is stopped

b6=Exhausting fan (under the liquid cristal) is stopped.

b7=Inhalation fan (Under the power box) is stopped.

b8=The lamp cover is not closed.

b9=The filter cover is not closed.

b10=The temperature sensor is off (Exhausting fan)

b11=The temperature sensor is off (The lamp)

b12=Communication erro between microcomputer

b13=0

b14=Abnormal temperature (the lamp)

b15=Abnormal temperature (outside)

b16=Abnormal temperature (MAIN circulated board)

b17=The lamp is not illuminating.

b18=0

b19=0

b20=0

b21= The life of a lamp

[Example 1] The projector was broken when the warning status was confirmed.

Sending commands from the PC etc.	Status code from projector	Meaning
30 30 45 6E OD '0' '0' 'E' 'n' '↵'		Commnd for confirm resent data
	30 30 45 6E 38 30 OD '0' '0' 'E' 'n' '8' '0' '↵'	Warning command (Malfunction of the projector) carried out

[Example 2]The exhausting fan was broken when the power was ON and the past data of the warning was confirmed.

Sending commands from the PC etc.	Status code from projector	Meaning
30 30 45 70 OD '0' '0' 'E' 'p' '↵'		Commnd for confirm past data
	30 30 45 70 38 38 30 30 30 OD '0' '0' 'E' 'p' '8' '8' '0' '0' '0' '0' '↵'	Warning command (Inhalation fan is stopped when the power is ON) carried out

7) Reading command diagram

Monitor projector operation status. The power ON, OFF and input terminal settings can be monitored.

	ASCII		HEX	
	Function	Data (Receive)	Function	Data (Receive)
POWER ON	vP	1	76h 50h	31h
POWER OFF	vP	0	76h 50h	30h
INPUT RGB1	vI	r1	76h 49h	72h 31h
INPUT RGB2	vI	r2	76h 49h	72h 32h
INPUT VIDEO1	vI	v1	76h 49h	76h 31h
INPUT VIDEO2	vI	v2	76h 49h	76h 32h
INPUT CARD1	vI	c1	76h 49h	63h31h
INPUT CARD2	vI	c2	76h 49h	63h 32h

When a personal computer sends the command, data code will not be attached. On the other hand, the projector which has received a command will attach the recent operating status then send.

[Example] Input was Video 1 when the operating status of the input terminal was confirmed.

Sending commands from the PC etc.	Status code from projector	Meaning
30 30 76 49 0D '0' '0' 'v' 'I' ' ' [↵]		Command for confirm input
	30 30 76 49 76 31 0D '0' '0' 'v' 'I' 'v' '1' ' ' [↵]	Command (Input is Video) carried out

8) Picture adjustment commands

The picture adjustment commands execute the picture adjustment setting of this projector. If the personal computer doesn't send the commands without attaching the data code, the projector which has received the command replays the setting data as data code.

	ASCII	HEX
CONTRAST	P	50h
BRIGHTNESS	Q	51h
TINT	S	53h
COLOR	T	54h

How to set the grade

The data code of CONTRAST and BRIGHTNESS is structured by the setting data of R, setting data of G and setting data of B. Use ASCII letters code to set the grade for setting data. Please refer to the table below for HEX code.

ASCII	'+'	'0'	'1'	'2'	'3'	'4'	'5'	'6'	'7'	'8'	'9'	
HEX	2Bh	2Dh	30h	31h	32h	33h	34h	35h	36h	37h	38h	39h

[Example 1] Set the setting data of R to +10, the setting data of G to 0 and the setting data of B to -5.

Sending commands from the PC etc.	Status code from projector	Meaning
30 30 50 2B 31 30 2B 30 30 2D 30 35 0D '0' '0' 'P' '+' '1' '0' '+' '0' '0' '-' '0' '5' ' ' [↵]		Command for setting the picture control
	30 30 50 2B 31 30 2B 30 30 2D 30 35 0D '0' '0' 'P' '+' '1' '0' '+' '0' '0' '-' '0' '5' ' ' [↵]	Command received (Command echo back)

[Example 2] The TINT was set to +30 when the setting status was confirmed.

Sending commands from the PC etc.	Status code from projector	Meaning
30 30 53 0D '0' '0' 'S' ' ' [↵]		Command for confirm setting of TINT
	30 30 53 2B 33 30 0D '0' '0' 'S' '+' '3' '0' ' ' [↵]	Command (setting of TINT is +30) carried out

LPTM1200

In focus, Inc.
27700B SW Parkway Avenue
Wilsonville, Oregon 97070-9215
1-800-294-6400 • 503-685-8888
Fax: 503-685-8887
<http://www.infocus.com>

In Europe:
Olympia 1 NL-1213 NS
Hilversum, The Netherlands
Phone: (31) 35 6 474 000
Fax: (31) 35 6 423 999

In Asia:
9 Temasek Boulevard
#06-03 Suntec Tower 2
Singapore 038989
Telephone: (65) 334-9005
Fax: (65) 333-4525

InFocus[®]