







Epson PowerLite® S3

User's Guide



	Indicates procedures which may result in damage or injury if sufficient care is not taken.
	Indicates additional information and points which may be useful to know regarding a topic.
	Indicates a page where useful information regarding a topic can be found. Click on the page number to display that page.
	Indicates that an explanation of the underlined word or words in front of this symbol appears in the glossary of terms. Click the underlined word or words to display the corresponding entry in the “Glossary” section of the “Appendices.”  p.70
	Indicates operating methods and the order of operations. The procedure indicated should be carried out in the order of the numbered steps.
[(Name)]	Indicates the name of the buttons on the control panel or the remote control. Example: [Esc] button
“ (Menu Name) ”	Indicates configuration menu items. Example: “Image”- “Brightness”

The terms “this unit” and “this projector” may also refer to the accessories supplied with the projector and other optional products.

Copyright Notice

All rights reserved. No part of this publication may be reproduced, stored in a retrieval system, or transmitted in any form or by any means, electronic, mechanical, photocopying, recording, or otherwise, without the prior written permission of Seiko Epson Corporation. The information contained herein is designed only for use with this Epson product. Epson is not responsible for any use of this information as applied to other products.

Neither Seiko Epson Corporation nor its affiliates shall be liable to the purchaser of this product or third parties for damages, losses, costs, or expenses incurred by purchaser or third parties as a result of: accident, misuse, or abuse of this product or unauthorized modifications, repairs, or alterations to this product, or (excluding the U.S.) failure to strictly comply with Seiko Epson Corporation's operating and maintenance instructions.

Seiko Epson Corporation shall not be liable for any damages or problems arising from the use of any options or any consumable products other than those designated as Original Epson Products or Epson Approved Products by Seiko Epson Corporation.

Epson is a registered trademark of Seiko Epson Corporation.

Epson Connection, Epson Store, and Extra Care are service marks; and PrivateLine, Presenters Club, and PowerLite are registered trademarks of Epson America, Inc.

Pixelworks, DNX, and the DNX logo are trademarks of Pixelworks, Inc.

General Notice: Other product names used herein are for identification purposes only and may be trademarks of their respective owners. Epson disclaims any and all rights in those marks.

Copyright © 2005 by Epson America, Inc.

1/05

Notations Used in This Guide.....	2
Contents	4
Projector Features.....	6
Part Names and Functions.....	8
Front/Top	8
Control Panel	9
Rear	10
Base.....	11
Remote Control.....	12

Adjusting and changing the image

Adjusting the Image Quality	14
Adjusting Computer Images and RGB Video Images	14
Selecting the Projection Type (Color Mode).....	16
Adjusting the Projection Position (Image Shift)	18
Adjusting the Volume	19
Changing the Projected Image (Source Search).....	20
Automatically Detect Incoming Signals and Change the Projected Image (Source Search)	20
Changing Directly from the Remote Control.....	20

Useful Functions

Functions for Enhancing Projection.....	22
Pausing the Image and Sound (A/V Mute).....	22
Freezing the Image (Freeze)	22
Changing the Aspect Ratio (Resizing).....	23
Displaying the Pointer (Pointer)	23
Enlarging Part of the Image (E-Zoom)	24
Using the Remote Control to Operate the Mouse Pointer (Wireless Mouse).....	25

Security functions.....	28
Preventing theft (Password Protect).....	28
Operation Button Lock Function.....	31

Configuration Menu

Using the Configuration Menu	34
List of Functions	35
“Image” Menu	35
“Signal” Menu.....	36
"Settings" Menu	37
“Extended” Menu.....	38
“Info” Menu	40
“Reset” Menu	41

Troubleshooting

Using the Help	43
Problem Solving.....	45
Reading the Indicators.....	45
When the Indicators Provide No Help	48
Where to Get Help.....	56

Appendices

Installation.....	58
Setting Up the Projector	58
Maintenance	59
Cleaning	59
Replacing Consumables	60
Saving a User's Logo	66
Checking Projected Images on an External Monitor (Monitor Output).....	68



Optional Accessories and Consumables.....69

Glossary70

List of ESC/VP21 Commands72

 Command List..... 72

 Cable Layouts 72

List of Supported Monitor Displays.....73

Specifications74

Appearance75

Important Safety Instructions.....76

Epson America, Inc. Limited Warranty78

Index.....80

FCC Compliance Statement.....82

Declaration of Conformity82

 Remote Control..... 83



Color Mode

You can enjoy images of “Photos,” “Presentations,” “Games,” and so on, in the optimum color tone by choosing the most suitable mode for your surroundings. [p.16](#)

Direct Power On & Instant Off

The direct power on function means you can turn the projector on simply by plugging the power cable into the electrical outlet. [p.39](#)
Also, with the instant-off function you can finish quickly by unplugging the power cable immediately after use.

Ease of Use

■ Source search allows you to easily choose the image to project
Simply by pressing the “Source Search” button, the connected picture signal is automatically detected and projected.

■ Easy to use control panel with large buttons

For ease of use, buttons are classified and arranged according to their projection and adjustment functions. [p.9](#)

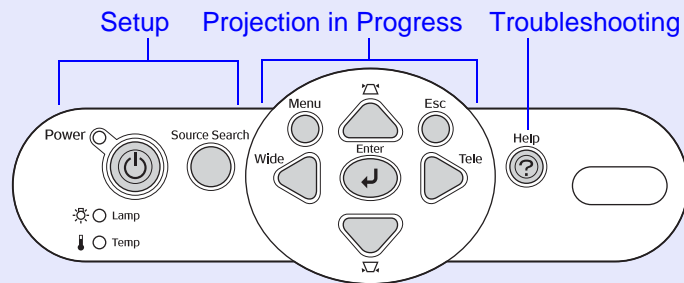

■ A single foot design simplifies leveling adjustments

You can easily make height adjustments with one hand. [Setup Guide](#)

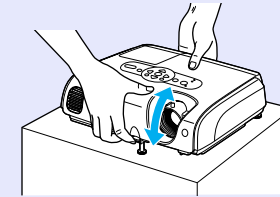

■ Audio indication for projector power on and off

A “beep” sounds when the power is turned ON. After the cooling down period has finished the projector beeps twice. Once you hear the two beeps, you can unplug the power cable.

Image Shift

When you cannot setup this projector directly in front of the screen, the projection position can be adjusted to fit on the screen. [p.18](#)

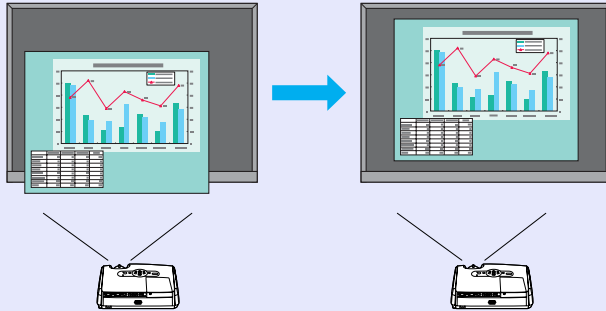







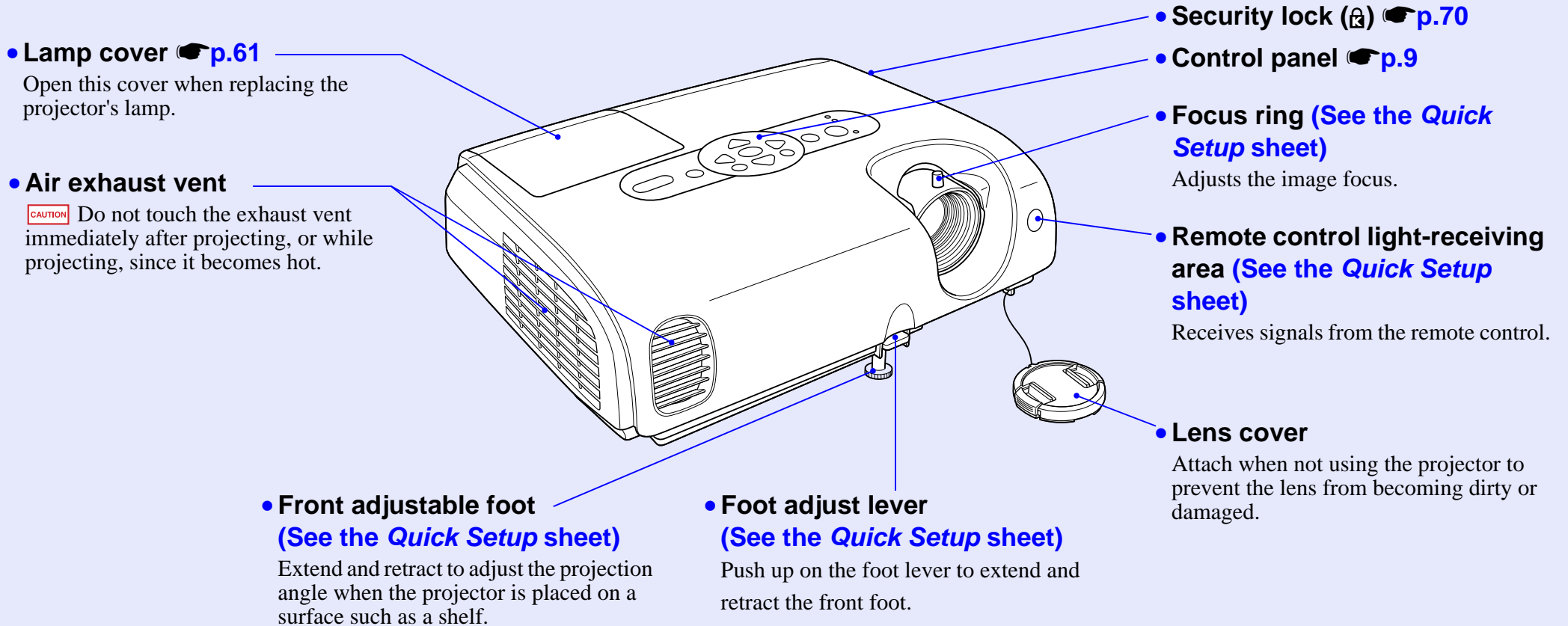

Security Functions

- Manage users with password protect
You can set up a password to restrict the use of the projector. [p.28](#)
- Operation lock stops the use of all control panel buttons except for the Power button
This can prevent your settings being changed by accident or on purpose.
This option is useful when the projector is used at schools or public events.
[p.31](#)

Front/Top



Control Panel

- [Menu] button**  [p.34](#)
 Displays and closes the configuration menu.
- [Power] button**
(See the Quick Setup sheet)
 Turns the projector power on or off.
- Indicator states**  [p.45](#)
 The color of the indicators and whether they are flashing or lit shows the state of this projector.
- [Source Search] button**  [p.20](#)
 The input source is automatically searched for in the following order, and the input image from the connected equipment is projected.
 - Computer port
 - S-Video port
 - Video port
- [↕] [↔] button**  [p.34](#)
 Press to correct keystone distortion. If a configuration menu or help screen is displayed, it selects menu items and setting values.
- [Enter] button**  [p.14, p.34](#)
 Automatically adjusts analog RGB images from computers and RGB video images to the optimum settings. If a configuration menu or help screen is displayed, it accepts and enters the current selection.
- [Esc] button**  [p.34](#)
 Stops the current function. Displays the previous screen or menu while viewing a configuration menu.
- [Help] button**  [p.43](#)
 Displays and closes the help, which shows solutions if a problem occurs.
- [Wide] [Tele] buttons**  [p.34](#)
 Adjusts the image size. If a configuration menu or help screen is displayed, it selects menu items and setting values.

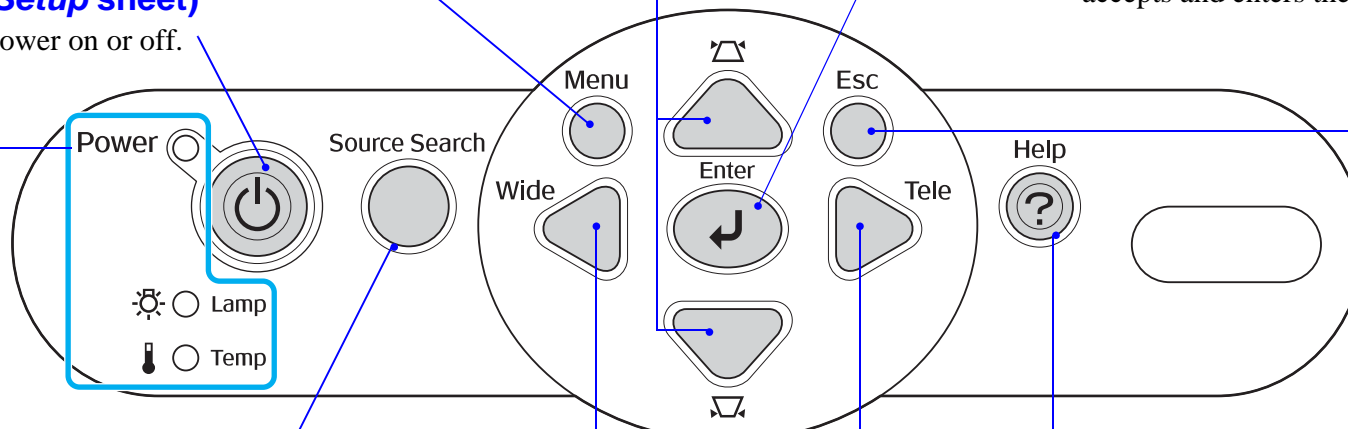

Rear

- **Computer port**
(See the *Quick Setup sheet*)

Inputs analog RGB video signals from a computer and RGB video signals and [component video](#) signals from other video sources.

- **Monitor Out port**

Outputs the computer's analog RGB signals or RGB video signals to an external monitor from the source that is connected to the Computer port. This feature is not available for video equipment signals.

- **Power inlet**
(See the *Quick Setup sheet*)

Connects to the power cable.

- **Rear adjustable foot**

- **S-Video port**
(See the *Quick Setup sheet*)

Inputs [S-Video](#) signals to the projector from other video sources.

- **Video port**
(See the *Quick Setup sheet*)

Inputs [composite video](#) signals to the projector from other video sources.

- **USB port** (p.25, p.72)

Connects the projector to a computer via the [USB](#) cable when using the wireless mouse function.

Computer images cannot be projected by using the USB cable to connect the computer.

- **Remote control light-receiving area**
(See the *Quick Setup sheet*)

Receives signals from the remote control.

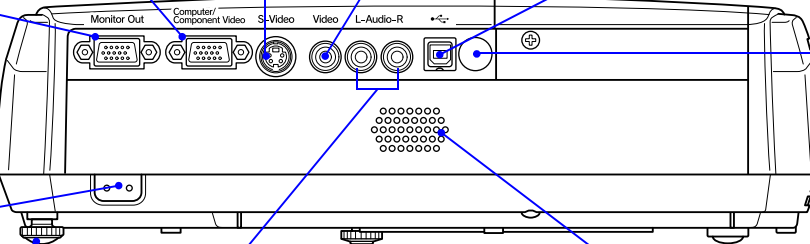

- **Audio input**
(See the *Quick Setup sheet*)

Input audio signals from connected external equipment.
When you are connecting two or more pieces of external equipment that use the same input port, you need to disconnect one before connecting the other, or use an audio selector.





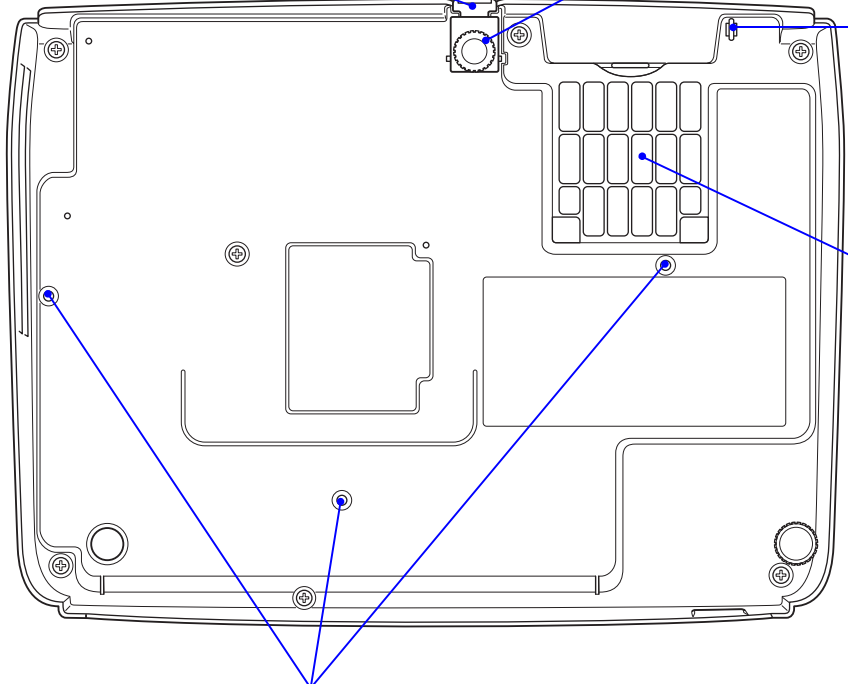





- **Speaker**

Base







- **Foot adjust lever**
(See the *Quick Setup sheet*)
 - **Front adjustable foot**
 - **Lens cover string attachment ring**
Remove this when suspending the projector from a ceiling.
 - **Air filter (air intake vent)**
☞ **p.59, p.65**
This prevents dust and other foreign particles from getting inside the projector when air is drawn in. It should be cleaned and replaced periodically.
 - **Ceiling mount holes (3 points)** ☞ **p.58, p.75**
Attach the optional ceiling mount here when suspending the projector from a ceiling.
- 
- A technical line drawing of the projector's base, viewed from the bottom. The drawing shows the internal layout of the base, including a central rectangular area for the lens cover, a grid of ventilation holes, and various adjustment points. Blue lines with circular endpoints point from text labels to specific features on the base. The labels include: 'Foot adjust lever' pointing to a small lever on the top edge; 'Front adjustable foot' pointing to a circular foot on the front edge; 'Lens cover string attachment ring' pointing to a ring on the top edge; 'Air filter (air intake vent)' pointing to a rectangular vent on the right side; and 'Ceiling mount holes (3 points)' pointing to three circular holes on the bottom edge.

Remote Control

If you position the  over the button icon or button name, a description of that button will appear.

- [Page down] [Page up] buttons  p.26
- [E-Zoom] button (⊕) (⊖)  p.24
- [Enter] button  p.26, p.34
- [Esc] button  p.26, p.34
- [Pointer] button  p.23
- [A/V Mute] button  p.22
- [Computer] button  p.20
- [S-Video] button  p.20
- [Video] button  p.20
- [Auto] button  p.20



- Remote control light-emitting area
- [Power] button
- [⊕] buttons  p.26, p.34
- [Freeze] button  p.22
- [Num] button  p.28
- [Color Mode] button  p.16
- [Menu] button  p.34
- [Resize] button  p.23
- [Help] button  p.43
- [Volume] buttons  p.19
- [Search] button  p.20
- Numeric buttons  p.28



Adjusting and changing the image

This section explains how to adjust image quality, volume, and the color mode. It also explains how to change the image source and adjust the projection position.

Adjusting Computer Images and RGB Video Images

Automatic Setup

Automatic setup detects analog RGB signals coming from a connected computer, and automatically adjusts these signals so that the optimum images can be obtained.

Automatic setup involves adjustment of the following three items: [Tracking](#), Position, and [Sync \(synchronisation\)](#).

If “Auto Setup” in the “Signal” menu is set to “OFF,” automatic setup is not carried out. In this case, press the [Auto] button on the remote control or the [Enter] button on the projector’s control panel to make the adjustment while computer or RGB video images are being projected.

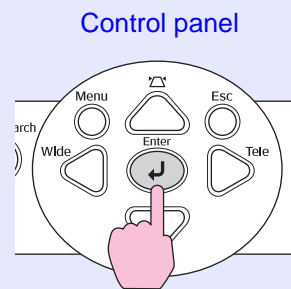
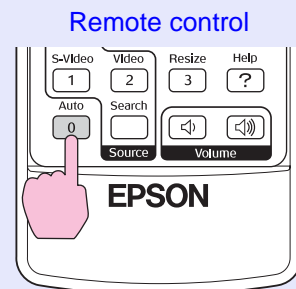

- If you press the [Auto] button on the remote control, or the [Enter] button on the control panel, while performing other functions such as E-zoom or Freeze, these functions are canceled and then the automatic setup adjustment is made.
- Sometimes the signals may not be adjusted correctly depending on the type of computer or RGB video signals being input. In such cases, use the configuration menu commands to adjust the tracking and sync settings manually. [p.15](#)

Adjusting the Tracking

If vertical stripes appear in the projected computer or RGB video images, and this cannot be fixed using automatic setup, you will need to adjust the [Tracking](#) manually using the following procedure.

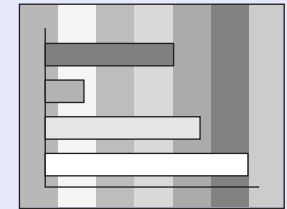

PROCEDURE



Select “Signal” from the configuration menu, and then select “Tracking.”

For details on this operation, refer to “Using the Configuration Menu.” [p.34](#)

Check the buttons you can use and the operations they perform in the guide at the bottom of the screen.

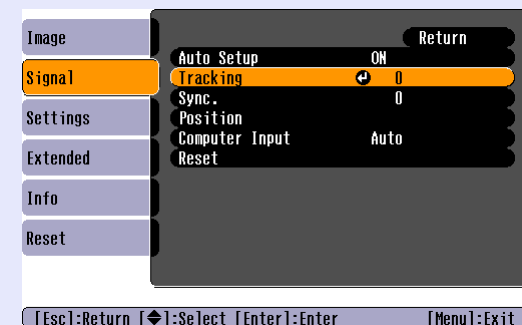
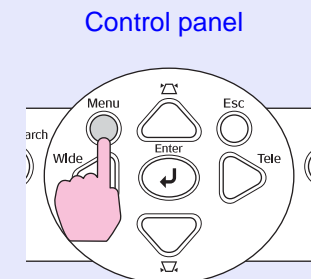
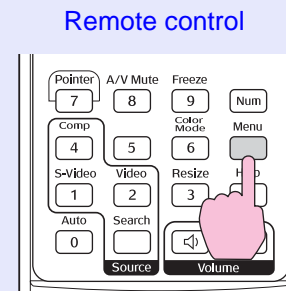

- Adjust the tracking until the vertical stripes disappear from the image.

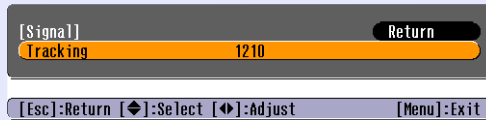

Remote control

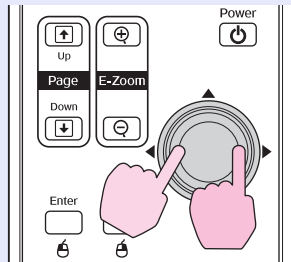

Control panel

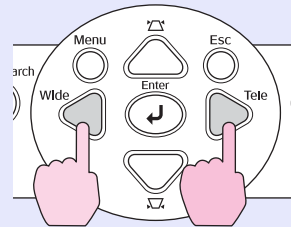

The tracking value increases or decreases each time a button is pressed.

- Press the [Menu] button to exit the configuration menu.



The image will flash during continuous tracking adjustment.

Adjusting the Sync

If flickering, fuzziness or interference appear in computer or RGB video images, and this cannot be fixed using automatic setup, you will need to adjust the [Sync \(synchronisation\)](#) manually using the following procedure.

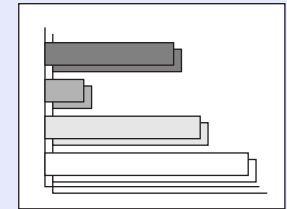

PROCEDURE

- Select "Signal" from the configuration menu, and then select "Sync."

For details on this operation, refer to "Using the Configuration Menu." p.34

Check the buttons you can use and the operations they perform in the guide at the bottom of the screen.

Remote control

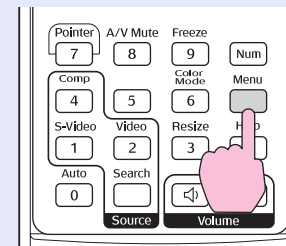

Control panel

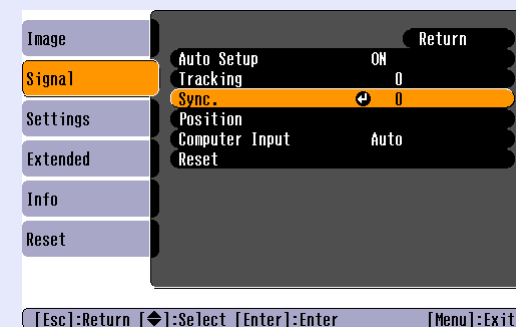
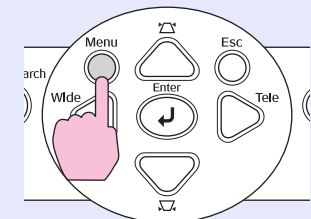

- Adjust the synchronization until the horizontal noise disappears from the image.

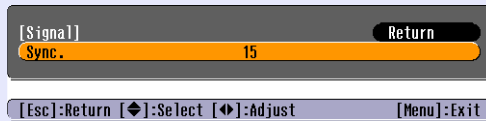

Remote control

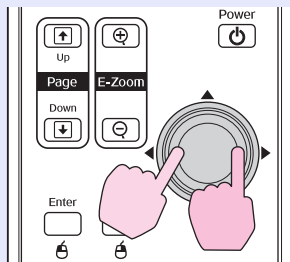

Control panel

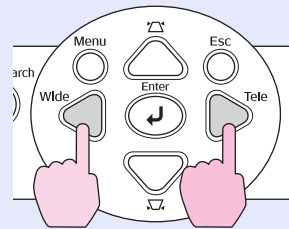

The sync value increases or decreases each time a button is pressed.

- Press the [Menu] button to exit the configuration menu.



TIP

- Adjust the **tracking** before adjusting the sync for best results.
- Flickering and fuzziness may also occur when the brightness, **contrast**, sharpness, zoom, and keystone correction settings are adjusted.

Selecting the Projection Type (Color Mode)

The following seven preset color modes are available. You can easily obtain the optimum image quality simply by selecting the color mode that corresponds to the projected images. The brightness of the images will vary depending on which color mode is selected.

Mode	Application
Photo	(When computer and RGB video images are being input) The images are vivid and brought into contrast. Ideal for projecting still pictures, such as photos, in a bright room.
Sports	(When component video, S-video, or composite video images are being input) The images are vivid and brought to life. Ideal for watching TV programmes and so on in a bright room.
Presentation	Ideal for giving presentations in a bright room
Theatre	Gives images a natural tone. Ideal for watching films in a dark room.
Game	Excels at emphasising dark gradations. Ideal for playing video games in a bright room.
sRGB	Ideal for images that conform to the sRGB color standard
Blackboard	Even if you are projecting onto a blackboard (green board), this setting gives your images a natural tint, just like when projecting onto a screen

PROCEDURE

Remote control

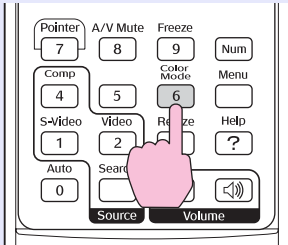

Each time you press the button, the color modes change in the following order.

The current setting appears in the top-right corner of the screen each time the color mode is changed. While the color mode name is displayed on the screen, it does not change to the next color mode setting unless you press the button.

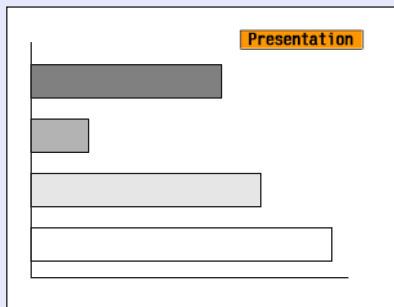
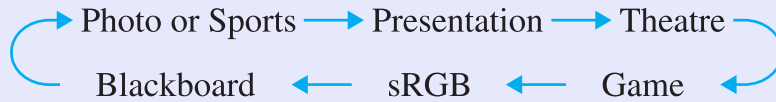

TIP

The color mode can also be set using the “Color Mode” command in the “Image” menu.  p.35

When you cannot setup the projector directly in front of the screen, the projection position can be moved without moving the projector.

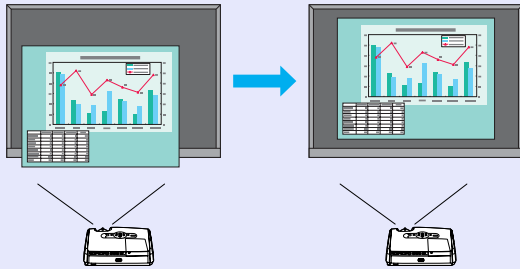

PROCEDURE

- 1 Using the buttons on the projector, perform zoom adjustment or keystone correction.

The Image Shift adjustment screen is displayed after you finish making adjustments.

- 2 Adjust projection position.

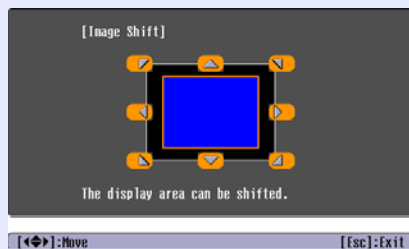

Remote control

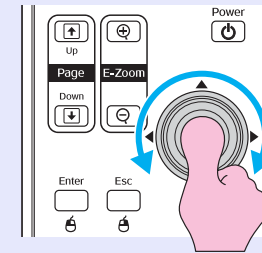

Control panel

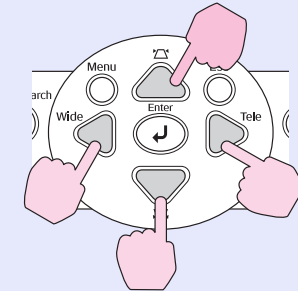

3

- 3 Press the [Esc] button to close the adjustment screen.

The screen closes automatically if no buttons are pressed for about 10 seconds.



TIP

- The projection position cannot be adjusted when zoom is set to the maximum “wide” position.
- Even if you turn the power supply off, the “Image Shift” settings you make are kept. When either the projector position or the angle of the projector is changed, you can readjust or perform the following operations.

Control panel

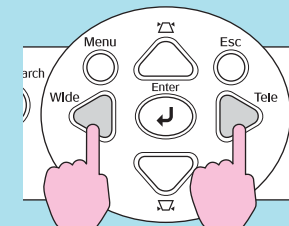

Press and hold down the [Wide] and [Tele] buttons for more than one second.

- You can also make adjustments from the configuration menu. [p.35](#)

The volume of the projector's built-in speaker can be adjusted as follows.

PROCEDURE

Remote control

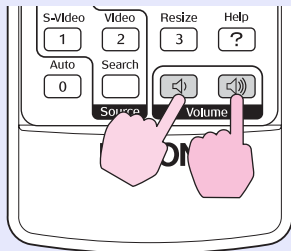

When the [🔊] button is pressed, the volume increases. When the [🔇] button is pressed, the volume decreases.
The volume gauge appears on the screen while the volume is being adjusted.



TIP

The volume can also be adjusted using the configuration menu. ➡ p.37

Automatically Detect Incoming Signals and Change the Projected Image (Source Search)

The picture signal input from the connected equipment is automatically detected and projected.

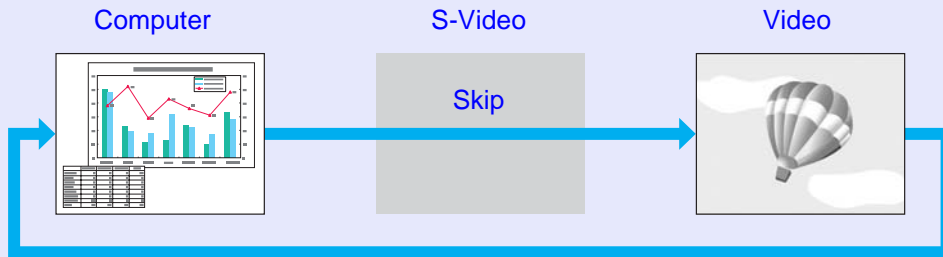

PROCEDURE

1 Perform the Source Search.

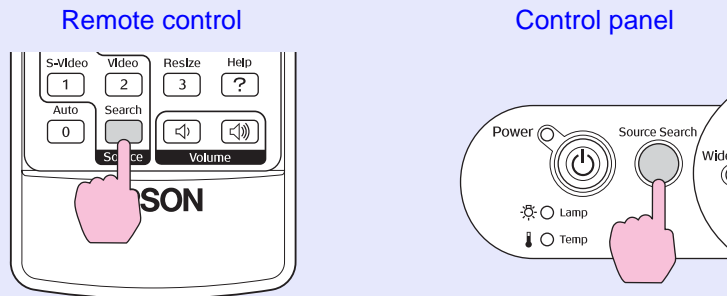

2 The screen being searched for is displayed, and then the image is projected.

When two or more pieces of equipment are connected, press the [Source Search] button until the target image is projected.



TIP

- When your video equipment is connected, start playback.
- The following screen is displayed when there is only one input signal, which is already selected, or when no picture signal is input. You can choose the input source from this screen.

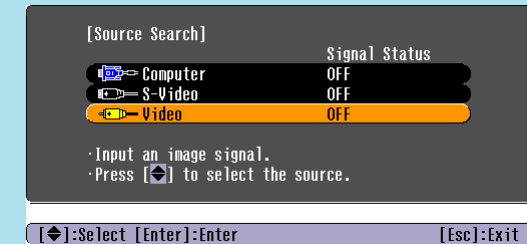

Changing Directly from the Remote Control

You can use the remote control to change directly to the target input source.

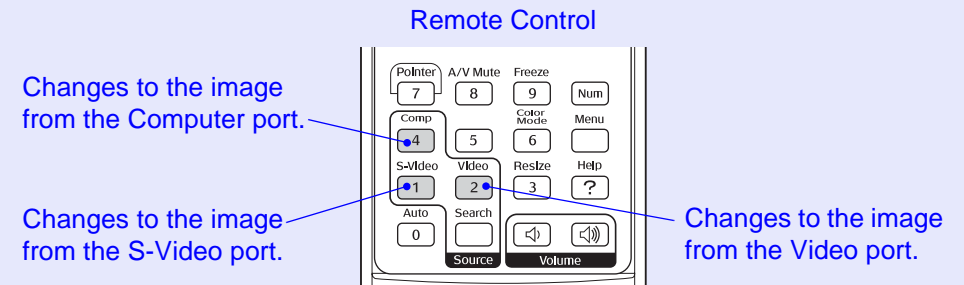

Useful Functions

This section explains useful functions for giving presentations and other projection, and also explains the security functions.

Pausing the Image and Sound (A/V Mute)

For example, this can be used if you want to pause the projection for a moment and focus the audience's attention on what you are saying. Or if you are making a computer presentation and you do not want to show details, such as selecting different files.

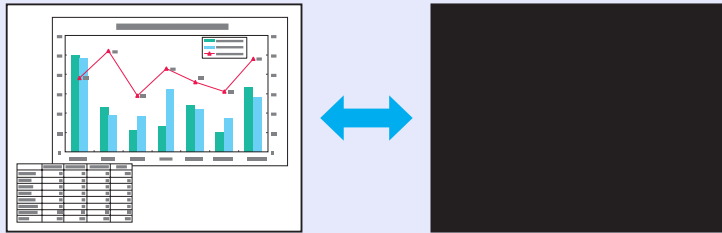

PROCEDURE

Remote control

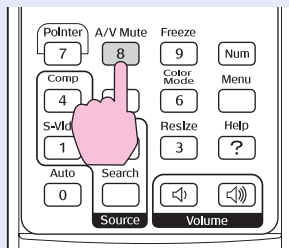

You can turn this function on or off by pressing the [A/V Mute] button.



- If you use this function when projecting moving images, the images and sound will still continue to be played back by the source, and you cannot return to the point where the A/V mute function was activated.
- The screen display in A/V mute can be chosen from black, blue, or a logo by using "Extended" - "Display" - "Background Color" in the configuration menu.

Freezing the Image (Freeze)

The source image continues to project even when the screen is frozen. You can still perform operations such as changing files, without projecting any images.

PROCEDURE

Remote control

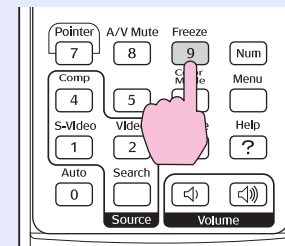

You can turn this function on or off by pressing the [Freeze] button.



- **Sound does not stop.**
- **Even though the image on the screen is frozen, the image source continues to play. It is not possible to resume projection from the point where it was paused, unless you have paused the source image.**
- **Pressing the [Freeze] button also clears configuration menu displays and help messages from the screen.**
- **The freeze function still works while the E-Zoom function is being used.**

Changing the Aspect Ratio (Resizing)

This function changes the [aspect ratio](#) of images from 4:3 to 16:9 when [component video](#), [S-Video](#), or [composite video](#) images are being projected.

Images which have been recorded in digital video or onto DVDs can be viewed in 16:9 wide-screen format.

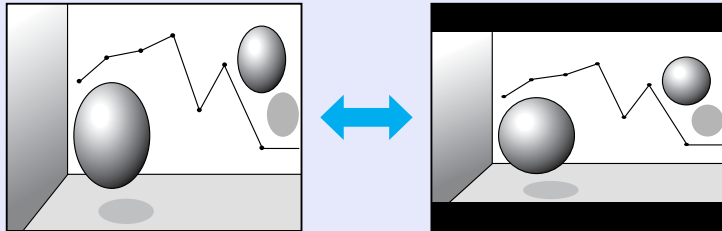

When images in [Squeeze mode](#) are projected at 4:3

When images in squeeze mode are projected at 16:9

PROCEDURE

Remote control

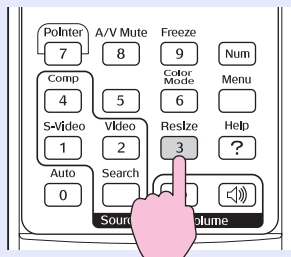

The display is changed whenever you press the button.



You can also make this setting using the "Resize" command in the "Signal" menu.

Displaying the Pointer (Pointer)

This allows you to move a pointer icon on the projected image, and helps you draw attention to the area you are talking about.

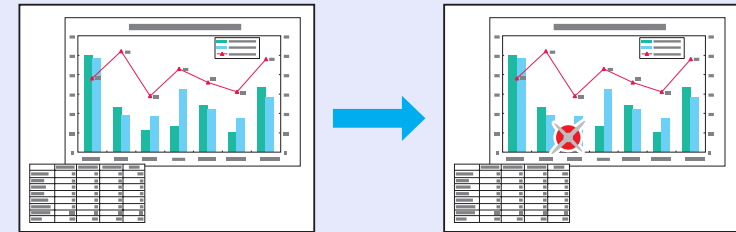

PROCEDURE



1 Display the pointer.

Remote control

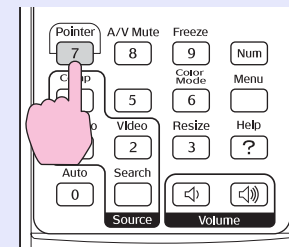

Each time you press the button the pointer appears or disappears.

2 Move the pointer icon.

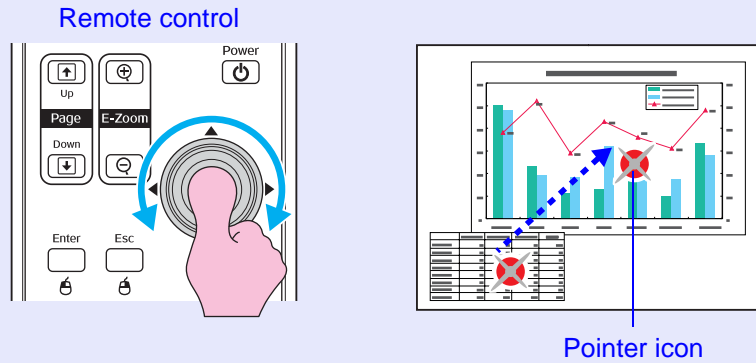

Enlarging Part of the Image (E-Zoom)

This is useful when you want to see images in greater detail, such as graphs and details in a table.

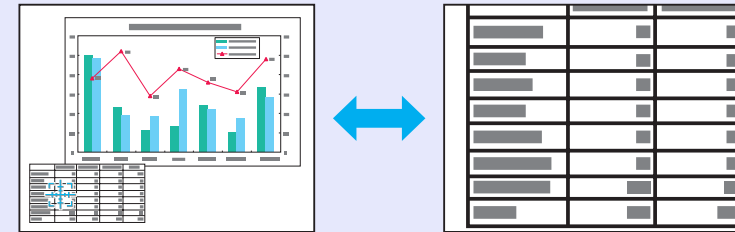

TIP You can use the "Pointer Shape" command in the "Settings" menu to change the shape of the pointer to one of three different shapes. [p.37](#)

PROCEDURE

1 Start E-Zoom.

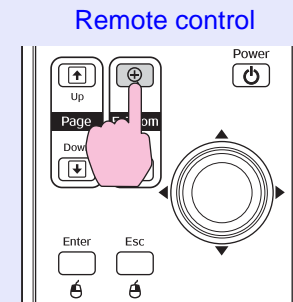

- 2 Move the crosshair to the area of the image that is to be enlarged or reduced.

Remote control

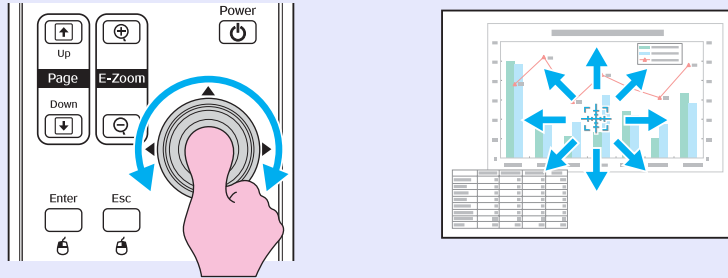

Using the Remote Control to Operate the Mouse Pointer (Wireless Mouse)

If the USB terminal of a computer and the USB terminal on the back of this projector are connected by a commercially available USB A-B cable, you can use the projector's remote control like a wireless mouse to control the computer's mouse pointer.

Computer

Windows 98/2000/Me/XP Home Edition/XP Professional
Macintosh (OS 8.6–9.2/10.0–10.3)

- 3 Enlarge.

Remote control

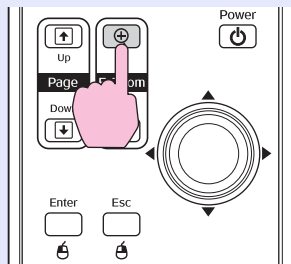

You can reduce the enlarged image by pressing the [-] button. To cancel the E-Zoom, press the [Esc] button.



TIP

- The enlargement ratio will appear on the screen.
- You can scroll the screen by tilting the [⊙] button.
- The selected area can be enlarged to between 1- 4 times, in 25 incremental steps.

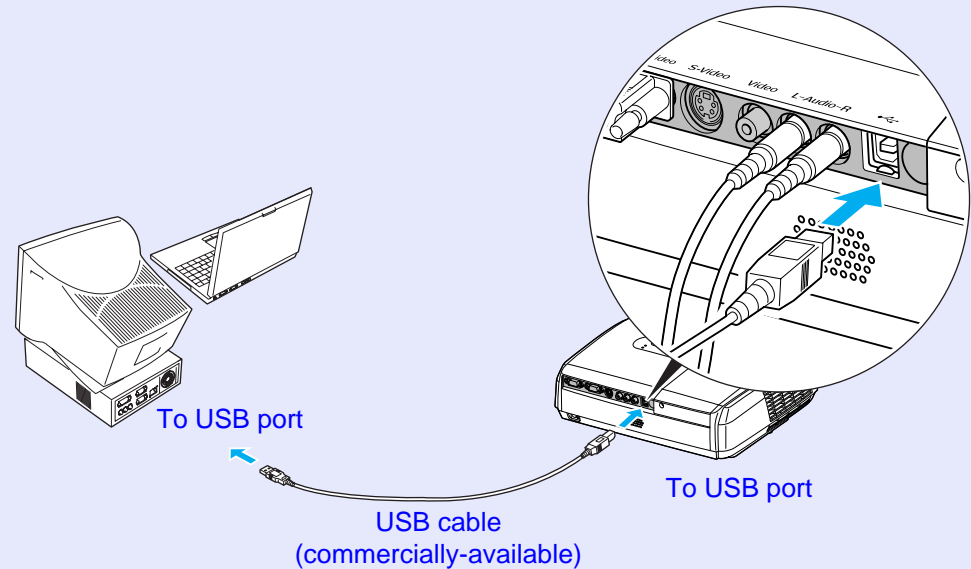



TIP

- *The USB cable can only be connected to computers with a standard USB interface. If using a computer which is running Windows, the computer must have had a full version of Windows 98/2000/Me/XP Home Edition/XP Professional installed. If the computer is running a version of Windows 98/2000/Me/XP Home Edition/XP Professional that has been upgraded from an earlier version of Windows, correct operation cannot be guaranteed.*
- *It may not be possible to use the mouse function under some versions of both the Windows and Macintosh operating systems.*
- *Some computer settings may have to be changed in order for the mouse function to be used. Consult the documentation for the computer for further details.*

Once the connection has been made, the mouse pointer can be operated as follows.

Moving the mouse pointer

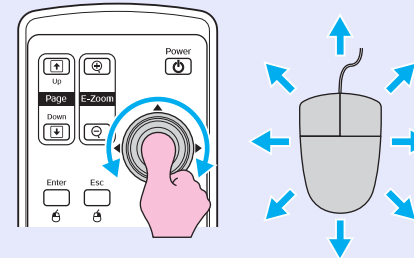

Mouse clicks

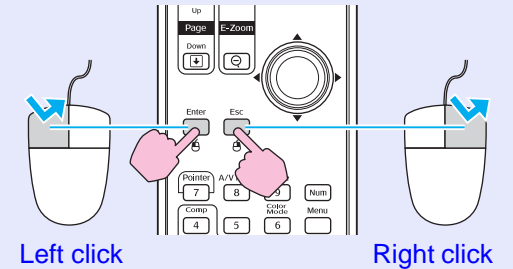

Double-click: Press twice in rapid succession.

Drag and drop

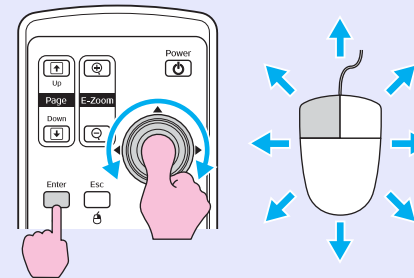

1. Hold down the [Enter] button and tilt and drag the [⊙] button.
2. Release the [Enter] button to drag at the desired location.

This is useful for displaying the previous or next slide in a PowerPoint slideshow.

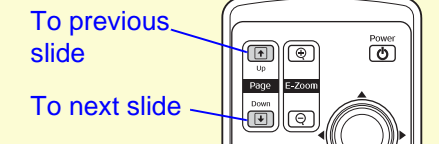

To previous slide
To next slide





TIP

- *If the mouse button settings are set to reverse on the computer, the operation of the remote control buttons will also be reversed.*
- *The wireless mouse function cannot be used while the following functions are being used.*
 - *While a configuration menu is being displayed*
 - *While a help menu is being displayed*
 - *While the E-Zoom function is being used*
 - *While a user's logo is being captured*
 - *Pointer function*
 - *While adjusting sound volume*
 - *While Image Shift is being used*



Preventing theft (Password Protect)

When the Password Protect function is activated, people who do not know the password will not be able to use the projector to project images. Furthermore, the user's logo that is displayed on the background of the screen cannot be changed. This is effective against theft. At the time of purchase, the password protection function is not enabled.

■ When Password Protect is Enabled

■ When "Power ON Protect" is enabled (ON)

When the power is turned on for the first time after the projector's power cable is connected to an electrical outlet, or when Direct Power On is carried out, the following password entry screen will be displayed.

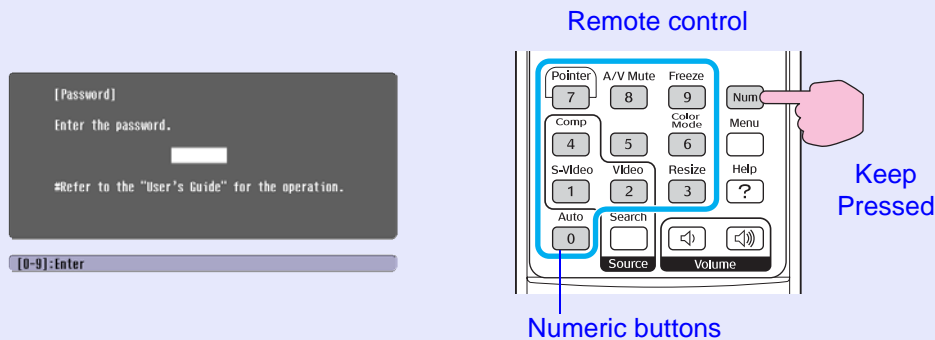

While holding down the [Num] button, press the numeric keypad buttons to enter the password. If the password is entered correctly, projection will start.

The password entry screen will only be displayed when the power is turned on for the first time after the power cable has been disconnected and then reconnected.

If you leave the power cable connected to the electrical outlet and turn the projector's power on when it is in standby mode, projection will start without the password entry screen appearing. If Direct Power On is set to "ON" and you are using a circuit breaker or similar to centrally control the power, the password entry screen will be displayed the first time the projector is turned on after the power supply is restored.



TIP

• *If an incorrect password is entered three times in succession, the message "The projector's operation will be locked." will be displayed for approximately five minutes, and then the projector will switch to standby mode. If this happens, disconnect the power plug from the electrical outlet and then reinsert it and turn the projector's power back on. A window requesting you to enter the password will be displayed. Enter the correct password.*

If you happen to forget the password, make a note of the "Request Code: xxxxx" number that appears in the Password screen and contact Epson. [p.56](#)

• *If you continue to repeat the above operation and input the wrong password thirty times, the following message will be displayed and the projector will not accept password entries any more: "The projector's operation will be locked. Contact the nearest address provided in the "International Warranty Conditions" section of the Safety Instructions/ World Wide Warranty terms." If you see this message, contact Epson. [p.56](#)*



■ When “Password Timer” is set to “ON” and “Timer” is used
The password entry screen will not be displayed at all when the power is turned on until the length of time that has been set has elapsed. When the set length of time has elapsed, the password entry screen will be displayed each time the power is turned on. The length of time referred to here is the total illumination time for the projector's lamp from the point when the projector's menu is closed.
If “Password Timer” is set to “OFF,” the password entry screen will be displayed each time the power plug is disconnected and reinserted from the electrical outlet. If the projector power is on when it is in standby mode, the password entry screen will not be displayed.

■ When “User's Logo Protect” is enabled (ON)

If an attempt is made to carry out any of the following user logo operations, a message is displayed and the setting cannot be changed. To change the setting, set “User's Logo Protect” to “OFF” first.  p.30

- Capturing a user's logo
- When the “Extended” - “Display” - “Background Color” menu is changed from “Logo” to “Black” or “Blue,” or changed from “Black” or “Blue” to “Logo.”
- When the “Extended” - “Display” - “Startup Screen” menu (“ON” or “OFF”) is changed.

■ Setting Password Protect

Use the following procedure to set Password Protect.

PROCEDURE

- 1 Hold down the [Freeze] button for approximately 5 seconds.

The “Password Protect” menu will be displayed.

Remote control

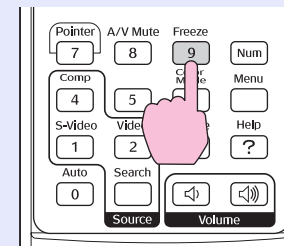

TIP

- If Password Protect has already been enabled, the “Password” screen will be displayed. If the password has been entered correctly, the “Password Protect” menu will be displayed. “When Password Protect is enabled”  p.28
- If Password Protect is set to “ON,” attach the accessory Password Protect sticker to your preferred position on the projector as a theft-prevention measure.

- 2 Turn “Power ON Protect” on.

- (1) Select “Power ON Protect,” and then press the [Enter] button.
- (2) Select “ON,” and then press the [Enter] button.
- (3) Press the [Esc] button.

3 Turn “Password Timer” on.

If you don't use this setting, proceed to step 4.

- (1) Select “Password Timer,” and then press the [Enter] button.
- (2) Select “ON,” and then press the [Enter] button.
- (3) Press the [Esc] button.
- (4) Select “Timer” and then press the [Enter] button.
- (5) While holding down the [Num] button, use the numeric keypad buttons to enter the setting time within the range of 1 to 9999 hours and then press the [Enter] button.
If you make a mistake entering the time, press the [Esc] button and re-enter the time.
When you have finished using the “Password Protect” menu, the countdown for the elapsed time will start.

4 Turn “User’s Logo Protect” on.

- (1) Select “User’s Logo Protect,” and then press the [Enter] button.
- (2) Select “ON,” and then press the [Enter] button.
- (3) Press the [Esc] button.

5 Enter the password.

- (1) To set a password, select “Password” and then press the [Enter] button.
- (2) The message “Change the password?” will be displayed, so select “Yes” and then press the [Enter] button. The default setting for the password is “0000,” but you should change this to your own desired password. If you select “No,” the screen shown at step 1 will be displayed again.
- (3) While holding down the [Num] button, use the numeric keypad buttons to enter a 4-digit number. The number entered will be displayed as “* * * *.” Once four digits have been entered, the confirmation screen will be displayed.
- (4) Re-enter the password.
The message “The new password is stored.” will be displayed. If you enter the password incorrectly, a message will be displayed prompting you to re-enter the password.



Operation Button Lock Function

This function locks the buttons on the projector's control panel. This function is useful at times such as during show events so that only projection is carried out deactivating all buttons operation, or in places such as schools to limit the range of buttons that can be operated.

PROCEDURE

- 1 From the configuration menu, select "Settings" - "Operation Lock."

For details on this operation, refer to "Using the Configuration Menu." p.34

Check the buttons you can use and the operations they perform in the guide at the bottom of the screen.

Remote control

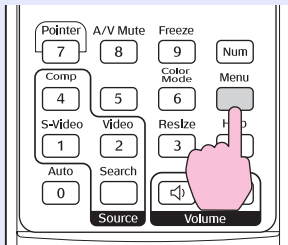

Control panel

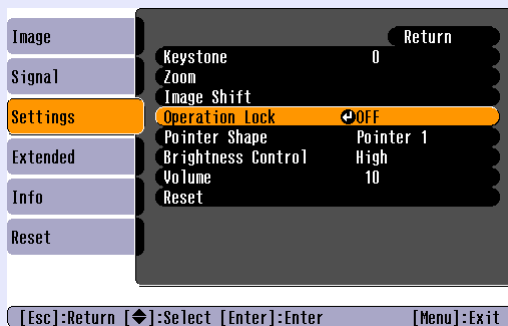
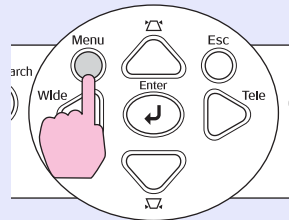

- 2 Set to "ON."

If set to "ON," none of the buttons on the control panel except the [Power] button can be operated.

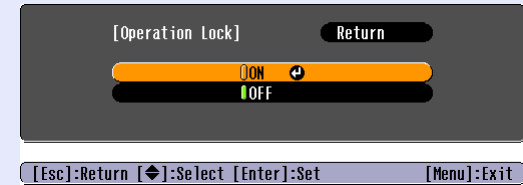

Remote control

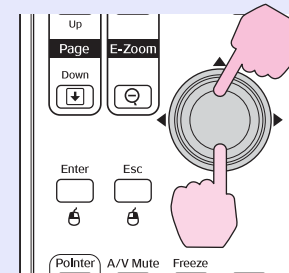

Control panel

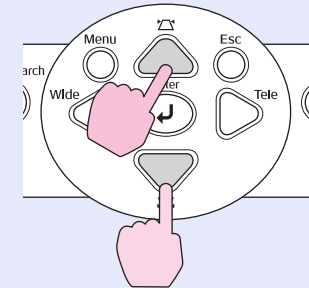



When the confirmation message is displayed, select “Yes.”

The control panel buttons will be locked in accordance with the selected setting.



TIP

There are two methods to cancel the projector’s control panel lock.

- *Using remote control, change the “Settings” - “Operation Lock” in the configuration menu to “OFF”*
 - *Hold down the projector’s [Enter] button continuously for about 7 seconds, a message will be displayed and the lock will be cancelled.*
-

Configuration Menu

This section explains how to use the configuration menu and its functions.

1 Selecting from the top menu

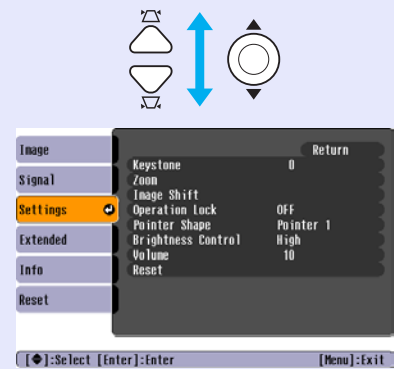
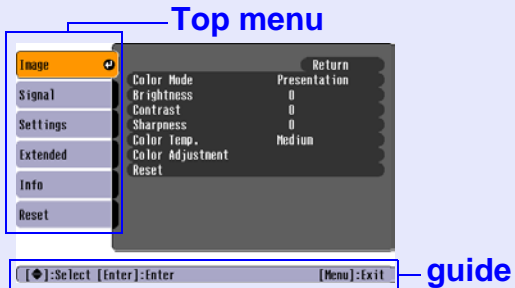

2 Selecting from the sub menu

Sub menu (Settings)

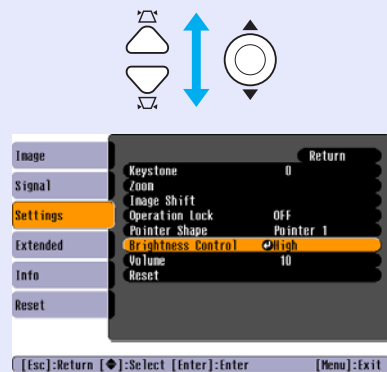
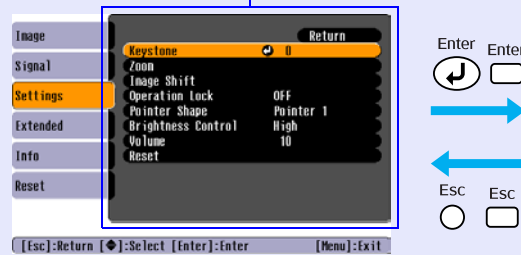

3 Changing the selected item

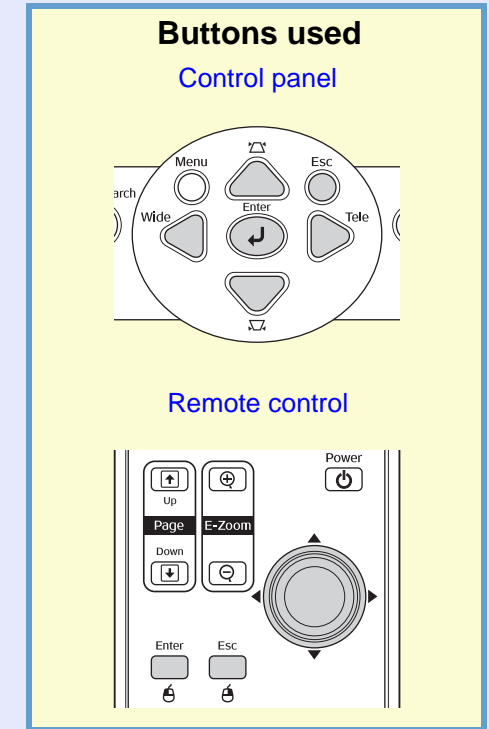
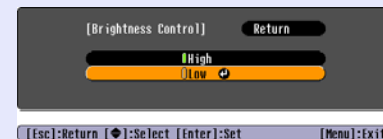
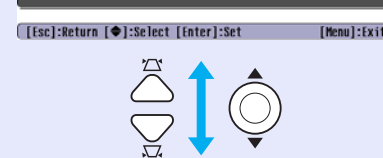
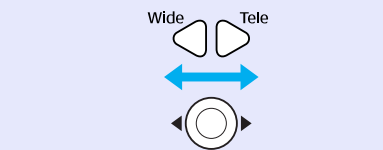

Select the setting to change.

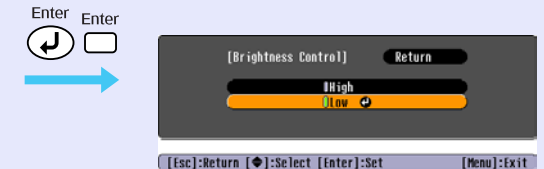

“Image” Menu

The items that can be set will vary depending on the input source that is currently being projected. Setting details are saved separately for each source.

Computer/RGB video



[Component video▶▶](#) / [Composite video▶▶](#) / [S-Video▶▶](#)



Sub-menu	Function
Color Mode	Select the type of image to suit your surroundings. p.16
Brightness	Adjusts the image brightness.
Contrast▶▶	Adjusts the difference between light and shade in the images.
Color Intensity	Adjusts the color intensity for the images.
Tint	(Adjustment is only possible when component video or NTSC signals are being input.) Adjust the image tint.
Sharpness	Adjusts the image sharpness.
Color Temp.▶▶	You can adjust the overall tint of images. If you select “High,” images appear bluish, and if you select “Low,” images appear reddish. (This item cannot be selected if “ sRGB▶▶ ” has been selected as the “Color Mode” setting in the “Image” menu.)
Color Adjustment	Adjusts the red, green, and blue color strength of the image. Red: Adjust the intensity of red. Green: Adjusts the intensity of green. Blue: Adjusts the intensity of blue. (This item cannot be selected if “ sRGB▶▶ ” has been selected as the “Color Mode” setting in the “Image” menu.)
Reset	Resets all adjustment values for the “Image” menu functions to their default settings. If you would like to return all menu items to their default, see “Reset All.” p.41



“Signal” Menu

The items that can be set will vary depending on the input source that is currently being projected. Setting details are saved separately for each source.

Computer/RGB video

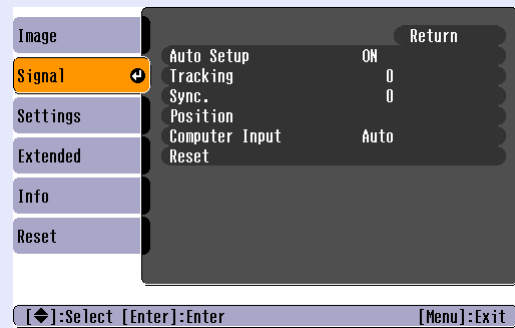

Component video»

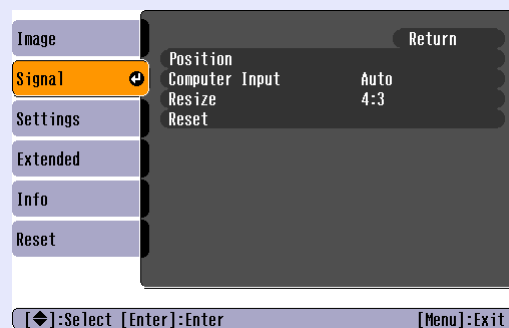

Composite video»/ S-Video»

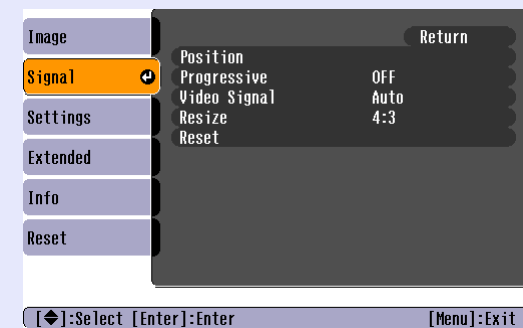

Sub-menu	Function
Auto Setup	Selects whether the automatic adjustment function for automatically optimising images when the input source is changed is turned “ON” or “OFF.” (Only appears when computer video is being projected.) 🖱️ p.14
Tracking»	Adjusts computer images when vertical stripes appear in the images. 🖱️ p.14
Sync.»	Adjusts computer images when flickering, fuzziness or interference appear in the images. 🖱️ p.15
Position	Moves the image display position vertically and horizontally.
Progressive	(Only appears when composite Video/S-Video/Component video signals are being projected.) OFF: IP conversion is carried out for each field in the screen. This is ideal for using when viewing images with a large amount of movement. ON: Interlaced» (i) signals are converted into progressive» (p) signals. This is ideal for using when viewing still images.
Computer Input	Selects the input signal in accordance with the equipment that is connected to the Computer port. If set to “Auto” the input signal is set automatically in accordance with the connected equipment. If the colours do not appear correctly when you select “Auto,” select the appropriate signal for the connected equipment manually.
Video Signal	(Only appears when composite video/S-Video signals are being projected.) Sets the video signal format. With the “Auto” function, image signals are recognized automatically. If interference appears in the projected images or no images appear when you select “Auto,” select the appropriate signal manually.
Resize	Sets the aspect ratio» for projected images. 🖱️ p.23
Reset	All the adjustment values on the “Image” menu, except “Computer Input,” are returned to their default values. Press the [Enter] button on the remote control or on the projector's control panel. If you would like to return all menu items to their default, see “Reset All.” 🖱️ p.41

"Settings" Menu

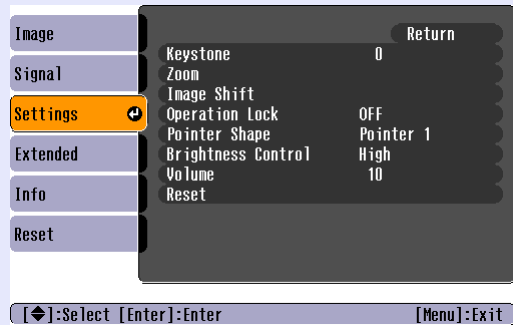

Sub-menu	Function
Keystone	Corrects vertical keystone distortion in images.
Zoom	Adjusts the size of the projected image. Wide: Larger Tele: Smaller
Image Shift	Adjusts the projection position. p.18
Operation Lock	When set to "ON," the operation of all buttons on the projector's control panel except for the [Power] button will be disabled. p.31
Pointer Shape	The shape of the pointer can be selected. p.23 Pointer 1: Pointer 2: Pointer 3:
Brightness Control	This lets you set the lamp brightness to one of two settings. Select "Low" if the images being projected are too bright such as when projecting images in a dark room or onto a small screen. When "Low" is selected, the brightness of the images is reduced, the amount of electricity consumed and noise produced during projection are reduced, and the lamp's operating life is extended. (Electrical consumption: about an 18 W decrease, lamp life: about 1.5 times longer)
Volume	Adjusts the volume. p.19
Reset	Adjustment values for the "Settings" menu functions are returned to their default settings, except for "Image Shift" and "Zoom." If you would like to return all menu items to their default, see "Reset All." p.41

“Extended” Menu



Sub-menu	Function
Display	<p>This lets you make settings related to the projector's display.</p> <p>Message: Sets whether the input source name or color mode name or a message is displayed on the screen (“ON”) or not displayed (“OFF”) at times such as when the input source or color mode is changed or when no image signals are being input.</p> <p>Background Color: Sets the screen status when the [A/V Mute] button on the remote control is being pressed or when no image signals are being input to “Black,” “Blue,” or “Logo.”</p> <p>Startup Screen: The startup screen (the image projected when starting the projector) is displayed when starting (ON)/ or not displayed when starting (OFF). The setting is enabled after turning the power supply off and then back on.</p>
User's Logo	Change the user's logo that is displayed as a background and displayed during A/V Mute. 🖱️ p.66
Projection	<p>Sets the projection position. 🖱️ p.58 Front, Front / Ceiling, Rear, Rear / Ceiling</p> <p>By holding down the [A/V Mute] button for about 5 seconds, you can change the projection setup.</p>

Sub-menu	Function
Operation	<p>Direct Power ON: Sets whether direct power on is enabled (“ON”) or disabled (“OFF”). When you set to “ON” and leave the power cable connected to a wall socket, be aware of that sudden surges of electricity that may occur when power comes back on after a power outage may cause the projector to turn on automatically.</p> <p>Sleep Mode: Sets whether projection stops automatically (“ON”) or not (“OFF”) when no operations are carried out for approximately 30 minutes while no image signals are being input.</p> <p>Fan Speed: When using the projector at an altitude of about 4900 ft (1500 m) or higher, set to “High.”</p>
Link 21L	<p>Sets whether the EMP Link 21L utility software is being used or not. To enable the EMP Link 21L, turn the projector's power off and wait until the cool down period has finished.</p>
Language	<p>Sets the language for message displays.</p>
Reset	<p>Returns “Display” and “Operation” settings in the “Extended” menu (except for “Fan Speed”) to their default settings. If you would like to return all menu items to their default, see “Reset All.”  p.41</p>

“Info” Menu

Lets you check the status of the image signals being projected and the status of the projector. (Display only)

Computer/RGB Video/[Component video](#)»

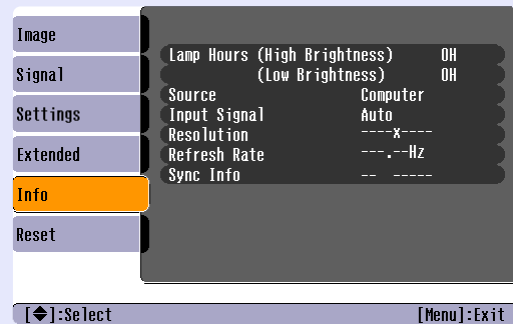

[Composite video](#)»/ [S-Video](#)»

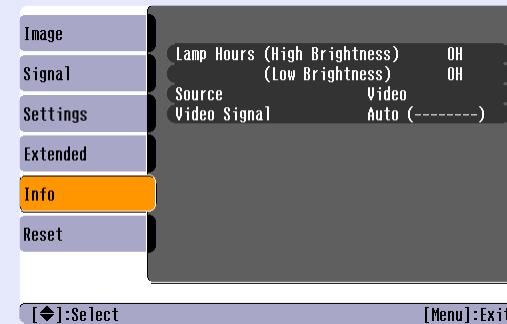

Sub-menu	Function
Lamp Hours	Shows the cumulative lamp operating time. If it reaches the lamp warning time, the characters are displayed in yellow. The cumulative operating time from 0 to 10 hours will be displayed as “0H.” From “10H” onwards, the display will be in units of 1 hour.
Source	Displays the input source which is currently being projected.
Input Signal	Displays the input signal settings. (Does not appear when the input source is composite video or S-video.)
Resolution	Displays the input resolution. (Does not appear when the input source is composite video or S-video.)
Video Signal	Shows the video signal format. (Not displayed for computer, RGB video, or component video images.)
Refresh Rate »	Displays the refresh rate. (Does not appear when the input source is composite video or S-video.)
Sync. » Info	Information from this menu may be required when you ask for service from your dealer or from Epson.  p.56 (Does not appear when the input source is composite video or S-video.)

“Reset” Menu

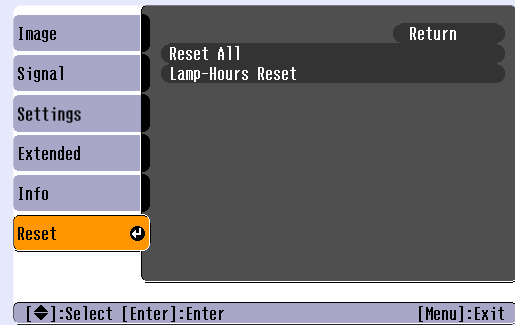

Sub-menu	Function
Reset All	Resets all items in all menus to their default settings. <ul style="list-style-type: none"> •The “Computer Input,” “Zoom,” “Image Shift,” “User’s Logo,” “Lamp Hours,” and “Language” settings will not be reset to their defaults.
Lamp-Hours Reset	Clear the cumulative lamp operating time and reset to “0H.” Perform this procedure when you replace the lamp.

Troubleshooting

This chapter describes how to identify problems and what to do if a problem is found.

If a problem occurs with the projector, the Help function uses on-screen displays to assist you in solving the problem. It uses a series of menus in a question and answer format.

PROCEDURE

1 Display the Help menu.

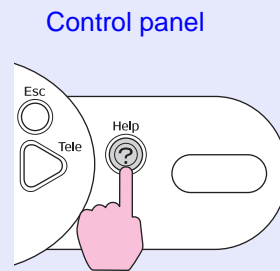
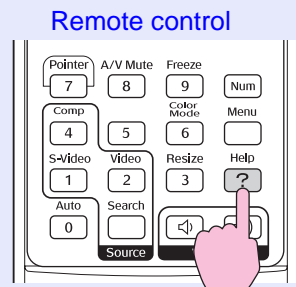

2 Select a menu item.

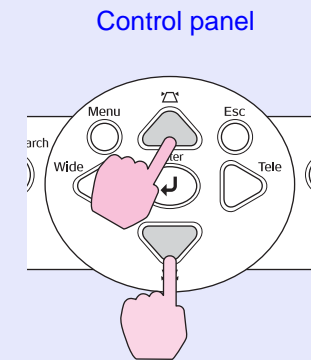
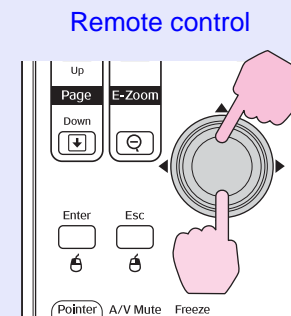
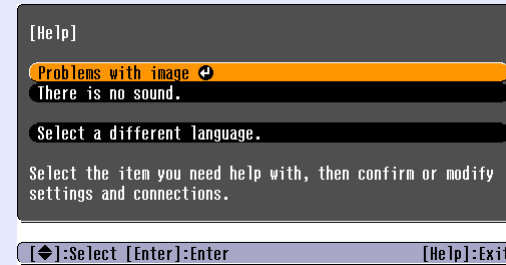

3 Confirm the selection.

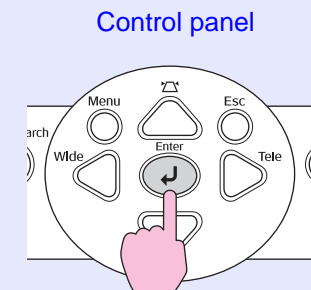
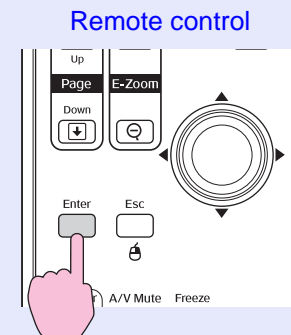

- 4 Repeat the operations in steps 2 and 3 to proceed through the menu to more detailed items.

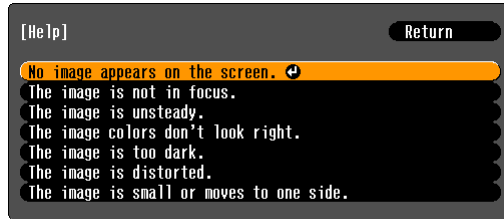

[Esc]:Return [↕]:Select [Enter]:Enter [Help]:Exit

- 5 Press the [Help] button to exit the help menu.



If the Help function does not provide a solution to the problem, refer to “Problem Solving” p.45



If you are having a problem with the projector, first check the projector's indicators and refer to "Reading the Indicators" below.
 If the indicators do not show clearly what the problem might be, refer to "When the Indicators Provide No Help." [p.48](#)

Reading the Indicators

The projector is provided with the following three indicators which indicate the operating status of the projector.

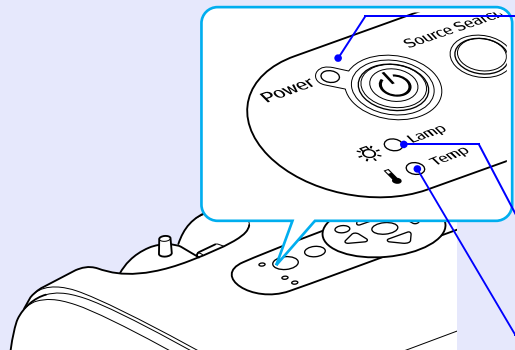

Indicates the operating status of the projector.

- Orange: Standby condition
 Projection starts again when the [Power] button is pressed.
 You can disconnect the power plug from the electrical outlet when the status light is in this condition.
- Green: Warm-up in progress
 Warm-up time is approximately 30 seconds. After warm-up is complete, the indicator will stop flashing.
- Green: Projection in progress

● Indicates the projection lamp status.

● Indicates the internal temperature status.

The following tables show what the indicators mean and how to remedy problems that they indicate.
 If all indicators are switched off, check that the power cable is connected correctly and that power is being supplied normally.

Power indicator lights red **Abnormal**

● : lit ● (with radiating lines) : flashing ○ : off

Status	Cause	Remedy or Status
Power ● Red ● (with radiating lines) Red ● (with radiating lines) Red	Internal error	Stop using the projector, disconnect the power cable from the electrical outlet, and contact your dealer or Epson. p.56
Power ● Red ● (with radiating lines) Red ○	Fan related error/ Sensor error	Stop using the projector, disconnect the power cable from the electrical outlet, and contact your dealer or Epson. p.56



● : lit ☀ : flashing ○ : off

Status	Cause	Remedy or Status
Power ● Red ☀ ○ 🌡 ● Red	Internal temperature error (overheating)	The lamp will turn off automatically and projection will stop. Wait for about 5 minutes. After about 5 minutes the projector will switch to standby mode, so check the following: <ul style="list-style-type: none"> • Check that the air filter and air exhaust vent are clear, and that the projector is not positioned against a wall. • If the air filters are blocked, clean or replace them. (p.59, p.65) • After checking, press the [Power] button to turn the power back on. If this does not solve the problem and the projector continues to overheat or the indicators continue to show a problem when the power is turned on, stop using the projector, disconnect the power cable from the wall outlet, and contact your dealer or Epson. (p.56)
Power ● Red ☀ ☀ Red 🌡 ○	Lamp timer failure/ Lamp out	Take out the lamp and check if it is broken. (p.61) If the lamp is not broken, put it back in and then turn the power on. If the lamp still does not turn on, replace it with a new lamp. If this does not solve the problem, stop using the projector and disconnect the power cable from the electrical outlet. Then contact your dealer or Epson. (p.56)
		If the lamp is broken, replace it with a new lamp, or contact your local dealer for further advice. If replacing the lamp yourself, be careful to avoid pieces of broken glass. (Projection cannot be carried out until the lamp is replaced.)
		Check that the lamp and the lamp cover are securely installed. If the lamp or lamp cover is not securely installed, the lamp will not switch on.

■ Lamp or Temp indicator flashes orange **Warning**

● : lit ☀ : flashing ○ : off

Status	Cause	Remedy or Status
Power ● Red ☀ ○ 🌡 ☀ Orange	High-speed cooling in progress	(This is not an abnormality, but if the temperature rises too high again, projection will stop automatically.) <ul style="list-style-type: none"> • Check that the air filters and air exhaust vent are clear and that they are not up against a surface such as a wall. • If the air filters are clogged, clean or replace them. (p.59, p.65)

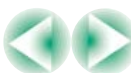

● : lit ☀ : flashing ○ : off

Status	Cause	Remedy or Status
Power ● ☀ Orange 🌡 ○	Lamp replacement notification	Replace the lamp with a new one. 🖱 p.61 If you continue to use the lamp after it has passed the replacement period, the possibility that the lamp may break will increase. Replace the lamp with a new one as soon as possible. The Power indicator status will vary depending on the projector status at the time.



TIP











- *If the projector is not operating properly even though the indicators are all showing normal, refer to “When the Indicators Provide No Help” on the following page.*
- *If an indicator is showing a status which does not appear in the previous tables, contact your dealer or Epson. 🖱 p.56*



When the Indicators Provide No Help

If any of the following problems occur and the indicators do not offer a solution, refer to the pages given for each problem.



Problems relating to images

- No images appear  p.49
Projection does not start, the projection area is completely black, the projection area is completely blue, etc.
- Projection stops automatically  p.49
- The message “Not Supported.” is displayed  p.50
- The message “No Signal.” is displayed  p.50
- Images are fuzzy or out of focus  p.51
- Interference or distortion appear in images  p.51
Problems such as interference, distortion or black & white checked patterns appear.
- Image is truncated (large) or small  p.52
Only part of the image is displayed.
- Image colors are not right  p.53
The whole image appears purplish or greenish, images are black & white, colors appear dull, etc.
(Computer monitors and LCD screens have different color reproduction performance, so that the colors projected by the projector and the colors appearing on the monitor may not necessarily match, but this is not a sign of a problem.)
- Images appear dark  p.53
- Nothing appears on the external monitor  p.53

Problems when projection starts

- Power does not turn on  p.54

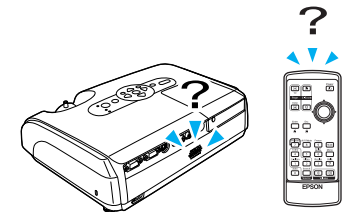

Other problems

- No sound can be heard or the sound is faint  p.54
- The remote control does not work  p.55



■ Problems relating to images



■ No images appear

Check	Remedy
Was the [Power] button pressed?	Press the [Power] button to turn the power on.
Are both indicators switched off?	The power cable is not connected correctly or power is not being supplied normally. Connect the projector's power cable correctly. (See the <i>Quick Setup sheet</i>) Check that your power supply socket is working.
Is A/V Mute mode active?	Press the [A/V Mute] button on the remote control to cancel the mute.  p.22
Have the configuration menu settings been made correctly?	Reset all of the settings. "Reset" - "Reset All"  p.41
Is the projected image completely black? Only when projecting computer images	Some input images, such as screen savers, may be completely black.
Are the image signal format settings correct? Only when projecting images from a video source	If a composite video or S-Video source is connected to the projector, use the "Video Signal" menu command to select the signal format. "Signal" - "Video Signal"  p.36

■ Projection stops automatically

Check	Remedy
Is "Sleep Mode" set to "ON"?	When the "Sleep Mode" menu command has been set to "ON," the lamp turns off automatically if no buttons are pressed for about 30 minutes while no video signal is being input. The Power indicator is lit orange at this time. Press the [Power] button to turn the power on. If you do not want sleep mode to be used, change the "Sleep Mode" setting to "OFF." "Extended" - "Operation" - "Sleep Mode"  p.39

■ The message “Not Supported.” is displayed

Check	Remedy
<p>Are the image signal format settings correct?</p> <p>Only when projecting images from a video source</p>	<p>If a composite video or S-Video source is connected to the projector, use the “Video Signal” menu command to select the signal format. “Signal” - “Video Signal”  p.36</p>
<p>Does the mode match the frequency and resolution of the image signals?</p> <p>Only when projecting computer images</p>	<p>Refer to the documentation provided with your computer for details on changing the resolution and frequency of the image signals being output from the computer. “List of Supported Monitor Displays”  p.73</p>



■ The message “No Signal.” is displayed

Check	Remedy
<p>Are the cables connected correctly?</p>	<p>Check that all of the cables required for projection are securely connected. (See the Quick Setup sheet)</p>
<p>Has the correct video input port been selected?</p>	<p>Press the [Computer], [S-Video], or [Video] button on the remote control or the [Source Search] button on the remote control or the projector's control panel to change the image.  p.20</p>
<p>Is the power for the computer or video source turned on?</p>	<p>Turn the power on for the devices.</p>
<p>Are the image signals being output to the projector?</p> <p>Only when projecting images from a laptop computer or computer with a built-in LCD screen</p>	<p>If the image signals are only being output to the computer’s LCD monitor or to the accessory monitor, you need to change the output to an external destination as well as the computer's own monitor. For some computer models, when the image signals are output externally, they no longer appear on the LCD monitor or accessory monitor. (See your computer documentation, under a title such as “External output” or “Connecting an external monitor”)</p> <p>If the connection is made while the power is already turned on, the function [Fn] key that switches the computer's video signal to external output may not work. Turn the power for the projector and the computer off and then back on again. (See the Quick Setup sheet)</p>





■ Images are fuzzy or out of focus

Check	Remedy
Has the focus been adjusted correctly?	Turn the focus ring on the projector to adjust the focus.
Is the lens cover still attached?	Remove the lens cover.
Is the projector at the correct distance?	The recommended projection distance ranges from 2.9 ft (87 cm) to 39.8 ft (1212 cm). (See the Quick Setup sheet)
Is the keystone adjustment value too large?	Decrease the projection angle to reduce the amount of keystone correction.
Is the zoom adjustment value too small?	Enlarge the zoom adjustment value.
Has condensation formed on the lens?	If the projector is suddenly taken from a cold environment to a warm environment or if sudden ambient temperature changes occur, condensation may form on the surface of the lens, and this may cause the images to appear fuzzy. Set the projector up in the room approximately one hour before it is to be used. If condensation forms on the lens, turn the power off and wait for the condensation to disappear.





■ Interference or distortion appears in images

Check	Remedy
<p>Are the image signal format settings correct?</p> <p>Only when projecting images from a video source</p>	If a composite video or S-Video source is connected to the projector, use the "Video Signal" menu command to select the signal format. "Signal" - "Video Signal"  p.36
Are the cables connected correctly?	Check that all of the cables required for projection are securely connected. (See the Quick Setup sheet)
Is an extension cable being used?	If an extension cable is used, electrical interference may affect the signals. Use the accessory cables and check if this helps.
<p>Has the correct resolution been selected?</p> <p>Only when projecting computer images</p>	Set the computer so that the signals that are output are compatible with this projector. "List of Supported Monitor Displays"  p.73 (See your computer documentation)
<p>Have the "Sync." and "Tracking" settings been adjusted correctly?</p> <p>Computer and RGB video signals only</p>	Press the [Auto] button on the remote control or the [Enter] button on the projector's control panel to carry out automatic adjustment. If the images have not been adjusted correctly after using automatic adjustment, you can make the adjustments using the "Sync." and "Tracking" menus.  p.14 , p.15





■ Image is too large and cut off, or too small

Check	Remedy
<p>Has the “Aspect ratio” been set correctly?</p>	<p>Press the [Resize] button on the remote control.  p.23</p>
<p>Is the image still being enlarged by the E-Zoom function?</p>	<p>Press the [Esc] button on the remote control to cancel the E-Zoom function.  p.24</p>
<p>Has the “Position” setting been adjusted correctly?</p>	<p>If analog RGB images from a computer or RGB video images are being projected, press the [Auto] button on the remote control or the [Enter] button on the projector’s control panel to carry out automatic adjustment. If the images have not been correctly adjusted after using the automatic setup function, adjust the setting manually using the “Position” menu command. If signals other than analogue RGB images from a computer or RGB video images are being input, adjust the setting manually using the “Position” menu command. “Signal” - “Position”  p.36</p>
<p>Has the computer been set for dual display?</p> <p>Only when projecting computer images</p>	<p>If dual display has been activated in the Display Properties of the computer’s Control Panel, the projector will only project about half of the image on the computer screen. To display the whole of the image on the computer screen, turn off the dual display setting. (See your computer video driver documentation)</p>
<p>Has the correct resolution been selected?</p> <p>Only when projecting computer images</p>	<p>Set the computer so that the signals that are output are compatible with this projector. “List of Supported Monitor Displays”  p.73 (See your computer documentation)</p>

■ Image colors are not right

Check	Remedy
Do the input signal settings match the signals from the connected device?	If a composite video or S-Video source is connected to the projector, use the “Video Signal” menu command to select the video signal format. “Signal” - “Video Signal”  p.36
Has the image brightness been adjusted correctly?	Use the “Brightness” menu command to adjust the brightness. “Image” - “Brightness”  p.35
Are the cables connected correctly?	Check that all of the cables required for projection are securely connected. (See the Quick Setup sheet .)
Has the image contrast been adjusted correctly?	Use the “Contrast” menu command to adjust the contrast. “Image” - “Contrast”  p.35
Has the color been adjusted correctly?	Use the “Color Adjustment” menu command to adjust the color. “Image” - “Color Adjustment”  p.35
Have the color intensity and tint been adjusted correctly?	Use the “Color Intensity” and “Tint” menu commands to adjust the color and tint. “Image” - “Color Intensity,” “Tint”  p.35
<div style="background-color: #333; color: white; padding: 5px; display: inline-block;">Only when projecting images from a video source</div>	

■ Images appear dark

Check	Remedy
Have the image brightness and luminance been adjusted correctly?	Use the “Brightness” and “Brightness Control” menu commands to adjust the brightness and luminance. “Image” - “Brightness”  p.35 “Settings” - “Brightness Control”  p.37
Has the image contrast been adjusted correctly?	Use the “Contrast” menu command to adjust the contrast. “Image” - “Contrast”  p.35
Is the lamp due for replacement?	When the lamp is nearly due for replacement, the images will become darker and the color quality will become poorer. When this happens, the lamp should be replaced with a new one.  p.61

■ Nothing appears on the external monitor

Check	Remedy
Are images from a port other than the Computer port being projected?	The only images that can be displayed on an external monitor are those from the Computer port. You cannot output video equipment images to an external monitor.  p.68

■ Problems when projection starts

■ Power does not turn on

Check	Remedy
Have you pressed the [Power] button?	Press the [Power] button to turn the power on.
Are all of the indicators switched off?	The power cable is not connected correctly or power is not being supplied. Connect the power cable to the projector correctly. (See the <i>Quick Setup sheet</i>) Alternatively, check the circuit breaker to see if power is being supplied.
Do the indicators turn off and on when the power cable is touched?	There is probably a poor contact in the power cable, or the power cable may be defective. Reinsert the power cable. If this does not solve the problem, stop using the projector, disconnect the power cable from the wall outlet and contact Epson. 🖱️ p.56

■ Other problems

■ No sound can be heard or the sound is faint

Check	Remedy
Is the audio source connected correctly?	Check that the cable is connected to the Audio port.
Has the volume been adjusted to the minimum setting?	Adjust the volume so that sound can be heard. 🖱️ p.19
Is A/V Mute mode active?	Press the [A/V Mute] button on the remote control to cancel the A/V mute function. 🖱️ p.22

■ The remote control does not work

Check	Remedy
Is the remote control facing towards the remote control light-receiving area on the projector when it is operated?	Face the remote control towards the remote control light-receiving area. The operating angle for the remote control is approximately $\pm 30^\circ$ horizontally and approximately $\pm 15^\circ$ vertically.
Is the remote control too far from the projector?	The operating range for the remote control is approximately 20 ft (6 m).
Is direct sunlight or strong light from fluorescent lamps shining onto the remote control light-receiving area?	Set the projector up in a location where strong light will not shine onto the remote control light-receiving area.
Are the batteries dead, or have the batteries been inserted correctly?	Insert new batteries, while making sure that they are inserted in the correct direction.  p.60
Has a remote control button been pressed for more than 30 seconds?	If any of the buttons on the remote control are pressed down for more than 30 seconds, the remote control stops sending signals (remote control's sleep mode). The purpose of this is to prevent the batteries from being consumed due to something being placed on top of the remote control. When the button is released, normal remote control operation will resume.

Where to Get Help

Epson provides technical assistance through electronic support services 24 hours a day, as listed in the following table.

Service	Access
World Wide Web	From the Internet, you can reach Epson's product support page at http://support.epson.com . After selecting your product, you can access troubleshooting information, download product documentation, and receive technical advice through FAQs and e-mail.
Presenters Online	Access tips, templates, and training for developing successful presentations at http://www.presentersonline.com

Telephone Support Services

To use the Epson PrivateLine Support service, call (800) 637-7661 and enter the PIN on the included Epson PrivateLine Support card. This is the fastest way of speaking to a live representative, and it's free. This service is available 6 AM to 6 PM, Pacific Time, Monday through Friday, for the duration of your warranty period.

You may also speak with a projector support specialist by dialing one of these numbers:

- U.S.: (562) 276-4394, 6 AM to 6 PM, Pacific Time, Monday through Friday
- Canada: (905) 709-3839, 6 AM to 6 PM, Pacific Time, Monday through Friday

Toll or long distance charges may apply.

Before you call, please have the following information ready:

- Product name (Epson PowerLite S3)
- Product serial number (located on the bottom of the projector)
- Computer or video configuration
- Description of the problem

You can purchase screens, carrying cases, or other accessories from Epson at (800) 873-7766 or by visiting the Epson Store at www.epsonstore.com (U.S. sales only). In Canada, please call (800) 463-7766 for dealer referral.

Appendices

This chapter provides information on maintenance procedures to ensure the best level of performance from the projector.

Setting Up the Projector

The projector supports the following four different projection methods, allowing you to choose the best method for displaying your images.

CAUTION

- *Before setting up the projector, make sure you read the Important Safety Instructions first. [p.76](#)*
- *Do not set this projector up on its side to carry out projection, otherwise malfunctions may occur.*

- Front projection (Front projection)

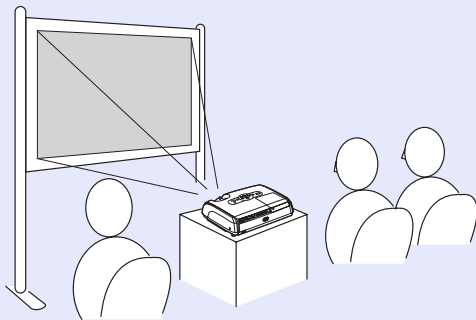

- Rear projection using a translucent screen (Rear projection)

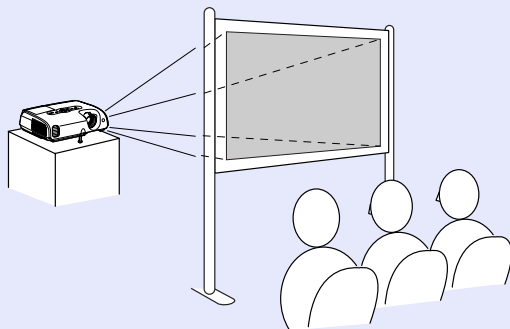

- Front/ceiling projection (Front/Ceiling projection)

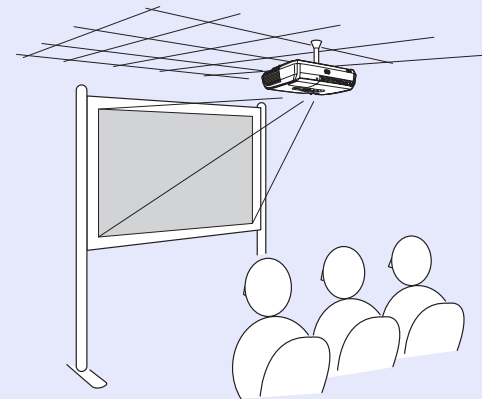

- Rear/ceiling projection using a translucent screen (Rear/Ceiling projection)

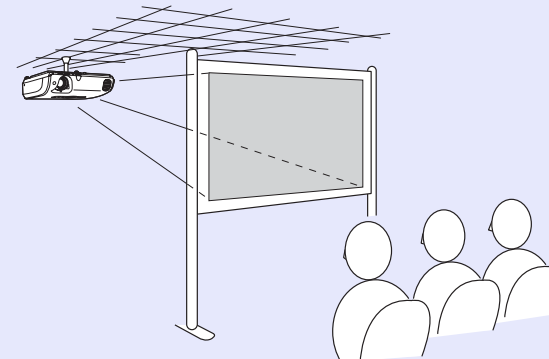

- * A special method of installation is required for suspending the projector from a ceiling. Please contact your supplier if you would like to use this installation method. The optional ceiling mount is required when installing the projector on a ceiling. [p.69](#)



TIP

When using ceiling projection or projection using a translucent screen, set the "Projection" command in the "Extended" menu to match the installation method.

[p.38](#)

This section describes maintenance tasks such as cleaning the projector and replacing consumable parts.

Cleaning

You should clean the projector if it becomes dirty or if the quality of projected images starts to deteriorate.

CAUTION *Make sure you read the Safety Instructions [p.76](#) before cleaning.*

Cleaning the Projector's Surface

Clean the projector's surface by wiping it gently with a soft cloth. If the projector is particularly dirty, moisten the cloth with water containing a small amount of neutral detergent, and then firmly wring the cloth dry before using it to wipe the projector's surface. Then wipe it again with a soft, dry cloth.

CAUTION *Do not use volatile substances such as wax, alcohol or thinner to clean the projector's surface. These can cause the projector to warp and make the coating finish peel off.*

Cleaning the Lens

Use a commercially-available air blower, or use a lens cleaning paper to gently wipe the lens.

CAUTION *Do not rub the lens with harsh materials or subject the lens to shocks, as it can easily become damaged.*

Cleaning the Air Filters and Air Intake Vent

If dust collects on the air filter or the air outlet, it can cause the internal temperature of the projector to rise, and this can lead to problems with operation and shortening of the optical engine's service life. It is recommended that you clean these parts at least once every three months. Clean them more often than this if using the projector in particularly dusty environments.

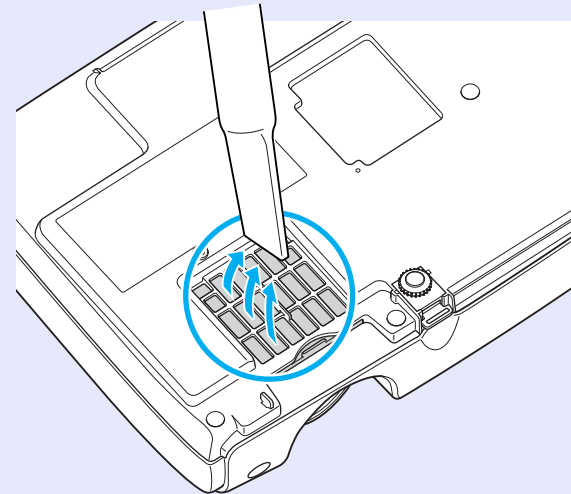

TIP

If the air filters are broken or if the warning message reappears after they have been cleaned, they should be replaced. Replace with a new air filter. See “Replacing the Air Filter.” [p.65](#)

Replacing Consumables

This section explains how to replace the remote control batteries, the lamp, and the air filters.

Replacing the batteries

If delays in the responsiveness of the remote control occur or if it does not operate after it has been used for some time, it probably means that the batteries are becoming flat. Replace the batteries. Have two spare AAA-size alkaline batteries ready to use when required.

CAUTION *Make sure you read the Safety Instructions [p.76](#) before handling the batteries.*

PROCEDURE

1 Remove the battery cover.

While pushing the catch of the battery compartment cover, lift the cover up.

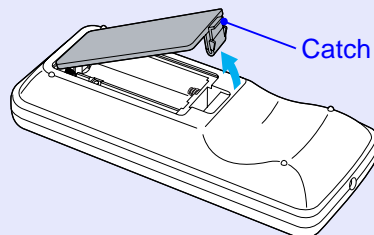

2 Insert the batteries.

Check the positions of the (+) and (-) marks inside the battery holder to ensure that the batteries are inserted the correct way.

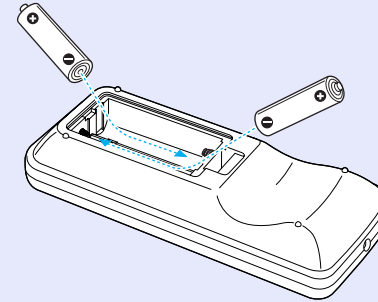

3 Replace the battery cover.

Press the battery compartment cover until it clicks into place.

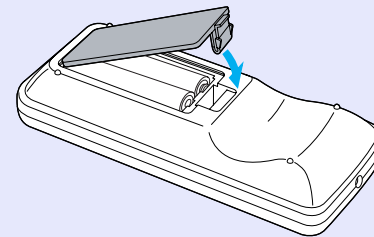

Lamp Replacement Period

It is time to replace the lamp when:

- The message "Replace the Lamp." appears on the screen when projection starts

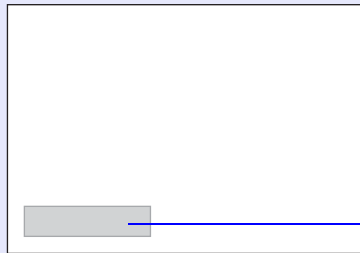

A message will be displayed.

- When the Lamp indicator is flashing orange

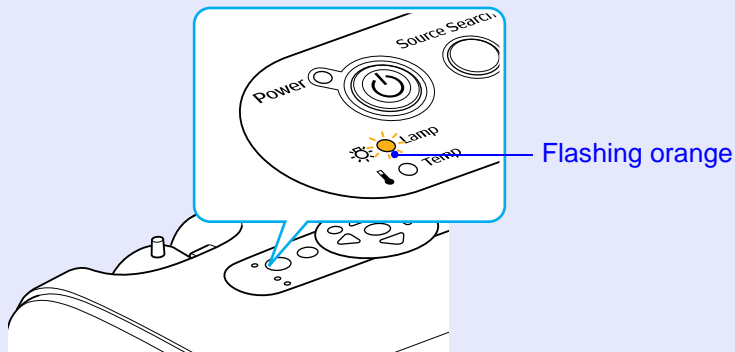

- The projected image gets darker or starts to deteriorate



TIP

- *The lamp replacement message is set to appear after the following periods of time in order to maintain the initial brightness and quality of the projected images. "Brightness Control" p.37*
 - *When used continuously at high brightness: Approx. 1900 hours*
 - *When used continuously at low brightness: Approx. 2900 hours*
- *If you continue to use the lamp after this period, the possibility of the lamp breaking becomes greater. When the lamp replacement message appears, replace the lamp with a new one as soon as possible, even if it is still working.*
- *Depending on the characteristics of the lamp and on the way it has been used, the lamp may become darker or stop working before the lamp warning message appears. You should always have a spare lamp ready in case it is needed.*
- *Contact your dealer for a spare lamp.*

Replacing the Lamp

CAUTION

- *If you are replacing the lamp because it has stopped working, it is possible that the lamp is broken. If replacing the lamp of a projector which has been installed on a ceiling, you should always assume that the lamp is broken and be extremely careful when removing the lamp cover.*
- *Wait until the lamp has cooled down sufficiently before removing the lamp cover. To give the lamp enough time to cool down after turning off the power, wait for about one hour.*

PROCEDURE

- 1 After you turn off the projector's power, and the confirmation buzzer beeps twice, disconnect the power cable.

- 2 Wait until the lamp has cooled down, then remove the lamp cover from the base of the projector.

Loosen the lamp cover screw with the screwdriver that is supplied with the spare lamp (or your own cross head [Phillips] screwdriver).

Then slide the lamp cover straight forward and lift it to remove.

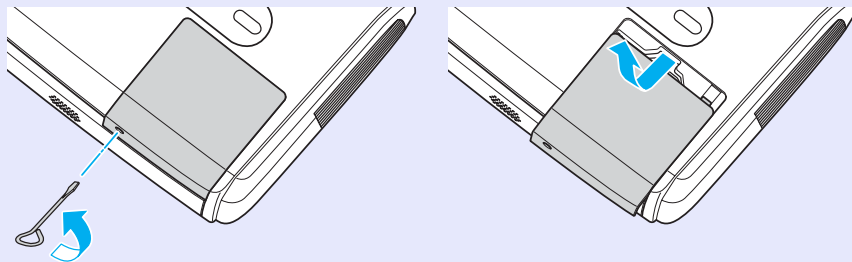

- 3 Loosen the two lamp screws.

Loosen the two lamp screws with the screwdriver that is supplied with the spare lamp (or your own cross head [Phillips] screwdriver).

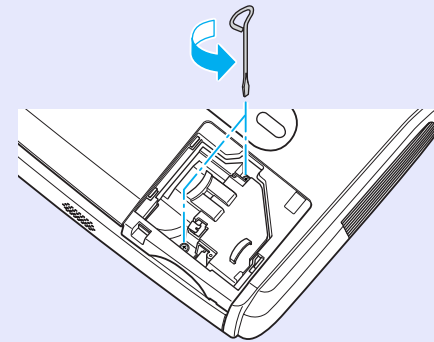

- 4 Take out the lamp.

Hold the lamp as shown in the illustration below and lift it up and out of the projector.

If the lamp is broken, replace it with a new lamp, or contact your local dealer for further advice. If replacing the lamp yourself, be careful to avoid pieces of broken glass.

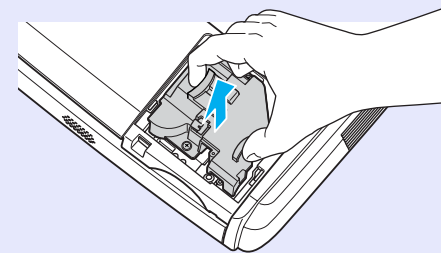

5 Install the new lamp.

Insert the new lamp so that it fits in place correctly. Once it is fully inserted, tighten the two screws.

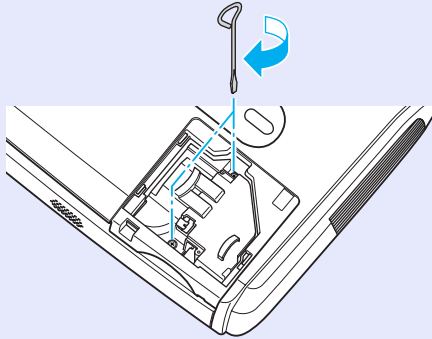
**6** Install the lamp cover.

Slide the lamp cover onto the projector and tighten the cover screw.

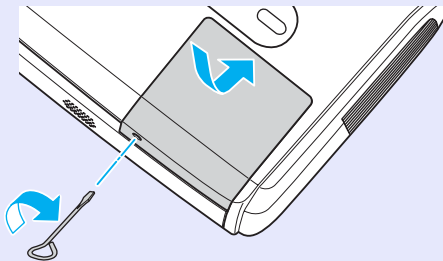
**TIP**

- *Install the lamp securely. If the lamp cover is removed, the lamp turns off automatically as a safety precaution. Moreover, the lamp will not turn on if the lamp or the lamp cover is not installed correctly.*
- *The lamp contains mercury. Dispose of used lamps properly in accordance with your local regulations.*

Resetting the Lamp Operating Time

The projector has a built-in counter which keeps track of the lamp operating time. When the cumulative operating time reaches a certain point, it causes the replacement warning message to be displayed. Therefore, the counter needs to be reset after the lamp has been replaced with a new one. You can do this using the configuration menu.



Do not reset the lamp operating time except after the lamp has been replaced, otherwise the lamp replacement period will not be indicated correctly.

PROCEDURE

1 Connect the power cable and turn on the projector.

2 Select “Reset” from the configuration menu, and then select “Lamp-Hours reset.”

For details on this operation, refer to “Using the Configuration Menu.” p.34

Check the buttons you can use, and the operations they perform, in the guide at the bottom of the screen.

Remote control

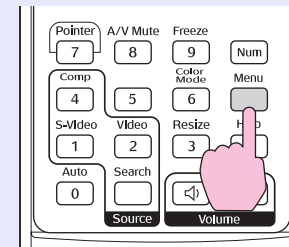

Control panel

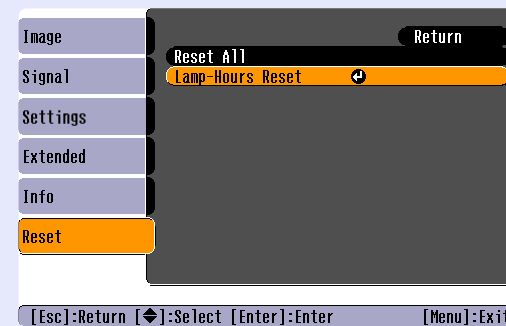
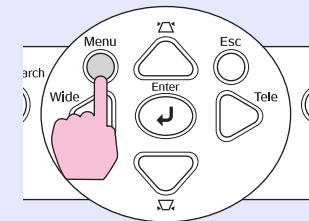

3 When “Execute?” appears, select “Yes.”

The lamp operating time will then be reset.



■ Replacing the Air Filter

If the air filters are broken or if the warning message reappears after they have been cleaned, they should be replaced.

The air filter can be replaced even if the projector is installed on a ceiling.

PROCEDURE

- 1 Turn off the projector's power. When the confirmation buzzer beeps twice, disconnect the power cable.

- 2 Remove the air filter.
Put your finger into the recess of the air filter and slide it forward to remove it.

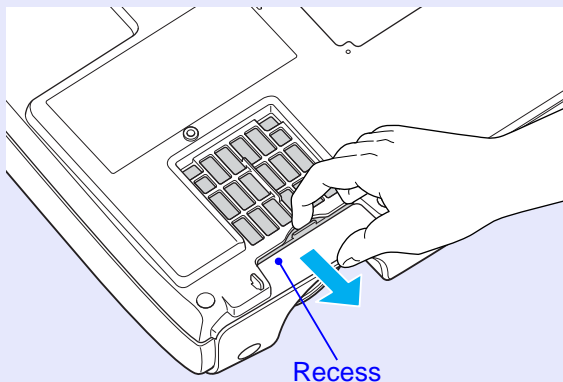

- 3 Install the new air filter.
Slide the air filter covers in from the outside and push them in until they click into place.

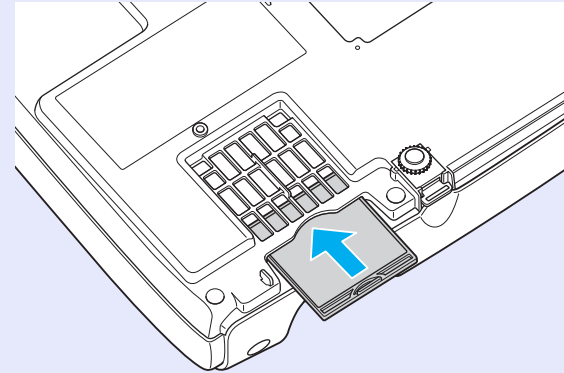

Dispose of used air filters properly in accordance with your local regulations.

*Air filter frame: Polycarbonate, ABS plastic
Filter: Polyurethane foam*

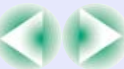

You can record the image that is currently being projected as a user's logo.



When a user's logo is recorded, the previous user's logo will be erased.

PROCEDURE

- 1 Project the image you would like to use as the user's logo, and then display the configuration menu.

Remote control

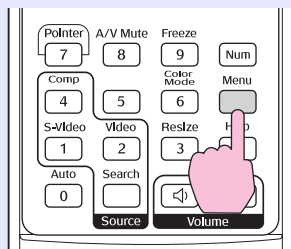

Control panel

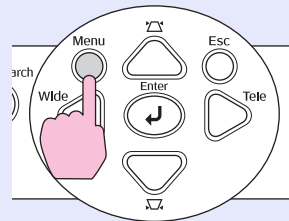

- 2 Select "Extended" from the configuration menu, and then select "User's Logo."

For details on this operation, refer to "Using the Configuration Menu." [p.34](#)

Check which buttons on the remote control or the control panel you can use, and the operations they perform, in the guide at the bottom of the screen.

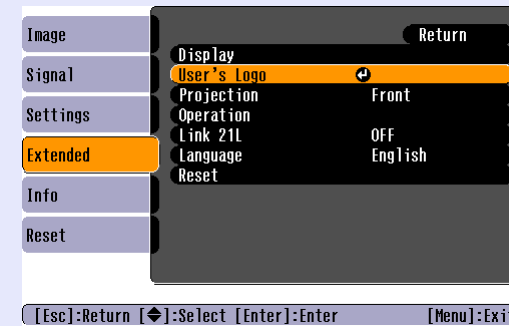

- If the "User's Logo Protect" function of "Password Protect" is set to "ON," a message is displayed and the user's logo cannot be recorded. To record a user's logo, set "User's Logo Protect" to "OFF" first. [p.30](#)
- If keystone correction, Zoom adjustment, or E-Zoom and so on, have been carried out, the function currently being performed is cancelled when the "User's Logo" menu is selected.

- When “Choose this image as the User's Logo?” appears, select “Yes.”



TIP

When you press the [Enter] button on either the remote control or the projector's control panel, the image will be displayed at its original resolution, so if a signal with a resolution that is different from the current resolution of the projector is projected, or if a video image is being projected, the display size will change.

- The image to be recorded and a selection marquee box will be displayed. Move the marquee box to select the part of the image to use.



Remote control

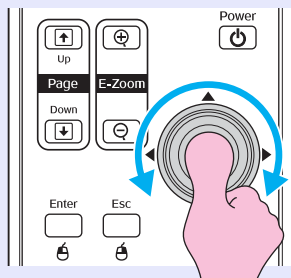

Control panel

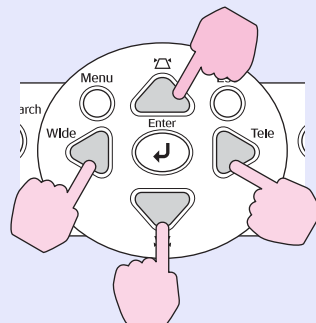

TIP

User's logos can be saved at up to 400 × 300 dots in size.

- When “Select this image?” appears, select “Yes.”
- Select the zoom rate from the Zoom rate setting screen.

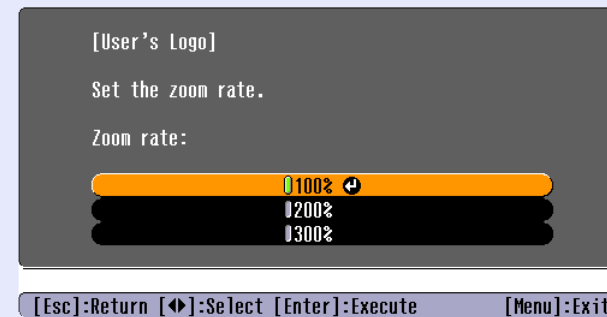

- When “Save this image?” is displayed, select “Yes.”
The image will then be saved. Once the image has been saved, the message “Completed.” will be displayed.



TIP

- Saving the user's logo may take a few moments (about 15 seconds). Do not use the projector or any other sources which are connected to the projector while the user's logo is being saved, otherwise it may result in errors in projector operation.
- Once a user's logo has been saved, the logo setting cannot be returned to the factory default.

Checking Projected Images on an External Monitor (Monitor Output)

While performing presentations and so on, you can check analog RGB images and RGB video images from a computer being input to the "Computer/Component Video" terminal by connecting an external monitor to this projector.

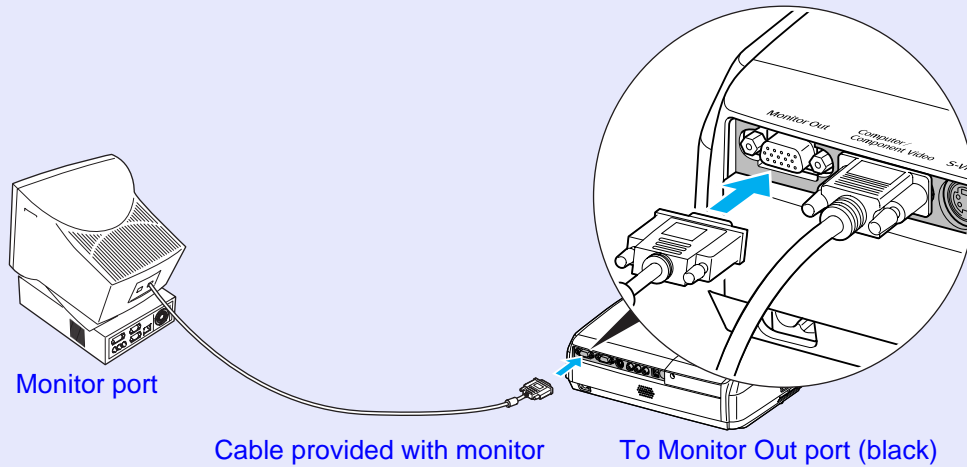

TIP

- *Component video, S-Video, and component video images cannot be output to an external monitor.*
- *The setting gauge for keystone correction and the configuration menus and help menus are not output to the external monitor.*



Optional Accessories and Consumables

You can purchase screens, carrying cases, or other accessories from an Epson authorized reseller. For product information and to find the nearest authorized reseller, please call 800-GO-EPSON (800-463-7766) or browse our catalog of products at www.epson.com, select the product you are interested in, and click "Where to Buy." To purchase online, please visit the Epson Store at www.epsonstore.com (U.S. sales only). In Canada, please call 800-463-7766 for a reseller referral. This list of optional accessories is current as of January 2005. Details of accessories are subject to change without notice.

Part Number	Part Name
V13H010L33	Replacement lamp
V13H134A08	Air filter set (2)
ELPSC06	50" Portable screen (4:3 aspect ratio)
ELPSC07	60" Portable pop-up screen (4:3 aspect ratio)
ELPSC08	80" Portable pop-up screen (4:3 aspect ratio)
ELPSC09	83.6" Hanging pull-down screen (4:3 aspect ratio)
ELPMBUNI	Ceiling mount
ELPMBFCP	False ceiling plate
ELPMBSEC	Ceiling mount secure cable kit
ELPMBAPL	Suspension adapter
ELPMBACC	Adjustable Ceiling Channel
ELPSV01	S-Video cable
ELPKC19	Component video cable (9.8 feet/3 m) for mini D-Sub 15-pin/RCA×3
ELPDA010	Distribution amplifier
ELPKS35-S	Samsonite wheeled softcase
ELPKS43	Samsonite soft shoulder case for projector and notebook
ELPKS54	ATA molded hardshell case
V12H162020	ELPDC05 High resolution document imager
ELPSL01	Kensington security lock



The following is an explanation of some of the terms used in this guide which may be unfamiliar or which are not explained in the text of this guide itself. Further information can be obtained by referring to other commercially-available publications.

Aspect ratio	The ratio between an image's length and its height. HDTV images have an aspect ratio of 16:9 and appear elongated. The aspect ratio for standard images is 4:3.
Color Temp.	The temperature of an object that is emitting light. If the colour temperature is high, the colours take on a bluish tinge. If the colour temperature is lower, the colours take on a reddish tinge.
Component video	Video signals which have the video brightness signals and colour signals separated, in order to provide better image quality. In high-definition TV (HDTV), it refers to images which consist of three independent signals: Y (luminance signal), Pb, and Pr (colour difference signals).
Composite video	Video signals which have the video brightness signals and colour signals mixed together. The type of signals commonly used by household video equipment (NTSC, PAL and SECAM formats). The carrier signal Y (luminance signal) and chroma (colour) signal which are contained in the colour bar are overlapped to form a single signal.
Contrast	The relative brightness of the light and dark areas of an image can be increased or decreased in order to make text and graphics stand out more clearly, or to make them appear softer. Adjusting this particular property of an image is called "contrast adjustment."
Dolby Digital	A sound format developed by Dolby Laboratories. Normal stereo is a 2-channel format which uses two speakers. Dolby Digital is a 6-channel (5.1-channel) system which adds to this a centre speaker two rear speakers and a sub-woofer.
HDTV	An abbreviation for High-Definition Television. It refers to high-definition systems which satisfy the following conditions. <ul style="list-style-type: none"> • Vertical resolution of 750p or 1125i or greater (p = progressive, i = interlaced) • Screen aspect ratio of 16:9 • Dolby Digital audio reception and playback (or output)
Interlaced	A method of image scanning whereby the image data is divided into fine horizontal lines which are displayed in sequence starting from left to right and then from the top to the bottom of the screen. The even-numbered lines and odd-numbered lines are displayed alternately.
Progressive	A method of image scanning whereby the image data from a single image is scanned sequentially from top to bottom to create a single image.
Refresh rate	The light-emitting element of a display maintains the same luminosity and colour for an extremely short time. Because of this, the image must be scanned many times per second in order to refresh the light-emitting element. The number of refresh operations per second is called the "refresh rate", and is expressed in hertz (Hz).
SDTV	An abbreviation for Standard Definition Television. It refers to standard television systems which do not satisfy the conditions for High-Definition Television.
Security lock	A device consisting of a projector case with a hole in it that a commercially-available theft-prevention cable can be passed through in order to secure the device to a table or pillar. This projector is compatible with the Microsaver Security System manufactured by Kensington.

Squeeze mode	In this mode, wide-screen images in 16:9 mode are compressed in the horizontal direction so that they are stored on the recording medium as 4:3 images. When these images are played back by the projector in squeeze mode, they are restored to their original 16:9 format.
sRGB	An international standard for colour intervals that was formulated so that colours which are reproduced by video equipment can be handled easily by computer operating systems (OS) and the Internet. If the connected source has a sRGB mode, set both the projector and the connected signal source to sRGB.
SVGA	A type of video signal with a resolution of 800 (horizontal) × 600 (vertical) dots which is used by IBM PC/AT-compatible computers.
S-Video	A video signal which has the luminance component and colour component separated in order to provide better image quality. It refers to images which consist of two independent signals: Y (luminance signal), and C (colour signal).
SXGA	A type of video signal with a resolution of 1280 (horizontal) × 1024 (vertical) dots which is used by IBM PC/AT-compatible computers.
Sync (synchronisation)	The signals output from computers and RGB video equipment have a specific frequency. If the projector frequency does not match this frequency, the resulting images will not be of a good quality. The process of matching the phases of these signals (the relative position of the crests and troughs in the signal) is called “synchronisation.” If the signals are not synchronized, problems such as flickering, blurriness and horizontal interference can occur.
Tracking	The signals output from computers and RGB video equipment have a specific frequency. If the projector frequency does not match this frequency, the resulting images will not be of a good quality. The process of matching the frequency of these signals (the number of crests in the signal) is called "tracking". If tracking is not carried out correctly, wide vertical stripes will appear in the projected images.
USB	An abbreviation for Universal Serial Bus. USB is an interface for connecting personal computers to peripheral devices which only support relatively low data transmission speeds.
VGA	A type of video signal with a resolution of 640 (horizontal) × 480 (vertical) dots which is used by IBM PC/AT-compatible computers.
XGA	A type of video signal with a resolution of 1024 (horizontal) × 768 (vertical) dots which is used by IBM PC/AT-compatible computers.

Command List

When a power on command is sent to the projector, the power will turn on and the projector will change to warm-up mode. When the power has turned on, a colon ":" (3Ah) will be returned.

When the projector executes a command, it returns a ":" and waits for the next command to be sent.

If command processing terminates with an error, the projector outputs an error message and then returns the ":" code.

	Item	Command
Power ON/OFF	ON	PWR ON
	OFF	PWR OFF
Signal selection	Computer (Auto)	SOURCE 1F
	Computer	SOURCE 11
	Component Video	SOURCE 14
	Video	SOURCE 41
	S-Video	SOURCE 42
A/V Mute ON/OFF	ON	MUTE ON
	OFF	MUTE OFF
A/V Mute Selection	Black	MSEL 00
	Blue	MSEL 01
	User's Logo	MSEL 02

* When issuing any of the above commands, tack a Carriage Return (CR) code (0Dh) on to the end.

Cable Layouts

■ USB connection

Connector shape: USB (type B)

<At the projector>

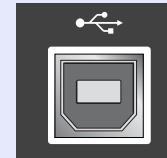

(type B)

<At the computer>

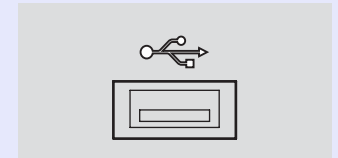

Computer/RGB Video

Signal	Refresh rate [▶] (Hz)	Source Resolution (dots)	Projected Resolution ^{*2} (dots)
VGA[▶]	60	640 × 480	800 × 600
VGAEGA		640 × 350	800 × 438
VESA	60/72/75/85,iMac ^{*1}	640 × 480	800 × 600
SVGA[▶]	56/60/72/75/85,iMac ^{*1}	800 × 600	800 × 600
XGA[▶]	60/70/75/85,iMac ^{*1}	1024 × 768	800 × 600
SXGA[▶]	70/75/85	1152 × 864	800 × 600
SXGA	60/75/85	1280 × 960	800 × 600
SXGA	60/75/85	1280 × 1024	750 × 600
MAC13"		640 × 480	800 × 600
MAC16"		832 × 624	800 × 600
MAC19"		1024 × 768	800 × 600
MAC19"	60	1024 × 768	800 × 600
MAC21"		1152 × 870	794 × 600
SDTV[▶] (625i)	50	720 × 576	800 × 600
SDTV(525i)	60	720 × 480	800 × 600
SDTV(525p)	60	640 × 480	800 × 600
HDTV[▶] (750p)	60	1280 × 720	800 × 450
HDTV(1125i)	60	1920 × 1080	800 × 450

*1:Connection is not possible if the equipment does not have a VGA output port.

*2:Maximum Zoom

The projection of some signals not listed in the table may still be possible. However, not all functions may be supported.

Component Video/RGB Video

Signal	Refresh rate [▶] (Hz)	Resolution (dots) ^{*2}	
		Aspect ratio [▶] 4:3	Aspect ratio 16:9
SDTV[▶] (525i) (D1)	60	800 × 600	800 × 450
SDTV (625i)	50	800 × 600	800 × 450
SDTV (525p) (D2)	60	800 × 600	800 × 450
HDTV[▶] (750p) 16:9 (D4)	60	800 × 600	800 × 450
HDTV (1125i) 16:9 (D3)	60	800 × 600	800 × 450

Composite Video/S-Video

Signal	Refresh rate [▶] (Hz)	Resolution (dots) ^{*2}	
		Aspect ratio [▶] 4:3	Aspect ratio 16:9
TV (NTSC)	60	800 × 600	800 × 450
TV (PAL, SECAM)	50	800 × 600	800 × 450

Product name	PowerLite S3		
Dimensions	327 (W) × 86 (H) × 246 (D) mm (not including feet)		
Panel size	0.5 inches		
Display method	Polysilicon TFT active matrix		
Resolution	SVGA 480,000 pixels (800 (W) × 600 (H) dots) × 3		
Focus adjustment	Manual		
Zoom adjustment	Electronic (approx. 1:1.35)		
Lamp (light source)	UHE lamp, 135 W, Model No.: ELPLP33		
Max. audio output	1W monaural		
Speaker	1		
Power supply	100-240VAC 50/60Hz 1.0-2.2A Power Consumption Operating: 200W(100 to 240 V area) Standby : 4.8W(100 to 240 V area)		
Operating temperature	+5°– +35°C (41°–95°F) (No condensation)		
Storage temperature	-10°– +60°C (14°–140°F) (No condensation)		
Weight	Approx. 2.5 kg		
Connectors	Computer:	1	Mini D-Sub 15-pin (female) Blue
	S-Video:	1	Mini DIN 4-pin
	Video:	1	RCA pin jack
	Audio Input:	1	RCA pin jack×2 (L,R)
	USB*:	1	USB connector (B series)
	Monitor Out :	1	Mini D-Sub 15-pin (female) Black

* The USB interface complies with the USB 1.1 standard.
The USB connector is not guaranteed to operate correctly with all USB-compatible devices.



Pixelworks DNX™ ICs are used in this Projector.

Angle of tilt

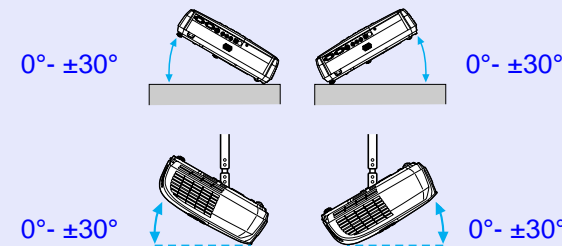

If you set the projector higher than 30°, it could damage the projector and cause an accident.

Safety

USA
UL60950 Third Edition
Canada
CSA C22.2 No.60950
European Community
The Low Voltage Directive
(73/23/EEC)
IEC60950 3rd Edition

EMC

USA
FCC Part 15B Class B (DoC)
Canada
ICES-003 Class B
European Community
The EMC Directive
(89/336/EEC)
EN55022, 1998 Class B
EN55024, 1998
IEC/EN61000-3-2
IEC/EN61000-3-3

Australia/New Zealand
AS/NZS CISPR 22:2002 Class B

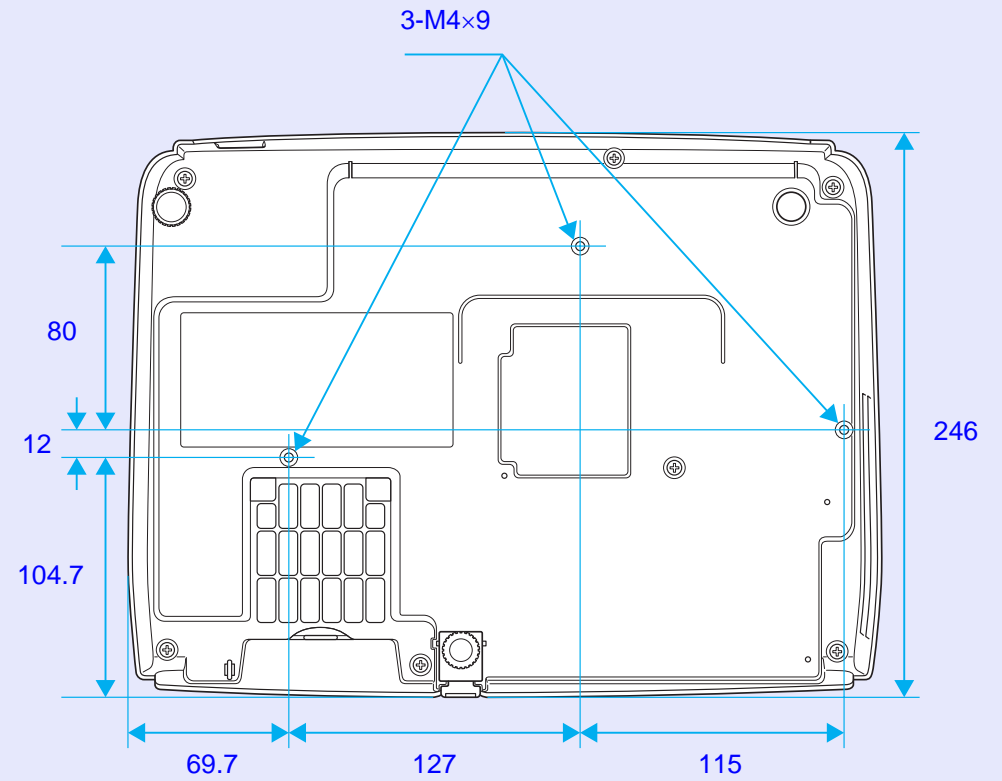
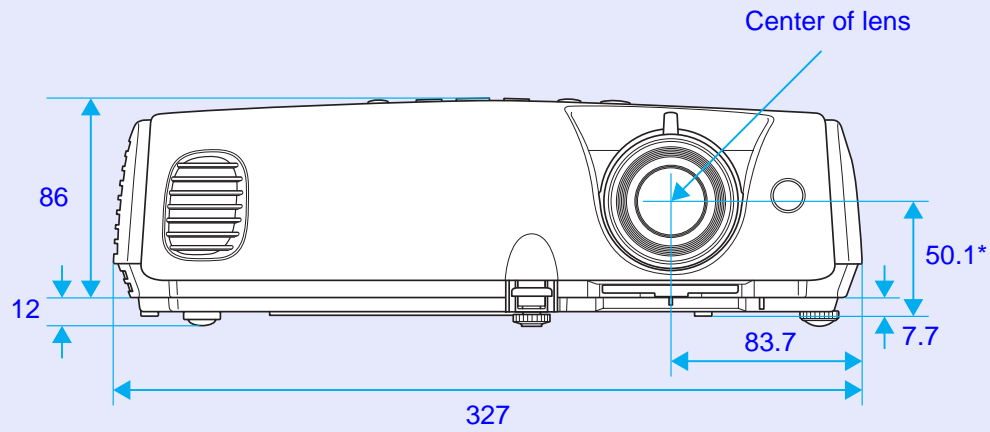

*Distance from center of lens to suspension bracket fixing point

Units: mm



Please read the following important information about your projector.

CAUTION

- ***Never look into the projector lens when the lamp is switched on as the bright light can damage your eyes. Never let children look into the lens when it is on.***
- ***Never open any covers on the projector except the lamp cover. Dangerous electrical voltages inside the projector can cause severe injury. Except as specifically directed in the User's Guide supplied, do not attempt to service this product yourself. Refer all servicing to qualified service personnel.***
- ***Keep the plastic bags for the projector, accessories and optional parts out of the reach of children. Children covering their heads with bags may result in death by suffocation. Be particularly careful around small children.***
- ***When you replace the lamp, never touch the new bulb with your bare hands. The invisible residue left by the oil on your hands may be shorten the bulb life. Use a cloth or gloves to handle the new bulb.***

Follow these safety instructions when setting up and using the projector:

- Do not place the projector on an unstable cart, stand, or table.
- Do not stand on the projector or place heavy objects on it.
- Do not use the projector near water or sources of heat.
- Use attachments only as recommended.
- Use the type of power source indicated on the projector. If you are not sure of the power available, consult your dealer or local electricity company.
- Place the projector near a wall outlet where the plug can be easily unplugged.
- If the projector has a three-prong plug, insert the projector's three-pin grounding-type plug into a properly grounded outlet. If you have a two-prong outlet, contact an electrician to replace it.
- Take the following precautions when handling the plug. Failure to comply with these precautions could result in sparks or fire or electric shock.
 - Do not insert the plug into an outlet with dust present.
 - Insert the plug firmly into the outlet.
 - Do not overload wall outlets, extension cables or integral convenience receptacles. This can cause fire or electric shock.
 - Do not place the projector where the cable can be stepped on. It may result in fraying or damage to the plug.
 - Do not handle the plug with wet hands.
- Unplug the projector from the wall outlet before cleaning. Use a damp cloth for cleaning. Do not use liquid or aerosol cleaners.
- Do not block the slots and opening in the projector case. They provide ventilation and prevent the projector from overheating. Do not place the projector on a sofa, rug or other soft surface, or in a closed-in cabinet unless proper ventilation is provided.
- Never push objects of any kind through cabinet slots. Never spill liquid of any kind into the projector.
- Unplug the projector when it will not be used for extended periods.
- Do not place the projector and remote control on top of heat producing equipment or in a heated place, such as a car.
- Unplug the projector from the wall outlet and refer servicing to qualified service personnel under the following conditions:
 - When the power cable or plug is damaged or frayed
 - If liquid has been spilled into the projector, or it has been exposed to rain or water
 - If it does not operate normally when you follow the operating instructions, or if it exhibits a distinct change in performance, indicating a need for service
 - If it has been dropped or the housing has been damaged
- The internal projector components consist of many glass parts such as the lens and projection lamp.

- The lamp is fragile, and can easily break. If the lamp breaks, handle the projector with extreme care to avoid injury from broken glass, and contact your dealer or contact Epson for repairs.  p.56
Particular care should be taken when the projector is installed to a ceiling, as small pieces of glass may fall down when the lamp cover is removed. Be very careful not to allow such pieces of glass to get into the eyes or mouth.
 - Material or paper may get stuck against the air filter underneath the projector while it is in use. Remove anything from underneath the projector that might get stuck against the air filter in this way.
 - Never try to remove the lamp immediately after use.
Doing so will result in serious burns. Before removing the lamp, turn off the power supply and wait the time specified in the *User's Guide* to allow the lamp to cool completely.
 - A mercury lamp with high internal pressure is used as the projector's light source. Mercury lamps may make a loud noise when they break. Handle the lamp with extreme care while observing the following. If the following points are not observed, injury or poisoning may result.
 - Do not damage the lamp or subject it to any impacts.
 - Do not use the lamp after the lamp replacement period has elapsed. Once the lamp replacement period has elapsed, the possibility of the lamp breaking becomes greater. When the lamp replacement message appears, replace the lamp with a new one as soon as possible.
 - The gases inside mercury lamps contain mercury vapor. If the lamp breaks, immediately ventilate the room to prevent the gases that are released when the lamp breaks from being inhaled or coming into contact with the eyes or mouth.
 - Do not bring your face close to the projector while it is in use, in order to prevent the gases that are released when the lamp breaks from being inhaled or coming into contact with the eyes or mouth.
 - If the lamp breaks and needs to be replaced with a new lamp, contact the place of purchase or contact Epson  p.56 for information on replacement. If the lamp breaks, pieces of broken glass may get scattered around inside the projector.
 - Particular care should be taken when the projector is installed to a ceiling, as small pieces of glass may fall down when the lamp cover is removed. If cleaning the projector or replacing the lamp yourself, be very careful not to allow such pieces of glass to get into the eyes or mouth. In addition, consult your local regulations regarding proper disposal and do not place in the trash.
 - If the lamp breaks and gas from the lamp or fragments of broken glass are inhaled or get into the eyes or mouth, or if any other ill effects are noticed, immediately seek medical advice.
 - If there is an electrical storm, do not touch the power plug, otherwise you may receive an electric shock.
 - Clean the inside of the projector periodically.
If the inside of the projector has not been cleaned for a long time, dust may build up and cause fire or electric shocks. Contact your dealer or Authorized Epson Service Center to clean inside the projector at least once a year. A charge will be levied for this service.
 - If using a remote control that takes batteries, keep these batteries out of the reach of children. Batteries are choking hazards and can be very dangerous if swallowed.
 - If the batteries are swallowed, seek medical assistance immediately.
 - When replacing batteries, take the following precautions.
 - Replace the batteries as soon as they run out.
 - If the batteries leak, wipe away battery fluid with a soft cloth. If fluid gets on your hands, wash immediately.
 - Do not expose batteries to heat or flame.
 - Dispose of used batteries according to your local regulations.
 - Remove the batteries if you won't be using the projector for a long period of time.
- WARNING:** The cords included with this product contain chemicals, including lead, known to the State of California to cause birth defects or other reproductive harm. **Wash hands after handling.** (provided in accordance with Proposition 65 in Cal. Health & Safety Code § 25249.5 et seq)

Basic Two-Year Warranty and 90-Day Lamp Warranty

What Is Covered: Epson America, Inc. (“EPSON”) warrants to the original retail purchaser of the EPSON product enclosed with this limited warranty statement that the product, if purchased and operated only in the United States or Canada, conforms to the manufacturer’s specifications and will be free from defects in workmanship and materials for a period of two (2) years from the date of original purchase (except that the warranty period is 90 days for projector lamps). For warranty service, you must provide proof of the date of original purchase.

What EPSON Will Do To Correct Problems: If you elect carry-in warranty service, please bring the product securely packaged in its original container or an equivalent, along with proof of the date of original purchase, to your EPSON Dealer or EPSON Customer Care Center. EPSON will, at its option, repair or replace on an exchange basis the defective unit, without charge for parts or labor. When warranty service involves the exchange of the product or of a part, the item replaced becomes EPSON property. The exchanged product or part may be new or previously refurbished to the EPSON standard of quality, and at EPSON’s option, the replacement may be another model of like kind and quality. EPSON’s liability for replacement of the covered product will not exceed the original retail selling price of the covered product. Exchange or replacement products or parts assume the remaining warranty period of the product covered by this limited warranty. However, each replacement lamp carries the limited 90-day warranty stated above.

What This Warranty Does Not Cover: This warranty does not apply to refurbished or reconditioned products. This warranty covers only normal consumer use in the United States and Canada. 24-hour-per-day use causes unusual strain and is not considered normal use. This warranty does not cover consumables (e.g., fuses), other than lamps. This warranty is not transferable. EPSON is not responsible for warranty service should the EPSON label or logo or the rating label or serial number be removed or should the product fail to be properly maintained or fail to function properly as a result of misuse, abuse, improper installation, neglect, improper shipping, damage caused by

disasters such as fire, flood, and lightning, improper electrical current, software problems, interaction with non-EPSON products, or service other than by an EPSON Authorized Servicer. Postage, insurance, or shipping costs incurred in presenting your EPSON product for carry-in warranty service are your responsibility. If a claimed defect cannot be identified or reproduced in service, you will be held responsible for costs incurred.

THE WARRANTY AND REMEDY PROVIDED ABOVE ARE EXCLUSIVE AND IN LIEU OF ALL OTHER EXPRESS OR IMPLIED WARRANTIES INCLUDING, BUT NOT LIMITED TO, THE IMPLIED WARRANTIES OF MERCHANTABILITY OR FITNESS FOR A PARTICULAR PURPOSE. SOME LAWS DO NOT ALLOW THE EXCLUSION OF IMPLIED WARRANTIES. IF THESE LAWS APPLY, THEN ALL EXPRESS AND IMPLIED WARRANTIES ARE LIMITED TO THE WARRANTY PERIOD IDENTIFIED ABOVE. UNLESS STATED HEREIN, ANY STATEMENTS OR REPRESENTATIONS MADE BY ANY OTHER PERSON OR FIRM ARE VOID. IN THE EVENT THE REMEDIES ABOVE FAIL, EPSON’S ENTIRE LIABILITY SHALL BE LIMITED TO A REFUND OF THE PRICE PAID FOR THE EPSON PRODUCT COVERED BY THIS LIMITED WARRANTY. EXCEPT AS PROVIDED IN THIS WRITTEN WARRANTY, NEITHER EPSON AMERICA, INC. NOR ITS AFFILIATES SHALL BE LIABLE FOR ANY LOSS, INCONVENIENCE, OR DAMAGE, INCLUDING DIRECT, SPECIAL, INCIDENTAL, OR CONSEQUENTIAL DAMAGES, RESULTING FROM THE USE OR INABILITY TO USE THE EPSON PRODUCT, WHETHER RESULTING FROM BREACH OF WARRANTY OR ANY OTHER LEGAL THEORY.

In Canada, warranties include both warranties and conditions.

Some jurisdictions do not allow limitations on how long an implied warranty lasts and some jurisdictions do not allow the exclusion or limitation of

incidental or consequential damages, so the above limitations and exclusions may not apply to you.

This warranty gives you specific legal rights, and you may also have other rights, which vary from jurisdiction to jurisdiction.

To locate the Authorized EPSON Servicer nearest you, call the EPSON ConnectionSM at (800) 637-7661 + PIN or (562) 276-4394 in the U.S. and (905) 709-3839 in Canada or write to:

Epson America, Inc., P.O. Box 93012, Long Beach, CA 90809-3012.

A

Accessories	56
Air exhaust vent.....	8
Air filter	11
Air intake vent	11
Angle of tilt.....	74
Aspect ratio.....	23
Audio input	10
Auto Setup	14, 36

B

Background Color	38
Blackboard.....	16
Brightness	35
Brightness Control.....	37

C

Cleaning the Air Filter.....	59
Cleaning the Lens	59
Cleaning the Projector Surface....	59
Color Intensity	35
Color Mode.....	16, 35
Color Temp.....	35
Computer1 Input.....	36
Computer port.....	10
Configuration Menu	34
Consumables.....	69

Contrast	35
Control Panel.....	9

D

DirectPower ON.....	39
Display	38

E

EPSON	
accessories.....	56
PrivateLine Support	56
technical support	56
ESC/VP21	72
"Extended" Menu	38
E-Zoom	24

F

Fan Speed	39
Focus ring.....	8
Freeze	22
Front adjustable foot	8

G

Glossary.....	70
---------------	----

H

HDTV	73
Help.....	56
Help function	43

I

"Image" Menu.....	35
Image Shift.....	37
Image shift	18
"Info" Menu	40
Input Signal.....	40

K

Keystone	37
----------------	----

L

Lamp cover	8
Lamp Hours	40
Lamp-Hours Reset	41, 64
Lamp indicator.....	46
Lamp replacement period	61
Language.....	39
Lens cover.....	8
Link21L	39
Living Room.....	16
Low	37

M

Menu.....	34
Message	38
Monitor Out port	10
Mouse pointer.....	26

N

Numeric buttons	12
-----------------------	----

O

Operating temperature.....	74
Operation	39
Operation Lock.....	31, 37
Optional accessories.....	69
Overheating	46

P

Part Names and Functions.....	8
Password Protect	28
Password Protect stickers	29
Photo.....	16
Pointer	23
Pointer Shape.....	37
Position.....	14, 36
Power indicator	45
Power inlet.....	10



Power ON Protect..... 28
 Presentation 16
 Presenters Online..... 56
 PrivateLine Support..... 56
 Problem Solving 45
 Progressive 36
 Projection..... 38

R

Rear adjustable foot..... 10
 Refresh Rate 40
 Remote control 12, 60
 Remote control light-emitting area..
 12
 Remote control light-receiving area
8, 10
 Replacing the Air Filter 65
 Replacing the batteries 60
 Replacing the Lamp..... 61
 Request code..... 28
 Reset All 41
 "Reset" Menu..... 41
 Resolution..... 40, 73

S

Search 12
 Security lock 8
 "Settings" Menu..... 37

Setting Up the Projector 58
 Sharpness..... 35
 Sleep Mode..... 39
 Source..... 40
 Source Search..... 9, 20
 Speaker 10
 Specifications 74
 Sports..... 16
 Squeeze mode..... 23
 Startup Screen 38
 Storage temperature 74
 Sub menu..... 34
 Supported Monitor Displays 73
 Suspension bracket fixing point .. 11,
 75
 S-Video port 10
 Sync..... 14, 36
 Sync. Info 40

T

Technical support 56
 Temp indicator 46
 Theatre..... 16
 Tint 35
 Top menu 34
 Tracking 14, 36
 Translucent screen..... 58

U

USB port 10
 User's Logo 66
 User's Logo Protect 29

V

Video..... 35, 36, 40
 Video port 10
 Video Signal 36, 40
 Volume 19, 37

W

Wide-screen Projection..... 23

Z

Zoom..... 37

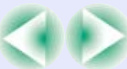

DECLARATION of CONFORMITY

According to 47CFR, Part 2 and 15
Class B Personal Computers and Peripherals; and/or
CPU Boards and Power Supplies used with Class B
Personal Computers

We	EPSON AMERICA, INC.
Located at	3840 Kilroy Airport Way MS: 3-13 Long Beach, CA 90806
Tel	562-290-5254

Declare under sole responsibility that the product identified herein, complies with 47CFR Part 2 and 15 of the FCC rules as a Class B digital device. Each product marketed, is identical to the representative unit tested and found to be compliant with the standards. Records maintained continue to reflect the equipment being produced can be expected to be within the variation accepted, due to quantity production and testing on a statistical basis as required by 47CFR 2.909. Operation is subject to the following two conditions : (1) this device may not cause harmful interference, and (2) this device must accept any interference received, including interference that may cause undesired operation.

Trade Name	EPSON
Type of Product	Projector
Model	EMP-S3

**FCC Compliance Statement
For United States Users**

This equipment has been tested and found to comply with the limits for a Class B digital device, pursuant to Part 15 of the FCC Rules. These limits are designed to provide reasonable protection against harmful interference in a residential installation. This equipment generates, uses, and can radiate radio frequency energy and, if not installed and used in accordance with the instructions, may cause harmful interference to radio or television reception. However, there is no guarantee that interference will not occur in a particular installation. If this equipment does cause interference to radio and television reception, which can be determined by turning the equipment off and on, the user is encouraged to try to correct the interference by one or more of the following measures.

- Reorient or relocate the receiving antenna.
- Increase the separation between the equipment and receiver.
- Connect the equipment into an outlet on a circuit different from that to which the receiver is connected.
- Consult the dealer or an experienced radio/TV technician for help.

WARNING

The connection of a non-shielded equipment interface cable to this equipment will invalidate the FCC Certification or Declaration of this device and may cause interference levels which exceed the limits established by the FCC for this equipment. It is the responsibility of the user to obtain and use a shielded equipment interface cable with this device. If this equipment has more than one interface connector, do not leave cables connected to unused interfaces. Changes or modifications not expressly approved by the manufacturer could void the user's authority to operate the equipment.

Remote Control

- **[Page down][Page up] buttons**  [p.26](#)

When using the remote control as a wireless mouse, press these buttons to scroll back and forth through pages in a PowerPoint file.

- **[E-Zoom] button**  [p.24](#)

[+]:Enlarges parts of images without changing the size of the projection area.
[-]:Reduces the part of images that have been enlarged using the [+] button.

- **[Enter] button**  [p.26, p.34](#)

Accepts a menu or help item or displays the next screen or menu when viewing a configuration menu or help menu.
Acts as a mouse left-click when using the wireless mouse function.

- **[Esc] button**  [p.26, p.34](#)

Stops the current function.
Displays the previous screen or menu while viewing a configuration menu.
Acts as a mouse right-click when using the wireless mouse function.

- **[Pointer] button**  [p.23](#)

Press to indicate part of an image being projected as part of a presentation.

- **[A/V Mute] button**  [p.22](#)

The audio and video are turned turn on or off each time the button is pressed.

- **[Computer] button**  [p.20](#)

Switches to images from the Computer port.

- **[S-Video] button**  [p.20](#)

- Switches to images from the S-Video port.

- **[Video] button**  [p.20](#)

Switches to images from the Video port.

- **[Auto] button**  [p.20](#)

Automatically adjusts and optimises analogue RGB computer video signals.



- **Remote control light-emitting area** (See the Quick Setup sheet)

Outputs remote control signals.

- **[Power] button** (See the Quick Setup sheet)

Turns the projector power on and off.

- **[◂] buttons**  [p.26, p.34](#)

When a configuration menu or help menu is displayed, these buttons select menu items and setting values.

When the wireless mouse function is activated, tilting this button moves the pointer in the direction of tilt.

- **[Freeze] button**  [p.22](#)

Images are paused or unpaused each time the button is pressed.

- **[Num] button**  [p.28](#)

This is used when entering and changing passwords.

- **[Color Mode] button**  [p.16](#)

Changing the colour mode. When you press the button, the colour modes change in the following order.

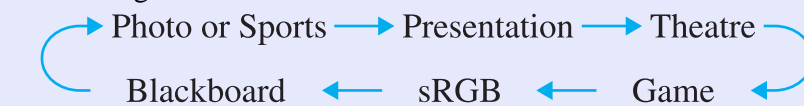

- **[Menu] button**  [p.34](#)

Displays and closes the configuration menu.

- **[Resize] button**  [p.23](#)

When [component video](#), [composite video](#) or [S-Video](#) signals are being projected, the [aspect ratio](#) changes each time this button is pressed.

- **[Help] button**  [p.43](#)

Displays and closes the help, which shows solutions if a problem occurs.

- **[Volume] buttons**  [p.19](#)

Adjust the sound volume.

- **[Search] button**  [p.20](#)

The input source is automatically searched for in the following order, and the input image from the connected equipment is projected.

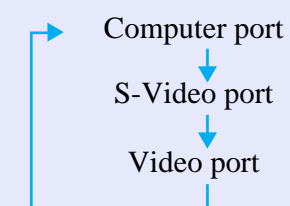

- **Numeric buttons**  [p.28](#)

Use these buttons to enter a password when using Password Protect.