

ViewSonic®

PJ650/PJ520

User Guide

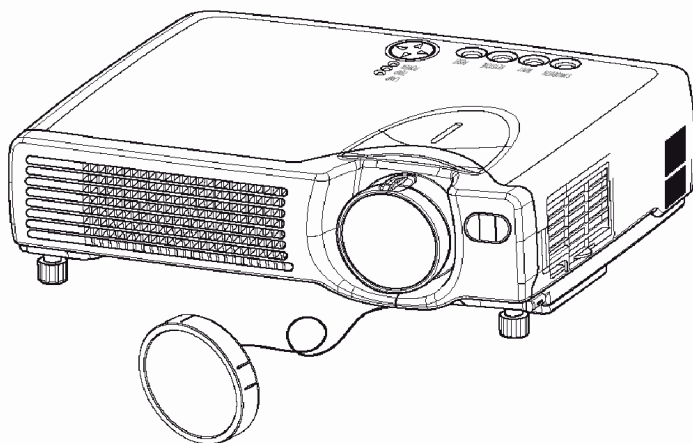

Image Size 31" - 300"
LCD Projector

Contents

For Your Records	1
Before Use	2
Package Contents	2
Component Names	3
Projector	3
Remote Control	4
Using the remote control	5
Putting batteries into the remote control unit	5
Operating the remote control	5
Setting up the projector	6
Adjusting the Projector's Elevator Feet	6
Adjusting the Screen Size and Projection Distance	7
Ports and Cables	8
SetUp Reminders	9
Connecting your devices	10
Plug & Play	10
Connecting to a Computer	11
Connecting to a DVD Player or VCR	12
Connecting to a Display Monitor	13
Turning On The Power	14
Precautions	14
Turning Off The Power	15
Selecting an Input Signal	16
Adjusting the Volume	17
Temporarily Muting the Sound	17
Adjusting the Image Position	18
Using the Automatic Adjustment Feature	19
Correcting Keystroke Distortions	20
Using the Magnify Feature	21
Freezing the Screen	21
Signal Searching	22
Selecting the Aspect Ratio	22
Temporarily Blanking the Screen	22
Using the Menu Functions	23
Operating the PC Screen	24
PS/2, ADB, Serial Mouse Control	24
USB Mouse/Keyboard Control	24
OSD Menu Function Description	25
Main Menu	25
Picture 1 Menu	26
Picture 2 Menu	26
Input Menu	27
Screen Menu	28

Option Menu	30
Maintenance	31
Lamp	31
Lamp Life	32
Replacing the Lamp	32
Caring for the Air Filter	33
Caring for the Inside of the Projector	34
Caring for the Lens	34
Caring for the Cabinet and Remote Control Transmitter	34
Troubleshooting	35
On-screen Messages	35
Panel Lamp Indicators	36
Problem Diagnostics	37
Specifications	38
Outline Dimension	38
Customer Support	39
Limited Warranty	40
VIEWSONIC Projector	40
Appendix	41
Power Cord Safety Guidelines	41
Compliance Information for U.S.A.	42
Compliance Information for Canada	42
Compliance Information for European Countries	42
User Information for all Countries	42

Copyright © ViewSonic Corporation, 2004. All rights reserved.

Apple, Mac and ADB registered trademarks of Apple Computer, Inc.

Microsoft, Windows, Windows NT, and the Windows logo are registered trademarks of Microsoft Corporation in the United States and other countries.

ViewSonic, the three birds logo and OnView are registered trademarks of ViewSonic Corporation.

VESA and SVGA are registered trademarks of the Video Electronics Standards Association.

DPMS and DDC are trademarks of VESA.

PS/2, VGA and XGA are registered trademarks of International Business Machines Corporation.

Disclaimer: ViewSonic Corporation shall not be liable for technical or editorial errors or omissions contained herein; nor for incidental or consequential damages resulting from furnishing this material, or the performance or use of this product.

In the interest of continuing product improvement, ViewSonic Corporation reserves the right to change product specifications without notice. Information in this document may change without notice.

No part of this document may be copied, reproduced, or transmitted by any means, for any purpose without prior written permission from ViewSonic Corporation.

Electronic Warranty Registration

To meet your future needs, and to receive any additional product information as it becomes available, please register your projector's warranty on the Internet at: <http://www.viewsonic.com>

For Your Records

Product Name:	ViewSonic PJ650 / PJ520
Model Number:	VPROJ27747-1W / VS10141
Document Number:	A-CD-PJ650-1 / A-CD-PJ520
Serial Number:	_____
Purchase Date:	_____

Before Use

Package Contents

Make sure all of the following items are included in the package. If anything is missing, please contact ViewSonic Corp.

NOTE:

Keep the original packing material for future shipment.

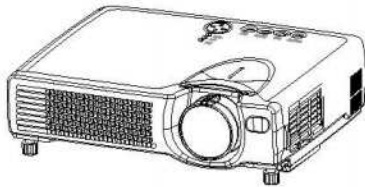

Projector



Power Cord

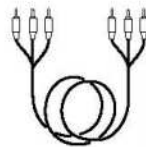

Video/Audio Cable

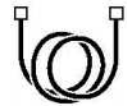

USB mouse cable



Quick Start Guide

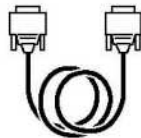

RGB Video Cable

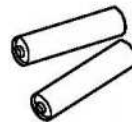

Batteries for Remote Control

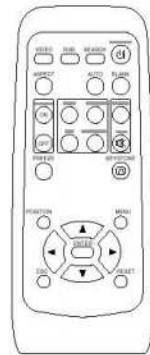

Remote Control



Soft Case



CD-Wizard

NOTE:

Applicable power cord is shipped with the projector to the point of destination.

To avoid penetration of foreign objects, do not put the projector in a case or a bag together with any things except the accessories of the projector, signal cables and connectors.

WARNING:

Before using this equipment, read this manual thoroughly. Always ensure that the equipment is used safely.

Component Names

Projector

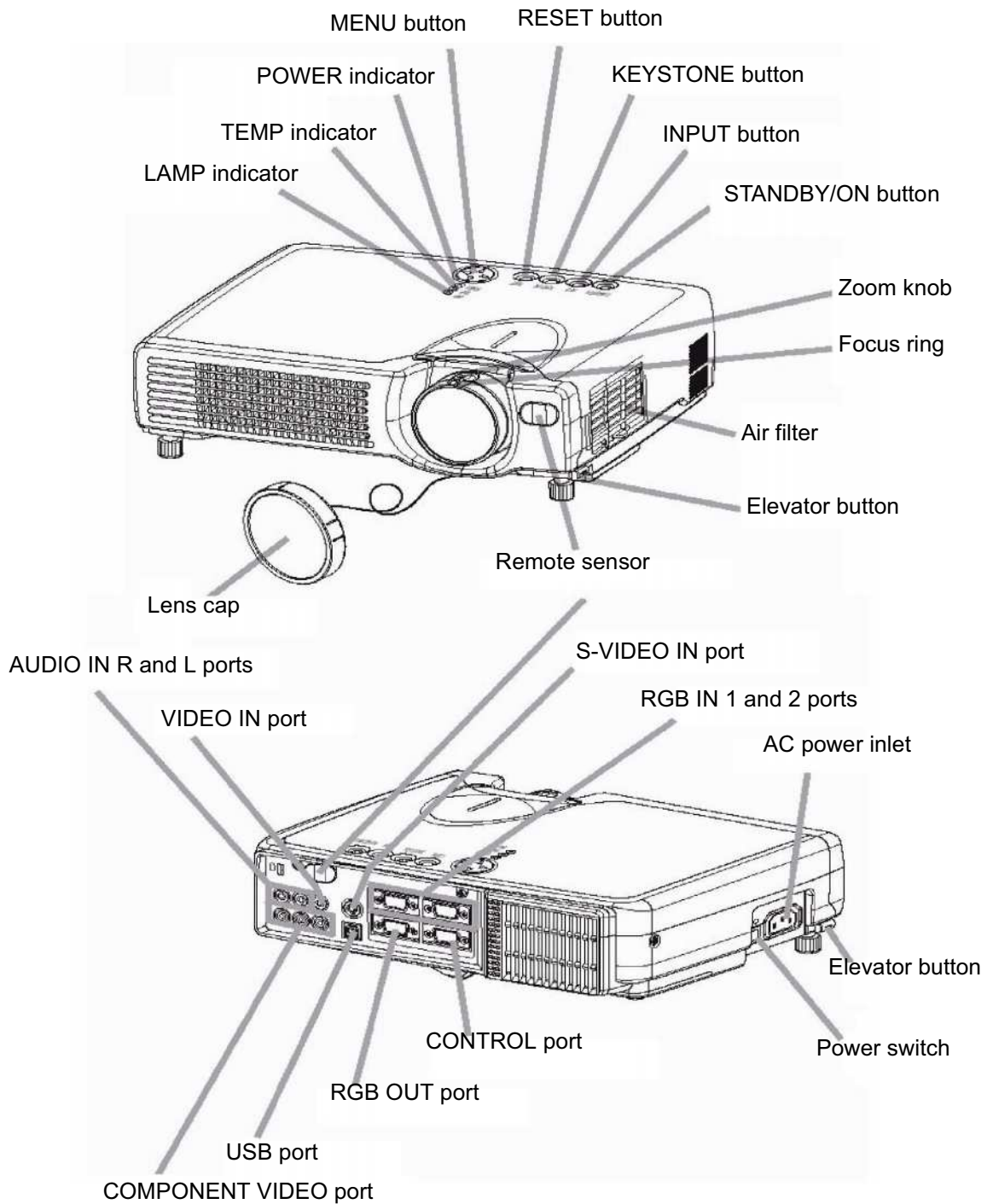

Remote Control

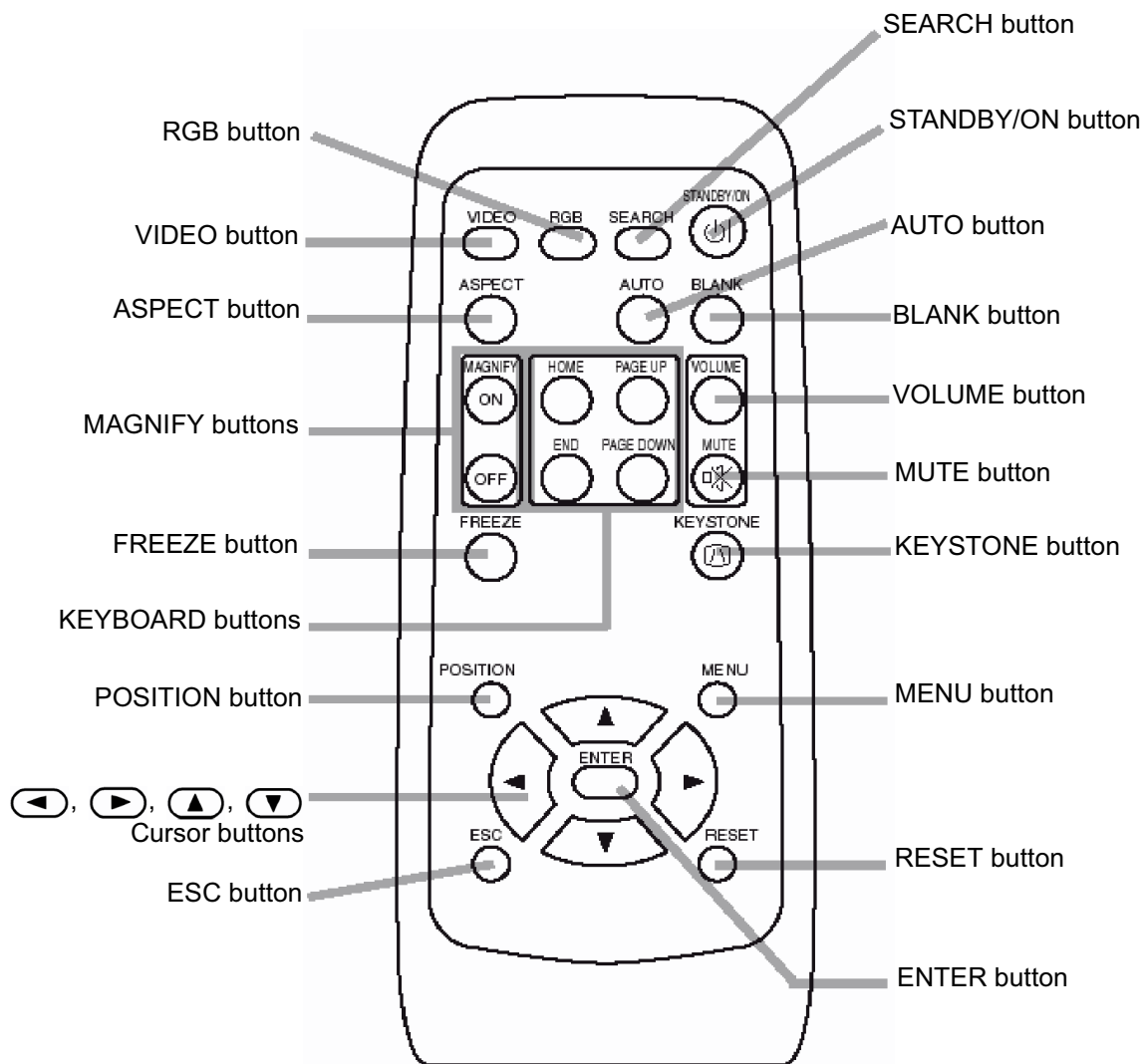

REMOTE CONTROL DEVICE

Using the remote control

Putting batteries into the remote control unit

CAUTION Precautions to observe in regards to the batteries

Always handle the batteries with care and use them only as directed. Improper use may result in battery cracking or leakage, which could result in fire, injury and/or pollution of the surrounding environment.

- Keep the battery away from children and pets.
- Be sure to use only the batteries specified for use with the remote control. Do not mix new batteries with used ones.
- When inserting batteries, verify that the plus and minus terminals are aligned correctly (as indicated in the remote control).
- When you dispose the battery, you should obey the law in the relative area or country.

1 Remove the battery cover

Slide back and remove the battery cover in the direction of the arrow.



2 Insert the batteries

Align and insert the two AA batteries (that came with the projector) according to their plus and minus terminals (as indicated in the remote control).

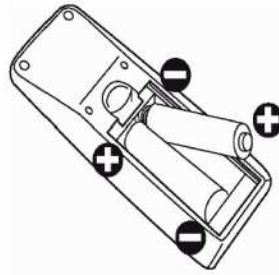

3 Close the battery cover

Replace the battery cover in the direction of the arrow and snap it back into place.



Operating the remote control

- The remote control works with both the projector's front and rear remote sensors.
- The range of the remote sensor on the front and back is 3 meters with a 60-degree range (30 degrees to the left and right of the remote sensor).
- Since the remote control uses infrared light to send signals to the projector (Class 1 LED), be sure to use the remote control in an area free from obstacles that could block the remote control's output signal to the projector.

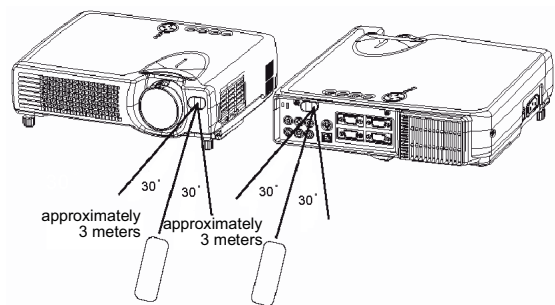

ATTENTION Precautions to observe when using the remote control

- Do not drop or otherwise expose the remote control to physical impact.
- Do not get the remote control wet or place it on wet objects. Doing so may result in malfunction.
- Remove the batteries from the remote control and store them in a safe place if you won't be using the remote control for an extended period.
- Replace the batteries whenever the remote control starts to malfunction.
- When strong light, such as direct sunlight or light from an extremely close range (such as from an inverter fluorescent lamp), hits the projector's remote sensor, the remote control may cease to function. Adjust the direction of the projector to keep light from directly hitting the projector's remote sensor.

Setting up the projector

CAUTION

- Install the projector in a suitable environment according to instructions of the accompanying manual “PJ650 / PJ520 Quick START GUIDE” and this manual.
- If you press the elevator buttons without holding the projector, the projector might crash down, overturn, smash your fingers and possibly result in malfunction. To prevent damaging the projector and injuring yourself, ALWAYS HOLD THE PROJECTOR whenever using the elevator buttons to adjust the elevator feet.

Adjusting the Projector's Elevator Feet

You can use the elevator feet to make adjustments if the surface on which you need to set the projector is uneven or if you otherwise need to adjust the angle of projection. The adjustment range of the elevator feet is 0 to 9 degrees.

1 Press and hold in the elevator buttons.

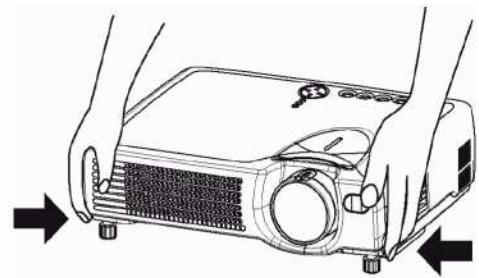

2 Raise or lower the projector to the desired height and then release the elevator buttons.
When you release the elevator buttons, the elevator feet will lock into position.

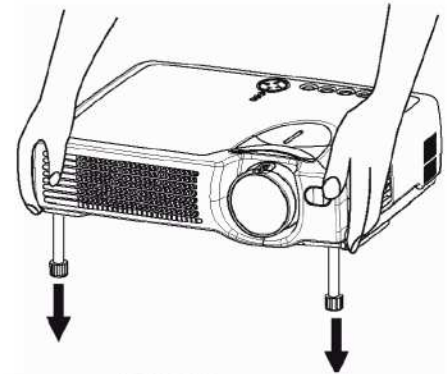

3 As necessary, you can also finely adjust the height of the projector by twisting the elevator feet by hand.

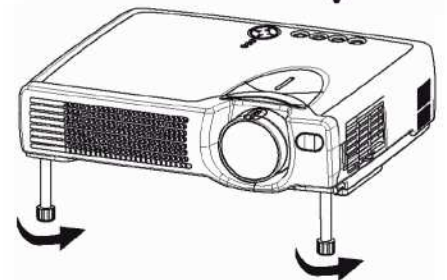

Adjusting the Screen Size and Projection Distance

Refer to the illustrations and tables below to determine the screen size and projection distance.
The values shown in the table are calculated for a full size screen (PJ650: 1024x768, PJ520: 800x600).

a: Distance from the projector to the screen ($\pm 10\%$).

b: Distance from the lens center to the bottom of the screen ($\pm 10\%$).

c: Distance from the lens center to the top of the screen ($\pm 10\%$).

If 4:3 aspect ratio.

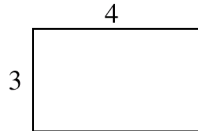

Screen Size Inches (m)	a Inches (m)		b Inches (cm)	C Inches (cm)
	Minimum	Maximum		
30 (0.8)	35 (0.9)	42 (1.1)	1 (2)	17 (55)
40 (1.0)	47 (1.2)	56 (1.4)	1 (3)	23 (58)
50 (1.3)	59 (1.5)	71 (1.8)	1 (4)	29 (73)
60 (1.5)	71 (1.8)	85 (2.2)	2 (4)	34 (87)
70 (1.8)	83 (2.1)	100 (2.5)	2 (5)	40 (102)
80 (2.0)	95 (2.4)	114 (2.9)	2 (6)	46 (116)
90 (2.3)	107 (2.7)	129 (3.3)	3 (7)	51 (131)
100 (2.5)	119 (3.0)	143 (3.6)	3 (7)	57 (145)
120 (3.0)	143 (3.6)	172 (4.4)	3 (9)	69 (174)
150 (3.8)	180 (4.6)	216 (5.5)	4 (11)	86 (218)
200 (5.0)	240 (6.1)	288 (7.3)	6 (15)	114 (290)
250 (6.3)	300 (7.6)	361 (9.2)	7 (18)	143 (363)
300 (7.5)	360 (9.2)	433 (11.0)	9 (22)	171 (435)

If 16:9 aspect ratio.

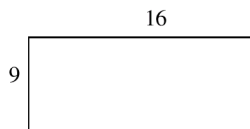

Screen Size Inches (m)	a Inches (m)		b Inches (cm)	C Inches (cm)
	Minimum	Maximum		
30 (0.8)	38 (1.0)	46 (1.2)	2 (4)	16 (41)
40 (1.0)	51 (1.3)	61 (1.6)	2 (5)	22 (55)
50 (1.3)	64 (1.6)	77 (2.0)	3 (6)	27 (69)
60 (1.5)	77 (2.0)	93 (2.4)	3 (8)	32 (82)
70 (1.8)	90 (2.3)	109 (2.8)	4 (9)	38 (96)
80 (2.0)	104 (2.6)	125 (3.2)	4 (10)	43 (110)
90 (2.3)	117 (3.0)	140 (3.6)	5 (12)	49 (124)
100 (2.5)	130 (3.3)	156 (4.0)	5 (13)	54 (137)
120 (3.0)	156 (4.0)	188 (4.8)	6 (15)	65 (165)
150 (3.8)	196 (5.0)	235 (6.0)	8 (19)	81 (206)
200 (5.0)	261 (6.6)	314 (8.0)	10 (26)	108 (275)
250 (6.3)	327 (8.3)	393 (10.0)	13 (32)	135 (343)
300 (7.5)	393 (10.0)	472 (12.0)	15 (39)	162 (412)

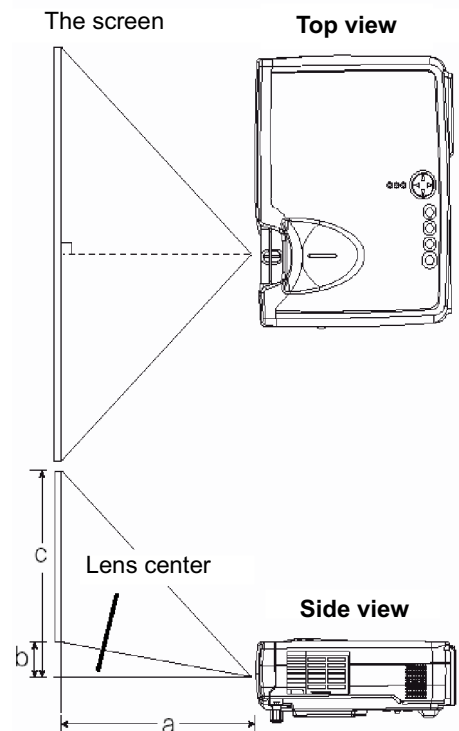
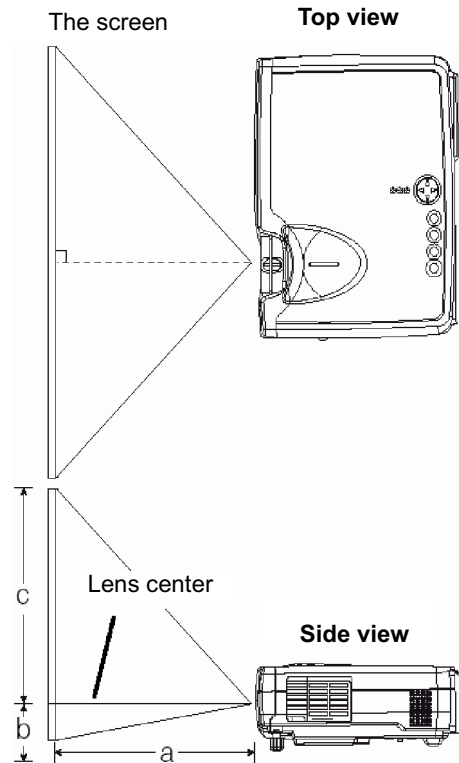

Ports and Cables

Refer to this table to determine which projector port and cable to use for connecting to a given device. Use this table for determining which cables to prepare.

Function	Projector Port	Connection Cables
RGB input	RGB IN 1	Accessory RGB cable or optional RGB cable with D-sub 15-pin shrink jack and inch thread screws
	RGB IN 2	
RGB output	RGB OUT	
USB mouse control	USB	Accessory USB cable
PS/2 mouse control	CONTROL	Optional PS/2 mouse cable
ADB mouse control		Optional ADB mouse cable
Serial mouse control		Optional serial mouse cable
RS-232C communication		Optional RS-232C cable
S-video input	S-VIDEO IN	Optional S-video cable with mini DIN 4-pin jack
Video input	VIDEO IN	Accessory audio/video cable
Component video input	COMPONENT VIDEO Y	Optional component video cable
	COMPONENT VIDEO C _B /P _B	
	COMPONENT VIDEO C _R /P _R	
Audio input	AUDIO IN L	Accessory audio/video cable or optional audio cable with RCA jack
	AUDIO IN R	

NOTE:

About Plug-and-Play Capability

- This projector is compatible with VESA DDC 1/2B. Plug-and-Play can be achieved by connecting this projector to computers that are VESA DDC (display data channel) compatible. Please take advantage of this function by connecting the accessory RGB cable to the RGB IN 1 port (DDC 1/2B compatible). Plug-and-Play may not work properly if any other type of connection is attempted.
- Plug-and-Play is a system composed of the computer, its operating system and peripheral equipment (i.e. display devices).
- Please use the standard drivers as this projector is a Plug-and-Play monitor.
- Plug-and-Play may not function properly with some type of computers. Use the RGB IN 2 port if Plug-and-Play does not function correctly.

SetUp Reminders

WARNING:

Precautions to observe in regards to the power cord: Please use extra caution when connecting the projector's power cord as incorrect or faulty connections may result in FIRE AND/OR ELECTRICAL SHOCK. Please adhere to the following safety guidelines to insure safe operation of the projector:

- Only plug the power cord into outlets rated for use with the power cord's specified voltage range.
- Only use the power cord that came with the projector.
- NEVER ATTEMPT TO DEFEAT THE GROUND CONNECTION OF THE THREEPRONGED PLUG!
- Make sure that you firmly connect the power cord to the projector and wall outlet.

1 Connect your devices to the projector

Connect your computer, VCR and/or other devices you will be using to the projector.

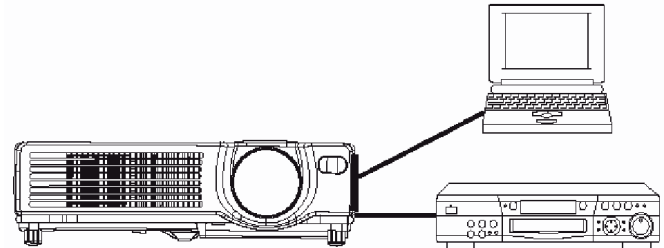

2 Insert the batteries into the remote control.

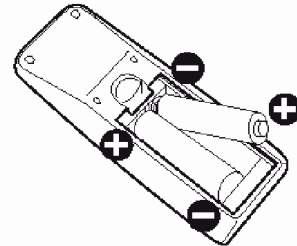

3 Connect the power cord

- (1) Connect the connector of the electrical power cord to the AC inlet of the main unit.
- (2) Firmly plug the power cord's into the outlet.

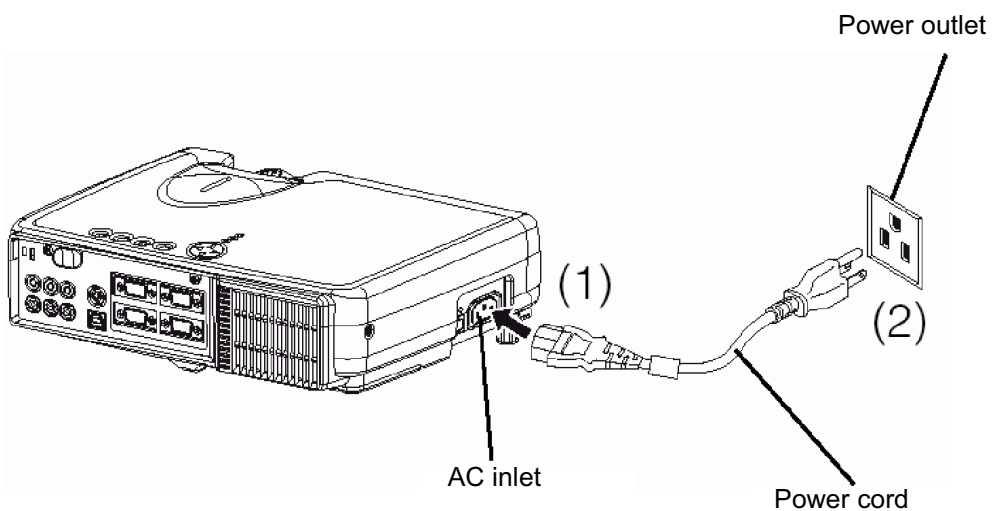

Connecting your devices

Devices You Can Connect to the Projector (Refer to this section for planning your device configuration to use for your presentation.)

CAUTION

- Incorrect connecting could result in fire or electrical shock. Please read this manual and the separate “PJ650 / PJ520 Quick START GUIDE”.

ATTENTION

 Precautions to observe when connecting other devices to the projector

- Whenever attempting to connect other devices to the projector, please thoroughly read the manual of each device to be connected.
- **TURN OFF ALL DEVICES** prior to connecting them to the projector. Attempting to connect a live device to the projector may generate extremely loud noises or other abnormalities that may result in malfunction and/or damage to the device and/or projector. Refer to the “TECHNICAL” of the PJ650 / PJ520 User Guide for the pin assignment of connectors and RS-232C communication data.
- Make sure that you connect devices to the correct port. Incorrect connection may result in mal-function and/or damage to the device and/or projector.
- A component cable and some other cables have to be used with core set. Use the accessory cable or a designated type cable for the connection. For cables that have a core only at one end, connect the core to the projector.
- Secure the screws on the connectors and tighten.

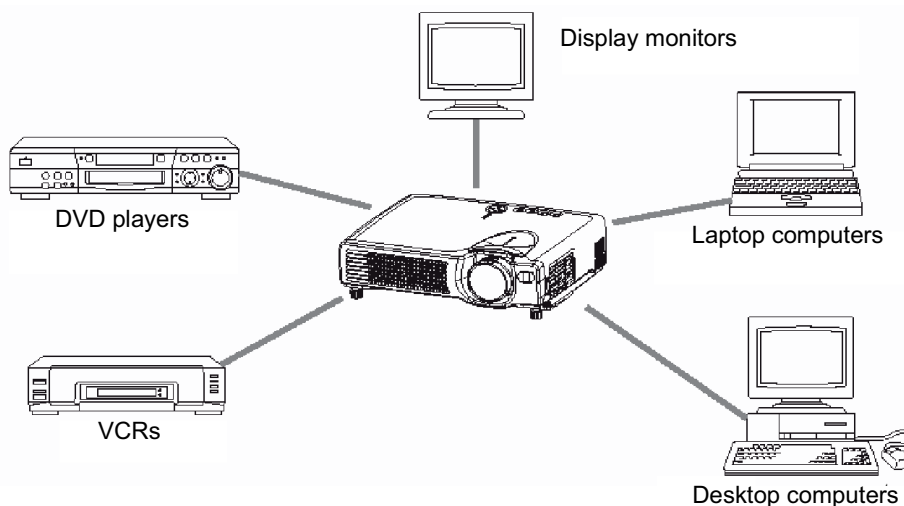

NOTE:

When connecting the projector to a notebook computer, set it so as to activate the RGB external image output (setting it to CRT display or to simultaneous LCD and CRT display). For more information, refer to the instruction manual of the notebook computer.

Plug & Play

This projector is compatible with VESA DDC 1/2B. Plug & Play is possible by connecting to a computer that is compatible with VESA DDC (Display Data Channel).

Use this function by connecting the accessory RGB cable with RGB IN 1 terminal (DDC 1/2B compatible). Plug & Play may not operate by any other connection.

NOTE:

- Plug & Play is a system configured with peripheral equipment which includes a computer, display and an operating system.
- This projector is recognized as a Plug & Play monitor. Load the driver contained in the CD Wizard included with the unit.

Connecting to a Computer

ATTENTION: Whenever attempting to connect a laptop computer to the projector, be sure to activate the laptop's RGB external image output (set the laptop to CRT display or to simultaneous LCD and CRT display). For details on how this is done, please refer to the laptop computer's instruction manual of the corresponding laptop computer.

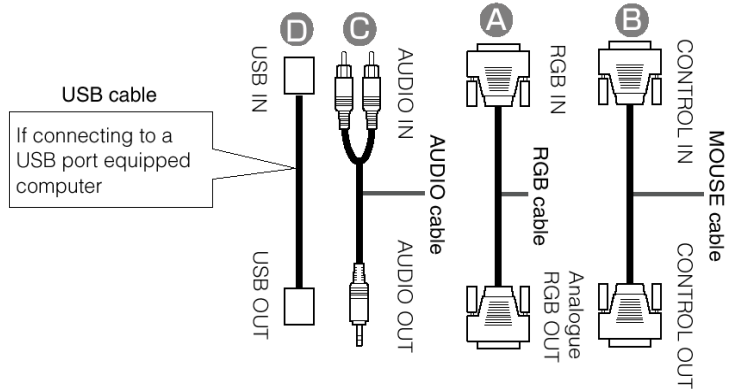
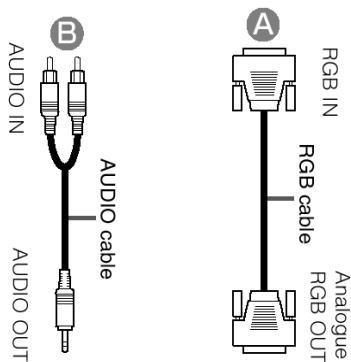
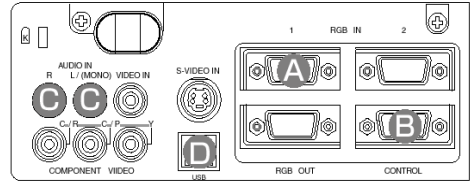
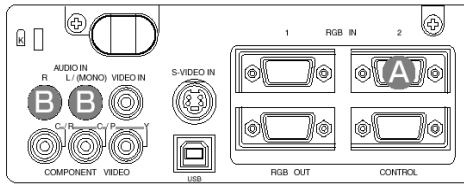

NOTE:

- Some computers may have multiple display screen modes. The use of some of these modes may not be possible with this projector.
- For some RGB input modes, the optional Mac adapter is necessary.

Connecting to a DVD Player or VCR

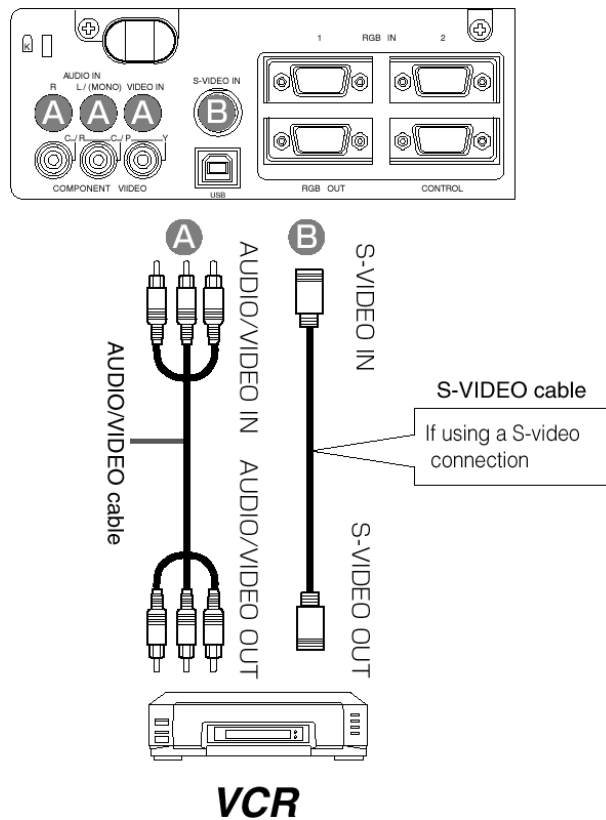
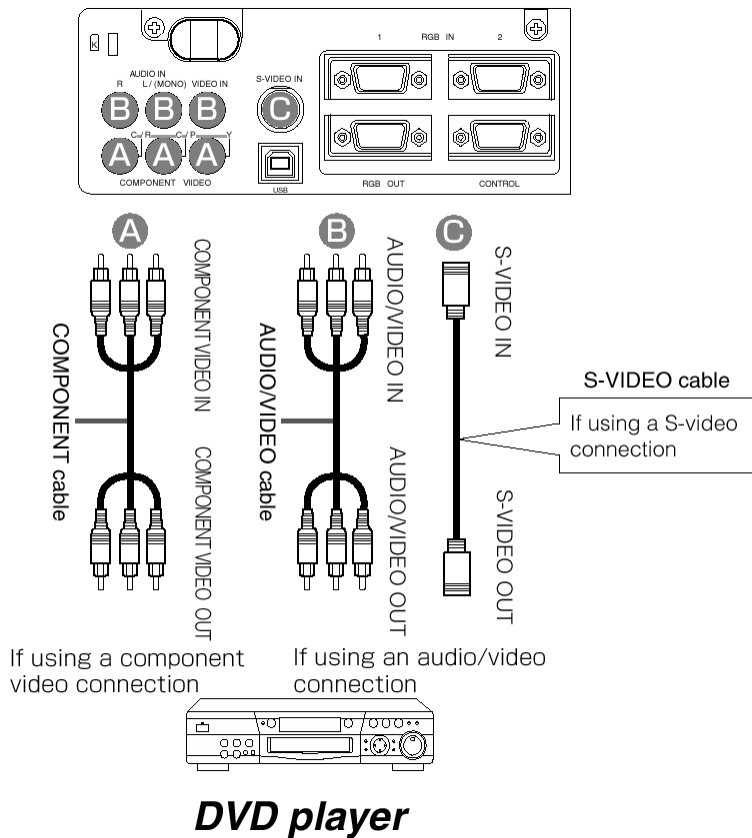

Connecting to a Display Monitor

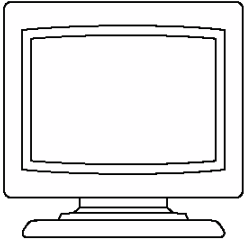
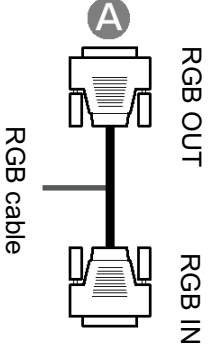
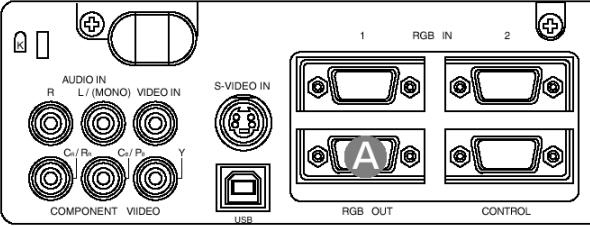

Display monitor

Turning On The Power

Precautions

Connect all devices to be used to the projector prior to turning on the power.

WARNING: When the power is ON, a strong light is emitted. Do not look into the lens.

- 1 Make sure that the power cord is firmly and correctly connected to the projector and outlet.
- 2 Turn on the projector's power
Set the power switch to [I] (ON). The projector will go to STANDBY mode and the POWER indicator will light to solid orange.

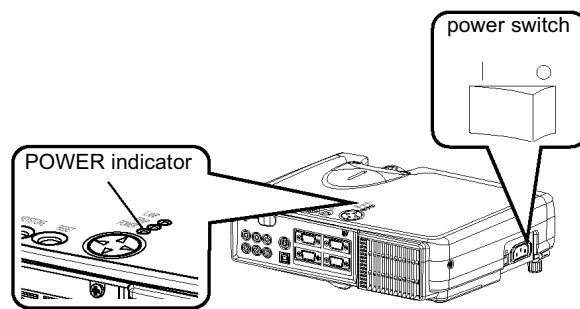

- 3 Press the STANDBY/ON button (control panel or remote control)
 - The projector begins warming up and the POWER indicator blinks green.
 - The POWER indicator stops blinking and lights to solid green once the projector's power is completely on.



Control panel

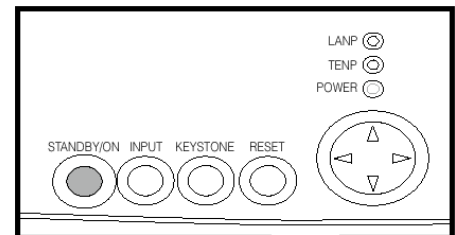

- 4 Remove the lens cap
The picture is projected.

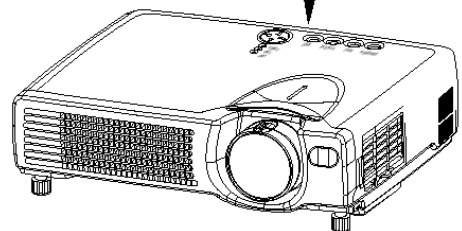
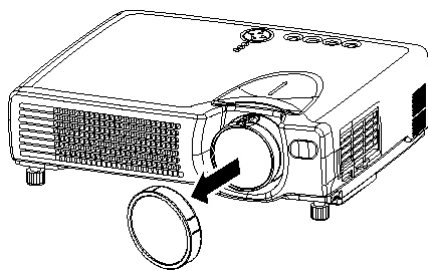

NOTE:

Turn the power on/off in right order.

- Power on the projector before the computer or video tape recorder.
- Power off the projector after the computer or video tape recorder.

Turning Off The Power

- 1 Press the STANDBY/ON button (control panel or remote control)
The message "Power off?" will appear on the screen for approximately 5 seconds.



- 2 Press the STANDBY/ON button again
(control panel or remote control)

Press the STANDBY/ON button again while the "Power off?" message is visible. The projector lamp goes off and starts cooling down. The POWER indicator blinks orange while the lamp cools down. (Pressing the STANDBY/ON button while the POWER indicator is blinking orange has no effect.)

The system goes into STANDBY mode, after cooling down the POWER indicator stops blinking orange and then lights to solid orange.



- 3 Check that the POWER indicator stops blinking and lights to solid orange.
Switch the power switch to [O] (OFF).

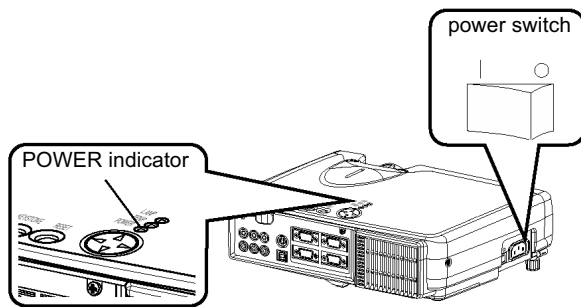

Control panel

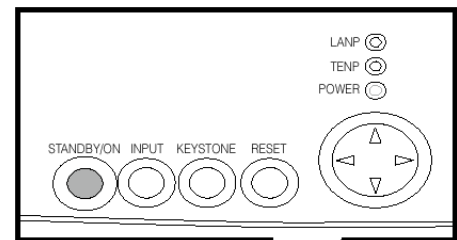

- 4 Confirm that the POWER indicator has gone off and then attach the lens cap.
When the projector has completed powering down, the POWER indicator will go off.

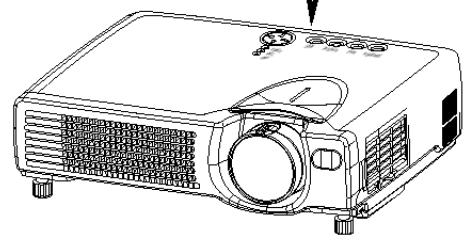
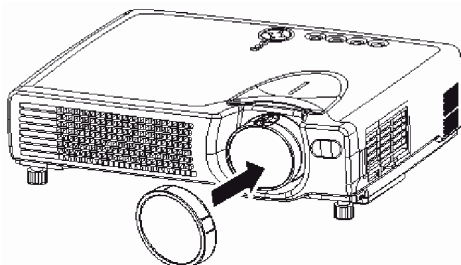

NOTE:

Except in emergencies, follow the abovementioned procedure for turning power off.

Selecting an Input Signal

Using the remote control

If selecting RGB input

Press the RGB button

Press this button to toggle between the devices connected to RGB IN 1 and 2. As illustrated below, each time you press the RGB button, the projector switches between RGB IN 1 and 2.

Select the signal you wish to project.



If selecting video input

Press the VIDEO button

Press this button to toggle between the devices connected to VIDEO IN, SVIDEO IN and COMPONENT VIDEO. As illustrated below, each time you press the VIDEO button, the projector switches between VIDEO IN, S-VIDEO IN and COMPONENT VIDEO. Select the signal you wish to project.



Using the projector's control panel

Press the INPUT button

As illustrated below, each time you press the INPUT button, the projector switches between its input signal ports. Select the signal you wish to project.

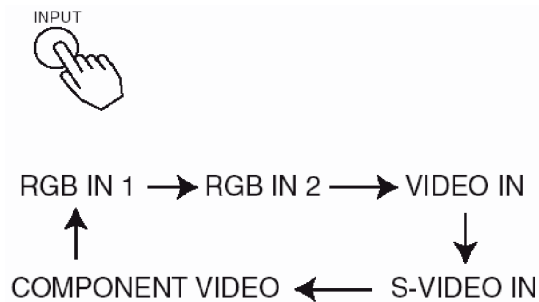

Use the zoom ring to adjust the screen size

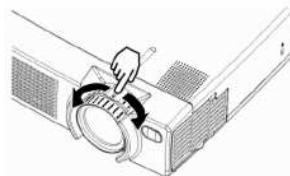

Use the focus ring to focus the picture

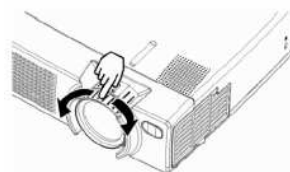

Adjusting the Volume

- 1 Press the VOLUME button

As illustrated on the right, a dialog box will appear on the screen to aid you in adjusting the volume.

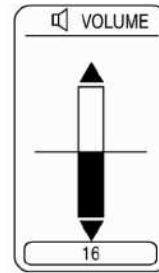

- 2 Press the ▲, ▼ buttons to adjust the volume

Press the VOLUME button again to close the dialog box and complete this operation. (Even if you don't do anything, the dialog box will automatically disappear after a few seconds.)



- ▲ Press this to increase the volume
- ▼ Press this to decrease the volume

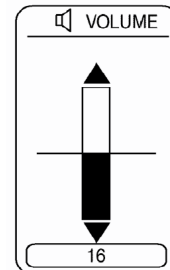

Temporarily Muting the Sound

- 1 Press the MUTE button

As illustrated on the right, a dialog box will appear on the screen indicating that you have muted the sound. Press the VOLUME button to close the dialog box (Even if you don't do anything, the dialog box will automatically disappear after a few seconds.)

Press the MUTE button again to restore the sound.

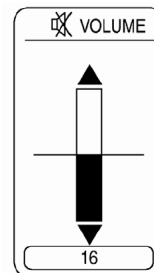
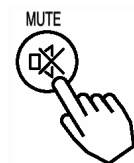

Adjusting the Image Position

1 Press the POSITION button

As illustrated on the right, a dialog box will appear on the screen to aid you in adjusting the position.

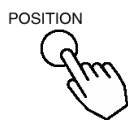

2 Use the ◀, ▶, ▲, ▼ buttons to adjust the position

When you want to initialize the position, press the RESET button during adjustment.

Press the POSITION button again to close the dialog box and complete this operation. (Even if you don't do anything, the dialog box will automatically disappear after a few seconds.)

This function is only available for RGB IN 1/2 input.

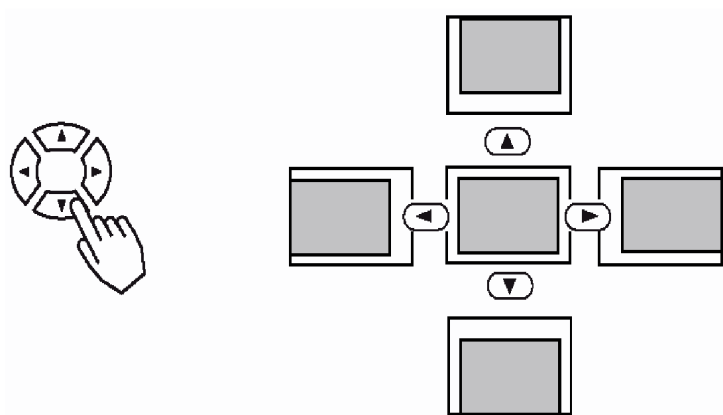

Using the Automatic Adjustment Feature

- 1 Press the AUTO button



- 2 Automatic Adjustment for RGB Input

Horizontal position (H. POSIT), vertical position (V. POSIT), clock phase (H. PHASE) and horizontal size (H. SIZE) are automatically adjusted.

Make sure that the application window is set to its maximum size prior to attempting to use this feature.

Dark pictures may still be incorrectly adjusted. Use a bright screen when adjusting.

- 3 Automatic Adjustment for Video Input

The signal type best suited for the respective input signal is selected automatically.

This feature is available only if VIDEO is set to AUTO in the INPUT menu.

NOTE:

The automatic adjustment operation requires approximately 10 seconds. Also, please note that it may not function correctly with some input signals.

Correcting Keystone Distortions

1 Press the KEYSTONE button

As illustrated on the right, a dialog box will appear on the screen to aid you in correcting the distortion.

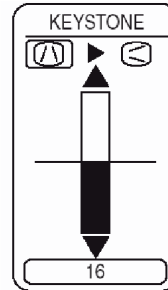

2 Use the ◀, ▶ buttons to select the direction of distortion to correct (⚡ / ⚡)

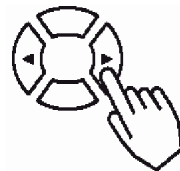

3 Use the ▲, ▼ buttons to correct the distortion

Press the KEYSTONE button again to close the dialog box and complete this operation. (Even if you don't do anything, the dialog box will automatically disappear after a few seconds.)



NOTE:

- This function may not work well with some types of input signals.
- The adjustable range for correcting keystone distortions will vary with the type of input signal.

Using the Magnify Feature

- 1 Press the MAGNIFY (ON) button
The projector enters MAGNIFY mode.



- 2 Press the POSITION button, then use the ◀, ▶, ▲, ▼ buttons to select the area to enlarge and then press the POSITION button again to confirm your selection.

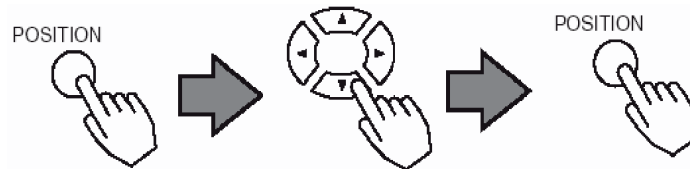

- 3 Press the ▲, ▼ buttons to zoom in and out of the selected area.
Press the MAGNIFY (OFF) button to exit MAGNIFY mode and restore the screen to normal. (The projector will also automatically exit MAGNIFY mode if there is a change in the input signal's state.)



NOTE:

The projector will automatically exit from MAGNIFY mode if either the INPUT SELECT, AUTO, ASPECT or VIDEO feature is used, or if there is a change in the input signal's state.

Freezing the Screen

- 1 Press the FREEZE button
The icon appears and the screen will freeze at the current image. Press the FREEZE button again and the icon disappears as the projector exits FREEZE MODE.



NOTE:

- The projector will automatically exit FREEZE mode if either the POSITION, VOLUME, MUTE, AUTO, BLANK ON/OFF, or MENU ON/OFF feature is used, or if there is a change in the input signal's state.
- If the projector continues projecting the same image for a long time (i.e. you forget to exit FREEZE mode), the image might possibly remain as an afterimage. Do not leave the projector in FREEZE mode for too long.

Signal Searching

1 Press the SEARCH button

When you press the SEARCH button, the projector begins searching for input signals. If it detects an input signal, the search will cease and the projector will project the detected signal. If the projector is unable to find an input signal at any of its ports, it will return to the state it was in prior to the search.

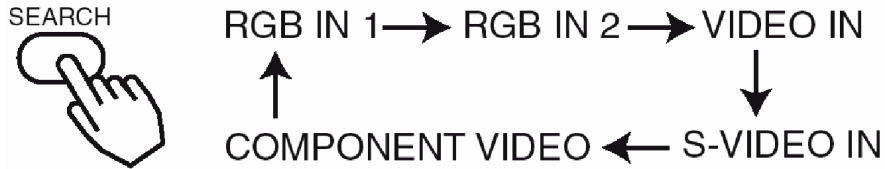

Selecting the Aspect Ratio

1 Press the ASPECT button



RGB IN 1, RGB IN 2, COMPONENT VIDEO

(HDTV signals : 1125i (1035i/1080i), 750p)

4:3 ←→ 16:9

VIDEO IN, S-VIDEO IN, COMPONENT VIDEO

(Non-HDTV signals : 525i, 525p, 625i)

4:3 → 16:9 → SMALL
↑

Temporarily Blanking the Screen

1 Press the BLANK button

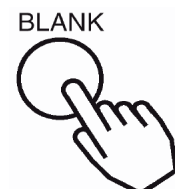

The input signal screen is shut off, and a blank screen appears. You can set the blank screen using the menu (from the SCREEN menu, select BLANK). Press the BLANK button again to remove the blank screen, and return to the input signal screen.



Using the Menu Functions

1 Press the MENU button

The menu display appears on the screen. The projector has the following menus: MAIN, PICTURE 1, PICTURE 2, INPUT, SCREEN, and OPTION.

Select a menu using the  /  buttons. The current settings of the items that can be manipulated via the selected menu appear.

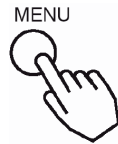

2 Select a menu using the / buttons, then press the or ENTER button.

The display for the selected menu appears.

[ex. Adjusting SHARPNESS]

Use the  /  buttons to select PICTURE 1, then press the  or ENTER button.

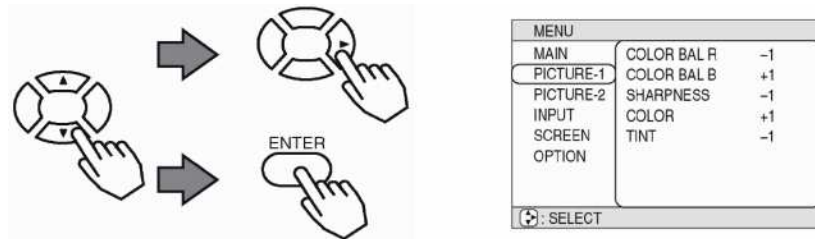

3 Select an item using the / buttons, then press the or the ENTER button.

The operation display of the selected item appears. To adjust a numerical value, press the  or ENTER button again to switch to the single menu (small display showing only the operation display area).

[ex. Adjusting SHARPNESS]

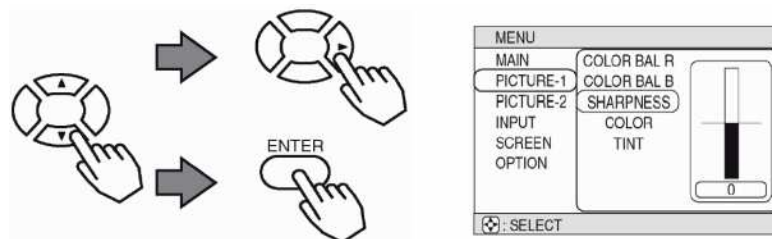

Use the  /  buttons to select SHARPNESS, then press the  or the ENTER button.



4 Press the / buttons to adjust the level.

Press the MENU button to hide the menu and finish your operation. Alternatively, press the  or ESC button to return to the previous display.

[ex. Adjusting SHARPNESS]

Use the  /  buttons to adjust the SHARPNESS.



Operating the PC Screen

You can use the remote control as a simplified mouse or keyboard.

CAUTION: Mistaken use of the mouse/keyboard control could damage your equipment.

- Only connect to a PC.
- Before connecting, read the manuals of the device you will connect.
- Do not unplug the connector cables while the computer is operating.

PS/2, ADB, Serial Mouse Control

- 1 Turn off the projector and PC power, and connect the projector's CONTROL terminal to the computer via the mouse cable.
- 2 If a USB cable is connected, disconnect it. If a USB cable is connected, the USB control function is given priority, and mouse control from the CONTROL terminal will not function.
- 3 Turn on the projector power, then the computer.
The functions in the table below can be controlled. If you have difficulty with control, restart the computer (either from the software or by pressing the restart button).

Available Functions	Remote Control Operation
Move Pointer	Use ◀, ▶, ▲, ▼ button
Left click with mouse	Press ENTER button
Right click with mouse	Press RESET button

USB Mouse/Keyboard Control

- 1 Connect the projector's USB terminal to the computer using a USB cable. The functions in the table below can be controlled.

Available Functions	Remote Control Operation
Move Pointer	Use ◀, ▶, ▲, ▼ button
Left click with mouse	Press ENTER button
Right click with mouse	Press RESET button
Press keyboard's HOME key	Press HOME button
Press keyboard's END key	Press END button
Press keyboard's PAGE UP key	Press PAGE UP button
Press keyboard's PAGE DOWN key	Press PAGE DOWN button
Press keyboard's ESC key	Press ESC button

NOTES:

- It may not be possible to control notebook PCs, and other computers with built-in pointing devices (e.g. track balls), using this remote control. In this case, before connecting go into BIOS (system setup) and select external mouse, and disable the pointing devices. In addition, the mouse may not function if the computer does not have the needed utility program. See your computer's hardware manual for details.
- The USB control can be used with Windows 95 OSR 2.1 or higher. It may not be possible to use the remote control, depending on the computer's configurations and mouse drivers.
- The USB control can only be used for the functions listed above. You cannot do things like press two buttons at once (for instance, pressing two buttons at the same time to move the mouse pointer diagonally).
- This function is not available while the lamp is warming up (the POWER indicator flashes green), while adjusting the volume and display, correcting for trapezoidal distortion, zooming in on the screen, using the BLANK function, or displaying the menu screen.

OSD Menu Function Description

This device has 6 separate menus: MAIN, PICTURE 1, PICTURE 2, INPUT, SCREEN and OPTION. Each of these menus is operated using the same methods.

The basic operations of these menus are as follows.

Menu screen display	Press the "MENU" button.
Menu selection	Choose a menu name using the / button, and press the button or the ENTER button.
Item selection	Choose an item using the / button, and press the button or the ENTER button.
Return menu to last previous screen	Press the button or the ESC button.
Execution of settings and/or adjustments	Operate by using the / button. (For further details, read the explanation for each separate menu.)
Initialization of settings and/or adjustments	During operation, press the RESET button. (Note that items whose functions are performed simultaneously with the operation of clock phase, language selection, automatic adjustment, etc., cannot be initialized.)
End menu operations	Press the MENU button, or do not perform any operation for several seconds.

Main Menu

With the MAIN menu, the seven items shown in the Table below can be performed.

Perform each operation in accordance with the instructions in the Table.

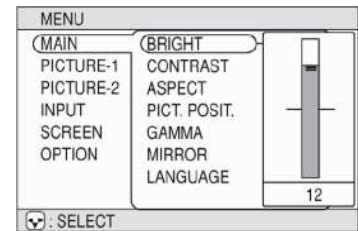

Item	Description
BRIGHT	Adjust Brightness: Light ⇌ Dark
CONTRAST	Adjust Contrast: Strong ⇌ Weak
ASPECT	Select Aspect Ratio: At RGB Input or Hi-Vision 1125i(1035i/1080i)/750p of COMPONENT VIDEO Input: 4:3 ⇌ 16:9 At VIDEO Input, S-VIDEO Input or 525i/525p/625i of COMPONENT VIDEO Input: 4:3 ⇌ 16:9 ⇌ SMALL The SMALL picture may not be displayed correctly with certain input signals.
PICT. POSIT.	Select Picture Position (for 16:9/SMALL Picture): TOP ⇌ CENTER ⇌ BOTTOM
GAMMA	Select Gamma Mode: NORMAL ⇌ CINEMA ⇌ DYNAMIC
MIRROR	Select Mirror Status: NORMAL ⇌ H:INVERT ⇌ V:INVERT ⇌ H&V:INVERT
LANGUAGE	Select Menu Language: ENGLISH ⇌ FRANÇAIS ⇌ DEUTSCH ⇌ ESPAÑOL ⇌ ITALIANO ⇌ NORSK ⇌ NEDERLANDS ⇌ 日本語 ⇌ POTUGUÊS ⇌ 中文

Picture 1 Menu

With the PICTURE 1 menu, the five items shown in the Table below can be performed.
Perform each operation in accordance with the instructions in the Table.

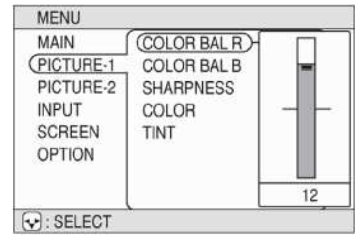

Item	Description
COLOR BAL R	Adjust Red Color Balance: Dark ⇌ Light
COLOR BAL B	Adjust Blue Color Balance: Dark ⇌ Light
SHARPNESS	Adjust Sharpness (for VIDEO/S-VIDEO): Clear ⇌ Soft
COLOR	Adjust COLOR (for VIDEO/S-VIDEO/COMPONENT VIDEO): Dark ⇌ Light
TINT	Adjust Tint (for VIDEO/S-VIDEO): Green ⇌ Red

Picture 2 Menu

With the PICTURE 2 menu, the five items shown in the Table below can be performed.
Perform each operation in accordance with the instructions in the Table.

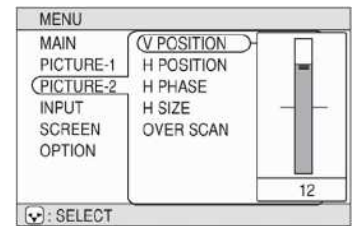

Item	Description
V POSITION	Adjust Vertical Position (for RGB): Up ⇌ Down
H POSITION	Adjust Horizontal Position (for RGB): Left ⇌ Right
H PHASE	Adjust Horizontal Phase (for RGB/COMPONENT VIDEO): Right ⇌ Left Adjust to eliminate flicker.
H SIZE	Adjust Horizontal Size (for RGB): Large ⇌ Small If the horizontal size adjustment is excessive, the image may not be displayed correctly. In such a case, initialize H SIZE with the RESET button.
OVER SCAN	Select Over-scan Ratio (for VIDEO/S-VIDEO/COMPONENT VIDEO): LARGE ⇌ MIDDLE ⇌ SMALL It is recommended to select SMALL to avoid flicker at the lower part of the picture.

Input Menu

With the INPUT menu, the four items shown in the Table below can be performed. With inputting of RGB IN 1 and RGB IN 2 signals, the horizontal and vertical frequencies of the signals will be displayed on the initial screen of the INPUT menu.

Perform each operation in accordance with the instructions in the Table.

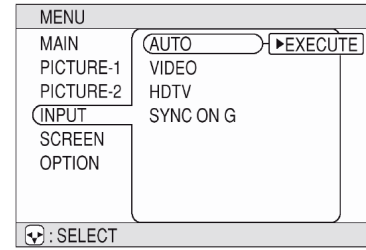

Item	Description
AUTO	<p>Auto Adjust (for RGB): Automatically adjusts H POSITION, V POSITION, H PHASE, and H SIZE. Use this function with the maximum window size.</p> <p>Auto Adjust (for VIDEO/S-VIDEO): Automatically selects the proper VIDEO mode for the current input signal. This function is active only when the AUTO mode is selected for the item VIDEO. Refer to the description for the item VIDEO below.</p> <p>This function may not be available with a PAL60 signal and certain other signals. The AUTO mode operation requires approximately 10 seconds. For COMPONENT VIDEO, the signal type is identified automatically even if this function is inactive. For a HDTV signal, refer to the item HDTV below.</p>
VIDEO	<p>Select Mode of Signal Type (for VIDEO/S-VIDEO): AUTO (▼) ↔ (▲) NTSC (▼) ↔ (▲) PAL (▼) ↔ (▲) SECAM (▼) ↔ (▲) NTSC4.43 (▼) ↔ (▲) M-PAL (▼) ↔ (▲) N-PAL</p> <p>Selecting AUTO mode activates and performs the AUTO function for VIDEO/SVIDEO. It automatically selects the proper mode from among those above. Use this function if the image becomes unstable with VIDEO/S-VIDEO. (e.g. The image becomes irregular, or lacks color.)</p> <ul style="list-style-type: none"> AUTO mode may not function correctly with a PAL60 signal and certain other signals. The AUTO mode operation requires approximately 10 seconds. For COMPONENT VIDEO, the signal type is identified automatically even if this function is inactive. For a HDTV signal, refer to the item HDTV below.
HDTV	<p>Select HDTV Signal Mode: 1080i (▼) ↔ (▲) 1035i</p> <ul style="list-style-type: none"> If the selected HDTV mode is incompatible with the input signal, the picture may be distorted.
SYNC ON G	<p>On/Off SYNC ON G Mode: TURN ON (▼) ↔ (▲) TURN OFF</p> <p>Selecting TURN ON turns on the SYNC ON G mode. The SYNC ON G mode allows reception of SYNC on G.</p> <ul style="list-style-type: none"> In the SYNC ON G mode, the picture may be distorted with certain input signals. In such cases, remove the signal connector so that no signal is received and turn SYNC ON G off, and then reconnect the signal.

Screen Menu

With the SCREEN menu, the five items shown in the Table below can be performed.

Please perform each operation in accordance with the instructions in the Table.

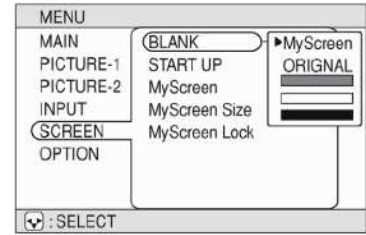

Item	Description
<p>BLANK</p>	<p>Selection of BLANK Screen: MyScreen (▼) ⇔ (▲) ORIGINAL (▼) ⇔ (▲), [Grey Box], (▼) ⇔ (▲), [Black Box], (▼) ⇔ (▲), [Black Box]</p> <p>The BLANK Screen may be voluntarily selected. The BLANK Screen is displayed when the screen has been erased (i.e., made to vanish) by manipulating the BLANK button (please refer to the “Temporarily Blanking the Screen” section of the separate booklet, Vol. 1 (Basic)).</p> <p>MyScreen: Using the MyScreen category (see this Table, below), one can register a desired screen (or screens). At the time of factory shipment, this is set as a non-patterned (plain) blue color screen.</p> <p>ORIGINAL: Existing standard screens. Please make confirmation using the actual screen(s).</p> <p>Option screens: Various colored non-patterned (plain) screens displayed within the Menus.</p> <ul style="list-style-type: none"> The MyScreen and the ORIGINAL Screen will each change to a non-patterned (plain) black color screen several minutes after being displayed.
<p>START UP</p>	<p>Selection of START UP Screen: MyScreen (▼) ⇔ (▲) ORIGINAL (▼) ⇔ (▲) TURN OFF</p> <p>The START UP Screen may be voluntarily selected. The START UP Screen is displayed when no signal has been inputted, or when spec signals are being inputted.</p> <p>MyScreen: Using the MyScreen category (see this Table, below), one can register a desired screen (or screens). At the time of factory shipment, this is set as a non-patterned (plain) blue color screen.</p> <p>ORIGINAL: Existing standard screens. Please make confirmation using the actual screen(s).</p> <p>TURN OFF: A non-patterned (plain) blue color screen.</p> <ul style="list-style-type: none"> The MyScreen and the ORIGINAL Screen will each change to the BLANK Screen several minutes after being displayed.

MyScreen	<p>Registration of MyScreen: When this item is executed, the MyScreen Menu for registration of MyScreen for the BLANK Screen and the START UP Screen is displayed. When operations are performed in accordance with this Menu, one can “cut” and register desired screens from among the received images within the display.</p> <ol style="list-style-type: none"> 1. After the “Do you start capturing this picture?” message has been displayed, pressing the ESC (or RESET) button interrupts execution of the MyScreen. When the ENTER button is pressed, the picture becomes static (no longer moves), and a frame for picture cutting, as well as the message that follows below, appear. Please press the button when the screen you want to register is currently being displayed. 2. When the “Move the capture area as you want.” message has been displayed, pressing the ESC (or RESET) button will eliminate the static state of the picture, and operations can be performed again from operation 1. The frame can be moved using the ◀, ▶, ▲, ▼ buttons. After designating the screen you want to register, pressing the ENTER button will initiate screen registration. The registration process takes approximately 1 minute to complete. 3. When the registration has been completed, the screen of the registered MyScreen, and the message, “MyScreen registration is finished,” will be displayed for several seconds, after which the operation is terminated.
MyScreen Size	<p>Selection of MyScreen display size: x1 ▼ ↔ ▲ FULL</p>
MyScreen Lock	<p>Invalidation of MyScreen registration function: TURN ON ▼ ↔ ▲ TURN OFF</p> <p>When TURN ON is selected, the MyScreen category (see this Table, above) cannot be executed. In this way, one can prohibit rewrites (“writeovers”) of the MyScreen</p>

Option Menu

With the OPTION menu, the five items shown in the Table below can be performed.

Please perform each operation in accordance with the instructions in the Table.

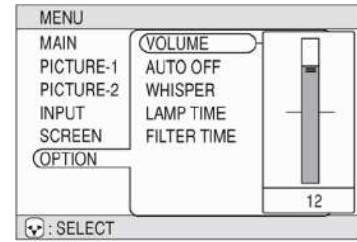

Item	Description
VOLUME	Adjust Volume: High ⇌ Low
AUTO OFF	Adjust AUTO OFF Time: Long (MAX. 99 min.) ⇌ Short (Min. 1 min.) ⇌ (DISABLE: 0 min.) The system automatically enters the standby mode if no signal is received within the set time. This function is inactive when DISABLE (0 min.) is selected.
WHISPER	Select WHISPER Mode: NORMAL ⇌ WHISPER When WHISPER is selected the WHISPER mode is activated. In the WHISPER mode, acoustic noise and screen brightness are reduced.
LAMP TIME	Refer to LAMP TIME: When set, this function displays the total time the projector lamp has been used since new. Reset LAMP TIME [Use this function only when the lamp has been replaced!]: Depress the RESET button for at least 3 seconds while lamp time is being displayed. The reset menu will then appear. After you replace the lamp with a new lamp, select RESET on the menu with the button. <ul style="list-style-type: none"> Do not reset the lamp time unless you have replaced the lamp. And, always reset the lamp time when replacing the lamp. The message functions will not operate properly if the lamp time is not reset correctly. After the lamp running reaches 2000 hours, a warning message is displayed: "To maximize performance, lamp replacement is recommended.", but won't shut the unit off. The message display for 30 seconds when the PJ is turned on. If we push any button while displaying the message, the message disappears. Before replacing the lamp, carefully read the descriptions headed "THE LAMP".
FILTER TIME	Refer to FILTER TIME: This function displays the total time the air-filter has been used since new. Reset FILTER TIME [Use this function only when the filter is cleaned or replaced!]: Depress the RESET button for at least 3 seconds while lamp time is being displayed. The reset menu will then appear. After you replace the filter, select RESET on the menu with the button. DEFAULT ⇌ CANCEL <ul style="list-style-type: none"> Do not reset the filter time unless you have cleaned or replaced the filter. And, always reset the filter time when cleaning or replacing the filter. The message functions will not operate properly if the filter time is not reset correctly. Before cleaning or replacing the filter, carefully read the descriptions headed "THE AIR FILTER".

Maintenance

Lamp

WARNING



The projector uses a high-pressure mercury glass lamp. The lamp can **break with a loud bang, or burn out**, if jolted or scratched, handled while hot, or worn over time. Note that each lamp has a different lifetime, and some may burst or burn out soon after you start using them. In addition, when the bulb bursts, it is possible for **shards of glass** to fly into the lamp housing, and for **gas containing mercury** to escape from the projector's vent holes

About disposal of a lamp

- This product contains a mercury lamp; do not put in trash. Dispose of in accord with environmental laws.
 - For lamp recycling, go to www.lamprecycle.org. (in USA)
 - For product disposal, contact your local government agency or www.eiae.org (in the US) or www.epsc.ca (in Canada).
 - For more information, call your dealer.
-



Disconnect
the plug from
the power
outlet

- If the lamp should break (it will make a loud bang when it does), unplug the power cord from the outlet, and make sure to request a replacement lamp from your local dealer. Note that shards of glass could damage the projector's internals, or cause injury during handling, so please do not try to clean the projector or replace the lamp yourself.
 - If the lamp should break (it will make a loud bang when it does), ventilate the room well, and make sure not to breathe the gas that comes out of the projector vents, or get it in your eyes or mouth.
 - Before replacing the lamp, make sure the power switch is off and the power cable is not plugged in, then wait at least 45 minutes for the lamp to cool sufficiently. Handling the lamp while hot can cause burns, as well as damaging the lamp.
-



- Do not open the lamp cover while the projector is suspended from above. This is dangerous, since if the lamp's bulb has broken, the shards will fall out when the cover is opened. In addition, working in high places is dangerous, so ask your local dealer to have the lamp replaced even if the bulb is not broken.
 - Do not use the projector with the lamp cover removed. At the lamp replacing, make sure that the screws are screwed in firmly. Loose screws could result in damage or injury.
-



- Use only the lamp of the specified type **RLU-150-001**.
- If the lamp breaks soon after the first time it is used, it is possible that there are electrical problems elsewhere besides the lamp. If this happens, contact your local dealer or a service representative.
- Handle with care: jolting or scratching could cause the lamp bulb to burst during use.
- If the indicators or a message prompts you to replace the lamp (see the section "Related Messages" and "Regarding the indicator Lamps"), replace the lamp as soon as possible. Using the lamp for long periods of time, or past the replacement date, could cause it to burst. Do not use old (used) lamps; this is a cause of breakage.

Lamp Life

Projector lamps have a finite life. The projected images will become darker and hues will become weaker after a lamp has been used for a long period of time.

The LAMP indicator also becomes red when the lamp unit reaches a high temperature. Before replacing the lamp, switch the POWER OFF, wait approximately 20 minutes, then switch the POWER ON again. If the LAMP indicator still displays red, replace the lamp.

Replacing the Lamp

All projector lamps will wear out eventually. If used for long periods of time, the image could become darkened, and the color contrast could be impacted as well. We recommend that you replace your lamps early. If the LAMP indicator turns red, or a message prompts you to replace the lamp when you power up the projector, the lamp needs to be replaced.

- 1 Turn off the projector, and unplug the power cord. Allow the lamp bulb to cool for at least 45 minutes, and prepare a new lamp
- 2 After making sure that the projector has cooled adequately, slowly flip over the projector, so that the bottom is facing up
- 3 Unscrew the 2 screws, and remove the lamp cover

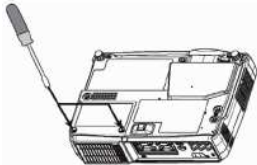

- 4 Unscrew the 1 screw, and slowly pull out the lamp by the handle
 - Be careful not to touch the inside of the lamp case.

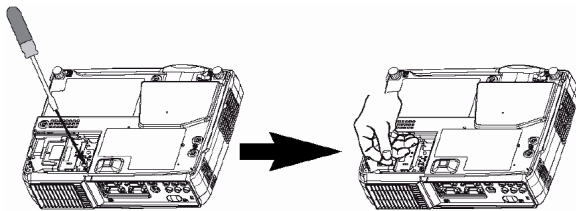

- 5 Insert the new lamp, and tighten the 1 screw firmly to lock it in place
 - Also steadily push the opposite side of the screwed side of the lamp into the unit.

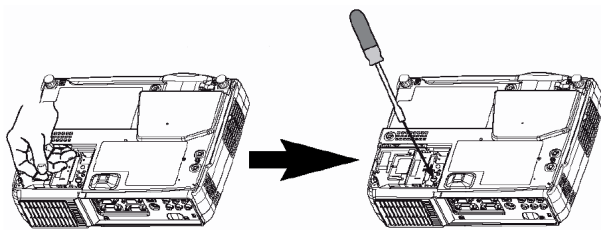

- 6 Replace the lamp cover, and tighten the 2 screws firmly to lock it in place

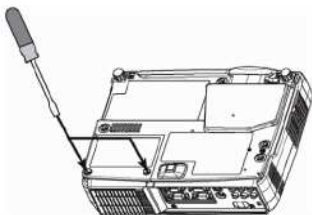

- 7 Slowly turn the projector so that the top is facing up
- 8 Turn on the projector power, and using the menu, reset the lamp timer
 - To reset the lamp timer, from the OPTION menu, select LAMP TIME.

ATTENTION:

- Make sure that the screws are screwed in firmly. Loose screws could result in damage or injury.
- Do not use with lamp cover removed.
- Do not reset the lamp timer without replacing the lamp.

NOTE:

The LAMP indicator is also red when the lamp unit reaches high temperature.

Before replacing the lamp, switch power OFF, wait approximately 20 minutes, and switch power ON again. If the LAMP indicator is still red, replace the lamp.

Caring for the Air Filter

The air filter should be cleaned about every 100 hours. Clean the filter if the LAMP indicator and TEMP indicator blink red simultaneously, or if a message prompts you to clean the air filter when you turn on the unit, the filter needs to be cleaned. (Refer to “On-Screen Messages” in the Trouble-shooting section.)

- 1 Turn off the projector, then unplug the power cord
- 2 To clean a reusable filter, carefully vacuum both sides of the filter area.

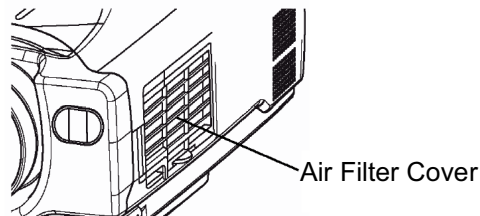

- 3 If the filter is damaged and needs to be replaced, contact your dealer or ViewSonic Corp. Replace the old filter then put the grill back in place.
- 4 To reset the Filter Timer, turn on the projector power, go to the Option menu then select filter timer. Reset the filter timer.

CAUTION:

- Switch power OFF and remove the power cord from the power outlet before beginning maintenance work.
- Replace the air filter if contamination cannot be removed or if it is damaged.
- Do not use the equipment with the air filter removed.
- When the air filter becomes clogged with dust etc., the power supply may switch OFF automatically to prevent the temperature from rising inside the projector.
- Make sure the lens is cool before cleaning.
- Do not use detergents or solvents such as benzene or thinners.
- Do not use chemical sprays.
- Use a soft cloth or lens paper only.

Caring for the Inside of the Projector

In order to ensure the safe use of your projector, please have it cleaned and inspected by an authorized Service Provider approximately once every 2 years. Never try to care for the inside of the unit yourself. Doing so is dangerous.

Caring for the Lens

Lightly wipe the lens with a commercially available lens-cleaning wipe. Do not touch the lens directly with your hand.

Caring for the Cabinet and Remote Control Transmitter

Wipe lightly with gauze or a soft cloth. If soiling is severe, dip a soft cloth in water or a neutral cleanser diluted in water, and wipe lightly after wringing well. Then, wipe lightly with a soft, dry cloth.

CAUTION:

- Make sure to turn off the power and unplug the power cord before caring for the unit. Please care-fully read all the PJ650 / PJ520 Quick START GUIDE in this manual, in order to care for your projector correctly.
- Do not use cleaners or chemicals other than those listed above, including benzene and paint thinner.
- Do not use aerosols or sprays.
- Do not polish or wipe with coarse material.
- Gently wipe with a soft cloth. If dirt and stains etc. are not easily removed, use a soft cloth dampened with water, or water and a neutral detergent, and wipe dry with a soft, dry cloth.

Troubleshooting

On-screen Messages

When the unit's power is ON, messages such as those shown below may be displayed. When any such message is displayed on the screen, please respond as described below.

Message	Description
TO MAXIMIZE PERFORMANCE, LAMP REPLACEMENT IS RECOMMENDED.	The unit does not display a warning message on the screen when the lamp expires or fails. When the lamp does not light, this indicates that the lamp is no longer functional and should be replaced. Replace the lamp and do not forget to reset the timer.
CLEAN THE AIR FILTER AFTER CLEANING AIR FILTER, RESET THE FILTER TIMER.	A note of precaution when cleaning the air filter. After cleaning the filter, operate FILTER TIME of the OPTION Menu, then perform reset of the filter timer.
NO INPUT IS DETECTED ON ***	There is no input signal. Check the signal input connection and the status of the signal source.
SYNC IS OUT OF RANGE ON ***	The horizontal or vertical frequencies of the inputted signal is outside of the operating range limits of this unit. Please confirm the specs for this unit or the signal source specs.
CHECK THE AIR FLOW	The internal temperature is rising. Please turn the power OFF, then allow the unit to cool down for approximately 20 minutes. After having confirmed the following items, then please reset the power to ON. <ul style="list-style-type: none">• Is there blockage of the air filter?• Is the air filter dirty?• Does the ambient temperature exceeds 35°C?

Panel Lamp Indicators

Lighting and flashing of the POWER indicator, the LAMP indicator, and the TEMP indicator have the meanings as described in the Table below.

Please respond in accordance with the instructions within the Table.

POWER indicator	LAMP indicator	TEMP indicator	Description
The orange lamp is lighted	Turned OFF (Not lighted)	Turned OFF (Not lighted)	The STANDBY mode is set
Flashing of the green lamp	Turned OFF	Turned OFF	The unit is warming up. Please wait.
The green lamp is lighted	Turned OFF	Turned OFF	The unit is in an ON state. Ordinary operations may be performed.
Flashing of the orange lamp	Turned OFF	Turned OFF	The unit is cooling down. Please wait.
Blinking of the red lamp	-	-	The unit is cooling down. Please wait. A certain error has been detected. Wait until the POWER indicator lamp has finished flashing, and then perform the proper response measure using the item descriptions below as reference.
The red lamp is lighted, or blinks	The red lamp is lighted	Turned OFF	The lamp does not light. There is a possibility that the interior portion has become heated. Turn the power OFF and wait approximately 20 minutes. After the main unit has cooled down, please confirm whether or not there is blockage of the air passage aperture, whether or not the filter is dirty, and/or whether or not the peripheral temperature exceeds 35°C, etc. After performing any needed maintenance, turn the power ON again; if the same display is displayed, then please change the lamp.
The red lamp is lighted, or blinks	Blinking of the red lamp	Turned OFF	Either there is no lamp and/or lamp cover, or either of these has not been properly fixed (attached). Turn the power OFF and wait approximately 45 minutes. After the main unit has sufficiently cooled down, please make confirmation of the attachment state of the lamp and lamp cover. After performing any needed maintenance, turn the power ON again; if the same display is displayed, then please contact a sales store or a service company.
The red lamp is lighted, or blinks	Turned OFF	Blinking of the red lamp	The cooling fan is not operating. Turn the power OFF and wait approximately 20 minutes. After the main unit has cooled down, please make confirmation that no foreign matter has become caught in the fan, etc. After performing any needed maintenance, turn the power ON again; if the same display is displayed, then please contact a sales store or a service company.
The red lamp is lighted, or blinks	Turned OFF	The red lamp is lighted	There is a possibility that the interior portion has become heated. Turn the power OFF and wait approximately 20 minutes. After the main unit has cooled down, please confirm whether or not there is blockage of the air passage aperture, whether or not the filter is dirty, and/or whether or not the peripheral temperature exceeds 35°C, etc. After performing any needed maintenance, turn the power ON again; if the same display is displayed, then please contact a sales store or a service company.
The green lamp is lighted	Alternative blinking with the red lamp		There is a possibility that the interior portion has become overcooled. Please use the unit within the usage temperature parameters (0°C to 35°C). After performing any needed maintenance, turn the power ON again; if the same display is displayed, then please contact a sales store or a service company.
The green lamp is lighted	Simultaneous blinking with the red lamp		This is a notification that it is time to clean the filter. After cleaning the filter, operate the FILTER TIME portion of the OPTION Menu, and perform reset of the FILTER TIME.

NOTE:

When the interior portion has become overheated, for safety purposes, the power source is automatically turned OFF, and the indicator lamps may also be turned OFF. Press the "O" (power OFF) side of the main power switch, and wait for approximately 20 minutes. Please then use the unit only after having first confirmed that the unit has sufficiently cooled down.

Problem Diagnostics

Before requesting repair, please check the following chart. If the situation cannot be corrected, then contact your dealer.

Phenomenon	Cases not involving a machine defect	Items to be confirmed
Power does not come ON	The main power source is not ON.	Turn on the main power.
	The electrical power cord is not plugged in.	Correctly connect the power cord. points.
	The main power source has been interrupted during operation, such as by a power outage (blackout), etc.	Be sure to press the "O" (power OFF) side of the main power switch, and leave this OFF for approximately 20 minutes. After the unit has sufficiently cooled down, turn ON the power source.
No sound or pictures are outputted	The input changeover settings are mismatched.	Select the input signal, and correct the settings.
	The input changeover settings are mismatched.	Correctly connect the connection cord.
	No signal is being inputted.	Correctly connect the connection cord.
Pictures are displayed, but no sounds are heard	The electrical wiring to this unit is not correctly connected.	Correctly connect the connection cord.
	The volume setting has been set at (or adjusted to) an extremely low level.	Adjust the VOLUME setting to a higher level.
	MUTE is turned on.	Press the MUTE button to toggle the MUTE mode setting..
Sounds are heard, but no pictures are displayed	The electrical wiring to this unit is not correctly connected.	Correctly connect the connection cord.
	The brightness setting has been set at (or adjusted to) an extremely low level.	Adjust the BRIGHT setting to a brighter level.
	The lens cap has not been removed.	Remove the lens cap.
Colors have a faded-out appearance. Color tone is poor	Color depth setting or color tone setting	Perform picture adjustments by changing the COLOR BAL R, the COLOR BAL B, and/or the TINT settings, etc.
Pictures appear dark	The brightness setting and/or contrast setting has not been properly adjusted.	Perform picture adjustments by changing the BRIGHT and/or CONTRAST settings, etc.
	The WHISPER mode is the current setting.	Toggle from the WHISPER mode.
	Lamp is approaching the end of its product lifetime.	Repalce the Lamp Assembly.
Pictures appear blurry	Either the FOCUS setting or the H PHASE is not properly adjusted.	Adjust the FOCUS and H PHASE settings.

NOTE:

When the interior becomes overheated, power to the unit automatically shuts down. Press the main switch on the side of the unit to the off position then wait 20 minutes to allow the unit to cool down before any work is done to the unit.

Specifications

This specifications are subject to change without notice.

Item		Specification														
Product name		PJ650 / PJ520														
Liquid crystal projector	Panel size	1.8 cm (0.7 type)														
	Drive system	TFT active matrix														
	Pixels	PJ650: 786,432 pixels (1024 horizontal x 768 vertical) PJ520: 480,000 pixels (800 horizontal x 600 vertical)														
Lens		Zoom lens F=1.7 ~ 1.9 =21.7~26.1 mm														
Lamp		150 W UHB														
Speaker		1.0W														
Power supply		AC100 ~ 120V, 2.7A / AC220 ~ 240V, 1.3A														
Power consumption		240W (typ.)														
Temperature range		0 ~ 35°C (32~95° F) (Operating)														
Size		295 (W) x 87.5 (H) x 237 (D) mm 11.6 (W) x 3.4 (H) x 9.3 (D) inches														
Weight (mass)		2.7 kg (6.04 lbs)														
Ports		<table border="0"> <tr> <td>RGB Terminal</td> <td>AUDIO Terminal</td> </tr> <tr> <td>RGB IN (1,2).....2</td> <td>AUDIO IN (R, L)..... 1</td> </tr> <tr> <td>VIDEO Terminal</td> <td>OUT Terminal</td> </tr> <tr> <td>VIDEO IN.....1</td> <td>RGB OUT.....1</td> </tr> <tr> <td>S-VIDEO IN.....1</td> <td>CONTROL Terminal</td> </tr> <tr> <td>COMPONENT VIDEO</td> <td>CONTROL.....1</td> </tr> <tr> <td>(Y, C_B/P_B, C_R/P_R).....1</td> <td>USB.....1</td> </tr> </table>	RGB Terminal	AUDIO Terminal	RGB IN (1,2).....2	AUDIO IN (R, L)..... 1	VIDEO Terminal	OUT Terminal	VIDEO IN.....1	RGB OUT.....1	S-VIDEO IN.....1	CONTROL Terminal	COMPONENT VIDEO	CONTROL.....1	(Y, C _B /P _B , C _R /P _R).....1	USB.....1
RGB Terminal	AUDIO Terminal															
RGB IN (1,2).....2	AUDIO IN (R, L)..... 1															
VIDEO Terminal	OUT Terminal															
VIDEO IN.....1	RGB OUT.....1															
S-VIDEO IN.....1	CONTROL Terminal															
COMPONENT VIDEO	CONTROL.....1															
(Y, C _B /P _B , C _R /P _R).....1	USB.....1															
Optional Parts		Lamp: RLU-150-001 ViewSonic offers other accessories including items such as air filters, remote controls, ceiling mounting brackets, manuals, soft cases, etc. Please contact your dealer or ViewSonic for information.														

Outline Dimension

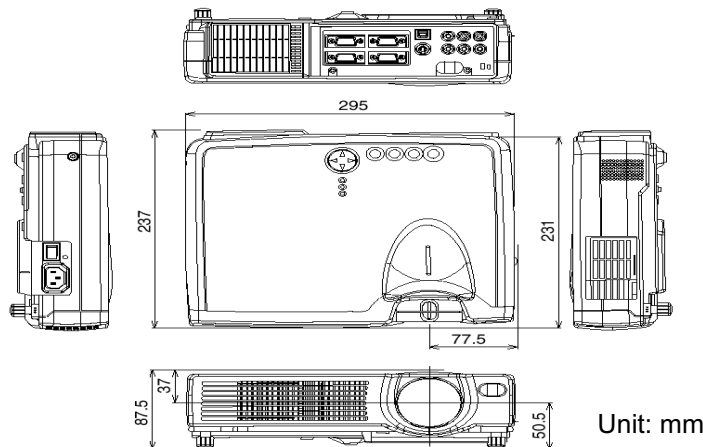

Customer Support

For technical support or product service, see the table below or contact your reseller.

NOTE: You will need the product serial number.

Country/ Region	Web site	T = Telephone F = FAX	Email
United States	viewsonic.com/ support	T: (800) 688-6688 F: (909) 468-1202	service.us@ viewsonic.com
Canada	viewsonic.com/ support	T: (800) 688-6688 F: (909) 468-1202	service.ca@ viewsonic.com
United Kingdom	viewsoniceurope.com	T: 0800 833 648 F: (01293) 643910	service.eu@ viewsoniceurope.com
Europe, Middle East, Baltic countries, and North Africa	viewsoniceurope.com	Contact your reseller	service.eu@ viewsoniceurope.com
Australia and New Zealand	viewsonic.com.au	T: +61 2 9906 6277 F: +61 2 9906 6377	service@au. viewsonic.com
Singapore/ Malaysia/Thailand	viewsonic.com.sg	T: 65 273 4018 F: 65 273 1566	service@sg. viewsonic.com
Other Asia/Pacific countries	viewsonic.com.tw	T: 886 2 2246 3456 F: 886 2 8242 3668	service@sd. viewsonic.com
South Africa	viewsonic.com/asia	T: 886 2 2246 3456 F: 886 2 8242 3668	service@sd. viewsonic.com

LIMITED WARRANTY

VIEWSONIC Projector

What the warranty covers:

ViewSonic® warrants its products to be free from defects in material and workmanship during the warranty period. If a product proves to be defective in material or workmanship during the warranty period, **ViewSonic** will at its sole option repair or replace the product with a like product. Replacement product or parts may include remanufactured or refurbished parts or components.

How long the warranty is effective:

ViewSonic projectors are warranted for three (3) years for all parts excluding the lamp, three (3) years for all labor, and one (1) year for the lamp from the date of the first consumer purchase.

Lamp warranty subject to terms and conditions, verification and approval. Applies to manufacturer's installed lamp only. All accessory lamps purchased separately are warranted for 90 days.

Who the warranty protects:

This warranty is valid only for the first consumer purchaser.

What the warranty does not cover:

1. Any product on which the serial number has been defaced, modified or removed.
2. Damage, deterioration or malfunction resulting from:
 - a. Accident, misuse, neglect, fire, water, lightning, or other acts of nature, unauthorized product modification, or failure to follow instructions supplied with the product.
 - b. Repair or attempted repair by anyone not authorized by **ViewSonic**.
 - c. Any damage of the product due to shipment.
 - d. Removal or installation of the product.
 - e. Causes external to the product, such as electric power fluctuations or failure.
 - f. Use of supplies or parts not meeting **ViewSonic**'s specifications.
 - g. Normal wear and tear.
 - h. Any other cause which does not relate to a product defect.
3. Removal, installation, and set-up service charges.

How to get service:

1. For information about receiving service under warranty, contact **ViewSonic Customer Support**. You will need to provide your product's serial number.
2. To obtain warranted service, you will be required to provide (a) the original dated sales slip, (b) your name, (c) your address, (d) a description of the problem, and (e) the serial number of the product.
3. Take or ship the product freight prepaid in the original container to an authorized **ViewSonic** service center or **ViewSonic**.
4. For additional information or the name of the nearest **ViewSonic** service center, contact **ViewSonic**.

Limitation of implied warranties:

THERE ARE NO WARRANTIES, EXPRESS OR IMPLIED, WHICH EXTEND BEYOND THE DESCRIPTION CONTAINED HEREIN INCLUDING THE IMPLIED WARRANTY OF MERCHANTABILITY AND FITNESS FOR A PARTICULAR PURPOSE.

Exclusion of damages:

VIEWSONIC'S LIABILITY IS LIMITED TO THE COST OF REPAIR OR REPLACEMENT OF THE PRODUCT.

VIEWSONIC SHALL NOT BE LIABLE FOR:

1. DAMAGE TO OTHER PROPERTY CAUSED BY ANY DEFECTS IN THE PRODUCT, DAMAGES BASED UPON INCONVENIENCE, LOSS OF USE OF THE PRODUCT, LOSS OF TIME, LOSS OF PROFITS, LOSS OF BUSINESS OPPORTUNITY, LOSS OF GOODWILL, INTERFERENCE WITH BUSINESS RELATIONSHIPS, OR OTHER COMMERCIAL LOSS, EVEN IF ADVISED OF THE POSSIBILITY OF SUCH DAMAGES.
2. ANY OTHER DAMAGES, WHETHER INCIDENTAL, CONSEQUENTIAL OR OTHERWISE.
3. ANY CLAIM AGAINST THE CUSTOMER BY ANY OTHER PARTY.

Effect of state law:

This warranty gives you specific legal rights, and you may also have other rights which vary from state to state. Some states do not allow limitations on implied warranties and/or do not allow the exclusion of incidental or consequential damages, so the above limitations and exclusions may not apply to you.

Sales outside the U.S.A. and Canada:

For warranty information and service on **ViewSonic** products sold outside of the U.S.A. and Canada, contact **ViewSonic** or your local **ViewSonic** dealer.

Appendix

Power Cord Safety Guidelines

Caution: Use a power cable that is properly grounded. Always use an AC power cord that meets your country's safety standard.

USA..... UL	SwitzerlandSEV
Canada..... CSA	Britain.....BASE/BS
Germany..... VDE	

AC PLUG CORD PRECAUTIONS FOR THE UNITED KINGDOM

FOR YOUR SAFETY PLEASE READ THE FOLLOWING TEXT CAREFULLY.

IF THE FITTED MOULDED PLUG IS UNSUITABLE FOR THE SOCKET OUTLET THEN THE PLUG SHOULD BE CUT OFF AND DISPOSED OF SAFELY.

THERE IS A DANGER OF SEVERE ELECTRICAL SHOCK IF THE CUT OFF PLUG IS INSERTED INTO AN APPROPRIATE SOCKET.

If a new plug is to be fitted, please observe the wiring code as shown below.

If in any doubt, please consult a qualified electrician.

WARNING: THIS APPLIANCE MUST BE EARTHED.

IMPORTANT: The wires in this mains lead are coloured in accordance with the following code:

Green-and-Yellow: Earth	
Blue:	Neutral
Brown:	Live

If the coloured wires of the mains lead of this appliance do not correspond with the coloured markings identifying the terminals in your plug, proceed as follows:

The wire which is coloured GREEN-AND-YELLOW must be connected to the terminal in the plug which is marked by the letter E or by the Earth symbol or coloured GREEN or GREEN-AND-YELLOW.

The wire which is coloured BLUE must be connected to the terminal in the plug which is marked with the letter N or coloured BLACK. The wire which is coloured BROWN must be connected to the terminal in the plug which is marked with the letter L or coloured RED.

IMPORTANT NOTICE CONCERNING POWER CORD SELECTION

The power cord set for this unit has been enclosed and has been selected according to the country of destination and must be used to prevent electric shock. Use the following guidelines if it is necessary to replace the original cord set, or if the cord set is not enclosed.

The female receptacle of the cord set must meet CEE-22 requirements and may look like (Figure A1 below):

Figure 1 

For the United States and Canada

In the United States and Canada the male plug is a NEMA5-15 style (Figure A2), UL Listed, and CSA Labeled. For units which are mounted on a desk or table, type SVT cord sets may be used. The cord set must be selected according to the current rating for your unit. Please consult the table below for the selection criteria for power cords used in the United States and Canada.

Figure 2 

For customers in Canada:

Notice: This Class B digital apparatus complies with Canadian ICES-003.

Cord Type	Size of Conductors in Cord	Maximum Current Rating of Unit
SJT	18 AWG 16 AWG 14 AWG	10 Amps 12 Amps 12 Amps
SVT	18 AWG 17 AWG	10 Amps 12 Amps

For European Countries

In Europe you must use a cord set which is appropriate for the receptacles in your country. The cord set is HAR-Certified, and a special mark that will appear on the outer sheath, or on the insulation of one of the inner conductors.

If you have any questions concerning which proper power cord to use, please consult with the dealer from whom you have purchased the product.

Compliance Information for U.S.A.

This equipment has been tested and found to comply with the limits for a Class B digital device, pursuant to part 15 of the FCC Rules. These limits are designed to provide reasonable protection against harmful interference in a residential installation. This equipment generates, uses, and can radiate radio frequency energy, and if not installed and used in accordance with the instructions, may cause harmful interference to radio communications. However, there is no guarantee that interference will not occur in a particular installation. If this equipment does cause harmful interference to radio or television reception, which can be determined by turning the equipment off and on, the user is encouraged to try to correct the interference by one or more of the following measures:

- Reorient or relocate the receiving antenna.
- Increase the separation between the equipment and receiver.
- Connect the equipment into an outlet on a circuit different from that to which the receiver is connected.
- Consult the dealer or an experienced radio/TV technician for help.

FCC Warning

To assure continued FCC compliance, the user must use grounded power supply cord and the provided shielded video interface cable with bonded ferrite cores. If a BNC cable is going to be used, use only a shielded BNC(5) cable. Also, any unauthorized changes or modifications not expressly approved by the party responsible for compliance could void the user's authority to operate this device.

Instructions to Users

This equipment complies with the requirements of FCC (Federal Communication Commission) equipment provided that the following condition is met. **Use the cables which are included with the projector or specified.**

Compliance Information for Canada

Notice: This class B digital apparatus complies with Canada ICES-003.

AVIS: Cet appareil numérique de la Classe B conforme a la norme NMB-003 du Canada.

Compliance Information for European Countries

CE Conformity



The device complies with the requirements of the EEC directive 89/336/EEC as amended by 92/31/EEC and 93/68/EEC Art.5 with regard to "Electromagnetic compatibility," and 73/23/EEC as amended by 93/68/EEC Art.13 with regard to "Safety."

User Information for all Countries

NOTICE: Use the cables which are included with the projector or specified.

