



DATA PROJECTOR

MODEL

SE2U

User Manual

SE2

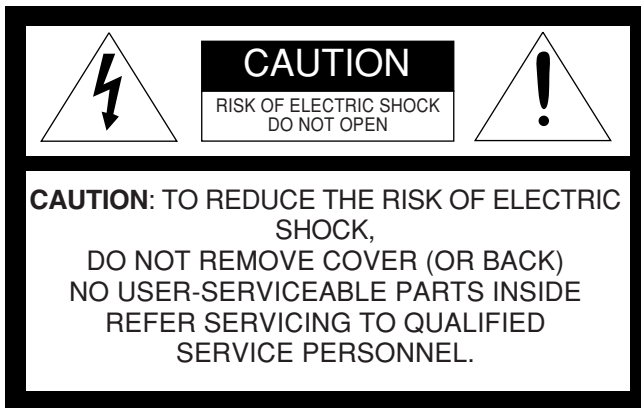

The lightning flash with arrowhead symbol within an equilateral triangle is intended to alert the user to the presence of uninsulated “dangerous voltage” within the product’s enclosure that may be of sufficient magnitude to constitute a risk of electric shock. The exclamation point within an equilateral triangle is intended to alert the user to the



presence of important operating and maintenance (servicing) instructions in the literature accompanying the appliance.

WARNING:

TO PREVENT FIRE OR SHOCK HAZARD, DO NOT EXPOSE THIS APPLIANCE TO RAIN OR MOISTURE.

CAUTION:

TO PREVENT ELECTRIC SHOCK, DO NOT USE THIS (POLARIZED) PLUG WITH AN EXTENSION CORD, RECEPTACLE OR OTHER OUTLET UNLESS THE BLADES CAN BE FULLY INSERTED TO PREVENT BLADE EXPOSURE.

NOTE:

SINCE THIS PROJECTOR IS PLUGGABLE EQUIPMENT, THE SOCKET-OUTLET SHALL BE INSTALLED NEAR THE EQUIPMENT AND SHALL BE EASILY ACCESSIBLE.

WARNING

Use the attached specified power supply cord. If you use another power-supply cord, it may cause interference with radio and television reception.

Use the attached VGA cable and the audio cable with this equipment so as to keep interference within the limit of a FCC Class B device.

This apparatus must be grounded.

DO NOT LOOK DIRECTLY INTO THE LENS WHEN THE PROJECTOR IS IN THE POWER ON MODE.

CAUTION

Not for use in a computer room as defined in the Standard for the Protection of Electronic Computer/Data Processing Equipment, ANSI/NFPA 75.

For USA only:

Handling the cord on this product or cords associated with accessories sold with this product, will expose you to lead, a chemical known to the State of California to cause birth defects or other reproductive harm. **Wash hands after handling.**

When using the projector in Europe: COMPLIANCE NOTICE

This Projector complies with the requirements of the EC Directive 89/336/EEC “EMC Directive” as amended by Directive 92/31/EEC and 93/68/EEC, and 73/23/EEC “Low Voltage Directive” as amended by Directive 93/68/EEC.

The electro-magnetic susceptibility has been chosen at a level that gains proper operation in residential areas, on business and light industrial premises and on small-scale enterprises, inside as well as outside of the buildings. All places of operation are characterised by their connection to the public low voltage power supply system.

WARNING

Use the attached VGA cable and the audio cable with this equipment so as to keep interference within the limits of an EN55022 Class B device. Please follow WARNING instructions.

Contents

Important Safeguards	1
Introduction	6
Shipping Contents	6
Projector Exterior View	7
Front / Upper Side	7
Rear Side	7
Bottom Side	7
Connector Panel	7
Controls and Functions	8
External Control Panel	8
Remote Control Description	9
Remote Control Effective Range	10
Installing or Replacing the Battery	10
Connection	11
Connecting to a Laptop or Desktop Computer	11
Connecting Equipment to the Component Video Input	12
Connecting Video and S-Video Devices	12
Connecting to Display Devices	13
Installation	14
Choosing a Location	14
Adjusting the Height	15
Screen Size	15
Operation	17
Start Up	17
Shutdown	18
Digital Keystone Correction	19
Source Selection	20
Auto Adjustment	20
Mute	21
Zoom / Focusing	21
Slide Operation	21
Still	22
Mode Selection	22

Menu Operation	23
Menu System	23
Using the Menus	24
1. Picture Menu	25
2. Pro-Picture Menu	27
3. Setting Menu	28
4. Advance Menu	29
5. Information Menu	30
Maintenance	31
Cleaning the Lens	31
Cleaning the Projector Case	31
Storing the Projector	31
Transporting the projector	31
Lamp Information	32
Warning Message	32
Replacing the Lamp	33
Temp Information	34
Indicators	35
Service Information	37
Accessories (included in the standard package)	37
Optional Accessories (not included in the standard package)	37
Ordering Parts or Getting Information	37
Troubleshooting	38
Specifications	39
Projector Specifications	39
Timing Chart	40
Supported Timing for PC Input	40
Supported Timing for Component-YPbPr Input	40
Supported Timing for Video and S-Video Inputs	40
Dimensions	41

Important safeguards

Please read all these instructions regarding your projector and retain them for future reference. Follow all warnings and instructions marked on the projector.

1. **Read instructions**
All the safety and operating instructions should be read before the appliance is operated.
2. **Retain instructions**
The safety and operating instructions should be retained for future reference.
3. **Warnings**
All warnings on the appliance and in the operating instructions should be adhered to.
4. **Instructions**
All operating instructions must be followed.
5. **Cleaning**
Unplug this projector from the wall outlet before cleaning it. Do not use liquid aerosol cleaners. Use a damp soft cloth for cleaning.
6. **Attachments and equipment**
Never add any attachments and/or equipment without the approval of the manufacturer as such additions may result in the risk of fire, electric shock or other personal injury.
7. **Water and moisture**
Do not use this projector near water or in contact with water.
8. **Accessories**
Do not place this projector on an unstable cart, stand, tripod, bracket or table. Use only with a cart, stand, tripod bracket, or table recommended by the manufacturer or sold with the projector. Any mounting of the appliance should follow the manufacturer's instructions and should use a mounting accessory recommended by the manufacturer.



An appliance and cart combination should be moved with care. Quick stops, excessive force and uneven surfaces may cause the appliance and cart combination to overturn.

9. **Ventilation**
Slots and openings in the cabinet are provided for ventilation, ensuring reliable operation of the projector and to protect it from overheating. Do not block these openings or allow them to be blocked by placing the projector on a bed, sofa, rug, or bookcase. Ensure that there is adequate ventilation and that the manufacturer's instructions have been adhered to.
10. **Power sources**
This projector should be operated only from the type of power source indicated on the marking label. If you are not sure of the type of power, please consult your appliance dealer or local power company.

11. Power-cord protection
Power-supply cords should be routed so that they are not likely to be walked on or pinched by items placed upon or against them. Pay particular attention to cords at plugs, convenience receptacles, and points where they exit from the appliance. Do not put the power cord under a carpet.
12. Overloading
Do not overload wall outlets and extension cords as this can result in a fire or electric shock.
13. Objects and liquids
Never push objects of any kind through openings of this projector as they may touch dangerous voltage points or short-out parts that could result in a fire or electric shock. Never spill liquid of any kind on the projector.
14. Servicing
Do not attempt to service this projector yourself. Refer all servicing to qualified service personnel.
15. Damage requiring service
Unplug this projector from the wall outlet and refer servicing to qualified service personnel under the following conditions:
 - (a) If the power-supply cord or plug is damaged.
 - (b) If liquid has been spilled, or objects have fallen into the projector.
 - (c) If the projector does not operate normally after you follow the operating instructions. Adjust only those controls that are covered by the operating instructions. An improper adjustment of other controls may result in damage and may often require extensive work by a qualified technician to restore the projector to its normal operation.
 - (d) If the projector has been exposed to rain or water.
 - (e) If the projector has been dropped or the cabinet has been damaged.
 - (f) If the projector exhibits a distinct change in performance - this indicates a need for service.
16. Replacement parts
When replacement parts are required, be sure that the service technician has used replacement parts specified by the manufacturer or parts having the same characteristics as the original part. Unauthorized substitutions may result in fire, electric shock or other hazards.
17. Safety check
Upon completion of any service or repair to this projector, ask the service technician to perform safety checks determining that the projector is in a safe operating condition.

WARNING:

Unplug immediately if there is something wrong with your projector.

Do not operate if smoke, strange noise or odor comes out of your projector. It may cause fire or electric shock. In this case, unplug immediately and contact your dealer.

Never remove the cabinet.

This projector contains high voltage circuitry. An inadvertent contact may result in an electric shock. Except as specifically explained in User Manual, do not attempt to service this product by yourself. Please contact your dealer when you want to fix, adjust, or inspect the projector.

Do not modify the projector.

It can lead to fire or electric shock.

Do not keep using the damaged projector.

If the projector is dropped and the cabinet is damaged, unplug the projector and contact your dealer for inspection. It may lead to fire if you keep using the damaged projector.

Do not face the projection lens to the sun.

It can lead to fire.

Use correct voltage.

If you use incorrect voltage, it can lead to fire.

Do not place the projector on uneven surface.

Place the projector on a level and stable surface only.

Do not look into the lens when the projector is operating.

It may hurt your eyes. Never let children look into the lens when the projector is on.

Do not unplug the power cord during operation.

It can lead to lamp breakage, fire, electric shock or other trouble. Wait for the fan to stop before unplugging the power cord.

Do not touch the air outlet grilles and bottom plate.

Do not touch them or put other equipment close to the air outlet grilles because they become hot during operation. The heated air outlet grilles and bottom plate may cause injury or damage to other equipment. Also, do not put the projector on a desk that is easily affected by heat.

Do not look into the air outlet grilles when projector is operating.

Heat, dust, etc. may blow out of them and hurt your eyes.

Do not block the air inlet and outlet grilles.

If they are blocked, heat may be generated inside the projector, causing deterioration in the projector quality and fire.

Place of installation

For safety's sake, do not use the projector at any place subjected to high temperature and high humidity. Please maintain an operating temperature, humidity, and altitude as specified below.

- Operating temperature: between +41°F (+5°C) and +95°F (+35°C)
- Operating humidity: between 30% and 90%
- Never put any heat-producing device under the projector to prevent the projector from being overheated.
- Do not install the projector at a place that is unstable or subject to vibration.
- Do not install the projector near any equipment that produces a strong magnetic field. Also refrain from installing the projector near any cable carrying a large amount of current.
- Place the projector on a solid, vibration-free surface. Otherwise it may fall, causing serious injury or damage.
- Do not stand the projector on its end. It may fall, causing serious injury or damage.
- Slanting the projector more than $\pm 10^\circ$ (right and left) or $\pm 15^\circ$ (front and rear) may cause trouble or explosion of the lamp.
- Do not place the projector near air-conditioning unit or heater to avoid the air outlet and inlet grilles from being exposed to hot air.
- Place the projector at least 50 cm (or 20 inch) away from the wall to prevent the air inlet grille and the air outlet grilles that emit hot air from being blocked.

COMPLIANCE NOTICE OF FCC

This equipment has been tested and found to comply with the limits for a Class B digital device, pursuant to Part 15 of the FCC Rules. These limits are designed to provide reasonable protection against harmful interference in a residential installation. This equipment generates, uses and can radiate radio frequency energy and, if not installed and used in accordance with the instructions, may cause harmful interference to radio communications. However, there is no guarantee that interference will not occur in a particular installation. If this equipment does cause harmful interference to radio or television reception, which can be determined by turning the equipment off and on, the user is encouraged to try to correct the interference by one or more of the following measures:

- Reorient or relocate the receiving antenna.
- Increase the separation between the equipment and receiver.
- Connect the equipment into an outlet on a circuit different from that to which the receiver is connected.
- Consult the dealer or an experienced Radio / TV technician for help.

Changes or modifications not expressly approved by Mitsubishi could void the user's authority to operate this equipment.

COMPLIANCE NOTICE OF INDUSTRY CANADA

This Class B digital apparatus complies with Canadian ICES-003.

Declaration of Conformity

Model Number :	SE2U
Trade Name :	MITSUBISHI ELECTRIC
Responsible party :	Mitsubishi Digital Electronics America, Inc. 9351 Jeronimo Road, Irvine, CA 92618 U.S.A
Telephone number :	+1-(949) 465-6000

This device complies with Part 15 of the FCC Rules. Operation is subject to the following two conditions:

- (1) this device may not cause harmful interference, and
- (2) this device must accept any interference received, including interference that may cause undesired operation.

Trademark, Registered trademark

Macintosh is registered trademark of Apple Computer Inc.

DLP™, Digital Micromirror Device and DMD are all trademarks of Texas Instruments.

Other brand or product names are trademarks or registered trademarks of their respective holders.

Introduction

Shipping Contents

The projector is shipped with the cables required for connection to a PC and to video equipment. Carefully unpack and verify that you have all of the items shown below. If any of these items are missing, please contact your place of purchase.



Projector



Soft Carry Case



Remote Control



Battery

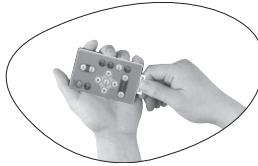

Important:

Pull the tab before using the remote control.



USB Cable



S-Video Cable



Video Cable



VGA Cable



Audio Cable



Power cord 120V



Power cord 230V

- User Manual CD
- Quick Start Up
- Safety Manual

Important:

The attached power cords are to be used exclusively for this product. Never use them for other products.

Projector Exterior View

Front / Upper Side

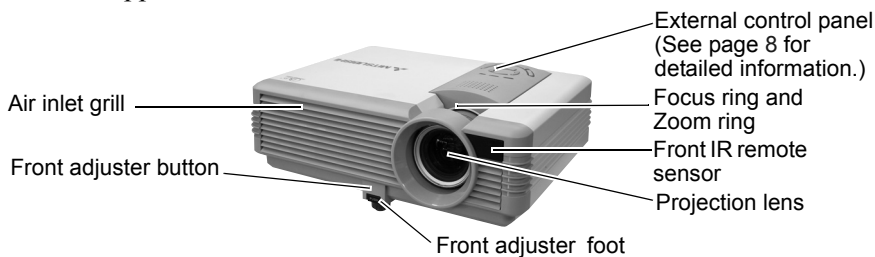

Rear Side



Bottom Side

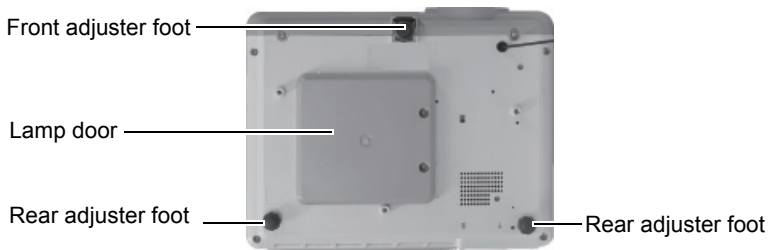

Connector Panel

Refer to page 11 for more information on making connections to various equipment.

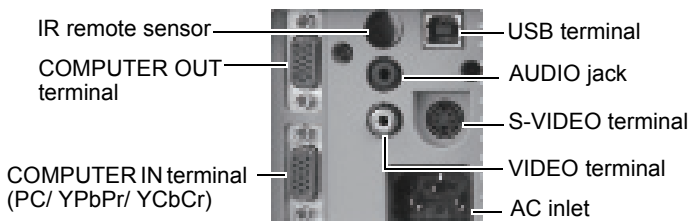

Controls and Functions

External Control Panel

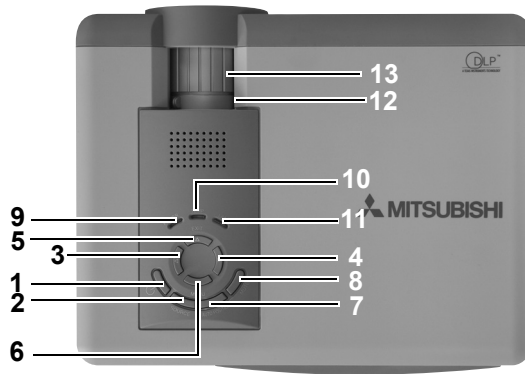

- 1. Power (Refer to pages 17 and 18 for more information.)**
Turns the projector on or off.
- 2. SOURCE (Refer to page 20 for more information.)**
Sequentially selects the input signal RGB/YpPr, Video or S-Video.
- 3. ◀ Left**
- 4. Right ▶**
When the on-screen menu is not activated, #3 and #4 function as **Keystone -/+** hot keys. (Refer to page 19 for more information.)
- 5. ▲ EXIT**
Exits and saves the menu settings.
- 6. ▼ MENU**
Turns the on-screen display control menu on. When the on-screen menu is activated, the #3 to #6 buttons are used as directional arrows to select the desired menu items and to make adjustments. Refer to page 24 for more information.
- 7. AUTO POSITION (Refer to page 20 for more information.)**
Automatically determines the best picture timings for the displayed image.
- 8. MUTE (Refer to page 21 for more information.)**
Used to hide the screen image and disable the audio. You can press **Mute** again to bring the image and audio back.
- 9. POWER indicator light**
Lights up or flashes when the projector is under operation.
- 10. TEMP (Temperature) warning light (Refer to page 34 for more information.)**
Flashes red if the projector's temperature becomes too high.
- 11. LAMP indicator light (Refer to page 32 for more information.)**
Indicates the status of the lamp. Lights up or flashes when the lamp has developed a problem.
- 12. Zoom ring**
Adjusts the size of the image. Rotate clockwise to enlarge the image or rotate counter-clockwise to make the image smaller.
- 13. Focus ring**
Adjusts the focus of the projected image.

Remote Control Description

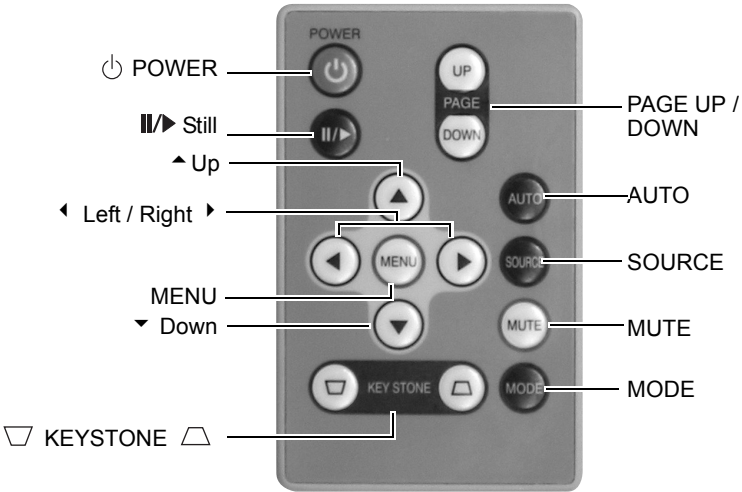

Functions	Descriptions
Power	Turns the projector on or off. Refer to pages 17 and 18 for more information.
Still	The image is frozen when Still is pressed. A "Pause" icon will appear in the lower right corner of the screen. To release the function, press Still again.
▲ Up, MENU ◀ Left / Right ▶, ▼ Down	Used to select the desired menu items and to make adjustments. Refer to page 24 for more information.
KEYSTONE	Manually corrects distorted images resulting from the angles of projection. Refer to page 19 for more information.
PAGE UP and DOWN	Connect the projector to your PC or notebook with a USB cable prior to using this function. You can operate your Power Point presentation moving forwards and backwards by pressing PAGE UP and PAGE DOWN .
AUTO	Automatically determines the best picture timings for displayed image. Refer to page 20 for more information.
SOURCE	Sequentially select the input signal RGB, Component Video, S-Video or Video. Refer to page 20 for information.
MUTE	In order to draw the audience's full attention to the presenter, you can use MUTE to hide the screen image and disable the audio. Press MUTE again to restore the image and audio. Refer to page 21 for more information.

MODE	According to the selected input signal, there are several picture setup options available: Presentation mode, Video mode, Cinema mode and Lamp Low mode. Refer to page 25 for more information.
------	---

Remote Control Effective Range

Infra Red (IR) remote control sensors are located on the front and the back of the projector. The remote control must be held at an angle within 30 degrees of the projector's IR remote control sensors to function correctly. The distance between the remote control and the sensors should not exceed 6 meters (19.5 feet).

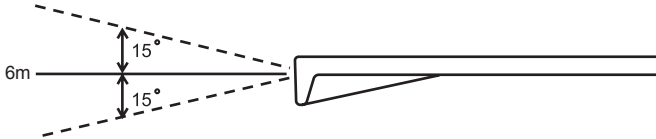

Important:

Notes on Remote Control Operation:

Make sure that there are no obstacles between the remote control and the IR sensors on the projector that might obstruct the infra-red beam.

Installing or Replacing the Battery

1. Pull out the battery holder while sliding the lock in the direction of the arrow using a pointed stick such as a ball point pen.
2. Insert the new battery in the holder.
3. Push the holder into the remote control.

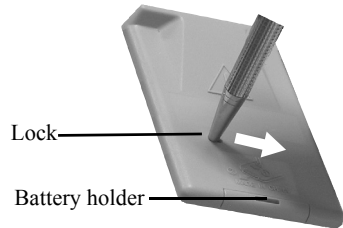

- Use of a battery of wrong type may cause explosion. Use type CR2025 only.
- Dispose of used batteries according to your local regulations.
- Batteries may explode if misused. Do not recharge, disassemble, or dispose of in fire.
- Be sure to handle the battery according to the instructions.
- Load the battery with its positive (+) and negative (-) sides correctly oriented as indicated on the remote control.
- Keep batteries out of reach of children and pets.
- Remove the battery, if the remote control is not used for a long time.

Connection

When connecting a signal source to the projector, be sure to:

1. Turn all equipment off before making any connections.
2. Use the correct signal cables for each source.
3. Ensure the cables are firmly inserted.

Connecting to a Laptop or Desktop Computer

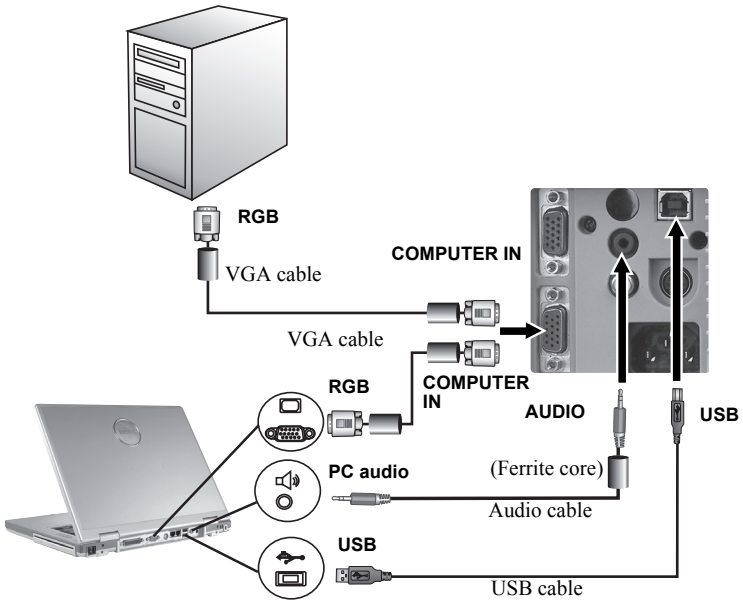

Important:

A Mac adapter is needed if you are connecting to Macintosh computers.

Connecting Equipment to the Component Video Input

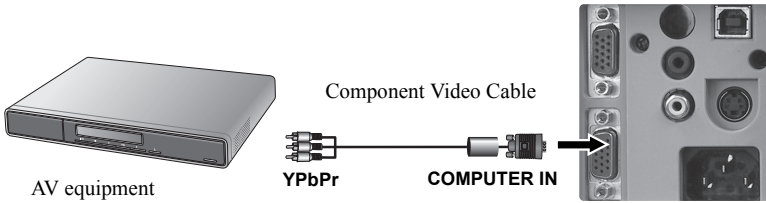

The projector is capable of displaying various High Definition TV display modes. Some of these sources are:

- Digital-VHS (D-VHS) recorder
- DVD player
- Satellite Dish HDTV receiver
- Digital TV tuners

Most of these sources will provide an analog component video output, a standard VGA output, or a YPbPr format.

The projector is capable of accepting HDTV data through a Component Video connector. Use a Component Video cable to display these images.

The following standards are supported in the HDTV function:

- 480i
- 480p
- 576i
- 576p
- 720p (50/ 60 Hz)
- 1080i (50/ 60 Hz)

Connecting Video and S-Video Devices

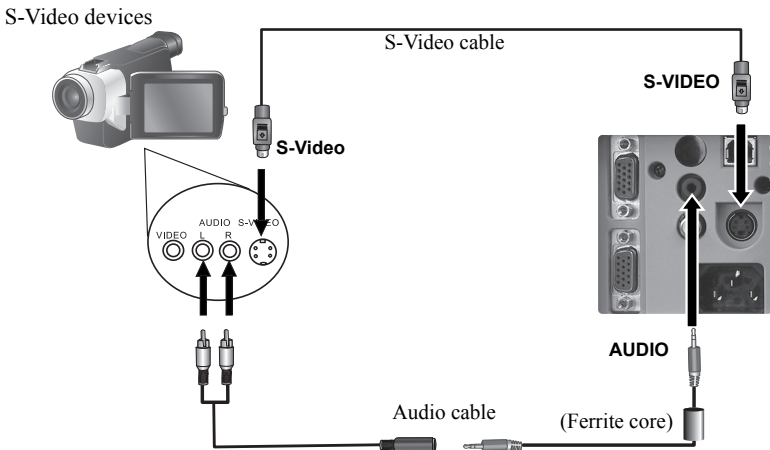

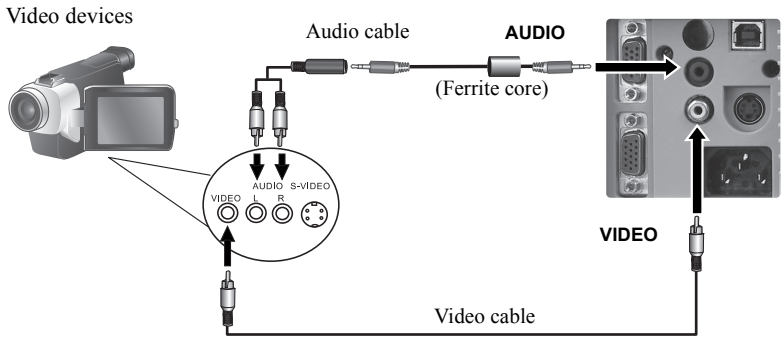

Important:

If the selected video image is not displayed after the projector is turned on and the correct video source has been selected, check that the video source is turned on and operating correctly. Also check that the signal cables have been connected correctly.

Connecting to Display Devices

If you want to monitor your presentation close-up on a monitor as well as on the screen, you can connect the COMPUTER output port on the projector to an external monitor with a VGA cable.

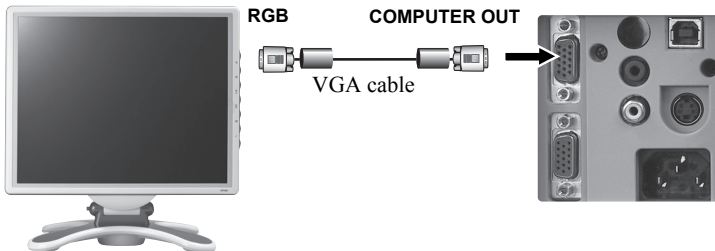

Installation

Choosing a Location

Your projector is designed to be installed in the four installation configurations shown here: Floor front, Ceiling front, Floor rear, Ceiling rear. Your room layout or personal preference will dictate which installation configuration you use.

I. Floor front

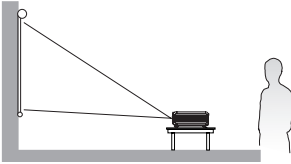

II. Ceiling front

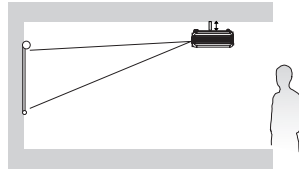

III. Floor rear

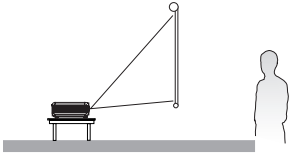

IV. Ceiling rear

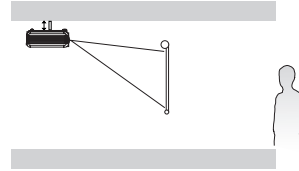

For further information on the four configurations, please refer to page 28.

If you place the projector above or below the screen, you have to tilt it down or up to center the image on the screen, in these situations image distortion will occur. Use the Keystone function to correct the distortion. See page 19 for keystone correction.

Adjusting the Height

The projector is equipped with 1 quick-release adjuster foot and 2 rear adjuster feet. These adjusters change the image height and projection angle. To adjust the projector,

1. Lift the projector up and press the adjuster button to release the adjuster. The adjuster will drop into position and be locked. It can lift the projector by up to 15 degrees.
2. Screw the rear adjuster feet to fine tune the horizontal angle.

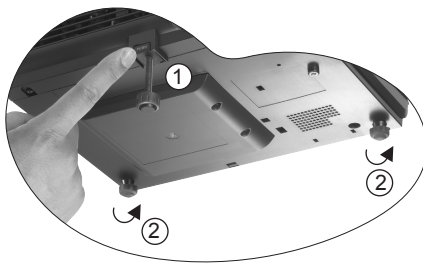

Press the adjuster button again to retract the foot.

Important:

If the screen and the projector are not perpendicular to each other, the projected image becomes vertically trapezoidal. To correct this situation, adjust the value of Keystone in the Picture menu, on the projector control panel or on the remote control.

Screen Size

Place the projector at the required distance from the screen according to the required picture size (see the table on the next page).

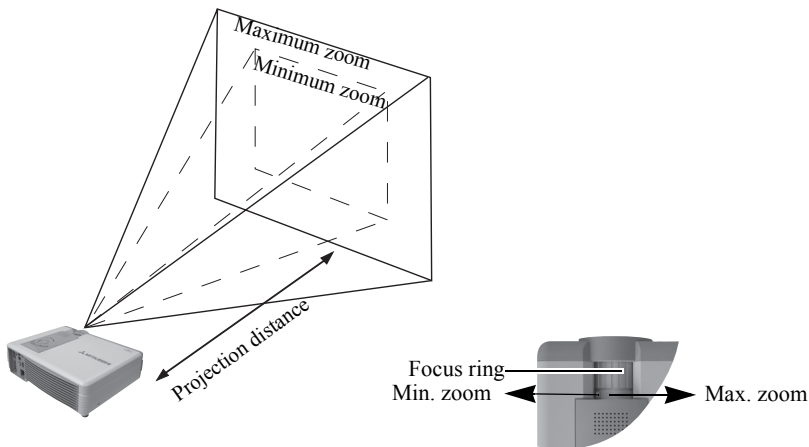

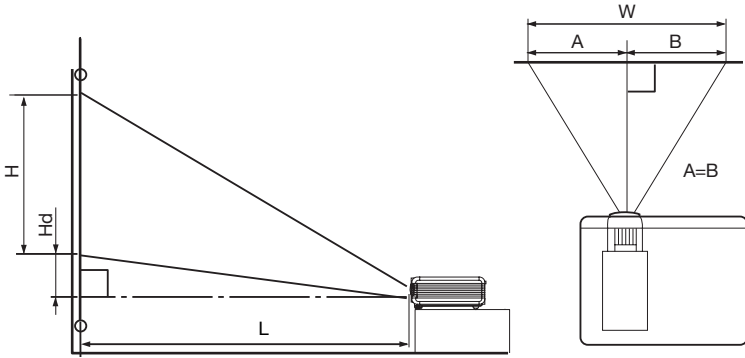

Screen size chart (4:3 aspect ratio)

Screen						Distance from screen (L)				Height projected image(Hd)	
Diagonal size		Width (W)		Height (H)		Minimum zoom		Maximum zoom		Height projected image(Hd)	
inch	cm	inch	cm	inch	cm	inch	m	inch	m	inch	cm
40	102	32	81	24	61	52	1.3	65	1.6	3.98	10.1
60	152	48	122	36	91	79	2.0	97	2.5	5.94	15.1
80	203	64	163	48	122	105	2.7	129	3.3	7.91	20.1
100	254	80	203	60	152	131	3.3	161	4.1	9.88	25.1
150	381	120	305	90	229	197	5.0	242	6.2	14.8	37.7
180	457	144	366	108	274	236	6.0	290	7.4	17.8	45.3

Screen size chart (16:9 aspect ratio)

Screen						Distance from screen (L)				Height projected image(Hd)	
Diagonal size		Width (W)		Height (H)		Minimum zoom		Maximum zoom		Height projected image(Hd)	
inch	cm	inch	cm	inch	cm	inch	m	inch	m	inch	cm
40	102	35	89	20	50	58	1.5	71	1.8	7.56	19.2
60	152	52	133	29	75	86	2.2	106	2.7	11.3	28.8
80	203	70	177	39	100	115	2.9	141	3.6	15.1	38.4
100	254	87	221	49	125	144	3.7	177	4.5	18.9	47.9
150	381	131	332	74	187	216	5.5	265	6.7	28.3	71.9
180	457	157	398	88	224	259	6.6	315	8.1	34.0	86.3

Important:

The above numbers are approximate, and may be slightly different from the actual measurements.

Operation

Start Up

1. Switch all of the connected equipment on.
2. Plug the power cord into the projector and into a wall socket.

Ex.

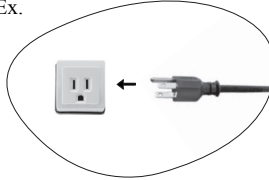

- The provided power cord 120V is rated at 120 V. Never connect this cord to any outlet or power supply using other voltages or frequencies than rated. If you want to use a power supply using other voltage than rated, prepare an appropriate power cord separately.
3. Turn on the wall socket switch (where fitted).
 4. Press and hold **Power** on the remote control or projector to start the unit. The **Power indicator light** flashes green and stays green when the power is turned on.

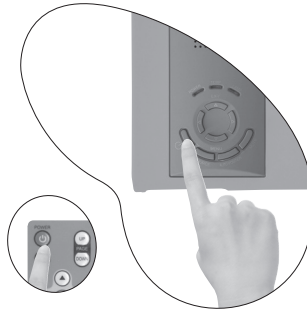

5. The start up procedure takes about 30 seconds after pressing **Power**. In the later stage of start up, a splash screen appears.
6. Then, the projector starts to search for input signals. Irrespective of selected input source, the screen shows the selected source information at the bottom right corner of the screen. If there is no input source detected, the three messages will be displayed on the screen continuously: “**RGB/YpBPr Searching**”, “**Video Searching**” and “**S-Video Searching**”.
7. You can also press **SOURCE** on the projector or remote control to select your desired input signal. For more information, please refer to page 20.

Important:

If the frequency/ resolution of the input signal exceeds the projector’s operating range, you will see the message “Out of Range” displayed on a blank screen.

Shutdown

1. Press **Power** and a warning message appears. Press **Power** a second time to turn the projector off.
2. The **Power indicator light** flashes orange and the lamp shuts down, the fans continue to run for approximately 110 seconds to cool down the projector.

 To protect the lamp, the projector will not respond to any commands during the cooling process.

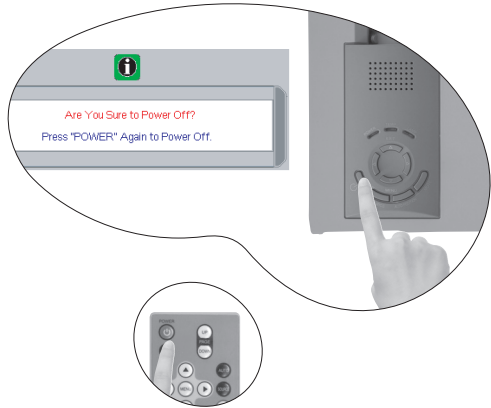

3. Disconnect the power cord from the wall socket.

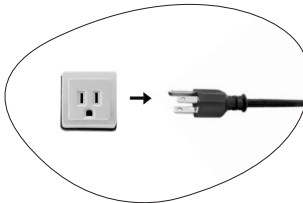

 Do not unplug the power cord before the projector shutdown sequence is complete or during the 110-second cooling down process. If the projector is not properly shut down, to protect the lamp, when you attempt to re-start the projector within a few minutes, the fans will run for a few minutes to cool down. Press Power again to start the projector after the fans stop.

Digital Keystone Correction

Keystoning refers to the situation where the projected image is noticeably wider at either the top or bottom. It occurs when the projector is not perpendicular to the screen.

To correct this, besides adjusting the height of the projector, you will need to manually correct it following ONE of these steps.

1. Press ◀ **Left/Right** ▶ (hot key) on the control panel of the projector to display the status bar labelled Keystone. Press ◀ **Left** to correct keystoning at the top of the image. Press **Right** ▶ to correct keystoning at the bottom of the image.

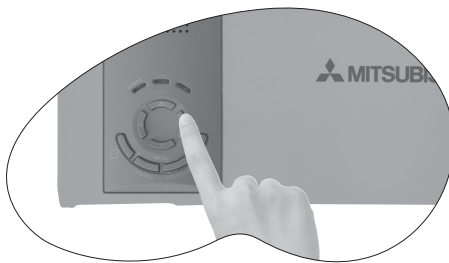

2. Press ▽ / ▴ on the remote control to display the status bar

labelled Keystone, then press ▽ to correct keystoning at the top of

the image or press ▴ to correct keystoning at the bottom of the image.

3. Press ▼ **Menu** on the projector or **MENU** on the remote control. Go to  **Picture** --> **Keystone** and adjust the values by pressing ◀ **Left/Right** ▶ on the projector or ◀ / ▶ on the remote control.

For example:



Keystone  0

1. Press ◀ **Left** on the projector or

2. Press ▽ on the remote control or

3. Press ◀ **Left** on the projector or ◀ on the remote control when you are in **Picture --> Keystone** menu.



Keystone  -6



Keystone  0

1. Press **Right** ▶ on the projector or

2. Press ▴ on the remote control or

3. Press **Right** ▶ on the projector or ▶ on the remote control when you are in **Picture --> Keystone** menu.



Keystone  6

Source Selection

To sequentially select input sources, press **SOURCE** on the projector control panel or the remote control. It may take you a few seconds when the projector is searching for input signals. The selected source will be displayed at the bottom right of the screen for 3 seconds. For a quick search, you can also press the key repeatedly until your desired signal is displayed.



Auto Adjustment

In some cases, you may need to optimize the picture quality. To do this, press **AUTO POSITION** on the control panel of the projector or **AUTO** on the remote control. Within 3 seconds, the built-in Intelligent Auto Adjustment function will re-adjust the values of Frequency and Clock to provide the best picture quality.

The current source information will be displayed at the bottom right of the screen for 3 seconds, as below.

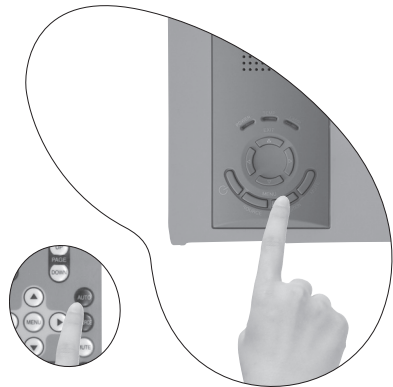
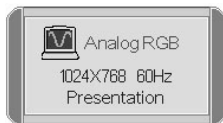

Important:

- The screen will be blank while Auto is functioning.
- You can use Auto Adjustment function when only source is Analog RGB.

Mute

In order to draw the audience's full attention to the presenter, you can use **MUTE** to hide the screen image and disable the audio. Press **MUTE** again to restore the image and audio.

You can set the mute time in 

Advance --> Mute Time menu to restore the image and audio automatically after a period of time when there is no action taken on the mute screen.

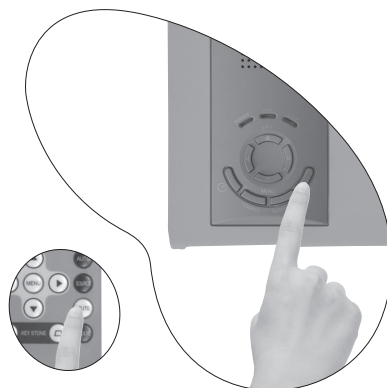

Zoom / Focusing

Adjust the projected image to your desired size using the lens' zoom ring. Then focus the image by rotating the focus ring. Refer to the screen size tables on page 16.

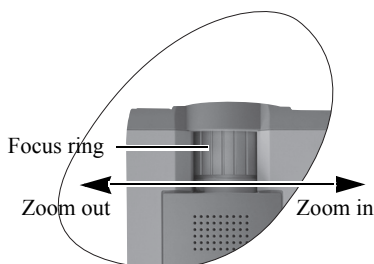

Slide Operation

You can control the computer to page-up and page-down the presentation data using the remote control. Switch the pages using the **PAGE UP** or **PAGE DOWN** button on the remote control.

Important:

- Connect the projector to your PC or notebook with a USB cable prior to using this function.
- Only the computers equipped with a USB port are supported.
- Wait for the lamp to light up before connecting the USB cable.

Remote control



Still

The image is frozen when **Still** is pressed. An icon  will appear in the lower right corner of the screen. To release the function, press any button except **▲ Up**, **◀ Left / Right ▶**, **▼ Down** buttons.

Remote control



Mode Selection

Press **MODE** to select a operation mode that suits your need. There are several operation modes available for different types of signals.

Presentation

Video

Cinema

Lamp Low

Remote control

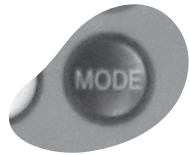





Refer to page 25 for more information.

Menu Operation

Menu System

Please note that the menus vary according to the signal type selected.

Functions available when receiving different signal types...		
Sub-Menu	PC	Video / S-Video / Component Video
 Picture	Mode Keystone Brightness Contrast	Mode Keystone Brightness Contrast Color Tint
 Pro-Picture	Auto Resize Aspect Ratio H Position V Position Fine Sync. Tracking	Auto Resize Aspect Ratio Sharpness
 Setting	Audio Mute Volume OSD Time Reset Color Temp	
 Advance	Mirror Mute Time Source Scan Language Splash Screen	
 Information	Source Resolution Mode Lamp Hour	Source System Mode Lamp Hour

Using the Menus

The projector is equipped with on-screen display (OSD) menus for making various adjustments and settings.

There are 8 different menu languages. **(Refer to page 29 for more details.)**

The following example describes the adjustment of the keystone.

1. Press **▼ MENU** on the projector or **MENU** on the remote control to turn the on-screen menu on.
4. Adjust keystone values by pressing **◀ Left / Right ▶** on the projector or **◀ / ▶** on the remote control.

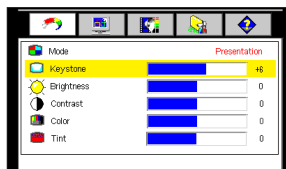
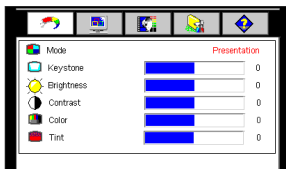



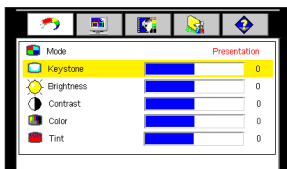



2. Use **◀ Left/ Right ▶** on the projector or **◀ / ▶** on the remote control to select  **Picture** menu.
3. Use **▲ EXIT** or **▼ MENU** on the projector or **▼ / ▲** on the remote control to select **Keystone**.
5. Press **▲ EXIT *** on the projector or press **MENU** on the remote control to leave and save the setting.



***The first press leads you back to the submenu and the second press closes the on-screen menu.**

1. Picture Menu

PC signal input



FUNCTION	DESCRIPTION
Mode	<p>Preset modes are provided so you can optimize your projector image set-up to suit your program type.</p> <ol style="list-style-type: none"> Presentation: Is designed for presentations. The brightness is emphasized in this mode. Video: With a higher color temperature, it is suitable for enjoying TV movies. Cinema: With a lower color temperature, it is suitable for enjoying cinematic movies. Lamp Low: Use this mode to reduce system noise and reduce power consumption by 20%. The lamp life is also extended with lower light output.
Keystone	<p>Corrects any keystoneing of the image. Refer to page 19 for more information.</p>
Brightness	<p>Adjusts the brightness of the image. The higher the value, the brighter the image. And lower the setting, darker the image. Adjust this control so the black areas of the image appear just as black and that detail in the dark areas is visible.</p> <div style="display: flex; justify-content: space-around; align-items: flex-end;"> <div style="text-align: center;">  <p>30</p> </div> <div style="text-align: center;">  <p>50</p> </div> <div style="text-align: center;">  <p>70</p> </div> </div>
Contrast	<p>Adjusts the degree of difference between dark and light in the image. The higher the value, the greater the contrast.</p> <div style="display: flex; justify-content: space-around; align-items: flex-end;"> <div style="text-align: center;">  <p>30</p> </div> <div style="text-align: center;">  <p>50</p> </div> <div style="text-align: center;">  <p>70</p> </div> </div>

Video/ S-Video/ Component Video signal input

FUNCTION	DESCRIPTION
Mode	As described in the previous table.
Keystone	As described in the previous table.
Brightness	As described in the previous table.
Contrast	As described in the previous table.
Color	Increases or decreases the color intensity of the image.
Tint	Adjusts the color tones of the image. The higher the value, the more reddish the image becomes. The lower the value, the more greenish the image becomes. (Available only when the source is Video or S-Video, and the input signal is NTSC format.)

2. Pro-Picture Menu

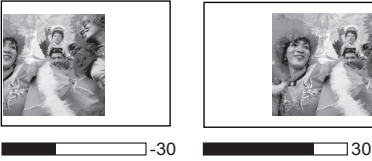

PC signal input

FUNCTION	DESCRIPTION
Auto Resize	Makes the best fit of the image to the screen. 1. On 2. Off
Aspect Ratio	There are two aspect ratio settings. 1. 4 : 3 (Standard) 2. 16 : 9 (Wide Screen)
H Position	Adjusts the horizontal position of the projected image. 
V Position	Adjusts the vertical position of the projected image. 
Fine Sync.	This function allows you to adjust the clock phase to reduce image distortion. 
Tracking	Adjusts the horizontal width of the image.

Video/ S-Video/ Component Video signal input

FUNCTION	DESCRIPTION
Auto Resize	As described in the previous table.
Aspect Ratio	As described in the previous table.
Sharpness	Adjusts the image to make it look sharper or softer.





3. Setting Menu

FUNCTION	DESCRIPTION
Audio Mute	Disable the audio. On Off  
Volume	Adjusts the volume level. 
OSD Time	Sets the length of time the OSD (On Screen Display) menu will remain active after your last button press. The range is from 5 to 85 seconds.
Reset	Returns settings to the factory preset values. (With exceptions.)
Color Temp	3 color temperature* settings are available. 1. Standard: Maintains normal colorings for white. 2. High: Makes images appear bluish white. 3. Low: Makes images appear reddish white.

***About color temperatures:**

There are many different shades that are considered to be “white” for various purposes. One of the common methods of representing white color is known as the “color temperature”. A white color with a low color temperature appears to be reddish white. A white color with a high color temperature appears to have more blue in it.

4. Advance Menu

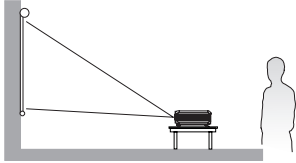
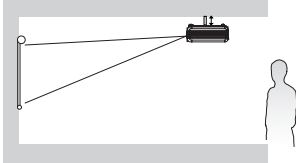
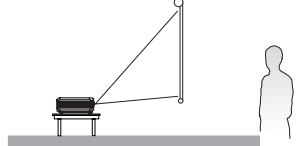
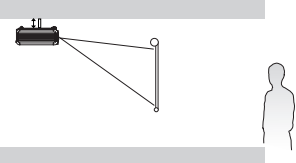
FUNCTION	DESCRIPTION
<p>Mirror</p>	<p>The projector can be installed on a ceiling or behind a screen, or with one or more mirrors. Contact your dealer for the ceiling mount bracket (optional accessory) if you need to install the projector on your ceiling.</p> <ul style="list-style-type: none"> •  Floor front: Select this setting with the projector set on the floor and audience viewing the projected images from the front side of the screen. This is the most common setting. •  Ceiling front: Select this setting with the projector suspended from the ceiling and audience viewing the projected images from the front side. •  Floor rear: Select this setting when the projector is placed near the floor and behind the screen. A special rear projection screen is required. •  Ceiling rear: Select this setting when the projector is suspended from the ceiling and placed behind the screen. A special rear projection screen is required.    
<p>Mute Time</p>	<p>Determines the length of time before the image and audio will automatically resume when Mute is activated. When 0 is chosen, the image and audio will not resume automatically.</p>
<p>Source Scan</p>	<p>Sets whether the projector searches automatically for input signals. If the source scan is on, the projector will scan for input signals in the following order: RGB/YpBPr --> Video --> S-Video until it acquires a signal. If the function is not activated, the projector selects the last input signal.</p>
<p>Language</p>	<p>Language sets the language for the OSD control menus.</p> <p>Use ◀ Left/ Right ▶ on the projector or ◀ / ▶ on the remote control to select your desired language from among English, French, German, Italian, Spanish, Simplified Chinese, Portugues and Japanese.</p>
<p>Splash Screen</p>	<p>Enables the user to select which screen will appear during projector start-up. Three modes are available: Default, black screen or blue screen.</p>

5. Information Menu

This menu shows you the current operating status of the projector.

PC signal input/ Component Video signal input

FUNCTION	DESCRIPTION
Source	Shows the current signal source.
Resolution	Shows the native resolution of the input signal.
Mode	Shows the selected mode in  Picture menu.
Lamp Hour	Displays the number of hours the lamp has been used.

Video/ S-Video signal input

FUNCTION	DESCRIPTION
Source	As described in the previous table.
System	Shows the Video input system format, NTSC, NTSC443, SECAM, PAL, PALN, PALM or PAL60.
Mode	As described in the previous table.
Lamp Hour	As described in the previous table.

Maintenance

Cleaning the Lens

Clean the lens whenever you notice dirt or dust on the surface.

- Use a canister of compressed air to remove dust.
- If there is dirt or smears, use lens-cleaning paper or moisten a soft cloth with lens cleaner to gently wipe the lens surface.

Important:

Never rub the lens with abrasive materials.

Cleaning the Projector Case

Before you clean the case, turn the projector off and unplug the power cord.

- To remove dirt or dust, wipe the case with a soft, dry, lint-free cloth.
- To remove stubborn dirt or stains, moisten a soft cloth with water and a neutral detergent. Then wipe the case.

Important:

Never use wax, alcohol, benzene, thinner or other chemical detergents. These can damage the case.

Storing the Projector

If you need to store the projector for an extended time, please follow the instructions below.

- Make sure the temperature and humidity of the storage area are within the recommended range for the projector. Please refer to the Spec. page in the manual or consult your dealer about the range.
- Retract the adjuster feet.
- Remove the batteries from the remote control.
- Pack the projector in its original packing or equivalent.

Transporting the projector

It is recommended that you ship the projector with its original packing or equivalent. When you carry the projector yourself, please use the provided soft carry case.

Lamp Information

Warning Message

When the **Lamp indicator** lights up red or a message appears suggesting it is time to replace the lamp, please install a new lamp or consult your dealer. An old lamp may cause a malfunction in the projector and in some instances the lamp may break.

For more detailed information on lamp warnings, please refer to page 35.



- The Lamp indicator light and Temperature warning light will light up if the lamp becomes too hot. Turn the power off and let the projector cool for 45 minutes. If the Lamp or Temp indicator still lights up after turning the power back on, please contact your dealer.
- Do not remove the lamp immediately after using the projector. You may get burned because the lamp is very hot after use.
- Before replacing the lamp, press the POWER button to turn off the lamp and wait for two minutes for the lamp to cool down. Unplug the power cord from the wall outlet and wait one hour for the lamp to cool down completely.
- Do not remove the lamp except for replacement. Careless handling can cause injury or fire.
- Do not touch the lamp directly. It may break and cause injury or burn.
- Be sure not to drop the lamp lid screw into the projector. Also be sure not to put metal or any flammable objects inside because it may cause fire or electric shock. If any objects should fall inside, unplug and contact your dealer.
- Install the lamp securely to prevent failure and fire.
- If the lamp should break, small glass fragments may fall out through the grilles and some may remain inside of the projector or the lamp box. When taking the lamp box out, be sure to turn over the projector and hold the handle of the lamp box to avoid injury due to the glass fragments.
- If the lamp should break, never shake the lamp box or hold it in front of your face after removing it. The glass fragments may fall out and cause injury to your eyes.
- When placing the projector upside down to replace the lamp or conduct maintenance, ensure that the projector is securely placed before working with it.
- The lamp is fragile. If it is broken, be careful not to cut yourself with glass fragments.
- Contact your dealer for a new lamp.

Interval of lamp replacement

The recommended interval of lamp replacement is about 2000 hours^{*1} of consecutive use. Such interval differs depending on the operating environment and may be shorter than 2000 hours^{*1}. Decrease in luminescence and/or color brightness indicates that the lamp needs to be replaced. When the lamp operation time exceeds 1500 hours^{*1}, the lamp replacement message will appear on the screen for 30 seconds^{*3} every time the lamp is turned on. When the lamp has been used for about 2000 hours^{*1,*2}, the replacement message will flash in the center of the screen for 30 seconds^{*3}. (In such cases, the LAMP indicator lighting up red.) The projector will shutdown after one minute.

*1 When Mode of the Picture menu is not set to Lamp Low mode continuously. When it is set to Lamp Low mode, this duration will be extended.

*2 When Mode is set to Lamp Low mode, this duration will be extended to 2500 hours.

*3 The projector will not respond to any operations.

Replacing the Lamp



- To reduce the risk of electrical shock, always turn the projector off and disconnect the power cord before changing the lamp.
- To reduce the risk of severe burns, allow the projector to cool for at least 45 minutes before replacing the lamp.
- To reduce the risk of injuries to fingers and damage to internal components, use caution when removing lamp glass that has shattered into sharp pieces.
- To reduce the risk of injuries to fingers and/or compromising image quality by touching the lens, do not touch the empty lamp compartment when the lamp is removed.
- This projector uses a lamp that contains mercury. Disposal of the lamp or the projector with the lamp may be regulated due to environmental considerations. For disposal or recycling information, please contact your local authorities or the Electronic Industries Alliance: www.eiae.org. (For US only).

Step 1. Turn the power off and disconnect the projector from the wall socket.

Step 2. Turn the projector over. Then loosen the screws and remove the lamp cover. If the lamp is hot, avoid burns by waiting for 45 minutes until the lamp has cooled.

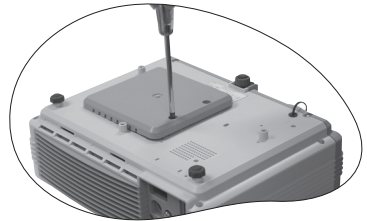

Step 3. Loosen the screw that holds the lamp to the projector. If the screw is not loosened completely, they could injure your fingers. It is strongly recommended that you use a magnetic-head screwdriver.

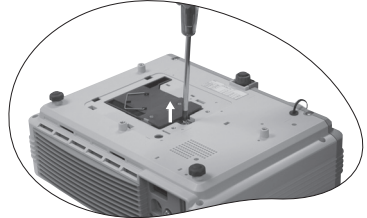

Step 4. Lift the handle so that it stands up. Use the handle to slowly pull the lamp out of the projector.

Important:

- Pulling it too quickly may cause the lamp to break and scatter broken glass in the projector.
- Do not place the lamp in locations where water might splash on it, children can reach it, or near flammable materials.
- Do not insert your hands into the projector after the lamp is removed. If you touch the optical components inside, it could cause color unevenness and distortion of the projected images.

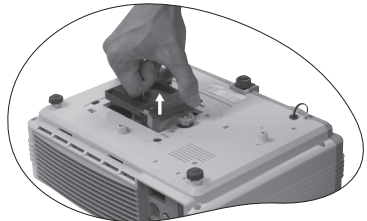

Step 5. Insert a new lamp. Make sure the handle is fully locked and tighten the screw firmly.

Important:

- Loose screw may cause a bad connection, which could result in malfunction.
- Do not over tighten the screw.

Step 6. Re-install the lamp cover and tighten the screw. **Do not turn the power on with the lamp cover removed.** Whenever the lamp is replaced, reset the total lamp operation time. **Do not reset if the lamp is not replaced as this could cause damage.**

Resetting the lamp counter

If replacing the lamp after 2000 hours of operation, please carry out the following operation within one minute of powering on. (When the replacement message appears, the projector will not respond to any operations.)

- i. Press and hold the Exit \blacktriangle button on the projector for 5 seconds to display the total used lamp time.
- ii. Press **AUTO POSITION** on the projector or **AUTO** on the remote control to reset the lamp hour to “0”.
- iii. Wait about 5 seconds to let the OSD disappear.



Temp Information



When the Temperature warning light is on, it is warning you of the following possible problems:





1. The internal temperature is too high.
2. The fans are not working.

Turn the projector off and contact qualified service personnel for further help.

Indicators

Illustration

1. **Blank -** : Light OFF
2.  : Light flashing
3.  : Light ON
4. **O** : Orange light
5. **R** : Red light
6. **G** : Green light

Light			Status & Description
Power	Temp	Lamp	
Power events			
	-	-	(1) The projector needs 110 seconds to cool down as it was abnormally shut down without the normal cooling down process. Or (2) The projector needs to cool for 110 seconds after the power is turned off.
	-	-	Stand-by mode.
	-	-	The Power indicator light is flashing during powering up.
	-	-	The projector is under normal operation.

Light			Status & Description
Power	Temp	Lamp	
Lamp events			
-	-	R	(1) The projector needs 110 seconds to cool down. Or (2) Please contact your dealer for assistance.
Thermal events			
-	R	-	The projector has shutdown automatically. If you try to re-start the projector, it will shutdown again. Please contact your dealer for assistance.
-	R	G	The projector has shutdown automatically. If you try to re-start the projector, it will shutdown again. Please contact your dealer for assistance.
-	R	O	The projector has shutdown automatically. If you try to re-start the projector, it will shutdown again. Please contact your dealer for assistance.
O	R	-	The projector has shutdown automatically. If you try to re-start the projector, it will shutdown again. Please contact your dealer for assistance.
G	R	-	The projector has shutdown automatically. If you try to re-start the projector, it will shutdown again. Please contact your dealer for assistance.

Service Information

Accessories (included in the standard package)

Description	Part Number
Power cord (US)	27.01818.000
Power cord (EU)	27.82718.281
VGA cable	50.J0508.503
Video cable	50.J1303.501
S-Video cable	50.72920.011
RCA R/W audio cable	50.J1311.001
PC - PC audio cable	50.L4302.501
Soft carry case	47.J9904.001
USB mouse cable	50.73213.501
Remote control	56.26J0G.001
User Manual (CD)	53.J0G01.001
Safety Manual	46.J0G02.001
Quick Start Up	49.J0G02.001

Optional Accessories (not included in the standard package)

Description of parts	Part number
Spare lamp (VLT-SE2LP)	59.J9901.CG1

Ordering Parts or Getting Information

For product information, product assistance, service information, or to order accessories, please contact your dealer.

Troubleshooting

⑦ THE PROJECTOR DOES NOT TURN ON.

Cause	Remedy
There is no power from the power cable.	Plug the power cord into the AC inlet on the projector, and plug the power cord into the power outlet. If the power outlet has a switch, make sure that it is switched on.
Attempting to turn the projector on again during the cooling process.	Wait until the cooling down process has completed.

⑦ NO PICTURE

Cause	Remedy
The video source is not turned on or connected correctly.	Turn the video source on and check that the signal cable is connected correctly.
The projector is not correctly connected to the input source device.	Check the connection.
The input signal has not been correctly selected.	Select the correct input signal with the Source key on the projector or remote control.
The lens cap is still attached to the lens.	Remove the lens cap.

⑦ BLURRED IMAGE

Cause	Remedy
The projection lens is not correctly focused.	Adjust the focus of the lens using the focus ring.
The projector and the screen are not aligned properly.	Adjust the projection angle and direction as well as the height of the unit if necessary.
The lens cap is still attached to the lens	Remove the lens cap.

⑦ REMOTE CONTROL DOES NOT WORK

Cause	Remedy
The battery is out of power.	Replace the battery with a new one.
There is an obstacle between the remote control and the projector.	Remove the obstacle.
You are too far away from the projector.	Stand within 6 meters (19.5 feet) of the projector.

Specifications

Projector Specifications

Important:

All specifications are subject to change without notice.

General

Product name	DLP™ Projector
Model name	SE2U

Optical

Display Technology	0.55" Single chip Digital Micromirror Device (DMD)
Lens F/Number	F=2.6 to 3.1
Lamp	200W lamp

Electrical

Power supply	AC100 - 240V, 3.2A, 50/60 Hz (Automatic)
--------------	--

Mechanical

Dimensions	283 mm (W) x 107 mm (H) x 229 mm (D)
Operating temperature range	5°C - 35°C
Weight	2.9 Kg

Input terminal

Computer input	
RGB input	D-sub 15-pin (female)
Video signal input	
S-VIDEO	4-pin port x1
VIDEO	RCA jack x1
Component Video signal input	D-sub 15-pin (female) (Used also for RGB input)
Audio signal input	
Audio in	Mini jack stereo port

Output

Computer output	
RGB output	D-sub 15-pin (female)
USB mouse connector	B-type x1
Speaker	1 watt x 1

Timing Chart

Supported Timing for PC Input

Resolution	Horizontal Frequency (kHz)	Vertical Frequency (Hz)	Pixel Frequency (MHz)	Mode
720x400	37.927	85.039	35.500	720x400_85
640x480	31.469	59.940	25.175	VGA_60
	37.861	72.809	31.500	VGA_72
	37.500	75.000	31.500	VGA_75
	43.269	85.008	36.000	VGA_85
800x600	37.879	60.317	40.000	SVGA_60
	48.077	72.188	50.000	SVGA_72
	46.875	75.000	49.500	SVGA_75
	53.674	85.061	56.250	SVGA_85
1024x768	48.363	60.004	65.000	XGA_60
	56.476	70.069	75.000	XGA_70
	60.023	75.029	78.750	XGA_75
	68.667	84.997	94.500	XGA_85
1280x1024	63.981	60.020	108.000	SXGA3_60

Supported Timing for Component Video-YPbPr Input

Signal Format	Horizontal Frequency (kHz)	Vertical Frequency (Hz)
480i(525i)@60Hz	15.73	59.94
480p(525p)@60Hz	31.47	59.94
576i(625i)@50Hz	15.63	50.00
576p(625p)@50Hz	31.25	50.00
720p(750p)@60Hz	45.00	60.00
720p(750p)@50Hz	37.50	50.00
1080i(1125i)@60Hz	33.75	60.00
1080i(1125i)@50Hz	28.13	50.00

Supported Timing for Video and S-Video Inputs

Video mode	Horizontal Frequency (kHz)	Vertical Frequency (Hz)	Color sub-carrier Frequency (MHz)
NTSC	15.73	60	3.58
PAL	15.63	50	4.43
SECAM	15.63	50	4.25 or 4.41
PAL-M	15.73	60	3.58
PAL-N	15.63	50	3.58
PAL-60	15.73	60	4.43
NTSC4.43	15.73	60	4.43

- Some computers aren't compatible with the projector.
- The projector's maximum resolution is 800 x 600 pixels. It may not display images of higher resolutions than 800 x 600 correctly.
- Images with SYNC on G (Green) signal may jitter.
- Images with SYNC on G (Green) signal may be tinged with green.
- If the resolution and frequency of your computer aren't shown on the table, find the compatible resolution and frequency by changing the resolution of your computer.

Dimensions

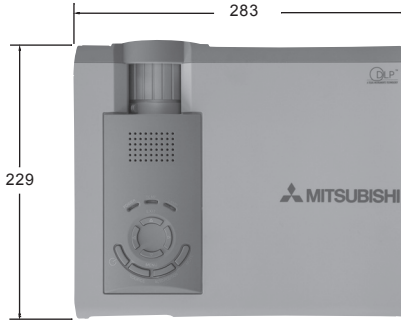

Unit: mm

MITSUBISHI Projector Contact Information

North America

MESCA (Mitsubishi Electric Sales Canada Inc.)
<http://www.mitsubishielectric.ca>
Information Technologies Group, 4299 14th Avenue, Markham, Ontario
L3R 0J2, Canada

Sales Phone :+1-(905) 475-7728
Fax :+1-(905) 475-7958
E-mail :projectors@mitsubishielectric.ca
Technical Phone :+1-(905) 475-7728
Fax :+1-(905) 475-7958

Customer Care E-mail :support@mitsubishielectric.ca

MDEA (Mitsubishi Digital Electronics America, Inc.)
(Warranty Registration)
<http://www.mitsubishi-presentations.com/>
Presentation Products Division, 9351 Jeronimo Road, Irvine, CA 92618
U.S.A.

Phone Main Line :+1-(949) 465-6000
Technical :+1-(888) 307-0309
Product Information :+1-(888) 307-0312

Technical Support E-mail :tsupport@mdea.me.com

Europe

MEU-FRA (Mitsubishi Electric Europe B.V. French Branch)
25, Boulevard des Bouvets 92 741, Nanterre CEDEX, France

Phone :+33 (0)1 55-68-55-07
Fax :+33 (0)1 55-68-57-31
Technical Phone :+33 (0)1 41-02-83-24
Fax :+33 (0)1 49-01-07-23

MEU-GER (Mitsubishi Electric Europe B.V. German Branch)
<http://www.mitsubishi-evs.de/>
Gothaer Strasse 8, 40880 Ratingen, Germany

MEU-IR (Mitsubishi Electric Europe B.V. Irish Branch)
<http://www.mitsubishi.ie/>

Westgate Business Park, Ballymount, Dublin 24, Ireland
Sales Phone :+353(0)1-4198844
Fax :+353(0)1-4564422
Technical Phone :+353(0)1-4198807
Fax :+353(0)1-4198895

MEU-IT (Mitsubishi Electric Europe B.V. Italian Branch)
Centro Direzionale Colleoni, Palazzo Persero-Ingresso 2, Via Paracelso 12,
20041 Agrate Brianza, Italy

Phone :+39-(0)39-605031
Fax :+39-(0)39-6053214
E-mail :info.projector@it.mee.com

MEU-NL (Mitsubishi Electric Europe B.V. Benelux Branch)
<http://www.mitsubishi.nl/LCD/ProdFrame.html>
Nijverheidsweg 23a, 3641 RP Mijdrecht, The Netherlands

Sales Phone :+31-297-282461
Fax :+31-297-283936
E-mail :info.lcd@nl.mee.com
Technical Phone :+31-297-282461
Fax :+31-297-283936
E-mail :info.lcd@nl.mee.com

MEU (MITSUBISHI ELECTRIC EUROPE B.V.)

<http://www.mitsubishi-projector.ru/>
Moscow Representative Office, 12/1 Goncharnaya St. 109240, Moscow,
Russia

Sales Phone :+7 (095) 915 8603
Fax :+7 (095) 915 8603

MEU-SP (Mitsubishi Electric Europe B.V. Spanish Branch)

<http://www.mitsubishi-electric.es/>
Ctra. de Rubi, 76-80, 08190 Sant Cugat del Valles, Barcelona, Spain

Sales Phone :+34-93.565.31.54
Fax :+34-93.589.43.88
E-mail :mitsubishi.profesional@sp.mee.com
Technical Phone :+34-93.586.27.51
Fax :+34-93.699.74.45
E-mail :mitsubishi.profesional@sp.mee.com

MEU-SWE (Mitsubishi Electric Europe B.V. Scandinavian Branch)

Hammarbacken 14, Box 750, S-19127, Sollentuna, Sweden

Sales Phone :+46-(0)8-6251070
Fax :+46-(0)8-6251036

Technical Phone :+46-(0)8-6251052
Fax :+46-(0)8-6251036

MEU-UK (Mitsubishi Electric Europe)

<http://www.mitsubishi.co.uk/evs/>
Visual Information Systems Division, Travellers Lane, Hatfield,
Hertfordshire, AL10 8XB

Sales Phone :+44 (1707) 278684
Fax :+44 (1707) 278541
E-mail :projector.info@meuk.mee.com
Technical Phone :+44 (870) 606 5008
Fax :+44 (1506) 431927
E-mail :projector.info@meuk.mee.com

Russia (Mitsubishi Electric Europe B.V. Moscow Representative Office)
52, bldg.5, Kosmodamianskaya Nab, 113054, Moscow, Russian Federation

Sales Phone :+7 (095) 721 2070
Fax :+7 (095) 721 2071
Technical Phone :+7 (095) 721 2070
Fax :+7 (095) 721 2071

Asia

MITSUBISHI ELECTRIC RYODEN AIR-CONDITIONING & VISUAL INFORMATION SYSTEMS (HONGKONG) LTD.

• Hong Kong Office
Units 5-10, 20/F., Ever Gain Plaza, Tower One
88 Container Port Road, Kwai Chung, New Territories, Hong Kong.
Technical Support

Phone :+852 2510 0777
Fax :+852 2510 0463

• Beijing Office

9/F, Office Tower 1, Henderson Centre, 18 Jianguomennei Dajie,
Dongcheng District, Beijing, 100005, China

Sales & Technical Support
Phone :+86 (10) 6518 2930
Fax :+86 (10) 6518 2530

• Shanghai Office

10/F, Shanghai Square Office Tower, 138 Huai Hai Zhong Road, Lu
Wan District, Shanghai, 200021, China

Sales & Technical Support
Phone :+86 (21) 6327 2228
Fax :+86 (21) 6327 4918

• Shenzhen Office

Unit 01-04, 13/F, Building A, Tian An International Building, Renmin
Road South, Shenzhen, 518005, China

Sales & Technical Support
Phone :+86 (755) 518 6386
Fax :+86 (755) 218 4775

• Chengdu Office

Block B-1, 23/F., Chuan Xin Mansion, 18 Section 2, Renmin Road
South, Chengdu, 610016, China

Sales & Technical Support
Phone :+86 (28) 619 9730
Fax :+86 (28) 619 9801

MEAP (Mitsubishi Electric Asia Pte Ltd)

<http://www.mitsubishielectric.com.sg>
307 Alexandra Road, Mitsubishi Electric Building, 289245, Singapore

Main Line Phone :+65 6 473 2308
Fax :+65 6 475 9503

Sales & Technical Support

E-mail :peripherals@asia.meap.com

AMS (Antah Melco Sales & Services Sdn Bhd

(A Joint-Venture Company of Mitsubishi Electric Corporation))

<http://www.antahmelco.com.my>

6, Jalan 13/6, Petaling Jaya, Selangor Darul Ehsan, Malaysia

Main Line Phone :+603-7955 2088
Fax :+603-7956 3950
+603-7958 2576

Technical Support

Phone :+603-7955 2088

E-mail :anmelco@po.jaring.my

Product Information

Phone :+603-7955 2088

ME-TWN (Mitsubishi Electric Taiwan Co., Ltd.)

<http://www.mitsubishi-electric.com.tw>
9th Floor, 90 Sec. 6, Chung Shan N. Rd., Taipei, Taiwan

Sales Support Phone :+886 (0) 2 2832 8255
Fax :+886 (0) 2 2833 9813

KYW (Kang Yong Watana Co., Ltd.)

<http://www.mitsubishi-kyw.in.th>
28 Krungthep Kreetha Road, Huamark Bangkok, Bangkok, 10240,
Thailand

Sales Support Phone :+66 (2) 731 6901
Fax :+66 (2) 379 4763

STC (Setsuyo Astec Corp. Seoul Branch)

Dongseo Game Channel Bldg, 660-11, Deungchon-dong, Kangseo-ku,
Seoul, Korea

Main Line Phone :+82 (0) 2 3665 4964
Fax :+82 (0) 2 3665 4965

Oceania

ME-AUST (Mitsubishi Electric Australia)

<http://www.mitsubishi-electric.com.au/prod.asp?prod=proj>
348 Victoria Road, Rydalmere, N.S.W. 2116, Australia

Sales Phone :+(612)9684-7777
Fax :+(612)9898-0484
E-mail :ped@meaust.meap.com

BDT (Black Diamond Technologies Ltd.)

(Warranty Registration) <http://www.bdt.co.nz/projectors/warranty.asp>
1 Parliament St, Lower Hutt, Wellington, New Zealand

Sales Phone :+64(0)4-560-9100
Fax :+64(0)4-560-9133

E-mail :help@bdt.co.nz

Technical Phone :+64(0)4-560-9100
Fax :+64(0)4-560-9133

Manufactured by Mitsubishi Electric Corporation
1 Zusho Baba, Nagaokakyo-City, Kyoto Japan

 **MITSUBISHI ELECTRIC CORPORATION**