

EIKI

Owner's manual

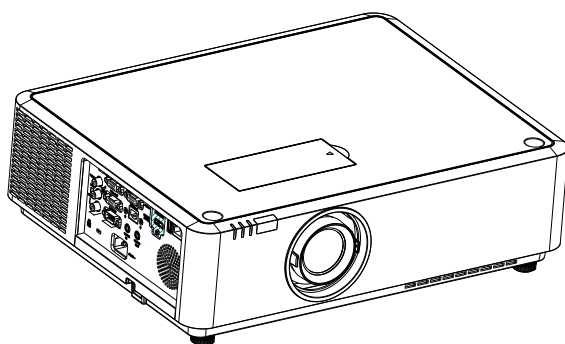

Multimedia Projector

EK-350U

EK-351W

Features and Design

This multimedia projector is build with the HLD light source, not only the great image quality through 3LCD technology and the longer life time as 25,000 hours. The color depth of this projector is up to 1.07 billion colors. And the Input/output terminal has located on the side of the projector to provide more convenient for the usage.

Simple Computer System Setting

The projector has the Multi-scan system to conform to almost all computer output signals quickly. Up to WUXGA resolution can be accepted.

Useful Functions for Presentations

- The digital zoom function allows you to focus on the crucial information during a presentation.
- The built-in speaker (10W*2) allows you to make a presentation without any external audio equipment.

Light Source Control

Brightness of the projection light source can be selected.

Logo Capture Function

The Logo Capture function allows you to customize the start up screen logo.

(This function is disable on EK-350U)

Multilanguage Menu Display

The screen menu of the projector is available in 26 languages: English, German, French, Italian, Spanish, Polish, Swedish, Dutch, Portuguese, Japanese, Simplified Chinese, Traditional Chinese, Korean, Russian, Arabic, Turkish, Finnish, Norwegian, Danish, Indonesian, Hungarian, Czech, Kazakh, Vietnamese, Thai, and Farsi.

Helpful Maintenance Functions

Filter maintenance functions provide for better and proper maintenance of the projector.

Security Function

The Security function helps you to ensure security of the projector. With the Key lock function, you can lock the operation on the control panel or remote control. PIN code lock function prevents unauthorized use of the projector.

LAN Network Function

This projector is loaded with the wired LAN network function. You can operate and manage the projector via network.

Auto Setup Function

This function enables input source search and auto PC adjust by simple pressing the AUTO button on the remote control.

Colorboard Function

At the time of simple projection on the colored wall, you can get the close color image projected on a white screen by selecting the similar color to the wall color from the preset four colors.

Power Management

The Power management function reduces power consumption and maintains the LED light source life.

Closed Caption

This is a printed version of the program sound or other information displayed on the screen. You can turn on the feature and switch the channels.

✓ Note:

- The screen menu and images in the manual may slightly differ from the real product.
- The manual is subject to change without prior notice.





Table of contents

Features and Design	2	Expand	
Table of contents.....	3	Language.....	46
Safety operation guideline.....	4	Auto Setup.....	45
Compliance.....	11	Keystone.....	47
Accessories	12	Curved correction	48
Overview		Logo.....	49
Name and function of the projector		Security.....	49
Front/top	14	Power Management.....	51
Rear	14	Filter counter.....	51
Control panel/LED indicator.....	15	Test pattern.....	52
Terminal	16	Network.....	52
Remote controller	17	Factory Default	53
Remote controller operation range	18	Memory Viewer	
Install battery of remote controller	19	Memory Viewer.....	54
Installation		Info.	
Installation		Information.....	55
Set up the projector	21	Description on using useful function	
Lens shift adjustment.....	22	Network control operation.....	57
Connection to equipment		Network display function.....	62
Connection to computer.....	23	Memory Viewer function	65
Connection to video equipment	24	USB Display function	67
Connection to audio equipment.....	25	Edge Blending function.....	69
Connect the AC power cord.....	26	Maintenance	
Operation		Regular maintenance	
Basic operation		Status indicator	71
Power on the projector.....	28	Clean the lens.....	72
Power off the projector.....	29	Clean casing of the projector	72
Zoom / focus function	30	Clear the filter	72
Lens shift function.....	30	Reset the filter counter.....	73
Auto setup function.....	30	Appendix	
Keystone adjustment	31	Troubleshooting	75
How to use the OSD.....	32	Light indicator status.....	77
Menu operation.....	32	Compatible computer screen.....	78
Menu item overview.....	33	Terminal configuration.....	79
Remote controller operation	34	Menu Tree.....	80
Input selection		Technical Specifications.....	84
Input select	35	Dimensions	86
Display		PIN code memorandum.....	87
Auto PC Adjusting.....	37	Color Adjust	
Manual computer adjustment	38	Color Adjust (Computer signals).....	41
Color Adjust		Color Adjust (Video signals).....	42
Color Adjust (Computer signals).....	41	Setting	
Color Adjust (Video signals).....	42	Setting.....	43
Setting			
Setting.....	43		

Safety operation guideline

Safety instructions

This document and the projector employ certain symbols to illustrate how to use the projector safely. They are described below: Please get yourself familiar with them before going through this document.

	Caution	Ignoring messages indicated by this symbol may lead to personal injuries or deaths due to human errors.
	Note	Ignoring messages indicated by this symbol may lead to personal injuries or property damage.
		High voltage inside with risks of electric shock.
		RG2. DO NOT stare into the beam. RG2. Ne regarde pas dans la poutre.

Please read this manual carefully before installing and operating the projector.

The projector comes with a lot of convenient features and functions. You may make the most of these features and keep the projector in good working conditions by using it correctly. Invalid operation of the projector may not only shorten its life cycle but also may lead to product failure, fire, or other incidents.

In case of any operation abnormality, refer to this manual to check the operation and connections and try solutions given in the “Troubleshooting” section at end of this manual. If the problem persists, call the dealer or our service center.

The projector's LED light source is a consumable and will get dimmer after long-term use. It's normal for an older LED light source to be dimmer than a newer one. Please power on and off the projector by strictly following steps given in “Power on the projector” and “Power off the projector” section of this manual. Execute regular maintenance and cleaning according to instructions set forth in “Maintaining and cleaning the projector” section of this manual. Fail to do so may shorten life cycle of the projector and its LED light sources sharply or even damage the projector and its LED light sources before long.



Caution

**Danger of electric shock
DO NOT open this.**



Note: DO NOT remove the casing (or back cover) as this may result in electric shock. Users shall not execute any maintenance work on components within the projector except replacing LED light sources. Call qualified maintenance personnel in case of any maintenance requirements.



High voltage inside with risks of electric shock.



Operation and maintenance tips about these components.

Safety operation guideline

Notes



Caution

Safety precautions:

- GROUND the projector.
- Lens of the projector projects strong light. DO NOT look at the light beam directly. You may get the eyesight hurt. This is especially the case with children.
- Unplug the AC power plug if the projector will not be used for long time.
- DO NOT overload the socket of power cord as it may lead to fire or electric shock. DO NOT subject the power cord to any object. DO NOT place the projector in locations where its power cord may become damaged by treading by passersby.
- Disconnect the power plug before cleaning the projector. DO NOT apply liquid or sprays to the projector. DO NOT wipe the projector with wet cloth.
- Please follow warnings and instructions given in labels attached to the projector. Unplug the projector when the projector is exposed to thunderstorm weather, is unmanned, or not in use for long periods to prevent damage caused by lightning and power surges.
- DO NOT use accessories without recommendation by the manufacturer as it may result in potential risks.



Caution

Precautions on air outlet:

- Keep adequate clearance around the projector for its ventilation and cooling. See figure below for the least clearance requirements. The least clearance is a MUST when the projector is placed within a cabinet or other closed environment.

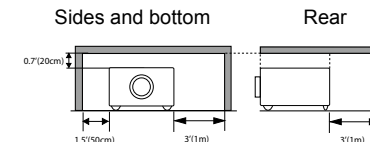

- DO NOT cover the air outlet of the projector. Poor ventilation not only shorten life cycle of the projector but also may lead to risks.
- Slots and openings at rear and bottom of the projector are designed for ventilation. Keep the projector from overheated to ensure its steady operation.
- DO NOT cover the air outlet with cloth or other objects. DO NOT place the projector on the surface of bed, sofa, carpets, or similar object as this may block the air outlets at its bottom.
- DO NOT place the projector in closed environment, e.g. a bookcase, unless it is well ventilated.
- Keep any matter from falling in the projector through the air outlets as they may touch high voltage parts and lead to fire or electric shock by short circuits. DO NOT splash liquid to the projector.

Safety operation guideline



Note:

Precautions on location of the projector:

- Place the projector in a proper location or it may result in fire.
- DO NOT expose the projector in rain or high humidity environments or it may result in fire or electric shock. DO NOT place the projector near water or splashing water. DO NOT place any water container, e.g. flower vase, atop the projector.
- DO NOT place the projector in environments of soot, moisture or smoke, e.g. the kitchen, or it may lead to product failure or accidents. The projector may be damaged by contact with oil or chemicals.
- DO NOT place the projector near exhaust pipe or air conditioning equipment.
- DO NOT place the projector near radiator or heating pipes.
- DO NOT place the projector atop unstable truck, rack, or table. It may fall off the surface and lead to personal injuries and property damages. Please use cart or rack recommended by the manufacturer or included with the product. Please follow steps given in installation guideline included with the wall and ceiling mount racks for installation. Use installation components approved by the manufacturer.
- Be careful when moving the projector with cart. Abrupt stops, pushing too hard and rugged surfaces may topple the projector and the cart together.

FOR EU USERS

The symbol mark and recycling systems described below apply to EU countries and do not apply to countries in other areas of the world.

The product is designed and manufactured with high quality materials and components which can be recycled and/or reused.

The symbol mark means that electrical and electronic equipment, batteries and accumulators, at their end-of-life, should be disposed of separately from the household waste.

Note:

If a chemical symbol is printed beneath the symbol mark, this chemical symbol means that the battery or accumulator contains a heavy metal at a certain concentration.

This will be indicated as follows: Hg: mercury, Cd: cadmium, Pb: lead In the European Union there are separate collection systems for used electrical and electronic equipment, batteries and accumulators.

Please, dispose of them correctly at the local community waste collection/recycling centre.

Please help us to conserve the environment we live in!



Safety operation guideline



Note:

Precautions on using the projector:

- DO NOT project the same image for long time as residual images may be left in the panel. This is a property of LCD panel.
- Use power as indicated in tags attached to the projector. If you have doubts over available power type, consult the dealer or local power company first.
- DO NOT open or remove the casing for maintenance as this may lead to electric shock or other damages. Call qualified maintenance personnel in case of any maintenance requirements.
 - In case of the following, unplug the power cord and call qualified maintenance personnel for service immediately:
 - a. Damaged or broken power cord or plug
 - b. Liquid splashed in the projector
 - c. The projector exposed to rain or water
 - d. If the projector fails to work as expected by following operation instructions, adjust it according to given instructions. Other invalid operations may damage the projector, which requires the technician to spend more time before returning it back to normal.
 - e. The projector falls off to ground or its casing is damaged.
 - f. In case of any abnormal change in the projector during its use, then maintenance services would be required.
- In case components replacement is required, make sure the replacements have been approved by the manufacturer and features the same with the one being replaced. Use of unauthorized parts may lead to fire, electric shock or personal injury.
- After the completion of maintenance or repair work, get the maintenance personnel to run routine safety check to ensure the projector's safety operation status.

Information for users in the European Union

This is a device to project images onto a screen, etc., and is not intended for use as indoor lighting in a domestic environment.
Directive 2009/125/EC.

Safety operation guideline

Air ventilation

Openings in the casing are designed for ventilation and overheating prevention. DO NOT block or cover these openings to keep the projector in normal operation and from overheating.

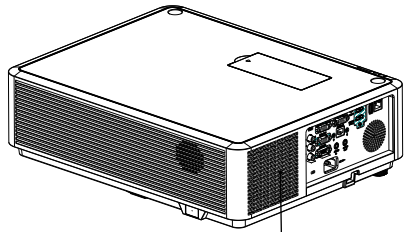

Air intake

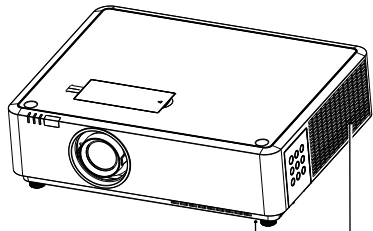

Air intake

Air outlet
(For heat exhaust)



Note:

Heat exhaust at the air outlet. Keep the following in mind when using or installing the projector:

- DO NOT place flammable materials or sprayers near the projector.
- Keep the air outlet one meter away from other objects.
- DO NOT touch the area close to the air outlet especially the metal components, e.g. screws. This area and parts will get very hot once the projector starts operating.
- DO NOT place any object atop the projector. They may not only be damaged but also lead to fire after being overheated.

Cooling fans are designed for cooling the projector. Fan speed is auto adjusted subject to internal temperature of the projector.

Safety operation guideline

- The projector supports 360° projection vertically and horizontally.

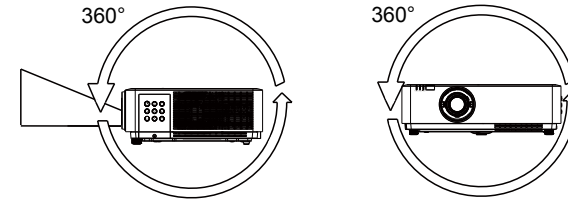

Note:

- Enable the “Ceiling” function if flip over screen is required.



Note:

Precautions on ceiling mount racket installation:

- Get qualified technician to install the ceiling mount racket.
- Warranty of the projector does not cover hazards and damage caused by using ceiling mount rackets provided by unauthorized dealers.
- Remove the ceiling mount racket when it is not in use.
- Apply torque driver instead of power driver or impact driver in the projector.

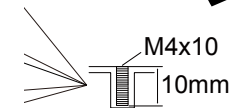
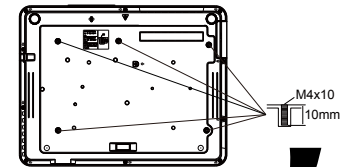

Safety operation guideline

Moving the projector

When moving the projector close its adjustment legs as they may damage the lens and casing. Keep the projector in suitable box when it is not to be used for a long time.



Note:

Precautions on moving or shipping the projector:

- DO NOT drop or impact the projector as it may get damaged or failed in operation.
- Please employ proper container for movement.
- Prohibit express or other shipping service provider personnel from shipping the projector with improper boxes. The projector may become damaged. Please consult the dealers for shipping the projector by express or other shipping service providers.
- Place the projector in box only after it has been fully cooled down.

Precautions on dealing with the projector:

DO NOT lift or move the projector by holding the lens or projecting decoration ring as it may damage the lens and the projector.

Be careful when handling the projector. DO NOT drop it, subject it to external forces, or place objects atop it.

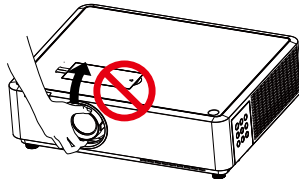
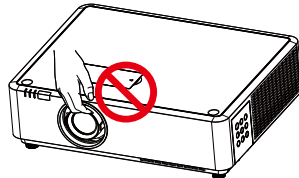

DO NOT hold the lens or area around it.

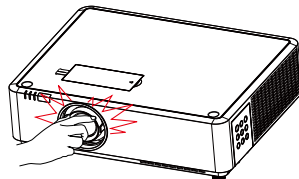

Compliance

FCC Caution

Declaration of Conformity

This device complies with Part 15 of the FCC Rules.

Operation is subject to the following two conditions:

(1) This device may not cause harmful interference, and (2) this device must accept any interference received, including interference that may cause undesired operation.

To assure continued compliance, follow the attached installation instructions and do not make any unauthorized modifications.

CAUTION:

This equipment has been tested and found to comply with the limits for a Class A digital device, pursuant to part 15 of the FCC Rules. These limits are designed to provide reasonable protection against harmful interference when the equipment is operated in a commercial environment. This equipment generates, uses, and can radiate radio frequency energy and, if not installed and used in accordance with the instruction manual, may cause harmful interference to radio communications. Operation of this equipment in a residential area is likely to cause harmful interference in which case the user will be required to correct the interference at his own expense.

Model Number : EK-350U, EK-351W

Trade Name : EIKI

Responsible party : EIKI International, Inc.

Address : 30251 Esperanza Rancho Santa Margarita CA 92688-2132

Telephone No. : 800-242-3454 (949-457-0200)

AC Power Cord Requirement

The AC Power Cord supplied with this projector meets the requirement for use in the country you purchased it.

AC Power Cord for the United States and Canada:

AC Power Cord used in the United States and Canada is listed by the Underwriters Laboratories (UL) and certified by the Canadian Standard Association (CSA).

AC Power Cord has a grounding-type AC line plug. This is a safety feature to be sure that the plug will fit into the power outlet. Do not try to defeat this safety feature. Should you be unable to insert the plug into the outlet, contact the electrician.

AC Power Cord for the United Kingdom:

This cord is already fitted with a moulded plug incorporating a fuse, the value of which is indicated on the pin face of the plug. Should the fuse need to be replaced, an ASTA approved BS 1362 fuse must be used of the same rating, marked thus \diamond . If the fuse cover is detachable, never use the plug with the cover omitted. If a replacement fuse cover is required, ensure it is of the same colour as that visible on the pin face of the plug (i.e. red or orange). Fuse covers are available from the Parts Department indicated in the User Instructions.

If the plug supplied is not suitable for the socket outlet, it should be cut off and destroyed.

The end of the flexible cord should be suitably prepared and the correct plug fitted.

WARNING : A PLUG WITH BARED FLEXIBLE CORD IS HAZARDOUS IF ENGAGED IN A LIVE SOCKET OUTLET.

The Wires in this mains lead are coloured in accordance with the following code:

Green-and-yellow	Earth
Blue	Neutral
Brown	Live

As the colours of the wires in the mains lead of this apparatus may not correspond with the coloured markings identifying the terminals in the plug proceed as follows:

The wire which is coloured green-and-yellow must be connected to the terminal in the plug which is marked by the letter E or by the safety earth symbol \perp or coloured green or green-and-yellow.

The wire which is coloured blue must be connected to the terminal which is marked with the letter N or coloured black.

The wire which is coloured brown must be connected to the terminal which is marked with the letter L or coloured red.

WARNING: THIS APPARATUS MUST BE EARTHED.

THE SOCKET-OUTLET SHOULD BE INSTALLED NEAR THE EQUIPMENT AND EASILY ACCESSIBLE.

Accessories

Quick Start Guide

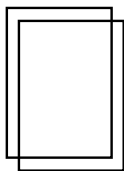

Safety Information

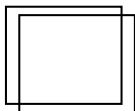

AC Power Cord

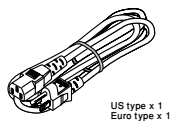

US type x 1
Euro type x 1

VGA Cable

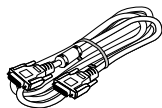

Remote Control with batteries
(AA or LR6)



Overview

This chapter presents names and functions of individual component.

Name and function of the projector

Front/top

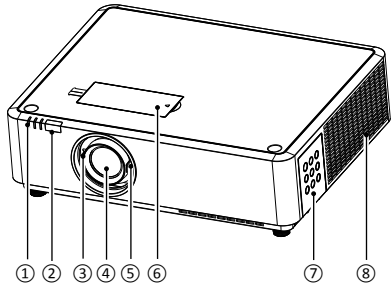

- ① LED indicator (Power / Status / Filter)
- ② Remote controller receiver (front)
- ③ Focus ring
- ④ Projection lens
- ⑤ Zoom ring
- ⑥ Cover of lens shift ring
- ⑦ Control panel
- ⑧ Exhaust vent

Rear

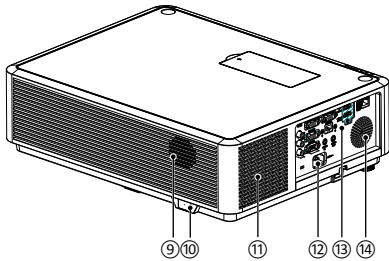

- ⑨ Speaker
- ⑩ Remote controller receiver (rear)
- ⑪ Intake vent
- ⑫ AC power cord connector
- ⑬ Input / Output terminal
- ⑭ Speaker

Bottom

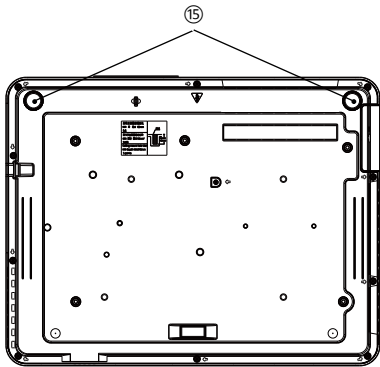

- ⑮ Adjustable foot



Note:

Air exhaust emits hot air. DO NOT place heat sensitive objects near it.

Name and function of the projector

Control Panel

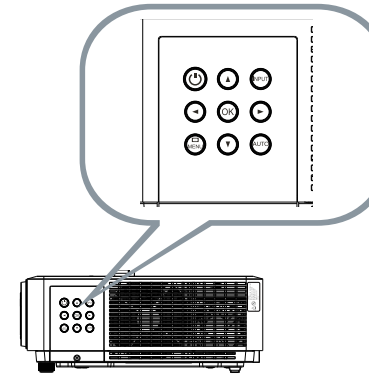

- Power / Stand-by
Power on or off the projector
- Left / Right / Up / Down
 - Select items or adjust values in the OSD menu.
 - Select display area in digital zoom+ mode
 - Adjust the volume.
- OK
Enter the OSD menu or select options in a menu
- Input
Select source of input
- Menu
Open or close the OSD menu
- Auto
Optimize a computer image automatically

LED indicator

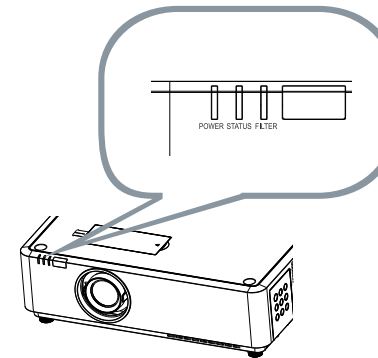

- POWER indicator
 - The power indicator turns steady red when the projector is in standby mode
 - It turns steady green when the projector is in normal operation
- STATUS indicator
It flashes orange when internal temperature of the projector is out of operation range
- FILTER indicator
It turns orange when the filter requires cleaning

Name and function of the projector

Terminal

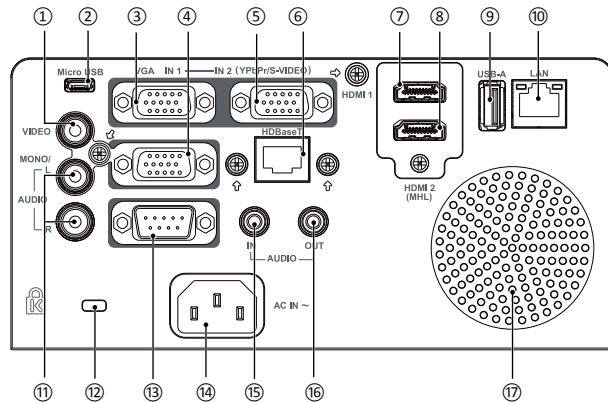

- ① VIDEO IN
Connect video output signal to this terminal.
- ② Micro-USB
The terminal is to use the USB display function, when connected the projector to computer with USB cable
- ③ VGA IN 1
Connect output signal from computer to this terminal.
- ④ VGA OUT
Transmit signals from ③ or ⑤ to other displays when the projector is acting as a output display.
- ⑤ VGA IN 2 / YPbPr / S-VIDEO
Connect output signal from computer, YPbPr or S-Video to this terminal.
- ⑥ HDBaseT
Connect to this terminal through a network cable to achieve the HDBaseT function.
- ⑦ HDMI 1
Connect HDMI digital output signals to this terminal.
- ⑧ HDMI 2(MHL)
Connect HDMI digital output signals or MHL digital output signals to this terminal.
- ⑨ USB
When using the Memory Viewer function, insert the USB Flash Drives to this terminal directly.
- ⑩ LAN
Connect network cable to this port for controlling and operating the projector via network.
- ⑪ AUDIO (L/R)
Connect audio signals to this terminal.
- ⑫ Kensington Security Slot
This slot is for a Kensington lock used to deter theft of the projector.
* Kensington is a registered trademark of ACCO Brands Corporation
- ⑬ RS232C
Connect serial cable to this terminal when using RS232 device to control or operate the projector.
- ⑭ Power cord connector
- ⑮ AUDIO IN
Connect audio signals
- ⑯ AUDIO OUT
Output audio signals to amplifier or other audio equipment.
- ⑰ Speaker

Name and function of the projector

Remote controller

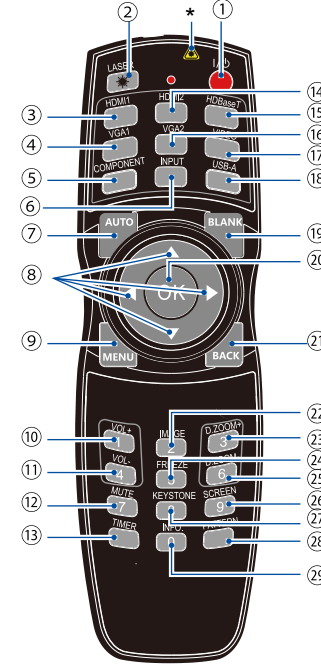

* Laser Transmitting Window:
Laser beam will emit from this window while pressing LASER button during the projection to use the remote controller as a laser pointer.

Do not stare directly at the laser transmitting window or aim the window at human body, to avoid any physical injury.

- ① POWER
Power on or off the projector.
- ② LASER
Press the LASER button during presentation to use the remote controller as laser pointer.
- ③ HDMI
Select HDMI input source.
- ④ VGA 1
Select VGA 1 input source.
- ⑤ COMPONENT
Select Component input source.
- ⑥ INPUT
Open or close the INPUT menu.
- ⑦ AUTO
Optimize a computer image automatically
- ⑧ Arrow ▲▼◀▶
-Select items or adjust values in the OSD menu
-Select display area in digital zoom+ mode.
- ⑨ MENU
Open or close the OSD menu.
- ⑩ VOLUME +
Increase volume.
- ⑪ VOLUME -
Decrease volume.
- ⑫ Mute
Mute the sound.
- ⑬ TIMER
Enable the timer function.
- ⑭ HDMI 2
Select HDMI 2(MHL) input source.
- ⑮ HDBaseT
Select HDBaseT input source.
- ⑯ VGA 2
Select VGA 2 input source.
- ⑰ VIDEO
Select VIDEO input source.
- ⑱ USB-A
Select Memory Viewer input source.
- ⑲ BLANK
Dark out screen images temporarily.
- ⑳ OK
Enter the OSD menu or select options in it.
- ㉑ BACK
Backward or exit the OSD menu.

Name and function of the projector

- ⑳ IMAGE
Select image mode.
- ㉑ D.ZOOM+
Zoom in projected image.
- ㉒ FREEZE
Freeze projected images.
- ㉓ D.ZOOM-
Zoom out projected image.
- ㉔ SCREEN
Select screen size.
- ㉕ KEYSTONE
Keystone calibration.
- ㉖ PATTERN
Select built-in test pattern of the projector.
- ㉗ INFO.
Display current status information of the projector.

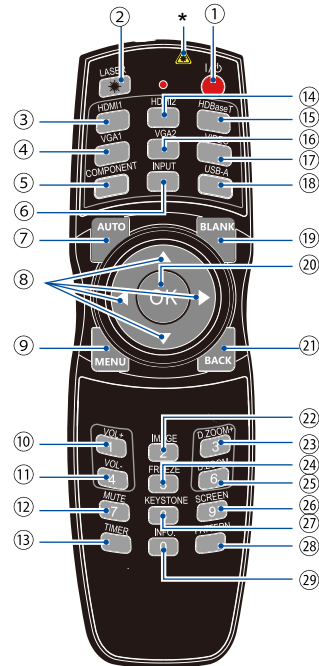

Operation range of remote controller

Point the remote controller to the IR receiver of the projector

Maximum operation range of the remote controller is an area of radius 5 meters / arc 60° in front of and behind the projector

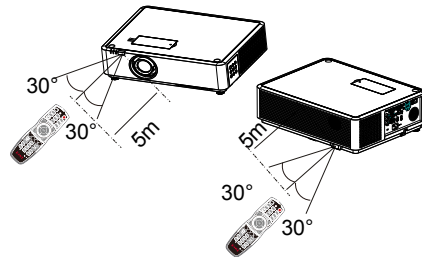

Name and function of the projector

Install battery of remote controller

- ❶ Open the battery cover.
- ❷ Insert a new battery in it.
Two AA (LR6) batteries
Place the batteries with its anode and cathode (+ and -) in correct direction. Keep both poles in good connection to the contacts within the compartment.
- ❸ Put the cover back.

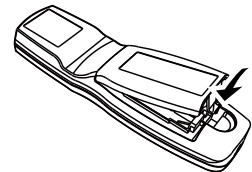
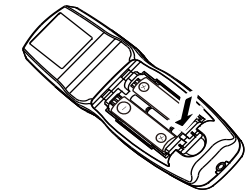
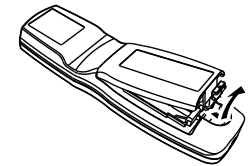

Please follow the following rules for safety operation:



- Use two of AA or LR6 alkaline batteries.
- Replace both batteries at the same time.
- Do not mix new and old batteries as one pair.
- Keep the remote controller away from water or other liquids.
- Do not expose the remote controller to environments with high humidity or temperature.
- Do not drop the remote controller.
- In case of any battery solution leaking in the compartment, clear it thoroughly before placing new batteries in it.
- Using battery of other types than what specified on this manual may lead to risks of explosion.
- Please dispose the old battery by following instructions given in tag of the battery or local regulations.

Installation

Set up the projector

- Ambient brightness may affect the projection image quality. For the optimal image effect, it is recommended to control brightness in the environment.
- Values shown in figure below are approximates only. They may differ from the actual ones.

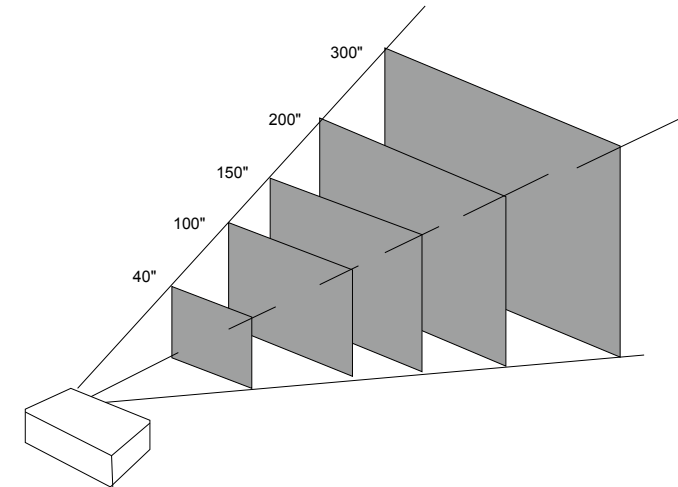

Installation

EK-350U / EK-351W (16:10)

Unit:cm

Screen size	40"		100"		150"		200"		300"	
	Width	Height	Width	Height	Width	Height	Width	Height	Width	Height
Maximum	86	54	215	134	323	202	431	269	646	404
Minimum	152.3		384.9		578.8		772.7		1160.5	

EK-350U / EK-351W (16:9)

Unit:cm

Screen size	40"		100"		150"		200"		300"	
	Width	Height	Width	Height	Width	Height	Width	Height	Width	Height
Maximum	89	60	221	125	332	187	443	249	664	374
Minimum	156.6		395.7		595.0		794.3		1192.8	

This chapter introduces the information of install.

Installation

Lens shift adjustment

The electric lens shift function may adjust the lens in all four directions. This function enables easy image position adjustment.

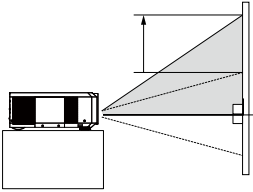
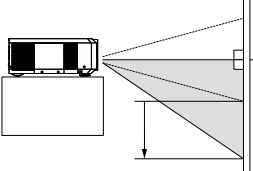
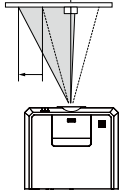
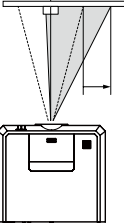
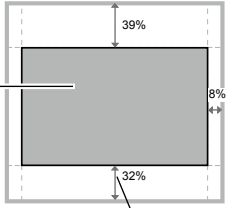
<p>The projection location of the image may be moved upward a distance up to 39% of the length of the image.</p>	<p>Move lens to top position</p> 
<p>The projection location of the image may be moved downward a distance up to 32% of the length of the image.</p>	<p>Move lens to bottom position</p> 
<p>The projection location of the image may be moved leftward a distance up to 8% of the width of the image.</p>	<p>Move lens to leftmost position</p> 
<p>The projection location of the image may be moved rightward a distance up to 8% of the width of the image.</p>	<p>Move lens to rightmost position</p> 
<p>Scope of lens shift adjustment</p>	<p>Center of the lens</p>  <p>Lens shift range</p>

*When the setting of LENS SHIFT as the maximum position, the corner of projection image might be darker.

Connection to equipment

Connection to computer

Cables used for connection:

- VGA cable
- HDMI cable*
- Serial cable*
- USB cable*
- USB device*

(*Cables are not supplied with the projector)

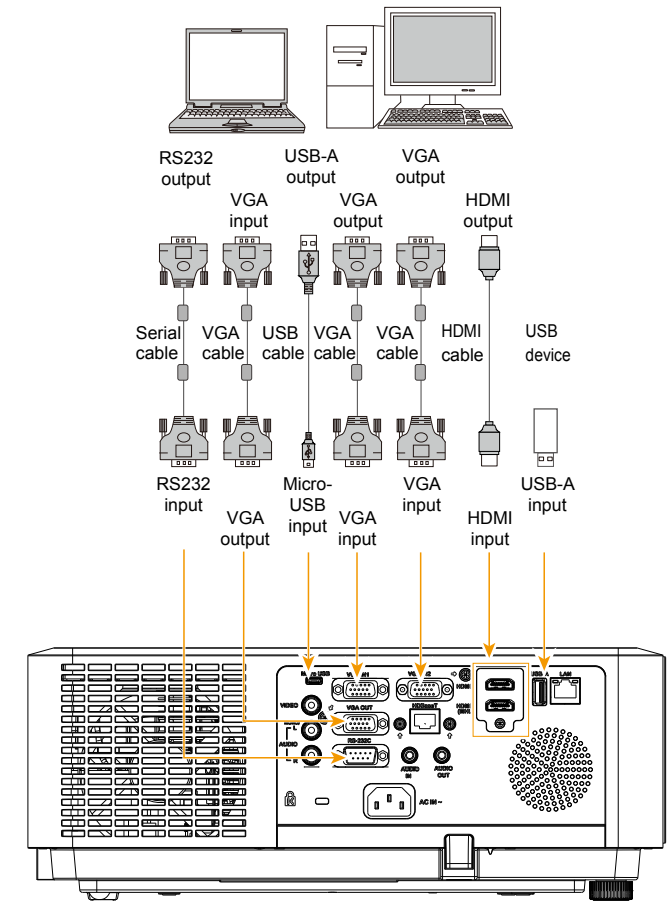

Unplug power cords of the projector and all external equipment before connecting any cable to them.

Connection to equipment

Connection to video equipment

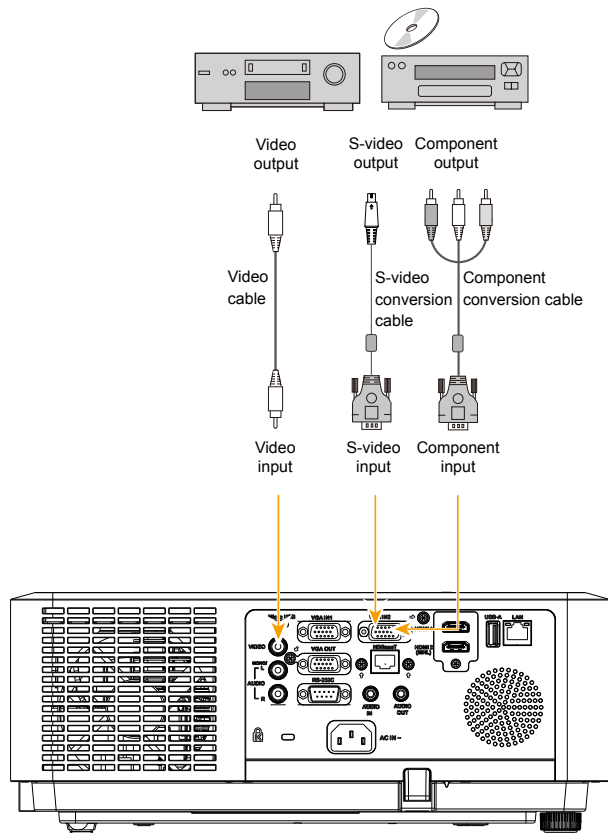

Unplug power cords of the projector and all external equipment before connecting any cable to them.

Connection to equipment

Connection to audio equipment

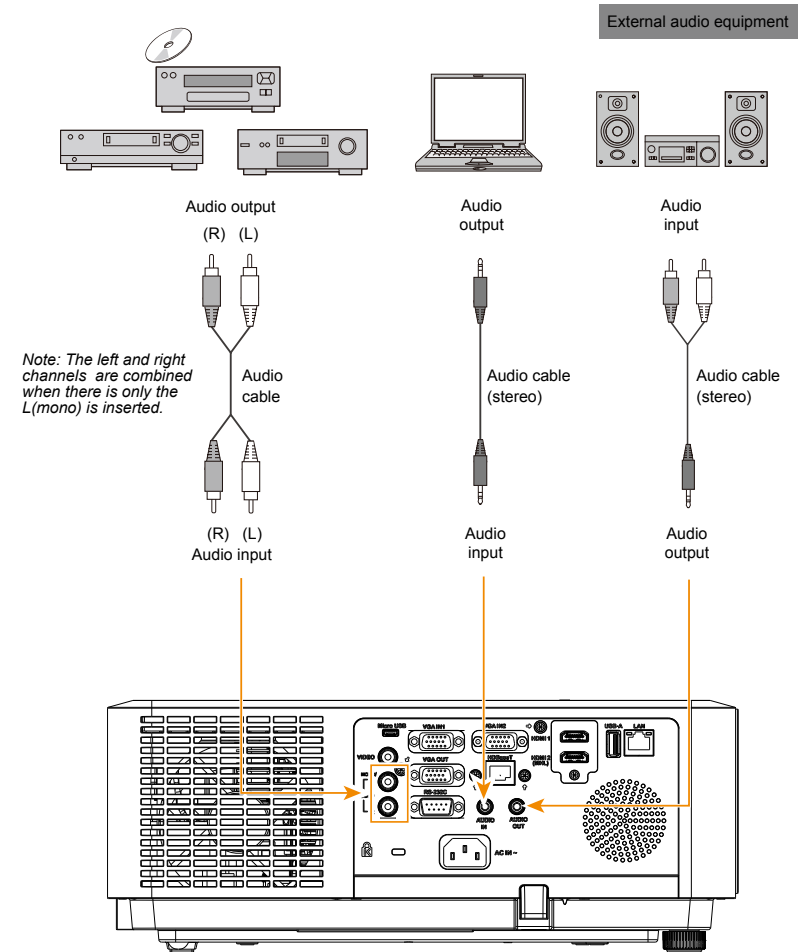

Unplug power cords of the projector and all external equipment before connecting any cable to them.

Connection to equipment

Connect the AC power cord

Standard voltage employed by the projector is AC 100-240V. It adapts to different input voltage automatically. The projector employs 2-phase power cord with neutral ground cable.

Do not use any other type of power cords or you may face the risks of electric shock. In case you have any doubt on type of power cord you are using, please call authorized dealer or service center for help. Before powering on the projector, get all external equipment connected in advance.

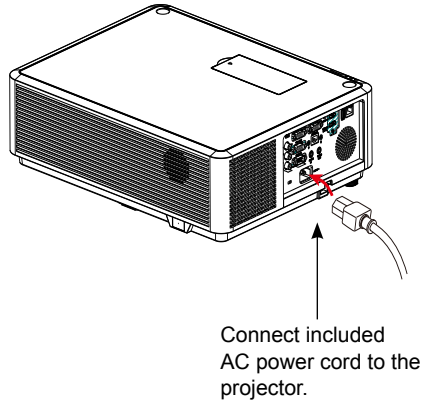

Note:

Keep the AC power socket close to the projector for easy plugging and unplugging.

✓ Note:

For safety reasons, unplug the AC power cord when the projector is not in use. The projector will consume a small amount of power when it is connected to AC grid power and in standby mode.

Precautions on power cord

The AC power cord should meet regulations of the country/district where the projector is used. Please make sure the type of the power plug is compliant with those given in figure below. Make sure you are using a valid AC power cord. In case the included AC power cord does not comply with the AC power socket in the location, call the dealer for replacement.

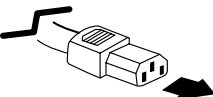
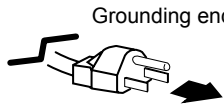
The projector side	Connect to the AC power socket
 <p data-bbox="129 1157 470 1204">Connect to power cord connector of the projector</p>	 <p data-bbox="622 1157 896 1189">Connect to AC power socket</p>

✓ Note:

- Use of invalid power cord may hamper product performance or even lead to electric shock, fire, and other incidents. Please use power cord compliant with the included one to ensure product performance and operation safety.
- The frequently used cables are: AC power cord, VGA cable, audio cable, video cable, and RS232 control cable.

Operation

This chapter introduces you to basic operation of the projector.

Basic operation

Power on the projector

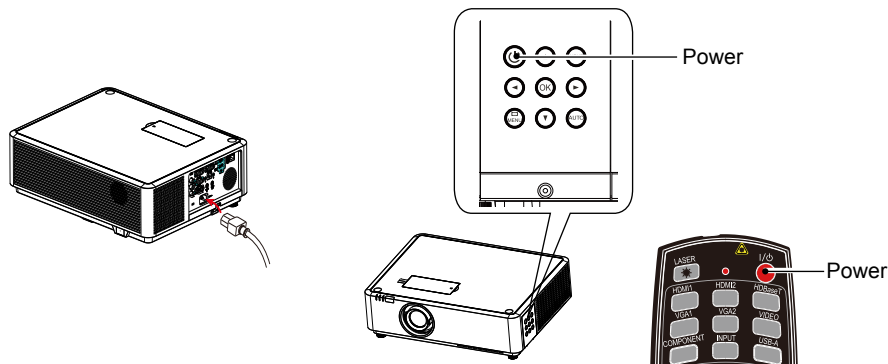

1. Connect all external equipment to the projector (e.g. computer or media player) before powering it on.
2. Connect AC power cord of the projector to an AC power socket. The Power indicator turns on in red.
3. Press the Power button on the control panel or the remote controller. The Power indicator lights in green and the cooling fan starts running.
4. If the projector is setting as password protected, the password dialog box displays. Enter the password as instructed below.

Enter password (PIN)

Press ENTER button to start input the PIN code. Press ◀▶ button to select a number, then press ENTER button to select and the cursor would move to next field automatically. The number you typed is displayed as “*”. Repeat this step to fill in a 3-digit number. If any mistake, press MENU button to reset.

After fill in the PIN code, the cursor would move to the “Set” selection. Press the ENTER button and now you are ready to use the projector. Or press ▶ button select “Cancel” to give up the setting.

If the password is invalid, the password displayed as “***” will be in red. Please try again with a valid one.

✓ Note:

- In case the “Logo Select” option is set to OFF, then no welcome image will display in screen.
- You can do nothing but powering off the projector during the welcome image is displaying.



What is a password (PIN)?

A password (PIN) is an ID code for identifying people with knowledge about it to operate the projector. A password (PIN) setting may help preventing the projector from unauthorized use.

Your password (PIN) code is a 3-digit number. To find out more about protecting the projector with a password (PIN), please refer to the PIN Code Lock function in the Setup menu on Page 50 for details.

Precautions on password (PIN) operation

You cannot operate a password (PIN) protected projector without correct password (PIN). Please set up a new password (PIN) and keep the operation manual in safe place. In case the password (PIN) is lost or forgotten, call the dealer or service center.

Basic operation

Power off the projector

1. Press the Power button at the control panel or the remote controller, the “Power off?” message displays.
2. Press the Power button again in 4 seconds after the “Power off?” message prompted to you. The POWER indicator flashes red while the cooling fan continues running. (You may set up noise level and speed of the fan.) Unplug the power cord until the fan stops running. Failure to do so may shorten life cycle of the projector or lead to power on failures or operation abnormalities.
3. The POWER indicator stops flashing once the projector has been cooled down to ready for power on again.



Do not use the projector without stop. As it may hurt the life cycle of the LED light source. Power off the projector at least once every 24 hours and have it idle for an hour.

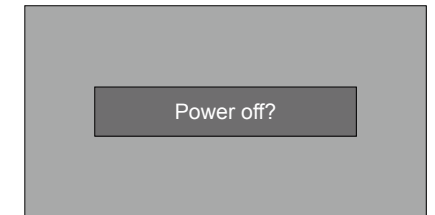
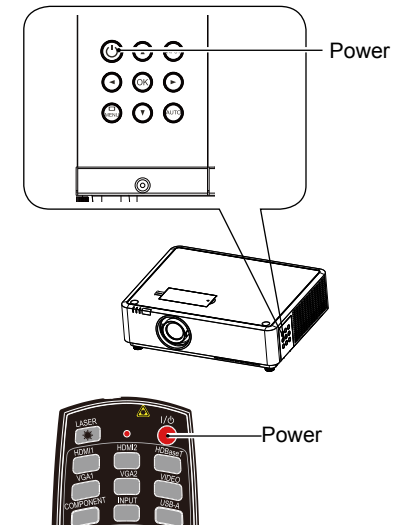

“Power off?” message disappears in 4 seconds.

✓ Note:

- If the “On Start” function is set to “On”, the projector will power on once it is connected to an AC power socket. (Refer to page 43)
- Speed of the cooling fan varies with internal temperature of the projector.
- Do not place the projector in any box before it is fully cooled down.
- In case the STATUS indicator flashes or turns red, refer to the “Light indicator status” for instructions. (Refer to page 77)
- The POWER indicator flashes when the LED light source is cooling down. Do not power on the projector at this time. Power on the projector only after the POWER indicator turns red.
- Unplug the power cord after the projector has been turned off. The fan stops running.
- The POWER indicator turns red when the projector is ready for power on again.

Basic operation

Zoom / focus function

Rotate the ZOOM ring to zoom in or zoom out the image.

Rotate the FOCUS ring to adjust the focus of the image.

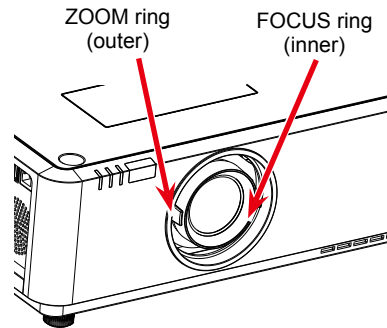

Lens Shift function

Perform the lens shift adjustment with ① and ②.

Rotate ①, the screen may deviate up-and-down from the central axis of lens shift up:38% and down:32% elevation of the display.

Rotate ②, the screen may deviate left-and-right from the central axis of lens shift 8% width of the display.

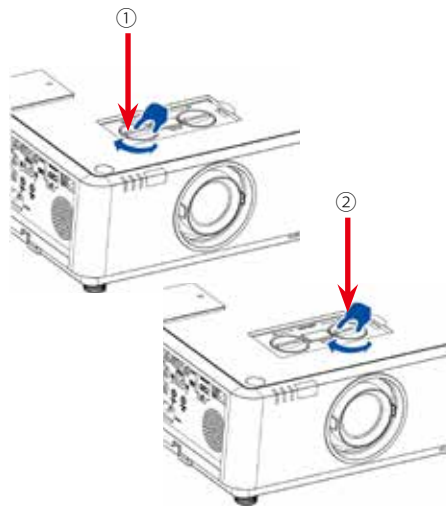

Adjustable pad

The projector can be adjusted up to 5° with the adjustable pads.

Rotate the adjustable pad to lift the projector to a certain height. During lifting, rotate the pad clockwise.

To lower or retract the adjustable pads, rotate the pad counterclockwise.

Keystone distortion of projected images can be corrected by auto settings, remote control operation or menu operation.

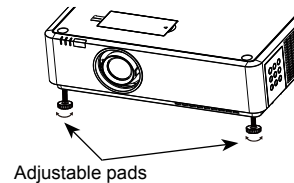

Basic operation

Auto setup function

Press the AUTO button on the remote controller to auto execute settings given in the Auto Setup menu (including Auto Searching, Auto PC Adjusting and Auto Keystone).

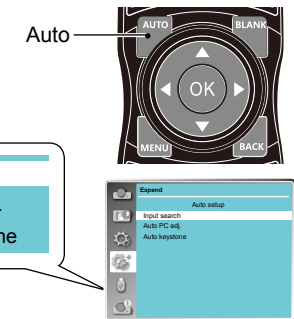

Keystone adjustment

You may adjust keystone distortion of image in the projector with the keystone adjustment.

Follow steps below to adjust keystone distortion of projected image manually.

Press the KEYSTONE button on the remote controller.

The Keystone selection menu show up, press ▲▼ button to select the adjustment.

The keystone adjustment dialog box displays, press ▲▼◀▶ button to adjust keystone distortion.

You may save the settings for keystone adjustment.

H/V Keystone

Adjust the projected image when the projector is on the horizontal or vertical keystone distortion.

Corner correction

Adjust the projected image when the projector is keystone distortion of four corners.

Curved correction

Adjust the projected image when the projector linearity is uneven or the projected images bent vertically and horizontally. (*This function is unavailable of EK-350U)

Reset value

The correction values will be restored to the factory defaults.

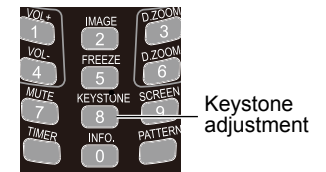

Keystone adjustment

*for WXGA model

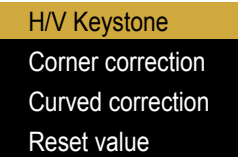

*for WUXGA model

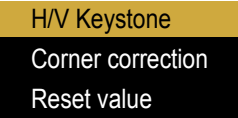

Keystone adjustment

- The arrow mark looks white when there is no keystone adjustment in existence.
- The arrow mark indicating the adjustment direction turns red.
- The arrow mark disappears when the maximum adjustment limit reaches.
- The keystone adjustment will be canceled if you press the keystone adjustment button when it is displaying.
- The adjustable range is subject to source of signal input.

Basic operation

Remote controller operation

Use the remote controller for common operations.

Blank (BLANK)

Press the BLANK button on remote controller a blank screen displays to replace existing image. Press the BLANK button or any other button to restore the image. Press the BLANK to toggle switch the screen as shown below:

BLANK → Normal → BLANK → Normal →

Image mode selection (IMAGE)

Press the IMAGE button on remote controller to select required image mode.

Digital Zoom (D.ZOOM+/-)

Press the D.ZOOM+/- button on remote controller to enter the Digital Zoom mode.

Screen size selection (SCREEN)

Press the SCREEN button on remote controller to select required screen size mode.

Freeze (FREEZE)

Press the FREEZE button on remote controller to freeze image on the screen and mute the sound. Press the FREEZE button to cancel the freeze function.

Volume +/- (VOL +/-)

Increase or decrease volume.

Mute the sound (MUTE)

Press MUTE button on the remote control to turn off the volume. Press MUTE button again or VOL+/- button to cancel mute function.

Timer (TIMER)

Press the TIMER button on remote controller. A timer animation (00:00) displays and starts timing in format of (00:00-59:59). Press the TIMER button again to stop timing. Press the TIMER button again to disable the timing function.



Timer display

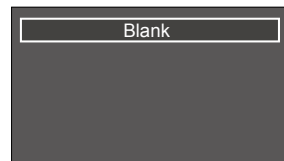
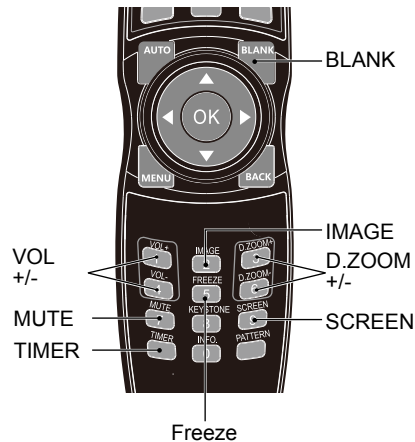

The Blank screen disappears if no buttons are pressed in 4 seconds.

Input selection

Input select

Direct operation

Press HDMI 1, HDMI 2, VGA 1, VGA 2, VIDEO, HDBase T, COMPONENT or USB-A on the remote control as input source.

Menu operation

- 1 Press INPUT button on the remote control or control panel to display the input select menu.
- 2 Press ▲▼ button to select VGA 1, VGA 2, HDMI 1, HDMI 2(MHL), HDBaseT, Component, Video, S-video, Memory Viewer, Network or USB Display, then press the OK button.

VGA 1

When input source is from computer connected to VGA IN 1 terminal with VGA cable, please select "VGA 1".

VGA 2

When input source is from computer connected to VGA IN 2 (YPbPr/S-VIDEO) terminal with VGA cable, please select VGA 2.

HDMI 1

When input source is from equipment connected to HDMI 1 terminal with HDMI cable, please select "HDMI 1".

HDMI 2(MHL)

When input source is from equipment connected to HDMI 2(MHL) terminal with HDMI cable, please select "HDMI 2".

HDBase T

When input source is from equipment connected to HDBaseT terminal with RJ45 cable, please select "HDBaseT".

Component

Select it when the input source is from the video equipment connected to VGA IN 2 (YPbPr/S-VIDEO) terminal via Component to VGA cable.

Video

Select it when the video input signal is connected to VIDEO IN terminal.

✓Note:

- When the "Input search" function is set to "On" in the "Auto setup" function, the input signal will be searched automatically.

Remote control

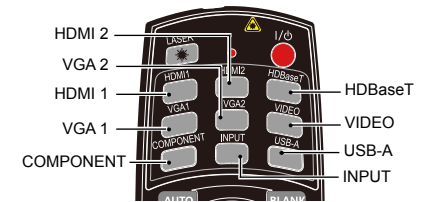

Control Panel

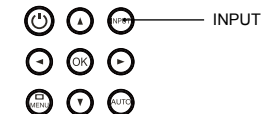

Input select menu

- VGA 1
- VGA 2
- HDMI 1
- HDMI 2(MHL)
- HDBase T
- Component
- Video
- S-video
- Memory Viewer
- Network
- USB Display

Input selection

S-video Select it when the video input signal is connected to VGA IN 2(YPbPr/S-VIDEO) terminal via S-Video to VGA adaptor cable

Memory Viewer When input source is from device connected to USB-A terminal, please select "Memory Viewer".

Network When input source is from network connected to LAN terminal with LAN cable, please select "Network".

USB Display When input source is from the device connected to Micro-USB terminal, please select "USB Display".

Remote control

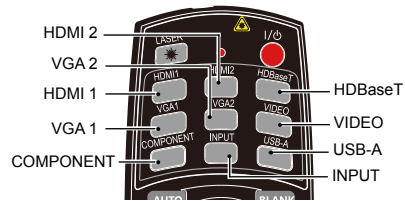

Control Panel

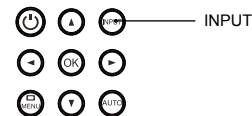

Input select menu

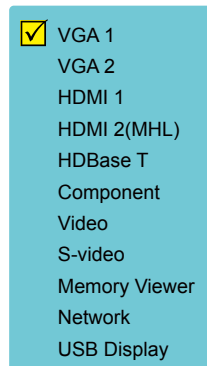

✓Note:

- When the "Input search" function is set to "On" in the "Auto setup" function, the input signal except "USB Display", "Memory Viewer" and "Network" will be searched automatically.
- When signal is in "USB Display", "Memory Viewer" and "Network", FREEZE, ASPECT, IMAGE, AUTO SETUP, TEST PATTERN and SCREEN function cannot work.

Basic operation

How to use the OSD

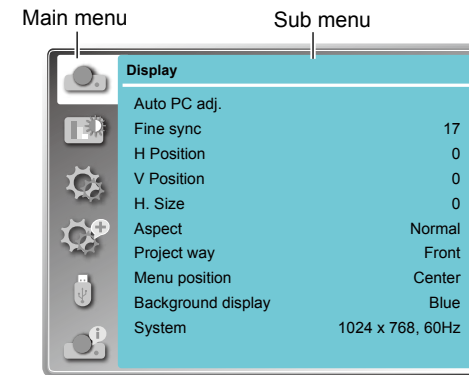

Menu operation

1. Press the MENU button on the rear control panel or remote controller and the OSD displays.
2. Press ▲▼ button to act on or select one main menu item. Press ► button or OK button to enter a submenu.
3. Press ▲▼ button to select required submenu, then press OK button or ► button to set up or enter an option.
4. Press ▲▼◀▶ button to select settings or navigate options, then press OK button to act on the item and exit.
5. Press ◀ button to return to mainmenu. Press the MENU button on remote controller or control panel to exit the OSD.

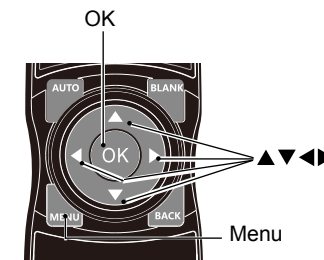
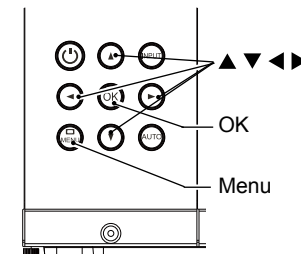

Basic operation

Menu item overview

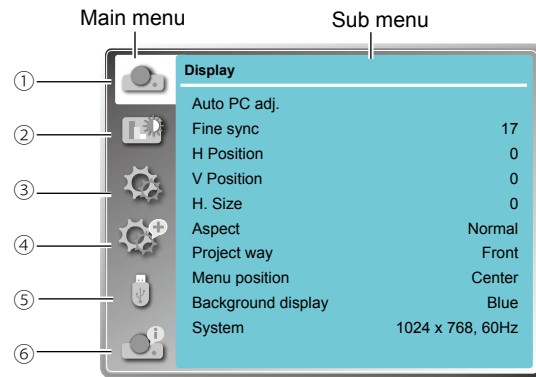

- ① **Display**
Select Auto PC Adjust, Fine sync., H Position, V Position, H size, Aspect, Project way, Menu position, Background display, System to align each parameter with the input signal format.
- ② **Color adjust**
For computer input source, the color adjust options are: Image mode (Cinema/ Blackboard(Green)/ DICOM/ Colorboard/ User Image/ Dynamic/ Standard/ Bright), Contrast, Brightness, Color temp., Red, Green, Blue and sharpness.
For the input source as video equipment, the color adjust options are: Image mode (Cinema/ Blackboard(Green)/ DICOM/ Colorboard/ User Image/ Dynamic/ Standard/ Bright), Contrast, Brightness, Color, Tint, Red, Green, Blue and sharpness.
- ③ **Setting**
For computer input the setting options are: On start, Standby mode, High land, Light source mode, Cooling fast, Closed caption, Key lock, Contrast optimization, Remote control, Sound and HDMI setup.
For video input the setting options are: On start, Standby mode, High land, Light source mode, Cooling fast, Closed caption, Key lock, Contrast optimization, Remote control and Sound.
For HDMI input the setting options are: On start, Standby mode, High land, Light source mode, Cooling fast, Key lock, Contrast optimization, Remote Control, Sound and HDMI setup.
- ④ **Expend**
Setting the Language, Auto setup (Input search/ Auto PC adj./ Auto keystone), Keystone, Logo, Security, Power management, Filter counter, Test pattern, Network and Factory default function as you need.
- ⑤ **Memory Viewer**
Setting the display method of Memory Viewer page as Set slide, Slide transition effect, Sort order, Best fit, Rotate, Repeat and Apply.
- ⑥ **Information**
Display information about the projector.

OSD Setting-Display

Auto PC Adjusting

The Auto PC Adjusting function may get Total Dots, Horizontal and Vertical position, Display area H, and Display area V aligned with computer input.

Direct Operation

Press Auto button on the remote control or control panel to launch the Auto PC Adj. function.

Menu Operation

- 1 Press the MENU button on remote controller and the OSD displays. Press ▲▼ button to select Display icon. Press ► button or OK button and the Display menu displays.
- 2 Press ▲▼ button to point to Auto PC Adj. option, press OK button to confirm the choice.

Remote control

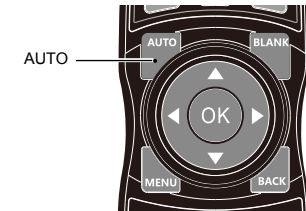

Control Panel

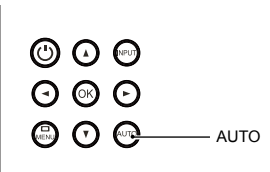

Display menu

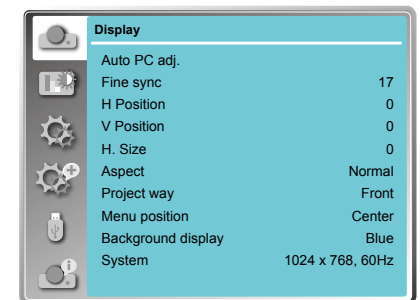

✓ Note:

- The projector executes the Auto PC adjustment automatically when the computer signals input the projector for the first time.
- Auto PC adjustment may not work depending on the model of the computer and the input signal.
- The Auto PC adjustment cannot be operated when 480i, 576i, 480p, 576p, 720p 1080i or 1080p is selected in the "Display" menu → "System", or when the signal is coming from the HDMI terminal.

OSD Setting-Display

Manual computer adjustment

The scan system of the projector may fail to detect signal format used by certain computers as they opted some special signal format. The manual computer adjustment function of the projector enables you to adjust individual parameter to align with most special signal format. The projector comes with up to storage area to keep parameters manually adjusted by you. You may save preferred settings for certain computers as required.

- 1 Press MENU button on the remote controller or control panel and the OSD displays. Press ▲▼ button to select Display icon, press ► button or OK button to confirm the selection.
- 2 Press ▲▼ button to select items for adjustment, press ► button or OK button to confirm the selection. Press ▲▼ button to adjust settings.

Auto PC adj.

Adjust [Fine sync], [H Position], [V Position] and [H Size] automatically.

Auto PC adj. Menu

Auto PC adj.	
Fine sync	17
H Position	0
V Position	0
H. Size	0
Aspect	Normal
Project way	Front
Menu position	Center
Background display	Blue
System	1024 x 768, 60Hz

Fine Sync

Eliminate flashes in image. Press ▲▼ button to adjust Total Dots. (From 0 to 31)

H Position

Press ▲▼ button to adjust horizontal position of image.

V Position

Press ▲▼ button to adjust vertical position of image.

H size

Adjust and minimize the effect of interference caused by projection of patterns consisting of vertical stripes. The projection of the vertical striped pattern may cause cyclic patterns (noise). Adjust to minimize the amount of interference. (From -15 to +15).

Note: H.Size must be set before adjust Fine sync.

Aspect

Press ▲▼ button to select the item to set the screen size to fit the image while maintaining the aspect ratio of the input signal.

Normal.....Projects the image at the maximum size while maintaining the aspect ratio of the input signal.

Wide Projects the image at 16:9 aspect ratio.

Full To provide an image to fit the screen.

Advanced Splicing screen.

*Executing edge blending function

**Only effected with the VGA ans HDMI signal

***Edge blending software and its manual can be downloaded from EIKI website. See page 69 for usage of Edge blending.

Aspect menu

Auto PC adj.	
Fine sync	17
H Position	0
V Position	0
H. Size	0
Aspect	Normal
Project way	Front
Menu position	Center
Background display	Blue
System	1024 x 768, 60Hz

✓ Note:

- The projector executes the Auto PC adjustment automatically when the computer signals input the projector for the first time.
- Auto PC adjustment may not work depending on the model of the computer and the input signal.
- The Auto PC adjustment cannot be operated when 480i, 576i, 480p, 576p, 720p 1080i or 1080p is selected in the "Display" menu → "System", or when the signal is coming from the HDMI terminal.

✓ Note:

- The adjustment of Fine sync, H Position, V Position and H.Size is only for computer signal input.
- The Fine Sync, Total Dots and Clamp function will be disabled if 480i, 576i, 480p, 576p, 720p, 1080i or 1080p has been selected in the system menu.

OSD setting-Display

Project way

Press ▲▼ button to select the project way.

Front Projects to front screen when projector is front standing.

Rear Projects to rear screen when projector is front standing.

Ceiling/Front Projects to front screen when projector is in ceiling state.

Ceiling/Rear Projects to rear screen when projector is in ceiling state.

Auto Ceiling/Front: Projects to front screen when projector is in ceiling state automatically.

Auto Ceiling/Rear: Projects to rear screen when projector is in ceiling state automatically.

Project way menu

Auto PC adj.	
Fine sync	17
H Position	0
V Position	0
H. Size	0
Aspect	Normal
Project way	Front
Menu position	Center
Background display	Blue
System	1024 x 768, 60Hz

Menu position

Press ▲▼ button to select the position of the on screen menu.

Upper left.....Menu locates on upper left of the screen.

Upper right.....Menu locates on upper right of the screen.

CenterMenu locates at the center of the screen.

Lower left.....Menu locates on lower left of the screen.

Lower right.....Menu locates on lower right of the screen.

Menu position

Auto PC adj.	
Fine sync	17
H Position	0
V Position	0
H. Size	0
Aspect	Normal
Project way	Front
Menu position	Center
Background display	Blue
System	1024 x 768, 60Hz

Background display

Press ▲▼ button to select the screen background of the projector when there is no signal detected.

Black Select black background.

Blue Select blue background.

Background display

Auto PC adj.	
Fine sync	17
H Position	0
V Position	0
H. Size	0
Aspect	Normal
Project way	Front
Menu position	Center
Background display	Blue
System	1024 x 768, 60Hz

OSD setting-Display

System

The projector automatically tunes to various types of computers with its function of Multi-scan system and Auto PC Adjustment. If a computer is selected as a signal source, the projector automatically detects the signal format and tunes to project proper images without any additional setting.

One of the following messages may appear when input source as computer:

Auto

When the projector cannot recognize the connected signal conforming to the provided computer system, Auto is displayed on the System menu and the Auto PC Adj. function works to display proper images. If the image is not projected properly, a manual adjustment is required.

There is no signal input from computer. Check the connection between the computer and projector.

System menu

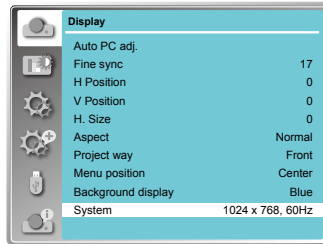

System for computer signal

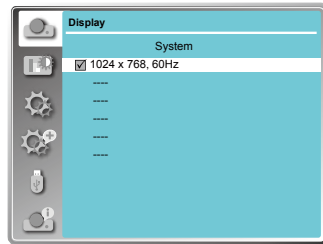

VIDEO or S-Video system menu

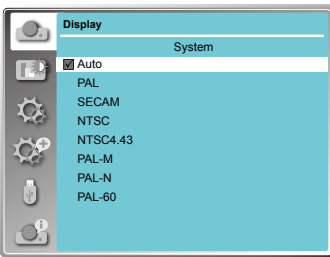

When input source as VIDEO or S-Video

Auto

The projector may auto detect the input video system and adjust to the optimum status. For PAL-M or PAL-N video system, select the system manually.

PAL/SECAM/NTSC/NTSC4.43/PAL-M/PAL-N

If image cannot be displayed correctly, you may need to select one from PAL, SECAM, NTSC, NTSC 4.43, PAL-M and PAL-N for playing.

✓ Note:

- When HDMI, Component, HDBaseT, Network or USB display is selected, System menu for computer is disable.

OSD setting-Color Adjust (HDMI 1, HDMI 2, VGA 1, VGA 2, Memory Viewer, Network and USB Display signal)

Color Adjust

Menu operation

- 1 Press the MENU button on remote controller and the OSD displays. Press ▲▼ button select Color Adjust icon, press ► button or OK button to confirm the selection.
- 2 Press ▲▼ button to point to required item and press OK button to confirm the selection.

Image mode

Switch image mode to fit the image source and the projector.

Dynamic

The light output is secondly maximized.

Standard

The picture becomes suitable for moving images in general.

Bright

The light output is maximized.

Cinema

Enriched grayscale for viewing movies.

Chalkboard (Green)

An image mode designed for displaying on a chalkboard (Green). It boosts quality of image projected on chalkboard (Green).

DICOM

A highly clear X-ray image is reproduced. Digital radiographs with excellent detail and clarity for medical training, presentations and conferences.

Colorboard

Image mode suitable for image projecting on surface of wall in red, blue, yellow or green.

User Image

Default image mode set by users in the Image Adjust menu.

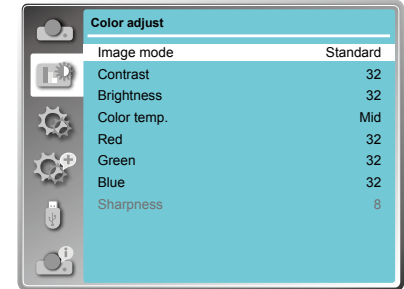

Contrast

Press ▼ button to decrease contrast, press ▲ button to increase contrast.

Brightness

Press ▼ button to decrease brightness, press ▲ button to increase brightness

Color Temp.

Press ▲▼ button to select required color temperature

- High: Blueish image color
- Mid.: Natural image color
- Low: Reddish image color

Red

Press ▼ button to lighten red tint and ▲ button to darken it.

Green

Press ▼ button to lighten green tint and ▲ button to darken it.

Blue

Press ▼ button to lighten blue tint and ▲ button to darken it.

Sharpness

Press ▼ button to soften image and ▲ button to sharpen it.

OSD setting-Color Adjust (Video, Component and S-video signal)

Color Adjust

Menu operation

- 1 Press the MENU button on remote controller and the OSD displays. Press ▲▼ button select Color Adjust icon, press ► button or OK button to confirm the selection.
- 2 Press ▲▼ button to point to required item and press OK button to confirm the selection.

Image mode

Switch image mode to fit the image source and the projector.

Dynamic

The light output is secondly maximized.

Standard

The picture becomes suitable for moving images in general.

Bright

The light output is maximized.

Cinema

Enriched grayscale for viewing movies.

Chalkboard (Green)

An image mode designed for displaying on a chalkboard (Green). It boosts quality of image projected on chalkboard (Green).

DICOM

A highly clear X-ray image is reproduced. Digital radiographs with excellent detail and clarity for medical training, presentations and conferences.

Colorboard

Image mode suitable for image projecting on surface of wall in red, blue, yellow or green.

User Image

Default image mode set by users in the Image Adjust menu.

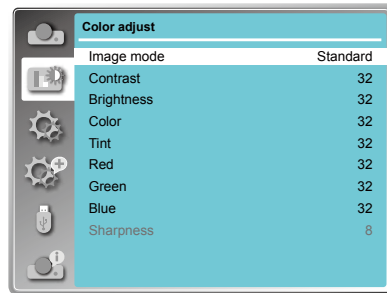

Contrast

Press ▼ button to decrease contrast, press▲ button to increase contrast.

Brightness

Press ▼ button to decrease brightness, press ▲button to increase brightness

Color

Press ▼ to decrease the chroma and ▲to increase it.

Tint

Press ▲▼ to select the appropriate tone for the image.

Red

Press ▼ button to lighten red tint and ▲ button to darken it.

Green

Press ▼ button to lighten green tint and ▲ button to darken it.

Blue

Press ▼ button to lighten blue tint and ▲ button to darken it.

Sharpness

Press ▼ button to soften image and ▲ button to sharpen it.

OSD setting-Setting

Setting

The projector comes with convenient adjustment function.

- 1 Press the MENU button on remote controller and the OSD displays. Press ▲▼ button to select Setting icon, press ► button or OK button to confirm the selection.
- 2 Press ▲▼ button to point to required item and press OK button to confirm the selection.

On start

Setting the projector to be turned on automatically just by connecting the AC power cord.

On Start the projection with countdown immediately.

Off Start up in the standby mode.

Standby mode

Press▲▼ button to select the item below:

Eco..... Restrict some functions in the standby mode to reduce power consumption. In this case, you cannot use network functions and RS-232C commands (expect Power ON).

Normal ... No restrict network and serial communication function via "Wake on LAN" software while the standby mode.

High land

Control the fan speed through the Setting menu.

Off Normal speed. Set it so if the projector is operated at normal altitude.

On Faster speed than the setting as "Off". Set it so if the projector is operated at high altitude.

✓ Note:

- Please change the setting as "ON", while operating the projector at an altitude around 1400~2700m.

Light source control

Change the brightness of the projection.

Normal Normal brightness.

Eco Lower brightness, reducing power consumption and extending the life time of the light source.

Cooling fast

provides the following options in the cooling fans' operation after turning off the projector.

Normal(60 sec) As default cooling time.

30 sec Faster cooling time and louder noise of fan.

0 sec.Allow to unplug the AC power cord immediately without the cooling.

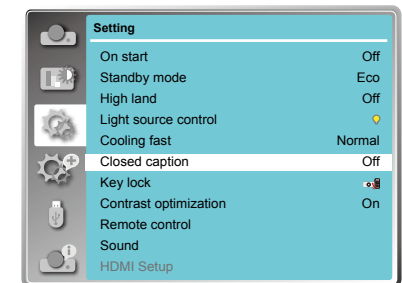
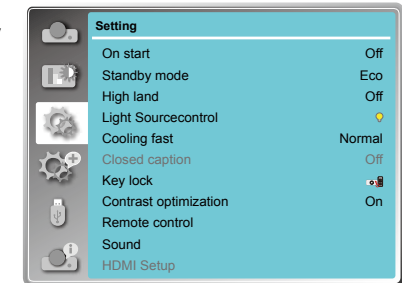

OSD setting-Setting

Closed caption (Video signal only)

Allows the subtitle to be displayed for the audio contents or other information. If the input source contains closed caption, you can enable this function and change the channel. Press ▲▼ to select Off, CC1, CC2, CC3 or CC4.

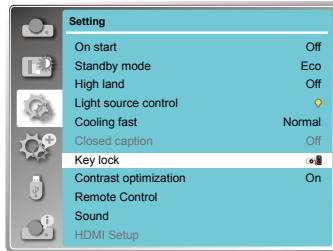

✓ **Note:**

- If the control panel accidentally becomes locked and you do not have the remote control nearby or there is something wrong with the remote control, contact the dealer where you purchased the projector or the service center.
- Closed caption is disable when screen menu or Timer displayed on screen.

Keylock

Set the security for the projector operation.

- Off The control panel and remote controller are effective.
- Projector Lock the operation of the control panel.
- Remote Control Lock the operation of the remote control.

✓ **Note:**

- If you lock the top of the control panel, but without a remote controller or something wrong with the remote controller, please contact the dealer or service center.

Contrast optimization

Select this function to optimize and compensate signal automatically on the basis of the image, to get the best contrast image.

- On Increase the contrast of the image.
- Off Disable this function.

Remote control

Prevent the interference from the remote controller while multiple projectors or video devices are operated at the same time. (default setting is Code 0)

Change code on Projector:

Code 0 ~ code 9 Select the specified ID number to control the individual projectors.

Change code on remote controller:

Press and hold the OK button and one of the number button for 5 seconds to set the code as the number you pressed. The code is set successfully when the light indicator on the remote controller flashed.

- ✓ **Note:** The projector and the remote controller must be paired with the same code.

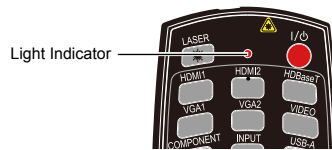
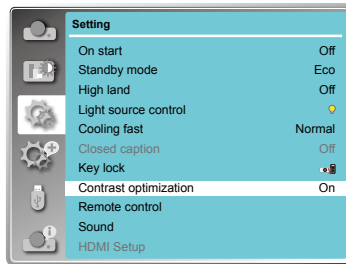

OSD setting-Setting

Sound

Adjust the volume.

Volume Press ▲ button to increase the volume, press ▼ button to decrease the volume.

Mute Press ▼ button to switch mute function. (On/Off)

HDMI setup (HDMI only)

Switch the settings of "Image" or "Sound" in "HDMI setup" menu, if the image is not projected properly.

Image

- 64-940 For the video device.
- 0-1023 For the computer device.

✓ **Note:**

The optimal setting varies depending on the output setting of the connected external device. Refer to the operation instruction of the external device regarding the output of the external device.

Sound

- HDMI The image and audio are transmitted while input signal from video device.
- Computer The audio signal is input by "AUDIO IN" terminal while input signal from computer device.

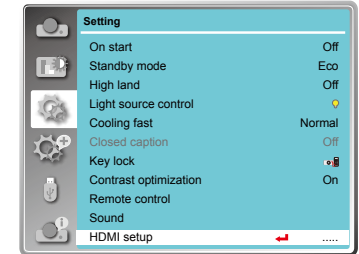

OSD setting-Expand

Expand

Select the Expand menu to set up other functions of the projector.

1. Press the MENU button on remote controller and the OSD displays. Press ▲▼ button to select Expand icon, press ► button or OK button to enter the submenu.
2. Press ▲▼ button to point to required item, press ► button or OK button to confirm the selection.
3. Press ▲▼ button to point to required item, press OK button to confirm the selection.

Language

This projector provides multi-language screen menu.

You can press ▲▼ button to select the language you want: English, German, French, Italian, Spanish, Polish, Swedish, Dutch, Portuguese, Japanese, Simplified Chinese, Traditional Chinese, Korean, Russian, Arabic, Turkish, Finnish, Norwegian, Danish, Indonesian, Hungarian, Czech, Kazakh, Vietnamese, Thai and Farsi.

Expand menu

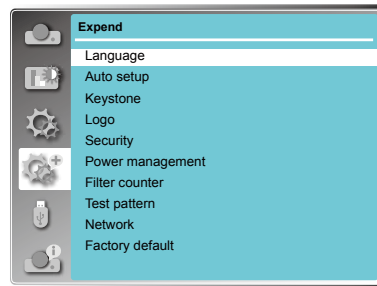

Auto setup

Press AUTO button on the remote control to execute "Input search", "Auto PC adj." and "Auto keystone" functions.

Auto setup

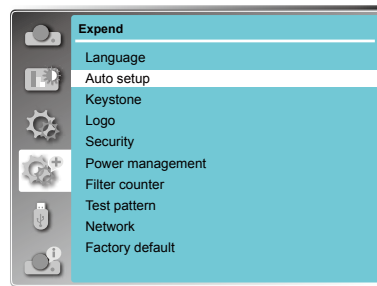

Input search

Allows you to automatically detect input signals. It stops when a signal is found. Press ▲▼ button to select an option below:
On..... Enabled.
Off..... Disabled.

Auto PC adj.

On..... Press the AUTO button on the remote control to enable Auto PC adj. function automatically.
Off..... Disable Auto PC adj. function.

Auto keystone

Auto ... When detecting the projector is tilted, correct the vertical keystone in real time.
Manual When pressing AUTO button on the remote control, perform a vertical keystone.
Off..... Disabled.

✓ Note:

- "Input search", "Auto PC Adj." and "Auto Keystone" cannot be set to "Off" at the same time. At least one of them is set to "On".
- Sometimes the auto keystone maybe correct image imperfectly, manual keystone is required.
- The Auto keystone function cannot work when "Display" → "Project way" is set to "Ceiling/Front" or "Ceiling/Rear".

OSD setting-Expand

Keystone

This function is used to store or reset the keystone correction when the AC power cord is unplugged.

- 1 Press MENU button on the remote control to display screen menu. Press ▲▼ button to select "Expand", then press the OK button.
- 2 Press ▲▼ button to select "Keystone", press the OK button.
- 3 Press ▲▼ button to select the item you want to set, press the OK button.

Keystone menu

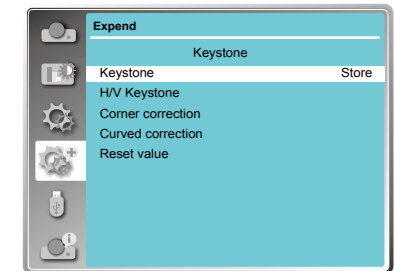

Keystone

Sets whether or not to keep the keystone correction after turn off the projector or plug out the power cord.

- Store.... The keystone correction will be kept when plug out the power cord or turn off the projector.
- Reset... When "Standby mode" is set to "Eco", plug out the power cord or turn off the projector, the keystone correction will be canceled. When "Standby mode" is set to "Normal", plug out the power cord, the keystone correction will be canceled; turn off the projector, the keystone correction will be kept.

H/V Keystone

Adjust when the horizontal or vertical trapezoid of the projected image is distorted.

Reduce the upper width with ▲ button.

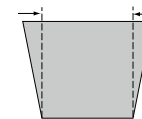

Reduce the lower width with ▼ button.

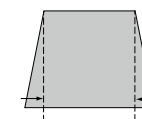

Reduce the left width with ◀ button.

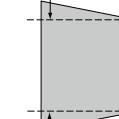

Reduce the right width with ▶ button.

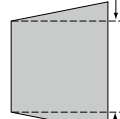

Corner correction

Adjust when the four corners of the projected image are distorted. Press ▲▼◀▶ to adjust the item.

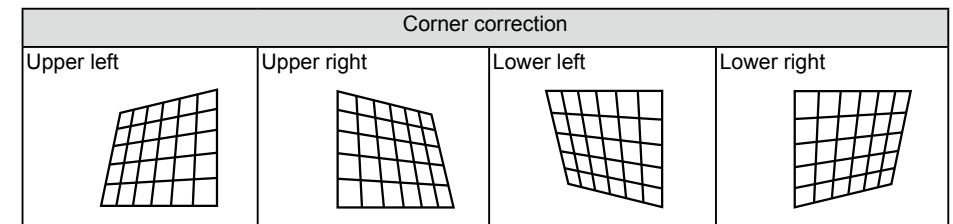

✓ Note:





- The white arrows indicate that there is no correction.
- A red arrow indicates the direction of correction.
- An arrow disappears at the maximum correction.

OSD setting-Expand

Curved correction (for EK-351W only)

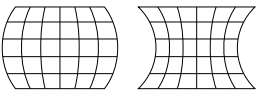
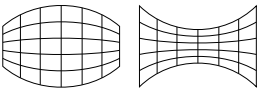
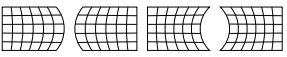
Adjust when the linearity is not uniform or the vertical and horizontal lines are distorted.

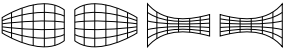
Press ▲ ▼ ◀ ▶ to adjust the item.

Items	Operation	Adjustment
Curved correction - X/Y Gain	Press the ◀ & ▶ button	Adjust the right & left of the width 
	Press the ▲ & ▼ button	Adjust the top & bottom of the width 
Curved correction - X Offset	Press the ◀ / ▶ button	Adjust the left / right of the distortion 
	Press the ▲ / ▼ button	Adjust the top / bottom of the distortion 
Curved Correction - Y Offset	Press the ◀ / ▶ button	Adjust the left / right of the distortion 
	Press the ▲ / ▼ button	Adjust the top / bottom of the distortion 

✓ Note:

- Either "H/V Keystone", "Corner correction" or "Curved correction" setting value is valid. When the "H/V Keystone", "Corner correction" or "Curved correction" adjustment is finished, the adjusted value will be reset when you adjust the other one.
- The "Curved Correction X Offset" and the "Curved Correction Y Offset" can not be adjusted independently. After adjusting the "Curved Correction X/Y Gain" at the beginning, please adjust the "Curved Correction X Offset" and "Curved Correction Y Offset".
- Press the KEystone button on the remote control when the keystone screen is displaying (it includes: H/V Keystone, Corner correction, Curved correction and Reset value), press ▲ ▼ button switch to the other adjustment screen.
- Keep pressing ▲ ▼ ◀ ▶ button for the continuous adjustment and this operation is faster.
- Correcting up to $\pm 30^\circ$ for the tilt in the vertical direction and $\pm 15^\circ$ for the tilt in the horizontal direction are available for adjustments with "Keystone". However, the image quality will degrade and it will get harder to focus with more correction. Install the projector so that the correction will be as small as possible.
- Screen size will also change when "H/V Keystone" is used to perform various adjustments.
- Aspect ratio of the image size may shift depending on the correction.

Reset value

Reset the corrected values to the factory default values.

Press ▲ ▼ to select "Reset value", and then press the OK button, the state of the keystone correction is released.

OSD setting-Expand

Logo

This function allows you to customize the screen logo with Logo select, Capture, Logo PIN code lock and Logo PIN code change functions.

Logo Select

This function decides on the starting-up display from following options.

- Default . Show the factory-set logo.
- *User ... Show the image captured by user.
- Off..... Show the countdown display only.
- *for EK-351W only

Capture (for EK-351W only)

You can capture a projected image as start logo . Select "Capture" and press the OK button on remote control or control panel.

Confirmation dialog box appears, select "Yes" to start capturing.

✓ Note: The captured user logo image is deleted when factory default is executed.

Logo PIN code Lock

This function prevents an unauthorized person from changing the screen logo.

Off The screen logo can be changed freely from the Logo menu.

On The screen logo cannot be changed without a Logo PIN code.

If you want to change the Logo PIN code lock setting, press the OK button and the Logo PIN code dialog box appears. Enter a Logo PIN code by following the steps below. The default PIN code is "111".

Press OK button to enter the PIN code. Press ◀ ▶ button to select a number, and then press the OK button to enter this number, the cursor automatically move to next box. If you fixed an incorrect number, press MENU button to reset it again.

Repeat this step to complete entering a three-digit number.

After entering the three-digit number, the cursor automatically move to "Set", and press the OK button, then you can start to operate the projector.

If you entered an incorrect PIN code, the number (***) turn red, it will be reset automatically within one second. Enter the correct PIN code all over again.

Logo PIN code change

You can change the Logo PIN code (three number). Press the OK button to select Logo PIN code change. Logo Pin code dialog box appears, press ◀ ▶ button to enter the correct PIN code. The New Logo PIN code input dialog box appears. Set a new Logo PIN code, confirmation box appears, select Yes to set the new Logo Pin code.

Be sure to note the new Logo PIN code and keep it on hand. If you lost the number, you could no longer change the Logo PIN code setting.

CAUTION:

WHEN YOU HAVE CHANGED THE LOGO PIN CODE, WRITE DOWN THE NEW PIN CODE IN COLUMN OF THE LOGO PIN CODE NO. MEMO ON PAGE 87, AND KEEP IT SECURELY. SHOULD THE LOGO PIN CODE BE LOST OR FORGOTTEN, THE LOGO PIN CODE SETTING CAN NO LONGER BE CHANGED.

Logo

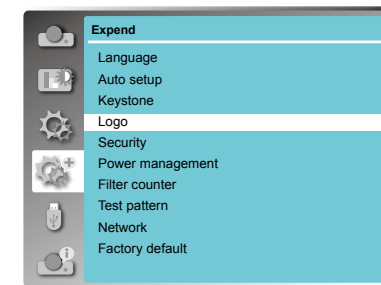

OSD setting-Expand

Security

This function allows you to use the PIN code lock and PIN code change functions to set the security for the projector operation.

PIN code lock

This function prevents the projector from being operated by unauthorized persons and provides the following setting options for security.

OffUnlocked.

OnEnter the PIN code every time turning on the projector. If you want to change PIN code lock setting or PIN code, you must enter the PIN code.

The default PIN code is "111".

If you want to change the PIN code lock setting, press the OK button, then PIN code dialog box appears.

Press ◀▶ button to select a number, and then press the OK button to enter this number, the cursor automatically moves to next box. If you fixed an incorrect number, press MENU button to reset it again. Repeat this step to complete entering a three-digit number.

After entering the three-digit number, the cursor automatically move to "Set", and press the OK button, then you can change the PIN code lock setting.

If you entered an incorrect PIN code, the number (***) turn red, it will be reset automatically within one second. Enter the correct PIN code all over again.

PIN code change

The PIN code can be changed to three-digit number. Press ▲▼ button to select PIN code change. Pin code dialog box appears, Press ◀▶ button to enter the correct code. The New PIN code input dialog box appears. Set a new PIN code.

Security

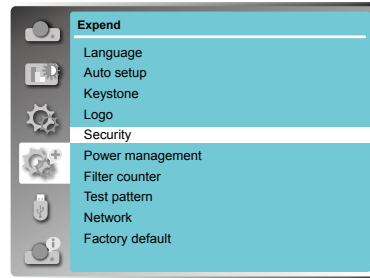

What is a password (PIN)?

A password (PIN) is an ID code for identifying people with knowledge about it to operate the projector. A password (PIN) setting may help preventing the projector from unauthorized use.

Your password (PIN) code is a 3-digit number. To find out more about protecting the projector with a password (PIN), please refer to the PIN Code Lock function in the Setup menu on Page 50 for details.

Precautions on password (PIN) operation

You cannot operate a password (PIN) protected projector without correct password (PIN). Please set up a new password (PIN) and keep the operation manual in safe place. In case the password (PIN) is lost or forgotten, call the dealer or service center.

CAUTION:
WHEN YOU HAVE CHANGED THE PIN CODE, WRITE DOWN THE NEW PIN CODE IN COLUMN OF THE PIN CODE NO. MEMO ON PAGE 87, AND KEEP IT SECURELY. SHOULD THE PIN CODE BE LOST OR FORGOTTEN, THE PIN CODE SETTING CAN NO LONGER BE CHANGED.

OSD setting-Expand

Power management

For reducing power consumption as well as maintaining the LED light source life, the Power management function turns off the projection LED light source when the projector is not operated for a certain period. Select one of the following options:

Ready

When the LED light source has been fully cooled down, the POWER indicator changes to green blinking. In this condition, the projection LED light source will be turned on if the input signal is reconnected or any button on the remote control or control panel is pressed.

Shut down

When the LED light source has been fully cooled down, the power will be turned off.

Off

Disable the Power management function.

Timer

If the input signal is interrupted and no button is pressed for more than 30 seconds, the timer display with No signal appears. It starts the countdown until the LED light source is turned off. Press ▲▼ button to set the Timer(1~30min.)

Ready countdown

Set the time that ready status transfers to standby status automatically.(0-30min. 0 Min: not transfer automatically)

In ready status, press POWER button to switch to standby status, and press any other button to turn on the projector.

Filter counter

This function is used to set a frequency for filter cleaning.

When the projector reached a specified time between cleanings, a Filter warning icon appears on the screen, notifying the cleaning is necessary. After cleaning the filter, be sure to select RESET and set the timer. The Filter warning icon will not turn off until the filter counter is reset.

Filter counter

Display the using time of the filter.

Timer

Set the time to display the warning icon.

Filter counter reset

Reset the filter counter.

Power management

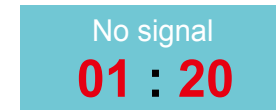

Time left before LED light source is off.

✓ Note:

Factory default: "Timer: 5 min", "Ready countdown: 5 min".

Filter counter

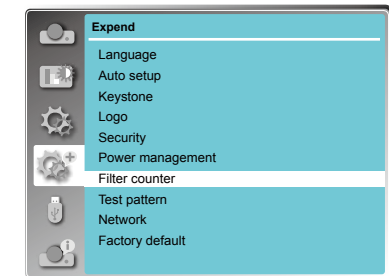

OSD setting-Expand

Test Pattern

This function is used to set the internal test signal: Gray scale 1, Gray scale 2, Gray scale 3, Gray scale 4, Color bar, Red, Green, Blue, Cross hatch, White, Black and Raster gray.

Test Pattern

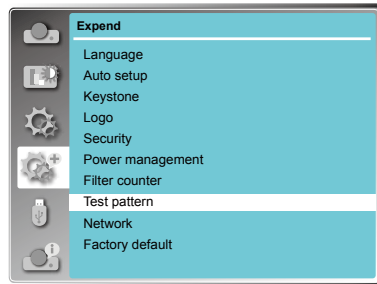

Network

Function : PC controls projector via LAN.

Preparation:

1. Equipments: PC, projector, cables
2. Connection procedures:
Connect the PC to routers or switches of the LAN by direct on cross cable. If it fails to connect PC and projector by parallel cable, please switch to cross cable as suggested.
3. After the computer is booted and the projector is plugged in, indicator lights of LAN interface will flash continuously.

Operation procedures:

- 1 Turn on the projector.
- 2 Obtain network address. DHCP set is displayed as On and obtain network address automatically.(If familiar with network, you can set DHCP as Off and obtain network address manually.)
- 3 Enter network settings menu.

(1) Press MENU button on the remote control to display screen menu. Press ▲▼ button to select Expand, and then press the OK button.

(2) Press ▲▼ button to select Network, and then press the OK button to enter the network menu.

MAC address ... Displays the MAC address of wired network of this projector.

IP addressDisplays the IP address of wired network of this projector.

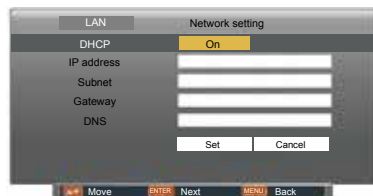
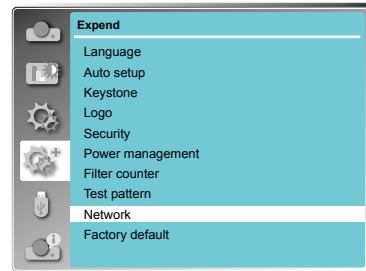

OSD setting-Expand

(3) When DHCP is setting as On, IP address, Subnet, Gateway and DNS will be obtained automatically, press the OK at "Set" to confirm the parameters.

When DHCP is setting as Off, press the OK button to enter IP address, then press ▼ button to enter Subnet, Gateway and DNS respectively, press the OK at "Set" to confirm the parameters.

✓ **Note:**

See page 57 for usage of Network.

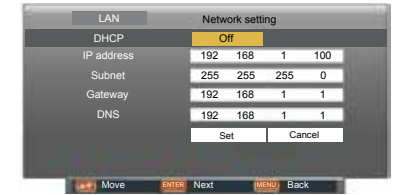

Factory default

This function returns all setting values except for the PIN code lock, Logo PIN code lock, Light source counter and Filter counter to the factory default settings.

✓ **Note:**

The captured user logo image is deleted when factory default is executed.

Factory Default

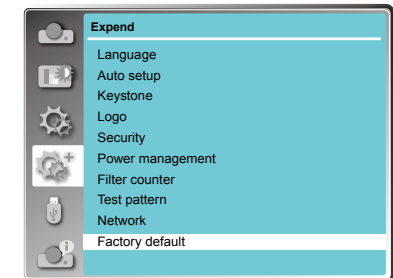

OSD setting-Memory Viewer

Memory Viewer

The Memory Viewer function makes it possible to project the pictures which are stored in the USB memory when the USB memory is inserted into the projector

- 1 Press MENU button on the remote control to display screen menu.
- 2 Press ▲▼ button to select "Memory Viewer", then press the OK button.
- 3 Press ▲▼ button to select the item you want to set, press the OK button.
- 4 Press ▲▼ button to adjust the item, then press the OK button.

Set Slide

Start the slide show.

Slide transition effect

Set the slide transition effect when the slide show image is switching.

Slide down.....Switch the image from the top to the bottom.

Slide right..... Switch the image from the left to the right.

Press▲▼to select "Apply" and press the OK button to execute the setting.

Sort Order

Set the sort order of the slide show.

Extend OrderSort files or folders in extended order.

Size OrderSort files or folders in amount of data order.

Time OrderSort files or folders in stored time order.

Name Order.....Sort files or folders in name order.

Press▲▼to select "Apply" and press the OK button to execute the setting.

Rotate

Set the rotate direction of image.

No Rotate Rotate is disabled.

270 Degrees Rotate 270 degrees in anti-clockwise direction.

180 Degrees Rotate 180 degrees.

90 Degrees Rotate 90 degrees in anti- clockwise direction.

Press▲▼to select "Apply" and press the OK button to execute the setting.

Best Fit

Set the image whether or not to fit with the projected screen.

On.....Display the image to fit with the aspect of the projected screen.

Off.....Display in the normal pixels of the image.

Press▲▼to select "Apply" and press the OK button to execute the setting.

Repeat

Enable or disable repeat function of the slide show.

On.....Display all of the files repeatedly.

Off.....Return to the thumbnail page after the last file is broadcasted.

Press▲▼to select "Apply" and press the OK button to execute the setting.

Apply

Execute the setting in slide show mode.

Press ▲▼ to select "Apply", then press the OK button, the setting of the items except the "Set Slide" will be effective.

Memory Viewer menu

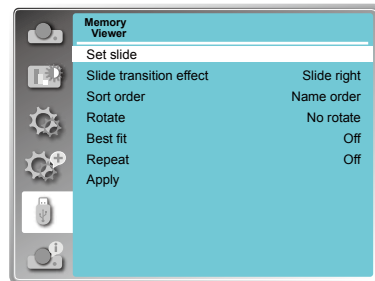

✓ Note:

- The "Memory Viewer" menu is available when select the input source as "Memory Viewer".
- All the setting except "Set Slide" will effective after execute "Apply".
- See page 65 for Memory viewer function.

OSD setting-Info.

Information

The information menu is used to the detect signal of projected image and running state.

Menu operation

Press MENU button on the remote control or control panel to display the screen menu.

Press ▲▼ to select Info., the information menu will appear as the right picture.

The status of projector will display in information menu.

Input

The selected input source is displayed.

H-sync freq .

The horizontal frequency of the input signal is displayed in KHz or - - - -KHz when no signal is detected.

V-sync freq .

The vertical frequency of the input signal is displayed in Hz or - - - - Hz when no signal is detected.

Light source status

The setting status of "Light source mode" is displayed.

Light source counter

The usage time of the light source is displayed.

Power management

The setting status of "Power management" is displayed.

Image mode

The setting status of "Image mode" is displayed.

info. menu

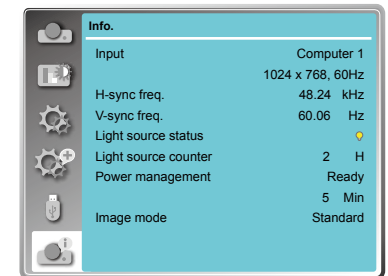

Description on network control operation

LAN control

Function : PC controls projector via LAN.

Preparation:

1. Equipments: PC, projector, cables
2. Connection procedures:

Connect the projector to routers or switches of the LAN by direct on cross cable. If it fails to connect PC and projector by parallel cable, please switch to cross cable as suggested.

3. After the computer is booted and the projector is plugged in, indicator lights of LAN interface and computer interface will flash continuously.

Operation procedures:

- 1 Turn on the projector.
- 2 Obtain network address. DHCP set is displayed as on and obtain network address automatically. If familiar with network, you can set DHCP as close and obtain network address manually.

- 3 Enter network settings menu.

(1) Press MENU button on control panel or remote control to display screen menu. Press ▲▼ button to select "Expand" icon, then press the OK button.

(2) Press ▲▼ button to select "Network" setting and press the OK button enter the network setting.

(3) Press ▲▼ button to set DHCP as on.

(4) Press ▲▼ button to "Set" and press the OK button. "Please wait..." appears.

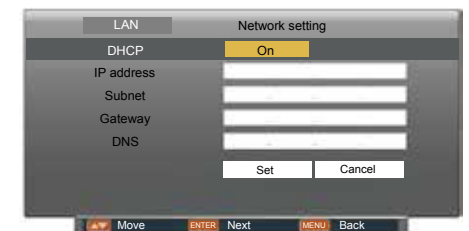
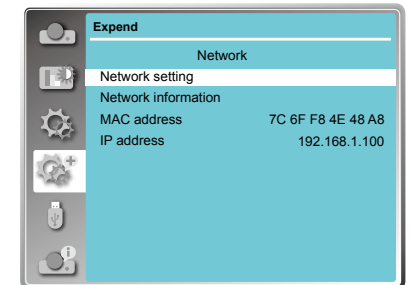

Description on using
useful function

Description on network control operation

4. Activate the Web browser in the personal computer.
5. Enter the IP address set by the projector into the URL input field of the Web browser.
6. Select "Login" to login the Network Display System page. (Both the initial name and passwords are "admin".)



✓ **Note:**

- You can click the upper right corner of the web browser screen to select the display language.
- Do not perform setting or control simultaneously by starting up multiple web browsers. Do not set or control the projector from multiple computers.
- Change the password first. (8 half-width characters).
- If the screen for the web control is not displayed, consult the network administrator.

7. Items in Network Display System page including: "System Status", "General Setup", "Picture Setup", "Image Setup" and "Network Setup".



- | | |
|-------------------------------------------------------------------------------------------------------------------------------------------------------------------------------------------------------------------------------------------------------------------------|-----------------------------------------------------------------------------------------------------------------------------------------------------------------------------|
| <p>① System Status
The "System Status" page is displayed by clicking this item.</p> <p>② General Setup
The "General Setup" page is displayed by clicking this item.</p> <p>③ Picture Setup
The "Picture Setup" page is displayed by clicking this item.</p> | <p>④ Image Setup
The "Image Setup" page is displayed by clicking this item.</p> <p>⑤ Network Setup
The "Network Setup" page is displayed by clicking this item.</p> |
|-------------------------------------------------------------------------------------------------------------------------------------------------------------------------------------------------------------------------------------------------------------------------|-----------------------------------------------------------------------------------------------------------------------------------------------------------------------------|

Description on network control operation

"System Status" page

Display the status of the projector for the following items.

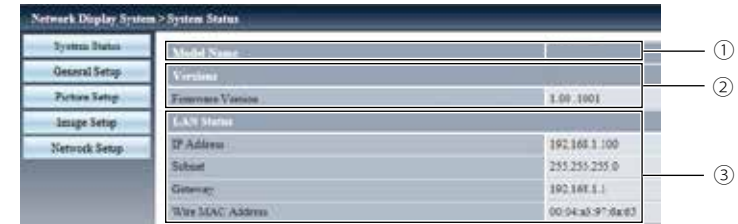

- | | |
|-----------------------------------------------------------------------------------------------------------------------------------------------|--------------------------------------------------------------------|
| <p>① Model Name
Displays the model No. of the projector.</p> <p>② Versions
Displays the version of the firmware of the projector.</p> | <p>③ LAN Status
Displays the connection status of the LAN.</p> |
|-----------------------------------------------------------------------------------------------------------------------------------------------|--------------------------------------------------------------------|

"General Setup" page

Change Password for Webpage is displayed.



- | | |
|-------------------------------------------------------------------------------------------------------------------------------------------------------------------------------------------------------------------|--------------------------------------------------------------------------------------------------------------------------------------------------------------------------------|
| <p>① Enter Old password
Enters the configured password.</p> <p>② Enter New password
Enters the new password.</p> <p>③ Confirm New password
Enters the wanted new password again for confirmation.</p> | <p>④ Apply
Updates the settings.</p> <p>⑤ Power
Switches on/off the power of the projector.</p> <p>⑥ Source Select
Switches the input source of the projector.</p> |
|-------------------------------------------------------------------------------------------------------------------------------------------------------------------------------------------------------------------|--------------------------------------------------------------------------------------------------------------------------------------------------------------------------------|

"Picture Setup" page

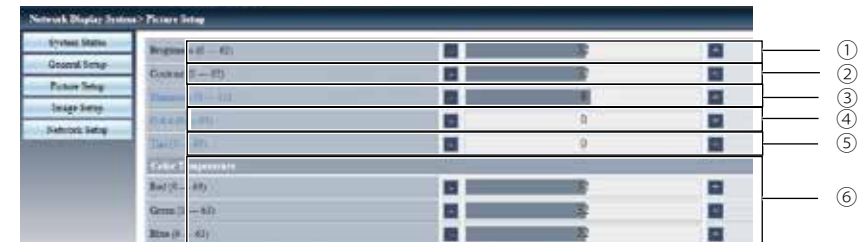

Description on network control operation

- ① Brightness
Adjusts the brightness of the projected image.
- ② Contrast
Adjusts the contrast of the projected image.
- ③ Sharpness
Adjusts the sharpness of the projected image.
- ④ Color
Adjusts the color saturation of the projected image.
- ⑤ Tint
Adjusts the skin tone of the projected image.
- ⑥ Color Temperature
Adjusts the color temperature of the projected image.

"Image Setup" page

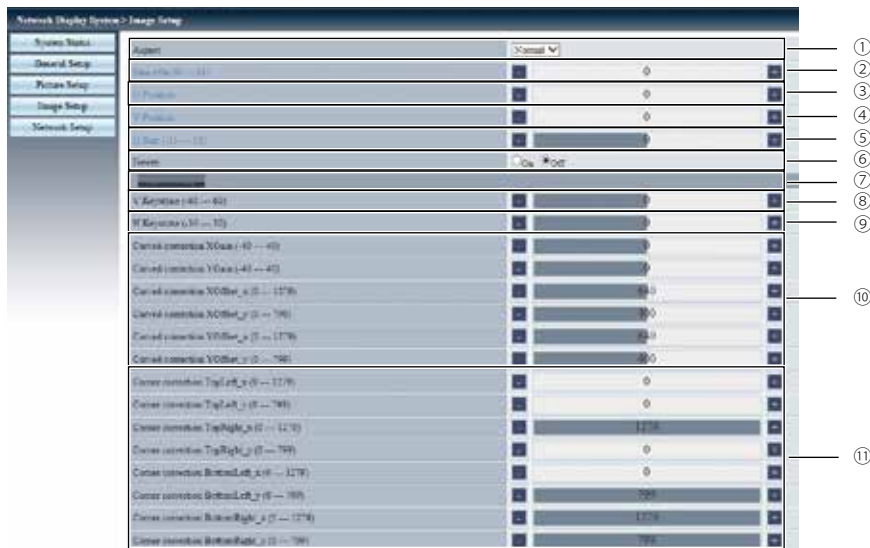

- ① Aspect
Switches the aspect of the projected image.
- ② Fine sync
Adjusts the fine sync of the projected image.
- ③ H Position
Adjusts the horizontal position of the projected image.
- ④ V Position
Adjusts the vertical position of the projected image.
- ⑤ H.Size
Adjusts the total number of dots of the projected.
- ⑥ Freeze
Switches the freeze function between on and off.
- ⑦ Auto PC adj.
Executes the Auto PC adj. function.
- ⑧ V Keystone
Corrects the keystone in vertical direction.
- ⑨ H Keystone
Corrects the keystone in horizontal direction.
- ⑩ Curved Correction (for EK-351W only)
Corrects the pincushion or barrel of the projected image.
- ⑪ Corner correction
Corrects the four corners of the projected image.

Description on network control operation

"Network Setup" page



- ① LAN Setup
Select [Obtain an IP address automatically] if you want to enable the DHCP client.
- ② Apply
Updates the settings.
- Gateway
Enter the default gateway address when not using a DHCP server.
- IP Address
Enter the IP address when not using a DHCP server.
- DNS
Enter the DNS server when not using a DHCP server.
- Subnet
Enter the subnet mask when not using a DHCP server.

Description on network display operation

Network Display function

1. PwPresenter software: when "Network" is selected in Source Select, you can project the current computer images via network.

Input the IP address of the projector in webpage to enter the Network Display System, click "Download" to download the PwPresenter software according to the operation system.



2. Launch the pwPresenter software.

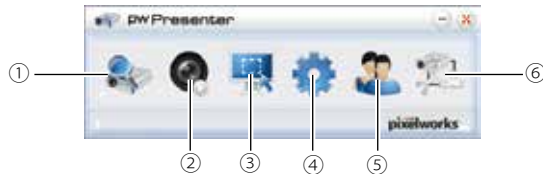

① Search for projector display
Click to enter Search, select the projector and connect it. Please setting the same IP address of the projector in pwPresenter software, (such as: 192.168.1.100). Both the initial name and passwords are "admin".



✓Note:

- Before use PwPresenter software to search, you need change Source Select to "Network".

Description on network display operation

- ② Play/Pause
Play or pause the selected image.
- ③ Choose capture mode
Choose a capture mode from "Full Screen", "Fixed Size" or "Alterable."
- ④ Parameters Setting
Basic Setting
Setting language, region of capture image etc.



Advanced Setting
Setting image quality, network port etc.



Global Setting
Setting remote control, capture by audio or screen etc.



Description on network display operation

Multicast Setting

Setting Sound volume, Bandwidth and Capture rate etc.



⑤ Network Display Management

Setting device and password management.



⑥ Disconnect the projector.

Description on using Memory Viewer function

Memory Viewer function

The Memory Viewer function is used to project the pictures which are stored in the USB memory when the USB memory is inserted into USB A(VIEWER) terminal of the projector.

Memory Viewer function supports the following image files.

	Extension	Format	Description
Picture	jpg/jpeg	Baseline encoder 24 bit	Max. resolution : 10000 x 10000
		Progressive RGB 24 bit	Max. resolution : Panel Resolution
	bmp	1, 4, 8 bit Palette-based RGB 24, 32 bit	Max. resolution : 1280 x 800
	png	24, 48 bit True color	24 bit color palette space Max. resolution : 1024 x 768
	gif	1, 4, 8 bit Palette-based	Max. resolution : 800 x 600
	tiff	—	Max. resolution : 800 x 600

Display the Memory Viewer screen

1. Press the INPUT button on the remote control or on the control panel to select the input source as Memory Viewer.
2. Insert the USB memory into the USB-A terminal of the projector directly, the standby screen of please press RC ENTER appears when the USB memory icon is displayed on the screen.
3. Press the OK button on the remote control, the root directory of the USB memory will appear in thumbnail on the screen.

Play the pictures

It will display a picture when play the picture manually every time.

1. Press ▲▼◀▶ to select a file on the thumbnail screen.
2. Press the OK button, the picture will display on the full screen.
3. Press ▶ to switch to the next picture, press ◀ to return to the previous picture.
4. Press the OK button on the remote control to return to thumbnail screen.

Executing the slide

All pictures in the same folder will play automatically when "Slide Transition Effect" of "Memory Viewer" menu is set to the special setting.

1. Press ▲▼◀▶ to select a file.
2. Press the "MENU" button to select the "Memory Viewer" → "Set Slide".
3. Press the OK button.
 - The picture will display on the full screen.
 - Press the OK button to return to the thumbnail screen.

Description on using Memory Viewer function

Play the PDF

Playing the PDF file.

press ▲▼◀▶ to select a PDF file and press the OK button, playing the PDF on the full screen.



▲ ▼	Displays the previous or next page.
◀ 5 5 ▶	The page number increases or decreases by 5 pages.
◀ ▶	The page number increases or decreases by 1 page.
GO 1	Jumps to page number directly.
	Switches PDF file between full screen display or whole page display.
	Switches the display size on 3 levels of magnification. Press ▲▼ on the remote control to move the display screen up and down.
	Remove the display screen up, down, left and right by ▲▼◀▶ button on the remote control.
	Exit the PDF file, and return to the thumbnail screen.

Termination of the Memory Viewer

1. Press ▲▼◀▶ to the thumbnail which is displayed on the upper left corner.
2. Press the OK button on the remote control to return to the standby screen of Press "OK".
3. Remove the USB memory directly.

Description on using USB display function

USB Display function

The USB Display function is used to project the image from the computer which is connected to Micro-USB(DISPLAY) terminal of the projector by a USB converting cable.

■ When using Windows

Windows operation environment

OS	Windows 7 32/64 bit, Windows 8 32/64 bit, Windows 8.1 and Windows 10
CPU	Intel Core 2 Duo 2.0 GHz or faster, the compatible processor
Amount of memory	256 MB or more (Recommended : 512 MB or more)
Hard-disk free space	20 MB or more
Display	Resolution 640 x 480 or more, 1 600 x 1 200 or less

- There is no guarantee for all computers that meet the above conditions will operate properly.

Projecting the USB Display

1. Connect the Micro-USB terminal of the projector to a computer with a USB converting cable.
2. Press the Input button on the remote controller or control panel to switch the input source as USB Display.
 - The startup screen will be displayed automatically due to the driver which is built-in the projector, and executes the installation according to the instructions of the screen. The displaying of the auto installation screen depends on the setting of computer. At this time, please select "Run autorun.exe". Please double-click "autorun.exe" in the folder of the USB Display when the automatically startup is disabled.
 - The image on the computer screen is projected.
3. Click the driver icon in the task bar of computer and select one item in Pop-up menu.
 - Pop-up menu is only displayed in English.
 - The item which is displayed in gray is unavailable.

Active audio/ Disable audio	Set whether to output the audio from the computer.
Play video/ Pause video	Switch between play and pause the image.
Start/Stop	Set whether to display the image from the computer.
Exit	Exit USB Display.

✓Note:

- The driver is not installed in the computer, and it will be removed from the computer when disconnecting the USB cable.
- It will take a while when you want to project the computer screen.
- Connect a USB cable directly to the USB connector of a computer. It will not work when connecting through a USB hub.

Termination of the USB display

When terminate the USB display, remove the USB cable directly. There is no need to follow "Remove hardware safely" when a USB cable is disconnected.

Description on using USB display function

■ When using Mac OS

Mac OS operating environment

OS	Mac OS X 10.5, 10.6, 10.7 or newer version
CPU	Power PC G4 1GHz or faster
Amount of memory	512 MB or more
Hard-disk free space	20 MB or more
Display	Resolution 640 x 480 or more, 1 600 x 1 200 or less

- There is no guarantee for all computers that meet the above conditions will operate properly.

Projecting the USB Display

1. Connect the Micro-USB terminal of the projector to a computer with a USB converting cable.
2. Press the INPUT button on the remote control or Control panel to switch the input source to USB Display.
 - The image on the computer screen is projected.
3. Double-click "Monitor.app" in the virtual disk that has been mounted.
4. Right-click the driver icon  in the dock of computer and select one item in Pop-up menu.
 - Pop-up menu is only displayed in English.
 - The item which is displayed in gray is unavailable.

Active audio/ Disable audio	Set whether to output the audio from the computer.
Play video/ Pause video	Switch between playing and pausing the image.
Start/Stop	Set whether to display the image from the computer.
Quit	Terminate the USB Display.

✓Note:

- It will take a while when you want to project the computer screen.
- Connect a USB cable directly to the USB connector of a computer. It will not work when connecting through a USB hub.

Termination of the USB display

When terminate the USB display, remove the USB cable directly.

Description on using Edge Blending function

Edge Blending

Edge Blending function could project bigger and brighter with high resolution pictures via multi projector. The Edge Blending software could adjust the color and the effect of the overlay edge.

Equipment:

2 or more projector with same resolution, Video duplicator, RS232 series cable.

Connection:

- (1)Setting the projectors with the same level from ground and the same projection distance from screen.
- (2)Project the image through the video duplicator to each projector.
- (3)Connect the computer and projectors via RS232 cable.

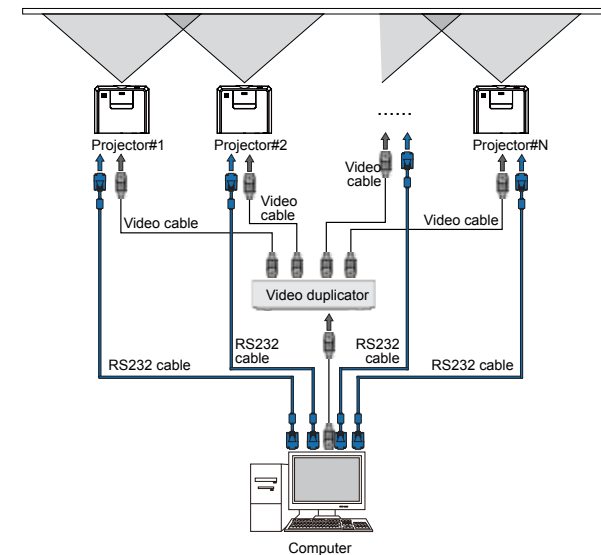

Setting:

- (1)Setting the projected image as the same dimension by each projector.
- (2)Press Menu button on the remote controller or control panel to pop up the OSD.
- (3)Press ▲▼ button to select "Display"
- (4)Press ▲▼ button to select "Aspect"
- (5)Press ▲▼ button to select "Advanced" and press OK to ready for Edge Blending function.

Adjustment:

The color and effect of the overlay edge can be adjusted with the Edge Blending software.

The Edge Blending Software and its manual can be downloaded from EIKI website.

URL: <http://www.eiki.com>

✓ Note:

- Edge Blending function can only effected with the same resolution projectors.
- Edge Blending function can apply via HDMI, VGA and RGBHV as input source.
- Setting the same level and position with the same dimension image would make the better effect after edge blending adjustment.

Regular maintenance

Status light indicator

The STATUS indicator shows status of projector protection function. Check STATUS and POWER indicator for good maintenance operation.



Note:
Unplug the AC power cord in case of any abnormality as it may lead to fire or electric shock.

The projector turns off and the STATUS indicator flashing orange.

The projector powers off automatically to protect its internal components when it is overheated. The POWER indicator flashing while the projector is cooling down. Press the STANDBY button to power the projector on again when it is cooled down to normal operation temperature.

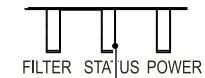

The STATUS indicator flashing orange

✓ **Note:**

The POWER indicator stops flashing when the projector's internal temperature cooled down to normal and it is ready to powered on again.

Check the following:

- Is adequate clearance provided for the projector's ventilation? Check the installation status and any air outlet block.
- Is the projector installed at location close to outlet of air conditioning equipment? Keep the projector away from air outlet of air conditioning equipment.
- Is the filter in clean condition? Please clean the filter regularly.

The projector powers off and the STATUS indicator turns orange.

The STATUS indicator turns orange and the projector powers off to protect its internal components whenever an abnormality is detected. Unplug the AC power cord and connect again. Restart the projector and run checkup routine. If the problem persists, unplug the AC power cord and call the service center for checkup and maintenance.

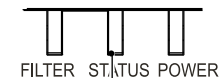

The status indicator turns orange

Maintenance

This chapter describes the regular maintenance procedure of the projector to ensure its optimal operation status for long.

Regular maintenance

Clean the projector when it is contaminated by foreign matter or its display effects are getting worse.



Note:

Unplug the AC power cord before any cleaning operation.

Clean the lens

Wipe the lens with clean cloth dampened with non-abrasive camera lens cleaner or clean it with lens cleaning paper or air blower.

Do not over apply cleaner to the lens. Abrasive cleaner, solution, or other rough chemical may scratch the lens.

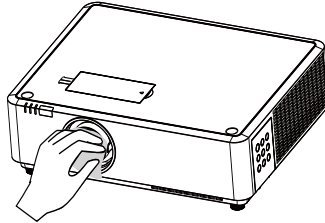

Clean casing of the projector

Wipe the casing surface with clean and soft cloth. Gently wipe the casing with clean and soft cloth dampened with small amount of neutral detergent to remove heavy dirt. Do not over apply cleaner to the casing. Abrasive cleaner, solution, or other rough chemical may scratch the casing surface.

Place the projector in proper container after use to protect it from dirt and dust and being scratched.

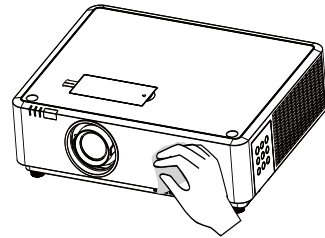

Clean the filter

The filter is designed to keep dust from entering in the projector, which may lead to dusts accumulated on surface of internal components. Clogged filter may reduce cooling fan effects, which, in turn, will overheat the projector and shorten its life cycle. Clean the filter immediately whenever the Filter Warning icon displays.

Please follow these steps to clean the filter:

- 1 Power off the projector and unplug from AC power source.
- 2 Remove the control panel by release the screw on it.
- 3 Remove the filter by release the screw on the filter case.
- 3 Gently clean it with a brush.
- 4 Insert the filter. Make sure it has been fully inserted.

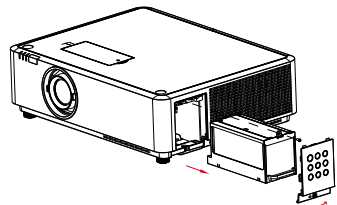

Note:

Do not operate the projector after its filter is removed. Dust may attach to the lens assembly and deteriorate image quality.

Regular maintenance

Reset the filter counter

- 1 Press MENU button and the OSD displays. Press ▲▼ button to select Expend menu, press ► button or OK.
- 2 Press ▲▼ button to select "Filter Counter", press ► button or OK. Press ▲▼ button to select "Filter counter reset" and press OK. The "Filter counter reset?" message displays.
- 3 In another pop-up dialog box, select Yes to reset the filter counter.

Recommendations

Please do not use the projector at place of dust and smoke. That may affect image quality. Using the projector in place of dust and smoke may lead to piling dusts on lens, LCD panel, and lens components within it. In case like this, call the dealer or service center for correct cleaning.

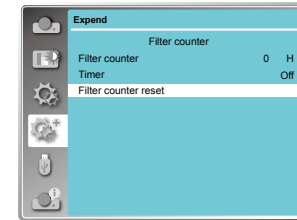

Note:

Reset the filter counter after its cleaning or replacement.

Order Replacement Filter

Replacement Filter can be ordered through the dealer. When ordering a projection filter, give the following information to the dealer.

Replacement Model No.: 63220132 (Filter Box)

Troubleshooting

Check the following before calling the dealer or service center:

Troubleshooting	Solution
Power on failure	<ul style="list-style-type: none"> – Plug the power cord of the projector in an AC socket. – Make sure the POWER indicator turns red. – Restart the projector until the POWER indicator turns red. It indicates the projector is ready for power on again. – Disable the Key Lock function of the projector.
Logo screen display failure	<ul style="list-style-type: none"> – Make sure the setting is not "Off" of "Logo select" function in the Expand Menu on OSD.
The Logo screen differs from the standard settings.	<ul style="list-style-type: none"> – Make sure you did not select "User" or "Off" of "Logo select" function in the Expand Menu on OSD.
Input signal switch (or do not switch) automatically.	<ul style="list-style-type: none"> – Make sure you have correctly set up the Input Search function.
Press INPUT button during power on and a non-input mode icon displays.	<ul style="list-style-type: none"> – This is a filter or light source replacement alerts.
A non-input or light source mode icon displays.	<ul style="list-style-type: none"> – This is a filter replacement alerts.
Image looks fuzzy	<ul style="list-style-type: none"> – Adjust focus of the projector. – Provide proper projection distance. – The projection lens requires cleaning. – Moving the projector from a colder environment to a hotter one may result in condensing on the lens. If this is the case, wait until the condensing water evaporated before powering on the projector.
Image mirror reflected	<ul style="list-style-type: none"> – Check the Ceiling and Rear settings.
Image turns upside down	<ul style="list-style-type: none"> – Check the Ceiling settings.
Image looks dim	<ul style="list-style-type: none"> – Check for contrast and brightness settings. – Check for correct image mode settings.
No image displays	<ul style="list-style-type: none"> – Check for the connection between the projector and computer or image equipment. – Check for correct input signal setting from computer. While connected with laptop may mandate changes to its display output settings. See the user manual included with the computer for details on settings. – It takes about 5 seconds for the projector to show the first image. – Check the setting mode of signal, color system, image system, or computer system. – Make sure the ambient temperature is within given range (41°F–95°F; 5°C–35°C). – Image does not display in BLANK mode. Press the BLANK button or other buttons on the remote controller.

Appendix

Abnormal color	<ul style="list-style-type: none"> – Check the setting mode of signal, color system, image system, or computer system. – Make sure Blackboard mode is not selected in Image selection.
Some operations are invisible	<ul style="list-style-type: none"> – Check the display function.
Auto PC Adjusting function failure	<ul style="list-style-type: none"> – Check the input signal. Auto PC Adjusting function is unavailable in 480p, 576p, 720p, 480i, 576i, 1080i or 1080p mode.
Settings do not save after power off	<ul style="list-style-type: none"> – Make sure you have selected Store after settings adjustment. Certain settings do not keep without selecting Store.
Power management failure	<ul style="list-style-type: none"> – In case of Freeze or Blank operation, the power management function does not work.
Auto Setting does not work	<ul style="list-style-type: none"> – Make sure it is not set to "Off" in each selection. – Make sure setted "Auto Ceiling" in Ceiling function.
Image distorted or disappeared	<ul style="list-style-type: none"> – Check and revise the Display menu or Keystone menu.
A password prompt displays after power on	<ul style="list-style-type: none"> – You have select the Logo PIN Code lock function
Remote controller does not work	<ul style="list-style-type: none"> – Check the battery. – Make sure there is no obstacles stand in between the projector and the remote controller. – Make sure the remote controller is not too far away from the projector. The maximum operation range is 5m. – Make sure the remote controller and the projector are paired with the same remote control codes. – Disable the key lock on remote controller function in the Safety option of the Setting menu.
Indicator turns on or flashes	<ul style="list-style-type: none"> – Check status of the projector according to the table of indicator status.
Exclamation mark displays	<ul style="list-style-type: none"> – Invalid operation, please operate the projector correctly.
Control panel does not function	<ul style="list-style-type: none"> – Disable the key lock on control panel function in the Safety option of the Setting menu.
Cannot unlock the Logo Select password, Key Lock, and PIN Code lock	<ul style="list-style-type: none"> – Please call the dealer or service center.

- Make sure the projector is correctly connected to external equipment.
- Make sure all devices have plugged in an AC power source and have been powered on.
- If the projector fails to project image of the connected computer, restart the computer.

































Warning:







The projector employs high voltage power for operation. Do not open its casing. If the problem persists, call the dealer or service center report with model number of the projector and a description to the problem. You will be advised on getting our services.

Appendix

Light indicator status

Check light indicator to learn status of the projector.

Light indicator			Status of the projector
POWER Green /Red / Orange	STATUS	FILTER	
			The projector is in Off status (without AC power supply).
			The projector is in standby status. Press Standby button to turn it on.
			The projector is in normal status.
			It is ready for standby or the LED light source is cooling. You may power on the projector only after the LED light source is fully cooled and the POWER light indicator stops flashing.
			The projector is in Ready mode.
			The projector detects abnormal situation and cannot power on. Unplug the AC power cord and connect it again before powering on the projector. If it powers off again, please unplug the cord and call the dealer or service center for maintenance or inspection. Do not let it continue operating as this may lead to electric shock or fire.
			The projector detects LED light source abnormality and cools down.
			The projector detects LED light source abnormality and switches into standby mode.
			The projector cannot power on, as its internal temperature is too high. You may power it on after it is fully cooled, temperature backs to normal, and the POWER light indicator turns red.
			You may power is fully cooled with temperature backs to normal.
			The filter requires cleaning

-  ... Green
-  ... Red
-  ... Orange
-  ... Turns off
-  ... Flashing green
-  ... Flashing red
-  ... Flashing orange

Appendix

Compatible computer screen

The projector is designed to accept every analog computer signal below Dot Clock 160MHz and digital computer signal below Dot Clock 150MHz.
See table below for details on resolution and relevant frequency.



No.	Display	Source				Specification		
		VGA	Component	HDMI	Video/ S-Video	H-Freq.(KHz)	V-Freq.(Hz)	Pixel clock (MHz)
1	NTSC	--	--	--	○	15.734	59.940	--
	NTSC-443	--	--	--	○			
	PAL-60	--	--	--	○			
	PAL-M	--	--	--	○			
2	PAL	--	--	--	○	15.625	50.000	--
	PAL-N	--	--	--	○			
	SECAM	--	--	--	○			
3	720x480i,60Hz	○	○	--	--	15.734	59.940	13.500
4	720x480i,60Hz	--	--	○	--	15.734	59.940	27.000
5	720x576i,50Hz	○	○	--	--	15.625	50.000	13.500
6	720x576i,50Hz	--	--	○	--	15.625	50.000	27.000
7	720x483,60Hz	○	○	--	--	31.469	59.940	27.000
8	720x576,50Hz	○	○	--	--	31.250	50.000	27.000
9	1280x720p,60Hz	○	○	--	--	45.000	60.000	74.250
						44.955	59.940	74.176
10	1280x720p,50Hz	○	○	--	--	37.500	50.000	74.250
11	1920x1080i,60Hz	○	○	--	--	33.750	60.000	74.250
						33.716	59.940	74.176
12	1920x1080i,50Hz	○	○	--	--	28.125	50.000	74.250
13	1920x1080p,24Hz	--	--	○	--	27.000	24.000	74.250
						26.970	23.980	74.176
14	1920x1080p,60Hz	○	○	○	--	67.500	60.000	148.500
						67.433	59.940	148.352
15	1920x1080p,50Hz	○	○	--	--	56.250	50.000	148.500
16	640x480,60Hz	○	--	--	--	31.469	59.940	25.175
17	640x480,67Hz	○	--	--	--	35.000	66.667	30.240
18	640x480,72Hz	○	--	--	--	37.861	72.809	31.500
19	640x480,75Hz	○	--	--	--	37.500	75.000	31.500
20	640x480,85Hz	○	--	--	--	43.269	85.008	36.000
21	800x600,56Hz	○	--	--	--	35.156	56.250	36.000
22	800x600,60Hz	○	--	--	--	37.879	60.317	40.000
23	800x600,72Hz	○	--	--	--	48.077	72.188	50.000
24	800x600,75Hz	○	--	--	--	46.875	75.000	49.500
25	800x600,85Hz	○	--	--	--	53.674	85.061	56.250
26	832x624,75Hz	○	--	--	--	49.725	74.550	57.283
27	1024x768,60Hz	○	--	--	--	48.363	60.004	65.000
28	1024x768,70Hz	○	--	--	--	56.476	70.069	75.000
29	1024x768,75Hz	○	--	--	--	60.023	75.029	78.750
30	1024x768,85Hz	○	--	--	--	68.678	84.997	94.500
31	1152x864,70Hz	○	--	--	--	63.995	70.020	94.200
32	1152x864,75Hz	○	--	--	--	67.500	75.000	108.000
33	1280x720,60Hz	○	--	--	--	44.772	59.855	74.500
34	1280x768,60Hz	○	--	--	--	47.776	59.870	79.500
35	1280x768,75Hz	○	--	--	--	60.289	74.893	102.250
36	1280x768,85Hz	○	--	--	--	68.630	84.840	117.500
37	1280x800,60Hz	○	--	--	--	49.702	59.810	83.500
38	1280x800,75Hz	○	--	--	--	62.795	74.934	106.500
39	1280x800,85Hz	○	--	--	--	71.554	84.880	122.500
40	1280x960,60Hz	○	--	--	--	60.000	60.000	108.000
41	1280x1024,60Hz	○	--	--	--	63.981	60.020	108.000
42	1280x1024,72Hz	○	--	--	--	78.160	71.970	135.060
43	1280x1024,75Hz	○	--	--	--	79.976	75.025	135.000
44	1280x1027,85Hz	○	--	--	--	91.146	85.024	157.500
45	1366x768,60Hz	○	--	--	--	47.720	59.799	84.750
46	1400x1050,60Hz	○	--	--	--	65.317	59.978	121.750
47	1400x1050,75Hz	○	--	--	--	82.278	74.867	156.000
48	1440x900,60Hz	○	--	--	--	55.935	59.887	106.500
49	1600x900,60Hz	○	--	--	--	55.920	60.000	118.998
50	1600x1200,60Hz	○	--	--	--	75.000	60.000	162.000
51	1680x1050,60Hz	○	--	--	--	65.290	59.954	146.250
52	1920x1080,60Hz	○	--	--	--	66.587	59.934	138.500
53	1920x1200,60Hz	○	--	--	--	74.038	59.950	154.000

* ○ *Available -- *Disisable

✓ **Note:**
Changes to this manual may be made without notice.

Appendix

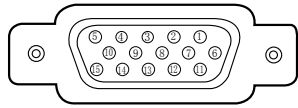
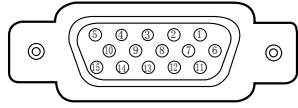
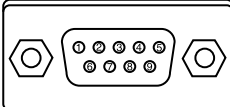
Terminal configuration

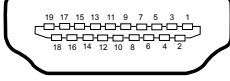
VGA IN / Component / S-Video Terminal (D-sub 15)				
	1	Red/Pr/S-C input	9	----
	2	Green/Y/S-Y input	10	Grounding (field synchronizing)
	3	Blue/Pb/- input	11	Grounding
	4	----	12	DDC data
	5	Grounding (line synchronizing)	13	Horizontal synchronizing (compound sync.) input
	6	Grounding(red)	14	Vertical synchronizing input
	7	Grounding(green)	15	DDC Clock
	8	Grounding(blue)		
VGA OUT Terminal (D-sub 15)				
	1	Red (Input/output)	9	----
	2	Green (Input/output)	10	Grounding (field synchronizing)
	3	Blue (Input/output)	11	Grounding
	4	----	12	DDC data
	5	Grounding (line synchronizing)	13	Horizontal synchronizing (compound sync.) input / output
	6	Grounding(red)	14	Vertical synchronizing input / output
	7	Grounding(green)	15	DDC Clock
	8	Grounding(blue)		
SERIAL Terminal (D-SUB 9)				
	1	----	6	----
	2	RXD	7	----
	3	TXD	8	----
	4	----	9	----
	5	GND		
LAN Terminal				
 87654321	1	TX +	5	----
	2	TX -	6	RX -
	3	RX +	7	----
	4	----	8	----
HDBaseT Terminal				
 87654321	1	HDBT_P0	5	HDBT_P2
	2	HDBT_N0	6	HDBT_N2
	3	HDBT_P1	7	HDBT_P3
	4	HDBT_N1	8	HDBT_N3
HDMI Terminal (HDMI Type A 19)				
	1	TMDS Data2+	11	TMDS Clock Shield
	2	TMDS Data2 Shield	12	TMDS Clock-
	3	TMDS Data2-	13	CEC
	4	TMDS Data1+	14	Reserved (N.C. on device)
	5	TMDS Data1 Shield	15	SCL
	6	TMDS Data1-	16	SDA
	7	TMDS Data0+	17	DDC/CEC Ground
	8	TMDS Data0 Shield	18	+5V Power
	9	TMDS Data0-	19	Hot Plug Detect
	10	TMDS Clock+		

Appendix

Menu tree

Main menu	Sub-menu	Setting	Default value	Remarks
Display	Auto PC adj.			
	Fine sync	0-31	0	
	H Position	-5 - +5	0	
	V Position	-5 - +5	0	
	H Size	-15 - +15	0	The range of H Size differs from signals.
	Aspect	Normal Wide Advanced Full	Normal	
	Project way	Front Rear Ceiling / Front Ceiling / Rear Auto ceiling / Front Auto ceiling / Rear	Front	
	Menu position	Upper Left, Upper Right Center Lower Left, Lower Right	Upper Left	
	Background display	Black Blue	Blue	
	System	Auto PAL SECAM NTSC NTSC4.43 PAL-M PAL-N PAL-60	verify by input source	S-Video Input Video Input
Color adjust	Image mode	Standard Dynamic Bright User Image Cinema Blackboard (Green) DICOM Colorboard	Standard	
	Contrast	0-63	32	PC Input
	Brightness	0-63	32	
	Color temp	High/Mid/Low	Mid	
	Red	0-63	32	
	Green	0-63	32	
	Blue	0-63	32	
	Sharpness	0-15	8	

Appendix

Main menu	Sub-menu	Setting	Default value	Remarks	
Color adjust	Contrast	0-63	32	Component Input S-Video Input Video Input	
	Brightness	0-63	32		
	Color	0-63	32		
	Tint	0-63	32		
	Red	0-63	32		
	Green	0-63	32		
	Blue	0-63	32		
	Sharpness	0-15	8		
Setting	On start	On/Off	Off		
	Standby Mode	Normal/Eco mode	Eco		
	High land	On/Off	Off		
	Light source control	Normal/ECO mode	Normal		
	Cooling fast	60sec/30sec/0sec	0sec		
	Closed caption	Off/CC1/CC2/CC3/CC4	Off		
	Key lock	Off/Projector/Remote controller	Off		
	Contrast optimization	On/Off	Off		
	Remote control	Code 0-9	Code 0		
	Sound	Volume	0-25	12	
		Mute	On/Off	Off	
	HDMI Setup	Image	64-940 0-1023	0-1023	
		Volume	HDMI	HDMI	
PC			PC		
Expand	Language	Projector provides multiple language support	English		
	Auto Setup	Input Search	On/Off	On	
		Auto PC Adj.	On/Off	On	
		Auto Keystone	Off	Off	
			AUTO Manual	AUTO	
	Keystone	Keystone	Store / Reset	Store	
		H/V Keystone			
		Corner correction			
		*Curved correction			*This function is disable on EK-350U
		Reset value			
	Logo	Logo select	Default/*User/Off	Default	*This function is disable on EK-350U
		*Capture			*This function is disable on EK-350U
		Logo PIN Code Lock	On/Off	Off	
Logo PIN Code Change					

Appendix

Main menu	Sub-menu	Setting	Default value	Remarks	
Expand	Security	PIN code lock	On/Off	Off	
		PIN code change			
	Power management	Ready		Ready	
		Shut down			
		Off			
		Timer Ready Countdown			
	Filter counter	Filter counter		Off	
		Timer	Off, 500H, 1000H, 2000H		
		Filter counter reset			
	Test pattern	Off, Gray scale (1-4), Color bar, Red, Green, Blue, Cross hatch, White, Black, Raster gray		Off	
	Network	Network setting	LAN		
DHCP(On/Off)			Off		
IP address					
Subnet			255.255.255.0		
Gateway			192.168.1.1		
DNS		192.168.1.1			
Network status	MAC address				
	IP address	192.168.1.100			
Factory default					
Memory Viewer	Set slide				
	Slide transition effect	Slide down Slide right	Slide right		
	Sort order	Extend name order Size order Time order Name order	Name order		
	Rotate	No rotate 270° Degree 180° Degree 90° Degree	No rotate		
	Best fit	On/Off	Off		
	Repeat	On/Off	Off		
	Apply				

Appendix

Main menu	Sub-menu	Setting	Remarks
Info.	Input		
	H- sync. Freq.		
	V- sync. Freq.		
	Light source status		
	Light source counter		
	Power management		
	Image mode		

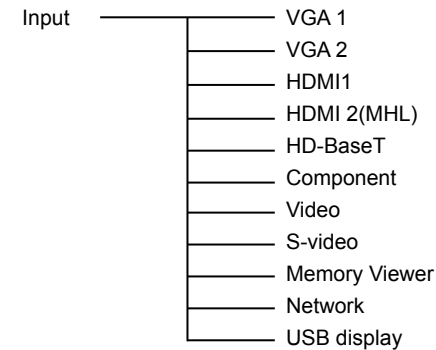

Appendix

Technical Specifications

Mechanical properties

Dimensions (W×H×D)	460mmx355mmx143mm
Net Weight	10.0 Kg
Adjustable foot	5°

LCD resolution

LCD system	0.76" TFT
LCD resolution	EK-350U:1920x1200 / EK-351W:1280x800

Compatible signals

Color standard	PAL, SECAM, NTSC, NTSC4.43, PAL-60, PAL-M and PAL-N
HDTV signal	480i, 480p, 576i, 576p, 720p, 1080p and 1080i
Scanning frequency	Horizontal frequency: 15–100 KHz; Vertical frequency: 48–85 Hz

Optical elements

Image size (diagonal lines)	40"-300"
Projection distance	Wide: 0.928m ~ 7.172m / Tele: 1.523m ~ 11.605m
Lens (Standard Lens)	F = 1.65~2.25 / f =18.2~29.38mm; Zoom ratio: 1.6x
LED light source power	420W (Normal)
Contrast Ratio	50000:1 @ lens shift 1:1
Aspect Ratio	16:10

Terminal

VGA IN 1	Mini D-sub 15 pin x1
VGA IN 2/YpPr/S-VIDEO IN	Mini D-sub 15 pin x1
VGA OUT	Mini D-sub 15 pin x1
HDMI	HDMI A type 19 pin x2(one is compatible with MHL)
LAN	RJ45 x1, 100 Base-TX (100Mbps)/10 Base-T (10Mbps)
HDBaseT	RJ45 x1 HDMI (Video, Audio), RS-232C, 100 Base-TX (100Mbps)/10 Base-T (10Mbps)
USB connector	USB-A x1, Micro-USB x1
AUDIO	3.5mm Mini Type Stereo x2, RCA (L/R) x2
VIDEO	RCA x1
RS232 terminal	D-sub 9 pin x1

Power

Voltage and power consumption	AC 100–240 V (Max 5.5A), 50/60 Hz
Fuse	10A/250V
Internal speaker	10W RMS 8ohm, *2

Operating Environment

Operating temperature	0°C-40°C
Storage Temperature	-20°C-60°C)
High land	2700 m

Remote control

Battery	AA or LR6 1.5V ALKALINE TYPE x 2
Operating Range	5 m/±30°
Dimensions	48mm (W) x 26mm (H) x 160mm (D)
Net Weight	67g (including batteries)

Accessories

Safety Guide	AC power cord (US type x 1, Euro type x 1)
Quick Start Guide	VGA cable
Remote control and batteries	

- The aforesaid specification is subject to change without prior notice.
- Liquid crystal panel is made on the basis of high standard, where 99.99% of the pixels are effective. Due to the nature of the liquid crystal panel, a fraction of the pixels (0.01% or less) may be ineffective.

Appendix

Chemical Substances table

Component name	Harmful substances					
	Pb	Hg	Cd	Cd(vi)	PBB	PBDE
PCB	×	○	○	○	○	○
Optical components	×	○	○	○	○	○
Projection lens	○	○	○	○	○	○
Projection light source	○	○	○	○	○	○
Outer casing	×	○	○	○	○	○
Internal mechanical parts	×	○	○	○	○	○
Remote control	×	○	○	○	○	○
Annex	○	○	○	○	○	○

This table is made according to SJ/T 11364 specifications.

- The contents of toxic and hazardous substances in all homogeneous materials of this part is below the limit requirement in GB/T 26572.
 - ×
- × The contents of toxic and hazardous substances in at least one of the homogeneous materials of this part is above the limit requirement in GB/T 26572 .

Appendix

Dimensions

Unit: mm

↳ Screw Holes for Ceiling Mount
Screw: M4
Depth: 10.0

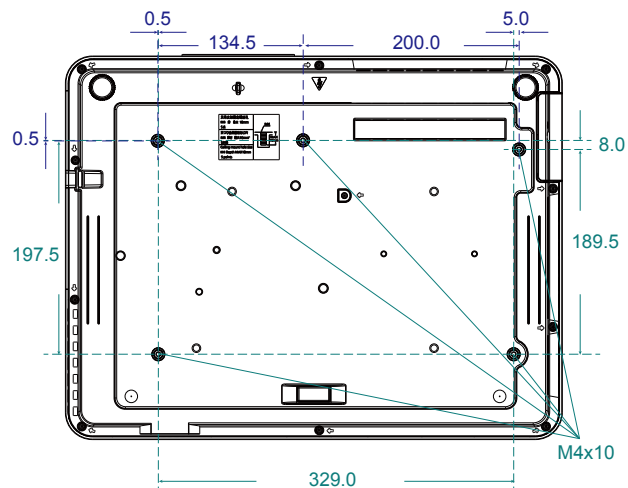
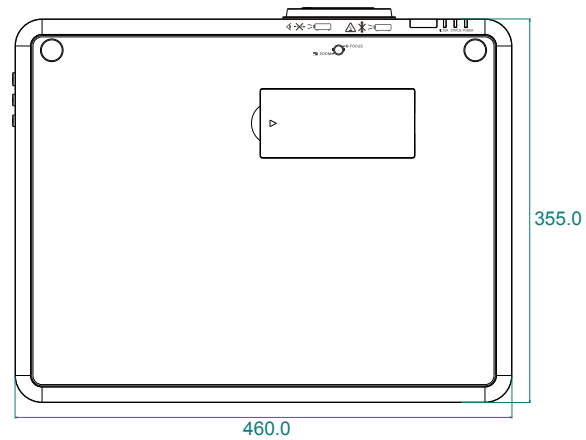
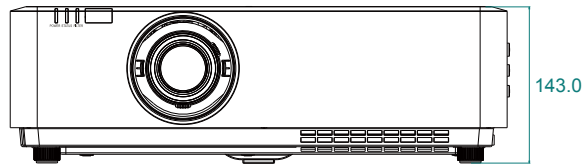

Appendix

PIN code memorandum

Write down the PIN code in the blank below and keep it, If you forgot or lost the number and unable to operate the projector, contact the service center.

Factory default PIN code 111*

PIN code lock

--	--	--

Factory default PIN code 111*

Logo PIN code Lock No.

--	--	--

*If this 3-digit number is changed, the factory default number will be ineffective.

EIKI

U.S.A.

EIKI International, Inc.
30251 Esperanza
Rancho Santa Margarita
CA 92688-2132, U.S.A.
Tel: +1 800-242-3454
+1 949-457-0200
Fax: +1 800-457-3454
+1 949-457-7878
E-Mail: usa@eiki.com

Deutschland & Österreich

EIKI Deutschland GmbH
Am Frauwald 12
65510 Idstein, Deutschland
Tel: +49 6126-9371-0
Fax: +49 6126-9371-11
E-Mail: info@eiki.de

China

EIKI (Shanghai) Co., Ltd.
LAKESIDE OASIS MIDDLE RING
BUSINESS CENTRE
Block 1, Room 606,
1628, Jin Sha Jiang Road
Shanghai, 200333, CHINA
China
Tel: +86 21-3251-3993
Service Hot line: +86 21-3251-3995
Fax: +86 21-3251-3997
E-mail: info@eiki-china.com

Oceania

EIKI AUSTRALIA PTY LTD
Level 5, 11 Queens Road,
Melbourne, Victoria 3004, Australia
Tel: +61 03-8530-7048
Fax: +61 03-9820-5834
E-Mail: sales@eiki.net.au

Canada

EIKI CANADA
Eiki International, Inc.
Canadian Branch
9170 County Road 93, Suite 304,
Midland, ON, L4R 4K4, Canada
Tel: +1 800-563-3454
+1 705-527-4084
E-Mail: canada@eiki.com

Eastern Europe

EIKI CZECH SPOL. s.r.o.
Branicka 416/237 140 00 Praha 4
Czech Republic
Tel: +420 241-410-928
+420 241-403-095
Fax: +420 241-409-435
E-Mail: info@eiki.cz

South East Asia

EIKI Industrial (M) Sdn Bhd
No. 11, Nouvelle Industrial Park,
Lorong Teknologi B, Taman Sains
Selangor 1, Kota Damansara PJU5,
47810 Petaling Jaya,
Selangor Darul Ehsan, Malaysia
Tel: +60 3-6157-9330
Fax: +60 3-6157-1320
E-Mail: sales@eiki.my

Japan & Worldwide

EIKI Industrial Company Limited.
6-23 Teramoto, Itami-shi, Hyogo,
664-0026, Japan
Tel: +81 72-782-7492
Fax: +81 72-781-5435

World Wide Website <http://www.eiki.com>