

ViewSonic®

PJ558D DLP Projector



ViewSonic®

- User Guide
- Guide de l'utilisateur
- Guía del usuario
- Guia do usuário
- 使用手冊
- 使用手冊

Model No. : VS11529

Compliance Information

For U.S.A.

This device complies with part 15 of FCC Rules. Operation is subject to the following two conditions: (1) this device may not cause harmful interference, and (2) this device must accept any interference received, including interference that may cause undesired operation. This equipment has been tested and found to comply with the limits for a Class B digital device, pursuant to part 15 of the FCC Rules. These limits are designed to provide reasonable protection against harmful interference in a residential installation. This equipment generates, uses, and can radiate radio frequency energy, and if not installed and used in accordance with the instructions, may cause harmful interference to radio communications. However, there is no guarantee that interference will not occur in a particular installation. If this equipment does cause harmful interference to radio or television reception, which can be determined by turning the equipment off and on, the user is encouraged to try to correct the interference by one or more of the following measures:

- Reorient or relocate the receiving antenna.
- Increase the separation between the equipment and receiver.
- Connect the equipment into an outlet on a circuit different from that to which the receiver is connected.
- Consult the dealer or an experienced radio/TV technician for help.

Warning: You are cautioned that changes or modifications not expressly approved by the party responsible for compliance could void your authority to operate the equipment.

For Canada

- This Class B digital apparatus complies with Canadian ICES-003.
- Cet appareil numérique de la classe B est conforme à la norme NMB-003 du Canada.

CE Conformity for European Countries

 The device complies with the requirements of the EEC directive 89/336/EEC as amended by 92/31/EEC and 93/68/EEC Art.5 with regard to “Electromagnetic compatibility”, and 73/23/EEC as amended by 93/68/EEC Art.13 with regard to “Safety.”

Following information is only for EU-member states:

The mark shown to the right is in compliance with the Waste Electrical and Electronic Equipment Directive 2002/96/EC (WEEE).

The mark indicates the requirement NOT to dispose the equipment as unsorted municipal waste, but use the return and collection systems according to local law.



Important Safety Instructions

1. Read these instructions completely before using the equipment.
2. Keep these instructions in a safe place.
3. Heed all warnings.
4. Follow all instructions.
5. Do not use this equipment near water. Warning: To reduce the risk of fire or electric shock, do not expose this apparatus to rain or moisture.
6. Clean with a soft, dry cloth. If further cleaning is required, see “Cleaning the Display” in this guide for further instructions.
7. Do not block any ventilation openings. Install the equipment in accordance with the manufacturer’s instructions.
8. Do not install near any heat sources such as radiators, heat registers, stoves, or other devices (including amplifiers) that produce heat.
9. Do not attempt to circumvent the safety provisions of the polarized or grounding-type plug. A polarized plug has two blades with one wider than the other. A grounding type plug has two blades and a third grounding prong. The wide blade and the third prong are provided for your safety. If the plug does not fit into your outlet, consult an electrician for replacement of the outlet.
10. Protect the power cord from being tread upon or pinched, particularly at the plug, and the point where it emerges from the equipment. Be sure that the power outlet is located near the equipment so that it is easily accessible.
11. Only use attachments/accessories specified by the manufacturer.
12. Use only with the cart, stand, tripod, bracket, or table specified by the manufacturer, or sold with the equipment. When a cart is used, use caution when moving the cart/equipment combination to avoid injury from tipping over. 
13. Unplug this equipment when it will be unused for long periods of time.
14. Refer all servicing to qualified service personnel. Service is required when the unit has been damaged in any way, such as: if the power-supply cord or plug is damaged, if liquid is spilled onto or objects fall into the unit, if the unit is exposed to rain or moisture, or if the unit does not operate normally or has been dropped.

Declaration of RoHS Compliance

This product has been designed and manufactured in compliance with Directive 2002/95/EC of the European Parliament and the Council on restriction of the use of certain hazardous substances in electrical and electronic equipment (RoHS Directive) and is deemed to comply with the maximum concentration values issued by the European Technical Adaptation Committee (TAC) as shown below:

Substance	Proposed Maximum Concentration	Actual Concentration
Lead (Pb)	0.1%	< 0.1%
Mercury (Hg)	0.1%	< 0.1%
Cadmium (Cd)	0.01%	< 0.01%
Hexavalent Chromium (Cr ⁶⁺)	0.1%	< 0.1%
Polybrominated biphenyls (PBB)	0.1%	< 0.1%
Polybrominated diphenyl ethers (PBDE)	0.1%	< 0.1%

Certain components of products as stated above are exempted under the Annex of the RoHS Directives as noted below:

Examples of exempted components are:

1. Mercury in compact fluorescent lamps not exceeding 5 mg per lamp and in other lamps not specifically mentioned in the Annex of RoHS Directive.
2. Lead in glass of cathode ray tubes, electronic components, fluorescent tubes, and electronic ceramic parts (e.g. piezoelectronic devices).
3. Lead in high temperature type solders (i.e. lead-based alloys containing 85% by weight or more lead).
4. Lead as an alloying element in steel containing up to 0.35% lead by weight, aluminium containing up to 0.4% lead by weight and as a copper alloy containing up to 4% lead by weight.

Copyright Information

Copyright © ViewSonic® Corporation, 2006. All rights reserved.

Macintosh and Power Macintosh are registered trademarks of Apple Computer, Inc.

Microsoft, Windows, Windows NT, and the Windows logo are registered trademarks of Microsoft Corporation in the United States and other countries.

ViewSonic, the three birds' logo, OnView, ViewMatch, and ViewMeter are registered trademarks of ViewSonic Corporation.

VESA is a registered trademark of the Video Electronics Standards Association. DPMS and DDC are trademarks of VESA.

PS/2, VGA and XGA are registered trademarks of International Business Machines Corporation.

Disclaimer: ViewSonic Corporation shall not be liable for technical or editorial errors or omissions contained herein; nor for incidental or consequential damages resulting from furnishing this material, or the performance or use of this product.

In the interest of continuing product improvement, ViewSonic Corporation reserves the right to change product specifications without notice. Information in this document may change without notice.

No part of this document may be copied, reproduced, or transmitted by any means, for any purpose without prior written permission from ViewSonic Corporation.

Product Registration

To meet your future needs, and to receive any additional product information as it becomes available, please register your product on the Internet at: www.viewsonic.com. The ViewSonic Wizard CD-ROM also provides an opportunity for you to print the registration form, which you may mail or fax to ViewSonic.

For Your Records

Product Name:	PJ558D ViewSonic DLP Projector
Model Number:	VS11529
Document Number:	PJ558D-1_UG_ENG Rev. 1A 07-12-06
Serial Number:	_____
Purchase Date:	_____



The lamp in this product contains mercury.

Please dispose of in accordance with local, state or federal laws.

Safety Instructions

Read all of these instructions before you operate your projector and save for future reference.

1. Check that the operating voltage of your unit is identical with the voltage of your local power supply.

2. Should any liquid or solid object fall into the cabinet, unplug the unit and have it checked by the qualified personnel before operating it further.

3. Do not attempt to service this product yourself, as opening or removing covers may damage the components inside and will void your warranty.

4. Do not place this product on an unstable cart, stand, or table. The product may fall, causing serious damage to the product.

5. Unplug the unit from the wall socket if it is not to be used for several days. To disconnect the cord, pull it out by the plug. Never pull the cord itself.

6. The wall socket should be near the unit and easily accessible.

7. Do not place the projector where the cord can be stepped on as this may result in fraying or damage to the lead or the plug. Be alert to tripping hazards.

8. Never look into the projector lens when the lamp is switched on as the bright light can damage your eyes. Never let children look into the lens when it is on.

9. Do not place your hand or objects near the ventilation holes. The air coming out is hot.

10. Never open any covers on the projector except the lamp cover. Dangerous electrical voltages inside the projector can cause severe injury. Except as specifically directed in this User's Manual, do not attempt to service this product yourself. Refer all servicing to qualified service personnel.

11. Unplug the projector from the wall socket before cleaning. Use a damp cloth for cleaning the projector housing. Do not use liquid or aerosol cleaners.

12. Keep the plastic packing materials (from the projector, accessories and optional parts) out of the reach of children as these bags may result in death by suffocation. Be particularly careful around the small children.



13. For ventilation reasons, the fan continues to operate after the projector has been powered off. Please do not unplug the power cord until the fan stops.

14. The projector is equipped with ventilation holes (intake) and ventilation holes (exhaust). Do not block or place anything near these slots, or internal heat build-up may occur, causing picture degradation or damage to the projector.

15. When you replace the projector lamp, never touch the new bulb with your bare hands. The invisible residue left by the oil on your hands may shorten the bulb life. Use lint-free gloves or finger cots are recommended.

16. The product should be situated away from heat sources such as radiators, heat registers, stoves, or other products (including amplifiers) that produce heat.

17. Do not overload wall outlets, extension cords, or integral convenience receptacles as this can result in a risk of fire or electric shock.

Notes on AC Power Cord

AC Power Cord must meet requirement of country where you use a projector. Confirm an AC plug type with graphics below and proper AC Power Cord must be used. If supplied AC Power Cord does not match your AC outlet, contact your sales dealer.

This projector is equipped with a grounding type AC line plug. Make sure that your outlet fits the plug. Do not defeat the safety purpose of this grounding type plug. We highly recommend using a video source device also equipped with a grounding type AC line plug to prevent from signal interference due to voltage fluctuation.

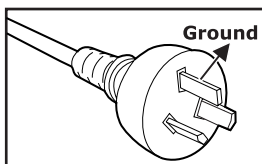

For Australia and
Mainland China

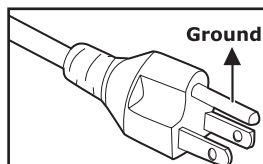

For the U.S.A. and Canada

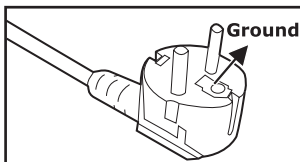

For Continental Europe

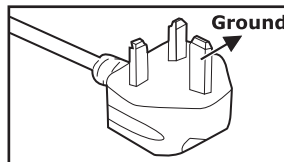

For the U.K.



CONTENTS

Product Introduction	5
Projector Features	5
Package Contents	6
Getting to Know the Projector	7
Projector Components	7
Remote Control Components	10
Installation	11
Connecting the Projector	11
Powering On/Off the Projector	12
Adjusting the Projected Image	13
Adjusting the Projector Zoom and Focus	14
Adjusting Projection Image Size	14
Using the Projector	16
Control Panel	16
Remote Control	17
Battery Replacement	17
Remote Control Operation	18
Menu Options	19
Color (Computer/Video Mode)	20
Image (Computer Mode)	22
Image (Video Mode)	23
Management (Computer/Video Mode)	24
Audio (Computer/Video Mode)	25
Language	26
Maintenance	27
Cleaning the Lens	27
Cleaning the Projector Housing	27
Replacing the Lamp	28
Specifications	30
Appendix	31
Indicator Messages	31
Preset Signals	32
Troubleshooting	33

Product Introduction

Projector Features

The projector integrates high-performance optical engine projection and a user-friendly design to deliver high reliability and ease of use.

The projector offers the following features:

- Single chip 0.55" Texas Instruments DLP™ technology
- XGA (1024 x 768 pixels)
- Compact size, light weight for portability
- 1.2x manual zoom lens
- Auto image re-sizing (Auto-Sync.) to 1024 x 768 full screen with scaling compression compatibility for VGA, SVGA, XGA and SXGA*.
- State-of-the-art motion adaptive hardware deinterlacing with 3:2 pull down
- Compatibility with Macintosh® computers
- Compatibility with NTSC, PAL, SECAM, and HDTV
- Multi-function remote control
- D-Sub 15-pin cable for analog video connectivity
- User-friendly, multi-language on-screen display (OSD)
- Advanced electronic keystone correction



* means compressed.



Package Contents

When you unpack the projector, make sure you have all these components:

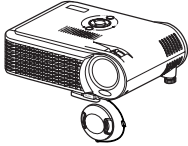

Projector with Lens Cap

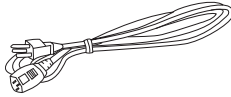

AC Power Cord

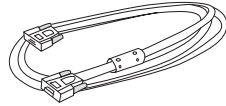

VGA Cable (D-SUB to D-SUB)



S-Video Cable

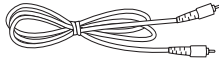

Composite Video Cable



Audio Cable



Remote Control (IR)
with Lithium battery



Projector
Carrying Case



User's Manual



Quick Start Guide

Optional Accessory:

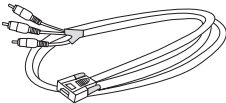

VGA (D-SUB) to
HDTV (RCA) Cable

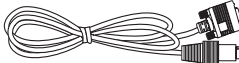

RS232 Cable



USB Cable



- Save the original shipping carton and packing material; they will come in handy if you ever to ship your unit. For maximum protection, repack your unit as it was originally packed at the factory.
- Accessories and components may vary by retailer and region.
- Lithium battery is loaded in the remote control. Remove the transparent insulation tape by pulling it before use.

Getting to Know the Projector

Projector Components

Front View

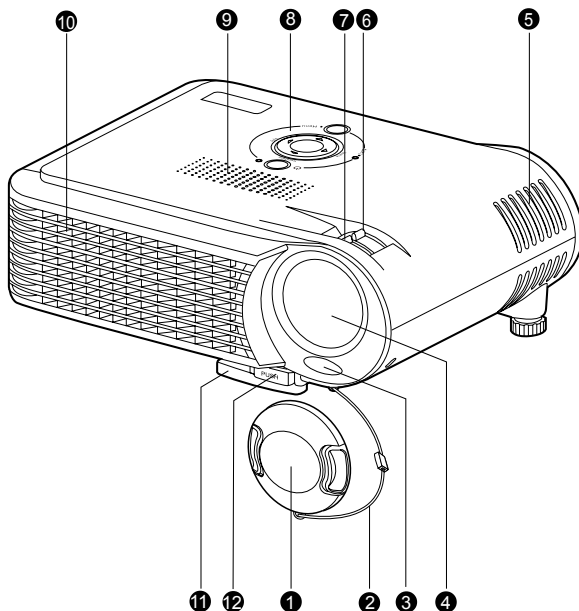

- | | |
|--|---------------------------------------|
| 1. Lens cap _____ | 7. Focus ring _____ |
| 2. Lens cap strap _____ | 8. Control panel _____ |
| 3. Front IR remote control
sensor _____ | 9. Speaker _____ |
| 4. Lens _____ | 10. Ventilation holes (exhaust) _____ |
| 5. Ventilation holes (intake) _____ | 11. Elevator foot _____ |
| 6. Zoom ring _____ | 12. Elevator button _____ |



Rear View

1. Interface connector
2. Rear IR remote control sensor
3. Security lock receptacle
4. AC power socket
5. Ventilation holes (intake)
6. Tilt-adjustment foot

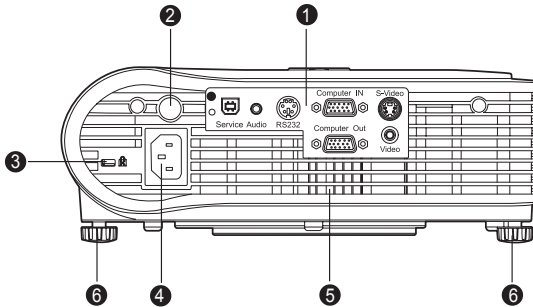

Bottom View

1. Lamp cover
2. Ceiling mount

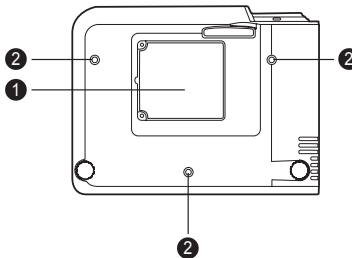

This projector can be used with a ceiling mount for support. The ceiling mount is not included in the package.

Control Panel

1.  (power)
2. Power LED indicator
3. Keystone ▲/▼
4. Auto ►
5. Menu
6. Four direction buttons
7. Lamp LED indicator
8. Source ◀

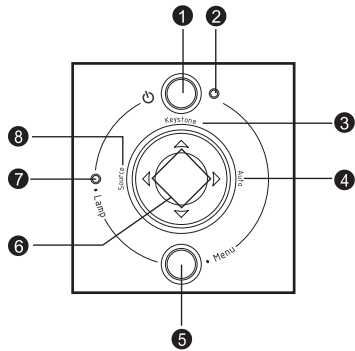

Interface Connector

1. USB connector (Service purpose)

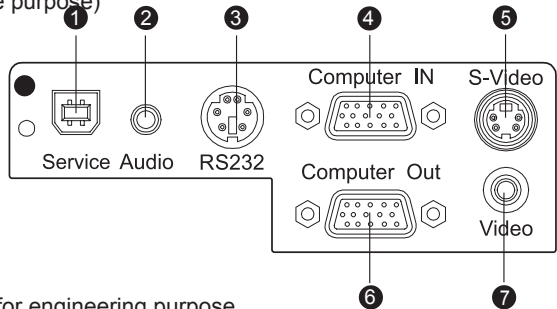

This connector is used for engineering purpose.

2. Audio input connector
Connect an audio output from video equipment to this jack.
3. RS232 connector
When operating the projector via a computer, connect this to the controlling computer's RS-232C port.
4. Computer IN (D-SUB) connector (Blue)
Connect image input signal (analog) to this connector.
5. S-Video connector
Connect S-Video output from video equipment to this jack.
6. Computer Out (D-SUB) connector (Black)
Connect to a computer display, etc.
7. Video connector
Connect composite video output from video equipment to this jack.



Remote Control Components

1. ① Power button _____
2. Four direction buttons _____
3. Menu button _____
4. Enter button _____
5. Keystone ▲/▼ buttons _____
6. Volume ▲/▼ buttons _____
7. Source button _____
8. Mute button _____
9. Blank button _____
10. 4:3/16:9 button _____
11. Auto button _____

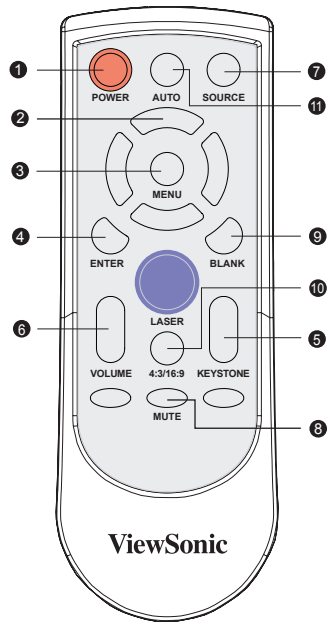

Installation

Connecting the Projector

- ① Audio Cable
- ② RS232 Cable
- ③ VGA Cable (D-SUB to D-SUB)
- ④ VGA (D-SUB) to HDTV (RCA)
- ⑤ Video Cable
- ⑥ S-Video Cable

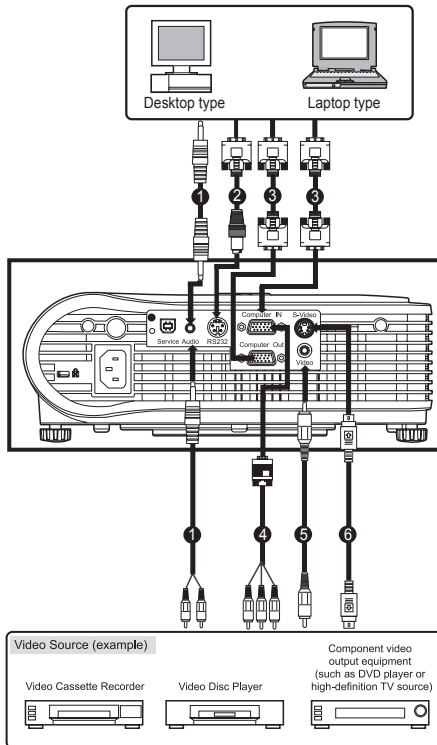



NOTE

- When connecting cable, power cords of both a projector and external equipment should be disconnected from AC outlet.
- The figure above is a sample connection. This does not mean that all of these devices can or must be connected simultaneously.



Powering On/Off the Projector



Powering On the Projector:

1. Remove the projector lens cap.
2. Complete the AC power cord and peripheral signal cable(s) connections.
3. Press the  button on the Projector Control Panel or the  button on the Remote Control to turn on the power.
4. Turn on your source (computer, notebook, DVD, etc.). The projector automatically detects your source.
 - If the “Searching for source” message appears on the screen, ensure that the appropriate signal cable(s) are securely connected.
 - If you are connecting multiple sources to the projector simultaneously, press the Source button either on the Projector Control Panel or the Remote Control.

Warning:

- Never look into the lens when the lamp is on. This can damage your eyes. It is especially important that children are not allowed to look into the lens.

Powering Off the Projector:

1. Press the  button on the Projector Control Panel or the  button on the Remote Control. A message will appear on the screen:



2. Press the  button on the Projector Control Panel or the  button on the Remote Control again to turn off the power. Wait until the lamp LED indicator turns off.



NOTE Please wait until the fan motor and the lamp LED turn off before removing the AC power cord from the projector.

Adjusting the Projected Image

Adjusting the Projector Height

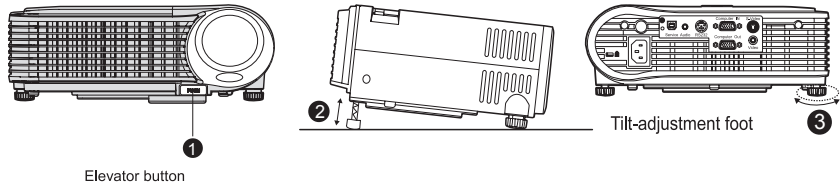

The projector is equipped with an elevator foot to adjust the image height. To raise or lower the image:

1. Turn the projector over and locate the elevator foot. Press the elevator button to extend the foot so it may be adjusted.
2. While holding down the elevator button, adjust the foot to the desired height, then release the button to lock the elevator foot into position.
3. Use tilt-adjustment foot to fine-tune tilt-adjustment.
4. Lower the projector so it rests on its foot; adjust as needed.



■ To avoid damaging the projector, make sure that the elevator foot and tilt-adjustment foot are fully retracted before placing the projector in its carrying case.



Adjusting the Projector Zoom and Focus

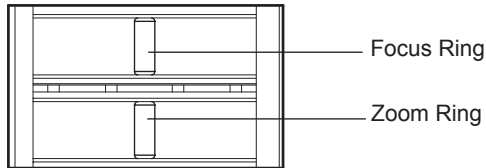

1. Adjust the image size by rotating the zoom ring.
Rotate to the right to reduce the image.
Rotate to the left to enlarge the image.
2. Focus the image by rotating the focus ring.
A still image is recommended for focusing.

Adjusting Projection Image Size

Refer to the graphic and table below to determine the screen size and projection distance.

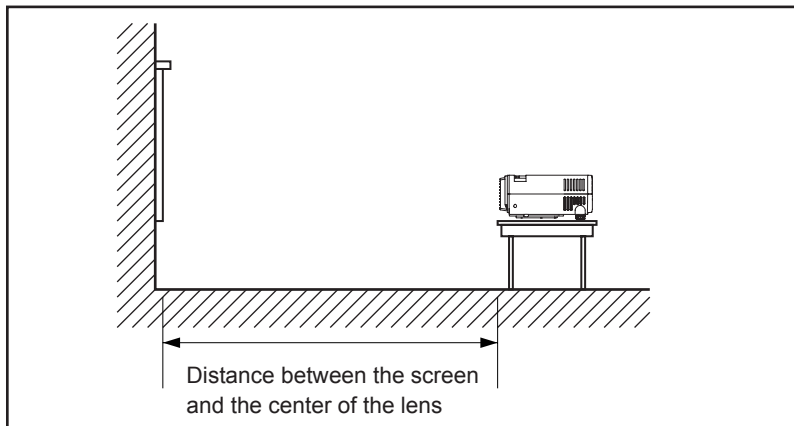

Screen Size (inch)	Projection Distance (m)	
	Wide	Tele
30	-	1.20
40	1.33	1.60
50	1.66	2.00
60	2.00	2.40
80	2.66	3.20
100	3.33	4.00
150	5.00	6.00
200	6.66	8.00
250	8.33	10.00
300	10.0	-

* This table is for user reference only.



- Position the projector in a horizontal position; other positions can cause heat build-up and damage to the projector.
- Make sure the heat ventilation holes are not blocked.
- Do not use the projector in a smoky environment. Smoke residue may cause buildup on critical parts (i.e. DMD, lens assembly, etc.)







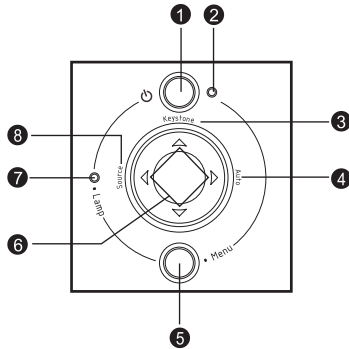





Using the Projector

Control Panel



1. Refer to “Powering On/Off the Projector”.
2. Power LED indicator
Refer to “Indicator Messages”.
3. Keystone
Adjusts image distortion caused by tilting the projector.
4. Auto
Automatically adjusts frequency and phase. This function is available for computer mode only.
5. Menu
Displays or exits the on-screen display menus.
6. Four direction buttons
The four direction buttons can be used to scroll through OSD (On-Screen Display) menus and make adjustments.
7. Lamp LED indicator
Refer to “Indicator Messages”.
8. Source
Manually selects an input source.

Remote Control

1.  Power
Refer to “Powering On/Off the Projector”.
2. Four direction buttons
The four direction buttons /// can be used to scroll through OSD (On-Screen Display) menus and make adjustments.
3. Menu
Press the Menu button to activate the OSD (On-Screen Display) menu. Use the directional buttons and Menu button to navigate through the OSD (On-Screen Display) menu.
4. Enter
Confirms the selection
5. Keystone  / 
Adjusts image distortion caused by tilting the projector.
6. Volume  / 
Press the Volume  button to increase the volume; press the Volume  button to reduce the volume.
7. Source
Manually selects an input source.
8. Mute
Cuts off the sound temporarily.
9. Blank
Cuts off the screen temporarily.
10. 4:3/16:9
Press the 4:3/16:9 to switch the image aspect ratio from 4:3 to 16:9.
11. Auto
Automatically adjusts frequency and phase.

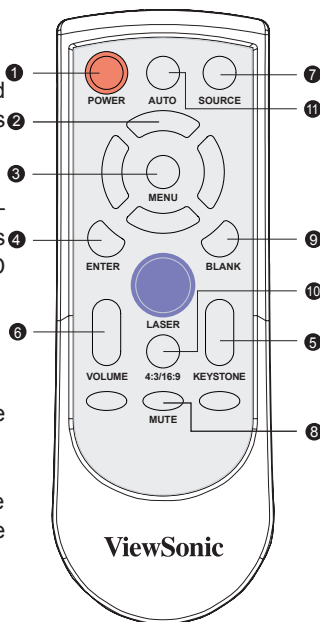

Battery Replacement

- Keep the battery out of the reach of children. There is a danger of death by accidentally swallowing the battery.
- Do not recharge the used battery or expose the battery to fire or water.
- Do not dispose of the used battery along with household waste. Dispose of used batteries according to local regulations.
- Avoid excessive heat and humidity. Danger of explosion may happen if a battery is incorrectly replaced. Replace only with the same type recommended by the manufacturer.



Remote Control Operation

Point the remote control at the infrared remote sensor and press a button.

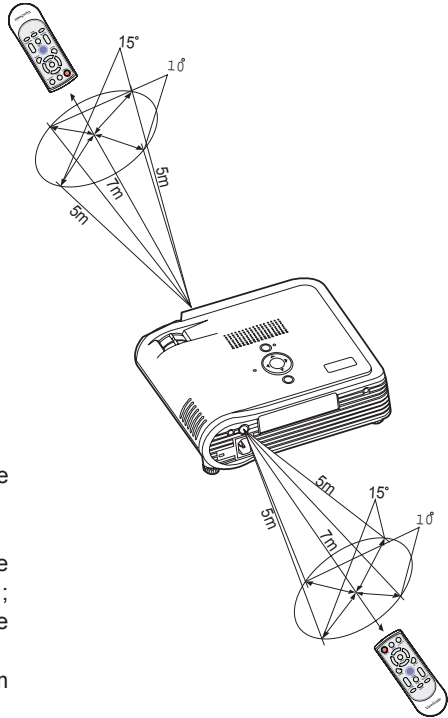

- A. Straight Distance: within about 7 meters from the front of the remote sensor.
- B. Direction:
 - Angle: within about 15 degrees of the remote sensor in vertical direction ; within about 10 degrees of the remote sensor in horizontal direction.
 - Distance: within about 5 meters from the front of the remote sensor.



NOTE

- The remote control may not operate when there is sunlight or other strong light such as a fluorescent lamp shining on the remote sensor.
- Operate the remote control from a position where the remote sensor is visible.
- Do not drop the remote control or jolt it.
- Keep the remote control out of locations with excessively high temperature or humidity.
- Do not get water on the remote control or place wet objects on it.
- Do not disassemble the remote control.

Menu Options

The projector has multi-language OSD (On-Screen Display) menus that can only be displayed when an input source is present. The menus can be accessed using either the Projector Control Panel or the Remote Control. The OSD (On-Screen Display) menus allow you to make image adjustments and change a variety of settings.



1. Press the Menu button on the Projector Control Panel or the Menu button on the Remote Control.
2. Select the menu tab with the ◀/▶ buttons either on the Projector Control Panel or the Remote Control.
3. Select the desired menu option item with the ▲/▼ buttons either on the Projector Control Panel or the Remote Control.
4. Adjust the settings with the ◀/▶ buttons either on the Projector Control Panel or the Remote Control.
 - Refer to each menu option section for more details.
5. To return back to the main menu, press the Menu button on the Projector Control Panel or the Menu button on the Remote Control.
6. To exit from the menu, press the Menu button on the Projector Control Panel or the Menu button on the Remote Control.



The illustrations in this manual are for the purpose of explanation and may differ from the actual setting of your projector.



Color (Computer/Video Mode)



Option	Actions/Descriptions
Brightness	Adjusts the brightness of the image. <ul style="list-style-type: none"> ● Press the ◀ button to darken the image. ● Press the ▶ button to lighten the image.
Contrast	The contrast controls the degree of difference between the lightest and darkest parts of the picture. Adjusting the contrast changes the amount of black and white in the image. <ul style="list-style-type: none"> ● Press the ◀ button to decrease the contrast. ● Press the ▶ button to increase the contrast.
Color Temperature	Adjusts the color temperature. At higher temperature, the screen looks colder; at lower temperature, the screen looks warmer.
Gamma	Gamma affects how dark scenery is displayed. With a greater gamma value, dark scenery will look brighter.
White Segment	The white segment control adjusts the white peaking level of the DMD chip. 0 stands for minimal segment, and 10 stands for maximum segment. If you prefer a stronger image, adjust towards the maximum setting. For a smooth and more natural image, adjust towards the minimum setting.

Option	Actions/Descriptions
Saturation	<p>Adjusts a video image from black and white to fully saturated color.</p> <ul style="list-style-type: none"> ● Press the ◀ button to decrease the amount of color in the image. ● Press the ▶ button to increase the amount of color in the image.
Tint	<p>Adjusts the color balance of red and green.</p> <ul style="list-style-type: none"> ● Press the ◀ button to increase the amount of green in the image. ● Press the ▶ button to increase the amount of red in the image.
Color R	Adjusts the red color.
Color G	Adjusts the green color.
Color B	Adjusts the blue color.



“Saturation” and “Tint” functions are not supported under computer mode.

Image (Computer Mode)

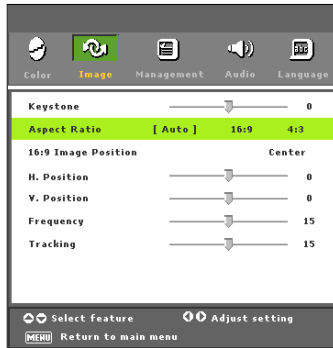

Option	Actions/Descriptions
Keystone	Adjusts image distortion caused by tilting projection. (+15 degrees)
Aspect Ratio	<p>Selects this function to fit Auto, 16:9, 4:3 aspect ratio.</p> <ul style="list-style-type: none"> ● Auto: Keep the image with original width-height ratio. ● 16:9: The input source will be scaled to fit the width of the screen. ● 4:3: The input source will be scaled to fit the projection screen.
16:9 Image	<ul style="list-style-type: none"> ● Press the ◀ / ▶ buttons to choose the image position showed on Position top, center, or bottom.
H. Position (Horizontal Position)	<ul style="list-style-type: none"> ● Press the ◀ button to move the image left. ● Press the ▶ button to move the image right.
V. Position (Vertical Position)	<ul style="list-style-type: none"> ● Press the ◀ button to move the image down. ● Press the ▶ button to move the image up.
Frequency	“Frequency” changes the display data frequency to match the frequency of your computer’s graphic card. If you experience a vertical flickering bar, use this function to make an adjustment.
Tracking	“Tracking” synchronizes the signal timing of the display with the graphic card. If you experience an unstable or flickering image, use this function to correct it.

Image (Video Mode)



Keystone	Adjusts image distortion caused by tilting projection. (± 15 degrees)
Aspect Ratio	Select this function to fit Auto, 16:9, 4:3 aspect ratio. <ul style="list-style-type: none"> ● Auto : Keep the image with original width-height ratio and maximize the image to fit native horizontal or vertical pixels. ● 16:9 : The input source will be scaled to fit the width of the screen. ● 4:3 : The input source will be scaled to fit the projection screen.
16:9 Image Position	● Press the ◀ / ▶ buttons to choose the image position showed on top, center, or bottom.
Sharpness	Adjusts the sharpness of the image. <ul style="list-style-type: none"> ● Press the ◀ button to decrease the sharpness. ● Press the ▶ button to increase the sharpness.



Management (Computer/Video Mode)

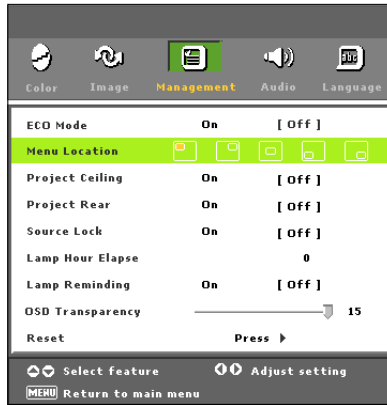

Option	Actions/Descriptions
ECO Mode	Choose “On” to dim the projector lamp which will lower power consumption, extend the lamp life and reduce noise. Choose “Off” to return normal mode.
Menu Location	Choose the Menu location on the display screen.
Project Ceiling	Choose “On” to reverse the image horizontally. Choose “Off” to return normal mode.
Project Rear	Choose “On” to reverse the image vertically. Choose “Off” to return normal mode.
Source Lock	When source lock is turned off, the projector will search for other signals if the current input signal is lost. When source lock is turned on, it will “Lock” the current source channel before you press “Source” button for next channel.
Lamp Hour Elapse	Displays the lamp’s elapsed operating time (in hours). Elapse
Lamp Reminding	Choose this function to show or to hide warning message when the changing lamp message is displayed. The message will show up 30 hours before end of life.
OSD Transparency	Adjusts the OSD’s transparency.
Reset	Press the ► button and then choose “Yes” to return the display parameters on all menus to the factory default settings.

Audio (Computer/Video Mode)



Option	Actions/Descriptions
Volume	<ul style="list-style-type: none">● Press the ◀ button to decrease the volume.● Press the ▶ button to increase the volume.
Mute	<ul style="list-style-type: none">● Choose “On” to turn mute on.● Choose “Off” to turn mute off.

Language

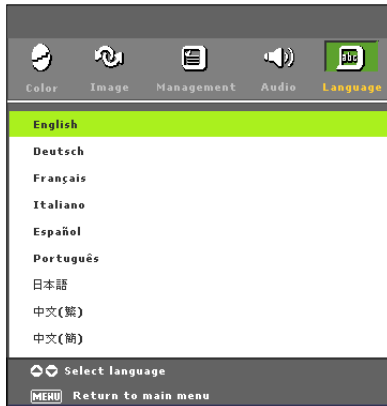

Option	Actions/Descriptions
Language	<p>Choose the multilingual OSD menu. Use the ▲ / ▼ buttons to select your preferred language.</p> <p>Press the Menu button on the Projector Control Panel or the Menu button on the Remote Control to confirm the selection.</p>

Maintenance

The projector needs proper maintenance. You should keep the lens clean as dust, dirt or spots will project on the screen and diminish image quality. If any other parts need replacing, contact your dealer or qualified service personnel. When cleaning any part of the projector, always switch off and unplug the projector first.

Warning:

- Never open any of the covers on the projector. Dangerous electrical voltages inside the projector can cause severe injury. Do not attempt to service this product yourself. Refer all servicing to qualified service personnel.

Cleaning the Lens

Gently wipe the lens with lens cleaning paper. Do not touch the lens with your hands.

Cleaning the Projector Housing

Gently wipe with a soft cloth. If dirt and stains are not easily removed, use a soft cloth dampened with water, or water and neutral detergent, and wipe dry with a soft, dry cloth.



- Turn off the projector and remove the AC power cord from the power outlet before beginning maintenance work.
- Make sure the lens is cool before cleaning.
- Do not use detergents or chemicals other than those noted above. Do not use benzene or thinners.
- Do not use chemical sprays.
- Use a soft cloth or lens paper only.



Replacing the Lamp

Projector lamps have a finite life. Replace the lamp when:

- A warning message “Lamp is approaching the end of its useful life in full power operation. Replacement Suggested!” appears on the screen.
- The image becomes darker and hues become weaker after a lamp has been for a long period of time.
- The projector lamp LED indicator turns into red. Refer to section titled “Indicator Messages” for further details.



- The lamp becomes high temperature after turning off the projector with the power button. If you touch the lamp, you may scald your finger. When you replace the lamp, wait for at least 45 minutes for the lamp to cool down.
- Do not touch the lamp glass at any time. The lamp may explode due to improper handling, including the touching of the lamp glass.
- Lamp lifetime may differ from lamp to lamp and according to the environment of use. There is no guarantee of the same lifetime for each lamp. Some lamps may fail or terminate their lifetime in a shorter period of time than other similar lamps.
- A lamp may explode as a result of vibration, shock or degradation as a result of hours of use as its lifetime draws to an end. Risk of explosion may differ according to the environment or conditions in which the projector and lamp are being used.
- Wear protective gloves and eyeglasses when fixing or detaching the lamp.
- Faster on-off-cycles will damage the lamp and reduce lamp life. Wait at least for 5 minutes to turn off the projector after powering on.
- Do not operate the lamp in proximity to paper, cloth, or other combustible material nor cover it with such materials. Otherwise it could cause a fire.
- Do not operate the lamp in an atmosphere containing an inflammable substance, such as thinner. Otherwise it could cause a fire or explosion.
- Thoroughly ventilate the area or the room when operating the lamp in an oxygen atmosphere (in the air). If ozone is inhaled, it could cause headaches, nausea, dizziness, etc.
- The inorganic mercury is involved in the lamp. If the lamp bursts, the mercury inside the lamp will go out of the projector. Leave the area immediately if the lamp shatters while being operated and ventilate the area for at least 30 minutes in order to avoid the inhalation of mercury fumes. Otherwise it could be harmful to user's health.

1. Turn off the projector and unplug the AC power cord.
2. Place a protective sheet (cloth) beneath the projector. Turn the projector over so you can access the lamp cover.
3. Remove the access panel screws and open the panel.
4. Remove the screws on the bottom of the lamp assembly.
5. Grasp the lamp handle and pull the lamp assembly directly out of the projector.
6. Replace with the new lamp.
7. Place back the screws on the bottom of lamp assembly.
8. Place the panel and screw back the screws on the lamp cover.

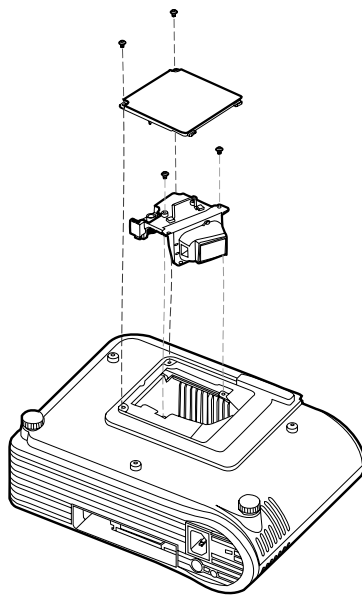

- Dispose of the used lamp according to local regulations.
- Ensure that screws are tightened properly. Screws not tightened fully may result in injury or accidents.
- Since the lamp is made of glass, do not drop the unit and do not scratch the glass.
- Do not reuse the old lamp. This could cause the lamp to explode.
- Be sure to turn off the projector and unplug the AC power cord before replacing the lamp.
- Do not use the projector with the lamp cover removed.



Specifications

Projection System	Single panel 0.55" DLP projector
Native resolution	786,432 dot x1 (1024 x 768 x1)
Image Brightness	2300 ANSI Lumens
Uniformity	85 %
Lens	Manual Zoom (1.2X)
Focal Length	18 - 21.57 mm
Contrast Ratio	2000 : 1(Full on/off)
Aspect Ratio	Auto, 16:9, 4:3
Screen Size	24.8 - 285.7 inches
Lamp	230W
Projection Type	Front, Rear, Ceiling
Input Source	VGA, HDTV via VGA, S-Video, Video
Scanning Frequency	
Horizontal Freq.	31 - 79 KHz
Vertical Freq.	56 - 85 Hz
Digital Keystone Correction	Vertical: +/- 15 degrees
Analog RGB (input signal)	D-Sub connector
HDTV Display	480p, 720p, 1080i
Integrated Speaker	1W x 1
Audio Noise	37dB (Normal) and 32dB (in ECO Mode)
Remote Control	Multifunctional
OSD Language	Multilanguage
Operational Ambient	Temperature: 0 - 40°C Humidity: 30 - 85%
Power Supply	AC 100 - 240 V, 50 / 60 Hz
Power Consumption	300 Watts (Typical)
Dimension (W x D x H)	265 x 202 x 97 mm
Weight	2.45 kgs

Note: Design and Specifications are subject to change without prior notice.

Appendix

Indicator Messages

LED Type	Color	Status	Meaning
Power LED	Green	Flashing	The projector is powered and ready.
Power LED	Amber	Solid	The projector system has some problems with its fan, so the projector cannot start up.
Power LED	Green	Solid	The projector is in good condition on working.
Lamp LED	Green	Solid	The lamp is in good condition and is projecting at maximum brightness.
Lamp LED	Amber	Solid	The lamp has reached its end of life and must be changed soon. The lamp will continue to operate until it fails. Change the lamp. If the lamp is off, then the ballast will become malfunction.
Lamp LED	Green	Flashing	The projector is shutting down. The fan motor is cooling the lamp for shutdown. Do not unplug the power cable or turn the power switch off before the lamp LED turns off. The fan motor will turn off when the lamp has cooled.
Lamp LED	Amber	Flashing	Temperature is too high. The lamp will turn off.



Preset Signals

Mode	Resolution	Vertical Frequency (Hz)	Horizontal Frequency (kHz)	Timing
480p	640 x 480	59.94	31.46	60 Hz
720p	1280 x 720	60	45	60 Hz
VGA	640 x 480	72.8	37.86	60 Hz
	640 x 480	75	37.5	75 Hz
	640 x 480	85	43.2	85 Hz
	720 x 400	70	31.5	60 Hz
	720 x 400	85	37.9	85 Hz
SVGA	800 x 600	56.2	35.1	56 Hz
	800 x 600	60.3	37.8	60 Hz
	8000 x 600	72.1	48	72 Hz
	800 x 6000	75	46.8	75 Hz
XGA	1024 x 768	60	48.3	60 Hz
	1024 x 768	70	56.4	70 Hz
	1024 x 768	75	60	75 Hz
	1024 x 768	84.9	68.8	85 Hz
	1024 x 768	60	48.3	60 Hz
	1024 x 768	75	60.2	60 Hz
SXGA*	1280 x 1024	60	63.98	60 Hz
	1280 x 1024	75	79.9	75 Hz
	1152 x 870	75	68.6	60 Hz
	1152 x 864	75	67.5	75 Hz
Mac 16"	832 x 624	74.5	49.7	60 Hz
Mac 480-66A	640 x 480	66.667	35	66 Hz

* means compressed.

HDTV Preset Signals

Signal	Horizontal Frequency (kHz)	Vertical Frequency (Hz)
480p	31.469 kHz	59.94 Hz
720p	45.0 kHz	60 Hz
1080i	33.716kHz	29.97 Hz

Troubleshooting

Refer to the symptoms and measures listed below before sending the projector for repairs. If the problem persists, contact your local reseller or service center. Please refer to “Indicator Messages” as well.

Symptom	Cause	Measure
No power.	The AC power cord is not plugged in.	Plug in the AC power cord.
	The AC power cord is not connected to the projector.	Connect the AC power cord to the projector correctly.
	The lamp cover loose.	Tighten the screws on the lamp cover.
Power goes out during use.	The temperature is too high.	Unplug the AC power cord and wait for a short while, then turn the power back on.
	The ventilation holes are blocked.	Place the projector so that the ventilation holes are not blocked.
No picture.	The projector is not turned on.	Turn the projector on.
	The brightness setting is minimized.	Adjust the brightness in the “Color” menu.
	The connections set up are not correctly.	Check that all connections are set up correctly.
	The connected devices are not functioning properly.	Check that all connected devices are functioning properly.
No audio.	The projector is not turn on.	Turn the projector on.
	The mute function is on.	Set the mute to off.
	The volume setting is minimized.	Adjust the volume in the “Audio” menu.
	The connections have not been set up correctly.	Check that all connections are set up correctly.
	The connected devices are not functioning properly.	Check that all connected devices are functioning properly.
Picture not displayed correctly.	The input signal is not supported by the projector.	Refresh the input signal rate.



Picture blurred. Part of picture out of focus.	The lens is dirty.	Wipe clean with a soft, dry cloth or lens paper.
	The lens focus is not adjusted optimally.	Adjust the focus with the focus ring.
	The projection distance is not within the projector's supported range.	Place the projector within the supported range.
	The projector's screen placement angle is tilted too far.	Adjust the screen placement angle.
	The frequency or tracking has not been adjusted properly.	Adjust frequency and tracking in the "Image (Computer Mode)" menu properly.
	The lens cap is attached to the lens.	Remove the lens cap.
Image is dark.	The brightness or contrast has not been adjusted properly.	Adjust the brightness or contrast in the "Color (Computer/Video Mode)" menu properly.
	The lamp is near the end of its service life.	Replace with a new lamp.
Colors too light. Bad shading.	The saturation, tint, color R, color G or color B has not been adjusted properly.	Adjust the saturation, tint, color R or color G in the "Color (Computer/Video Mode)" menu properly.
	The screen is dirty.	Wipe clean with a soft, dry cloth.
	The lamp is near the end of its service life.	Replace with a new lamp.
Remote control doesn't work.	The battery could be weak.	Replace with a new battery.
	The polarity is not correct.	Insert the battery with correct polarities.
	The remote control is not being used within the effective range.	Use the remote control within the effective range.
	There are some obstructions between the remote control and projector.	Check that there are not any obstructions between the remote control and projector.
	There are some fluorescent or other bright lights shining at the projector's infrared remote sensor.	Check that there are not any fluorescent or other bright lights shining at the projector's infrared remote sensor.

Customer Support

For technical support or product service, see the table below or contact your reseller.

Note : You will need the product serial number.

Country/ Region	Web Site	T=Telephone F=Fax	E-mail
United States	www.viewsonic.com/support/	T= 800 688 6688 F= 909 468 1202	service.us@viewsonic.com
Canada	www.viewsonic.com/support	T= 866 463 4775	service.ca@viewsonic.com
United Kingdom	www.viewsoniceurope.com/uk	T= 0207 949 0307	service.eu@viewsoniceurope.com
Europe, Middle East, Baltic countries, and North Africa	www.viewsoniceurope.com	Contact your reseller	service.eu@viewsoniceurope.com
Australia and New Zealand	www.viewsonic.com.au/support/	AUS= 1800 880 818 NZ= 0800 008 822	service@au.viewsonic.com
Singapore/ Malaysia/ Thailand	www.viewsonic.com.sg/support/	T= 65 64616044	service@sg.viewsonic.com
South Africa/ Other countries	www.viewsonic.com	T= 886 2 2246-3456 F= 886 2 2249-1751	service@sd.viewsonic.com
Hong Kong	www.hk.viewsonic.com/support/	T= 852 3102 2900	service@hk.viewsonic.com
Macau	www.hk.viewsonic.com/support/	T= 853 700 303	service@hk.viewsonic.com
Korea	www.viewsonic.com	T= 080 265 9080	service@kr.viewsonic.com

Limited Warranty

VIEWSONIC® PROJECTOR

What the warranty covers:

ViewSonic warrants its products to be free from defects in material and workmanship, under normal use, during the warranty period. If a product proves to be defective in material or workmanship during the warranty period, ViewSonic will, at its sole option, repair or replace the product with a like product. Replacement product or parts may include remanufactured or refurbished parts or components.

How long the warranty is effective:

North and South America: 3 years for all parts excluding the lamp, 3 years for labor, 1 year for the original lamp from the date of the first consumer purchase.

Europe: 3 years for all parts excluding the lamp, 3 years for labor, 1 year for the original lamp from the date of the first consumer purchase.

Other regions or countries: Please check with your local dealer or local ViewSonic office for the warranty information.

Lamp warranty subject to terms and conditions, verification and approval. Applies to manufacturer's installed lamp only.

All accessory lamps purchased separately are warranted for 90 days.

Who the warranty protects:

This warranty is valid only for the first consumer purchaser.

What the warranty does not cover:

1. Any product on which the serial number has been defaced, modified or removed.
2. Damage, deterioration or malfunction resulting from:
 - a. Accident, misuse, neglect, fire, water, lightning, or other acts of nature, unauthorized product modification, or failure to follow instructions supplied with the product.
 - b. Repair or attempted repair by anyone not authorized by ViewSonic.
 - c. Any damage of the product due to shipment.
 - d. Removal or installation of the product.
 - e. Causes external to the product, such as electric power fluctuations or failure.
 - f. Use of supplies or parts not meeting ViewSonic's specifications.
 - g. Normal wear and tear.
 - h. Any other cause which does not relate to a product defect.
3. Any product exhibiting a condition commonly known as "image built-in" which results when a static image is displayed on the product for an extended period of time.
4. Removal, installation, and set-up service charges.

How to get service:

1. For information about receiving service under warranty, contact ViewSonic Customer Support (Please refer to Customer Support page). You will need to provide your product's serial number.

2. To obtain warranted service, you will be required to provide (a) the original dated sales slip, (b) your name, (c) your address, (d) a description of the problem, and (e) the serial number of the product.
3. Take or ship the product freight prepaid in the original container to an authorized ViewSonic service center or ViewSonic.
4. For additional information or the name of the nearest ViewSonic service center, contact ViewSonic.

Limitation of implied warranties:

There are no warranties, express or implied, which extend beyond the description contained herein including the implied warranty of merchantability and fitness for a particular purpose.

Exclusion of damages:

ViewSonic's liability is limited to the cost of repair or replacement of the product. ViewSonic shall not be liable for:

1. Damage to other property caused by any defects in the product, damaged based upon inconvenience, loss of use of the product, loss of time, loss of profits, loss of business opportunity, loss of goodwill, interference with business relationships, or other commercial loss, even if advised of the possibility of such damages.
2. Any other damages, whether incidental, consequential or otherwise.
3. Any claim against the customer by other party.

Effect of state law:

This warranty gives you specific legal rights, and you may also have other rights which vary from state to state. Some states do not allow limitations on implied warranties and/or do not allow the exclusion of incidental or consequential damages, so the above limitations and exclusions may not apply to you.

Sales outside the U.S.A. and Canada:

For warranty information and service on ViewSonic products sold outside of the U.S.A. and Canada, contact ViewSonic or your local ViewSonic dealer.

The warranty period for this product in mainland China (Hong Kong, Macao and Taiwan Excluded) is subject to the terms and conditions of the Maintenance Guarantee Card.

4.3: Projector Warranty

PRJ_LW01 Rev. 1g 06-30-06

