

EPSON
EXCEED YOUR VISION



EPSON EB-600 Series Ultra Short Throw Projectors

ProSelecta

View :: Compare :: Select - www.ProSelecta.com

3LCD

CONSISTENT
DISPLAY OF DETAIL



Sharper images with
no colour disruption

VIVID, REALISTIC
COLOUR

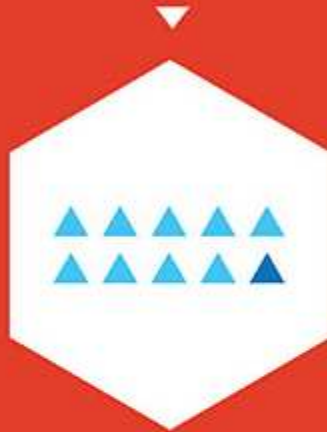

9 out of 10 people
prefer images from
3LCD projectors over
1-chip DLP¹

EFFICIENT ENERGY
USE



25% higher energy
efficiency per lumen
of brightness than
1-chip DLP²

SUPERIOR COLOUR
BRIGHTNESS



Colour Brightness
than 1-chip DLP¹

High Brightness

Up to 3,500 Lumen colour and white brightness



Interactive on Multi Projection

Annotate seamlessly over two projected images



Save and Print

Save to USB memory

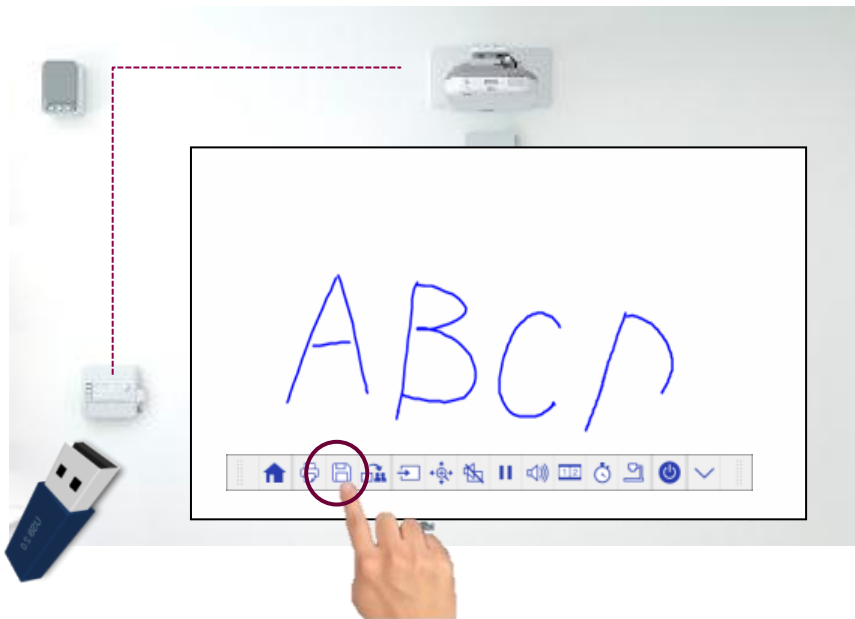

Print via network



Collaboration with student devices

Sending projected images

Teachers can send projected images from the bottom tool bar of the projector



Or via the teachers PC/tablet which is on the same network as the projector

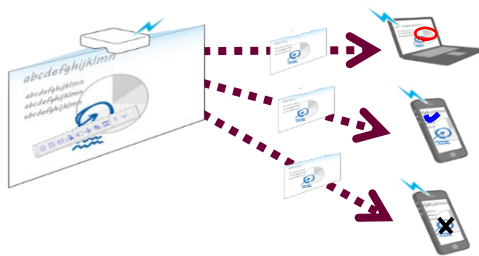

Answering

Students can annotate on the received image and save it to their own device

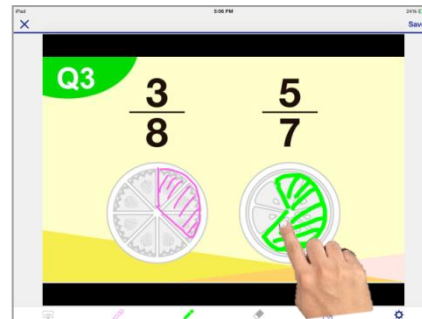
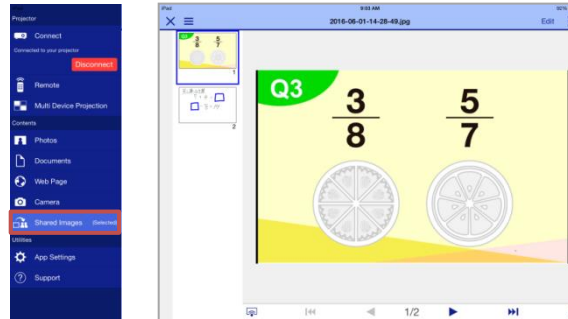

Projecting student answers

Teachers can check all the students answers via thumbnail images and select which one they choose to share



iProjection for BYOD Classrooms

iProjection (iOS) Ver 4.1

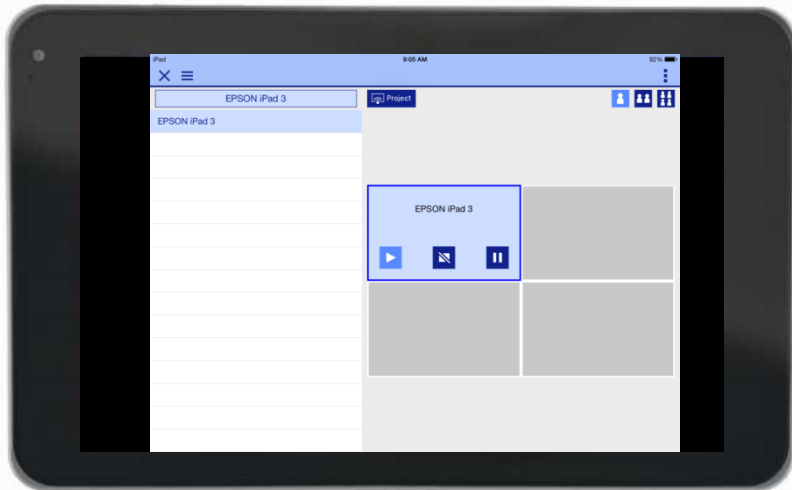

The new version of iProjection now includes a moderator function. This allows teachers to move around the classroom and select which images they project from their tablet.

iProjection for Chromebook

iProjection is now compatible with Chromebook making the software the idea solution for BYOD classrooms.

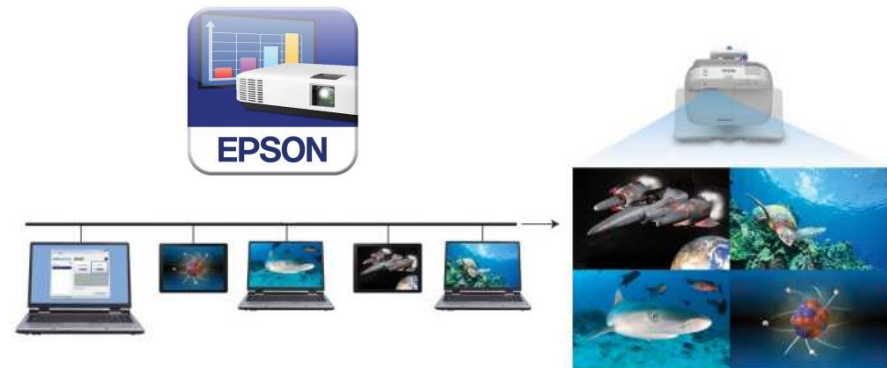

Interactivity – Document Camera Control

Epson document cameras can be controlled directly from the projected screen

Easily change Optical zoom, focus and freeze images

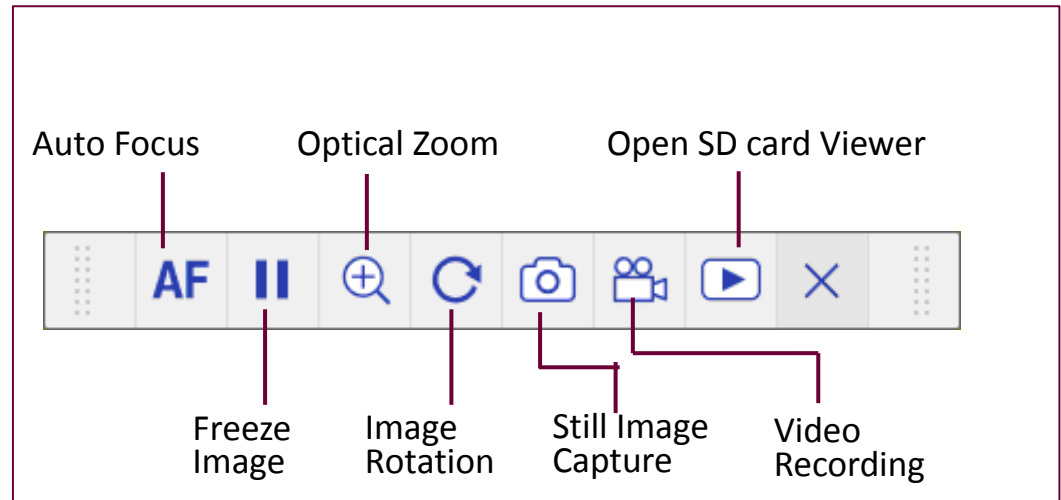

Improved pen



Smoother writing experience

Easy to grip



Smooth PC operation

Long life lamp and filter

Easy maintenance with both the lamp filter lasting 10,000hrs

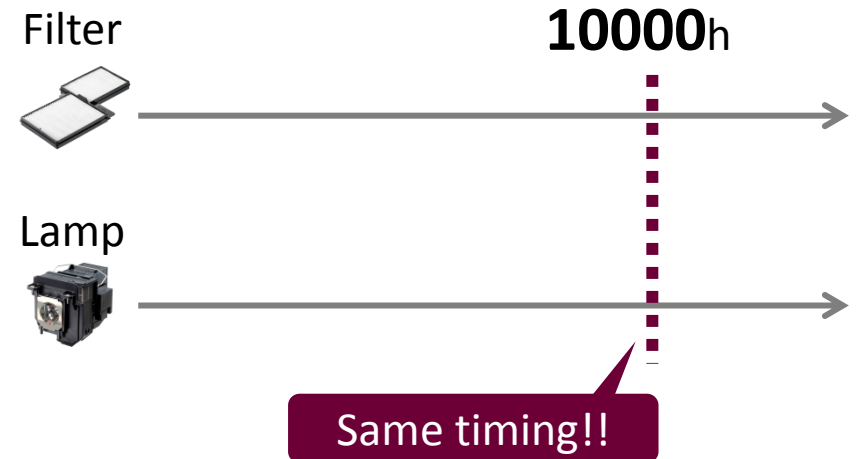
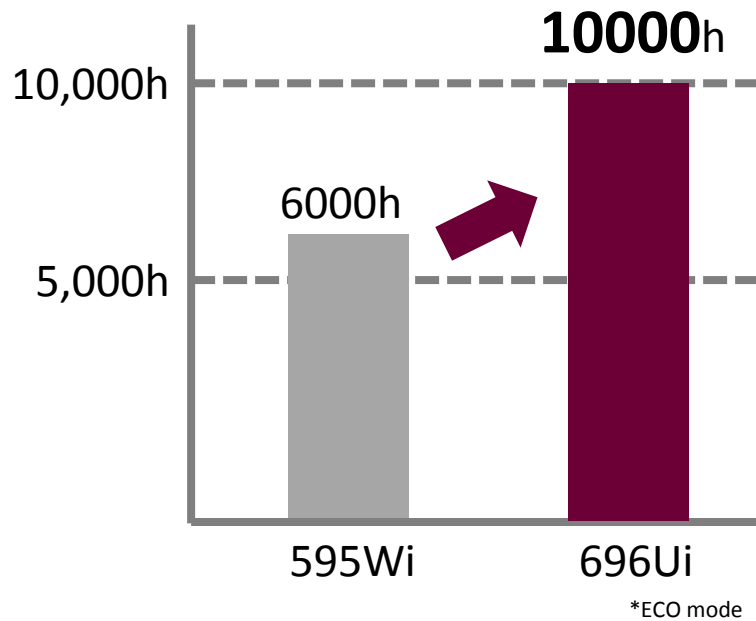

Additional Features

Arc Correction

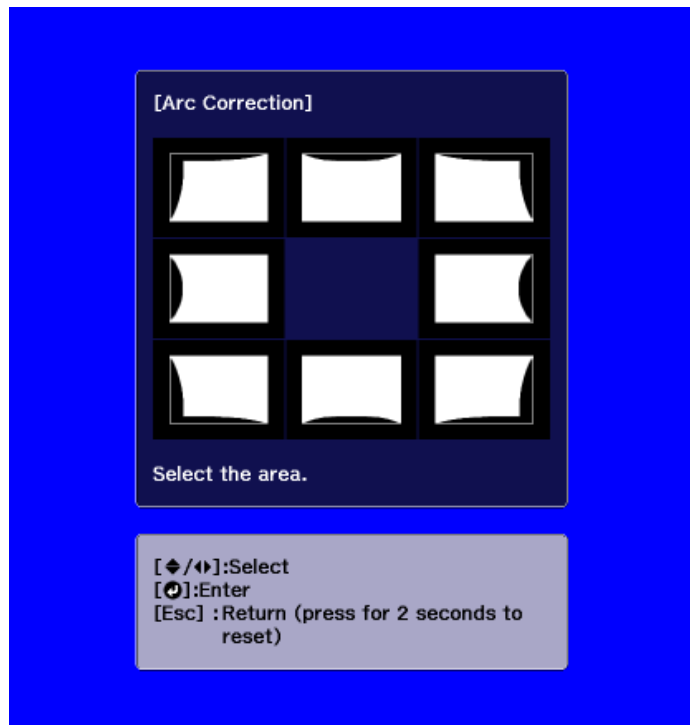

Dust resistant



Additional features

Touch operation of USB slide show



Onscreen timer

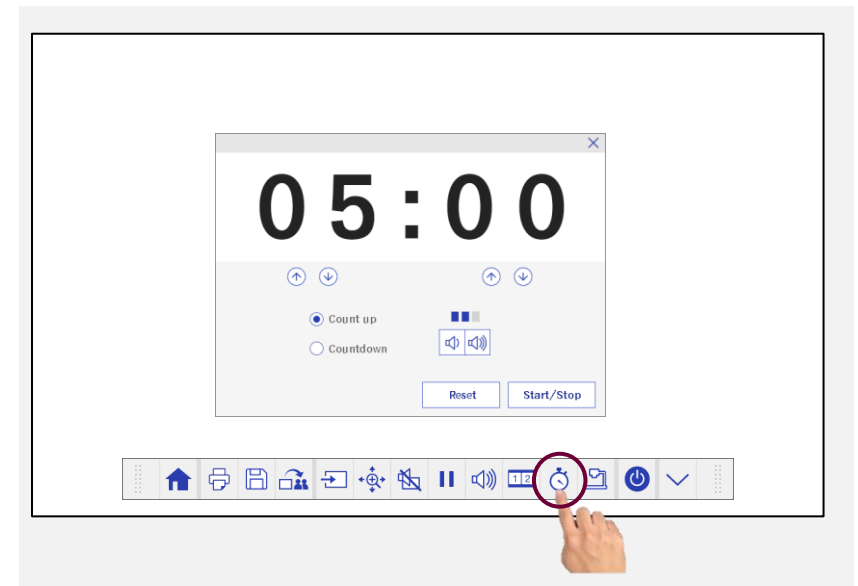

New Optional Mount

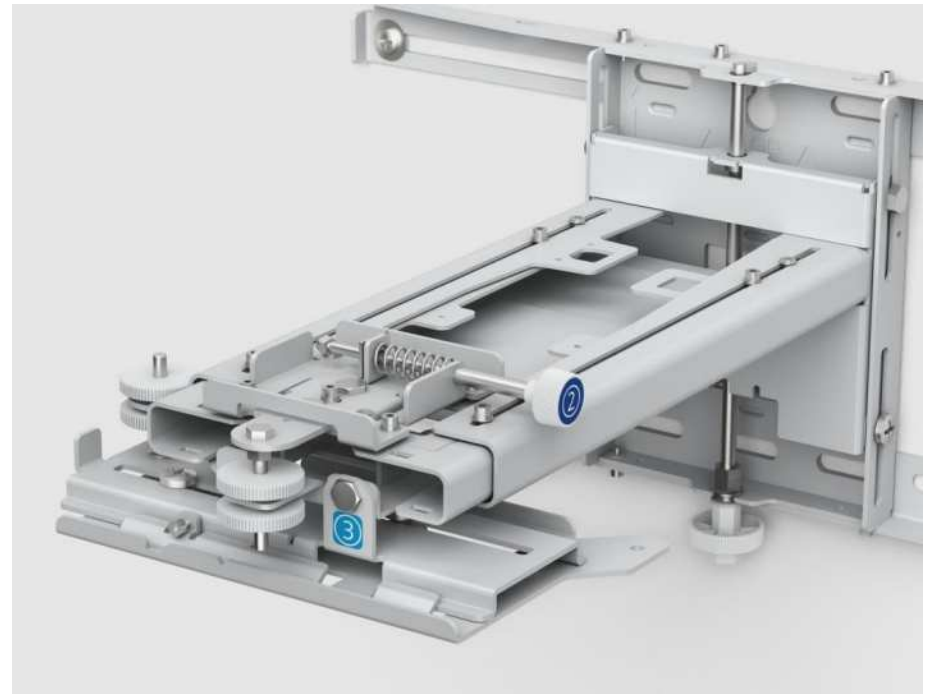

Interface



Range Chart – Interactive

	EB-696Ui	EB-695Wi	EB-695Wie	EB-685Wi	EB-675Wi
Resolution	WUXGA	WXGA	WXGA	WXGA	WXGA
Brightness (CLO/WLO)	3,500/3,500	3,500/3,500	3,500/3,500	3,500/3,500	3,000/3,000
Throw Ratio	0.27 (Zoom: Wide) 0.37 (Zoom: Tele)	0.28 (Zoom: Wide) 0.37 (Zoom: Tele)	0.28 (Zoom: Wide) 0.37 (Zoom: Tele)	0.28 (Zoom: Wide) 0.37 (Zoom: Tele)	0.28 (Zoom: Wide) 0.37 (Zoom: Tele)
Mount Included	✓	Optional (ELPMB46)	Optional (ELPMB46)	Optional (ELPMB46)	Optional (ELPMB46)
Wireless	Optional (ELPAP10)	Optional (ELPAP10)	Optional (ELPAP10)	Optional (ELPAP10)	Optional (ELPAP10)
SMART Notebook Software	✓	✓	✓	✓	✓
HDMI	3	3	3	3	3
Interactivity	Finger and Pen	Finger and Pen	Finger and Pen	Pen	Pen

Range Chart – Non Interactive

	EB-685W	EB-685We	EB-675W	EB-680	EB-680e
Resolution	WXGA	WXGA	WXGA	XGA	XGA
Brightness (CLO/WLO)	3,500/3,500	3,500/3,500	3,000/3,000	3,500/3,500	3,500/3,500
Throw Ratio	0.28 (Zoom: Wide) 0.37 (Zoom: Tele)	0.28 (Zoom: Wide) 0.37 (Zoom: Tele)	0.28 (Zoom: Wide) 0.37 (Zoom: Tele)	0.32(Zoom: Wide) 0.43 (Zoom: Tele)	0.32(Zoom: Wide) 0.43 (Zoom: Tele)
Mount Included	Optional (ELPMB46)	Optional (ELPMB46)	Optional (ELPMB46)	Optional (ELPMB46)	Optional (ELPMB46)
Wireless	Optional (ELPAP10)	Optional (ELPAP10)	Optional (ELPAP10)	Optional (ELPAP10)	Optional (ELPAP10)
HDMI	3	3	3	3	3
USB display (Win&Mac)	3 in 1	3 in 1	3 in 1	3 in 1	3 in 1