

## Projector

# CP-WU8700/CP-WX8750/CP-X8800 CP-WU8600/CP-WX8650

## User's Manual (detailed) Operating Guide

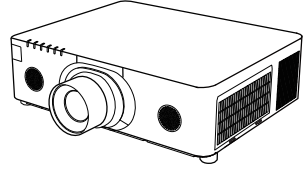

Thank you for purchasing this projector.

**▲ WARNING** ▶ Before using this product, please read all manuals for this product. Be sure to read **Safety Guide** first. After reading them, store them in a safe place for future reference.

### About this manual

Various symbols are used in this manual. The meanings of these symbols are described below.

**▲ WARNING** This symbol indicates information that, if ignored, could possibly result in personal injury or even death due to incorrect handling.

**▲ CAUTION** This symbol indicates information that, if ignored, could possibly result in personal injury or physical damage due to incorrect handling.

**NOTICE**  This entry notices of fear of causing trouble.

 Please refer to the pages written following this symbol.

**NOTE** • The information in this manual is subject to change without notice.

- The illustrations in this manual are for illustrative purposes. They may differ slightly from your projector.
- The manufacturer assumes no responsibility for any errors that may appear in this manual.
- The reproduction, transfer or copy of all or any part of this document is not permitted without express written consent.

### Trademark acknowledgment

- Mac<sup>®</sup> is a registered trademark of Apple Inc.
  - Windows<sup>®</sup>, DirectDraw<sup>®</sup> and Direct3D<sup>®</sup> are registered trademarks of Microsoft Corporation in the U.S. and/or other countries.
  - VESA and DDC are trademarks of the Video Electronics Standard Association.
  - HDMI<sup>™</sup>, the HDMI logo, and High-Definition Multimedia Interface are trademarks or registered trademarks of HDMI Licensing LLC in the United States and other countries.
  - Trademark PJLink is a trademark applied for trademark rights in Japan, the United States of America and other countries and areas.
  - Blu-ray Disc<sup>™</sup> and Blu-ray<sup>™</sup> are trademarks of Blu-ray Disc Association.
  - DICOM<sup>®</sup> is the registered trademark of the National Electrical Manufacturers Association for its standards publications relating to digital communications of medical information.
  - HDBaseT<sup>™</sup> and the HDBaseT Alliance logo are trademarks of the HDBaseT Alliance.
  - DisplayPort is a trademark or registered trademark of Video Electronics Standards Association.
- All other trademarks are the properties of their respective owners.

**PJLink**<sup>™</sup>

# Contents



<b>Introduction</b> .....	<b>3</b>	<b>EASY MENU</b> .....	<b>60</b>
Features .....	3	<b>PICTURE menu</b> .....	<b>62</b>
Checking the contents of package .....	3	<b>IMAGE menu</b> .....	<b>66</b>
Part names .....	4	<b>INPUT menu</b> .....	<b>69</b>
Projector, Control panel and Indicators, Ports, Remote control .....		<b>SETUP menu</b> .....	<b>74</b>
<b>Setting up</b> .....	<b>8</b>	<b>AUDIO menu</b> .....	<b>80</b>
Arrangement .....	10	<b>SCREEN menu</b> .....	<b>81</b>
Connecting with your devices .....	13	<b>OPTION menu</b> .....	<b>87</b>
Fastening the cables .....	23	<b>NETWORK menu</b> .....	<b>100</b>
Fastening the adapter cover .....	24	<b>SECURITY menu</b> .....	<b>101</b>
Attaching the terminal cover .....	25	<b>Maintenance</b> .....	<b>108</b>
Using the security bar and slot .....	26	Replacing the lamp .....	108
Connecting power supply .....	27	Cleaning and replacing the air filter .....	110
<b>Remote control</b> .....	<b>28</b>	Replacing the internal clock battery .....	112
Installing the batteries .....	28	Other care .....	113
Using the REMOTE ID function .....	29	<b>Troubleshooting</b> .....	<b>114</b>
Changing the frequency of remote control signal .....	29	Warnings displayed on the Status Monitor .....	114
About the remote control signal .....	30	Related messages .....	114
<b>Status Monitor</b> .....	<b>31</b>	Regarding the indicator lamps .....	117
Displaying the condition of the projector .....	31	Resetting all settings .....	121
Displaying the log .....	33	Phenomena that may be easy to be mistaken for machine defects .....	122
<b>Power on/off</b> .....	<b>35</b>	<b>Specifications</b> .....	<b>129</b>
Turning on the power .....	35		
Turning off the power .....	35		
<b>Operating</b> .....	<b>37</b>		
Adjusting the volume .....	37		
Temporarily turning off the screen and audio .....	37		
Selecting an input signal .....	38		
Selecting an aspect ratio .....	39		
Adjusting the projector's elevator .....	40		
Installation angle .....	40		
Adjusting the lens .....	41		
Adjusting the zoom and focus, Adjusting the lens position, Lens memory .....			
Using the automatic adjustment feature .....	43		
Correcting the distortion .....	44		
Using the EDGE BLENDING features .....	47		
Using the magnify feature .....	51		
Temporarily freezing the screen .....	52		
Temporarily shading the screen .....	52		
PbyP (Picture by Picture) / PinP (Picture in Picture) .....	53		
Using the menu function .....	57		
Indication in OSD, Containing items of each menu .....			

## Introduction

### Features

The projector provides you with the broad use by the following features.

- ✓ The **HDMI™/Display Port/HDBaseT™** ports can support various image equipment which have digital interface to get clearer pictures on a screen.
- ✓ The super bright lamp and high quality optical system can fulfill the demands of professional uses.
- ✓ Some optional lens units and the wide range of the lens shift feature will give much more chances to install the product wherever you want.
- ✓ The wealth of I/O ports is believed to support any business scene.
- ✓ Has an HDCR and an ACCENTUALIZER features which are Hitachi's original image stabilizer for a clearer image.
- ✓ Has a DICOM® (“Digital Imaging and Communication in Medicine”) simulation mode. This mode simulates the DICOM standard, which is a standard applicable to digital communications in medicine.
- ✓ The built-in 16W speaker can deliver sufficient sound volume in a large space like a classroom without external speakers.
- ✓ COLOR MANAGEMENT can correct an image by dividing it into three-dimensional space such as color phase, color saturation, and brightness.
- ✓ Equipped with IMAGE OPTIMIZER which is Hitachi's original function to maintain visibility by automatic image correction in accordance with lamp deterioration.

### Checking the contents of package

Please see the **Contents of package** section in the **User's Manual (concise)** which is a book. Your projector should come with the items shown there. Require of your dealer immediately if any items are missing.

**⚠ WARNING** ► Keep small parts away from children and pets. Take care not to put in the mouth. If swallowed, consult a physician immediately for emergency treatment.

**NOTE** • Keep the original packing materials for future reshipment. Be sure to use the original packing materials when moving the projector. Remove the lens unit and attach the lens hole cover when moving the projector.

## Part names

### Projector

- (1) Lamp cover (📖108)  
The lamp unit is inside.
- (2) Speakers (x2) (📖37, 80)
- (3) Filter cover (📖110)  
The air filter and intake vent are inside.
- (4) Elevator feet (x2) (📖40)
- (5) Remote sensors (x2) (📖30, 95)
- (6) Lens hole cover
- (7) Indicators (📖5)
- (8) Intake vents
- (9) Control panel (📖5)
- (10) Status Monitor (📖31)
- (11) AC (AC inlet) (📖27)
- (12) Exhaust vents
- (13) Ports (📖6)
- (14) Security bar (📖26)
- (15) Security slot (📖26)
- (16) Safety bar (📖26)
- (17) Battery cover (📖112)

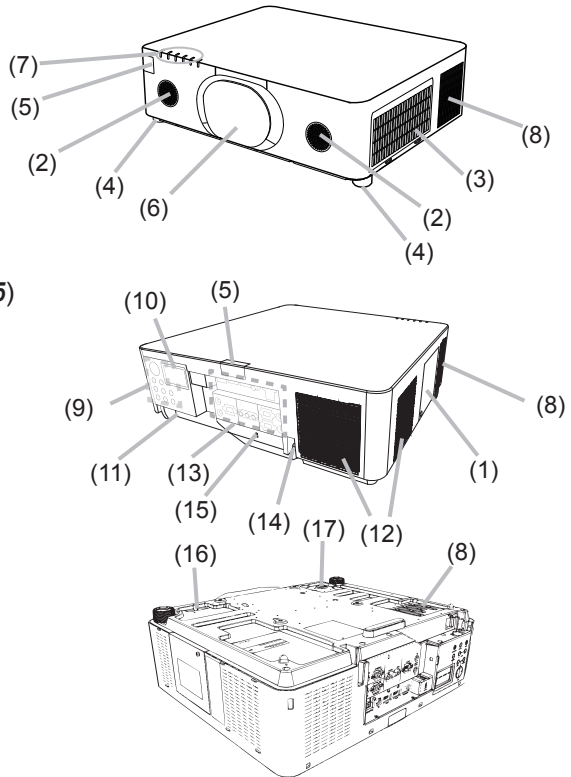

**⚠ WARNING** ▶ Do not open or remove any portion of the product, unless the manuals direct it.

▶ Do not subject the projector to unstable conditions.

▶ Do not apply a shock or pressure to this product. Remove all the attachments including the power cord and cables, from the projector when carrying the projector.

▶ Do not look into the lens and the openings on the projector while the lamp is on since the projection ray may cause a trouble on your eyes.

▶ Keep any object away from concentrated projection light beam. Blocking the beam by something causes high temperature and could result in fire or smoke.

**⚠ CAUTION** ▶ Do not touch around the lamp cover and the exhaust vents during use or just after use, since it is too hot.

▶ Do not attach anything onto the lens except the lens cover of this projector because it could damage the lens, such as melting the lens.



(continued on next page)

## Part names (continued)

## Control panel and Indicators

- (1) **STANDBY/ON** button (📖 35)
- (2) **INPUT** button (📖 38, 57)
- (3) **MENU** button (📖 57)
- (4) **LENS SHIFT** button (📖 41)
- (5) **ZOOM** button (📖 41)
- (6) **FOCUS - / +** buttons (📖 41)
- (7) **SHADE** button (📖 52)
- (8) **FUNCTION** button (📖 33, 42)
- (9) **FILTER** indicator (📖 121)
- (10) **SHADE** indicator (📖 52)
- (11) **SECURITY** indicator (📖 107)
- (12) **LAMP** indicator (📖 117 ~ 120)
- (13) **TEMP** indicator (📖 117 ~ 120)
- (14) **POWER** indicator (📖 35, 117 ~ 120)

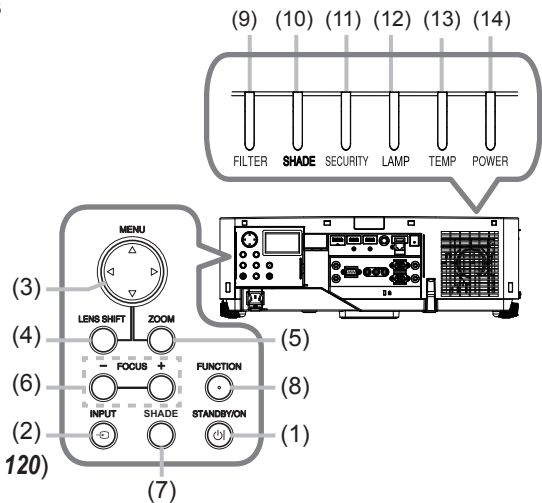

(continued on next page)

Part names (continued)

Ports (13~22)

- |                             |                                      |
|-----------------------------|--------------------------------------|
| (1) <b>COMPUTER IN</b> port | (9) <b>SDI</b> port (CP-WU8700 only) |
| (2) <b>HDBaseT</b> port     | (10) <b>AUDIO IN1</b> port           |
| (3) <b>LAN</b> port         | (11) <b>AUDIO IN2 (L, R)</b> ports   |
| (4) <b>WIRELESS</b> port    | (12) <b>AUDIO OUT</b> port           |
| (5) <b>HDMI 1</b> port      | (13) <b>MONITOR OUT</b> port         |
| (6) <b>HDMI 2</b> port      | (14) <b>REMOTE CONTROL IN</b> port   |
| (7) <b>DisplayPort</b> port | (15) <b>REMOTE CONTROL OUT</b> port  |
| (8) <b>VIDEO</b> port       | (16) <b>CONTROL</b> port             |

**CP-WU8600/CP-WX8650/CP-WX8750/CP-X8800**

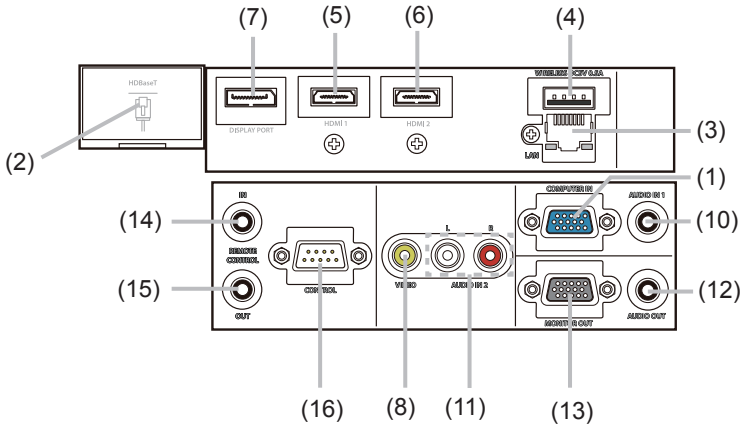

**CP-WU8700**

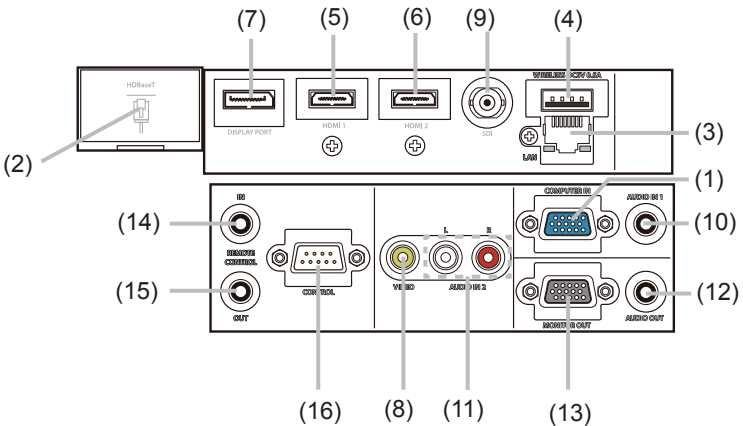

## Part names (continued)

## Remote control

- (1) **STANDBY** button (📖35)
- (2) **ON** button (📖35)
- (3) **ID - 1 / 2 / 3 / 4** buttons (📖29)
- (4) **COMPUTER 1** button (📖38)
- (5) **COMPUTER 2** button \*
- (6) **VIDEO** button (📖38)
- (7) **LAN** button (📖38)
- (8) **USB TYPE A** button \*
- (9) **USB TYPE B** button \*
- (10) **HDMI 1** button (📖38)
- (11) **HDMI 2** button (📖38)
- (12) **DisplayPort** button (📖38)
- (13) **HDBaseT** button (📖38)
- (14) **SDI** button  
(Supported only for CP-WU8700) (📖38)
- (15) **DIGITAL** button \*
- (16) **FOCUS + / -** buttons (📖41)
- (17) **ZOOM + / -** buttons (📖41)
- (18) **LENS SHIFT** button (📖41)
- (19) **LENS MEMORY LOAD / SAVE** buttons (📖42)
- (20) **LENS LOCK** button (📖94)
- (21) **OSD MSG** button (📖79)
- (22) **▲/▼/◀/▶** cursor buttons
- (23) **ENTER** button (📖33, 57)
- (24) **AV MUTE** button (📖37)
- (25) **MENU** button (📖57)
- (26) **GEOMETRY** button (📖74, 75)
- (27) **PICTURE** button (📖63 ~ 65)
- (28) **LAMP** button (📖75, 76)
- (29) **RESET** button (📖57)
- (30) **ASPECT** button (📖39)
- (31) **AUTO** button (📖43)
- (32) **MAGNIFY ON / OFF** buttons (📖51)
- (33) **VOL + / -** buttons (📖37)
- (34) **FREEZE** button (📖52)
- (35) **PbyP** button (📖53)
- (36) **MY BUTTON - 1 / 2 / 3 / 4** buttons (📖89, 90)
- (37) Battery cover (📖28)
- (38) Wired remote control port (📖20)

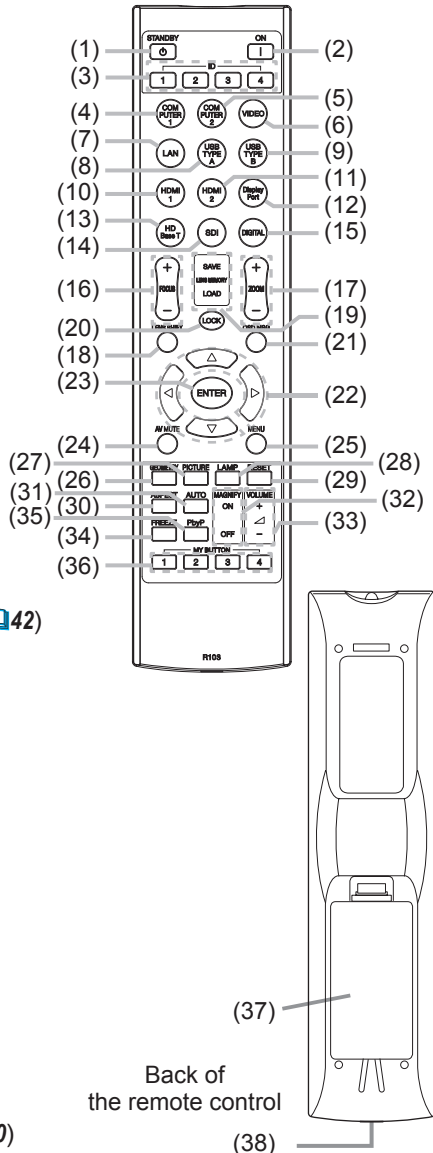

**NOTE** • Any button marked with “\*” is not supported on this projector (📖116).  
 • Each time you press any button (except ID buttons), the ID button of current selected ID number will light (📖29).

## Setting up

Install the projector according to the environment and manner the projector will be used in.

For the case of installation in a special state such as ceiling mount, the specified mounting accessories and service may be required. Before installing the projector, consult your dealer about your installation.

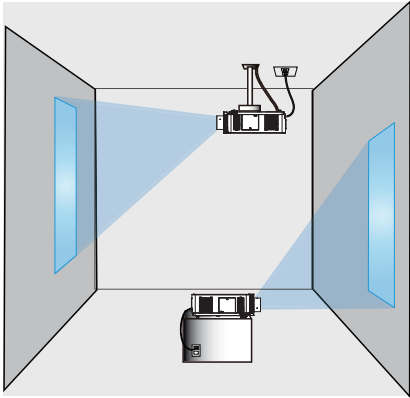

## Installing the lens unit

See the manual of the optional lens.

Secure a clearance of 50cm or greater between the exhaust vents and walls, and a clearance of 30cm or greater between the intake vents and walls. Assume that there is enough clearance in the front, back, and top of the projector in the figure below.

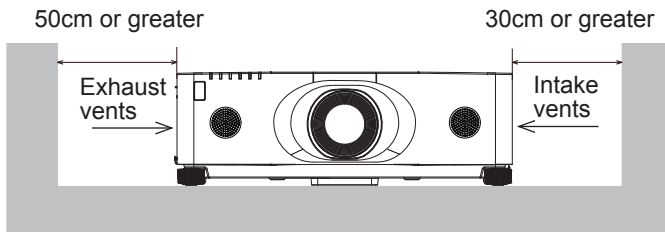

(continued on next page)



**Setting up (continued)**

Secure a clearance of 50cm or greater between the exhaust vents and walls. Assume that there is enough clearance in the front, sides, and top of the projector in the figure below.

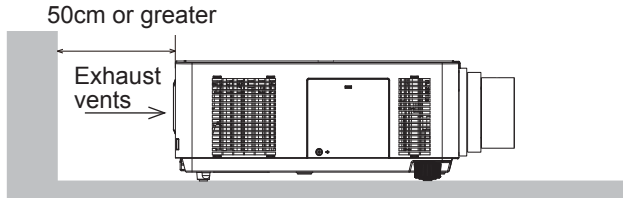

Secure a clearance of 50cm or greater when installing the projectors side by side. As for the required clearance not shown in the figure below, follow the installation mentioned above.

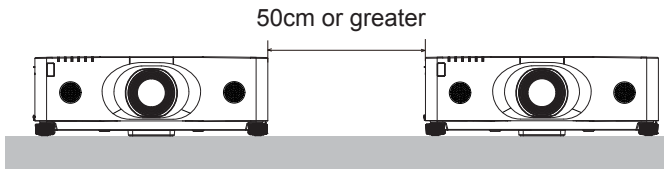

Secure a clearance of 30cm or greater between the intake vents and walls when installing the projector in portrait mode. As for the required clearance not shown in the figure below, follow the installation mentioned above.

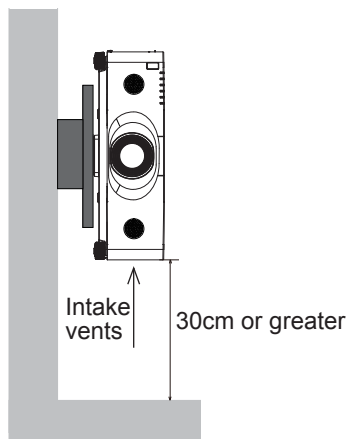

## Arrangement

Refer to tables T-1 to T-3 at the back of **User's Manual (concise)** as well as the following to determine the screen size and projection distance. The values shown in the table are calculated for a full size screen.

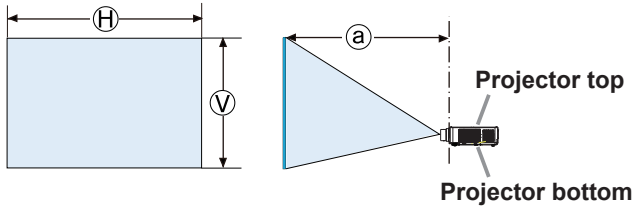

Ⓜ × Ⓥ : Screen size

ⓐ : Projection distance (from the front of the projector unit)

(continued on next page)

**Arrangement (continued)**

**⚠ WARNING ▶ Install the projector where you can access the power outlet easily.** If an abnormality should occur, unplug the projector urgently. Otherwise it could cause a fire or electric shock.

**▶ Do not subject the projector to unstable conditions.** If the projector falls or topples over, it could result in injury or damage to the projector and the surrounding things. Using a damaged projector could result in a fire and an electric shock.

- Do not place the projector in unstable places, such as an inclined surface, places subject to vibration, on top of a wobbly table or cart, or a surface that is smaller than the projector.
- Do not put the projector on its side, front or rear position.
- Do not attach nor place anything on the projector unless otherwise specified in the manual.
- Do not use any mounting accessories except the accessories specified by the manufacturer. Read and keep the manuals of the accessories used.
- For special installation such as ceiling mounting, be sure to consult your dealer beforehand.
- It is possible to install the projector for any direction with specified mounting accessories. Consult with your dealer about such a special installation.
- Remove all the attachments including the power cord and cables, from the projector when carrying the projector.

**▶ Do not install the projector near thermally conductive or flammable things.** Such things when heated by the projector could result in a fire and burns.

- Do not place the projector on a metal stand.

**▶ Do not place the projector where any oils, such as cooking or machine oil, are used.** Oil may harm the product, resulting in malfunction, or falling from the mounted position.

**▶ Do not place the projector in a place where it may get wet.** Getting the projector wet or inserting liquid into the projector could cause a fire and an electric shock, and damage the projector.

- Do not place the projector near water, such as in a bathroom, kitchen, or poolside.
- Do not place the projector outdoors or by the window.
- Do not place anything containing liquid near the projector.

**▶ Do not block the intake vents and exhaust vents of the projector.** If the intake vents and exhaust vents of the projector are blocked, the accumulated inside heat may cause fire.

(continued on next page)

**Arrangement (continued)**

**⚠ CAUTION ▶ Place the projector in a cool place with sufficient ventilation.** The projector may shutdown automatically or may malfunction if its internal temperature is too high.

Using a damaged projector could result in a fire and an electric shock.

- Do not place the projector in direct sunlight or near hot objects such as heaters.
- Do not place the projector where the air from an air conditioner or similar unit will blow on it directly.
- Do not place the projector on carpet, cushions or bedding.
- Do not stop up, block nor cover the projector's vent holes. Do not place anything around the projector that could be sucked in or stuck to the projector's intake vents.
- Do not place the projector at places that are exposed to magnetic fields, doing so can cause the cooling fans inside the projector to malfunction.

**▶ Avoid placing the projector in smoky, humid or dusty place.** Placing the projector in such places could cause a fire, an electric shock and malfunction of the projector.

- Do not place the projector near humidifiers. Especially for an ultrasonic humidifier, chlorine and minerals contained in tap water are atomized and could be deposited in the projector causing image degradation or other problems.
- Do not place the projector in a smoking area, kitchen, passageway or by the window.

**NOTICE** • Position the projector to prevent light from directly hitting the projector's remote sensor.

- Do not place the product in a place where radio interference may be caused.
- Set the ALTITUDE of the SERVICE item in the OPTION menu correctly. It is recommended to leave it at AUTO usually (📄93). If the projector is used with a wrong setting, it may cause damage to the projector itself or the parts inside.
- Keep heat-sensitive things away from the projector. Otherwise, they may be damaged by the heat from the projector.

**NOTE** • When the temperature inside the projector rises high, it may cause the high rotation of the fan for cooling temporarily.

## Connecting with your devices

Before connecting the projector to a device, consult the manual of the device to confirm that the device is suitable for connecting with this projector and prepare the required accessories, such as a cable in accord with the signal of the device. Consult your dealer when the required accessory did not come with the product or the accessory is damaged.

After making sure that the projector and the devices are turned off, perform the connection, according to the following instructions. Refer to the figures in subsequent pages.

Before connecting the projector to a network system, be sure to read **Network Guide** too.

**⚠ WARNING ▶ Use only the appropriate accessories.** Otherwise it could cause a fire or damage the projector and devices.

- Use only the accessories specified or recommended by the projector's manufacturer. It may be regulated under some standard.
- Neither disassemble nor modify the projector and the accessories.
- Do not use the damaged accessory. Be careful not to damage the accessories. Route a cable so that it is neither stepped on nor pinched out.

**⚠ CAUTION ▶ For a cable with a core at only one end, connect the end with the core to the projector.** That may be required by EMI regulations.

**NOTE** • Do not turn on or off the projector while connected to a device in operation, unless that is directed in the manual of the device. Otherwise it may cause malfunction in the device or projector.

- The function of some input ports can be selected according to your usage requirements. Check the reference page indicated beside each port in the following illustration.
- Be careful not to mistakenly connect a connector to a wrong port. Otherwise it may cause malfunction in the device or projector.
  - When connecting a connector to a port, make sure that the shape of the connector fits the port.
  - Tighten the screws to connect a connector equipped with screws to a port.
  - Use the cables with straight plugs, not L-shaped ones, as the input ports of the projector are recessed.

### About Plug-and-Play capability

- Plug-and-Play is a system composed of a computer, its operating system and peripheral equipment (i.e. display devices). This projector is VESA DDC 2B compatible. Plug-and-Play can be used by connecting this projector to a computer that is VESA DDC (display data channel) compatible.
  - Take advantage of this feature by connecting a computer cable to the **COMPUTER IN** port (DDC 2B compatible). Plug-and-Play may not work properly if any other type of connection is attempted.
  - Please use the standard drivers in your computer as this projector is a Plug-and-Play monitor.

(continued on next page)

Connecting with your devices (continued)

**CP-WU8600/CP-WX8650/CP-WX8750/CP-X8800**

Computer

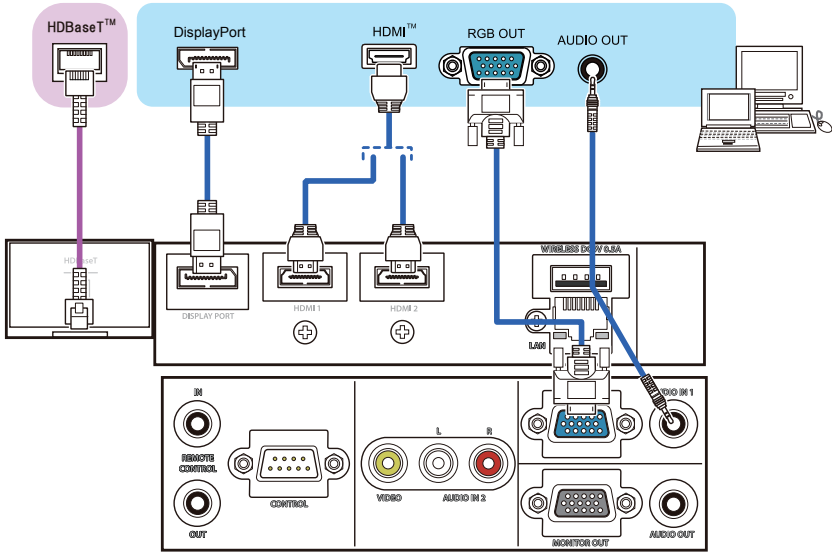

**CP-WU8700**

Computer

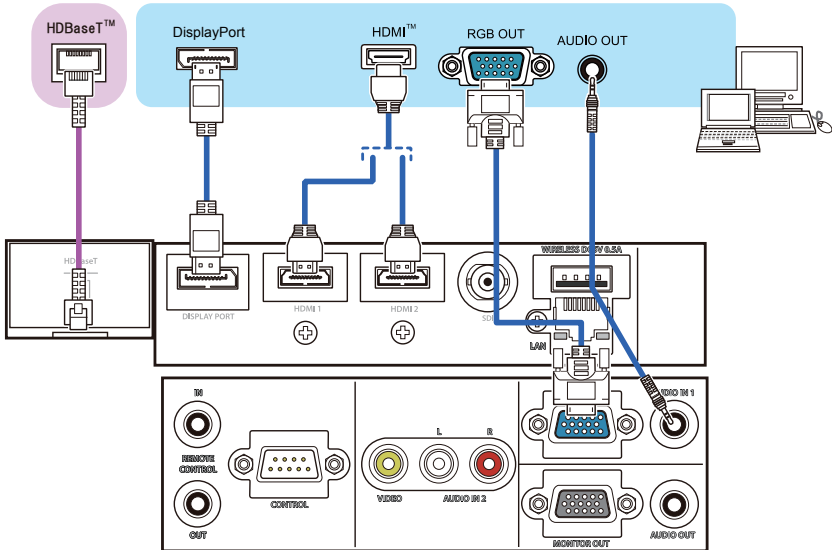

(continued on next page)

## Connecting with your devices (continued)

- NOTE** • Before connecting the projector to a computer, consult the computer's manual and check the compatibility of the signal level, the synchronization methods and the display resolution output to the projector.
- Some signal may need an adapter to input this projector.
  - Some computers have multiple screen display modes that may include some signals which are not supported by this projector.
  - Although the projector can display signals with a resolution up to UXGA (1600x1200) or up to W-UXGA (1920x1200), the signal will be converted to the projector's panel resolution before being displayed. The best display performance will be achieved if the resolutions of the input signal and the projector panel are identical.
  - If you connect this projector and a notebook computer, you need output the display to an external monitor, or output simultaneously to the internal display and an external monitor. Consult the computer's manual for the setting.
  - Depending on the input signal, the automatic adjustment function of this projector may take some time and not function correctly.
  - Note that a composite sync signal or sync-on-green signal may confuse the automatic adjustment function of this projector (71).
  - If the automatic adjustment function does not work correctly, you may not see the dialog to set the display resolution. In such a case, use an external display device. You may be able to see the dialog and set an appropriate display resolution.
  - Use DisplayPort cables conforming to the DisplayPort standard.
  - Use of DisplayPort cables not conforming to the DisplayPort standard may cause abnormal operations such as images with interruption or not displayed.
  - When the projector is connected to the output of the computer with an early type of chipset or graphics card that supports the DisplayPort, the projector and/or computer may not operate normally. In that case, turn off the projector and/or computer, then turn on again.
  - When connecting the output of the DisplayPort to the input of the projector, use of the computer with the newest chipset or graphics card is recommended.
  - Commercially available DisplayPort cables may have lock system. When Unplugging the cable, push the button on the connector of the cable.
  - Some computers may take a long time to display the image.
  - Power supply is available to the connected device with the input port of DisplayPort. However, it is not available to the computer.
  - When the signal from the device with a signal converting adapter is connected to the input port of DisplayPort, the image may not be displayed.
  - Use a commercially available converter when connecting the output port of HDMI of the computer with the input port of DisplayPort of the projector.

(continued on next page)

Connecting with your devices (continued)

**CP-WU8600/CP-WX8650/CP-WX8750/CP-X8800**

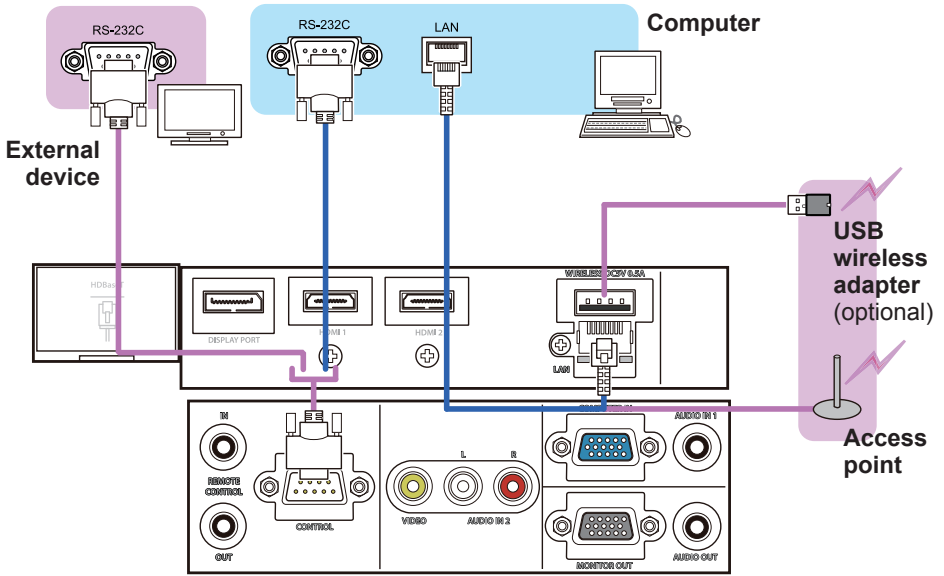

**CP-WU8700**

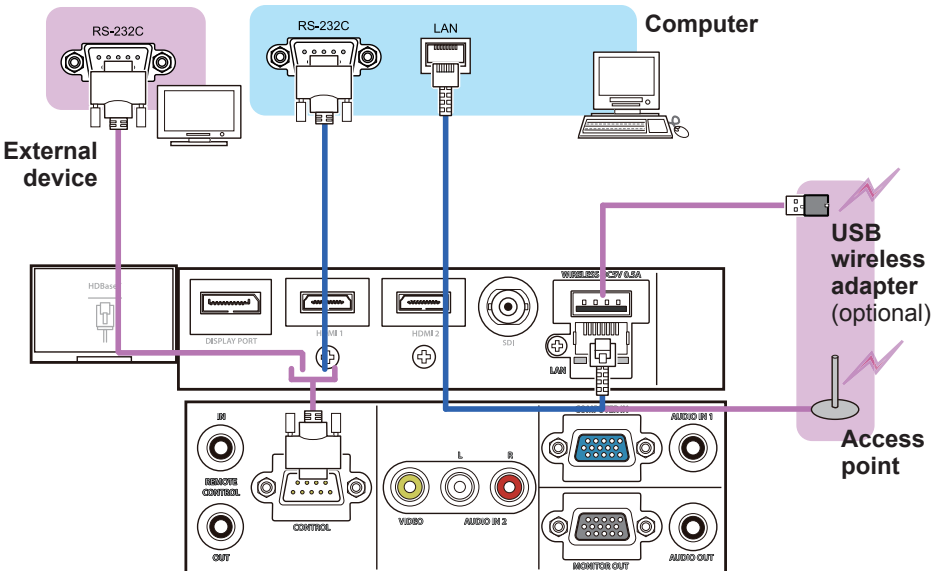

(continued on next page)



**Connecting with your devices (continued)**

⚠ **WARNING** ▶ Heat may build up in the USB wireless adapter, to avoid possible burns disconnect the projector power cord for 10 minutes before touching the adapter.

▶ When using the USB wireless adapter, use the supplied adapter cover or terminal cover (📄 24, 25).

⚠ **CAUTION** ▶ Before connecting the projector to a network system be sure to obtain the consent of the administrator of the network.

▶ Do not connect the **LAN** port to any network that might have the excessive voltage.

▶ The designated USB wireless adapter that is sold as an option is required to use the wireless network function of this projector. Before connecting the USB wireless adapter, turn off the power of the projector and disconnect the power cord. Do not use any extension cable or device when connecting the adapter to the projector.

▶ To connect both the LAN cable and USB wireless adapter to the projector, use a LAN cable that is flat on the side where the plug's wire is visible. Otherwise, both of them cannot be connected correctly, or the wire may break (malfunction).

(continued on next page)

Connecting with your devices (continued)

**CP-WU8600/CP-WX8650/CP-WX8750/CP-X8800**

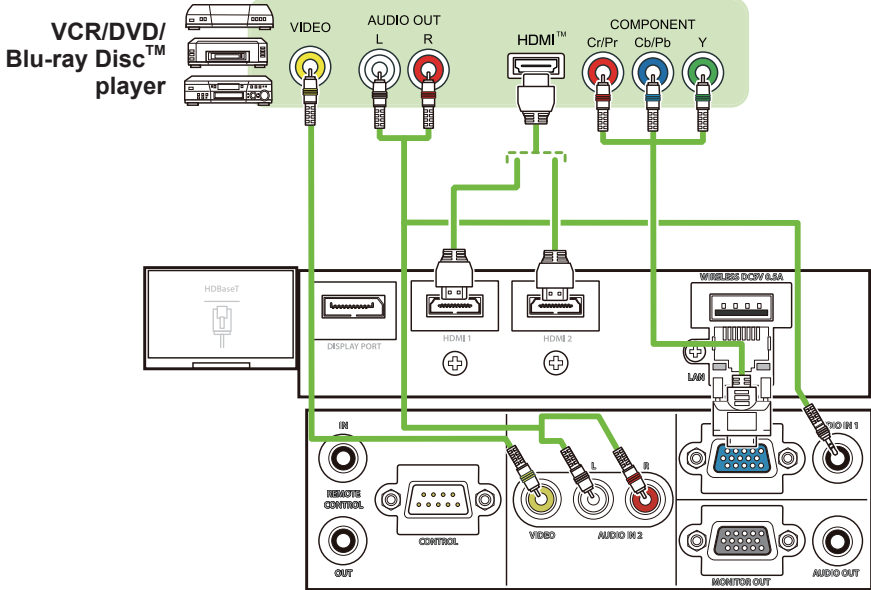

**CP-WU8700**

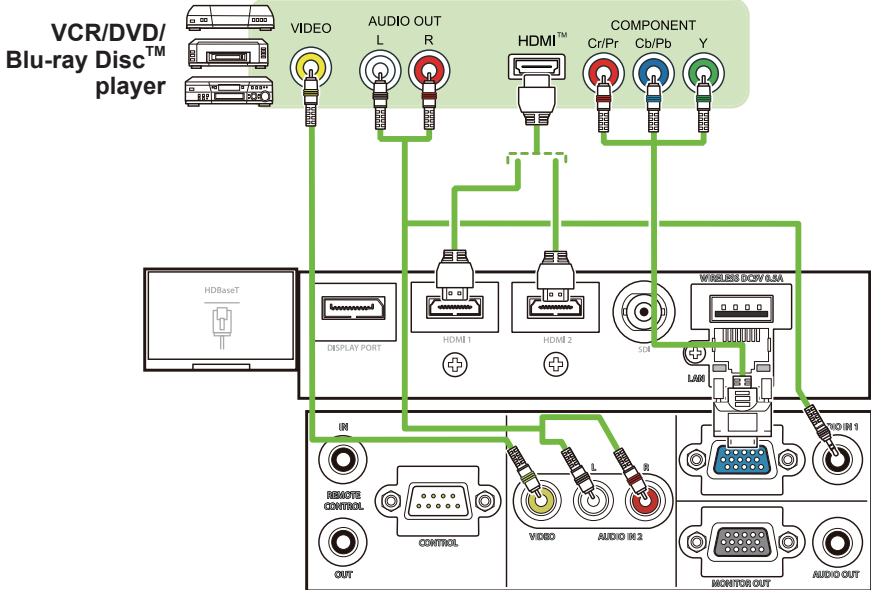

(continued on next page)

## Connecting with your devices (continued)

### About HDBaseT™ connection

- HDBaseT is a technology to transmit image, sound, ethernet or serial control signal via LAN cable.
- Please go to the following URL regarding the device of other company that supports HDBaseT and has been confirmed compatible with this projector.

<http://www.hitachi.co.jp/proj/>

LAN or HDBaseT input port can be selected as ethernet signal input by switching in the menu.

- Use LAN cables of up to 100m long. Exceeding this length, the image and sounds will be deteriorated, and even experience malfunction on LAN transmission.

**NOTE** • The **HDMI** ports of this model are compatible with HDCP (High-bandwidth Digital Content Protection) and therefore capable of displaying video signals from HDCP compatible DVD players or the like.

- The **HDMI** ports support the following signals:

For Video signals, refer to User's Manual (detailed) Technical.

Audio signal : Format Linear PCM

Sampling frequency 48kHz / 44.1kHz / 32kHz

- This projector can be connected with another equipment that has HDMI™ connector, but with some equipment the projector may not work properly, something like no video.
- Qualified cable is required for HDBaseT connection.
- Be sure to use an HDMI™ cable that has the HDMI™ logo.
- Use a Category 2-certified HDMI™ cable to input 1080p@50/60 signal to the projector.
- When the projector is connected with a device having DVI connector, use a DVI to HDMI™ cable to connect with the HDMI™ input.
- The HDMI™ cables might come off easily due to the lack of a mechanical lock on the cables and connectors. It is recommended to fasten the HDMI cables by using the HDMI cable holder and the Cable tie to prevent them from coming off (📖 23).

(continued on next page)

Connecting with your devices (continued)

**CP-WU8600/CP-WX8650/CP-WX8750/CP-X8800**

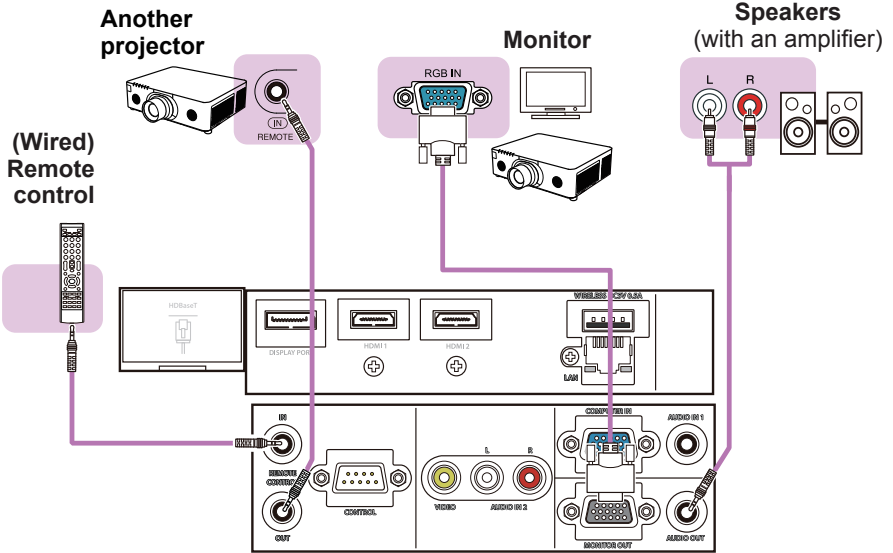

**CP-WU8700**

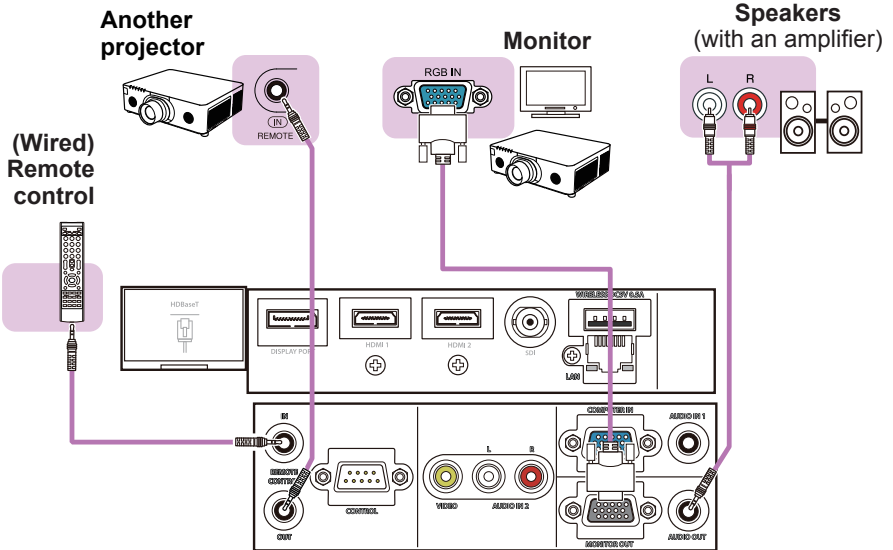

(continued on next page)

**Connecting with your devices (continued)**

**NOTE** • To use a wired remote control, connect a wired remote control to the **REMOTE CONTROL IN** port. You can also connect another projector to the **REMOTE CONTROL OUT** port to control it from the wired remote control. You can utilize this projector as a remote control-relay with the **REMOTE CONTROL IN** and **OUT** ports. To connect the wired remote control or another projector to the **REMOTE CONTROL IN** or **OUT** ports, use audio cables with 3.5 mm diameter stereo mini plugs. This function is useful when a wireless remote signal may not reliably reach the projector.

(continued on next page)

Connecting with your devices (continued)

CP-WU8700

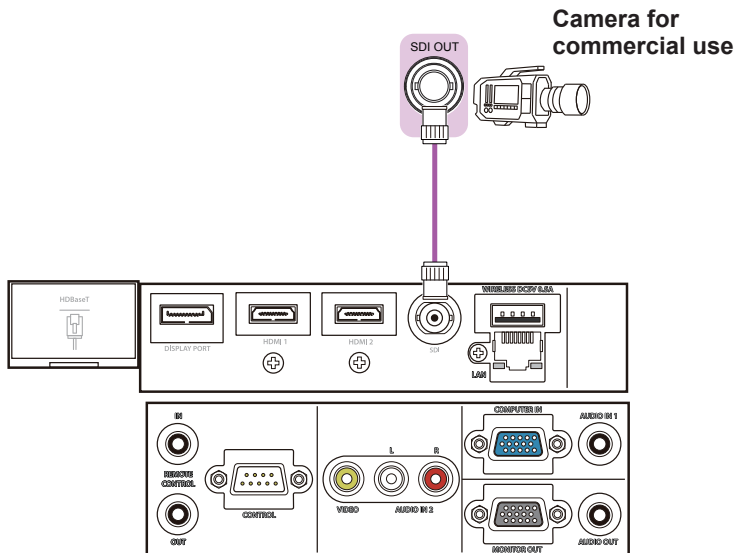

**NOTE** • The SDI port of this model supports the following SDI signals:

SD-SDI signal: conforming to SMPTE ST 259-C standard

YCBCR 4:2:2 10-bit

480i, 576i

Single link HD-SDI signal: conforming to SMPTE ST 292 standard

YPBPR 4:2:2 10-bit

720p@50/60, 1080i@50/60, 1080sf@25/30

3G-SDI Level-A signal: conforming to SMPTE ST 424 standard

YPBPR 4:2:2 10-bit

1080p@50/60

- This projector can be connected with another equipment that has SDI connector, but with some equipments the projector may not work properly.
- Use a cable of 5CFB or greater (5CFB, 7CFB, etc.), or Belden 1694A or greater to transmit the image properly. And use a cable with a length of 100m or less.
- Setting by MENU is necessary depending on a connected device.

## Fastening the cables

Remove the screw located on the lower side of HDMI connector and use it to attach the HDMI cable holder.

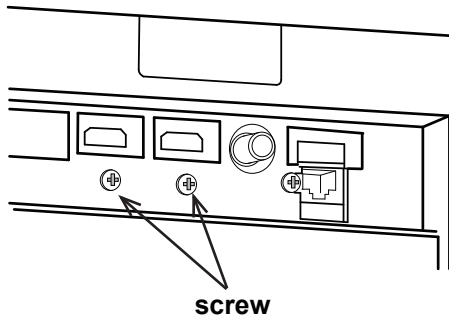

It is recommended to fasten the HDMI cables by using the HDMI cable holder and the Cable tie to prevent them from coming off. Use a Cable tie with the size of 2.0 x 4.0mm or smaller.

No cable tie

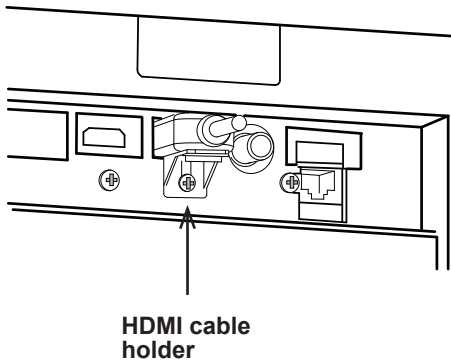

With cable tie

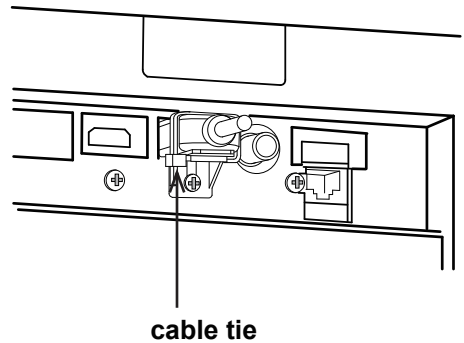

- ⚠ **WARNING** ▶ Do not fasten the cables other than HDMI.
- ⚠ **CAUTION** ▶ To fasten the cable, use a supplied Cable tie or plastic tie with the size of 2.0 x 4.0mm or smaller. A metallic tie may cause damage to the cables and tie holder.
- ▶ Do not bind the cables too tightly. The cables or the hole might be damaged.

## Fastening the adapter cover

When using the USB wireless adapter, use the supplied adapter cover for theft prevention.

**USB wireless adapter:** USB-WL-11N

Temperature range: 0 ~ 45°C(operating)

1. Loosen the screw on the bottom left of the **WIRELESS** port.

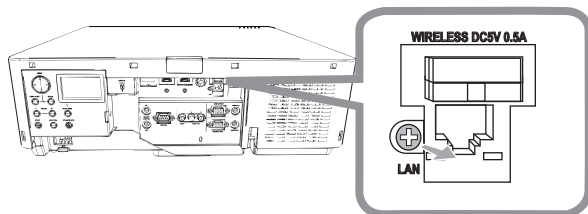

2. Insert the tab of the cover into the hole at the upper right of the **WIRELESS** port in the direction of the arrow.

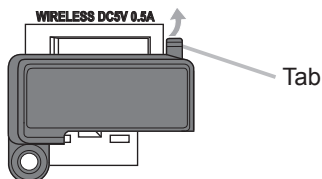

3. Align the screw holes on the projector and the cover. Then insert the screw removed from the projector into the hole and tighten the screw.

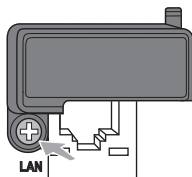

**⚠ WARNING** ► Keep small parts away from children and pets. Take care not to put in the mouth.

► Heat may build up in the USB wireless adapter, to avoid possible burns disconnect the projector power cord for 10 minutes before touching the adapter.



## Attaching the terminal cover

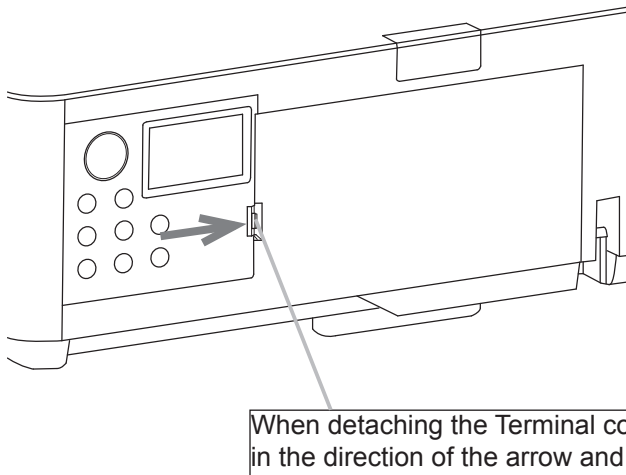
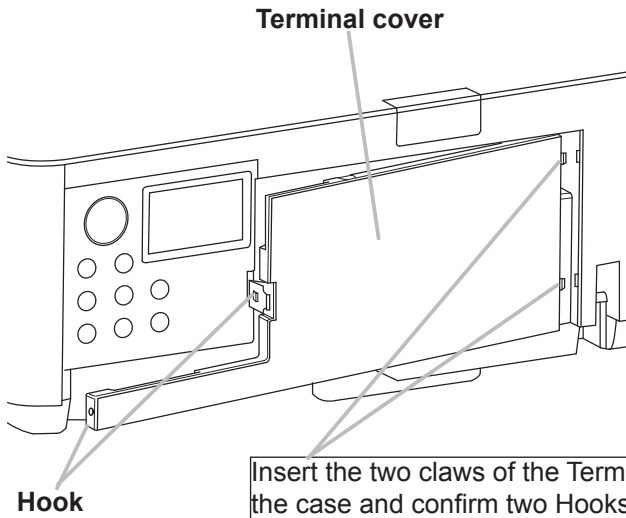

**NOTE** • Do not attach the Adapter cover when attaching the Terminal cover.

## Using the security bar and slot

A commercially available anti-theft chain or wire can be attached to the security bar on the projector. Refer to the figure to choose an anti-theft chain or wire.

Also this product has the security slot for the Kensington lock.

For details, see the manual of the security tool.

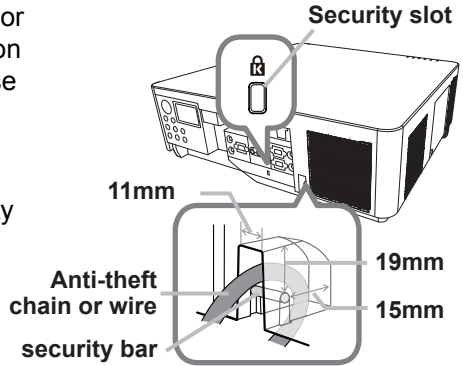

**⚠ WARNING** ▶ Do not use the security bars and slot to prevent the projector from falling down, since it is not designed for it.

**⚠ CAUTION** ▶ Do not place anti-theft chain or wire near the exhaust vents. It may become too hot.

- NOTE** • The security bar and slot is not comprehensive theft prevention measures. It is intended to be used as supplemental theft prevention measure.
- The safety bar (📖4) can be used for the same purpose as the security bar.

## Connecting power supply

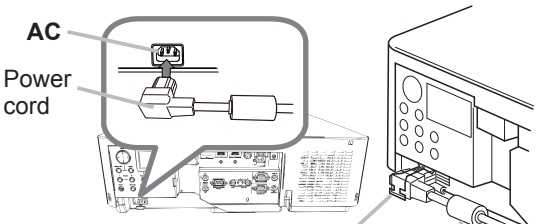
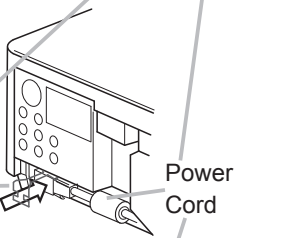
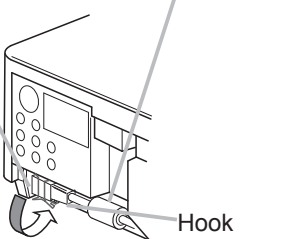
1. Put the connector of the power cord into the **AC** (AC inlet) of the projector.  

2. Push the Cord Stopper until it is caught by the hook.  

3. Firmly plug the power cord's plug into the outlet. In a couple of seconds after the power supply connection, the **POWER** indicator will light up in steady orange.  

Please remember that when the **DIRECT POWER ON** function activated, the connection of the power supply make the projector turn on.

**⚠ WARNING** ▶ Do not connect the projector to a power supply while no lens unit is attached to it.

▶ Please use extra caution when connecting the power cord, as incorrect or faulty connections may result in fire and/or electrical shock.

- Do not touch the power cord with a wet hand.
- Only use the power cord that came with the projector. If it is damaged, consult your dealer to get a new one. Never modify the power cord.
- Only plug the power cord into an outlet whose voltage is matched to the power cord. The power outlet should be close to the projector and easily accessible. Remove the power cord for complete separation.
- Do not distribute the power supply to multiple devices. Doing so may overload the outlet and connectors, loosen the connection, or result in fire, electric shock or other accidents.
- Connect the ground terminal for the AC inlet of this unit to the ground terminal of the building using an appropriate power cord (bundled).

**NOTICE** • This product is also designed for IT power systems with a phase-to-phase voltage of 220 to 240 V.

## Remote control

**Installing the batteries**

Please insert the batteries into the remote control before using it. If the remote control starts to malfunction, try to replace the batteries. If you will not use the remote control for long period, remove the batteries from the remote control and store them in a safe place.

1. Holding the hook part of the battery cover, remove it.
2. Align and insert the two AA batteries according to their plus and minus terminals as indicated in the remote control. (Use the appropriate AA carbon-zinc or alkaline batteries (non-rechargeable) in accordance with laws and regulations.)
3. Replace the battery cover in the direction of the arrow and snap it back into place.

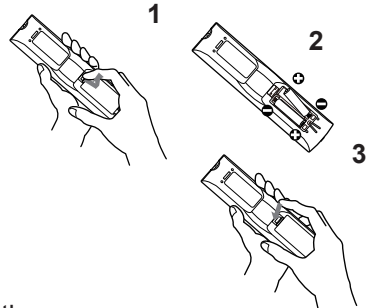

**⚠ WARNING** ► Always handle the batteries with care and use them only as directed. Improper use may result in battery explosion, cracking or leakage, which could result in fire, injury and/or pollution of the surrounding environment.

- Be sure to use only the batteries specified. Do not use batteries of different types at the same time. Do not mix a new battery with used one.
- Make sure the plus and minus terminals are correctly aligned when loading a battery.
- Keep a battery away from children and pets.
- Do not recharge, short circuit, solder or disassemble a battery.
- Do not place a battery in a fire or water. Keep batteries in a dark, cool and dry place.
- If you observe battery leakage, wipe out the leakage and then replace a battery. If the leakage adheres to your body or clothes, rinse well with water immediately.
- Obey the local laws on disposing the battery.

## Using the REMOTE ID function

Utilize this function to control specific projectors by the remote control assigned the same ID number when you use multiple projectors of the same type at the same time.

Assign an ID number to each projector before using the REMOTE ID item in the SERVICE menu of the OPTION menu (☰95). Press the **ID** button with the same ID number as assigned to the projector you are going to control. The **ID** button selected will light for several seconds.

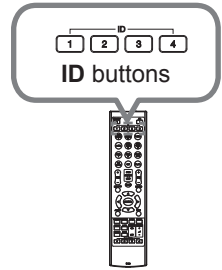

- NOTE**
- Each time you press any button (except **ID** buttons), the **ID** button of current selected ID number will light.
  - To confirm the projector's current ID, press any **ID** button for 3 seconds. Its number will be shown on each screen regardless of set ID of projector.

## Changing the frequency of remote control signal

The accessory remote control has the two choices on signal frequency Mode 1:NORMAL and Mode 2:HIGH. If the remote control does not function properly, attempt to change the signal frequency.

In order to set the Mode, please keep pressing the combination of two buttons listed below simultaneously for about 3 seconds.

(1) Set to Mode 1:NORMAL

**MENU** and **MY BUTTON-4** buttons

(2) Set to Mode 2:HIGH

**AV MUTE** and **MY BUTTON-1** buttons

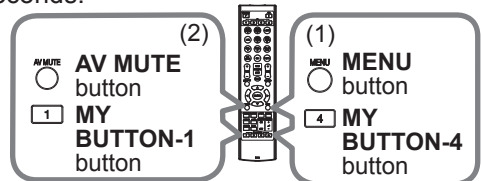

Please remember that the REMOTE

FREQ. in the SERVICE item of the OPTION menu (☰95) of the projector to be controlled should be set to the same mode as the remote control.

## About the remote control signal

The remote control works with the projector's remote sensor. This projector has two remote sensors on the front and back sides.

The sensors can sense signals within the following range:

60 degrees (30 degrees to the left and right of the sensor)  
within about 3 meters.

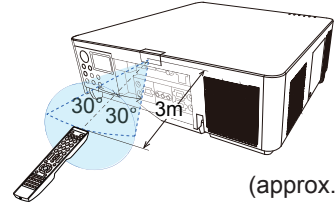
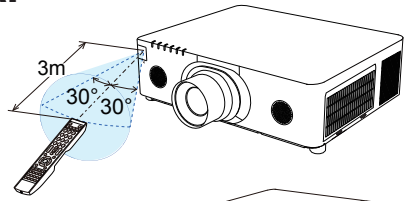

(approx.)

- NOTE** • You can deactivate one of the sensors using the REMOTE RECEIV. item in the SERVICE menu of the OPTION menu (📖95).
- The remote control signal reflected in the screen or the like may be available. If it is difficult to send the signal to the sensor directly, attempt to make the signal reflect.
  - The remote control uses infrared light to send signals to the projector (Class 1 LED), so be sure to use the remote control in an area free from obstacles that could block the remote control's signal to the projector.
  - The remote control may not work correctly if strong light (such as direct sun light) or light from an extremely close range (such as from an inverter fluorescent lamp) shines on the remote sensor of the projector. Adjust the position of projector avoiding those lights.

## Status Monitor

The Status Monitor is the sub LCD in the rear panel. The Status Monitor displays the present condition of the projector including errors, setup information and error history.

Status Monitor

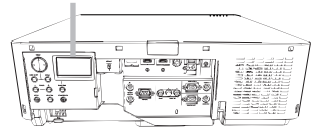

## Displaying the condition of the projector

If no buttons have been operated, the Status Monitor displays as below depending on the condition of the projector.

**NOTE** • The Status Monitor displays nothing while the projector is in standby mode if the STANDBY MODE item of SETUP menu is set to SAVING (📖78).  
 • When INSTALLATION in the SETUP menu is set to FRONT / CEILING or REAR / CEILING, the contents on the Status Monitor are displayed upside down (📖77).

### ○ In a normal state

The Status Monitor displays the state of the projector in three lines.

**1st line** : Displays the condition of the projector.  
 While the lamp is on, the selected port is displayed.

Displayed conditions are as below;

STANDBY: The projector is in standby mode.

WARM UP: The projector is warming up.

SEARCHING: The projector is searching an input signal.

COOL DOWN: The projector is cooling down.

**2nd line** : Displays the condition of the detected input signal while the lamp is on. Otherwise, displays the serial number of the projector.

Displayed conditions are as below;

SYNC OUT: Detected input signal is out of specified range.

NO SIGNAL: There is no input signal.

CONNECTED: The projector has connected to the network or the computer and some image is transferred to the projector while the **LAN** port is selected.

HOLD: The projector has connected to the network but no image is transferred while the **LAN** port is selected.

NOT CONNECTED: The projector is not connected to the network or the computer while the **LAN** port is selected.

**3rd line** : Displays supplied voltage and peripheral temperature in Celsius while the lamp is on.

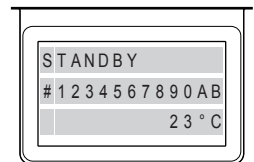

example

(continued on next page)

**Displaying the condition of the projector (continued)**

**NOTE** • While the projector is searching an input signal in normal condition, nothing is displayed on the 2nd line of the monitor.  
 • Displayed temperature might differ from actual peripheral temperature because the displayed temperature is measured inside of the projector.

○ **In error state**

The Status Monitor displays a warning of an error with larger letters. Resolve the errors referring to the table of the sections "**Related messages**" (📖114 ~ 116) and "**Regarding the indicator lamps**" (📖117 ~ 121) when the warning is displayed.



example

**Warnings;**

AIR (AIR FLOW): The internal temperature is rising.

Refer to the description of the message, "CHECK THE AIR FLOW" in the table (📖115).

COLD: There is a possibility that the interior portion has become over cooled.

Refer to the **LAMP** and **TEMP** indicators alternatively blinking in the table (📖120).

FILTR (FILTER): It is time to clean the air filter.

Refer to the **LAMP** and **TEMP** indicators simultaneous blinking in the table (📖120).

SHADE: Shade Error

Contact your dealer or service company.

SHIFT: Lens Shift Error

Contact your dealer or service company.

**Errors;**

COVER: The lamp cover has not been properly fixed.

Refer to the **LAMP** indicator blinking in the table (📖118).

FAN: The cooling fan is not operating.

Refer to the **TEMP** indicator blinking in the table (📖118).

LAMP: The lamp does not light.

Refer to the **LAMP** indicator lighting in the table (📖118).

TEMP: The projector's interior becomes over heated.

Refer to the **TEMP** indicator lighting in the table (📖119).

ACBLK: Refer to the **LAMP** indicator lighting in the table (📖118).

OTHER: Errors other than the above (📖119).

**NOTE** • When one of the warnings of FAN, LAMP, COVER, TEMP errors is displayed, the backlight blinks at the same time.



## Displaying the log

The present setup information and the error history can be displayed on the Status Monitor with button operation.

- NOTE**
- While the projector is warming up, button presses are ignored.
  - The Status Monitor displays nothing or no button presses for the monitor are available while the projector is in standby mode if the STANDBY MODE item of SETUP menu is set to SAVING (78).
  - Both of the Status Monitor and the OSD menu cannot be operated at the same time.

When the projector is in a normal condition, or displays one of the warnings of AIR FLOW, COLD or FILTER errors, press the **FUNCTION** button on the control panel, press the **ENTER** button on the remote control for three seconds or press one of the **MY BUTTON** buttons if assigned as STATUS MONITOR. The backlight of the monitor turns on.

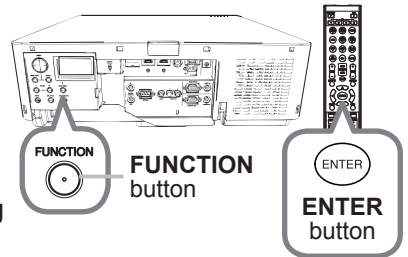

○ **To display the setup information including usage time**

Use the ◀/▶ buttons to switch display.

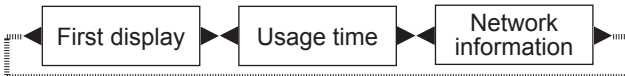

Usage time: The Status Monitor displays the lamp time (usage time of the present lamp), the filter time (usage time of the air filter) and the projector usage time.

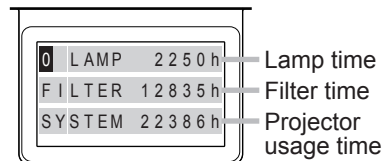

Usage time (example)

Network information: The network information is displayed over three pages.

Use the ▲/▼ buttons to switch the page.  
Displayed information in each page is as below;

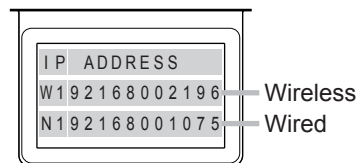
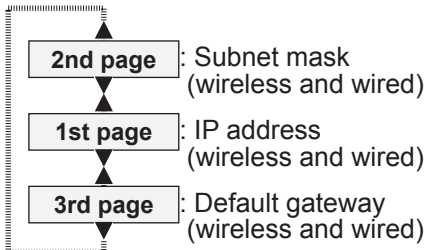

Network information (example)

(continued on next page)

Displaying the log (continued)

**NOTE** • The Status Monitor and its backlight returns to the first state before the **FUNCTION** or **ENTER** button was pressed when any button except cursor buttons is pressed, or after about 30 seconds without button operation.

- The projector usage time is the total lamp time from the projector is manufactured. It is not reset by using LAMP TIME in the SETUP menu (75).
- If the ▲/▼ buttons are pressed while the usage time is displayed, the usage time switches to the past one when an error occurred.

○ To display error history

Press the ▲ button to display previous error log. If a warning has been displayed, the first previous error log is the present error currently occurring. The Status Monitor displays the log number, occurred error, the supplied voltage and peripheral temperature at that time. Press the ► button to display the usage time when each error occurred.

Use the ▲/▼ buttons to switch the log. The display switches with the ◀/▶ buttons at each log. Up to 10 error logs including the present one can be displayed.

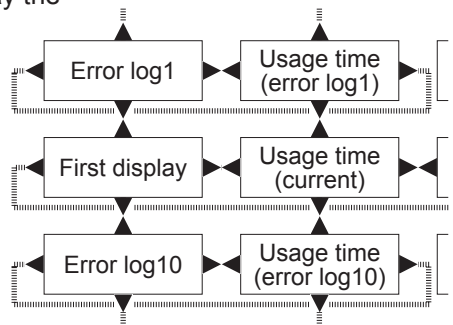
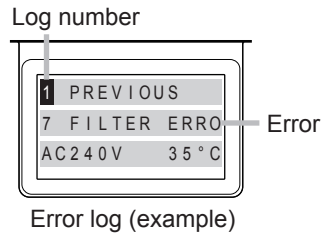

**NOTE** • The Status Monitor and its backlight returns to the first state before the **FUNCTION** or **ENTER** button was pressed when any button except cursor buttons is pressed, or after about 30 seconds without button operation.

- If no error or less than 10 errors have occurred, "NO DATA" is displayed in spite of occurred error in the error log.

## Power on/off

**Turning on the power**

1. Make sure that the power cord is firmly and correctly connected to the projector and the outlet.
2. Make sure that the **POWER** indicator is lighted in steady orange (📖117). Then remove the lens cover.
3. Press **STANDBY/ON** button on the projector or the **ON** button on the remote control.  
The projection lamp will light up and **POWER** indicator will begin blinking in green. When the power is completely on, the indicator will stop blinking and light in steady green (📖117).

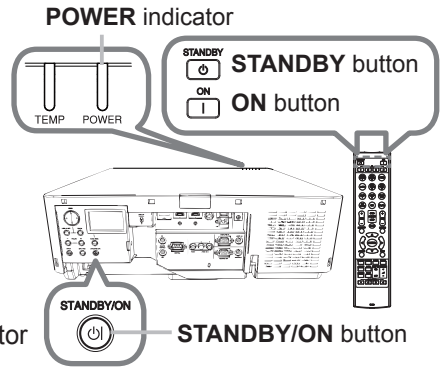

To display the picture, select an input signal according to the section **Selecting an input signal** (📖38).

**Turning off the power**

1. Press the **STANDBY/ON** button on the projector or the **STANDBY** button on the remote control.  
The message “Power off?” will appear on the screen for about 5 seconds.
2. Press the **STANDBY/ON** or **STANDBY** button again while the message appears.  
The projector lamp will go off, and the **POWER** indicator will begin blinking in orange. Then the **POWER** indicator will stop blinking and light in steady orange when the lamp cooling is complete (📖117).
3. Attach the lens cover, after the **POWER** indicator turns to steady orange.

Do not turn the projector on for about 10 minutes or more after turning it off. Also, do not turn the projector off shortly after turning it on. Such operations might cause the lamp to malfunction or shorten the lifetime of some parts including the lamp.

(continued on next page)

**⚠ WARNING** ▶ A strong light is emitted when the projector's power is on. Do not look into the lens of the projector or look inside of the projector through any of the projector's openings since the projection ray may cause a trouble on your eyes.

▶ Keep any object away from concentrated projection light beam. Blocking the beam by something causes high temperature and could result in fire or smoke.  
▶ Do not touch around the lamp cover and the exhaust vents during use or just after use, since it is too hot.

**NOTE** • Turn the power on/off in right order. Please power on the projector prior to the connected devices.

• This projector has the function that can make the projector automatically turn on/off. Please refer to the DIRECT POWER ON (📖88) and AUTO POWER OFF (📖88) items of the OPTION menu.

## Operating

**Adjusting the volume**

1. Use the **VOL + / -** buttons to adjust the volume. A dialog will appear on the screen to aid you in adjusting the volume. If you do not do anything, the dialog will automatically disappear after a few seconds.



VOLUME  
+  
-  
VOL + / -  
buttons

**NOTE** • When  $\times$  is selected for current picture input port, the volume adjustment is disabled. Please see AUDIO SOURCE item of AUDIO menu (80).  
 • Even if the projector is in the standby mode, the volume is adjustable when both of the following conditions are true:  
 - An option other than  $\times$  is selected for AUDIO OUT STANDBY in the AUDIO SOURCE item of the AUDIO menu (80).  
 - NORMAL is selected in the STANDBY MODE item of the SETUP menu (78).

**Temporarily turning off the screen and audio**

1. Press **AV MUTE** button on the remote control. The BLANK screen will be displayed instead of the screen of input signals and the sound from the internal speakers will be muted. Please refer to the BLANK item in SCREEN menu about the BLANK screen (81).



AV MUTE  
AV MUTE  
button

To exit from the AV MUTE mode and restore the screen and audio, press **AV MUTE** button again.

**NOTE** • The projector automatically exits from the AV MUTE mode when some control buttons are pressed.

**CAUTION** ▶ If you wish to have a blank screen while the projector's lamp is on, use the AV MUTE function above or the lens shade function (52). Taking any other action may cause the damage on the projector.

## Selecting an input signal

- Press **INPUT** button on the projector. Each time you press the button, the projector switches its input port from the current port as below.

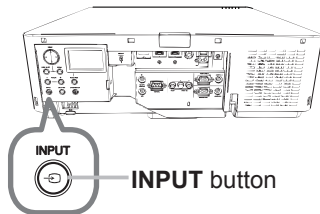

**NOTE** • If you have set SKIP to some ports from SOURCE SKIP in the OPTION menu, the input from the ports cannot be selected (87).  
 • While ON is selected for AUTO SEARCH item in OPTION menu, the projector will keep checking the ports in above order repeatedly till an input signal is detected (87).

- Press **COMPUTER 1, VIDEO, LAN, HDMI 1 / 2, DisplayPort, HDBaseT or SDI** button on the remote control. The port corresponding to each button is selected as below.

Button	Ports
<b>COMPUTER 1</b>	<b>COMPUTER IN</b>
<b>COMPUTER 2</b>	-
<b>VIDEO</b>	<b>VIDEO</b>
<b>LAN</b>	<b>LAN</b>
<b>USB TYPE A</b>	-
<b>USB TYPE B</b>	-
<b>HDMI 1</b>	<b>HDMI 1</b>
<b>HDMI 2</b>	<b>HDMI 2</b>
<b>DisplayPort</b>	<b>DisplayPort</b>
<b>HDBaseT</b>	<b>HDBaseT</b>
<b>SDI</b>	<b>SDI*</b>
<b>DIGITAL</b>	-

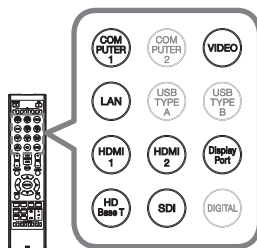

Buttons for input ports

**NOTE** • While ON is selected for AUTO SEARCH item in OPTION menu, the projector will keep checking every port sequentially till an input signal is detected (87).

\* CP-WU8700 only

## Selecting an aspect ratio

1. Press **ASPECT** button on the remote control.
  - Each time you press the button, the projector switches the mode for aspect ratio in turn.



**ASPECT**  
button

### ○ For a computer signal

#### CP-X8800:

NORMAL → 4:3 → 16:9 → 16:10



#### CP-WU8600, CP-WX8650, CP-WU8700, CP-WX8750:

NORMAL → 4:3 → 16:9 → 16:10 → NATIVE



### ○ For HDMI™, HDBaseT™, and DisplayPort signals

#### CP-X8800:

NORMAL → 4:3 → 16:9 → 16:10 → 14:9



#### CP-WU8600, CP-WX8650, CP-WU8700, CP-WX8750:

NORMAL → 4:3 → 16:9 → 16:10 → 14:9 → NATIVE



### ○ For a video signal

#### CP-X8800:

4:3 → 16:9 → 14:9



#### CP-WU8600, CP-WX8650, CP-WU8700, CP-WX8750:

4:3 → 16:9 → 16:10 → 14:9 → NATIVE



### ○ For an SDI signal (CP-WU8700 only)

NORMAL → 4:3 → 16:9



### ○ For an input signal from the LAN port, or if there is no signal

CP-X8800: 4:3 (fixed)

CP-WU8600, CP-WX8650, CP-WU8700, CP-WX8750: 16:10 (fixed)

**NOTE** • **ASPECT** button does not work when no proper signal is input.  
• **NORMAL** mode keeps the original aspect ratio setting.

## Adjusting the projector's elevator

Lengthening or shortening the length of the elevator feet shifts the projection position and the projection angle.

Turn the elevator feet each to adjust their length.

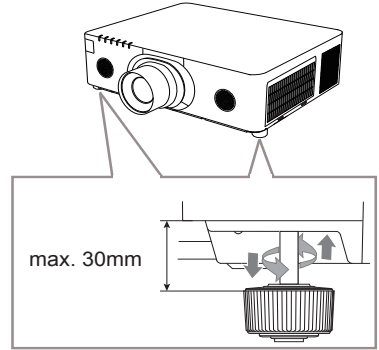
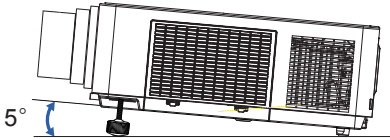

**⚠ WARNING** ▶ Do not lengthen the elevator feet exceeding 30 mm. The foot lengthened exceeding the limit may come off and drop the projector down, and result in an injury or damaging the projector.

**⚠ CAUTION** ▶ Do not place the projector with an inclination exceeding 5 degrees. The projector leaned exceeding the limit could cause malfunction and shorten the life of the projector.

## Installation angle

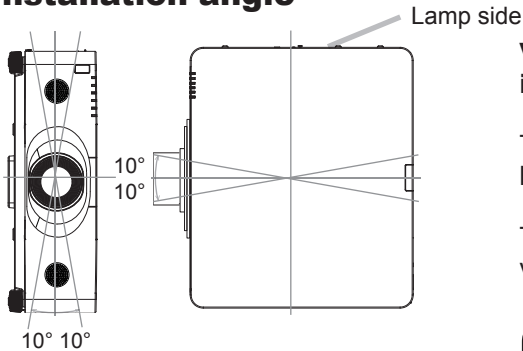

### Vertical and horizontal direction in portrait mode

The projector may be installed at horizontal angle of  $\pm 10^\circ$ .

The projector may be installed at vertical angle of  $\pm 10^\circ$ .

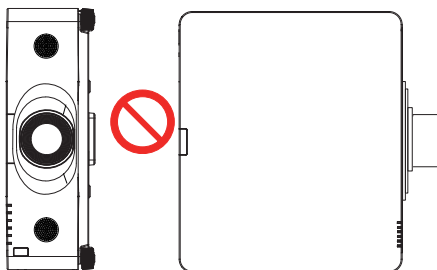

**NOTE** • The lamp side of the projector must face upward for vertical installations.

- If Other Error has occurred, please check the installation. Install the projector correctly and restart it.
- When using portrait mode, the service life of a lamp becomes shorter.



## Adjusting the lens

### Adjusting the zoom and focus

The ZOOM or FOCUS dialog will appear when you press any of the buttons from ZOOM, ZOOM -, ZOOM +, FOCUS + and FOCUS -.

1. Use the ZOOM + / - buttons on the remote control or ZOOM button and ◀/▶ cursor buttons on the projector to adjust the screen size.
2. Use the FOCUS + / - buttons to focus the picture.

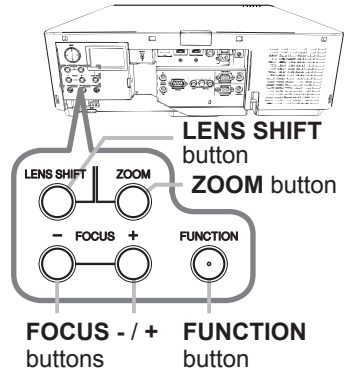
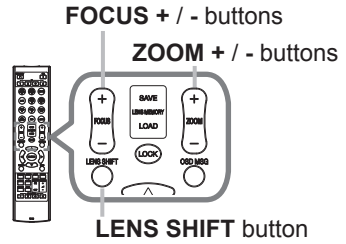

**NOTE** • The projector may ignore operation by other buttons while the lens is moving.

### Adjusting the lens position

Press the LENS SHIFT button. The LENS SHIFT dialog will appear. Using the ▲/▼/◀/▶ buttons while the dialog is displayed shifts the lens. Generally, better image quality can be got when the lens is set to the center.

Press the LENS SHIFT button again to exit the LENS SHIFT function.

### CENTERING

Press the ENTER or INPUT button while the dialog is displayed to execute the CENTERING feature, which adjusts the lens to the center. A message dialog is displayed for confirmation. Pressing the ▶ button performs CENTERING. You can also perform CENTERING in the standby mode by pressing the FUNCTION and LENS SHIFT buttons on the control panel for 3 seconds at the same time.

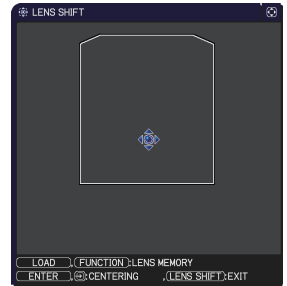

**CAUTION** ▶ Do not put your fingers or any other things around the lens. The moving lens could catch them in the space around the lens and result in an injury.

**NOTE** • While the lens is moving to the center, the menu will disappear and an hourglass icon will appear on the screen. CENTERING may take some time till the lens reaches the center.

- The projector may ignore operation by buttons while moving the lens.
- The CENTERING feature while the projector is in the standby mode is disabled if the STANDBY MODE item of SETUP menu is set to SAVING. Perform CENTERING before the projector's power is turned off, or set the STANDBY MODE to NORMAL.
- The adjustable range of LENS SHIFT varies depending on the lens unit mounted on the projector to maintain picture quality. Therefore LENS SHIFT adjustment may not reach the end of the indicator in the dialog, and that is not a failure.

## Adjusting the lens (continued)

### Lens memory

This projector is equipped with memory functions for the lens adjustments (LENS SHIFT and LENS TYPE). Up to 3 sets of adjustments can be stored.

To utilize the lens memory feature, press the **LOAD**

or **FUNCTION** button while the LENS SHIFT dialog is displayed. Then the LENS MEMORY dialog will appear. The current lens adjustments are displayed on the "CURRENT" line.

The adjustments already stored in the lens memory are displayed on the lines of SAVE and LOAD-1 to 3.

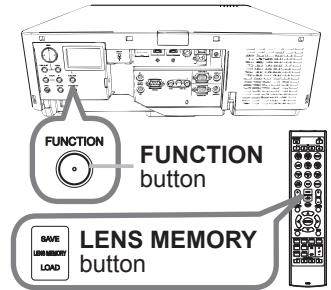

#### ○ **SAVE:**

To store the current lens adjustments, select one of the "SAVE" options numbered 1 to 3 (number of the lens memory) and press the **▶** or **ENTER** button.

Remember that the current data being stored of a memory will be lost by saving new data into the memory.

#### ○ **LOAD:**

To recall stored adjustments, select one of the "LOAD" options numbered 1 to 3 (number of the lens memory) and press the **▶** or **ENTER** button.

Remember that the current adjusted condition will be lost by loading data. If you want to keep the current adjustment, please save it before performing a LOAD function.

#### ○ **CLEAR LENS MEMORY:**

To clear the adjustment stored in a lens memory, select CLEAR LENS MEMORY and press the **▶** or **ENTER** button. The CLEAR LENS MEMORY dialog will be displayed. Select the number of the lens memory to be cleared using the **▲/▼** buttons and press the **▶** button. A message dialog is displayed for confirmation. Press the **▶** button again to clear the lens memory.

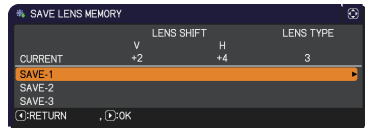

**NOTE** • The projector may ignore operation by buttons while moving the lens.  
• You can perform the LOAD function using **LENS MEMORY** button.

## Using the automatic adjustment feature

1. Press **AUTO** button on the remote control.
- Pressing this button performs the following.

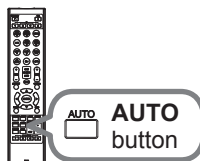

- **For a computer signal**

The vertical position, the horizontal position and the horizontal phase will be automatically adjusted.

Make sure that the application window is set to its maximum size prior to attempting to use this feature. A dark picture may still be incorrectly adjusted. Use a bright picture when adjusting.

- **For a video signal**

The video format best suited for the respective input signal will be selected automatically. This function is available only when the AUTO is selected for the VIDEO FORMAT item in the INPUT menu (📖70). The vertical position and horizontal position will be automatically set to the default.

- **For a component video signal**

The vertical position and horizontal position will be automatically set to the default. The horizontal phase will be automatically adjusted.

- NOTE** • The automatic adjustment operation requires approx. 10 seconds. Also please note that it may not function correctly with some input.
- When this function is performed for a video signal, a certain extra such as a line may appear outside a picture.
  - When this function is performed for a computer signal, a black frame may be displayed on the edge of the screen, depending on the computer model.
  - The items adjusted by this function may vary when the FINE or DISABLE is selected for the AUTO ADJUST item of the SERVICE item in the OPTION menu (📖93).

## Correcting the distortion

To correct the distortion of projected screen, you can select one of three options, KEYSTONE, PERFECT FIT, and WARPING. First press the **GEOMETRY** button to display the GEOMETRY CORRECTION menu, and point at one of the items with the ▲/▼ buttons.

**KEYSTONE**: allows you to adjust the vertical and horizontal keystone.

**PERFECT FIT**: allows you to adjust each of the screen corners and sides to correct the distortion.

**WARPING**: allows you to project an image on several types of screen.

Use Keystone/PERFECT FIT/Warping for adjustment. When one of them is selected, other items are not available.

Then follow the procedure shown below for the item you selected.

**NOTE** • The menu or dialog will automatically disappear after several seconds of inactivity. Press the **GEOMETRY** button again, or point the cursor at EXIT in the dialog and press the ► or **ENTER** button to end the operation and close the menu or dialog.

### ○ KEYSTONE:

When KEYSTONE is pointed at, pressing the ► or **ENTER** button displays the KEYSTONE dialog.

1. Select the vertical or horizontal keystone (▲/▼) with the ▲/▼ buttons.
2. Use the ◀/▶ buttons to adjust the keystone distortion.



**NOTE** • When the zoom adjustment is set to the TELE (telephoto focus), this function may be excessive. This function should be used when the zoom adjustment is set to the full WIDE (wide-angle focus) whenever possible.

- When the horizontal lens shift is not set to the center, this function may not work well.
- Point at RETURN in the dialog with the ▲/▼ buttons and press ◀ or **ENTER** button to return to the GEOMETRY CORRECTION menu.



## Correcting the distortion (continued)

### ○ PERFECT FIT:

When PERFECT FIT is pointed at, pressing the ► or **ENTER** button displays the PERFECT FIT dialog.

This projector is equipped with a test pattern for PERFECT FIT. Select PATTERN with the ▲/▼ buttons, then press the ◀/▶ buttons to switch on and off.



1. Select SETUP with the ▲/▼ buttons and press the ► or **ENTER** button.
2. Select one of the corners or sides to be adjusted with the ▲/▼/◀/▶ buttons and press the **ENTER** or **INPUT** button.
3. Adjust the selected part as below.
  - For adjusting a corner, use the ▲/▼/◀/▶ buttons to adjust the position of the corner.
  - For adjusting the upper or lower side, use the ▲/▼ buttons to adjust the distortion of the side.
  - For adjusting the left or right side, use the ◀/▶ buttons to adjust the distortion of the side.
  - To adjust another corner or side, press the **ENTER** or **INPUT** button and follow the procedure from step 2.

(continued on next page)

### Correcting the distortion (continued)

4. This projector is equipped with a memory feature for PERFECT FIT adjustment. Up to 3 sets of adjustments can be stored.

● **SAVE:**

To store the current PERFECT FIT adjustment, select one of the "SAVE" options numbered 1 to 3 (number of the memory) with the ▲/▼ buttons and press the ►, **ENTER** or **INPUT** button.

Remember that the current data being stored of a memory will be lost by saving new data into the memory.

● **LOAD:**

To recall stored adjustments, select one of the "LOAD" options numbered 1 to 3 (number of the memory) with the ▲/▼ buttons and press the ►, **ENTER** or **INPUT** button.

Remember that the current adjusted condition will be lost by loading data. if you want to keep the current adjustment, please save it before performing a LOAD function.

**NOTE** • The LOAD functions whose linked memory has no data are skipped.  
• There may be some noise and the screen may flicker for a moment when loading data. This is not malfunction.

○ **WARPING:**

Projection on several types of screen can be performed by WARPING function. This function is operated by using dedicated PC tool, "Warping Tool".

PC and projector are required to be connected with LAN cable in order to use this function.

You can get the PC tool from the URL below.

<http://www.hitachi.co.jp/proj/>

Refer to Application Manual for operations.

## Using the EDGE BLENDING features

### 1. Mode (MANUAL/CAMERA)

OFF: Disables the Blending function.

MANUAL: Allows you to adjust Blending Region or Blending Level by using menu.

CAMERA: Allows you to perform automatic adjustment by using CAMERA in Projector Blending Tool.

- IMAGE OPTIMIZER is not selectable when Blending is set to other than OFF.
- ECO MODE is not selectable when Blending is set to other than OFF.
- Keystone/Perfect Fit/Warping are not selectable when CAMERA is selected in Blending.

### 2. Blending Region

#### 2.1 Specifying Blending Region

Select one of the four sides with ▲/▼/◀/▶ buttons and press **ENTER** or **INPUT** button. Blending Region can be specified for left and right sides with ◀/▶ buttons and for top and bottom sides with ▲/▼ buttons.

Specify Blending Region for each projector.

Adjust them referring to the guide displayed during the adjustment of Blending Region.

\* The minimum value of Blending Region is 200 dots.

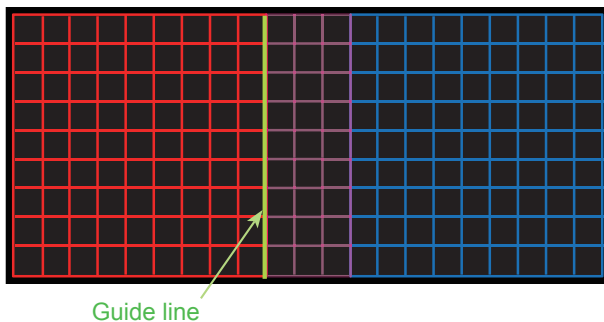

(continued on next page)

### 3. Cropping

When inputting the same image to each projector, Cropping function enables two projectors to cut out a part of input image and display one image on a large screen. The following patterns are supported.

2 x 1



1 x 2



2 x 2



#### 3.1 Displaying Cropping Menu

Select CROPPING with ▲/▼ buttons and press ►, **ENTER** or **INPUT** button to display Cropping Menu.

#### 3.2 Setting Cropping

Select MODE with ▲/▼ buttons and select ON with ◀/▶ buttons.

Input image is automatically cut out according to the settings of Blending Region.

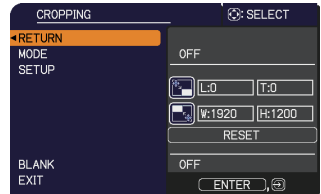

(continued on next page)



### 3.3 Adjusting Cropping Area

Adjust Cropping Area when cutting out a part of input image.

Select SETUP with ▲/▼ buttons and press ►, **ENTER** or **INPUT** button.

\* MODE is set to [OFF] temporarily and the guide of Cropping Area is displayed.

Select [LT]/[WH] with ▲/▼ buttons and press **ENTER** or **INPUT** button.

Move the guide display with ▲/▼/◀/▶ buttons to select the region of the screen to be cut out.

Press **ENTER** or **INPUT** button and then press ◀ button to select SETUP, and MODE switches to ON automatically.

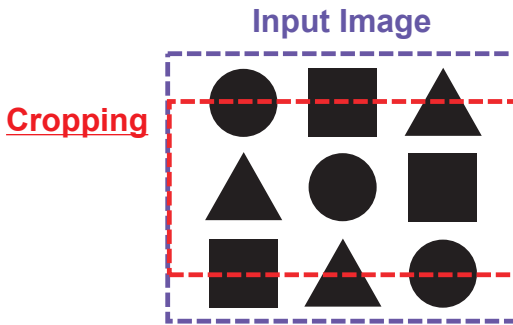

### 3.4 Adjust Cropping Area of the other projector.

Set Cropping Area of the other projector with the same value as one projector. Input image is automatically cut out according to the settings of Blending Region.

\* When you want to keep input image from not being seen while setting up, set BLANK to ON.

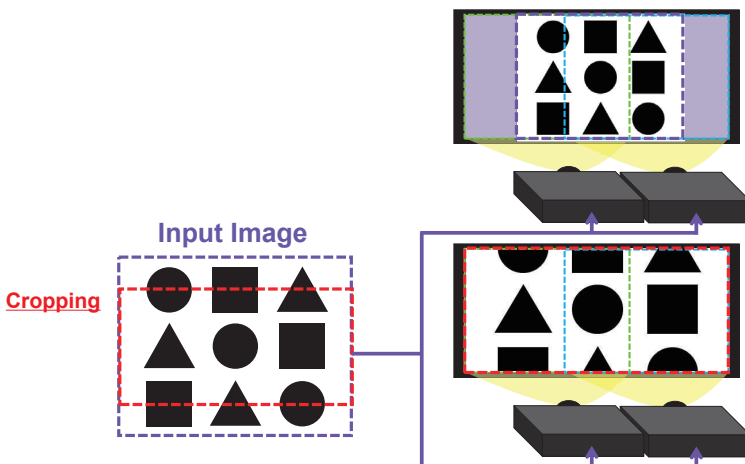

(continued on next page)

4. Selecting Blending Level

Select BLENDING LEVEL with ▲/▼ buttons.

[1-25] can be selected with ◀/▶ buttons.

Adjust the brightness of Blending Region according to the settings.

5. DIMMING LEVEL

Adjusts the brightness of the projectors which are using Blending.

Using the ◀/▶ buttons to adjust the dimming level.

6. WHITE BALANCE

Adjusts the white balance of the whole screen.

6.1. OFFSET

OFFSET adjustments change the color intensity on the whole tones.

6.2. GAIN

GAIN adjustments mainly affect color intensity on the brighter tones.

7. BLACK LEVEL

Adjusts black color level of the projectors which are using Blending.

Adjusts the adjustment value of R/G/B at the same time when W is selected.

When each of R/G/B is selected, the adjustment value of R/G/B can be adjusted respectively.

**NOTE** • The positional deviation of the screen may occur after installing the projector over time. In that case, perform the screen adjustment again to correct the positional deviation.

## Using the magnify feature

- Press the **MAGNIFY ON** button on the remote control.

The picture will be magnified, and the MAGNIFY dialog will appear on the screen. When the **MAGNIFY ON** button is pressed for the first time after the projector is turned on, the picture will be zoomed by 1.5 times. On the dialog, triangle marks to show each direction will be displayed.
- The display magnification of the projector switches in order with every press of the **MAGNIFY ON** button.

  - For computer signals, HDMI™ (RGB) signals, HDBaseT™ signals, DisplayPort signals, input signals from the LAN port  
1.5 times → 2 times → 3 times → 4 times → 1 time
  - For video signals, DisplayPort signals, HDBaseT signals, SDI signals, or HDMI™ signals  
1.5 times → 2 times → 1 time
- While the triangles are displayed on the dialog, use the ▲/▼/◀/▶ cursor buttons to shift the magnifying area.
- Press the **MAGNIFY OFF** button on the remote control to exit magnification.

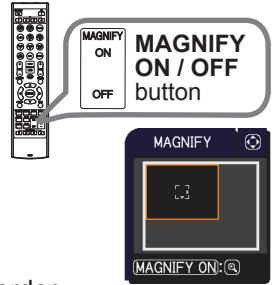

**NOTE** • The MAGNIFY dialog will automatically disappear in several seconds with no operation. The dialog will appear again if the **MAGNIFY ON** button is pressed when the dialog has automatically disappeared.

- The magnification is automatically disabled when the displaying signal or its display condition is changed.
- While the magnification is active, the keystone distortion condition may vary. It will be restored when the magnification is disabled.
- Some horizontal stripes might be visible on the image while magnification is active.
- This function is not available in the following cases:
  - A sync signal in the range not supported is input.
  - There is no input signal.

## Temporarily freezing the screen

1. Press the **FREEZE** button on the remote control.  
The “FREEZE” indication will appear on the screen (however, the indication will not appear when SILENT is selected for the OSD MESSAGE item in the SETUP (📖79), and the projector will go into the FREEZE mode, which the picture is frozen.

To exit the FREEZE mode and restore the screen to normal, press the **FREEZE** button again.



**NOTE** • The projector automatically exits from the FREEZE mode when some control buttons are pressed.

- If the projector continues projecting a still image for a long time, the LCD panel might possibly be burned in. Do not leave the projector in the FREEZE mode for too long.
- Images might appear degraded when this function is operated, but it is not a malfunction.

## Temporarily shading the screen

1. Press the **SHADE** button on the control panel.  
The mechanical lens shade closes and the screen turns to black. The **SHADE** indicator on the projector blinks in yellow while the shade is closed.

To open the shade and restore the screen, press the **SHADE** button again.

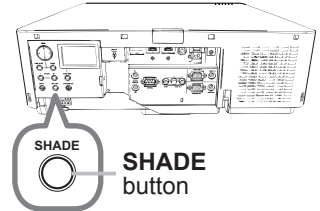

**⚠ CAUTION** ► If you wish to have a blank screen while the projector's lamp is on, use the lens shade function above or the AV MUTE function (📖37). Taking any other action may cause the damage on the projector.

**NOTE** • The projector will turn off automatically when the time set up by the SHADE TIMER passes (📖88).

- When turning off the power by the normal procedure, the lens shade opens automatically. If AC power supply is disconnected while opening or closing the lens shade, the moving of the lens shade stops. However, the next time the projector is turned on, the lens shade opens again automatically.

## PbyP (Picture by Picture) / PinP (Picture in Picture)

The PbyP / PinP is a function for displaying two different picture signals on a screen that is separated into main and sub areas for each signal.

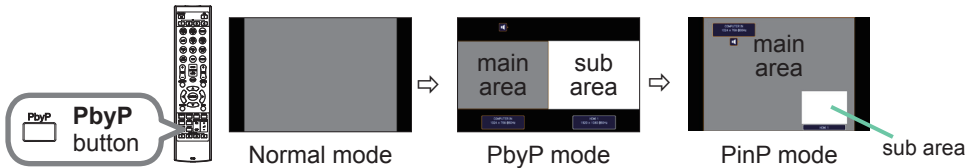

Press the **PbyP** button on the remote control. This activates the PbyP mode. Then, press the **PbyP** button again. The projector goes into PinP mode. The screen displayed before the **PbyP** button was pressed will be displayed as the main area. Most of operations are effective for the main area only. Only outputs the audio input signal paired with the picture input signal for the main area. To quit the PinP mode, press the **PbyP** button again.

- NOTE**
- If the **LAN** port is selected when the **PbyP** button is pressed, input from other port is displayed on the main area.
  - When in the PbyP / PinP mode, use the **MENU** button on the remote control or ▲/▼ buttons on the control panel to display the OSD menu.
  - There are certain functions that cannot be used when in the PbyP / PinP mode.
  - A message will be displayed when buttons that cannot be used are pressed (📖116). However, note that there are certain unusable buttons for which messages are not displayed.
  - The functions on the OSD menu that cannot be used are displayed in gray and cannot be selected.

(continued on next page)

**PbyP (Picture by Picture) / PinP (Picture in Picture) (continued)**

○ **Setting information**

The setting information will be appeared for several seconds when the PbyP / PinP function is started. Displays the input information for each area. A yellow frame around the main area and an audio mark indicating the audio output will also be displayed. The information can be redisplayed with the ◀/▶ buttons after it has been erased.

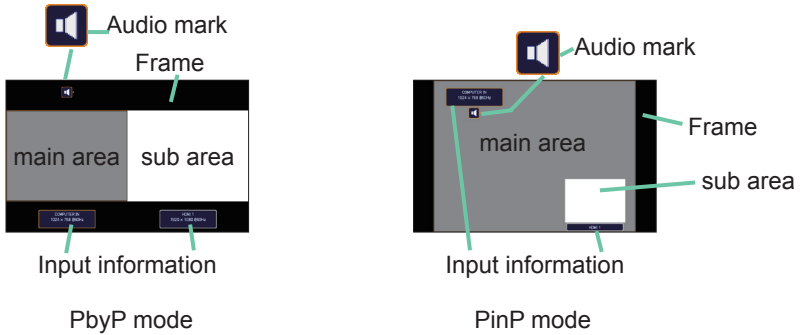

○ **Changing the main area**

The position of the main area can be toggled with the ◀/▶ buttons when the setting information is displayed on the screen. The yellow frame and the audio mark will move together with it.

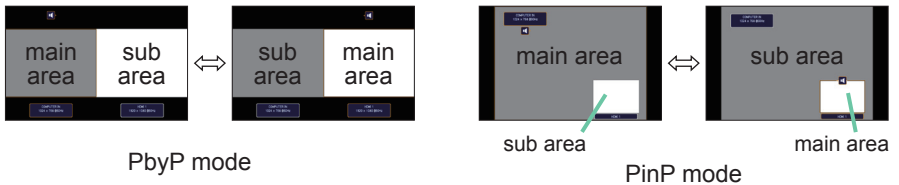

(continued on next page)

**PbyP (Picture by Picture) / PinP(Picture in Picture) (continued)**

**○ Changing the picture input signal**

Press any button to select an input port on the remote control or press the **INPUT** button on the control panel. A dialog box to select the input signal for the main area will be displayed. Choose a signal using the **▲/▼** buttons. To change the signal in the sub area, switch temporarily across to the main area with the **◀/▶** buttons.

Displaying the same signal on the both areas is not allowed. Refer to the table for details on available input signal combinations. Any combinations marked with "X" can not be selected.

Sub area \ Main area	COMPUTER IN	LAN	HDMI 1	HDMI 2	DisplayPort	HDBaseT	SDI (CP-WU8700 only)	VIDEO
COMPUTER IN	X	X	O	O	O	O	O	X
LAN	X	X	X	X	X	X	X	X
HDMI 1	O	X	X	O	X	X	X	O
HDMI 2	O	X	O	X	O	O	O	O
DisplayPort	O	X	X	O	X	X	X	O
HDBaseT	O	X	X	O	X	X	X	O
SDI (CP-WU8700 only)	O	X	X	O	X	X	X	O
VIDEO	X	X	O	O	O	O	O	X

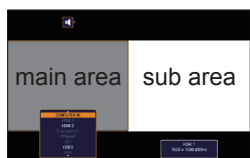

Input signal

PbyP mode



Input signal sub area

PinP mode

**NOTE** • The combined input signals marked with an "O" can be selected and displayed in the PbyP / PinP mode even when the port is set to SKIP with the SOURCE SKIP on the OPTION menu (87).

(continued on next page)

**PbyP (Picture by Picture) / PinP (Picture in Picture) (continued)**

○ **PbyP /PinP SWAP function**

Press the **MY BUTTON** assigned the PbyP / PinP SWAP (📖89). The position of the both area is exchanged without any setting change.

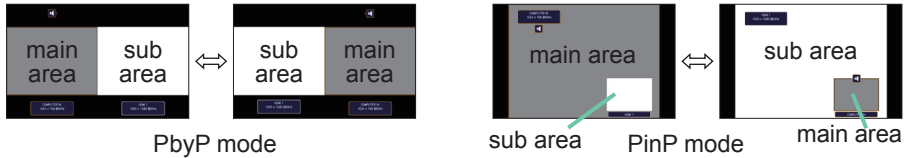

**NOTE** • For some signals, it may not be displayed correctly in the PbyP / PinP mode, even if it can be displayed properly in the normal mode.  
 • PbyP/PinP is unavailable when MANUAL is selected in GEOMETRY CORRECTION > EDGE BLENDING > MODE.

○ **Changing the size of main area in PbyP mode**

Using ▲/▼ buttons on the remote control changes the size of main area in PbyP mode.

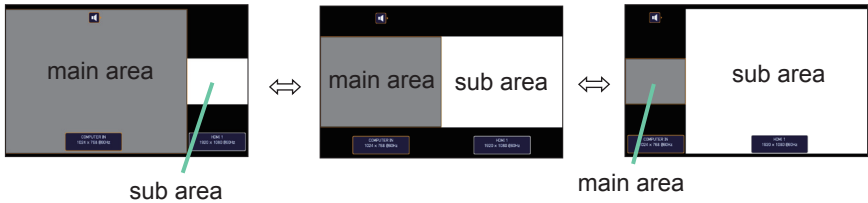

○ **Changing the position of sub area in PinP mode**

1. Select PinP POSITION in INPUT MENU (📖73).
2. Using ▲/▼ buttons on the remote control changes the position of sub area in PinP mode.

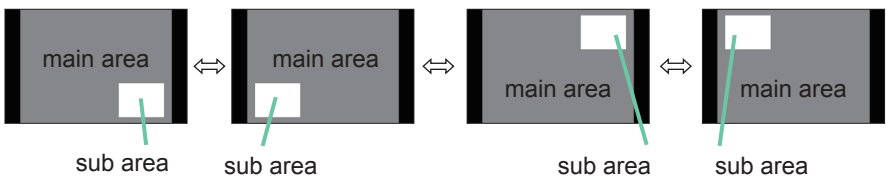



## Using the menu function

This projector has the following menus:

PICTURE, IMAGE, INPUT, SETUP, AUDIO, SCREEN, OPTION, NETWORK, SECURITY and EASY MENU. EASY MENU consists of functions often used, and the other menus are classified into each purpose and brought together as the ADVANCED MENU.

Each of these menus is operated using the same methods. While the projector is displaying any menu, the **MENU** button on the projector works as the cursor buttons. The basic operations of these menus are as follows.

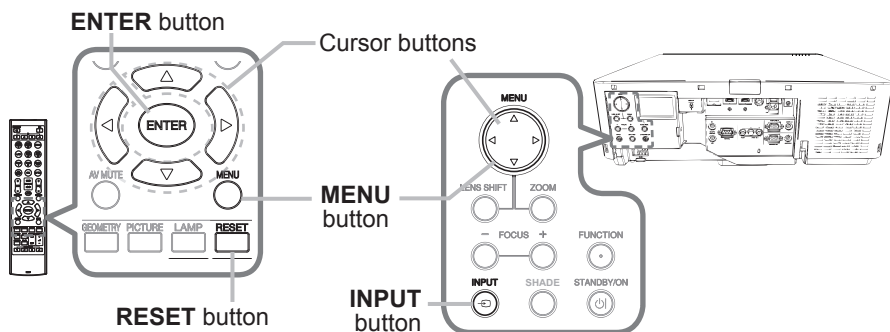

1. To start the MENU, press the **MENU** button. The MENU you last used (EASY or ADVANCED) will appear. EASY MENU has priority to appear just after powered on.

### 2. In the EASY MENU

- (1) Use the ▲/▼ cursor buttons to select an item to operate. If you want to change it to the ADVANCED MENU, select the ADVANCED MENU.
- (2) Use the ◀/▶ cursor buttons to operate the item.



### In the ADVANCED MENU

- (1) Use the ▲/▼ cursor buttons to select a menu. If you want to change it to the EASY MENU, select the EASY MENU. The items in the menu appear on the right side.
- (2) Press the ▶ cursor button or **ENTER** button to move the cursor to the right side. Then use the ▲/▼ cursor buttons to select an item to operate and press the ▶ cursor button or **ENTER** button to progress. The operation menu or dialog of the selected item will appear.
- (3) Use the buttons as instructed in the OSD to operate the item.



(continued on next page)

### Using the menu function (continued)

3. To close the MENU, press the **MENU** button again or select EXIT and press the ◀ cursor button or **ENTER** button. Even if you do not do anything, the dialog will automatically disappear after about 30 seconds.

**NOTE** • Some functions cannot be performed when a certain input port is selected, or when a certain input signal is displayed.

- When you want to reset the operation, press **RESET** button on the remote control during the operation. Note that some items (ex. LANGUAGE, VOLUME) cannot be reset.
- In the **ADVANCED MENU**, when you want to return to the previous display, press the ◀ cursor button on the remote control.

### Indication in OSD (On Screen Display)

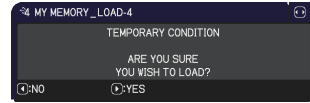
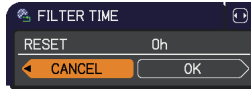

The meanings of the general words on the OSD are as follows.

Indication	Meaning
EXIT	Selecting this word finishes the OSD menu. It's the same as pressing the <b>MENU</b> button.
RETURN	Selecting this word returns the menu to the previous menu.
CANCEL or NO	Selecting this word cancels the operation in the present menu and returns to the previous menu.
OK or YES	Selecting this word executes the prepared function or shifts the menu to the next menu.

## Using the menu function (continued)

### Containing items of each menu

The items contained in the menus are as below;

Menu	Items
<b>EASY MENU</b> (📖60)	ASPECT, KEYSTONE, PERFECT FIT, PICTURE MODE, ECO MODE, INSTALLATION, RESET, FILTER TIME, LANGUAGE, ADVANCED MENU, EXIT
<b>PICTURE</b> (📖62)	BRIGHTNESS, CONTRAST, COLOR, TINT, SHARPNESS, ACTIVE IRIS, PICTURE QUALITY, MY MEMORY
<b>IMAGE</b> (📖66)	ASPECT, OVER SCAN, V POSITION, H POSITION, H PHASE, H SIZE, AUTO ADJUST EXECUTE
<b>INPUT</b> (📖69)	PROGRESSIVE, VIDEO NR, COLOR SPACE, VIDEO FORMAT, DIGITAL FORMAT, DIGITAL RANGE, COMPUTER IN, FRAME LOCK, RESOLUTION, PbyP/PinP SETUP
<b>SETUP</b> (📖74)	GEOMETRY CORRECTION, LAMP & FILTER, IMAGE OPTIMIZER, PICTURE POSITION, INSTALLATION, STANDBY MODE, COLOR UNIFORMITY, OSD MESSAGE
<b>AUDIO</b> (📖80)	VOLUME, SPEAKER, AUDIO SOURCE
<b>SCREEN</b> (📖81)	LANGUAGE, MENU POSITION, BLANK, AUTO BLANK, START UP, MyScreen, MyScreen Lock, SOURCE NAME, TEMPLATE, C.C.
<b>OPTION</b> (📖87)	SOURCE SKIP, AUTO SEARCH, DIRECT POWER ON, AUTO POWER OFF, SHADE TIMER, MY BUTTON, SCHEDULE, SERVICE
<b>NETWORK</b> (📖100)	PROJECTOR NAME, WIRELESS SETUP, WIRED SETUP, NETWORK INFORMATION, SNTP SETUP, MY IMAGE, EXTERNAL CONTROL, PRESENTATION, WIRED NETWORK
<b>SECURITY</b> (📖101)	ENTER PASSWORD, SECURITY PASSWORD CHANGE, MyScreen PASSWORD, PIN LOCK, TRANSITION DETECTOR, MY TEXT PASSWORD, MY TEXT DISPLAY, MY TEXT WRITING, SECURITY INDICATOR, STACK LOCK

EASY MENU



From the EASY MENU, items shown in the table below can be performed.

Select an item using the ▲/▼ cursor buttons. Then perform it according to the following table.

Item	Description
<b>ASPECT</b>	Using the ◀/▶ buttons switches the mode for aspect ratio. See the ASPECT item in IMAGE menu (📖66).
<b>KEYSTONE</b>	Pressing the ▶ button displays the KEYSTONE dialog. See the KEYSTONE item in SETUP menu (📖74).
<b>PERFECT FIT</b>	Pressing the ▶ button displays the PERFECT FIT dialog. See the PERFECT FIT item in SETUP menu (📖74).
<b>PICTURE MODE</b>	<p>Using the ◀/▶ buttons switches the picture mode. The picture modes are combinations of GAMMA and COLOR TEMP settings. Choose a suitable mode according to the projected source.</p> <p style="text-align: center;">STANDARD ⇄ NATURAL ⇄ CINEMA ⇄ DYNAMIC            ⇅            USER-3 <span style="float: right;">BOARD(BLACK)</span>            ⇅            USER-2 <span style="float: right;">BOARD(GREEN)</span>            ⇅            USER-1 ⇄ DICOM SIM. ⇄ DAYTIME ⇄ WHITEBOARD</p> <ul style="list-style-type: none"> <li>• Lines or other noise might appear on the screen when this function is operated, but it is not a malfunction.</li> <li>• DICOM SIM. is the projector's DICOM® ("Digital Imaging and Communication in Medicine") simulation mode. This mode simulates the DICOM standard, which is a standard applicable to digital communications in medicine, and can be useful for displaying medical images, such as X-rays photos. This projector is not a medical device and is not compliant to the DICOM standard, and neither the projector nor the DICOM SIM. mode should be used for medical diagnosis.</li> </ul>

(continued on next page)

Item	Description
<b>ECO MODE</b>	Using the ◀/▶ buttons turns off/on the Eco mode. See the ECO MODE item in SETUP menu (📖75).
<b>INSTALLATION</b>	Pressing the ▶ button displays the INSTALLATION dialog. See the INSTALLATION item in SETUP menu (📖77).
<b>RESET</b>	Performing this item resets all of the EASY MENU items except the FILTER TIME and LANGUAGE. A dialog is displayed for confirmation. Selecting the OK using the ▶ button performs resetting.
<b>FILTER TIME</b>	The usage time of the air filter is shown in the menu. Performing this item resets the filter time which counts usage time of the air filter. A dialog is displayed for confirmation. Selecting the OK using the ▶ button performs resetting. See the FILTER TIME item in SETUP menu (📖76).
<b>LANGUAGE</b>	Using the ◀/▶ buttons changes the display language. See the LANGUAGE item in SCREEN menu (📖81).
<b>ADVANCED MENU</b>	Press the ▶ or <b>ENTER</b> button to use the menu of PICTURE, IMAGE, INPUT, SETUP, AUDIO, SCREEN, OPTION, NETWORK or SECURITY.
<b>EXIT</b>	Press the ◀ or <b>ENTER</b> button to finish the OSD menu.

## PICTURE menu

From the PICTURE menu, items shown in the table below can be performed.

Select an item using the ▲/▼ cursor buttons, and press the ► cursor button or **ENTER** button to execute the item. Then perform it according to the following table.

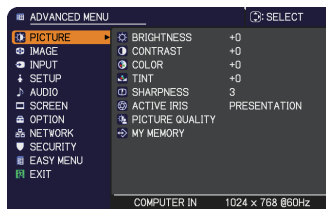

Item	Description
<b>BRIGHTNESS</b>	Using the ◀/▶ buttons adjusts the brightness. Dark ⇄ Light
<b>CONTRAST</b>	Using the ◀/▶ buttons adjusts the contrast. Weak ⇄ Strong
<b>COLOR</b>	Using the ◀/▶ buttons adjusts the strength of whole color. Weak ⇄ Strong
<b>TINT</b>	Using the ◀/▶ buttons adjusts the tint. Reddish ⇄ Greenish
<b>SHARPNESS</b>	Using the ◀/▶ buttons adjusts the sharpness. Weak ⇄ Strong <ul style="list-style-type: none"> <li>• There may be some noise and/or the screen may flicker for a moment when an adjustment is made. This is not a malfunction.</li> </ul>
<b>ACTIVE IRIS</b>	Using the ▲/▼ cursor buttons changes the active iris control mode. PRESENTATION ⇄ THEATER ⇄ OFF ↑—————↑ <u>PRESENTATION</u> : The active iris displays the best presentation image for both bright and dark scenes. <u>THEATER</u> : The active iris displays the best theater image for both bright and dark scenes. <u>OFF</u> : The active iris is always open. <ul style="list-style-type: none"> <li>• The screen may flicker when the PRESENTATION or THEATER modes are selected. If this occurs select OFF.</li> </ul>

(continued on next page)

Item	Description
<p><b>PICTURE QUALITY</b></p>	<p>Selecting this item displays the PICTURE QUALITY menu.</p> <p>Select an item using the ▲/▼ buttons, and press the ► button or the ENTER button on the remote control to execute the item.</p> 
	<p><b>PICTURE MODE</b></p> <p>STANDARD ⇔ NATURAL ⇔ CINEMA ⇔ DYNAMIC</p> <p>⇕</p> <p>USER-3 BOARD(BLACK)</p> <p>⇕</p> <p>USER-2 BOARD(GREEN)</p> <p>⇕</p> <p>USER-1 ⇔ DICOM SIM. ⇔ DAYTIME ⇔ WHITEBOARD</p> <p>After selecting USER-1 / USER-2 / USER-3, the following features are adjustable.</p> <p>Gamma, Color Temp</p>
	<p><b>GAMMA</b></p> <p>This feature is only available when USER-1 / USER-2 / USER-3 is selected.</p> <p>Using the ▲/▼ buttons switches the gamma mode.</p> <p>DEFAULT-1 ⇔ CUSTOM-1 ⇔ DEFAULT-2 ⇔ CUSTOM-2</p> <p>⇕</p> <p>CUSTOM-8 DEFAULT-3</p> <p>⇕</p> <p>DEFAULT-8 CUSTOM-3</p> <p>⇕</p> <p>CUSTOM-7 DEFAULT-4</p> <p>⇕</p> <p>DEFAULT-7 CUSTOM-4</p> <p>⇕</p> <p>CUSTOM-6 ⇔ DEFAULT-6 ⇔ CUSTOM-5 ⇔ DEFAULT-5</p>

(continued on next page)

Item	Description																																																														
<p><b>PICTURE QUALITY (continued)</b></p>	<p><b>GAMMA (continued)</b></p> <p>Selecting a mode whose name includes CUSTOM and then pressing the ► button or the <b>ENTER</b> button displays a dialog to aid you in adjusting the mode. This function is useful when you want to change the brightness of particular tones. Choose an item using the ◀/▶ buttons, and adjust the level using the ▲/▼ buttons.</p> <ul style="list-style-type: none"> <li>• Lines or other noise might appear on the screen when this function is operated, but it is not a malfunction.</li> </ul>																																																														
	<p><b>COLOR TEMP</b></p> <p>This feature is only available when USER-1 / USER-2 / USER-3 is selected.</p> <p>Using the ▲/▼ buttons switches the color temperature mode.</p> <table style="width: 100%; border: none;"> <tr> <td style="text-align: center;">HIGH</td> <td style="text-align: center;">⇔</td> <td style="text-align: center;">CUSTOM-1</td> <td style="text-align: center;">⇔</td> <td style="text-align: center;">MID-1</td> <td style="text-align: center;">⇔</td> <td style="text-align: center;">CUSTOM-2</td> </tr> <tr> <td style="text-align: center;">⇕</td> <td></td> <td></td> <td></td> <td></td> <td></td> <td style="text-align: center;">⇕</td> </tr> <tr> <td style="text-align: center;">CUSTOM-7</td> <td></td> <td></td> <td></td> <td></td> <td></td> <td style="text-align: center;">MID-2</td> </tr> <tr> <td style="text-align: center;">⇕</td> <td></td> <td></td> <td></td> <td></td> <td></td> <td style="text-align: center;">⇕</td> </tr> <tr> <td style="text-align: center;">HIGHBRIGHT-3</td> <td></td> <td></td> <td></td> <td></td> <td></td> <td style="text-align: center;">CUSTOM-3</td> </tr> <tr> <td style="text-align: center;">⇕</td> <td></td> <td></td> <td></td> <td></td> <td></td> <td style="text-align: center;">⇕</td> </tr> <tr> <td style="text-align: center;">CUSTOM-6</td> <td></td> <td></td> <td></td> <td></td> <td></td> <td style="text-align: center;">LOW</td> </tr> <tr> <td style="text-align: center;">⇕</td> <td></td> <td></td> <td></td> <td></td> <td></td> <td style="text-align: center;">⇕</td> </tr> <tr> <td colspan="7" style="text-align: center;">HIGHBRIGHT-2 ⇔ CUSTOM-5 ⇔ HIGHBRIGHT-1 ⇔ CUSTOM-4</td> </tr> </table> <p>Selecting a mode whose name includes CUSTOM and then pressing the ► button or the <b>ENTER</b> button displays a dialog to aid you in adjusting the OFFSET and GAIN of the selected mode. OFFSET adjustments change the color intensity on the whole tones. GAIN adjustments mainly affect color intensity on the brighter tones. Choose an item using the ◀/▶ buttons, and adjust the level using the ▲/▼ buttons.</p> <ul style="list-style-type: none"> <li>• Lines or other noise might appear on the screen when this function is operated, but it is not a malfunction.</li> </ul>	HIGH	⇔	CUSTOM-1	⇔	MID-1	⇔	CUSTOM-2	⇕						⇕	CUSTOM-7						MID-2	⇕						⇕	HIGHBRIGHT-3						CUSTOM-3	⇕						⇕	CUSTOM-6						LOW	⇕						⇕	HIGHBRIGHT-2 ⇔ CUSTOM-5 ⇔ HIGHBRIGHT-1 ⇔ CUSTOM-4					
HIGH	⇔	CUSTOM-1	⇔	MID-1	⇔	CUSTOM-2																																																									
⇕						⇕																																																									
CUSTOM-7						MID-2																																																									
⇕						⇕																																																									
HIGHBRIGHT-3						CUSTOM-3																																																									
⇕						⇕																																																									
CUSTOM-6						LOW																																																									
⇕						⇕																																																									
HIGHBRIGHT-2 ⇔ CUSTOM-5 ⇔ HIGHBRIGHT-1 ⇔ CUSTOM-4																																																															

(continued on next page)



Item	Description
<p><b>PICTURE QUALITY</b> (continued)</p>	<p><b>ACCENTUALIZER</b> ACCENTUALIZER is a function to improve the legibility. Using the ◀/▶ buttons adjusts the sharpness. Weak ⇔ Strong</p> <ul style="list-style-type: none"> <li>• There may be some noise and/or the screen may flicker for a moment when an adjustment is made. This is not a malfunction.</li> <li>• This function may not work properly when IMAGE OPTIMIZER is enabled.</li> </ul>
	<p><b>HDRC</b> A function to show a clear picture in a bright room. Using the ◀/▶ buttons adjusts the contrast.</p> <ul style="list-style-type: none"> <li>• This function may not work properly when IMAGE OPTIMIZER is enabled.</li> </ul>
	<p><b>COLOR MANAGEMENT</b> A function to adjust color phase, color saturation, and brightness respectively for red, yellow, green, cyan, blue, and magenta.</p>
<p><b>MY MEMORY</b></p>	<p>This projector has 4 memories for adjustment data (for all the items of the PICTURE menu). Selecting a function using the ▲/▼ buttons and pressing the ▶ or <b>ENTER</b> button performs each function.</p> <p> </p> <p><u>SAVE-1, SAVE-2, SAVE-3, SAVE-4</u> Performing a SAVE function saves the current adjustment data into the memory linked in the number included in the function's name.</p> <ul style="list-style-type: none"> <li>• Remember that the current data being stored of a memory will be lost by saving new data into the memory.</li> </ul> <p><u>LOAD-1, LOAD-2, LOAD-3, LOAD-4</u> Performing a LOAD function loads the data from the memory linked in the number included in the function's name, and adjusts the picture automatically depending on the data.</p> <ul style="list-style-type: none"> <li>• The LOAD functions whose linked memory has no data are skipped.</li> <li>• Remember that the current adjusted condition will be lost by loading data. If you want to keep the current adjustment, please save it before performing a LOAD function.</li> <li>• There may be some noise and the screen may flicker for a moment when loading data. This is not malfunction.</li> <li>• You can perform the LOAD function using <b>MY BUTTON</b>. Please see MY BUTTON item in OPTION menu (p.89).</li> </ul>

IMAGE menu

From the IMAGE menu, items shown in the table below can be performed.

Select an item using the ▲/▼ cursor buttons, and press the ► cursor button or ENTER button to execute the item. Then perform it according to the following table for selected port.

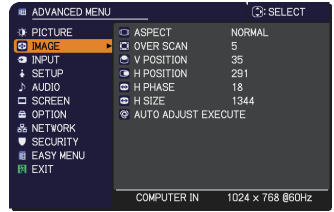

Item	Description
<p><b>ASPECT</b></p>	<p>Using the ▲/▼ buttons switches the mode for aspect ratio.</p> <p><b>For a computer signal</b></p> <p><b>CP-X8800:</b>            NORMAL ⇄ 4:3 ⇄ 16:9 ⇄ 16:10            ↑—————↑</p> <p><b>CP-WU8600, CP-WX8650, CP-WU8700, CP-WX8750:</b>            NORMAL ⇄ 4:3 ⇄ 16:9 ⇄ 16:10 ⇄ NATIVE            ↑—————↑</p> <p><b>For HDMI™, HDBaseT™, and DisplayPort signals</b></p> <p><b>CP-X8800:</b>            NORMAL ⇄ 4:3 ⇄ 16:9 ⇄ 16:10 ⇄ 14:9            ↑—————↑</p> <p><b>CP-WU8600, CP-WX8650, CP-WU8700, CP-WX8750:</b>            NORMAL ⇄ 4:3 ⇄ 16:9 ⇄ 16:10 ⇄ 14:9 ⇄ NATIVE            ↑—————↑</p> <p><b>For a video signal</b></p> <p><b>CP-X8800:</b>            4:3 ⇄ 16:9 ⇄ 14:9            ↑—————↑</p> <p><b>CP-WU8600, CP-WX8650, CP-WU8700, CP-WX8750:</b>            4:3 ⇄ 16:9 ⇄ 16:10 ⇄ 14:9 ⇄ NATIVE            ↑—————↑</p> <p><b>For an SDI signal (CP-WU8700 only)</b>            NORMAL ⇄ 4:3 ⇄ 16:9            ↑—————↑</p> <p><b>For an input signal from the LAN port, or if there is no signal</b></p> <p><b>CP-X8800:</b> 4:3 (fixed)  <b>CP-WU8600, CP-WX8650, CP-WU8700, CP-WX8750:</b> 16:10 (fixed)</p> <ul style="list-style-type: none"> <li>• The NORMAL mode keeps the original aspect ratio of the signal.</li> </ul>

(continued on next page)

Item	Description
<b>OVER SCAN</b>	<p>Using the ◀/▶ buttons adjusts the over-scan ratio.            Small (It magnifies picture) ⇔ Large (It reduces picture)</p> <ul style="list-style-type: none"> <li>• This item can be selected for a video signal and an SDI signal.</li> <li>• For HDMI™, HDBaseT™, and DisplayPort signals, this item can also be selected if either (1) or (2) applies.               <ol style="list-style-type: none"> <li>(1) DIGITAL FORMAT item in the INPUT menu for selected port is set to VIDEO.</li> <li>(2) DIGITAL FORMAT item in the INPUT menu for selected port is set to AUTO, and the projector recognizes that it receives video signals.</li> </ol> </li> </ul>
<b>V POSITION</b>	<p>Using the ◀/▶ buttons adjusts the vertical position.            Down ⇔ Up</p> <ul style="list-style-type: none"> <li>• Over-adjusting the vertical position may cause noise to appear on the screen. If this occurs, please reset the vertical position to the default setting. Pressing the <b>RESET</b> button when the V POSITION is selected will reset the V POSITION to the default setting.</li> <li>• When this function is performed on a video signal, the range of this adjustment depends on OVER SCAN (🔲<i>above</i>) setting. It is not possible to adjust when OVER SCAN is set to 10.</li> <li>• This function is unavailable for a signal from the <b>LAN, HDMI 1 / 2, HDBaseT, DisplayPort, or SDI</b> port.</li> </ul>
<b>H POSITION</b>	<p>Using the ◀/▶ buttons adjusts the horizontal position.            Right ⇔ Left</p> <ul style="list-style-type: none"> <li>• Over-adjusting the horizontal position may cause noise to appear on the screen. If this occurs, please reset the horizontal position to the default setting. Pressing the <b>RESET</b> button when the H POSITION is selected will reset the H POSITION to the default setting.</li> <li>• When this function is performed on a video signal, the range of this adjustment depends on OVER SCAN (🔲<i>above</i>) setting. It is not possible to adjust when OVER SCAN is set to 10.</li> <li>• This function is unavailable for a signal from the <b>LAN, HDMI 1 / 2, HDBaseT, DisplayPort, or SDI</b> port.</li> </ul>

(continued on next page)

Item	Description
<p><b>H PHASE</b></p>	<p>Using the ◀/▶ buttons adjusts the horizontal phase to eliminate flicker. Right ⇔ Left</p> <ul style="list-style-type: none"> <li>• This item can be selected only for a computer signal or a component video signal. This function is unavailable for a signal from the <b>LAN</b>, <b>HDMI™ 1 / 2</b>, <b>HDBaseT™</b>, <b>DisplayPort</b>, or <b>SDI</b> port.</li> </ul>
<p><b>H SIZE</b></p>	<p>Using the ◀/▶ buttons adjusts the horizontal size. Small ⇔ Large</p> <ul style="list-style-type: none"> <li>• This item can be selected only for a computer signal. This function is unavailable for a signal from the <b>LAN</b>, <b>VIDEO</b>, <b>HDMI 1 / 2</b>, <b>HDBaseT</b>, <b>DisplayPort</b>, or <b>SDI</b> port.</li> <li>• When this adjustment is excessive, the picture may not be displayed correctly. In such a case, please reset the adjustment by pressing the <b>RESET</b> button on the remote control during this operation.</li> <li>• Images might appear degraded when this function is operated, but it is not a malfunction.</li> </ul>
<p><b>AUTO ADJUST EXECUTE</b></p>	<p>Selecting this item performs the automatic adjustment feature.</p> <p><b>For a computer signal</b> The vertical position, the horizontal position and the horizontal phase will be automatically adjusted. Make sure that the application window is set to its maximum size prior to attempting to use this feature. A dark picture may still be incorrectly adjusted. Use a bright picture when adjusting.</p> <p><b>For a video signal</b> The video format best suited for the respective input signal will be selected automatically. This function is available only when the <b>AUTO</b> is selected for the <b>VIDEO FORMAT</b> item in the <b>INPUT</b> menu (▶70). The vertical position and horizontal position will be automatically set to the default.</p> <ul style="list-style-type: none"> <li>• The automatic adjustment operation requires approx. 10 seconds. Also please note that it may not function correctly with some input.</li> <li>• When this function is performed for a video signal, a certain extra such as a line may appear outside a picture.</li> <li>• When this function is performed for a computer signal, a black frame may be displayed on the edge of the screen, depending on the computer model.</li> <li>• The items adjusted by this function may vary when the <b>FINE</b> or <b>DISABLE</b> is selected for the <b>AUTO ADJUST</b> item of the <b>SERVICE</b> item in the <b>OPTION</b> menu (▶93).</li> </ul>

INPUT menu

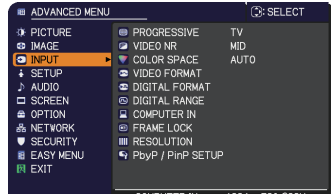

From the INPUT menu, items shown in the table below can be performed.

Select an item using the ▲/▼ cursor buttons, and press the ► cursor button or **ENTER** button to execute the item. Then perform it according to the following table.



Item	Description
<p><b>PROGRESSIVE</b></p>	<p>Using the ▲/▼ buttons switches the progress mode.                      TV ⇄ FILM ⇄ OFF                      ↑—————↑</p> <ul style="list-style-type: none"> <li>• This function works only for a video signal, component video signal (of 480i@60 or 576i@50 or 1080i@50/60), an HDMI™ signal (of 480i@60 or 576i@50 or 1080i@50/60) and HDBaseT™ signal (of 480i@60 or 576i@50 or 1080i@50/60).</li> <li>• When TV or FILM is selected, the screen image will be sharp. FILM adapts to the 2-3 Pull-Down conversion system. But these may cause a certain defect (for example, jagged line) of the picture for a quick moving object. In such a case, please select OFF, even though the screen image may lose sharpness.</li> </ul>
<p><b>VIDEO NR</b></p>	<p>Using the ▲/▼ buttons switches the noise reduction mode.                      HIGH ⇄ MID ⇄ LOW                      ↑—————↑</p> <ul style="list-style-type: none"> <li>• This function works only for a video signal, component video signal (of 480i@60 or 576i@50 or 1080i@50/60), an HDMI™ signal (of 480i@60 or 576i@50 or 1080i@50/60) and HDBaseT™ signal (of 480i@60 or 576i@50 or 1080i@50/60).</li> </ul>
<p><b>COLOR SPACE</b></p>	<p>Using the ▲/▼ buttons switches the mode for color space.                      AUTO ⇄ RGB ⇄ SMPTE240 ⇄ REC709 ⇄ REC601                      ↑—————↑</p> <ul style="list-style-type: none"> <li>• This item can be selected only for a computer signal (except for signals from the LAN and HDBaseT ports).</li> <li>• The AUTO mode automatically selects the optimum mode.</li> <li>• The AUTO operation may not work well at some signals. In such a case, it might be good to select a suitable mode except AUTO.</li> </ul>

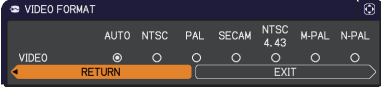
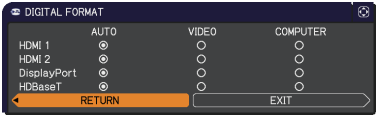

(continued on next page)

Item	Description
<p><b>VIDEO FORMAT</b></p>	<p>The video format for <b>VIDEO</b> port can be set.</p> <p>Using the ◀/▶ buttons switches the mode for video format.</p>  <p>AUTO ⇔ NTSC ⇔ PAL ⇔ SECAM          ↕ N-PAL ⇔ M-PAL ⇔ NTSC4.43 ↕</p> <ul style="list-style-type: none"> <li>• This item is performed only for a video signal from the <b>VIDEO</b> port.</li> <li>• The AUTO mode automatically selects the optimum mode.</li> <li>• The AUTO operation may not work well for some signals. If the picture becomes unstable (e.g. an irregular picture, lack of color), please select the mode according to the input signal.</li> </ul>
<p><b>DIGITAL FORMAT</b></p>	<p>The digital format of HDMI™ input signals from the <b>HDMI 1/2</b>, <b>HDBaseT™</b>, and <b>DisplayPort</b> ports can be set.</p> <p>(1) Use the ▲/▼ buttons to select the port to be set.          (2) Use the ◀/▶ buttons to select the digital format.</p>  <p>AUTO ⇔ VIDEO ⇔ COMPUTER</p> <p>↕ ↕</p> <p><u>AUTO</u>: automatically sets the optimum mode.  <u>VIDEO</u>: sets the suitable mode for DVD signals.  <u>COMPUTER</u>: sets the suitable mode for computer signals.</p> <ul style="list-style-type: none"> <li>• When the COMPUTER is selected, the function OVER SCAN (IMAGE menu) is unavailable.</li> </ul>
<p><b>DIGITAL RANGE</b></p>	<p>The digital range of HDMI™ input signals from the <b>HDMI 1/2</b>, <b>HDBaseT™</b>, <b>DisplayPort</b>, and <b>SDI</b> ports can be set.</p> <p>CP-WU8600/CP-WX8650          CP-WX8750/CP-X8800</p> <p>CP-WU8700</p>  <p>(1) Use the ▲/▼ buttons to select the port to be set.          (2) Use the ◀/▶ buttons to select the digital range.</p> <p>AUTO ⇔ NORMAL ⇔ ENHANCED          ↕ ↕</p> <p><u>AUTO</u>: automatically sets the optimum mode.  <u>NORMAL</u>: sets the suitable mode for DVD signals. (16-235)  <u>ENHANCED</u>: sets the suitable mode for computer signals. (0-255)          ((1-254) for SDI)</p> <ul style="list-style-type: none"> <li>• If the contrast of the screen image is too strong or too weak, try finding a more suitable mode.</li> </ul>

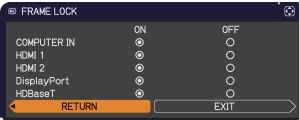
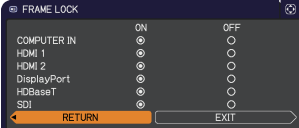
(continued on next page)

Item	Description
<p><b>COMPUTER IN</b></p>	<p>The computer input signal type for <b>COMPUTER IN</b> port can be set. Use the ◀/▶ buttons to select the computer input signal type.</p> <p style="text-align: center;">AUTO ⇔ SYNC ON G OFF</p>  <ul style="list-style-type: none"> <li>• Selecting the AUTO mode allows you to input a sync on G signal or component video signal from the port.</li> <li>• In the AUTO mode, the picture may be distorted with certain input signals. In such a case, remove the signal connector so that no signal is received and select the SYNC ON G OFF, and then reconnect the signal.</li> </ul>
<p><b>FRAME LOCK</b></p>	<p>Set the frame lock function on/off for each port.</p> <p style="text-align: center;">CP-WU8600/CP-WX8650/ CP-WX8750/CP-X8800</p>  <p style="text-align: center;">CP-WU8700</p>  <ol style="list-style-type: none"> <li>(1) Use the ▲/▼ buttons to select the input ports.</li> <li>(2) Use the ◀/▶ buttons to turn the frame lock function on/off .</li> </ol> <p style="text-align: center;">ON ⇔ OFF</p> <ul style="list-style-type: none"> <li>• This item can be performed only on a signal with a vertical frequency of 49 to 51Hz, 59 to 61 Hz.</li> <li>• When ON is selected, moving pictures are displayed more smoothly.</li> </ul>

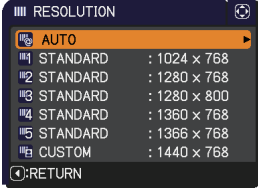
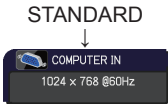
(continued on next page)

Item	Description
<p><b>RESOLUTION</b></p>	<p>The resolution for the <b>COMPUTER IN</b> input signal can be set on this projector.</p> <p>(1) In the INPUT menu select the RESOLUTION using the ▲/▼ buttons and press the ► button. The RESOLUTION menu will be displayed.</p>  <p>(2) In the RESOLUTION menu select the resolution you wish to display using the ▲/▼ buttons. Selecting AUTO SETUP will set a resolution appropriate to the input signal.</p> <p>(3) Pressing the ► or <b>ENTER</b> button when selecting a STANDARD resolution will automatically adjust the horizontal and vertical positions, clock phase and horizontal size. The INPUT_INFORMATION dialog will be displayed.</p> <p style="text-align: center;">STANDARD</p>  <p>(4) To set a custom resolution use the ▲/▼ buttons to select the CUSTOM and the RESOLUTION_CUSTOM box will be displayed. Set the (HORZ) and (VERT) resolutions using the ▲/▼/◀/▶ buttons. This function may not support all resolutions.</p> <p style="text-align: center;">CUSTOM</p>  <p>(5) Move the cursor to OK on screen and press the ► or <b>ENTER</b> button. The message "ARE YOU SURE YOU WISH TO CHANGE RESOLUTION?" appears. To save the setting, press the ► button. The horizontal and vertical positions, clock phase and horizontal size will be automatically adjusted. The INPUT_INFORMATION dialog will be displayed.</p>  <p>(6) To revert back to the previous resolution without saving changes, move the cursor to CANCEL on screen and press the ◀ or <b>ENTER</b> button. The screen will then return to the RESOLUTION menu displaying the previous resolution.</p> <ul style="list-style-type: none"> <li>• For some pictures, this function may not work well.</li> </ul>

(continued on next page)



Item	Description
<b>PbyP / PinP SETUP</b>	<b>PinP POSITION</b> Using ▲/▼ buttons on the remote control changes the position of sub area in PinP mode (📖 56).
	<b>PbyP / PinP FRAME LOCK</b> Select the screen that enables FRAME LOCK function when using PbyP or PinP. LEFT / PRIMARY: Enables FRAME LOCK function for input on left screen of PbyP or on primary area of PinP.  RIGHT / SECONDARY: Enables FRAME LOCK function for input on right screen of PbyP or on secondary area of PinP.

SETUP menu

From the SETUP menu, items shown in the table below can be performed.

Select an item using the ▲/▼ cursor buttons, and press the ► cursor button or **ENTER** button to execute the item. Then perform it according to the following table.

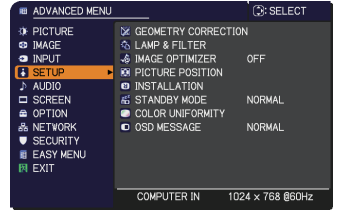

Item	Description
<p style="text-align: center;"><b>GEOMETRY CORRECTION</b></p>	<p><b>KEYSTONE</b>                      Selecting this item displays the KEYSTONE dialog. For details, see KEYSTONE in <b>Correcting the distortion (44)</b>.</p> <ul style="list-style-type: none"> <li>• When the zoom adjustment is set to the TELE (telephoto focus), this function may be excessive. This function should be used when the zoom adjustment is set to the full WIDE (wide-angle focus) whenever possible.</li> <li>• When the horizontal lens shift is not set to the center, this function may not work well.</li> <li>• This function is unavailable when the screen is activated by PERFECT FIT (45), and WARPING (46).</li> </ul>
	<p><b>PERFECT FIT</b>                      Selecting this item displays the PERFECT FIT dialog. For details, see PERFECT FIT in <b>Correcting the distortion (45)</b>.</p> <ul style="list-style-type: none"> <li>• This function is unavailable when the screen is activated by KEYSTONE (44), and WARPING (46).</li> </ul>
	<p><b>WARPING</b>                      Selecting this item displays the WARPING dialog. For details, see Application Manual of this feature.</p> <ul style="list-style-type: none"> <li>• This function is unavailable when the screen is activated by KEYSTONE (44) and PERFECT FIT (45).</li> </ul>
	<p><b>EDGE BLENDING</b>                      Selecting this item displays the EDGE BLENDING dialog. For details, see EDGE BLENDING feature (47 ~ 50).</p>



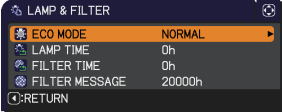

(continued on next page)

Item	Description
<p><b>GEOMETRY CORRECTION (continued)</b></p>	<p><b>PATTERN</b>                      Select PATTERN with ▲/▼ buttons.                      Displayed pattern [Off/1/2/3/4/5/6] can be switched with ◀/▶ buttons.                      PATTERN 1: Frame                      PATTERN 2: Red Grid                      PATTERN 3: Green Grid                      PATTERN 4: Blue Grid                      PATTERN 5: Vertical 9 steps                      PATTERN 6: Horizontal 9 steps                      OFF: Displays the input signal.</p>
<p><b>LAMP &amp; FILTER</b></p>	<p>Selecting this item displays the LAMP &amp; FILTER menu.                      Select an item using the ▲/▼ buttons, and press the ▶ button or the ENTER button on the remote control to execute the item.</p>  <p><b>ECO MODE</b>                      Using the ▲/▼ buttons switches the Eco mode.                      NORMAL ⇄ ECO</p> <ul style="list-style-type: none"> <li>• When the item other than NORMAL is selected, acoustic noise and screen brightness are reduced.</li> </ul> <p><b>LAMP TIME</b>                      The lamp time is the usage time of the lamp, counted after the last resetting. It is shown in the LAMP &amp; FILTER menu.                      Pressing the <b>RESET</b> button on the remote control or the ▶ button of the projector displays a dialog.                      To reset the lamp time, select the OK using the ▶ button.                      CANCEL ⇄ OK</p> <ul style="list-style-type: none"> <li>• For the lamp replacement, see the section <b>Replacing the lamp (108)</b>.</li> <li>• The lamp time can be checked also with the Status Monitor (31).</li> <li>• The IMAGE OPTIMIZER function does not work properly unless LAMP TIME is initialized when replacing a lamp.</li> </ul>

(continued on next page)

Item	Description
<p><b>LAMP &amp; FILTER</b> (continued)</p>	<p><b>FILTER TIME</b> The filter time is the usage time of the air filter, counted after the last resetting. It is shown in the <b>LAMP &amp; FILTER</b> menu. Pressing the <b>RESET</b> button on the remote control or the ► button of the projector displays a dialog. To reset the filter time, select the OK using the ► button. CANCEL ⇨ OK</p> <ul style="list-style-type: none"> <li>• Please reset the filter time only when you have cleaned or replaced the air filter, for a suitable indication about the air filter.</li> <li>• For the air filter cleaning, see the section Cleaning and replacing the air filter (110).</li> <li>• The filter time can be checked also with the Status Monitor (31).</li> </ul>
	<p><b>FILTER MESSAGE</b> Use the ▲/▼ button to set the timer for notifying by the message when to replace the filter unit 1000h ⇨ 2000h ⇨ 5000h ⇨ 10000h ⇨ 15000h ⇨ 20000h ⇨ 25000h ⇨ 30000h ⇨ OFF After choosing an item except OFF, the message “REMINDER *** HRS PASSED ...” will appear after the timer reaches the interval time set by this feature. When the OFF is chosen, the message will not appear. Utilize this feature to keep the air filter clean, setting the suitable time according to your environment of this projector.</p> <ul style="list-style-type: none"> <li>• Please take care of the filter unit periodically, even if there is no message. If the air filter becomes to be blocked by dust or other matter, the internal temperature will rise, which could cause malfunction, or reduce the lifetime of the projector.</li> <li>• Please be careful with the operating environment of the projector and the condition of the filter unit.</li> </ul>
<p><b>IMAGE OPTIMIZER</b></p>	<p>When this function is enabled, automatic image correction is performed to maintain visibility in accordance with lamp deterioration.</p> <ul style="list-style-type: none"> <li>• This function may not work properly when HDCR/ACCENTUALIZER is set to other than 0.</li> <li>• This function does not work properly unless LAMP TIME is initialized when replacing a lamp.</li> </ul>

(continued on next page)

Item	Description
<p><b>PICTURE POSITION</b></p>	<p>Using the ▲/▼/◀/▶ cursor buttons selects the desirable picture position.                      The PICTURE POSITION is not changed if any of the following cases apply.</p> <ul style="list-style-type: none"> <li>• There is no non-display area (black display or background display) or it is not displayed on the screen.</li> <li>• One of the following messages is displayed on the screen:                      "NO INPUT IS DETECTED"                      "SYNC IS OUT OF RANGE"                      "INVALID SCAN FREQ."</li> <li>• The BLANK or TEMPLATE function is selected.</li> </ul>
<p><b>INSTALLATION</b></p>	<p>Pressing the ► button displays the dialog for changing the INSTALLATION setting.</p> <div style="display: flex; align-items: center; margin-bottom: 5px;">  <div style="text-align: center;">FRONT / DESKTOP</div> </div> <div style="text-align: center; margin-bottom: 5px;">⇕</div> <div style="display: flex; align-items: center; margin-bottom: 5px;">  <div style="text-align: center;">REAR / DESKTOP</div> </div> <div style="text-align: center; margin-bottom: 5px;">⇕</div> <div style="display: flex; align-items: center; margin-bottom: 5px;">  <div style="text-align: center;">REAR / CEILING</div> </div> <div style="text-align: center; margin-bottom: 5px;">⇕</div> <div style="display: flex; align-items: center;">  <div style="text-align: center;">FRONT / CEILING</div> </div> <p>Use the ▲/▼ buttons to select the desired setting on the INSTALLATION dialog, and press the <b>ENTER</b> button of the remote control or the <b>INPUT</b> button of the projector to execute.                      If TRANSITION DETECTOR is ON and the INSTALLATION status is changed, the TRANSITION DETECTOR ON alarm (🔊104) will be displayed when the projector is restarted.</p>

(continued on next page)

Item	Description
<p><b>STANDBY MODE</b></p>	<p>Using ▲/▼ buttons switches the standby mode setting between NORMAL and SAVING.            NORMAL ⇔ SAVING</p> <p>When SAVING is selected, the power consumption in the standby mode is lowered with some functional restriction as below:</p> <ul style="list-style-type: none"> <li>• When SAVING is selected, the RS-232C communication control except to turn the projector on and the network function are disabled while the projector is in the standby mode. If the COMMUNICATION TYPE in the COMMUNICATION menu is set to NETWORK BRIDGE, all of the RS-232C commands are disabled (p.96).</li> <li>• This function will be unavailable when NETWORK BRIDGE is selected for COMMUNICATION TYPE. (OPTION menu &gt; SERVICE &gt; COMMUNICATION)</li> <li>• This function will be available only when OFF is selected for STACK MODE. (OPTION menu &gt; SERVICE &gt; COMMUNICATION &gt; STACK)</li> <li>• When SAVING is selected, AUDIO OUT STANDBY setting of AUDIO SOURCE (p.80) is invalid, and no signal is output from <b>AUDIO OUT</b> port in the standby mode.</li> <li>• When SAVING is selected, STANDBY setting of MONITOR OUT is invalid, and no signal is output from <b>MONITOR OUT</b> port in the standby mode.</li> <li>• When SAVING is selected, the CENTERING feature while the projector is in the standby mode is disabled.</li> <li>• When SAVING is selected, the Status Monitor and its button operation are unavailable while the projector is in the standby mode.</li> <li>• When SAVING is selected, the HDMI Link and HDBaseT functions are disabled while the projector is in the standby mode.</li> </ul>
<p><b>COLOR UNIFORMITY</b></p>	<p>Selects image level and region that are desired to be corrected, and adjusts Color Balance.            Divides the screen into 9 regions and adjusts gain of R/G/B of each region.</p>

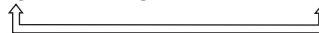

(continued on next page)

Item	Description
<p><b>OSD MESSAGE</b></p>	<p>Using the ▲/▼ buttons turns on/off the message function.            NORMAL ↔ SILENT ↔ INHIBIT  </p> <p>■ <b>SILENT</b> : The following message functions does not work.            “AUTO IN PROGRESS” while automatically adjusting            “NO INPUT IS DETECTED”            “SYNC IS OUT OF RANGE”            “INVALID SCAN FREQ.”            “NOT AVAILABLE”            “Searching....” while searching for the input            “Detecting....” while an input signal is detected            The indication of the ZOOM displayed by changing                *While operating from the remote control only.            The indication of the FOCUS displayed by changing            The indication of the input signal displayed by changing            The indication of the aspect ratio displayed by changing            The indication of the PICTURE MODE displayed by changing            The indication of the ACTIVE IRIS displayed by changing            The indication of the MY MEMORY displayed by changing            The indication of “FREEZE” and “II” while freezing the screen by pressing the <b>FREEZE</b> button.            The indication of the TEMPLATE displayed by changing.            The indication of the ECO MODE displayed by changing.</p> <p>■ <b>INHIBIT</b> : All message functions does not work.            The only buttons will function are as below.            STANDBY, ON            Status Monitor can be operated.</p> <ul style="list-style-type: none"> <li>• To change this function, follow the steps below.               <ol style="list-style-type: none"> <li>1. Press the <b>OSD MSG</b> button on the remote control for 3 sec.</li> <li>2. The HIDE OSD will be displayed.                    While this OSD is displayed, press the <b>OSD MSG</b> button again on the remote control.</li> <li>3. Toggle and change the function.</li> </ol> </li> </ul> <p>NORMAL ↔ SILENT ↔ INHIBIT  </p>

## AUDIO menu

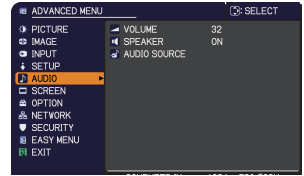
From the AUDIO menu, items shown in the table below can be performed. Select an item using the ▲/▼ cursor buttons, and press the ► cursor button or the **ENTER** button to execute the item. Then perform it according to the following table.



Item	Description								
<b>VOLUME</b>	Using the ◀/▶ buttons adjusts the volume of the audio output. Low ⇔ High								
<b>SPEAKER</b>	Using the ▲/▼ buttons turns on/off the built-in speaker. ON ⇔ OFF When OFF is selected, the built-in speaker does not work.								
<b>AUDIO SOURCE</b>	<p>While the image signal from the input port chosen in step (1) is projected, the audio signal from the input port selected in step (2) is output to both the <b>AUDIO OUT</b> port and built-in speaker of this projector. However, the built-in speaker does not work when <b>SPEAKER</b> is set to OFF.</p> <p>CP-WU8600/CP-WX8650 CP-WX8750/CP-X8800</p> <p>CP-WU8700</p> <div style="display: flex; justify-content: space-around;">   </div> <p>(1) Choose a picture input port using the ▲/▼ buttons. Choose <b>AUDIO OUT STANDBY</b> to select the sound output in the standby mode.</p> <p>(2) Select an audio input port or the mute icon using the ◀/▶ buttons. The icons indicate the following;</p> <table style="width: 100%; border: none;"> <tr> <td style="width: 50%;">No.1: <b>AUDIO IN1</b> port</td> <td style="width: 50%;">No.2: <b>AUDIO IN2</b> port</td> </tr> <tr> <td>No.3: <b>HDMI 1</b> port</td> <td>No.4: <b>HDMI 2</b> port</td> </tr> <tr> <td>No.5: <b>DisplayPort</b></td> <td>No.6: <b>HDBaseT</b> port</td> </tr> <tr> <td>No.7: <b>LAN</b> port</td> <td>⌘ : mutes the sound</td> </tr> </table> <ul style="list-style-type: none"> <li>• Audio input from port Nos.3 to 7 can only be selected by each of the picture input ports and <b>AUDIO OUT STANDBY</b>.</li> <li>• C.C. (Closed Caption) is automatically activated when ⌘ is selected and an input signal containing C.C. is received. This function is available only when the signal is NTSC for <b>VIDEO</b> or <b>COMPUTER IN</b>, and when <b>AUTO</b> is selected for <b>DISPLAY</b> in the <b>C.C.</b> menu under the <b>SCREEN</b> menu (📖86).</li> </ul>	No.1: <b>AUDIO IN1</b> port	No.2: <b>AUDIO IN2</b> port	No.3: <b>HDMI 1</b> port	No.4: <b>HDMI 2</b> port	No.5: <b>DisplayPort</b>	No.6: <b>HDBaseT</b> port	No.7: <b>LAN</b> port	⌘ : mutes the sound
No.1: <b>AUDIO IN1</b> port	No.2: <b>AUDIO IN2</b> port								
No.3: <b>HDMI 1</b> port	No.4: <b>HDMI 2</b> port								
No.5: <b>DisplayPort</b>	No.6: <b>HDBaseT</b> port								
No.7: <b>LAN</b> port	⌘ : mutes the sound								



## SCREEN menu

From the SCREEN menu, items shown in the table below can be performed.

Select an item using the ▲/▼ cursor buttons, and press the ► cursor button or **ENTER** button to execute the item. Then perform it according to the following table.

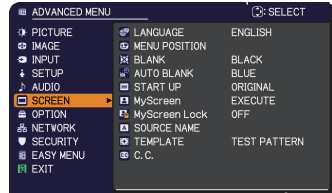



Item	Description
<b>LANGUAGE</b>	<p>Using the ▲/▼/◀/▶ buttons switches the OSD (On Screen Display) language.  <b>ENGLISH</b> ⇔ <b>FRANÇAIS</b> ⇔ <b>DEUTSCH</b> ⇔ <b>ESPAÑOL</b>            ⬅ ..... (shown in the LANGUAGE dialog) ..... ➡            Press the <b>ENTER</b> or <b>INPUT</b> button to save the language setting.</p>
<b>MENU POSITION</b>	<p>Using the ▲/▼/◀/▶ buttons adjusts the menu position.            To quit the operation, press the <b>MENU</b> button on the remote control or keep no operation for about 10 seconds.</p>
<b>BLANK</b>	<p>Using the ▲/▼ buttons switches the mode for the blank screen. The blank screen is a screen for the temporarily blanking feature (p. 37). It is displayed by pressing the <b>AV MUTE</b> button on the remote control.</p> <p><b>MyScreen</b> ⇔ <b>ORIGINAL</b> ⇔ <b>BLUE</b> ⇔ <b>WHITE</b> ⇔ <b>BLACK</b>            ⬅—————➡</p> <p><b>MyScreen</b> : Screen can be registered by the MyScreen item (p. 83).  <b>ORIGINAL</b> : Screen preset as the standard screen.  <b>BLUE, WHITE, BLACK</b> : Plain screens in each color.</p> <ul style="list-style-type: none"> <li>• To avoid remaining as an afterimage, the MyScreen or ORIGINAL screen will change to the AUTO BLANK screen after several minutes.</li> </ul>





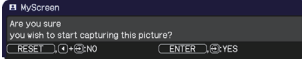
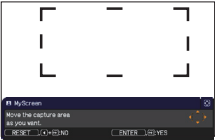

(continued on next page)

Item	Description
<p><b>AUTO BLANK</b></p>	<p>Using the ▲/▼ buttons switches the mode for the AUTO BLANK screen.</p> <p>BLUE ⇔ WHITE ⇔ BLACK</p> <p style="text-align: center;">↑—————↑</p> <ul style="list-style-type: none"> <li>• To avoid remaining as an afterimage, displayed image will change to the designated blank color screen by AUTO BLANK after several minutes at the following conditions.</li> <li>- When MyScreen or ORIGINAL is displayed as BLANK screen.</li> <li>- When start-up screen is displayed.</li> </ul>
<p><b>START UP</b></p>	<p>Using the ▲/▼ buttons switches the mode for the start-up screen. The start-up screen is a screen displayed when no signal or an unsuitable signal is detected.</p> <p>MyScreen ⇔ ORIGINAL ⇔ OFF</p> <p style="text-align: center;">↑—————↑</p> <p><u>MyScreen</u> : Screen can be registered by the MyScreen item (📖83).</p> <p><u>ORIGINAL</u> : Screen preset as the standard screen.</p> <p><u>OFF</u> : Plain black screen.</p> <ul style="list-style-type: none"> <li>• To avoid remaining as an afterimage, the START UP screen will change to the AUTO BLANK screen after several minutes.</li> <li>• When the ON is selected to the MyScreen PASSWORD item in the SECURITY menu (📖102), the START UP is fixed to MyScreen.</li> </ul>

(continued on next page)

Item	Description
MyScreen	<p>This item allows you to capture an image for use as a MyScreen image which can be used as the BLANK screen and START UP screen. Display the image you want to capture before executing the following procedure.</p> <p>(1) Selecting this item displays a dialog titled “MyScreen”. It will ask you if you start capturing an image from the current screen.</p>  <p>Please wait for the target image to be displayed, and press the <b>ENTER</b> or <b>INPUT</b> button when the image is displayed. The image will freeze and the frame for capturing will appear.</p> <p>To stop performing, press the <b>RESET</b> button on the remote control.</p> <p>(2) Using the <b>▲/▼/◀/▶</b> buttons adjusts the frame position.</p>  <p>Please move the frame to the position of the image which you want to use. The frame may not be able to be moved for some input signals.</p> <p>To start registration, press the <b>ENTER</b> or <b>INPUT</b> button on the remote control.</p>  <p>To restore the screen and return to the previous dialog, press the <b>RESET</b> button on the remote control.</p> <p>Registration may take several minutes.</p> <p>When the registration is completed, the registered screen and the following message is displayed for several seconds:</p> <p><b>“MyScreen registration is finished.”</b></p> <p>If the registration failed, the following message is displayed:</p> <p><b>“A capturing error has occurred. Please try again.”</b></p> <ul style="list-style-type: none"> <li>• This function cannot be selected when the ON is selected to the MyScreen Lock item (104).</li> <li>• This function cannot be selected when the ON is selected to the MyScreen PASSWORD item in SECURITY menu (102).</li> <li>• This function is unavailable for a signal from the LAN, HDMI 1 / 2, HDBaseT or SDI port.</li> </ul>

(continued on next page)

Item	Description
<p><b>MyScreen Lock</b></p>	<p>Using the ▲/▼ buttons turns on/off the MyScreen lock function. ON ⇄ OFF</p> <p>When the ON is selected, the item MyScreen is locked. Use this function for protecting the current MyScreen.</p> <ul style="list-style-type: none"> <li>This function cannot be selected when the ON is selected to the MyScreen PASSWORD item in SECURITY menu (102).</li> </ul>
<p><b>SOURCE NAME</b></p>	<p>Each input port for this projector can have a name applied to it.</p> <p>(1) Use the ▲/▼ buttons on the SCREEN menu to select SOURCE NAME and press the ► or <b>ENTER</b> button. The SOURCE NAME menu will be displayed.</p> <p>(2) Use the ▲/▼ buttons on the SOURCE NAME menu to select the port to be named and press the ► button. The SOURCE NAME dialog will be displayed. Right side of the menu is blank until a name is specified.</p> <p>CP-WU8600/CP-WX8650 CP-WX8750/CP-X8800</p>  <p>CP-WU8700</p>  <p>(3) Select an icon you would like to assign to the port in the SOURCE NAME dialog. The name assigned to the port will also be automatically switched according to your icon selection. Press the <b>ENTER</b> or <b>INPUT</b> button to determine your icon selection.</p>  <p>(4) Select a number you would like to assign to the port along with the icon. You can select the number either from blank (no number assigned), 1, 2, 3, or 4. Then press the <b>ENTER</b> or <b>INPUT</b> button.</p>  <p>(5) If you would like to modify the name assigned to the port, select CUSTOM NAME and press the <b>ENTER</b> or <b>INPUT</b> button.</p> <p>CP-WU8600/CP-WX8650 CP-WX8750/CP-X8800</p>  <p>CP-WU8700</p> 

(continued on next page)

Item	Description
<p><b>SOURCE NAME</b> (continued)</p>	<p>(6) The current name will be displayed on the first line. Use the ▲/▼/◀/▶ buttons and the <b>ENTER</b> or <b>INPUT</b> button to select and enter characters. To erase 1 character at one time, press the <b>RESET</b> button or press the ◀ and <b>INPUT</b> button at the same time. Also if you move the cursor to <b>DELETE</b> or <b>CLEAR ALL</b> on screen and press the <b>ENTER</b> or <b>INPUT</b> button, 1 character or all characters will be erased. The name can be a maximum of 16 characters.</p> <p>(7) To change an already inserted character, press the ▲ button to move the cursor to the first line, and use the ◀/▶ buttons to move the cursor on the character to be changed. After pressing the <b>ENTER</b> or <b>INPUT</b> button, the character is selected. Then, follow the same procedure as described at the item (6) above.</p> <p>(8) To finish entering text, move the cursor to the OK on screen and press the ▶, <b>ENTER</b> or <b>INPUT</b> button. To revert to the previous name without saving changes, move the cursor to the <b>CANCEL</b> on screen and press the ◀, <b>ENTER</b> or <b>INPUT</b> button.</p> 
<p><b>TEMPLATE</b></p>	<p>Using the ▲/▼ cursor buttons switches the mode for the template screen. Press the ▶ cursor (or the <b>ENTER</b>) button to display the selected template, and press the ◀ cursor button to close the displayed screen. The last selected template is displayed when the <b>MY BUTTON</b> allocated to the <b>TEMPLATE</b> function is pressed (89).</p> <p>TEST PATTERN ⇔ DOT-LINE1 ⇔ DOT-LINE2 ⇔ DOT-LINE3 ⇕ ⇕</p> <p>STACK ⇔ MAP2 ⇔ MAP1 ⇔ CIRCLE2 ⇔ CIRCLE1 ⇔ DOT-LINE4</p> <p>You can turn a map upside down and scroll it horizontally when MAP1 or MAP2 is selected. To invert or scroll the map, display the guidance by pressing the <b>RESET</b> button on the remote three seconds or more when MAP1 or MAP2 appears.</p>

(continued on next page)

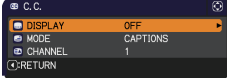

Item	Description
<p style="text-align: center;"><b>C.C.</b> <b>(Closed Caption)</b></p>	<p>The C.C. is the function that displays a transcript or dialog of the audio portion of a video, files or other presentation or other relevant sounds. It is required to have NTSC format video or 480i@60 format component video source supporting C.C. feature to utilize this function.</p> <p>It may not work properly, depending on equipment or signal source. In this case, please turn off the Closed Caption.</p> 
	<p><b>DISPLAY</b></p> <p>Select Closed Caption DISPLAY setting from following options using ▲/▼ buttons.</p> <p style="text-align: center;">AUTO ⇄ ON ⇄ OFF</p> <p style="text-align: center;">↑—————↓</p> <p><u>AUTO</u> : Closed Caption automatically appears when the input signal (C.C. compatible) from the port with the mute icon set at AUDIO SOURCE is selected.</p> <p><u>ON</u> : Closed Caption is on.</p> <p><u>OFF</u> : Closed Caption is off.</p> <ul style="list-style-type: none"> <li>• The caption is not displayed when the OSD menu is active.</li> <li>• The Closed Caption is the function to display the dialogue, narration, and / or sound effects of a television program or other video sources. The Closed Caption availability is depending upon broadcaster and/or content.</li> </ul>
	<p><b>MODE</b></p> <p>Select Closed Caption MODE setting from following options using ▲/▼ buttons.</p> <p style="text-align: center;">CAPTIONS ⇄ TEXT</p> <p><u>CAPTIONS</u> : Display Closed Caption.</p> <p><u>TEXT</u> : Display Text data, which is for additional information such as news reports or a TV program guide. The information covers the entire screen. Not all of the C.C. program has Text information.</p>
	<p><b>CHANNEL</b></p> <p>Select Closed Caption CHANNEL from following options using ▲/▼ buttons.</p> <p style="text-align: center;">1 ⇄ 2 ⇄ 3 ⇄ 4</p> <p style="text-align: center;">↑—————↓</p> <p>1: Channel 1, primary channel / language                  2: Channel 2                  3: Channel 3                  4: Channel 4</p> <p>The channel data may vary, depending on the content. Some channel might be used for secondary language or empty.</p>

OPTION menu

From the OPTION menu, items shown in the table below can be performed.

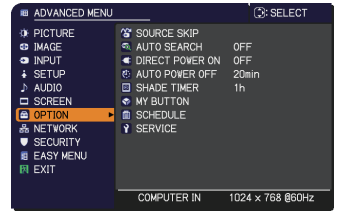

Select an item using the ▲/▼ cursor buttons, and press the ► cursor button or ENTER button to execute the item. Then perform it according to the following table.



Item	Description
<p><b>SOURCE SKIP</b></p>	<p>The ports can be set to be ignored in searching by the AUTO SEARCH function (see below) or in selecting by buttons on the control panel.</p> <p>CP-WU8600/CP-WX8650 CP-WX8750/CP-X8800</p>  <p>CP-WU8700</p>  <ol style="list-style-type: none"> <li>(1) Choose a picture input port using the ▲/▼ buttons.</li> <li>(2) Using the ◀/▶ buttons turns on/off the SOURCE SKIP function. NORMAL ⇔ SKIP</li> </ol> <p>The port that is set to SKIP will be ignored.</p> <ul style="list-style-type: none"> <li>• It is not possible to set SKIP to all ports at the same time.</li> <li>• This setting is not valid when in the PbyP /PinP mode (see 53).</li> </ul>
<p><b>AUTO SEARCH</b></p>	<p>Using the ▲/▼ buttons turns on/off the automatic signal search function. ON ⇔ OFF</p> <p>When the ON is selected, detecting no signal automatically cycles through input ports in the following order. The search is started from the current port. Then when an input is found, the projector will stop searching and display the image.</p> <pre> LAN ⇔ COMPUTER IN ⇔ HDMI 1   ↑                               ↓ VIDEO                               HDMI 2   ↑                               ↓ SDI* ⇔ HDBaseT ⇔ DisplayPort     </pre>

\* CP-WU8700 only

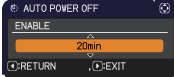
(continued on next page)

Item	Description
<p><b>DIRECT POWER ON</b></p>	<p>Using the ▲/▼ buttons turns on/off the DIRECT POWER ON function.            ON ⇔ OFF</p> <p>When set to the ON, the lamp in projector will be automatically turned on without the usual procedure (☰35), only when the projector is supplied with the power after the power was cut while the lamp was on.</p> <ul style="list-style-type: none"> <li>• This function does not work as long as the power has been supplied to the projector while the lamp is off.</li> <li>• After turning the lamp on by the DIRECT POWER ON function, if neither input nor operation is detected for about 30 minutes, the projector is turned off, even though the AUTO POWER OFF function (☰below) is disabled.</li> </ul>
<p><b>AUTO POWER OFF</b></p>	<p>Using the ▲/▼ buttons adjusts the time to count down to automatically turn the projector off.            Long (max. 99 minutes) ⇔ Short (min. 0 minute = DISABLE)</p> <div style="display: flex; justify-content: space-around; align-items: center;">   </div> <p>When the time is set to 0, the projector is not turned off automatically.            When the time is set to 1 to 99, and when the passed time with no-signal or an unsuitable signal reaches at the set time, the projector lamp will be turned off.            If one of the projector's buttons or the remote control buttons is pressed or one of the commands (except get commands) is transmitted to the <b>CONTROL</b> port during the corresponding time, projector will not be turned off.            Please refer to the section <b>Turning off the power</b> (☰35).</p>
<p><b>SHADE TIMER</b></p>	<p>Using the ▲/▼ buttons sets the time from closing the lens shade to automatically turning the projector off.            1h ⇔ 3h ⇔ 6h</p> <div style="text-align: center;">  </div> <ul style="list-style-type: none"> <li>• The shade will open automatically when turning the projector on again.</li> </ul>

(continued on next page)



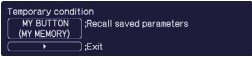

Item	Description
<p><b>MY BUTTON</b></p>	<p>This item is to assign one of the following functions to <b>MY BUTTON</b> (1 to 4) on the remote control ( 7 ).</p> <p>(1) Use the ▲/▼ buttons on the MY BUTTON menu to select a button from MY BUTTON - 1 to 4 and press the ► or <b>ENTER</b> button to display the MY BUTTON setup dialog.</p> <p>(2) Then using the ▲/▼/◀/► buttons sets one of the following functions to the chosen button. Press the <b>ENTER</b> or <b>INPUT</b> button to save the setting.</p> <p><u>MY IMAGE</u>: Displays the MY IMAGE menu. ( 5. My Image Function in the Network Guide)</p> <p><u>MESSENGER</u>: Turns the messenger text displayed on the screen on/off ( 6. Messenger Function in the Network Guide). When there is no transferred text data to display, the message "NO MESSENGER DATA" appears.</p> <p><u>BLANK</u>: Switches the BLANK function to on or off.</p> <p><u>SHADE</u>: Turns the lens shade closed and opened ( 52 ).</p> <p><u>PbyP / PinP SWAP</u>: Swaps the picture on the right with one on the left in the PbyP mode. Swaps the primary picture and the secondary picture in the PinP mode. ( 53 )</p> <p><u>PinP POSITION</u>: Toggles the PinP position.</p> <p><u>INFORMATION</u>: Displays SYSTEM INFORMATION, INPUT INFORMATION ( 99 ), WIRELESS INFORMATION, WIRED INFORMATION or nothing.</p> <p><u>MY MEMORY</u>: Loads one of adjustment data stored ( 65 ). When more than one data are saved, the adjustment changes every time the <b>MY BUTTON</b> is pressed. When no data is saved in memory, the dialog "No saved data" appears. When the current adjustment is not saved to memory, the dialog as shown in the right appears.</p> <div style="text-align: right;">  </div> <div style="text-align: right;">  </div> <p>If you want to keep the current adjustment, please press the ► button to exit. Otherwise loading a data will overwrite the current adjusted condition.</p> <p><u>ACTIVE IRIS</u>: Changes the active iris mode ( 62 ).</p> <p><u>PICTURE MODE</u>: Changes the PICTURE MODE ( 63 ).</p> <p><u>FILTER RESET</u>: Displays the filter time reset confirmation dialogue ( 76 ).</p> <p><u>TEMPLATE</u>: Makes the template pattern selected to the TEMPLATE item ( 85 ) appear or disappear.</p> <p><u>MUTE</u>: Turns the audio mute on/off.</p> <p><u>RESOLUTION</u>: Turns on/off the RESOLUTION dialog ( 72 ).</p> <p><u>ECO MODE</u>: Changes the ECO MODE dialog ( 75 ).</p>

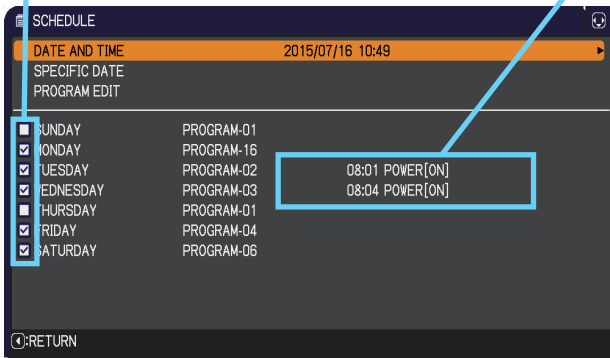

(continued on next page)

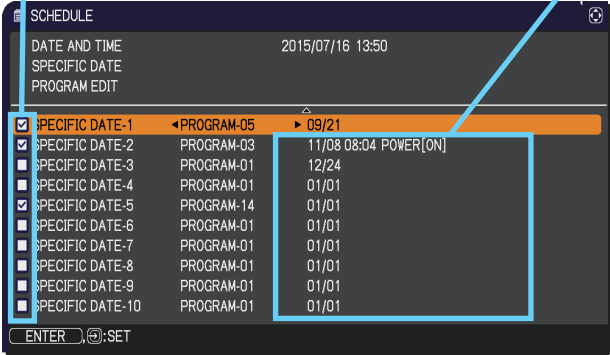
Item	Description								
<p><b>MY BUTTON</b> (continued)</p>	<p><b>ACCENTUALIZER:</b> Turns on/off the ACCENTUALIZER dialog ( 65).  <b>HDCCR:</b> Turns on/off the HDCCR dialog ( 65).  <b>STATUS MONITOR:</b> Turns on/off the back light of status monitor ( 31). This function is unavailable when SAVING is selected in STANDBY MODE while the projector is in the standby mode.</p>								
<p><b>SCHEDULE</b></p>	<p>■ <b>How to setup the item</b></p> <ol style="list-style-type: none"> <li>1. Use the ▲/▼/◀/▶ cursor buttons to select or adjust.</li> <li>2. Select OK to finish the settings.</li> </ol> <div data-bbox="308 478 1036 558" style="border: 1px solid black; padding: 5px; margin: 10px 0;"> <p><b>NOTE</b> Please refer to the actual on-screen display(OSD) for appropriate operation.</p> </div> <table border="1" data-bbox="302 582 1030 798" style="width: 100%; border-collapse: collapse;"> <thead> <tr> <th style="width: 30%;">Item</th> <th>Description</th> </tr> </thead> <tbody> <tr> <td><b>DATE &amp; TIME</b></td> <td>Set the DATE(Year/Month/Date) and Time(24-hour scale).</td> </tr> <tr> <td><b>SPECIFIC DATE</b></td> <td>Set specific date from 1 to 10.</td> </tr> <tr> <td><b>PROGRAM EDIT</b></td> <td>The TIME and EVENT for Program 1 to 16 can be edited.</td> </tr> </tbody> </table> <p>■ <b>How to activate (DATE AND TIME / SPECIFIC DATE)</b></p> <p>Place a check mark in the box.</p> <div data-bbox="319 933 448 981"> <p>Check mark in the box</p> </div> <div data-bbox="834 901 1013 1013"> <p>Date and first setup info could be seen with the check mark.</p> </div>  <p>1/2 page (Set the DATE(Year/Month/Date) and Time(24-hour scale).)</p>	Item	Description	<b>DATE &amp; TIME</b>	Set the DATE(Year/Month/Date) and Time(24-hour scale).	<b>SPECIFIC DATE</b>	Set specific date from 1 to 10.	<b>PROGRAM EDIT</b>	The TIME and EVENT for Program 1 to 16 can be edited.
Item	Description								
<b>DATE &amp; TIME</b>	Set the DATE(Year/Month/Date) and Time(24-hour scale).								
<b>SPECIFIC DATE</b>	Set specific date from 1 to 10.								
<b>PROGRAM EDIT</b>	The TIME and EVENT for Program 1 to 16 can be edited.								

(continued on next page)

Item	Description
<p><b>SCHEDULE</b> (continued)</p>	<p>Check mark in the box</p> <p>Date and first setup info could be seen with the check mark.</p>  <p>2/2 page (Set specific date from 1 to 10.)</p> <p>■ <b>PROGRAM EDIT</b></p> <p>The TIME and EVENT for Program 1 to 16 can be edited.</p> <ul style="list-style-type: none"> <li>• <b>RETURN</b> Select this to go back to the top menu of the SCHEDULE.</li> <li>• <b>SELECT</b> Select from PROGRAM-01 to 16 to edit. Each PROGRAM can be setup up to 20 settings.</li> <li>• <b>COPY TO</b> The selected program (with the settings of TIME and EVENT) can be copied to other program.</li> <li>• <b>APPLY</b> Select this to apply and save all adjustments and settings.</li> </ul> 

(continued on next page)

Item	Description
<p><b>SCHEDULE (continued)</b></p>	<p>■ <b>How to edit the selected PROGRAM</b></p> <ol style="list-style-type: none"> <li>1. Select from 1 to 20 events. Use the ▲/▼ cursor buttons to select. Press ► cursor button to set the TIME and EVENT.</li> <li>2. Use the ◀/▶ cursor buttons to select.</li> <li>3. Use the ▲/▼ cursor buttons to adjust.</li> </ol> <p>EVENT can be selected as listed below.</p> <ul style="list-style-type: none"> <li>◦ POWER – ON, STANDBY</li> <li>◦ INPUT SOURCE – "input source"channel</li> <li>◦ MY IMAGE – IMAGE-1 to 4, IMAGE OFF</li> <li>◦ MESSENGER – TEXT-1 to 12, TEXT OFF</li> <li>◦ ECO MODE – NORMAL, ECO</li> <li>◦ BLANK – ON, OFF</li> </ul>  <ol style="list-style-type: none"> <li>4. Press ► cursor button to finish the settings.</li> <li>5. Select APPLY to save the settings.</li> </ol> <p><b>NOTE</b> Please refer to the actual on-screen display(OSD) for appropriate operation.</p>
	



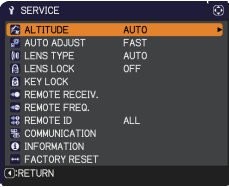

(continued on next page)

Item	Description
<p><b>SERVICE</b></p>	<p>Selecting this item displays the SERVICE menu.                      Select an item using the ▲/▼ buttons, and press the ► button or the <b>ENTER</b> button on the remote control to execute the item.</p> 
	<p><b>ALTITUDE</b>                      Using the ▲/▼ buttons switches the rotation speed of the cooling fans. It is recommended to leave it at AUTO usually.</p> <p>HIGH-2 ⇄ HIGH-1 ⇄ NORMAL ⇄ AUTO                      ↑—————↑</p> <p><u>AUTO</u>: The projector changes the rotation speed automatically to suit the altitude and other environmental factors.                      Choose an option below when there is a trouble with the AUTO mode.</p> <p><u>NORMAL</u>: This mode can be used below 1600m (5250ft.).  <u>HIGH-1</u>: This mode can be used between 1600 to 2300m (5250 to 7550ft.).  <u>HIGH-2</u>: This mode can be used above 2300m (7550ft.).</p>
	<p><b>AUTO ADJUST</b>                      Using the ▲/▼ buttons to select one of the mode. When the DISABLE is selected, the automatic adjustment feature is disabled.</p> <p>FINE ⇄ FAST ⇄ DISABLE                      ↑—————↑</p> <p><u>FINE</u>: Finer tuning including H.SIZE adjustment.  <u>FAST</u>: Faster tuning, setting H.SIZE to prearranged data for the input signal.</p> <ul style="list-style-type: none"> <li>Depending on conditions, such as input image, signal cable to the projector, environment around the projector, etc., the automatic adjustment may not work correctly. In such a case, please choose DISABLE to disable the automatic adjustment, and make adjustment manually.</li> </ul>

(continued on next page)

Item	Description
<p><b>SERVICE (continued)</b></p>	<p><b>LENS TYPE</b></p> <p>(1) Select the lens type currently used using the ▲/▼ buttons and press the ► or <b>ENTER</b> button. If AUTO is selected, the projector determines the lens type automatically.</p> <p>(2) A message dialog is displayed for confirmation. Press the ► or <b>ENTER</b> button to save the lens type.</p> <ul style="list-style-type: none"> <li>• This setting has an influence on the keystone distortion etc.</li> <li>• The lens type determined by the projector will be displayed on the right of "AUTO".</li> <li>• If the projector cannot determine the lens type automatically when this item is set to AUTO, "UNKNOWN LENS" is displayed on the right of "AUTO".</li> <li>• About the optional lens, ask your dealer.</li> </ul>
	<p><b>LENS LOCK</b></p> <p>Using the ▲/▼ buttons turns on/off the lens lock feature. When ON is selected, the buttons (<b>ZOOM</b>, <b>ZOOM + / -</b>, <b>FOCUS + / -</b>, <b>LENS SHIFT</b>, <b>LENS MEMORY</b>) are locked.</p> <p>ON ⇄ OFF</p>

(continued on next page)

Item	Description
<p><b>SERVICE</b> (continued)</p>	<p><b>KEY LOCK</b></p> <p>(1) Use the ▲/▼ buttons to choose the operations control. CONTROL PANEL ⇔ REMOTE CONTROL</p> <p>(2) Use the ◀/▶ buttons to select ON or OFF. ON ⇔ OFF</p>  <p>Selecting ON in Step 2 locks the buttons except <b>STANDBY, ON</b> and <b>STANDBY/ON</b> on the operations control selected in Step 1. Selecting OFF releases the locked buttons on the operations control selected in Step 1.</p> <ul style="list-style-type: none"> <li>• Please use this function to prevent tampering or accidental operation.</li> <li>• It's not possible to disable both options at the same time.</li> </ul>
	<p><b>REMOTE RECEIV.</b></p> <p>(1) Select a remote sensor using the ▲/▼ button. FRONT ⇔ REAR ⇔ HDBaseT</p>  <p>(2) Switch it using the ◀/▶ button. ON ⇔ OFF</p>  <ul style="list-style-type: none"> <li>• When one sensor is turned off, the other cannot be turned off too.</li> </ul>
	<p><b>REMOTE FREQ.</b></p> <p>(1) Use the ▲/▼ button to change the projector's remote sensor frequency setting (4, 29). 1:NORMAL ⇔ 2:HIGH</p>  <p>(2) Use the ◀/▶ button to change the projector's remote sensor on or off. ON ⇔ OFF</p> <p>If the remote control does not function correctly, disable either of them.</p> <ul style="list-style-type: none"> <li>• It's not possible to disable both options at the same time.</li> </ul>
	<p><b>REMOTE ID</b></p> <p>Use the ▲/▼ buttons on the REMOTE ID menu to select ID and press the ▶ button. ALL ⇔ 1 ⇔ 2 ⇔ 3 ⇔ 4</p>  <p>The projector is controlled by the remote control whose <b>ID</b> button is set the same number as this number. When the ALL is selected, the projector is controlled by a remote control irrespective of the ID setting.</p>

(continued on next page)

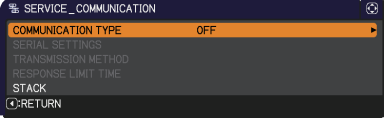
Item	Description
<p><b>SERVICE</b> (continued)</p>	<div style="display: flex; justify-content: space-between;"> <div style="width: 15%; text-align: center; vertical-align: middle;"> <p><b>COMMUNICATION</b></p> </div> <div style="width: 85%;"> <p>Selecting this item displays COMMUNICATION menu. In this menu, you can configure the serial communication settings of the projector using the <b>CONTROL</b> port.</p>  <ul style="list-style-type: none"> <li>• Select an item using the cursor buttons ▲/▼. Then pressing the ► button opens the submenu for the setting item you selected. Or, pressing the ◀ button instead of the ► button makes the menu back to the previous one without changing the setup. Each submenu can be operated as described above.</li> <li>• When COMMUNICATION TYPE (📄<i>below</i>) is set to OFF, the other items except STACK in COMMUNICATION menu are invalid.</li> <li>• For the function of serial communication, refer to the <b>Network Guide</b>.</li> </ul> <p><b>COMMUNICATION TYPE</b></p> <p>Select the communication type for transmission via the <b>CONTROL</b> port.</p> <div style="margin-left: 40px;"> <p>NETWORK BRIDGE (WIRELESS) ⇕</p> <p>NETWORK BRIDGE (WIRED) ⇕</p> <p>OFF ←</p> </div> <p><u>NETWORK BRIDGE</u>: Select this type, if it is required to control an external device as a network terminal, via this projector from the computer. Select WIRELESS or WIRED as your network connection mode. The <b>CONTROL</b> port does not accept RS-232C commands (📄<b>7. Network Bridge Function</b> in the <b>Network Guide</b>).</p> <p><u>OFF</u>: Select this mode to receive RS-232C commands using the <b>CONTROL</b> port.</p> <ul style="list-style-type: none"> <li>• OFF is selected as the default setting.</li> <li>• When you select the NETWORK BRIDGE, check the item, TRANSMISSION METHOD (📄<b>97</b>).</li> </ul> </div> </div>

(continued on next page)





Item	Description	
SERVICE (continued)	COMMUNICATION (continued)	<p><b>SERIAL SETTINGS</b> Select the serial communication condition for the <b>CONTROL</b> port.</p> <p><b>BAUD RATE</b> 4800bps ⇔ 9600bps ⇔ 19200bps ⇔ 38400bps ↑—————↑</p> <p><b>PARITY</b> NONE ⇔ ODD ⇔ EVEN ↑—————↑</p> <ul style="list-style-type: none"> <li>• The BAUD RATE is fixed to 19200bps and PARITY is fixed NONE when the COMMUNICATION TYPE is set to OFF (☐96).</li> </ul>
		<p><b>TRANSMISSION METHOD</b> Select the transmission method for communication by the NETWORK BRIDGE from the <b>CONTROL</b> port.</p> <p>HALF-DUPLEX ⇔ FULL-DUPLEX</p> <p><u>HALF-DUPLEX</u>: This method lets the projector make two way communication, but only one direction, either transmitting or receiving data, is allowed at a time.</p> <p><u>FULL-DUPLEX</u>: This method lets the projector make two way communication, transmitting and receiving data at the same time.</p> <ul style="list-style-type: none"> <li>• HALF-DUPLEX is selected as the default setting.</li> <li>• If you select HALF-DUPLEX, check the setting of the item RESPONSE LIMIT TIME (☐98).</li> </ul>

(continued on next page)

Item	Description	
<p><b>SERVICE</b> (continued)</p>	<p><b>COMMUNICATION</b> (continued)</p>	<p><b>RESPONSE LIMIT TIME</b> Select the time period to wait for receiving response data from other device communicating by the NETWORK BRIDGE and the HALF-DUPLEX through the <b>CONTROL</b> port.</p> <p>OFF ⇔ 1s ⇔ 2s ⇔ 3s  </p> <p><u>OFF</u>: Select this mode if it is not required to check the responses from the device that the projector sends data to. In this mode, the projector can send out data from the computer continuously.</p> <p><u>1s /2s /3s</u>: Select the time period to keep the projector waiting for response from the device that the projector sends data to. While waiting the response, the projector does not send out any data from the <b>CONTROL</b> port.</p> <ul style="list-style-type: none"> <li>• This menu is available only when the NETWORK BRIDGE is selected for the COMMUNICATION TYPE and the HALF-DUPLEX is selected for the TRANSMISSION METHOD (p.97).</li> <li>• OFF is selected as the default setting.</li> </ul>
		<p><b>STACK</b> Selecting this item displays the STACK menu. For more information, please see <b>Instant Stack Guide</b>.</p> <ul style="list-style-type: none"> <li>• When STACK MODE is set to MAIN or SUB, the other items in COMMUNICATION menu are invalid.</li> </ul>

(continued on next page)

Item	Description
<b>SERVICE</b> (continued)	<p><b>INFORMATION</b></p> <p>Selecting this item displays a dialog titled “INPUT_INFORMATION”. It shows the information about the current input.</p> <div style="display: flex; justify-content: space-around; align-items: center;">    </div> <ul style="list-style-type: none"> <li>• The “FRAME LOCK” message on the dialog means the frame lock function is working.</li> <li>• This item can't be selected for no signal and sync out.</li> <li>• When the MY TEXT DISPLAY is set to ON, the MY TEXT is displayed together with the input information in the INPUT_INFORMATION box (106).</li> </ul>
	<p><b>FACTORY RESET</b></p> <p>Selecting OK using the ► button performs this function. By this function, all the items in all of menus will collectively return to the initial setting. Note that the items LAMP TIME, FILTER TIME, LANGUAGE, AUTO BLANK, FILTER MESSAGE, STANDBY MODE, COMMUNICATION, NETWORK and SECURITY settings are not reset.</p> <p>CANCEL ⇔ OK</p>

## **NETWORK menu**

See the **Network Guide** for details of NETWORK operation.

Remember that incorrect network settings on this projector may cause trouble on the network. Be sure to consult with your network administrator before connecting to an existing access point on your network.

## SECURITY menu

This projector is equipped with security functions. From the SECURITY menu, items shown in the table below can be performed.

To use SECURITY menu: User registration is required before using the security functions.

### Enter to the SECURITY menu

1. Press the ► button. The ENTER PASSWORD box will be displayed.
2. Use the ▲/▼/◀/▶ buttons to enter the registered password. The factory default password is as follows.

CP-WU8600/CP-WU8700 : 4910 CP-WX8650/CP-WX8750 : 3210  
 CP-X8800 : 4810

This password can be changed (see below). Move the cursor to the right side of the ENTER PASSWORD box and press the ► button to display the SECURITY menu.

- It is strongly recommended the factory default password to be changed as soon as possible.
  - If an incorrect password is input, the ENTER PASSWORD box will be displayed again. If incorrect password is input 3 times, the projector will turn off. Afterwards the projector will turn off every time an incorrect password is input.
3. Items shown in the table below can be performed.

### If you have forgotten your password

(1) While the ENTER PASSWORD box is displayed, press and hold the **RESET** button on the remote control for about 3 seconds or press and hold the **INPUT** button for 3 seconds while pressing the ► button on the projector.



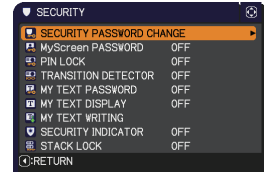
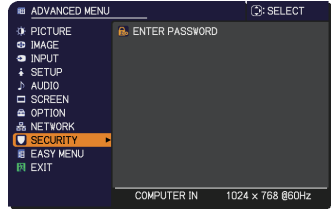

(2) The 10 digit Inquiring Code will be displayed. Contact your dealer with the 10 digit Inquiring Code. Your password will be sent after your user registration information is confirmed.

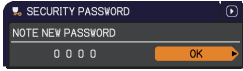
• If there is no key input for about 55 seconds while the Inquiring Code is displayed, the menu will close. If necessary, repeat the process from (1).

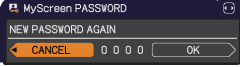
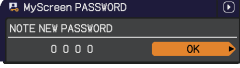

Item	Description
<p><b>SECURITY PASSWORD CHANGE</b></p>	<ol style="list-style-type: none"> <li>(1) Use the ▲/▼ buttons on the SECURITY menu to select SECURITY PASSWORD CHANGE and press the ► button to display the ENTER NEW PASSWORD box.                              </li> <li>(2) Use the ▲/▼/◀/▶ buttons to enter the new password.</li> <li>(3) Move the cursor to the right side of the ENTER NEW PASSWORD box and press the ► button to display the NEW PASSWORD AGAIN box, enter the same password again.                              </li> <li>(4) Move the cursor to the right side of the NEW PASSWORD AGAIN box and press the ► button and the NOTE NEW PASSWORD box will be displayed for about 30 seconds, please make note of the password during this time. Pressing the <b>ENTER</b> button on the remote control or ► button on the projector will close the NOTE NEW PASSWORD box.                              <ul style="list-style-type: none"> <li>• Please do not forget your password.</li> </ul> </li> </ol>

(continued on next page)

Item	Description
<p><b>MyScreen PASSWORD</b></p>	<p>The MyScreen PASSWORD function can be used to prohibit access to the MyScreen function and prevent the currently registered MyScreen image from being overwritten.</p> <p><b>1 Turning on the MyScreen PASSWORD</b></p> <p>1-1 Use the ▲/▼ buttons on the SECURITY menu to select MyScreen PASSWORD and press the ► button to display the MyScreen PASSWORD on/off menu.</p>  <p>1-2 Use the ▲/▼ buttons on the MyScreen PASSWORD on/off menu to select ON. The ENTER NEW PASSWORD box (small) will be displayed.</p>  <p>1-3 Use the ▲/▼/◀/▶ buttons to enter the password. Move the cursor to the right side of the ENTER NEW PASSWORD box (small) and press the ► button to display the NEW PASSWORD AGAIN box, enter the same PASSWORD again.</p>  <p>1-4 Move the cursor to the right side of the NEW PASSWORD AGAIN box and press the ► button to display the NOTE NEW PASSWORD box for about 30 seconds, please make note of the password during this time.</p>  <p>Pressing the <b>ENTER</b> button on the remote control or ► button on the projector will return to MyScreen PASSWORD on/off menu.</p> <p>When a password is set for MyScreen:</p> <ul style="list-style-type: none"> <li>• The MyScreen registration function (and menu) will be unavailable.</li> <li>• The MyScreen Lock menu will be unavailable.</li> <li>• The START UP setting will be locked on MyScreen (and the menu will be unavailable).</li> </ul> <p>Turning the MyScreen PASSWORD off will allow normal operation of these functions.</p> <ul style="list-style-type: none"> <li>• Please do not forget your MyScreen PASSWORD.</li> </ul> <p><b>2 Turning off the MyScreen PASSWORD</b></p> <p>2-1 Follow the procedure in 1-1 to display the MyScreen PASSWORD on/off menu.</p> <p>2-2 Select OFF to display the ENTER PASSWORD box (large). Enter the registered password and the screen will return to the MyScreen PASSWORD on/off menu.</p>  <p>If an incorrect PASSWORD is input, the menu will close. If necessary, repeat the process from 2-1.</p> <p><b>3 If you have forgotten your password</b></p> <p>3-1 Follow the procedure in 1-1 to display the MyScreen PASSWORD on/off menu.</p> <p>3-2 Select OFF to display the ENTER PASSWORD box (large). The 10 digit Inquiring Code will be displayed inside the box.</p> <p>3-3 Contact your dealer with the 10 digit Inquiring Code. Your password will be sent after your user registration information is confirmed.</p>

(continued on next page)

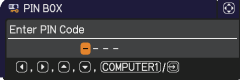
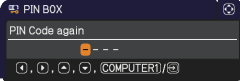
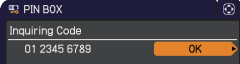

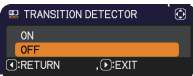
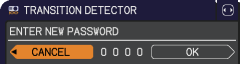
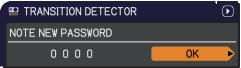
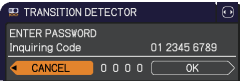

Item	Description
<b>PIN LOCK</b>	<p>PIN LOCK is a function which prevents the projector from being used unless a registered Code is input.</p> <p><b>1 Turning on the PIN LOCK</b></p> <p>1-1 Use the ▲/▼ buttons on the SECURITY menu to select PIN LOCK and press the ► button or the ENTER button to display the PIN LOCK on/off menu.</p>  <p>1-2 Use the ▲/▼ buttons on the PIN LOCK on/off menu to select ON and the Enter PIN Code box will be displayed.</p>  <p>1-3 Input a 4 part PIN code using the ▲/▼/◀/▶, COMPUTER 1 or INPUT button. The PIN Code again box will appear. Reenter the same PIN code. This will complete the PIN code registration.</p>  <ul style="list-style-type: none"> <li>• If there is no key input for about 55 seconds while the Enter PIN Code box or the PIN Code again box is displayed, the menu will close. If necessary, repeat the process from 1-1.</li> </ul> <p>Afterwards, anytime the projector is restarted after AC power is turned off the Enter PIN Code box will be displayed. Enter the registered PIN code. The projector can be used after entering the registered PIN code. If an incorrect PIN code is input, the Enter PIN code box will be displayed again. If an incorrect PIN code is input 3 times, the projector will turn off. Afterwards the projector will turn off every time an incorrect PIN code is input. The projector will also turn off if there is no key input for about 5 minutes while the Enter PIN code box is displayed.</p> <p>This function will activate only when the projector is started after AC power is turned off.</p> <ul style="list-style-type: none"> <li>• Please do not forget your PIN code.</li> </ul> <p><b>2 Turning off the PIN LOCK</b></p> <p>2-1 Follow the procedure in 1-1 to display the PIN LOCK on/off menu.</p> <p>2-2 Use the ▲/▼ buttons to select OFF and the Enter PIN Code box will be displayed.</p> <p>Enter the registered PIN code to turn the PIN LOCK function off.</p> <p>If an incorrect PIN code is input 3 times, the projector will turn off.</p> <p><b>3 If you have forgotten your PIN code</b></p> <p>3-1 While the Enter PIN Code box is displayed, press and hold the RESET button for three seconds or press and hold the INPUT button for 3 seconds while pressing the ► button on the projector. The 10 digit Inquiring Code will be displayed.</p> <ul style="list-style-type: none"> <li>• If there is no key input for about 5 minutes while the Inquiring Code is displayed, the projector will turn off.</li> </ul>  <p>3-2 Contact your dealer with the 10 digit Inquiring Code. Your PIN code will be sent after your user registration information is confirmed.</p>

(continued on next page)

Item	Description
<p><b>TRANSITION DETECTOR</b></p>	<p>If this function is set to ON and the vertical angle of the projector or the INSTALLATION setting is different from the previous recorded setting, the TRANSITION DETECTOR ON alarm will be displayed and the input signal will not be displayed.</p> <ul style="list-style-type: none"> <li>• To display the signal again, set this function OFF.</li> <li>• After about 5 minutes of displaying the TRANSITION DETECTOR ON alarm, the lamp will turn off.</li> </ul> <p><b>1 Turning on the TRANSITION DETECTOR</b></p> <p>1-1 Use the ▲/▼ buttons on the SECURITY menu to select TRANSITION DETECTOR and press the ► or the ENTER button to display the TRANSITION DETECTOR on/off menu.</p>  <p>1-2 Use the ▲/▼ buttons on the TRANSITION DETECTOR on/off menu to select ON. Selecting ON will save the setting of the current angle and the INSTALLATION setting. The ENTER NEW PASSWORD box (small) will be displayed.</p>  <p>1-3 Use the ▲/▼/◀/▶ buttons to enter a password. Move the cursor to the right side of the ENTER NEW PASSWORD box (small) and press the ► button to display the NEW PASSWORD AGAIN box, enter the same password again.</p>  <p>1-4 Move the cursor to the right side of the NEW PASSWORD AGAIN box and press the ► button to display the NOTE NEW PASSWORD box for about 30 seconds, please make note of the password during this time. Pressing the ENTER button on the remote control or the ► button on the projector will return to the TRANSITION DETECTOR on/off menu.</p>  <ul style="list-style-type: none"> <li>• Please do not forget your TRANSITION DETECTOR password.</li> <li>• This function will activate only when the projector is started after turning off the AC power.</li> <li>• This feature may not function properly if the projector is not in a stable position when ON is selected.</li> </ul> <p><b>2 Turning off the TRANSITION DETECTOR</b></p> <p>2-1 Follow the procedure in 1-1 to display the TRANSITION DETECTOR on/off menu.</p> <p>2-2 Select OFF to display the ENTER PASSWORD box (large). Enter the registered password and the screen will return to the TRANSITION DETECTOR on/off menu.</p>  <p>If an incorrect password is input, the menu will close. If necessary, repeat the process from 2-1.</p> <p><b>3 If you have forgotten your password</b></p> <p>3-1 Follow the procedure in 1-1 to display the TRANSITION DETECTOR on/off menu.</p> <p>3-2 Select OFF to display the ENTER PASSWORD box (large). The 10 digit Inquiring Code will be displayed inside the box.</p> <p>3-3 Contact your dealer with the 10 digit Inquiring Code. Your password will be sent after your user registration information is confirmed.</p>

(continued on next page)

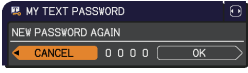
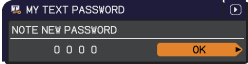

Item	Description
<b>MY TEXT PASSWORD</b>	<p>The MY TEXT PASSWORD function can prevent the MY TEXT from being overwritten. When the password is set for the MY TEXT;</p> <ul style="list-style-type: none"> <li>• The MY TEXT DISPLAY menu will be unavailable, which can prohibit changing the DISPLAY setting.</li> <li>• The MY TEXT WRITING menu will be unavailable, which can prevent the MY TEXT from being overwritten.</li> </ul> <p><b>1 Turning on the MY TEXT PASSWORD</b></p> <p>1-1 Use the ▲/▼ buttons on the SECURITY menu to select the MY TEXT PASSWORD and press the ► button to display the MY TEXT PASSWORD on/off menu.</p>  <p>1-2 Use the ▲/▼ buttons on the MY TEXT PASSWORD on/off menu to select ON. The ENTER NEW PASSWORD box (small) will be displayed.</p>  <p>1-3 Use the ▲/▼/◀/▶ buttons to enter the password. Move the cursor to the right side of the ENTER NEW PASSWORD box (small) and press the ► button to display the NEW PASSWORD AGAIN box, and then enter the same password again.</p>  <p>1-4 Move the cursor to the right side of the NEW PASSWORD AGAIN box and press ► button to display the NOTE NEW PASSWORD box for about 30 seconds, then please make note of the password during this time.</p>  <p>Pressing the <b>ENTER</b> button on the remote control or ► button on the projector will return to the MY TEXT PASSWORD on/off menu.</p> <p><b>2 Turning off the MY TEXT PASSWORD</b></p> <p>2-1 Follow the procedure in 1-1 to display the MY TEXT PASSWORD on/off menu.</p> <p>2-2 Select OFF to display the ENTER PASSWORD box (large). Enter the registered password and the screen will return to the MY TEXT PASSWORD on/off menu.</p>  <p>If an incorrect password is input, the menu will close. If necessary, repeat the process from 2-1</p> <p><b>3 If you have forgotten your password</b></p> <p>3-1 Follow the procedure in 1-1 to display the MY TEXT PASSWORD on/off menu.</p> <p>3-2 Select OFF to display the ENTER PASSWORD box (large). The 10 digit inquiring code will be displayed inside the box.</p> <p>3-3 Contact your dealer with the 10 digit inquiring code. Your password will be sent after your user registration information is confirmed.</p>

(continued on next page)

Item	Description
<p><b>MY TEXT DISPLAY</b></p>	<p>(1) Use the ▲/▼ buttons on the SECURITY menu to select the MY TEXT DISPLAY and press the ► or <b>ENTER</b> button to display the MY TEXT DISPLAY on/off menu.</p> <p>(2) Use the ▲/▼ buttons on the MY TEXT DISPLAY on/off menu to select on or off.</p> <p style="text-align: center;">ON ⇔ OFF</p> <p>When it is set ON, the MY TEXT will be displayed on the START UP screen and the INPUT_INFORMATION when the INFORMATION on the SERVICE menu is chosen.</p> <ul style="list-style-type: none"> <li>• This function is available only when the MY TEXT PASSWORD function is set to the OFF.</li> </ul>
<p><b>MY TEXT WRITING</b></p>	<p>(1) Use the ▲/▼ buttons on the SECURITY menu to select the MY TEXT WRITING and press the ► button. The MY TEXT WRITING dialog will be displayed.</p> <p>(2) The current MY TEXT will be displayed on the first 3 lines. If not yet written, the lines will be blank.</p> <p>Use the ▲/▼/◀/▶ buttons and the <b>ENTER</b> or <b>INPUT</b> button to select and enter characters. To erase 1 character at one time, press the <b>RESET</b> button or press the ◀ and <b>INPUT</b> button at the same time. Also if you move the cursor to DELETE or CLEAR ALL on screen and press the <b>ENTER</b> or <b>INPUT</b> button, 1 character or all characters will be erased. The MY TEXT can be input up to 24 characters on each line.</p> <p>(3) To change an already inserted character, press the ▲/▼ button to move the cursor to one of the first 3 lines, and use the ◀/▶ buttons to move the cursor on the character to be changed.</p> <p>After pressing the <b>ENTER</b> or <b>INPUT</b> button, the character is selected. Then, follow the same procedure as described at the item (2) above.</p> <p>(4) To finish entering text, move the cursor to the OK on screen and press the ►, <b>ENTER</b> or <b>INPUT</b> button. To revert to the previous MY TEXT without saving changes, move the cursor to the CANCEL on screen and press the ◀, <b>ENTER</b> or <b>INPUT</b> button.</p> <ul style="list-style-type: none"> <li>• The MY TEXT WRITING function is available only when the MY TEXT PASSWORD function is set to OFF.</li> </ul>

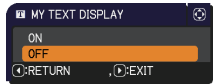

(continued on next page)

Item	Description
<b>SECURITY INDICATOR</b>	Selecting this item displays the SECURITY INDICATOR dialog. Use the ▲/▼ buttons to select ON or OFF. ON ⇔ OFF When ON is selected while PIN LOCK or TRANSITION DETECTOR is ON, the <b>SECURITY</b> indicator blinks in yellow in the standby mode (📖 103, 104).
<b>STACK LOCK</b>	Selecting this item displays the STACK LOCK dialog. For more information, please see <b>Instant Stack Guide</b> .

## Maintenance

## Replacing the lamp

A lamp has finite product life. Using the lamp for long periods of time could cause the pictures darker or the color tone poor. Note that each lamp has a different lifetime, and some may burst or burn out soon after you start using them.

Preparation of a new lamp and early replacement are recommended. To prepare a new lamp, make contact with your dealer and tell the lamp type number.

**Type number : DT01881 <CP-WU8700/CP-WX8750/CP-X8800>**  
**DT01871 <CP-WU8600/CP-WX8650>**

## Replacing the lamp

- 1 Turn the projector off, and unplug the power cord. Allow the projector to cool for at least 45 minutes.
- 2 Prepare a new lamp. If the projector is mounted with specified mounting accessories, or if the lamp has broken, also ask the dealer to replace the lamp.

**In case of replacement by yourself, follow the following procedure.**

- 3 Loosen the screw (marked by arrow) of the lamp cover and then slide down and lift the lamp cover to remove it.
- 4 Loosen the 3 screws (marked by arrow) of the lamp, and slowly pull the lamp out by the handles. Never loosen any other screws.
- 5 Insert the new lamp, and retighten firmly the 3 screws of the lamp that are loosened in the previous process to lock it in place.
- 6 While putting the interlocking parts of the lamp cover and the projector together, slide the lamp cover back in place. Then firmly fasten the screw of the lamp cover.
- 7 Turn the projector on and reset the lamp time using the LAMP TIME item in the SETUP menu.
  - (1) Press the **MENU** button to display a menu.
  - (2) Point at the ADVANCED MENU in the menu using the ▼/▲ button, then press the ► button.
  - (3) Point at the SETUP in the left column of the menu using the ▼/▲ button, then press the ► button.
  - (4) Point at the LAMP TIME using the ▼/▲ button, then press the ► button. A dialog will appear.
  - (5) Press the ► button to select "OK" on the dialog. It performs resetting the lamp time.

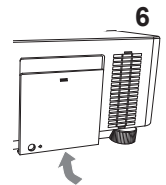
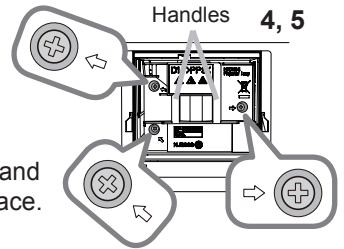
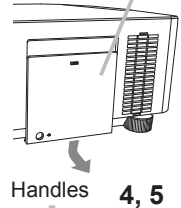
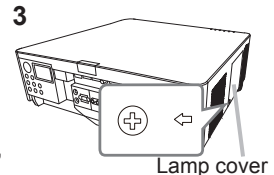

**⚠ CAUTION** ► Do not touch the interior of the projector, while the lamp is taken out.

**NOTE** • Please reset the lamp time only when you have replaced the lamp, for a suitable indication about the lamp.

## Replacing the lamp (continued)

### Lamp warning

 **HIGH VOLTAGE**     **HIGH TEMPERATURE**     **HIGH PRESSURE**

**⚠ WARNING** ► The projector uses a high-pressure mercury glass lamp. The lamp can break with a loud bang, or burn out, if jolted or scratched, handled while hot, or worn over time. Note that each lamp has a different lifetime, and some may burst or burn out soon after you start using them. In addition, if the bulb bursts, it is possible for shards of glass to fly into the lamp housing, and for gas containing mercury and dust containing fine particles of glass to escape from the projector's vent holes.

► **About disposal of a lamp:** This product contains a mercury lamp; do not put it in a trash. Dispose of it in accordance with environmental laws.

- For lamp recycling, go to [www.lamprecycle.org](http://www.lamprecycle.org) (in the US).
- For product disposal, consult your local government agency or [www.eiae.org](http://www.eiae.org) (in the US) or [www.epsc.ca](http://www.epsc.ca) (in Canada).

For more information, call your dealer.



Disconnect  
the plug  
from the  
power  
outlet

- If the lamp should break (it will make a loud bang when it does), unplug the power cord from the outlet, and make sure to request a replacement lamp from your local dealer. Note that shards of glass could damage the projector's internals, or cause injury during handling, so please do not try to clean the projector or replace the lamp yourself.
- If the lamp should break (it will make a loud bang when it does), ventilate the room well, and make sure not to inhale the gas or fine particles that come out from the projector's vent holes, and not to get them into your eyes or mouth.
- Before replacing the lamp, turn the projector off and unplug the power cord, then wait at least 45 minutes for the lamp to cool sufficiently. Handling the lamp while hot can cause burns, as well as damaging the lamp.



- Never unscrew except the appointed (marked by an arrow) screws.
- Do not open the lamp cover while the projector is suspended from a ceiling. This is dangerous, since if the lamp's bulb has broken, the shards will fall out when the cover is opened. In addition, working in high places is dangerous, so ask your local dealer to have the lamp replaced even if the bulb is not broken.
- Do not use the projector with the lamp cover removed. At the lamp replacing, make sure that the screws are screwed in firmly. Loose screws could result in damage or injury.



- Use only the lamp of the specified type. Use of a lamp that does not meet the lamp specifications for this model could cause a fire, damage or shorten the life of this product.
- If the lamp breaks soon after the first time it is used, it is possible that there are electrical problems elsewhere besides the lamp. If this happens, consult your local dealer or a service representative.
- Handle with care: jolting or scratching could cause the lamp bulb to burst during use.
- Using the lamp for long periods of time, could cause it dark, not to light up or to burst. When the pictures appear dark, or when the color tone is poor, please replace the lamp as soon as possible. Do not use old (used) lamps; this is a cause of breakage.

## Cleaning and replacing the air filter

Please check and clean the air filter periodically. When the indicators or a message prompts you to clean the air filter, comply with it as soon as possible.

The filter unit with 2 sheets of filters is inside of the filter cover. In addition, the extra air filter is attached to inner side of the filter cover. If one of the filters is damaged or heavily soiled, replace whole filter set with a new one.

Request for a filter set with the following type number from your dealer when purchasing a new one.

**Type number : UX40821**

1. Turn the projector off, and unplug the power cord. Allow the projector to sufficiently cool down.
2. Use a vacuum cleaner on and around the filter cover.
3. Pick and pull up the filter cover knobs to take it off.
4. Press up slightly the bottom side knobs to unlock the bottom side of the filter unit. Pull the center knob to take the filter unit off.
5. Use a vacuum cleaner for the filter vent of the projector and the outer side of the filter unit.
6. The filter unit consists of two parts. Press down around the interlocking parts to unlock, then separate the two parts.
7. Use a vacuum cleaner for the inner side of each part of the filter unit to clean them up. If the filters are damaged or heavily soiled, replace them with the new ones.
8. Combine the two parts to reassemble the filter unit.
9. Put the filter unit back into the projector.

(continued on next page)

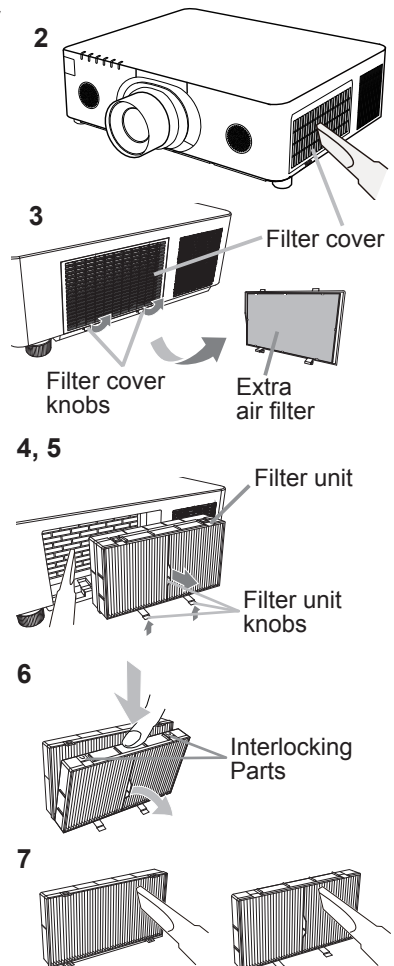

**Cleaning and replacing the air filter (continued)**

10. Put the filter cover back into the place.
11. Turn the projector on and reset the filter time using the FILTER TIME item in the EASY MENU.
  - (1) Press the **MENU** button to display a menu.
  - (2) Point at the FILTER TIME using the ▲/▼ cursor buttons, then press the ► cursor (or the **ENTER** / the **RESET**) button. A dialog will appear.
  - (3) Press the ► cursor button to select the “OK” on the dialog. It performs resetting the filter time.

**⚠ WARNING** ► Before taking care of the air filter, make sure the power cable is not plugged in, then allow the projector to cool sufficiently.

► Use only the air filter of the specified type. Do not use the projector without the air filter or the filter cover. It could result in a fire or malfunction to the projector.

► Clean the air filter periodically. If the air filter becomes clogged by dust or the like, internal temperatures rise and could cause a fire, a burn or malfunction to the projector.

**NOTE** • Please reset the filter time only when you have cleaned or replaced the air filter, for a suitable indication about the air filter.

• The projector may display the message such as the “CHECK THE AIR FLOW” or turn off the projector, to prevent the internal heat level rising.

## Replacing the internal clock battery

Please replace a battery according to the following procedure.

1. Turn the projector off, and unplug the power cord. Allow the projector to cool sufficiently.
2. After making sure that the projector has cooled adequately, slowly turn over the projector, so that the bottom is facing.
3. Turn the battery cover fully in the direction indicated “OPEN” using a coin or the like, and pick the cover up to remove it.
4. Pry up the battery using a flathead screwdriver or the like to take it out. While prying it up, put a finger lightly on the battery since it may pop out of the holder.
5. Replace the battery with a new **HITACHI MAXELL**, Part No.**CR2032** or **CR2032H**. Slide the battery in under the plastic claw, and push it into the holder until it clicks.
6. Replace the battery cover in place, then turn it in the direction indicated “CLOSE” using such as coins, to fix.

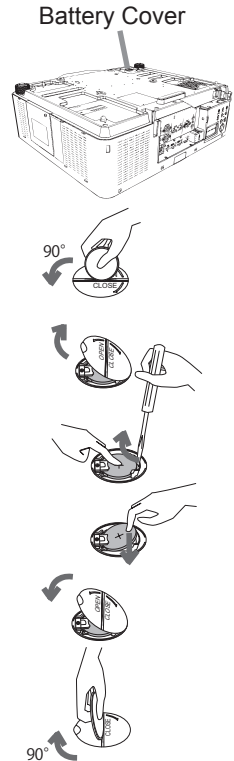

**⚠ WARNING** ▶ Always handle the batteries with care and use them only as directed. Battery may explode if mistreated. Do not recharge, disassemble or dispose of in fire.

And also improper use may result in cracking or leakage, which could result in fire, injury and/or pollution of the surrounding environment.

- Be sure to use only the batteries specified.
- Make sure the plus and minus terminals are correctly aligned when loading a battery.
- Keep a battery away from children and pets. If swallowed consult a physician immediately for emergency treatment.
- Do not short circuit or solder a battery.
- Do not allow a battery in a fire or water. Keep batteries in a dark, cool and dry place.
- If you observe battery leakage, wipe out the leakage and then replace a battery. If the leakage adheres to your body or clothes, rinse well with water immediately.
- Obey the local laws on disposing a battery.



## Other care

### Inside of the projector

In order to ensure the safe use of your projector, please have it cleaned and inspected by your dealer about once every year.

### Caring for the lens

If the lens is flawed, soiled or fogged, it could cause deterioration of display quality. Please take care of the lens, being cautious of handling.

1. Turn the projector off, and unplug the power cord. Allow the projector to cool sufficiently.
2. After making sure that the projector is cool adequately, lightly wipe the lens with a commercially available lens-cleaning wipe. Do not touch the lens directly with your hand.

### Caring for the cabinet and remote control

Incorrect care could have adverse influence such as discoloration, peeling paint, etc.

1. Turn the projector off, and unplug the power cord. Allow the projector to cool sufficiently.
2. After making sure that the projector is cool adequately, lightly wipe with gauze or a soft cloth.  
If the projector is extremely dirty, dip soft cloth in water or a neutral cleaner diluted in water, and wipe lightly after wringing well. Then, wipe lightly with a soft, dry cloth.

**⚠ WARNING** ▶ Before caring, make sure the power cord is not plugged in, and then allow the projector to cool sufficiently. The care in a high temperature state of the projector could cause a burn and/or malfunction to the projector.

▶ Never try to care for the inside of the projector personally. Doing is so dangerous.

▶ Avoid wetting the projector or inserting liquids in the projector. It could result in a fire, an electric shock, and/or malfunction to the projector.

- Do not put anything containing water, cleaners or chemicals near the projector.
- Do not use aerosols or sprays.

**⚠ CAUTION** ▶ Please take right care of the projector according to the following. Incorrect care could cause not only an injury but adverse influence such as discoloration, peeling paint, etc.

▶ Do not use cleaners or chemicals other than those specified in this manual.

▶ Do not polish or wipe with hard objects.

**NOTICE** ▶ Do not directly touch the lens surface with hands.

## Troubleshooting

If an abnormal operation should occur, stop using the projector immediately.

**⚠ WARNING** ▶ Never use the projector if abnormal operations such as smoke, strange odor, excessive sound, damaged casing or elements or cables, penetration of liquids or foreign matter, etc. should occur. In such cases, immediately disconnect the power plug from the power outlet. After making sure that the smoke or odor has stopped, contact to your dealer or service company.

Otherwise if a problem occurs with the projector, the following checks and measures are recommended before requesting repair.

If this does not resolve the problem, please contact your dealer or service company. They will tell you what warranty condition is applied.

### Warnings displayed on the Status Monitor

If an error occurs, a warning will be displayed on the Status Monitor (📖31).

Resolve the errors referring to the table of the sections "Related messages" and "Regarding the indicator lamps" when the warning is displayed.

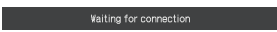
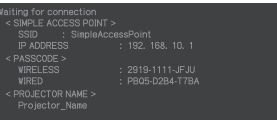

### Related messages

When some message appears, check and cope with it according to the following table. Although these messages will be automatically disappeared around several minutes, it will be reappeared every time the power is turned on.

Message	Description
	<p><b>There is no input signal.</b> Please confirm the signal input connection, and the status of the signal source.</p>
	<p><b>Projector is waiting for an image file.</b> Check the hardware connection, settings on the projector and network-related settings. The computer-Projector network connection might be disconnected. Please re-connect them.</p>
	



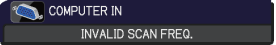

(continued on next page)

**Related messages (continued)**

Message	Description
	<p><b>The horizontal or vertical frequency of the input signal is not within the specified range.</b> Please confirm the specs for your projector or the signal source specs.</p>
	<p><b>An improper signal is input.</b> Please confirm the specs for your projector or the signal source specs.</p>
	<p><b>The internal temperature is rising.</b> Please turn the power off, and allow the projector to cool down at least 20 minutes. After having confirmed the following items, please turn the power ON again.</p> <ul style="list-style-type: none"> <li>• Is there blockage of the air passage aperture?</li> <li>• Is the air filter dirty?</li> <li>• Please use the unit within the usage temperature parameters (0°C to 40°C or 45°C (<a href="#">User's Manual (concise)</a>)).</li> <li>• Is the setting for ALTITUDE appropriate?</li> <li>• Is the exhaust air (hot/cold) from peripheral equipments blowing against the ventilation opening of projector?</li> </ul> <p>For details of ALTITUDE, refer to ALTITUDE of SERVICE in the OPTION menu (<a href="#">93</a>). If the projector is used with a wrong setting, it may cause damage to the projector itself or the parts inside.</p>

(continued on next page)



**Related messages (continued)**

Message	Description
	<p><b>A note of precaution when cleaning the air filter.</b> Please immediately turn the power off, and clean or change the air filter referring to the <b>Cleaning and replacing the air filter</b> section of this manual. After you have cleaned or changed the air filter, please be sure to reset the filter timer ( <b>76, 110</b>).</p>
	<p><b>The button operation is not available.</b> Check the button you are going to use ( <b>7</b>).</p>

## Regarding the indicator lamps

The indicators may differ from usual, check and cope with it according to the following table.

The indicators are described as below.

		
Lit Steady light	Blinking	Off

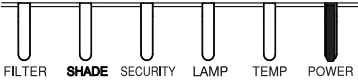
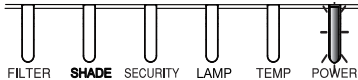
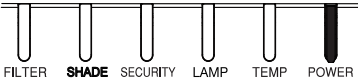
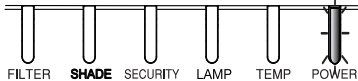
Indicator Status	Description
<p style="text-align: center;"><b>Orange</b></p>  <p style="text-align: center;">FILTER   SHADE   SECURITY   LAMP   TEMP   POWER</p>	<p><b>The projector is in a standby state.</b> Please refer to the section "Power on/off".</p>
<p style="text-align: center;"><b>Green</b></p>  <p style="text-align: center;">FILTER   SHADE   SECURITY   LAMP   TEMP   POWER</p>	<p><b>The projector is warming up.</b> Please wait.</p>
<p style="text-align: center;"><b>Green</b></p>  <p style="text-align: center;">FILTER   SHADE   SECURITY   LAMP   TEMP   POWER</p>	<p><b>The projector is in an on state.</b> Ordinary operations may be performed.</p>
<p style="text-align: center;"><b>Orange</b></p>  <p style="text-align: center;">FILTER   SHADE   SECURITY   LAMP   TEMP   POWER</p>	<p><b>The projector is cooling down.</b> Please wait.</p>

(continued on next page)

Regarding the indicator lamps (continued)

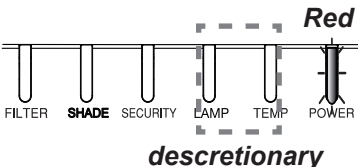
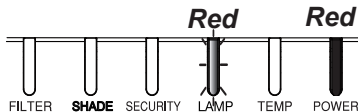
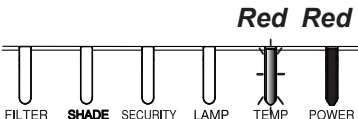
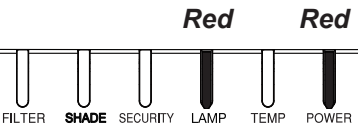
Indicator Status	Description
 <p style="text-align: center;"><i>descretionary</i></p>	<p><b>The projector is cooling down. A certain error has been detected.</b> Please wait until <b>POWER</b> indicator finishes blinking, and then perform the proper measure using the item descriptions below.</p>
	<p><b>The lamp cover has not been properly fixed.</b> Please turn the power off, and allow the projector to cool down at least 45 minutes. After the projector has sufficiently cooled down, please make confirmation of the attachment state of the lamp cover. After performing any needed maintenance, turn the power on again. If the same indication is displayed after the remedy, please contact your dealer or service company.</p>
	<p><b>The cooling fan is not operating.</b> Please turn the power off, and allow the projector to cool down at least 20 minutes. After the projector has sufficiently cooled down, please make confirmation that no foreign matter has become caught in the fan, etc., and then turn the power on again. If the same indication is displayed after the remedy, please contact your dealer or service company.</p>
	<p><b>The lamp does not light, and there is a possibility that interior portion has become heated. Otherwise, AC power supply is unstable (ACBLK).</b> Please turn the power off, and allow the projector to cool down at least 20 minutes. After the projector has sufficiently cooled down, please make confirmation of the following items, and then turn the power on again.</p> <ul style="list-style-type: none"> <li>• Is there blockage of the air passage aperture?</li> <li>• Is the air filter dirty?</li> <li>• Please use the unit within the temperature range. NORMAL MODE: 0 to 40°C ECO MODE: 0 to 45°C</li> </ul> <p>If the same indication is displayed after the remedy, please change the lamp referring to the section <b>Replacing the lamp</b>.</p>

(continued on next page)

## Regarding the indicator lamps (continued)

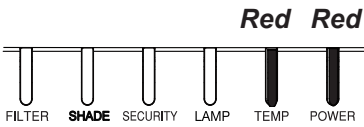
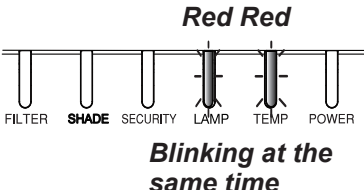
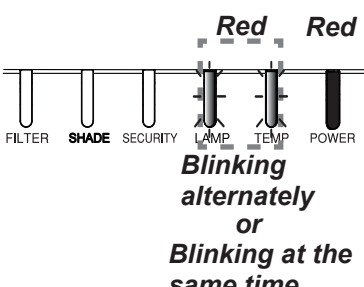
Indicator Status	Description
 <p style="text-align: center;"><b>Red Red</b></p>	<p><b>There is a possibility that the interior portion has become heated.</b></p> <p>Please turn the power off, and allow the projector to cool down at least 20 minutes. After the projector has sufficiently cooled down, please make confirmation of the following items, and then turn the power on again.</p> <ul style="list-style-type: none"> <li>• Is there blockage of the air passage aperture?</li> <li>• Is the air filter dirty?</li> <li>• Please use the unit within the temperature range. NORMAL MODE: 0 to 40°C ECO MODE: 0 to 45°C</li> <li>• Is the setting for ALTITUDE appropriate?</li> <li>• Is the exhaust air (hot/cold) from peripheral equipments blowing against the ventilation opening of projector?</li> </ul> <p>For details on ALTITUDE, refer to ALTITUDE of SERVICE in the OPTION menu. If the projector is used with a wrong setting, it may cause damage to the projector itself or the parts inside.</p>
 <p style="text-align: center;"><b>Red Red</b></p> <p style="text-align: center;"><b>Blinking at the same time</b></p>	<p><b>It is time to clean the air filter.</b></p> <p>Please turn the power off immediately, and clean or change the air filter referring to the section <b>Cleaning and replacing the air filter</b>. After cleaning or changing the air filter, please be sure to reset the filter timer.</p> <p>After the remedy, restart the projector.</p>
 <p style="text-align: center;"><b>Red Red</b></p> <p style="text-align: center;"><b>Blinking alternately or Blinking at the same time</b></p>	<p><b>Other error has occurred.</b></p> <ul style="list-style-type: none"> <li>• Please use the unit within the temperature range. NORMAL MODE: 0 to 40°C ECO MODE: 0 to 45°C</li> </ul> <p>If the same indication is displayed after the remedy, please contact your dealer or service company.</p>

(continued on next page)

Regarding the indicator lamps (continued)

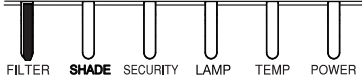
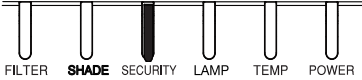
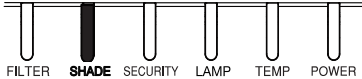
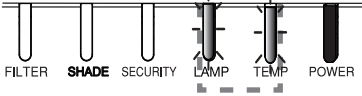
Indicator Status	Description
<p><b>Orange or Red</b></p>  <p>FILTER SHADE SECURITY LAMP TEMP POWER</p>	<p><b>The air filter is clogged or dirty.</b> (📖110) Please check and clean the air filter. Make sure the power cable is not plugged in, then allow the projector to cool sufficiently.</p> <p>In addition, please see the section "There is a possibility that the interior portion has become heated" (📖119).</p>
<p><b>Yellow</b></p>  <p>FILTER SHADE SECURITY LAMP TEMP POWER</p>	<p><b>PIN LOCK function is active.</b> Please see SECURITY menu &gt; PIN LOCK(📖103)</p> <p>If the same indication is displayed after the remedy, please contact your dealer or service company.</p>
<p><b>Yellow</b></p>  <p>FILTER SHADE SECURITY LAMP TEMP POWER</p>	<p><b>The mechanical lens shade is closed.</b> Press the SHADE button on the control panel to open the mechanical lens shade.</p>
<p><b>Red Green</b></p>  <p>FILTER SHADE SECURITY LAMP TEMP POWER</p> <p><b>Blinking alternately</b></p>	<p><b>There is a possibility that the interior portion has become overcooled.</b></p> <ul style="list-style-type: none"> <li>• Please use the unit within the temperature range. NORMAL MODE: 0 to 40°C ECO MODE: 0 to 45°C</li> </ul>

(continued on next page)



**Regarding the indicator lamps (continued)**

**NOTE** • When the interior portion has become overheated, for safety purposes, the projector is automatically shut down, and the indicator lamps may also be turned off. In such a case, disconnect the power cord, and wait at least 45 minutes. After the projector has sufficiently cooled down, please make confirmation of the attachment state of the lamp and lamp cover, and then turn the power on again.

For the **SECURITY** indicator, see SECURITY INDICATOR in the SECURITY menu (📖107).

For the **SHADE** indicator, see the section "Temporarily shading the screen" (📖52).

The **FILTER** indicator shows the condition of the air filter. Utilize this feature to keep the interior of the projector in good condition.

<b>FILTER indicator</b>	<b>Description</b>
Turned <b>off</b>	<b>The air filter is clean.</b> No need to clean up.
Lighting In <b>Orange</b>	<b>The air filter is going to be choked.</b> It is recommended to clean it. In addition, please see the section "There is a possibility that the interior portion has become heated" (📖119).
Lighting In <b>Red</b>	<b>The air filter is choked.</b> It is required to turn the power off and clean the air filter immediately. In addition, please see the section "There is a possibility that the interior portion has become heated" (📖119).

**NOTE** • The **FILTER** indicator might light up in orange or red when something blocks the intake vents even though the air filter is clean.  
• The **FILTER** indicator might light up differently from other indicators or display messages related to cleaning the air filter. Follow the prompt that is displayed earlier.

**Resetting all settings**

When it is hard to correct some wrong settings, the FACTORY RESET function of SERVICE item in OPTION menu (📖99) can reset all settings (except settings such as LANGUAGE, AUTO BLANK, LAMP TIME, FILTER TIME, FILTER MESSAGE, STANDBY MODE, COMMUNICATION, SECURITY and NETWORK) to the factory default.

## Phenomena that may be easy to be mistaken for machine defects

About the phenomenon confused with a machine defect, check and cope with it according to the following table.

Phenomenon	Cases not involving a machine defect	Reference page
Power does not come on.	<b>The electrical power cord is not plugged in.</b> Correctly connect the power cord.	27
	<b>The main power source has been interrupted during operation such as by a power outage (blackout), etc.</b> Please disconnect the power plug from the power outlet, and allow the projector to cool down at least 10 minutes, then turn the power on again.	27
	<b>Either there is no lamp and/or lamp cover, or either of these has not been properly fixed.</b> Please turn the power off and disconnect the power plug from the power outlet, and allow the projector to cool down at least 45 minutes. After the projector has sufficiently cooled down, please make confirmation of the attachment state of the lamp and lamp cover, and then turn the power on again.	108
Neither sounds nor pictures are output.	<b>The signal cables are not correctly connected.</b> Correctly connect the connection cables.	13 ~ 22
	<b>Signal source does not correctly work.</b> Correctly set up the signal source device by referring to the manual of the source device.	—
	<b>The input changeover settings are mismatched.</b> Select the input signal, and correct the settings.	38
	<b>AV MUTE function is working.</b> Press AV MUTE button on the remote control.	37

(continued on next page)

**Phenomena that may be easy to be mistaken for machine defects (continued)**

Phenomenon	Cases not involving a machine defect	Reference page
Sound does not come out.	<p><b>The signal cables are not correctly connected.</b> Correctly connect the audio cables.</p>	13 ~ 22
	<p><b>The volume is adjusted to an extremely low level.</b> Adjust the volume to a higher level using the menu function or the remote control.</p>	37, 80
	<p><b>The AUDIO SOURCE/SPEAKER setting is not correct.</b> Correctly set the AUDIO SOURCE/SPEAKER in AUDIO menu.</p>	80
	<p><b>The Sound button (♪) or checkbox is disabled.</b> If you have selected <b>LAN</b>, remove the check mark from the Sound checkbox in the Option menu of “LiveViewer”.</p>	-
No pictures are displayed.	<p><b>The signal cables are not correctly connected.</b> Correctly connect the connection cables.</p>	13 ~ 22
	<p><b>The brightness is adjusted to an extremely low level.</b> Adjust BRIGHTNESS to a higher level using the menu function.</p>	62
	<p><b>The computer cannot detect the projector as a plug and play monitor.</b> Make sure that the computer can detect a plug and play monitor using another plug and play monitor.</p>	13
	<p><b>The lens shade is closed.</b> Check whether the <b>SHADE</b> indicator is blinking. If it is blinking, press <b>SHADE</b> button on the control panel.</p>	52

(continued on next page)

**Phenomena that may be easy to be mistaken for machine defects (continued)**

Phenomenon	Cases not involving a machine defect	Reference page
The remote control does not work.	<p><b>The batteries in the remote control are near the end.</b> Replace the batteries.</p>	28
	<p><b>The ID numbers set in the projector and the remote control are different.</b> Press the <b>ID</b> button with the same ID number as the projector, then perform the desired operation. The ID number set in the projector can be displayed by pressing any of the <b>ID</b> buttons on the remote control for 3 seconds while the lamp is on.</p>	29
Video screen display freezes.	<p><b>The FREEZE function is working.</b> Press <b>FREEZE</b> button to restore the screen to normal.</p>	52
Colors have a faded-out appearance, or color tone is poor.	<p><b>Color settings are not correctly adjusted.</b> Perform picture adjustments by changing the COLOR TEMP, COLOR and/or TINT settings, using the menu functions.</p>	62, 64
	<p><b>COLOR SPACE setting is not suitable.</b> Change the COLOR SPACE setting to AUTO, RGB, SMPTE240, REC709 or REC601.</p>	69
Pictures appear dark.	<p><b>The brightness and/or contrast are adjusted to an extremely low level.</b> Adjust BRIGHTNESS and/or CONTRAST settings to a higher level using the menu function.</p>	62
	<p><b>The projector is operating in Eco mode.</b> Set ECO MODE in the LAMP &amp; FILTER menu to NORMAL.</p>	75
	<p><b>The lamp is approaching the end of its product lifetime.</b> Replace the lamp.</p>	108
Pictures appear blurry.	<p><b>The lens cover is attached.</b> Remove the lens cover.</p>	-
	<p><b>Either the focus and/or horizontal phase settings are not properly adjusted.</b> Adjust the focus using the <b>FOCUS + / -</b> buttons, and/or H PHASE using the menu function.</p>	41, 68

(continued on next page)

**Phenomena that may be easy to be mistaken for machine defects (continued)**

Phenomenon	Cases not involving a machine defect	Reference page
Pictures appear blurry. (continued)	<p><b>The lens is dirty or misty.</b> Clean the lens referring to the section <b>Caring for the lens.</b></p>	113
Some kind of image degradation such as flickering or stripes appear on screen.	<p><b>When the projector is operating in Eco mode, flickering may appear on screen.</b> Set ECO MODE in the LAMP &amp; FILTER menu to NORMAL.</p>	75
	<p><b>The OVER SCAN ratio is too big.</b> Adjust OVER SCAN in the IMAGE menu smaller.</p>	67
	<p><b>Excessive VIDEO NR.</b> Change the setting of VIDEO NR in the INPUT menu.</p>	69
	<p><b>The FRAME LOCK function cannot work on the current input signal.</b> Set FRAME LOCK in the INPUT menu to OFF.</p>	71
RS-232C does not work.	<p><b>The SAVING function is working.</b> Select NORMAL for STANDBY MODE item in the SETUP menu.</p>	78
	<p><b>The COMMUNICATION TYPE for the CONTROL port is set to NETWORK BRIDGE.</b> Select OFF for COMMUNICATION TYPE item in the OPTION - SERVICE - COMMUNICATION menu.</p>	96
Network does not work.	<p><b>The SAVING function is working.</b> Select NORMAL for STANDBY MODE item in the SETUP menu.</p>	78
	<p><b>The same network address is set for both wireless and wired LAN.</b> Change the network address setting for wireless or wired LAN.</p>	-

(continued on next page)

**Phenomena that may be easy to be mistaken for machine defects (continued)**

Phenomenon	Cases not involving a machine defect	Reference page
The IR and RS-232C does not work on HDBaseT™ connection.	<b>The SAVING function is working.</b> Select NORMAL for STANDBY MODE item in the SETUP menu.	78
HDBaseT connection does not work.	<b>The SAVING function is working.</b> Select NORMAL for STANDBY MODE item in the SETUP menu.	78
	<b>The connected equipment may not be supported by HDBaseT.</b> Refer to User's manual(detailed) for connection.	14
IR and LAN does not work via HDBaseT.	<b>Check if the IR setting is OFF under HDBaseT.</b> EASY MENU > ADVANCED MENU > OPTION > SERVICE > REMOTE RECEIV.	95
	<b>Check if the LAN setting is HDBaseT.</b> EASY MENU > ADVANCED MENU > NETWORK > WIRED NETWORK	–
LAN does not work, if LAN is connected to the projector while having an input signal from HDBaseT.	<b>Check if the LAN setting is HDBaseT.</b> EASY MENU > ADVANCED MENU > NETWORK > WIRED NETWORK	–
	<b>This projector is compatible with 100BASE-T only.</b> Check the specification of the connected equipments.	–
	If the LAN cable is connected with the hub, try to change the connected port at the hub	–
	If the LAN cable is connected directly to the computer, try to connect to other computer	–
No image is displayed via HDBaseT.	Check the LAN cable if it is CAT5e certified or higher.	–
	Try to change the LAN cable.	–
	If the LAN cable is connected with more than 3 extension connector, the transmission of 100 meters may fail.	–
	<b>Check if the extension connector is compatible with CAT5e.</b> All LAN cable and extension connector connected with HDBaseT port must be CAT5e certified.	–

(continued on next page)

**Phenomena that may be easy to be mistaken for machine defects (continued)**

Phenomenon	Cases not involving a machine defect	Reference page
No image is displayed via SDI. (CP-WU8700 only).	Check if it is connected with a cable of 5CFB or greater, or Belden 1694A or greater.	–
	Check if a cable with a length of 100m or less is used.	–
	Try to change the cable.	–
	Check if a supported signal format is input.	–
No image is displayed via DisplayPort.	Check if DisplayPort cables conforming to the DisplayPort standard is used for connection.	–
	When the projector is connected to the computer with an early type of chipset or graphics card that supports the DisplayPort, the projector and/or computer may not operate normally.	–
	The problem may be solved by upgrading the driver of graphic accelerator of the computer to the latest version.	–
	Turn off the projector and the external device, and turn on again.	–
	Check if the supported signal format is input.	–
NETWORK BRIDGE function does not work.	<b>The NETWORK BRIDGE function is turned off.</b> Select NETWORK BRIDGE for COMMUNICATION TYPE item in the OPTION - SERVICE - COMMUNICATION menu.	96
Schedule function does not work.	<b>The SAVING function is working.</b> Select NORMAL for STANDBY MODE item in the SETUP menu.	78
	<b>The internal clock has been reset.</b> Once you turn off the projector in the SAVING mode or the AC power, the current date and time setting is reset. Check the SCHEDULE setting for WIRELESS SETUP or WIRED SETUP in the NETWORK menu.	–

(continued on next page)

**Phenomena that may be easy to be mistaken for machine defects (continued)**

Phenomenon	Cases not involving a machine defect	Reference page
<p>When the projector is connected to the network, it powers off and on as described below.</p> <p>Powers off ←</p> <p>↓</p> <p><b>POWER</b> indicator blinks in orange a few times</p> <p>↓</p> <p>Goes into standby mode</p>	<p><b>Disconnect the LAN cable and check that the projector is working properly.</b></p> <p>If this phenomenon occurs after connecting to the network, there may be a loop between two Ethernet switching hubs within the network, as explained below.</p> <ul style="list-style-type: none"> <li>- There are two or more Ethernet switching hubs in a network.</li> <li>- Two of the hubs are doubly connected by LAN cables.</li> <li>- This double connection forms a loop between the two hubs.</li> </ul> <p>Such a loop may have an adverse effect on the projector as well as the other network devices.</p> <p>Check the network connection and remove the loop by disconnecting the LAN cables such that there is only one connecting cable between two hubs.</p>	<p>–</p>

**NOTE** • Although bright spots or dark spots may appear on the screen, this is a unique characteristic of liquid crystal displays, and it does not constitute or imply a machine defect.



## Specifications

Please see the **Specifications** in the **User's Manual (concise)** which is a book.

### **End User License Agreement for the Projector Software**

- Software in the projector consists of the plural number of independent software modules and there exist our copyright and/or third party copyrights for each of such software modules.
- Be sure to read “End User License Agreement for the Projector Software” which is separated document.