

ViewSonic®



LS810/LS820/LS830 DLP Projector User Guide

IMPORTANT: Please read this User Guide to obtain important information on installing and using your product in a safe manner, as well as registering your product for future service. Warranty information contained in this User Guide will describe your limited coverage from ViewSonic Corporation, which is also found on our web site at <http://www.viewsonic.com> in English, or in specific languages using the Regional selection box in the upper right corner of our website. "Antes de operar su equipo lea cuidadosamente las instrucciones en este manual"

Model No. VS16500/VS16501/VS16460

Compliance Information

FCC Statement

This device complies with part 15 of FCC Rules. Operation is subject to the following two conditions: (1) this device may not cause harmful interference, and (2) this device must accept any interference received, including interference that may cause undesired operation.

This equipment has been tested and found to comply with the limits for a Class B digital device, pursuant to part 15 of the FCC Rules. These limits are designed to provide reasonable protection against harmful interference in a residential installation. This equipment generates, uses, and can radiate radio frequency energy, and if not installed and used in accordance with the instructions, may cause harmful interference to radio communications. However, there is no guarantee that interference will not occur in a particular installation. If this equipment does cause harmful interference to radio or television reception, which can be determined by turning the equipment off and on, the user is encouraged to try to correct the interference by one or more of the following measures:

- Reorient or relocate the receiving antenna.
- Increase the separation between the equipment and receiver.
- Connect the equipment into an outlet on a circuit different from that to which the receiver is connected.
- Consult the dealer or an experienced radio/TV technician for help.

Warning: You are cautioned that changes or modifications not expressly approved by the party responsible for compliance could void your authority to operate the equipment.

For Canada

CAN ICES-3 (B)/NMB-3(B)

CE Conformity for European Countries

 The device complies with the EMC Directive 2014/30/EU and Low Voltage Directive 2014/35/EU.

Following information is only for EU-member states:

The mark is in compliance with the Waste Electrical and Electronic Equipment Directive 2012/19/EU (WEEE).

The mark indicates the requirement NOT to dispose the equipment including any spent or discarded batteries or accumulators as unsorted municipal waste, but use the return and collection systems available.

If the batteries, accumulators and button cells included with this equipment, display the chemical symbol Hg, Cd, or Pb, then it means that the battery has a heavy metal content of more than 0.0005% Mercury or more than, 0.002% Cadmium, or more than 0.004% Lead.



Important Safety Instructions

1. Read these instructions.
2. Keep these instructions.
3. Heed all warnings.
4. Follow all instructions.
5. Do not use this unit near water.
6. Clean with a soft, dry cloth.
7. Do not block any ventilation openings. Install the unit in accordance with the manufacturer's instructions.
8. Do not install near any heat sources such as radiators, heat registers, stoves, or other devices (including amplifiers) that produce heat.
9. Do not defeat the safety purpose of the polarized or grounding-type plug. A polarized plug has two blades with one wider than the other. A grounding type plug has two blades and a third grounding prong. The wide blade and the third prong are provided for your safety. If the provided plug does not fit into your outlet, consult an electrician for replacement of the obsolete outlet.
10. Protect the power cord from being walked on or pinched particularly at plugs. Convenience receptacles and the point where they exit from the unit. Be sure that the power outlet is located near the unit so that it is easily accessible.
11. Only use attachments/accessories specified by the manufacturer.
12. Use only with the cart, stand, tripod, bracket, or table specified by the manufacturer, or sold with the unit. When a cart is used, use caution when moving the cart/unit combination to avoid injury from tipping over.
13. Unplug this unit when unused for long periods of time.
14. Refer all servicing to qualified service personnel. Servicing is required when the unit has been damaged in any way, such as: if the power-supply cord or plug is damaged, if liquid is spilled onto or objects fall into the unit, if the unit is exposed to rain or moisture, or if the unit does not operate normally or has been dropped.



Declaration of RoHS2 Compliance

This product has been designed and manufactured in compliance with Directive 2011/65/EU of the European Parliament and the Council on restriction of the use of certain hazardous substances in electrical and electronic equipment (RoHS2 Directive) and is deemed to comply with the maximum concentration values issued by the European Technical Adaptation Committee (TAC) as shown below:

Substance	Proposed Maximum Concentration	Actual Concentration
Lead (Pb)	0.1%	< 0.1%
Mercury (Hg)	0.1%	< 0.1%
Cadmium (Cd)	0.01%	< 0.01%
Hexavalent Chromium (Cr ⁶⁺)	0.1%	< 0.1%
Polybrominated biphenyls (PBB)	0.1%	< 0.1%
Polybrominated diphenyl ethers (PBDE)	0.1%	< 0.1%

Certain components of products as stated above are exempted under the Annex III of the RoHS2 Directives as noted below:

Examples of exempted components are:

1. Lead in glass of cathode ray tubes.
2. Lead in glass of fluorescent tubes not exceeding 0.2% by weight.
3. Lead as an alloying element in aluminium containing up to 0.4% lead by weight.
4. Copper alloy containing up to 4% lead by weight.
5. Lead in high melting temperature type solders (i.e. lead-based alloys containing 85% by weight or more lead).
6. Electrical and electronic components containing lead in a glass or ceramic other than dielectric ceramic in capacitors, e.g. piezoelectronic devices, or in a glass or ceramic matrix compound.

Copyright Information

Copyright © ViewSonic® Corporation, 2016. All rights reserved.
Macintosh and Power Macintosh are registered trademarks of Apple Inc.
Microsoft, Windows, Windows NT, and the Windows logo are registered trademarks of Microsoft Corporation in the United States and other countries.
ViewSonic, the three birds logo, OnView, ViewMatch, and ViewMeter are registered trademarks of ViewSonic Corporation.
VESA is a registered trademark of the Video Electronics Standards Association.
DPMS and DDC are trademarks of VESA.
PS/2, VGA and XGA are registered trademarks of International Business Machines Corporation.
Disclaimer: ViewSonic Corporation shall not be liable for technical or editorial errors or omissions contained herein; nor for incidental or consequential damages resulting from furnishing this material, or the performance or use of this product.
In the interest of continuing product improvement, ViewSonic Corporation reserves the right to change product specifications without notice. Information in this document may change without notice.
No part of this document may be copied, reproduced, or transmitted by any means, for any purpose without prior written permission from ViewSonic Corporation.

Product Registration

To fulfill possible future product needs, and to receive additional product information as it becomes available, please visit your region section on ViewSonic's website to register your product online.
The ViewSonic CD also provides an opportunity for you to print the product registration form. Upon completion, please mail or fax to a respective ViewSonic office. To find your registration form, use the directory “:\CD\Registration”.
Registering your product will best prepare you for future customer service needs. Please print this user guide and fill the information in the “For Your Records” section. For additional information, please see the “Customer Support” section in this guide.

For Your Records

Product Name:	LS810/LS820/LS830 ViewSonic DLP Projector
Model Number:	VS16500/VS16501/VS16460
Document Number:	LS810/LS820/LS830_UG_ENG Rev. 1A 06-21-16
Serial Number:	_____
Purchase Date:	_____

Product disposal at end of product life

The lightsource in this product contains mercury which can be dangerous to you and the environment. Please use care and dispose of in accordance with local, state or federal laws.

ViewSonic respects the environment and is committed to working and living green. Thank you for being part of Smarter, Greener Computing. Please visit ViewSonic website to learn more.

USA & Canada: <http://www.viewsonic.com/company/green/recycle-program/>

Europe: <http://www.viewsoniceurope.com/uk/support/recycling-information/>

Taiwan: <http://recycle.epa.gov.tw/recycle/index2.aspx>

Table of Contents

Key safety instructions	1	Switching input signal	23
Introduction.....	3	Changing HDMI input settings.....	24
Projector features	3	Adjusting the projected image	25
Shipping contents	4	Correcting keystone.....	26
External appearance of the projector	5	Adjusting the 4 corners.....	27
Device control and functions	6	Zoom out for detailed review	28
		Selecting the aspect ratio	28
		About the aspect ratio.....	29
Projector Positioning	12	Optimizing the image.....	30
Choosing a location	12	Using Screen Color	30
Projection Dimension.....	13	Fine-tuning of image quality in user modes.....	31
		Setting the Presentation Timer	34
Connection.....	14	Hiding the image.....	35
Connect to the computer or monitor	15	Locking control keys	35
Connecting to Video source devices	16	Creating your own startup screen.....	36
Connecting to HDMI devices	17	Operations at high altitudes.....	36
To connect the projector to a Component Video source device:	17	Using the CEC function	37
To connect the projector to a S-Video source device:	17	3D functions.....	37
Connecting to composite video source devices	18	Using the projector under standby mode	37
Audio playback with the projector.....	18	Adjusting the sound.....	38
		Switch off the projector	38
		Menu operations.....	39
		Description of each menu.....	42
Operation.....	19	Maintenance.....	47
Activate the projector.....	19	Care of the projector.....	47
Using the menus.....	19	Using the filter.....	48
Disabling the password function.....	21	LED Indicator.....	49
Setting a password.....	21		
If you forget your password	21	Troubleshooting	50
Entering the password recall procedure ..	22		
Change Password	22		
Disabling the password function.....	22		

Specifications 51

Projector specifications.....	51
Dimensions.....	52
Ceiling mount installation.....	52
Timing chart.....	53

Copyright information.... 57

Copyright.....	57
Disclaimer.....	57

Appendix 58

IR control table.....	58
Address Code.....	59
RS232 command table.....	59

Key safety instructions

Design and testing of your projector have been carried out in compliance with the latest safety standards for information technology (IT) devices. However, it is extremely important for you to follow the instructions provided in this manual and product labels during use to ensure user safety.

Safety Instructions

- **Please read through this manual before using the projector.** Save it for future reference.
- **Do not look directly into the projector lens during use.** The intense light beam may damage your eyes.
- **Refer servicing to qualified service personnel.**
- **Always open the lens shutter or remove the lens cap when the projector light source has been switched on.**
- Stable line voltage may not be available in certain countries. This projector is designed to operate safely within a mains voltage between 100 to 240 volts AC, but could fail if power cuts or surges of ± 10 volts occur. **In areas where the mains voltage may fluctuate or cut out, it is recommended that you connect your projector through a power stabilizer, surge protector or uninterruptible power supply (UPS).**
- Do not block the projection lens with any object when using the projector as this could cause the said objects to overheat, deform, or even cause a fire. To temporarily turn off the light source, press the [BLANK] button on the projector or remote control.
- Do not place the projector on an unstable cart, stand, or table. The product may fall and sustain serious damages.
- Do not attempt to disassemble this projector. The projector contains high voltage parts that may cause electrocution or death when it comes in contact with the human body. Under no circumstances should you ever undo or remove any other covers. Refer servicing to qualified service personnel.
- Do not place the projector in any of the following environments.
 - Space that is poorly ventilated or confined. Allow at least 50 cm clearance from walls and ensure free flow of air around the projector.
 - Locations where temperatures may become excessively high, such as the inside of a car with all windows rolled up.
 - Locations that are too humid, dusty, or smoky may contaminate optical components, shortening the projector's life span and darkening the image.
 - Locations near fire alarms
 - Locations where temperature exceed 35°C/104°F.
 - Locations with altitudes greater than 3000 m (10000 feet).

- Do not block the ventilation holes. If the ventilation holes are seriously obstructed, overheating inside the projector may result in a fire.
 - Do not place this projector on a blanket, bedding, or any other soft surface.
 - Do not cover this projector with a cloth or any other item.
 - Do not place inflammables near the projector.
- Do not step on the projector or place any object upon it. These acts may damage the projector itself as well as cause accidents or personal injury.
- Do not place liquids near or on the projector. Liquids spilled into the projector may cause damage. If the projector does become wet, please unplug the power cable from the power socket and contact your local repair center for repairs.
- This product can be mounted on a ceiling suspension mount for back projection.



Use only ceiling suspension mounts that comply with the relevant requirements and ensure that the installation is secure.

- When the projector is under operation, you may sense some heated air and odor from its ventilation grill. This is a normal phenomenon and not a product defect.
- Do not use the safety lever during transport or installation purposes. The safety lever should only be used with the anti-theft cables sold on the market.

Safety instructions for ceiling mounting of the projector

We hope you to have a pleasant user experience with our projector. This is why we're bringing these safety reminders to your attention to prevent possible damage to person and property.

If you intend to mount your projector on the ceiling, we strongly recommend that you use a suitable projector ceiling mount kit and ensure it is securely and safely installed.

There may be safety risks if you fail to use an appropriate projector ceiling mounting kit. Use of inappropriate connectors or screws of the wrong specifications or length may cause the projector to fall from the ceiling.

You can purchase a projector ceiling mounting kit from the projector dealer. We recommend buying a safety harness in addition to the mounting kit. The harness should be securely connected to the anti-theft locking groove on the projector as well as the base of the ceiling mounting support. This will provide additional protection in case the connectors of the mounting support becoming loose.

Introduction

Projector features

The projector integrates high-performance optical engine projection and a user-friendly design to deliver high reliability and ease of use.

The projector offers the following features.

- Presentation Timer offers better time management during presentations
- 3D Display supported
- Color Management allows you to adjust colors according to your preferences
- Screen Color Correction allows projection on surfaces with various pre-defined colors
- Quick auto search speeding up the signal detecting process
- Color mode provides different options designed for different projection purposes
- Select Fast Shutdown
- Digital Keystone Correction and 4 Corner Adjustments (available for selected models) can help correct distorted images.
- Provides Color Management adjustments for digital / video displays
- Capable of displaying 1.07 billion colors
- Multi-language On-Screen Display (OSD) menus
- Switchable normal and economic modes to reduce the power consumption
- Compatible with Component HDTV (YPbPr)
- HDMI Consumer Electronics Control (CEC) allows synchronized power activation / shutdown operations when the projector is connected to a CEC-compatible DVD player or device via the HDMI input jack

 **The apparent brightness of the projected image will vary depending on ambient lighting conditions, and selected input signal contrast/brightness settings. Brightness is also directly proportional to projection distance.**

Shipping contents

Carefully unpack the product and check that you have all of the items shown below. If any of these items are missing, please contact the dealer from whom you've purchased this projector.

Standard accessories

 The supplied accessories will be suitable for your region, and may differ from those illustrated.

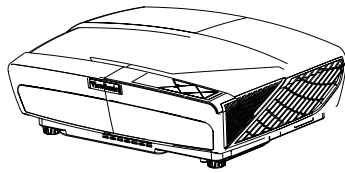

Projector

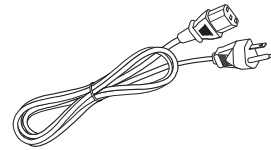

Power cable

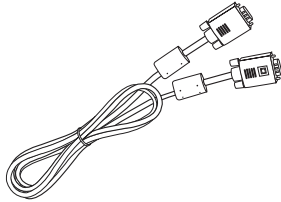

VGA cable



Multi-language user manual CD



Quick Start Guide



Remote control battery



HDMI Cable

External appearance of the projector

Front / rear

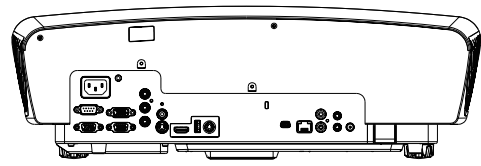
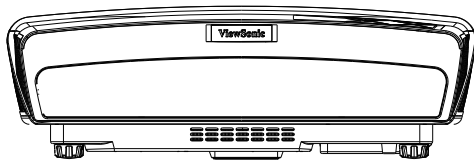

Side

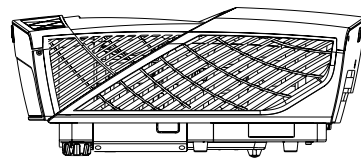
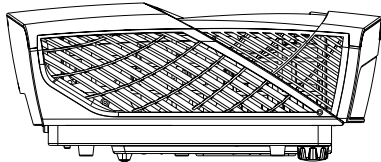

Top / bottom

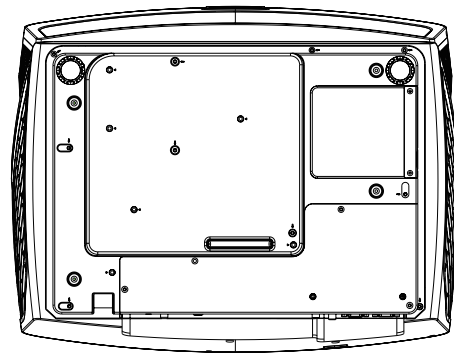
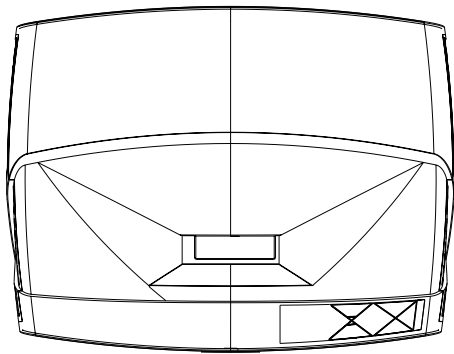

Warning

- This equipment must be connected to ground.
- You may add power interruption devices in the fixed wiring or plug in the power cable to a nearby socket for convenience. If failures or errors occur during equipment operations, use the power interruption device to cut the power or unplug the power cable from the socket.

Device control and functions projector

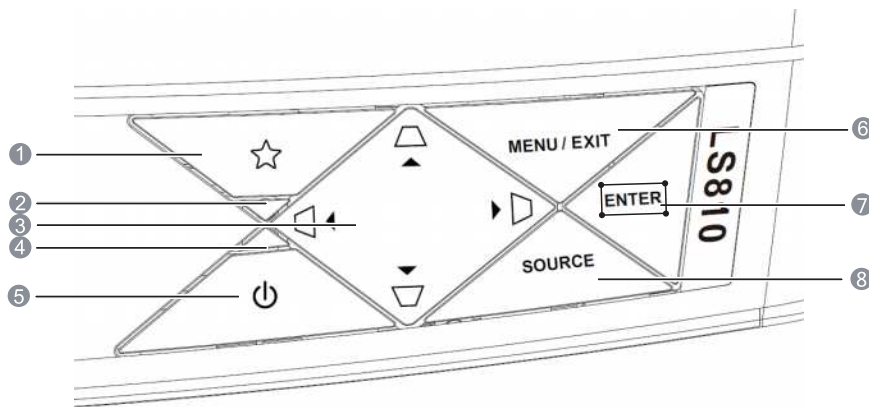

1. ☆ **(MY BUTTON)**
Allows the user to define buttons and hotkeys. These functions can be set using the OSD menu.
2. **STATUS LED**
3. ◁/▷/▲/▼ **(Keystone Correction buttons)**
Manually corrects distorted images resulting from an angled projection.
◀Left/▶Right/▲Up/▼Down
Selects the required menu item to make adjustments.
4. **POWER LED**
5. ⏻ **(POWER)**
Toggles the projector between standby mode and Power ON.
6. **MENU/EXIT**
Open the OSD menu.
7. **ENTER**
Enacts the selected On-Screen Display (OSD) menu item.
⏏
Displays the Corner Adj. page.
8. **SOURCE**
Shows the Source Selection Bar.



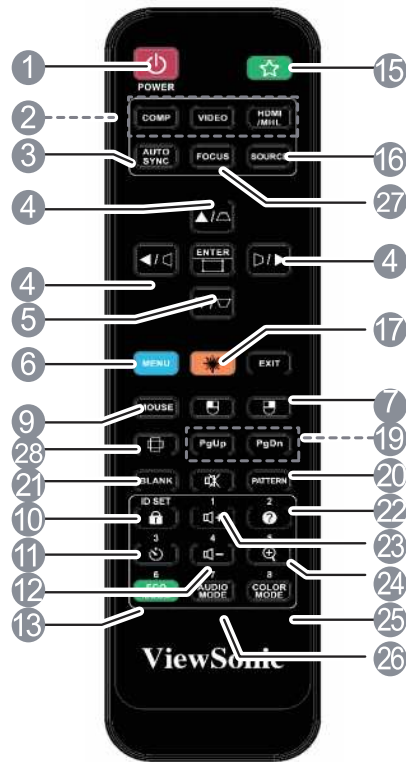





Remote Control



To use the remote mouse cursor control buttons (Page Up, Page Down, and) please refer to “Using the remote control cursor” for more details.

1. **Power**
Switches the projector between Standby and ON modes.
2. **Signal Selection button.**
 - **COMP**
Select the signal source for the D-Sub/Comp. display.
 - **VIDEO**
Select the source of the Video displayed.
 - **HDMI/MHL**
Select the source of the HDMI/MHL displayed.
3. **Auto Sync**
Automatically verifies the best picture quality for the image displayed.
4. **△/▽/▷/◁ (Keystone Correction buttons)**
Manually corrects distorted images resulting from an angled projection.
◀Left/▶Right/▲Up/▼Down
Selects the required menu item to make adjustments.

5. **Enter**
Enacts the selected On-Screen Display (OSD) menu item.
6. **Menu**
Open the OSD menu.
7. **(Left Mouse Button)**
Once Cursor Mode has been activated, this key would have the same function as the Left Mouse Button.
 Only available when PC input signals were selected.
8. **(Right Mouse Button)**
Once Cursor Mode has been activated, this key would have the same function as the Right Mouse Button.
 Only available when PC input signals were selected.
9. **Mouse**
Switch between Normal and Cursor Mode.
PgUp, PgDn, , : Activated by pressing the [Mouse] button. The screen will display an icon that indicates Cursor Mode has been activated.
 Only available when PC input signals were selected.

10.  **(Panel Key Lock)**
To disable Panel Key Lock after it has been activated, please press .
11.  **(Presentation Timer)**
Brings up the Presentation Timer settings menu.
12.  **(Volume)**
Brings up the Volume Slider
13. **Eco Mode**
Select light source Mode.
15.  **(My Buttons)**
Allows the user to define hotkeys on the remote control. These functions can be set using the OSD menu.
16. **Source**
Shows the Source Selection Bar.
17. **Laser**
Emits a visible laser pointer beam which can be used during presentations.
18. **Exit**
Goes back to the previous OSD menu. Exits and saves menu settings.
19. **PgUp (Page Up)/PgDn (Page Down)**
Can be used to operate the displayed software (Microsoft PowerPoint) running on the connected computer. When Cursor Mode is activated, these buttons will refer to the Previous Page and Next Page functions.
20. **Pattern**
Shows the inbuilt testing screens.
21. **Blank**
Hide screen image.
22.  **(Help)**
Brings up the Help menu.
23.  **(Mute)**
Toggles the projector audio between on and off.
24.  **(Zoom)**
Brings up the Zoom Bar which can be used to magnify or shrink the projected image.
25. **Color Mode**
Selects an available Picture Setup mode.
26. **Audio Mode**
Selects an Audio mode.
27. **Focusing ring**
Adjusts the focus of the projected image.
28.  **(Aspect ratio)**
Displays the aspect ratio selection bar.

 **Only available when PC input signals were selected.**

Use the laser pointer.

The laser pointer is a professional tool for supporting presentations. Press this button to emit a colored laser pointer beam. The laser beam emitted is within the visible spectrum. To generate the pointer beam continuously, press and hold the [Laser] button.

 **Do not look at the laser light and do not aim the laser beam at yourself or other people. Please read the warning texts provided at the back of the remote control before use.**

The laser pointer is not a toy. Parents should be aware of the hazards posed by laser energy and place the remote at a location not accessible to children.

Remote control code

The projector is capable of having 8 different remote control codes (1 to 8). When using multiple projectors close to each other at the same time, switching the remote control codes will prevent projector disruption by other remote controls. First set the projector's remote control code then switch the code of the remote control itself.

If you want to switch the code at the projector end, please go to **System Settings: Remote Control Code** menu and select 1 to 8.

If you want to switch the code at the remote control end, please press and hold both the [ID set] and number key corresponding to the remote control code for at least 5 seconds. 1 is the initial code by default. Setting the code to 8 allows the remote control to control every projector.





 **The projector will not respond to commands issued by the remote control commands if the projector and remote control codes are not the same. When this happens, a message will appear to remind you to switch the remote control code.**

Remote Control Setting	1
Remote Control Code	1

Using the remote control cursor

Use the remote control to operate your computer during presentations for greater flexibility

1. Before using the remote control to replace your cursor, fix one end of the USB cable to the projector Mini USB port and the other end to the PC or notebook computer. See “[Connect to the computer](#)” for details.
2. Change the input signal to D-Sub or HDMI via PC source.
3. Press the [Mouse] button on the remote control to switch from Normal Mode to Cursor Mode. The screen will display an icon that indicates Cursor Mode has been activated.
4. Achieve mouse cursor functions through using your remote.
 - To move the cursor on screen, please press ◀/▲/▼/▶.
 - To make a single click with the Left Mouse Button, please press .
 - To make a single click with the Right Mouse Button, please press .
 - To use the displayed software (such as Microsoft PowerPoint) of the connected computer, press PgUp/PgDn to go to the previous page or the next page.
 - To return to Normal mode, press the [Mouse] button again or press other functional buttons not related to the mouse functions.

Remote control effective range

There is an infra-red (IR) remote control sensor located at the front of the projector. Hold the remote control and maintain a perpendicular angle within 30 degrees with the IR remote control sensor to achieve normal remote control functions. The distance between the remote control and the sensor should not exceed 8 meters (about 26 feet).

Do not place any obstruction in front of the IR sensor on the projector as this may block the IR beam.

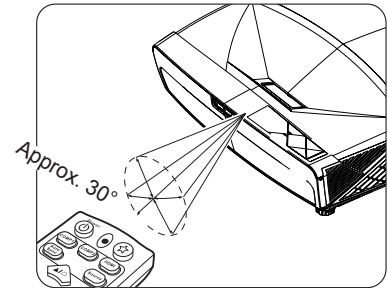

Replacing the remote control battery

1. To open the battery cover, place the remote control with the backside facing upwards. Press down at the indicated area and then pull the battery lid upwards along the indicated direction.
2. Take out the old batteries (if required) and then place 2 AAA batteries according to the indicated orientation. The positive pole of the battery should be directed at the (+) direction while the negative pole should be directed at the direction.
3. Align the battery lid with the bottom part of the remote control and push downwards. Return the lid to its original position to complete the process.

Warning

- **Avoid placing the remote control and battery in hot and humid environments such as kitchens, bathrooms, saunas, tanning rooms, or within vehicles.**
- **Replace batteries only with the same or equivalent type of batteries recommended by the battery manufacturer.**
- **Refer to the manufacturer's instructions and local environmental regulations to dispose of old batteries.**
- **Do not throw batteries into fires. There may be danger of an explosion.**
- **If the battery is flat or if you will not be using the remote control for a while, remove the battery to prevent battery leaks from damaging the remote control.**

Projector Positioning

Choosing a location

You may refer to the room layout or personal preference to determine the location of installation. Considerations include size and position of the screen, location of a suitable power outlet, as well as the location and distance between the projector and other equipment.

There are 4 potential installation locations for the projector:

1. Front Table

For this location, the projector is placed right in front of the screen. This is the most commonly employed means for placing the projector. It is quick to setup and highly mobile.

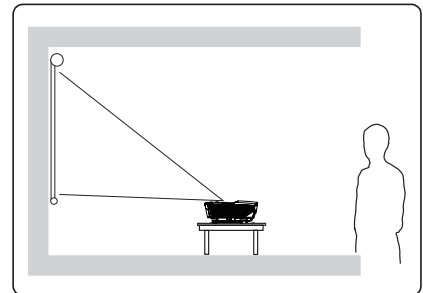

2. Front Ceiling

For this location, the projector is suspended upside-down from the ceiling in front of the screen.

Purchase a Projector Ceiling Mounting Kit from your dealer to mount your projector on the ceiling.

After activating your projector, go to **System Settings: Projector Position** menu and set to **Front Ceiling**.

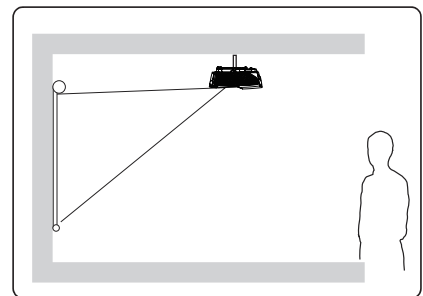

3. Rear Ceiling

For this location, the projector is suspended upside-down from the ceiling behind the screen.

Note that a special rear projection screen and Projector Ceiling Mounting Kit are required for this installation location.

After activating your projector, go to **System Settings: Projector Position** menu and select **Rear Ceiling**.

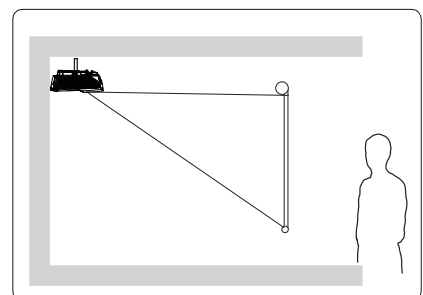

4. Rear Table

For this location, the projector is placed right behind the screen.

Note that a special rear projection screen is required.

After activating the projector, go to **System Settings: Projector Position** menu and select **Rear Table**.

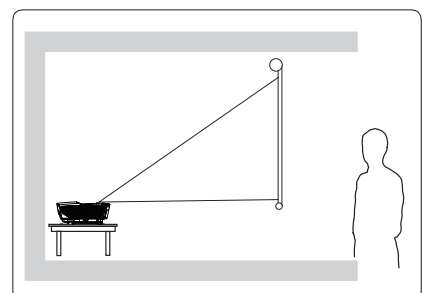

Projection Dimension

☞ Screens mentioned in the following section refer to projection screens composed of a screen surface and supporting structures.

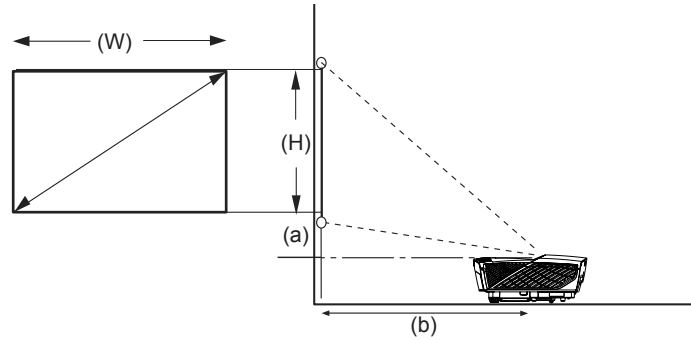

Distance from the center of the glass lens to the bottom peg: 115 mm

1080P	Unit: mm		Corresponding model:	LS820 LS830
Diagonal L	a	b	Screen width w	Screen height H
80"	209.6	405	1771	996
86"	229.4	442	1904	1071
90"	238.6	463	1992	1121
93"	248.0	481	2059	1158
100"	267.8	521	2214	1245
110"	296.8	577	2435	1370
120"	325.8	632	2657	1495
130"	346.9	692	2879	1619
140"	376.0	744	3099	1743
150"	404.0	800	3321	1868

WXGA	Unit: mm		Corresponding model:	LS810
Diagonal L	a	b	Screen width w	Screen height H
80"	188.92	411	1723	1077
86"	204.89	443	1852	1158
90"	215.54	465	1939	1212
93"	221.02	483	2003	1252
100"	238.95	519	2154	1346
103"	245.64	536	2219	1387
110"	266.77	578	2369	1481
120"	291.39	631	2585	1615
130"	314.00	687	2800	1750
140"	336.62	737	3015	1885
150"	362.23	791	3231	2019

** These figures are for reference purposes only. Refer to the actual projector for the precise dimensions.

Connection

When connecting a signal source to the projector, be sure to:

1. Turn all devices off before making any connections.
2. Use the correct signal cables for each source.
3. Ensure the cables are firmly inserted.

 In the connections shown below, some cables may not be included within the projector packaging (please refer to “Shipping contents”). You may purchase the required signal cables from an electronics store.

 The following links and icons are for references only. Connection jacks at the back of the projectors may differ according to the projector model.

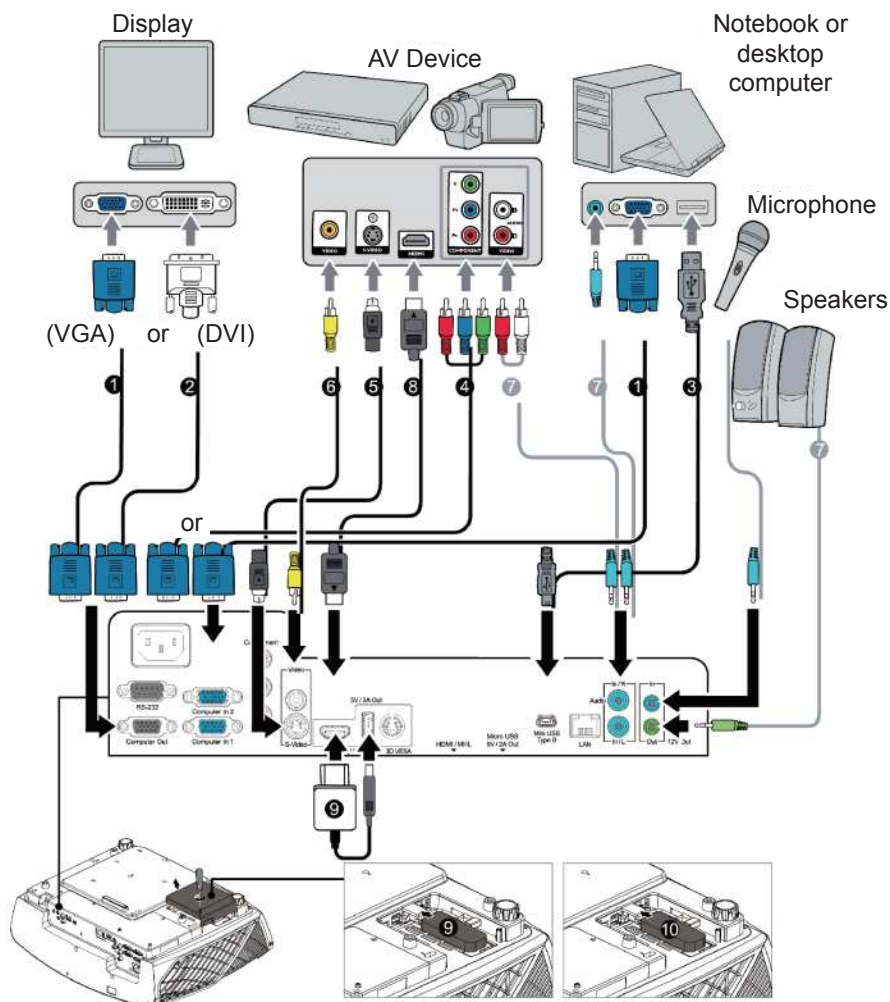

1. Computer In	6. Video
2. Computer Out	7. Audio
3. Mini USB	8. HDMI + USB 5V/2A Out
4. Component	9. HDMI + Micro USB
5. S-Video	10. MHL

Connect to the computer or monitor

Connect to the computer

1. Use the VGA cable provided. Plug one end to the D-Sub output jack at the computer end.
2. Connect the other end of the VGA cable to the COMPUTER IN1 or IN2 signal input jack on the projector.
3. To use the remote mouse cursor control function, plug in the larger end of the USB cable to the USB port on the computer and the smaller end to the MINI USB jack on the projector. See [“Using the remote control cursor”](#) for details.

 Many notebooks have not activated their monitor jack after being connected to the monitor. The user can often press FN + F3 or CRT/LCD button to switch ON/OFF the externally connected monitor. Find the function key labeled with the CRT/LCD or monitor icon on the notebook. Press the FN key and the labeled function key. Please refer to the instruction manual provided with the notebook computer for the combination keys and their functions.

Connect to the monitor

If you want the display to be shown both on the computer monitor as well as the screen, refer to the following instructions. Connect the VGA cable to the MONITOR OUT signal output jack on the projector as well as the external display.

1. Connect the projector to the computer as described in the [Connect to Computer] section.
2. Use a suitable VGA cable (only 1 such cable is provided) and connect one end of the cable to the D-Sub input jack on the video display.
If the display is provided with a DVI input jack, then connect the DVI end of the VGA-DVI-A cable to the DVI input jack on the video display.
3. Connect the other end of the cable to the COMPUTER OUT jack on the projector.

 **COMPUTER OUT** output will only be generated when the cable is connected to the **COMPUTER IN** jack of the projector.

 This connection mode can only be used when the projector is in Standby Mode. Go to Signal Source > Standby and activate the VGA Out function in the setup menu.

Connecting to Video source devices

You can connect the projector to any of the following video source device with an output jack:

- HDMI
- Component video
- S- video
- Video (composite video)

Only 1 of the aforementioned connection methods is required to connect the projector to the video source device. However, different connection methods would provide a different video quality. The connection method selected would be determined by the presence of matching jacks on the projector and Video source device:

Best video quality

HDMI is the best video connection method available. If the source device comes with HDMI jacks, you will be able to acquire uncompressed digital video quality.

Please refer to [“Connecting to HDMI devices”](#) for details on how to connect the projector to HDMI devices.

If you don't have any usable HDMI source, the next best video signal would be Component Video (not to be confused with Composite Video). Digital TV tuners and DVD players are provided with Component Video output sockets. If your device includes Component Video, then this would be your primary choice of connection to the (composite) video.

Please refer to [“To connect the projector to a Component Video source device:”](#) for details on how to connect your projector to Component Video devices.

Better video quality

S-video method provides slightly better simulation video compared to standard composite videos. If the video device is provided with both composite video and s-video output jacks, you should try to choose S-video connection first.

Please refer to [“To connect the projector to a S-Video source device:”](#) for details on how to connect your projector to S-video devices.

Least video quality

Composite Video is an analog video and will result in a perfectly acceptable, but less than optimal result from your projector, being the least video quality of the available methods described here.

Please refer to [“Connecting to composite video source devices”](#) for details on how to connect your projector to composite video devices.

Connecting audio

The projector includes built-in dual-channel speakers that is designed to provide basic audio functionality accompanying data presentations for business purposes. It is not designed for, nor intended for stereo audio reproduction use as might be expected in home theater or home cinema applications.

Connecting to HDMI devices

Use an HDMI cable to establish a connection between the projector and HDMI device.

1. Connect one end of the HDMI cable to the HDMI output jack on the video device.
2. Connect the other end of the cable to the HDMI signal input jack on the projector.

 In the unlikely event that the projector is connected to a DVD player via the projector's HDMI input and the projected picture displays wrong colors, please change the color space to YUV. See ["Changing HDMI input settings"](#) for details.

To connect the projector to a Component Video source device:

Examine your Video source device to determine if a set of unused Component Video output sockets is available:

- If so, you can continue with this procedure.
 - If not, you will need to reassess which method to use to connect to the device.
1. Take a VGA (D-Sub) Component adapter cable and connect the end with 3 RCA type connectors to the Component Video output sockets of the Video source device. Match the color of the plugs to the color of the sockets; green to green, blue to blue, and red to red.
 2. Connect the end of the VGA (D-Sub) Component adapter cable (with the D-Sub type connector) to the COMPUTER IN1/IN2 jack on the projector.

 If the selected video image is not displayed after the projector is turned on and the correct video source has been selected, check that the Video source device is turned on and operating correctly. You must also check that the signal cables have been connected correctly.

To connect the projector to a S-Video source device:

Examine your Video source device to determine if an unused S-Video output socket is available:

- If so, you can continue with this procedure.
 - If not, you will need to reassess which method to use to connect to the device.
1. Take an S-Video cable and connect one end to the S-Video output socket of the Video source device.
 2. Connect the other end of the S-Video cable to the S-VIDEO socket on the projector.

 If the selected video image is not displayed after the projector is turned on and the correct video source has been selected, check that the Video source device is turned on and operating correctly. You must also check that the signal cables have been connected correctly.

 If you have already made a Component Video connection between the projector and this S-Video source device using Component Video connections, an S-Video connection will not be required as this is an unnecessary second connection of poorer picture quality. See ["Connecting to Video source devices"](#) for details.

Connecting to composite video source devices

Examine your Video source device to determine if an unused composite output jack is available:

- If so, you can continue with this procedure.
 - If not, you will need to reassess which method to use to connect to the device.
1. Take a Video cable and connect one end to the composite Video output socket of the Video source device.
 2. Connect the other end of the video cable to the VIDEO socket on the projector.

 If the selected video image is not displayed after the projector is turned on and the correct video source has been selected, check that the Video source device is turned on and operating correctly. You must also check that the signal cables have been connected correctly.

 You need only connect to this device using a composite Video connection if Component Video and S-Video inputs are unavailable for use. See [“Connecting to Video source devices”](#) for details.

Audio playback with the projector

During demonstration, you may use the projector (mixed dual channel) speakers or connect separate sound systems with sound amplification functions to the AUDIO OUT sockets on the projector.

If you have a separate sound system, you should connect the audio output of your Video source device to this sound system instead of the mono audio input on the projector.

Operation

Activate the projector

Plug the power cord into the projector and into a wall socket. Turn on the switch on the wall socket (if available).

Press  Power to switch on the projector.

If this is the first time that you've switched on the projector, please refer to on-screen instructions and select your OSD language.

Switch on all connected equipment.

The projector will then begin a search of the input signals. The lower right corner of the screen will display the current input signal being scanned. If the projector fails to detect a valid signal, the screen will display a **[NO SIGNAL]** message until an input signal is found.

You can press Source to select the input signal required. See “Switching input signal” for details.

 If the input signal frequency/resolution exceeds the working range of the projector, the blank screen will display the [Out of Range] message. Please change to an input signal which is compatible with the projector's resolution or set the input signal to a lower setting. For more details, please refer to the [Resolution Table].

Using the menus

This projector is provided with an On-Screen Display (OSD) menu function, allowing you to make changes to various settings.

 The following OSD screenshot is for reference only. Actual OSD design may differ.

The following is an overview of the OSD menu.

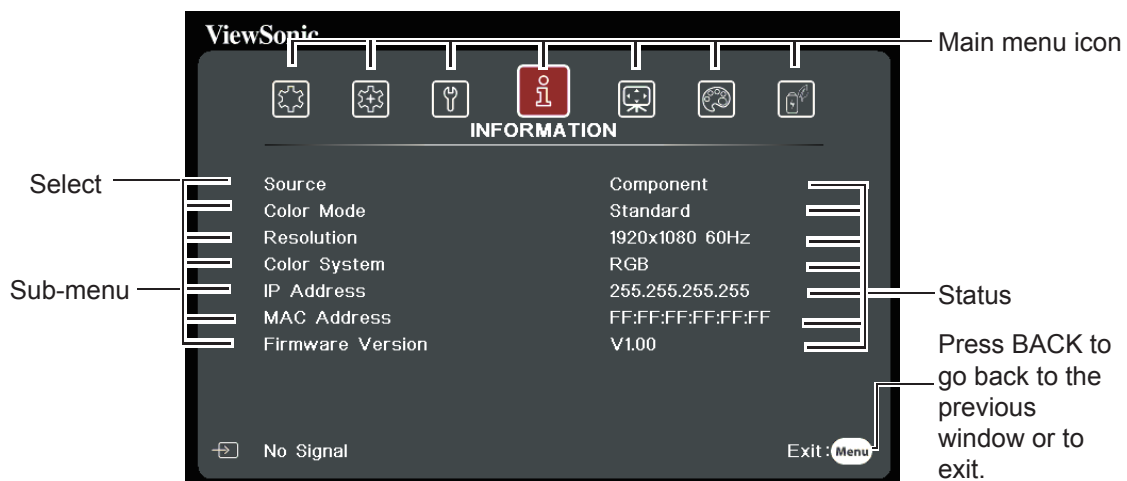

1. Press ▼ and select **Display**, then press ◀▶ to select screen color.

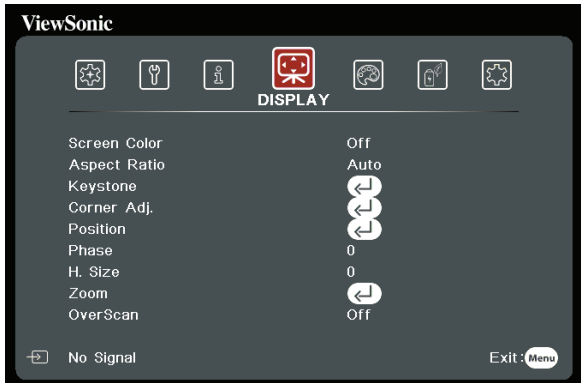

2. Press ▼ and select **Image**, then press ◀▶ select the primary color mode.

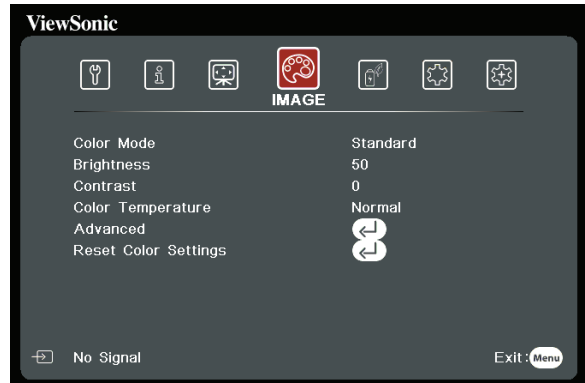

3. Press ▼ and select **Power Management**, then press ◀▶ to select automatic activation of power.

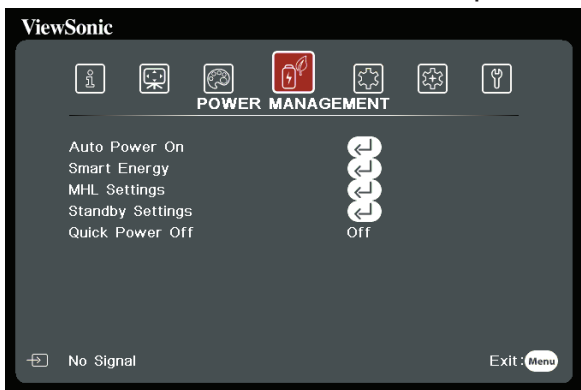

4. Press ▼ and select **Basic**, then press ◀▶ to start audio channel setup.

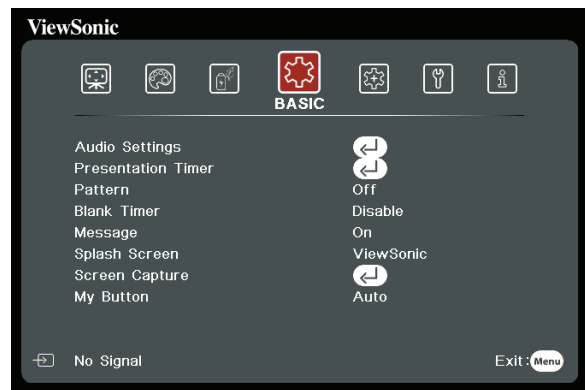

5. Press ▼ and select **Advanced**, then press ◀▶ to select 3D settings.

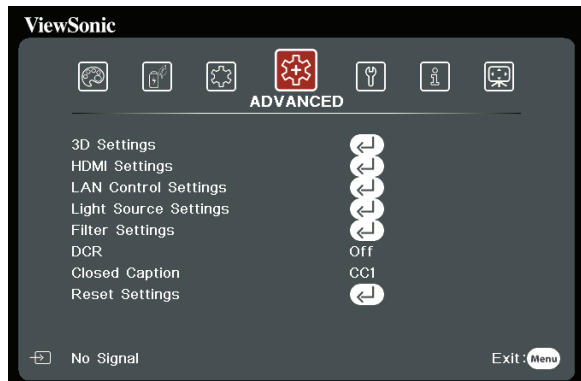

6. Press ▼ and select **System**, then press ◀▶ to select the primary language.

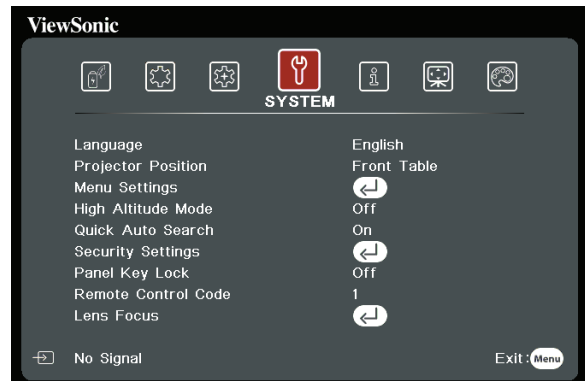

Disabling the password function

For security purposes and to help prevent unauthorized use, the projector includes an option for setting up password security. Passwords may be set using the On-Screen Display (OSD) menu. Please refer to the [Menu Use] section for details on OSD menu operations.

 It is troublesome if you keep forgetting the password after setting up password protection. We recommend writing down the password and placing it somewhere safe for future reference in case you forget.

Setting a password

 Once a password has been set, the user must provide the correct password after starting the projector. Otherwise, the projector cannot be used.

1. Open the OSD Menu and enter **System setup > Advanced > Advanced > Security Settings** menu.
2. Press [Enter]. The **Security Settings** page will be displayed.
3. Select **Power Lock**, then press ◀/▶ and select **ON**.
4. The picture on the right shows 4 arrow keys (◀, ▲, ▼, ▶) which each represent 4 numbers (1, 2, 3, 4) respectively. According to the password you desire to set, press the arrow keys to enter six digits for the password.
5. Enter the password and confirm that password.
After completing password settings, the OSD menu will return to the **Security Settings** page.
6. Press [Exit] to leave the OSD menu.

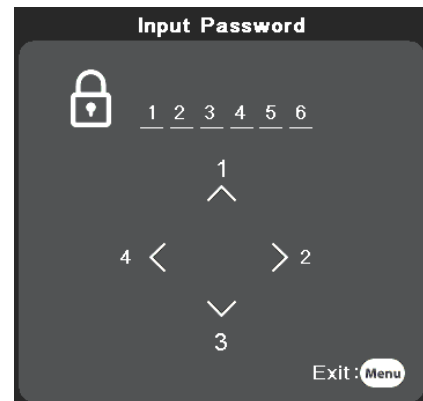

If you forget your password

If the password function is activated, you will be asked to enter the six-digit password every time you turn on the projector. If you enter the wrong password, the password error message as pictured to the right will be displayed for 5 seconds before the message [INPUT PASSWORD] is shown. You can enter another 6-digit password. You may use the password recall procedure if you forgot your password and did not record it in this manual. See [“Entering the password recall procedure”](#) for details.

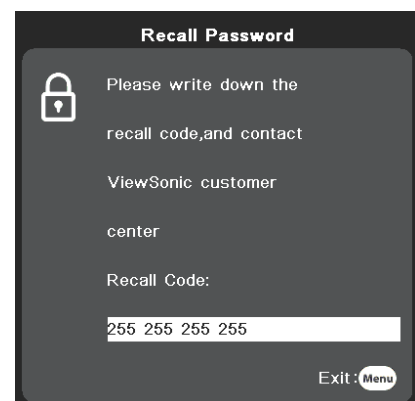

If you enter an incorrect password 5 times in succession, the projector will automatically shut down in a short time.

Entering the password recall procedure

1. Press and hold the [Auto Sync] button on the remote control for 3 seconds. The projector will display a coded number on the screen.
2. Write down the number and turn off your projector.
3. Seek help from the local service center to decode the number. You may be required to provide proof of purchase to verify that you are an authorized user of the projector.

 The [XXX] number in the screenshot shown above is determined by the projector model number.

Change Password

1. Open the OSD and enter **System Settings > Security Settings > Change Password** menu.
2. Press [Enter]. The message **[INPUT CURRENT PASSWORD]** will be shown.
3. Enter the old password.
 - If the password entered is correct, another message **[INPUT NEW PASSWORD]** will be shown.
 - If the password entered is incorrect, then the password error message will be displayed for 5 seconds before the screen shows the **[INPUT CURRENT PASSWORD]**. You will then need to re-enter the password. You can either press [Exit] to cancel the process or try other passwords.
4. Enter a new password.
5. Enter the password and confirm that password.
6. You have successfully assigned a new password to the projector. Remember to enter the new password next time the projector is started.
7. Press [Exit] to leave the OSD menu.

 Any digit entered will be displayed as asterisks [*] on-screen. We recommend writing down the password and placing it somewhere safe for future reference in case you forget.

Disabling the password function

1. Open the OSD menu and enter **System Settings > Security Settings > Power Lock** Menu.
2. Press ◀/▶ and select **OFF**.
3. The **[INPUT PASSWORD]** message will be shown. Enter the current password.
 - If the password is correct, the OSD menu will return to the **Security Settings** page and show **Power Lock** in the **[OFF]** column. You will not have to enter the password next time you turn on the projector.
 - If the password entered is incorrect, then the password error message will be displayed for 5 seconds before the screen shows the **[INPUT PASSWORD]**. You will then need to re-enter the password. You can either press [Exit] to cancel the process or try other passwords.

 Though the password function is disabled, you need to keep the old password in hand should you ever need to re-activate the password function by entering the old password.

Switching input signal

The projector can be connected to multiple devices at the same time. However, it can only display one full screen at a time.

If you want the projector to automatically search for various signals, please confirm that the **Auto Quick Search** function in the **Source** menu is switched **ON**.

You may also press the source selection button on the remote control or search for available input signals to manually select the desired signals.

1. Press [Source] to display the source selection column.
2. Keep pressing the ▲/▼ until you arrive at the desired signal, then press [Enter].

Once detected, the selected source information will display on the screen for seconds. If there are multiple devices connected to the projector, repeat steps 1 to 2 to search for another signal.

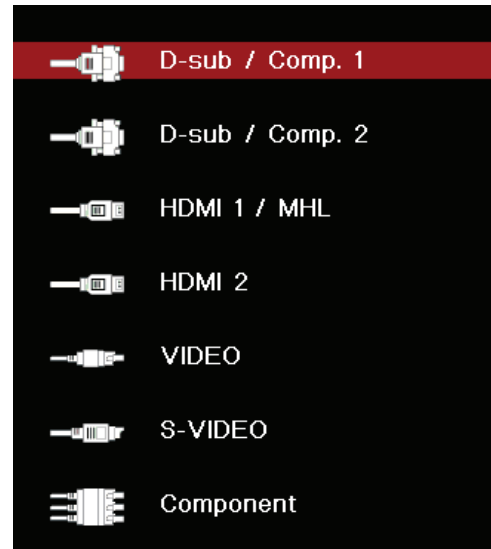

-  For display resolutions of this projector, please refer to **“Projector specifications”**. To achieve the best image display effects, you should select and use an input signal that outputs at this resolution. Any other resolutions will be scaled by the projector depending upon the aspect ratio setting, which may cause some image distortion or loss of picture clarity. See **“Selecting the aspect ratio”** for details.

Changing HDMI input settings

In the unlikely event that you connect the projector to a device (such as DVD or Blu-ray player) via the projector's HDMI input jack, and the projected picture displays the wrong colors, please change the color space settings to one that complies with the color space settings of the output device.

To perform this operation:

1. Open the OSD menu and enter **Display > HDMI settings** Menu.
2. Press [Enter].
3. Select **HDMI format**, then press ◀/▶ to select a suitable color space according to the color space settings of the output device.
 - **RGB**: Changes the color space to RGB.
 - **YUV**: Changes the color space to YUV.
 - **Auto**: Sets the projector to automatically detect the color space settings of the color space.
4. Select **HDMI Range**, then press ◀/▶ to select a suitable color range according to the color range settings of the output device.
 - **Enhanced**: Changes HDMI color range to 0-255
 - **Normal**: Changes HDMI color range to 16-235.
 - **Auto**: Sets the projector to automatically detect the HDMI range of the input signal.

 This function is only available when the HDMI input jack is being used.

 Please refer to equipment documentation to gain more details on color space and HDMI range settings.

Adjusting the projected image

Adjusting the projection angle

The projector is furnished with an adjustment support peg. The adjustment support peg may be used to adjust projection height and projection angle along the vertical axis. The user may turn the adjustment support peg to make fine adjustments to projection angle and position of the projected image until it reaches the desired location.

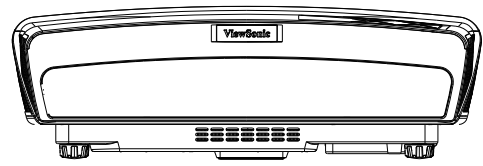

If the projector is placed on an uneven surface or where the screen and projector are not perpendicular to each other, the projected image may be subject to keystone (trapezoidal) distortion. For more details on projection calibration, please refer to [“Correcting keystone”](#).

Auto-adjustments to the image

You may need to optimize picture quality in some cases. To do this, press and hold the [Auto Sync] button of the remote control. Within 5 seconds, the built-in Intelligent Auto Adjust function will re-adjust the values of Frequency and Clock to provide the best picture quality.

The current source information will be displayed in the upper left corner of the screen for 3 seconds.

 When using Auto Adjust function, the entire screen will turn black.

 This function is only available when PC D-Sub input signal (analog RGB) is selected.

Auto-adjustments to image clarity

The focusing ring can be turned to adjust image clarity.

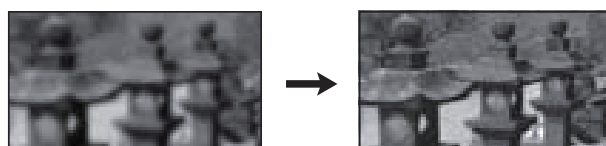
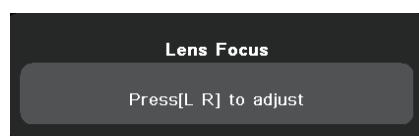

Correcting keystone

Keystone distortion is a problem where the projected image becomes trapezoidal in shape (keystone distortion) as a result of poor projection angle.

To correct this situation, you should adjust projector height and use the following steps to correct the issue manually.

- Using the remote control

1. Press $\triangle/\square/\triangleright/\triangleleft$ to display the Keystone Correction page.
2. Press \triangle to initiate Keystone Correction at the top of the image. Press \square to initiate Keystone Correction at the bottom of the image. Press \triangleright to initiate Keystone Correction at the right side of the image. Press \triangleleft to initiate Keystone Correction at the left side of the image.



- Using the OSD menu

1. Open the OSD menu and open **Display > Keystone Correction** menu.



2. Press the \triangle button to initiate Keystone Correction at the top of the image or press the \square button to initiate Keystone Correction at the bottom of the image.
3. Open the OSD menu and open **Display > Keystone Correction** menu.
4. Press [Enter]. This will bring up the **Keystone Correction** page.
5. Select **Vertical** and then press \triangle to initiate Keystone Correction at the top of the image or press \square to initiate Keystone Correction at the bottom of the image.
6. You can also select **Horizontal** and then press \triangleright to initiate Keystone Correction at the right side of the image. Press \triangleleft to initiate Keystone Correction at the left side of the image.

Adjusting the 4 corners

You may manually adjust the irregular shapes and sizes of the rectangular image manually.

1. To display the **Corner Adjustment** page, please follow any one of these steps:
 - i. Press [Enter].
 - ii. Open the OSD Menu and enter **Display > Corner Adjustment** menu and press [Enter]. This will bring up the **Corner Adjustment** page.
2. Press ◀/▲/▼/▶ to select the corner you wish to adjust, and then press [Enter].
3. Press ◀/▶ to select a suitable adjustment method and then press [Enter].
4. As shown in the screen, (▲/▼ to perform 45 degree adjustments and ◀/▲/▼/▶ to perform 90 degree adjustments). Please press ◀/▲/▼/▶ to adjust the shapes and size. You can press [Menu] or [Exit] to return to the previous step. Press and hold [Enter] for 2 seconds to reset the settings of the selected corner.

☞ **Adjusting Keystone Correction will reset Corner Adjustment settings.**

☞ **After making Corner Adjustment settings, you will no longer be able to adjust certain aspect ratios or time sequences. In case you need to perform these changes, please reset the settings for all 4 corners. The following message will be displayed:**

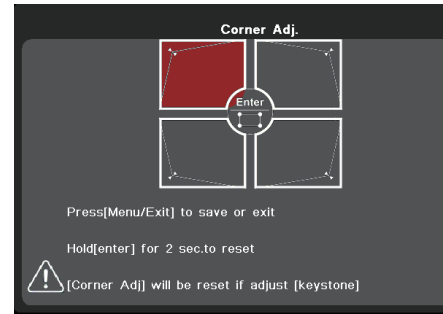
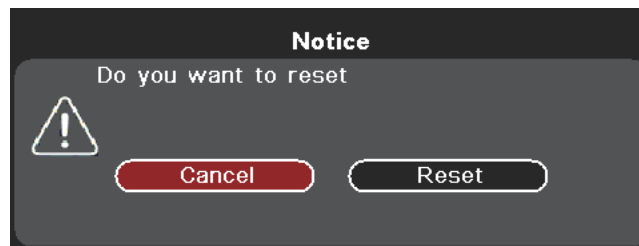





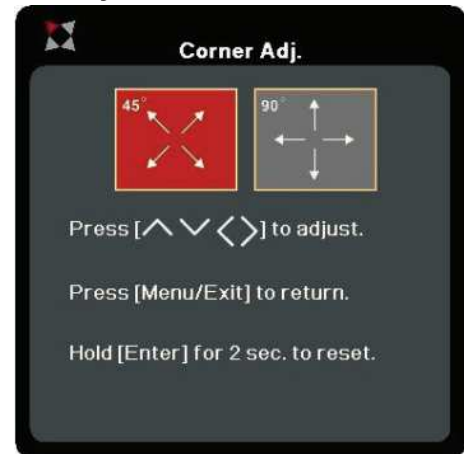

☞ **To display this page, press and hold [Enter] for 2 seconds to reset the settings for all 4 corners.**

Shows the corner that you have selected.



Zoom out for detailed review

You may need to expand the image to inspect details in the projected image. Use the arrow keys to move the images.

- Using the remote control
 1. Press the  on the remote to bring up the Zoom Bar.
 2. Press  repeatedly to expand the image to the desired dimension.
 3. To browse the image, press [Enter] to switch to displacement mode and use the arrow keys (, , , ) to move the image for browsing.
 4. To shrink the image, press [Enter] again to return to the Zoom In/Out function and press  repeatedly to restore the image to its original size. You can also press the [Auto Sync] button on the remote control to restore the image to its original size.
- Using the OSD menu
 1. Open the OSD menu to enter **Display > Zoom** menu.
 2. Press [Enter]. This will bring up the Zoom Slider.
 3. Repeat Steps 2-4 listed above in the Remote Control Use chapter.

 The image can only be inspected after zooming out. You can zoom out further to inspect details.

Selecting the aspect ratio

The 'aspect ratio' is the ratio of the image width to the image height. Most analog TV and computers have a 4:3 aspect ratio, while digital TV and DVDs have 16:9 aspect ratios.

With the advent of digital signal processing, digital display devices like this projector can dynamically stretch and scale the image output to a different aspect than that of the image input signal.

To change the projected image ratio (no matter what aspect the source is):

1. Open the OSD Menu and enter **Display > Aspect ratio** menu.
2. Press  to select an aspect ratio that suits the format of the video signal and your display requirements.

About the aspect ratio

 In the picture below, the black portions are inactive areas and the white portions are active areas. OSD menus can be displayed on those unused black areas.

1. **Auto:** Proportional scaling of an image to fit the projector's natural resolution in its horizontal width. This is suitable where the incoming image is neither in 4:3 nor 16:9 aspect ratios but where you want to make most use of the screen without altering the image's aspect ratio.

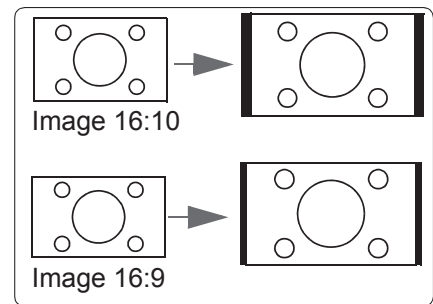

2. **4:3:** Scales a picture so that it is displayed in the center of the screen with a 4:3 aspect ratio. This is most suitable for 4:3 pictures such as those for computer monitors, standard definition TV, and 4:3 aspect DVD movies as these can be displayed without aspect alteration.

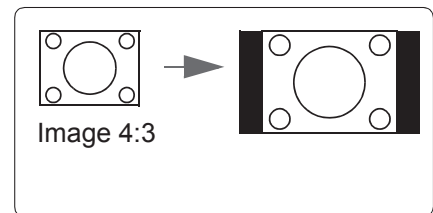

3. **16:9:** Scales a picture so that it is displayed in the center of the screen with a 16:9 aspect ratio. This is most suitable for images which are already in a 16:9 aspect such as high definition TV because as these can be displayed without aspect alteration.

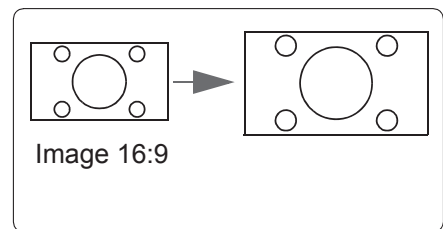

4. **2.35:1:** Scales a picture so that it is displayed at the center of the screen with a 2.35:1 aspect ratio without change.

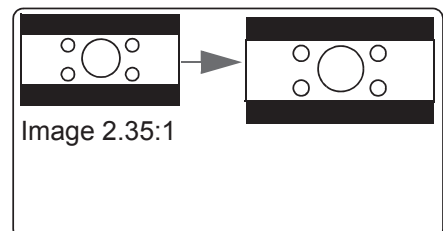

Optimizing the image

Selecting a picture mode

The projector is preset with several predefined picture modes. You may choose one of these modes that best fits your operating environment and input signal picture type.

To select an operation mode that suits your need, please follow the steps described below.

- Press [Color Mode] repeatedly until you arrive at the mode you desire.
- Enter **Display > Color mode** menu and press ◀/▶ to select the required mode.

Picture modes for different types of signals

The following lists the Picture modes that can be used for different signal types.

1. **Brightest:** Maximizes the brightness of the projected image. This mode is suitable when using projectors in environments such as well-lit rooms where extra-high brightness is required.
2. **Dynamic mode:** Used during daytime demonstration to match PC and notebook computer color tones. The projector will also refer to the projected contents and use dynamic PC functions to optimize image quality.
3. **Standard mode:** Used during daytime demonstration to match PC and notebook computer color tones.
4. **ViewMatch sRGB mode:** Switches between high brightness levels or precise color functions.
5. **Movie Mode:** Applicable for playing colored movies, video clips from digital cameras, or DVs from a PC input in darker (dim) environments to achieve the best viewing effects.

 The available light source modes will be based upon the selected color mode.

Using Screen Color

When the projection surface is colored (such as walls that are painted in colors other than white), the **Screen Color** function can be used to calibrate the color of the projected image in order to prevent color offsets between the source and color of the projected image.

To use this function, go to **Display > Screen Color** menu, and press ◀/▶ to select the color that is closest to that of the projection surface. Several preset color options are available, namely: **white board**, **green board** and **blackboard**. These setup functions may differ according to model type.

 This function is only available when PC or HDMI input signals were selected.

Fine-tuning of image quality in user modes

You may use several user-defined functions if the projector detects certain signal types. You can make adjustments to these functions based on your needs.

Adjusting Brightness

Enter **Display > Brightness** menu and then press ◀/▶.

The higher the value, the brighter the image. And lower the setting, darker the image.



Adjusting this control allows the black area of the image to appear just as black to reveal details within.

Adjusting Contrast

Enter **Display > Contrast** menu and then press ◀/▶.

The higher the value, the greater the contrast. After adjusting **brightness**, this function may be used to set the peak-white level that matches the input signal and observed environment of your choice.



Adjusting Color

Enter **Display > Advanced > Color** menu and press ◀/▶.

Lower settings produce less color saturation. If the setting is too high, colors on the image will be overpowering, which makes the image unrealistic.

☞ This function is only available when the input signals are S-Video, Video, YPbPr (digital) or YCbCr (digital).

Adjusting Tint

Enter **Display > Advanced > Tint** menu and then press ◀/▶.

The higher the value, the more reddish the picture becomes. The lower the value, the more greenish the picture becomes.

☞ This function is only available when the input signals are S-Video, Video, YPbPr (digital) or YCbCr (digital).

Adjusting Sharpness

Enter **Display > Advanced > Sharpness** menu and then press ◀/▶.

Higher settings produce sharper images. The lower the value, the softer the picture becomes.

☞ This function is only available when the input signals are S-Video, Video, YPbPr (digital) or YCbCr (digital).

Adjusting Brilliant Color

Enter **Display > Advanced > Brilliant Color** menu, and then press ◀/▶.

This feature utilizes a new color-processing algorithm and system level enhancements to enable higher brightness while providing truer, more vibrant colors of the projected image. Brightness levels of mid-tone areas commonly seen in videos and natural landscapes are increased by more than 50%, allowing the projector to generate images in realistic and true colors. To acquire this quality of images, please select the level you desire. If not required, set this option to **OFF**.

Reducing image noise

Enter **Display > Advanced > Noise Reduction** menu, and then press ◀/▶.

This function is capable of reducing image noise generated electrically by different media players. Higher settings will provide lower image noise.

☞ This function is only available when **PC, Video, or S-Video** input signals were selected.

Selecting a gamma setting

Enter **Display > Advanced > Gamma** menu, and then press ◀/▶ to choose the desired settings.

Gamma refers to the relationship between input source and image brightness.

Selecting a Color Temperature

Enter **Display > Color Temperature** menu, and then press ◀/▶.

Options available to Color Temperature settings will depend on the choice of the signal type.

1. **Cool**: Provides the highest color temperature. **Cool colors** allow the image to display white colors with the more blue undertones compared to other temperatures.
2. **Neutral**: White colors in the image will be provided with a light blue undertone.
3. **Normal**: Maintains a normal white color tone.
4. **Warm**: White colors in the image will be provided with a light red undertone.

Setting a preferred color temperature

1. Enter **Display > Color Temperature** menu.
2. Press ◀/▶ to select **Cool, Neutral, Normal** or **Warm**, and press [Enter].
3. Press ▲/▼ to select the item you wish to change, then press ◀/▶ to adjust its value.
 - **Red Gain/Green Gain/Blue Gain**: Adjusts the contrasts of the red, green, and blue colors.
 - **Red Offset/Green Offset/Blue Offset**: Adjusts the brightness of red, green, and blue colors.

Color Management

Only in permanent installations with controlled lighting levels such as boardrooms, lecture theaters, or home theaters, should color management be considered. Color management provides fine color control adjacent to allow for more accurate color reproduction, should you require it.

If you have purchased a test disc that contains various color test patterns that can be used to test the color presentation of monitors, TVs, and projectors, any image from the disc can be projected on screen and adjusted using the **Color Management** menu.

To adjust the settings:

1. Open the OSD menu, go to **Display > Advanced > Color Management** menu.
2. Press [Enter] to bring up the **Color Management** page.
3. Select **Original Color**, then press ◀/▶ and select any one of the colors from red, yellow, green, cyan, blue, or magenta.

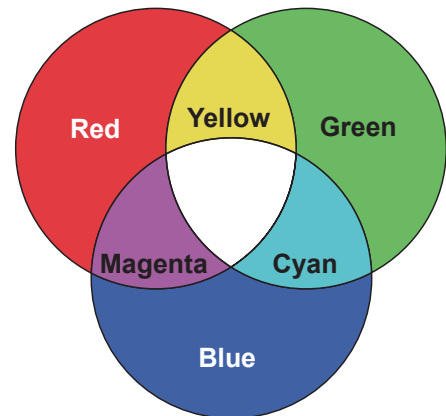



4. Press ▼ to select the **Tint**, then press ◀/▶ to select the range. Enlarging the range will include colors composed of higher proportions of 2 similar colors. Please refer to the illustration to the right for how the colors relate to each other. For example, if you select red and set the range to 0, you will only select pure red areas of the projected image. Increasing the range will include shades of red closer to yellow and magenta.
5. Press ▼ and select **Saturation**, then press ◀/▶ to adjust its values according to your preferences. The effect of each adjustment will be immediately reflected upon the image. For example, if you select Red and set its value at 0, only the saturation of pure red will be affected.

☞ **Saturation is the amount of that color in a video picture. Lower settings produce less saturated colors. A setting of 0 will remove that color from the image entirely. If the saturation is too high, that color will be overpowering and unrealistic.**



6. Press ▼ and select **Gain**, then press ◀/▶ to adjust its values according to your preferences. This affects the contrast level of the primary color selected. The effect of each adjustment will be immediately reflected upon the image.
7. Repeat steps 3 to 6 to carry out other color adjustments.
8. Make sure you have made all of the desired adjustments.
9. Press [Exit] to save the settings and exit.

Setting the Presentation Timer

The presentation timer can indicate the presentation time on-screen to help you achieve better time management when giving presentations. Follow these steps to utilize this function:

1. Use the remote control  and enter **Presentation Timer** menu or enter **Basic > Presentation Timer** menu.
2. Press [Enter] to show the **Presentation Timer** page.
3. Select **Timer Interval** and press   to confirm the duration. Duration can be set to 1 to 5 minutes, with 1 minute increments, or 5 to 240 minutes in 5 minute increments.

 Once the timer has been activated, resetting the timer interval will re-activate the timer.

4. Press  and select the **Timer Display**. Then press   to select whether to display or hide the on-screen timer.



Selection	Description
Always	Displays the timer on screen throughout the presentation time.
1 min/2 min/3 min	Display timer on-screen in the last 1 / 2 / 3 minutes.
Never	Hides the timer throughout the presentation time.

5. Press  and select **Timer Position**, and then press   to set timer location.

Upper left → Lower left → Upper right → Lower right

6. Press  to select **Timer Counting Direction**, then press   to select the required timer method.

Selection	Description
Count Up	Increases from 0 to the preset time.
Count Down	Decrease from the preset time to 0.

7. To activate Presentation Timer, press , then press   and select **Begin Countdown**, then press [Enter].
8. A confirmation message will be displayed next. Select **Yes** and press [Enter] to confirm the selection. The screen will display the message **[Timer is On!]**. Once activated, the timer will start its countdown.

To cancel the timer, perform the following steps:

1. Enter **Basic > Presentation Timer** menu.
2. Select **OFF**. Press [Enter]. A confirmation message will be displayed afterwards.
3. Select **Yes** and press [Enter] to confirm the selection. The screen will display the message **[Timer is Off!]**.

Hiding the image

In order to draw the audience's attention to the presenter, you may press Blank to hide the screen image. Press any key on the projector or remote to restore the image. After hiding the image, the lower right corner of the screen will display the text **[BLANK]**.

You can go to **Basic > Blank Timer** menu to set blank screen duration. Once the blank screen countdown is complete, the image will be automatically re-displayed.

 After pressing [Blank], the projector will automatically enter Power Saving mode.







Caution

Do not block the projector lens. The blocking item may be heated to the point of deformation or may even cause a fire.

Locking control keys

Locking the control buttons of the projector allows you to prevent projector settings from being changed accidentally (by children, for example). Once **Panel Key Lock** has been activated, with the exception of the  Power button, none of the buttons on the Projector could be used.

1. Press  (**Panel Key Lock**) or enter **System Settings > Panel Key Lock** menu.
2. Press /  and select **ON**.
3. A confirmation message will be displayed next. Select **Yes** to confirm your choice. To switch off the Panel Key Lock, press and hold the  button on the Projector for 3 seconds.

You may also use the remote to enter **System Settings > Panel Key Lock** menu, press /  and select **OFF**.

 Buttons on the remote control can still be used even if the Panel Key Lock function has been switched on.

 If you press the  Power button to switch off the projector without switching off the Panel Key Lock function, the projector buttons will remain locked when you switch it on the next time.

Creating your own startup screen

In addition to **Black**, **Blue**, or **ViewSonic** screens, you may also select a computer or video projection image as your startup screen.

To create your own startup screen:

1. Select the desired startup screen image from your computer or video source.
2. Open the OSD menu and enter **Basic > Screen Capture** menu.
3. Press [Enter].
4. A confirmation message will be displayed next. Press [Enter] again.
5. While the projector processes the image, the screen will display the message [Screen Capture in Progress...]. Please wait.
6. When successful, the screen will display the message [Screen Capture Success]. The captured image will be saved as a **Screen Capture** and set as your current startup screen.

In the unlikely event that the capturing action fails, change your target picture. When it happens, please set the resolution of the input signal under native resolution and try again.

Operations at high altitudes

We recommend using the **High Altitude Mode** when the environment is at 1500 to 3000 meters above sea level and the temperature is between 5°C to 25°C.



Caution

Do not activate High Altitude Mode if the environment is at 0 to 1500 meters above sea level and the temperature is between 5°C to 35°C.

Activating High Altitude Mode under such circumstances will lead to excessive cooling of the projector.

Activating **High Altitude Mode**:

1. Open the OSD menu and enter **System Settings > High Altitude Mode** menu.
2. Press ▼ and select **ON**. ◀/▶ will display a confirmation message.
3. Select **Yes**, and then press [Enter].

There is a chance that louder operational noises will be generated when using the projector in **High Altitude Mode**. The reason for this is the increased fan speed necessary to improve overall system cooling and performance.

Using this projector under extreme environments that exceed the aforementioned limits may lead to auto-shutdown designed to prevent overheating of the projector. Under such circumstances, you should switch to **High Altitude Mode** to solve these issues. However, this does not mean that this projector is able to operate under any and all harsh or extreme conditions.

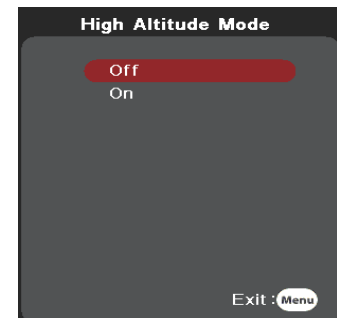

Using the CEC function

This projector supports Consumer Electronics Control (CEC), allowing you to connect to connect to HDMI and achieve synchronized power ON/OFF operations. This means that when a device that also supports CEC is connected to the HDMI input jack of the projector, switching off the power of the projector will also automatically switch off the power of the connected device. Switching on the power of the connected device will also automatically switch on the projector.

Activating the CEC function:

1. Open the OSD menu and enter **Power management > Auto Power On > CEC** menu.
2. Press ◀/▶ and select **Enable**.

 To ensure proper operations of the CEC function, please verify that the target device has been connected to the HDMI input jack via an HDMI cable and that the CEC function has been activated.

 CEC function may not be usable according to the connected equipment.

3D functions

This projector also comes with 3D functions that offer greater depth and immersion when viewing 3D movies, videos, sports, and games. You would need a pair of 3D glasses when viewing 3D images and videos.

If the 3D signal comes from an HDMI 1.4a compatible device, this projector will look for a 3D Sync data signal. Once detected, the projector will automatically switch to 3D projection. Under other circumstances, you may need to manually select the 3D Sync format to ensure that the proper projection of 3D images.

Selecting 3D Sync formats:

1. Use the 3D button on the remote control to enter the **3D Settings** menu or enter **Advanced > 3D Settings** menu.
2. Press [Enter] to bring up the **3D Settings** page.
3. Highlight **3D Glasses** and press ◀/▶ to select **DLP** or **3D VESA**.

 Once 3D Sync function has been activated:

- Brightness of the projected image will be reduced.
- Color modes cannot be adjusted.
- Zoom functions can only enlarge the image to a limited degree.

If the 3D image has been severely inverted, you may set the 3D Sync Invert function to [Invert] to correct this problem.

Using the projector under standby mode

A number of projector functions can be used under Standby Mode (plugged in to power but not switched on). To use these functions, please check that you have switched on the **Power management > Standby Settings** and its secondary menu items, and that the cables have been properly connected. Refer to the chapter on cable connections for more information on cable connections.

Active VGA Out

Once the COMPUTER IN and COMPUTER OUT jacks have been properly connected to the corresponding devices, select **ON** to generate VGA signal output. The projector will only receive output signals via Computer In 1.

Active Audio Out

When the AUDIO IN jack is correctly connected to a device, select **ON** to output audio signals.

Adjusting the sound

The sound adjustments made as below will have an effect on the projector speaker(s). Please check that you have made a correct connection to the projector audio input / output jacks. See “[Connection](#)” for details.

Adjustments in Audio Mode

1. Open the OSD menu and enter **Basic > Audio Settings > Audio Mode** menu.
2. Press ◀/▶ to select the primary Audio Mode.

 If available, you may press the [Audio Mode] on the remote control to select the primary Audio mode.

Mute

1. Open the OSD menu and enter **Basic > Audio Settings > Mute** menu.
2. Press ◀/▶ and select **ON**.



 If available, you may press the  button on the remote control to switch the projector audio ON or OFF.

Adjusting the sound level

1. Open the OSD menu and enter **Basic > Audio Settings > Audio Volume** menu.
2. Press ◀/▶ to select the desired volume.

 If available, you may press the  button on the remote control to adjust speaker volume of the projector.

Switch off the projector

1. Press the  Power button. A confirmation message will be displayed on screen. The message will disappear if you do not respond within a few seconds.
2. Press the  Power button again.
3. Disconnect the power cord from the wall socket if the projector will not be used in an extended period of time.

Menu operations

Menu system

Please note that the on-screen display (OSD) menu may vary according to the type of signal received.







The projector must detect at least one valid signal in order to use the menu items. If no device has been connected to the projector or if no signal has been detected, only a few menu items will be accessible.

Main menu	Sub-menu	Options		
1. Display	Screen Color	Off/Blackboard/Greenboard/Whiteboard		
	Aspect Ratio	Auto/4:3/16:9/16:10/2.35:1		
	Keystone	Auto V Keystone	Off/On	
		Manual	Vertical/Horizontal	
	Corner Adj.			
	Position			
	Phase			
	H. Size			
	Zoom			
OverScan		Off/1/2/3/4/5		
2. Picture	Color mode	Brightest/Dynamic/Standard/ViewMatch sRGB/Movie		
	Brightness			
	Contrast			
	Color Temperature	Warm	Red Gain/Green Gain/Blue Gain/Red Offset/Green Offset/Blue Offset	
		Normal		
		Neutral		
		Cool		
	Advanced	Color		
		Tint		
		Sharpness		
		Gamma	1/2/3/4/5/6/7/8	
		Brilliant Color	Off/1/2/3/4/5/6/7/8/9/10/13	
		Noise Reduction		
		Color Management	Primary color	
			Tint	
Saturation				
Gain				
Reset color settings		Restore/Cancel		



Main menu	Sub-menu	Options	
3. Power Management	Auto Power On	Computer	Disable/Enable
		CEC	Disable/Enable
		Direct power on	Off/On
	Smart Energy	Auto Power Off	Disable/10 min/20 min/30 min
		Sleep Timer	Disable/30 min/1 hr/2 hr/3 hr/4 hr/8 hr/12 hr
		Power saving	Disable/Enable
	MHL settings	Power Out	MHL/USB-TYPE A
		MHL reset	Restore/Cancel
	Standby Settings	Active VGA Out	Off/On
		Active Audio Out	Off/On
4. Basic	Audio Settings	Audio Mode	Standard/Speech/Entertainment
		Mute	On/Off
		Volume	
	Presentation Timer	Timer Period	1~240 m
		Timer Display	Always/1 min/2 min/3 min
		Timer Position	Top-Left/Bottom-Left/Top-Right//Bottom-Right
		Timer Counting Direction	Count Down/Count Up
		Start Counting/Off	
	Pattern		Off / 1/ 2/ 3
	Blank Timer		Disable/5 min/10 min/15 min/20 min/25 min/30 min
	Message		On/Off
	Splash Screen		Black/Blue/ViewSonic/Screen Capture/Off
	Screen Capture		
My Button	Auto/Projection (Projector Position)/Menu Position/Color Temp./Brightness/Contrast/3D Settings/Screen Color/Splash Screen/Message/Quick Auto Search/CEC/DCR/Closed Caption/Power Saving/Freeze/INFORMATION/Aspect Ratio/Power Out		



Main menu	Sub-menu	Options	
5. Advanced	3D Settings	3D Glasses	DLP/3D VESA
		3D Sync	Auto/Off/Frame Sequential/ Frame Packing/Top-Bottom/ Side-by-Side
		3D Sync Invert	Disable/Invert
	HDMI Settings	HDMI Format	Auto/RGB/YUV
		HDMI Range	Auto/Enhanced/Normal
	LAN Control Settings	LAN Control Settings	DHCP ON/Static IP
		Projector IP Address	
		Subnet Mask	
		Default Gateway	
		DNS Server	
		Standby LAN Control	Off/On
		Apply	
	Light Source Settings	Light Source Mode	Normal/Eco
DCR		On/Off	
Closed Caption	Caption Version	Off/ CC1/ CC2/ CC3/ CC4	
Reset Settings		Reset/Cancel	
5. System	Language	Multi-language OSD selection	
	Projector Position	Front Table/Rear Table/Rear Ceiling/Front Ceiling	
	Menu Settings	Menu Display Time	5 sec/10 sec/15 sec/20 sec/25 sec/30 sec
		Menu Position	Center/Top-Left/Top-Right/ Bottom-Left/Bottom-Right
	High Altitude Mode	On/Off	
	Quick Auto Search	On/Off	
	Security Settings	Change Password	
		Power On Lock	On/Off
	Panel Key Lock	On/Off	
Remote Control Code		1/2/3/4/5/6/7/8	
6. Information	<ul style="list-style-type: none"> • Source • Color Mode • Resolution • Color System • IP Address • MAC Address • Firmware Version 		

Description of each menu

	FUNCTION	Description
1. Display menu	Screen Color	See “Using Screen Color” for details.
	Aspect Ratio	See “Selecting the aspect ratio” for details.
	Keystone	See “Correcting keystone” for details.
	Corner Adj.	See “Adjusting the 4 corners” for details.
	Position	<p>Displays the position adjustment page. To move the projected image, use the directional arrow keys. The values shown on the lower position of the page change with every key press you made until they reach their maximum or minimum.</p> <p> This function is only available when a PC input signal is selected.</p> <p> The adjustment range may vary under different timings.</p>
	Phase	<p>Adjusts the clock phase to reduce image distortion.</p>  <p> This function is only available when a PC input signal is selected.</p>
	H. Size	<p>Adjusts the horizontal width of the image.</p> <p> This function is only available when a PC input signal is selected.</p>
	Zoom	See “Magnifying and searching for details” for details.
2. Image menu	OverScan	<p>Adjusts the overscan rate from 0% to 5%.</p> <p> This function is only available when a Composite Video, S-Video or HDMI input signal is selected.</p>
	Color mode	See “Selecting a picture mode” for details.
	Brightness	See “Adjusting Brightness” for details.
	Contrast	See “Adjusting Contrast” for details.
	Color Temperature	For more details, please refer to “Selecting a Color Temperature” and “Setting a preferred color temperature” .

	FUNCTION	Description
2. Image menu	Advanced	<p>Color See “Adjusting Color” for details.</p> <p>Tint See “Adjusting Tint” for details.</p> <p>Sharpness See “Adjusting Sharpness” for details.</p> <p>Gamma See “Selecting a gamma setting” for details.</p> <p>Brilliant Color See “Adjusting Brilliant Color” for details.</p> <p>Noise Reduction See “Reducing image noise” for details.</p> <p>Color Management See “Color Management” for details.</p>
	Reset color settings	Returns all color settings to the factory preset values.
3. Power Management menu	Auto Power On	<p>Computer Selecting Enable allows the projector to turn on automatically once the VGA signal is fed through the VGA cable.</p> <p>CEC See “Using the CEC function” for details.</p> <p>Direct power on Selecting On allows the projector to turn on automatically once the power is fed through the power cord.</p>
	Smart Energy	<p>Auto Power Off See “Setting Auto Power Off” for details.</p> <p>Sleep Timer See “Setting Sleep Timer” for details.</p> <p>Power Saving See “Setting Power Saving” for details.</p>
	MHL Settings	<p>Please check your MHL dongle and Power Output of OSD settings before used.</p> <p>If you'd like to have power charging through additional USB-type A, make sure to switch the Power Output from MHL to USB-type A.</p> <p>MHL Reset Selecting Reset to reapply power after a power outage.</p>

	FUNCTION	Description
4. Basic Menu	Audio Settings	See “ Adjusting the sound ” for details.
	Presentation Timer	See “ Setting the presentation timer ” for details.
	Pattern	The projector can display several test patterns. It helps you adjust the image size and focus and check that the projected image is free from distortion.
	Blank Timer	See “ Hiding the image ” for details.
	Message	Selecting On displays the current information on the screen when the projector is detecting or searching for a signal.
	Splash Screen	Allows you to select which logo screen will be displayed during projector start-up.
	Screen Capture	See “ Creating your own startup screen ” for details.
	My buttons	Sets a hotkey on remote control.
5. Advanced menu	3D Settings	See “ Using the 3D functions ” for details.
	HDMI Settings	See “ Changing HDMI input settings ” for details.
	Audio Setup	See “ Adjusting the sound ” for details.
	LAN Control Settings	See “ Controlling the projector through a LAN environment ” for details.
	Light Source Settings	<p>Light Source Mode</p> <p>See “Setting Light Source Mode” for details.</p> <p>Light Source Hours</p> <p>See “Getting to know the Light Source hour” for details on how the total Light Source hour is calculated.</p>
	DCR	<p>Enables or disables the DCR (Dynamic Contrast Ratio) function. Selecting On enables the function and the projector will automatically switch the Light Source mode between normal and economic modes according to the input image detected.</p> <p> This function is only available when a PC input signal is selected.</p> <p> After enabling DCR, frequent Light Source mode switching may shorten Light Source life and noise level will vary during operation.</p>

	FUNCTION	Description
5. Advanced menu	Closed Caption	<p>Selects a preferred closed captioning mode when the selected input signal carries closed captions.</p> <ul style="list-style-type: none"> • Captions: An on-screen display of the dialogue, narration, and sound effects of TV programs and videos that are closed captioned (usually marked as “CC” in TV listings). <p> This function is only available when a Composite video or S-Video input signal is selected and its system format is NTSC.</p> <p>Caption Version</p> <p>To view captions, select CC1, CC2, CC3, or CC4 (CC1 displays captions in the primary language in your area).</p>
	Reset Settings	<p>Returns all settings to the factory preset values.</p> <p> The following settings will still remain: Keystone / Corner Adj. / Language/ Projector Position/ Altitude/ Security Settings/ Remote Control Code</p>
6. SYSTEM menu	Language	Sets the language for the On-Screen Display (OSD) menus. See “Using the menus” for details.
	Projector Position	See “Choosing a location” for details.
	Menu Settings	<p>Menu Display Time</p> <p>Sets the length of time the OSD will remain active after your last key press. The range is from 5 to 30 seconds in 5-second increments.</p> <p>Menu Position</p> <p>Sets the On-Screen Display (OSD) menu position.</p>
	High Altitude Mode	A mode for operation in high altitude areas. See “Operating in a high altitude environment” for details.
	Quick Auto Search	See “Switching input signal” for details.
	Security Settings	See “Utilizing the password function” for details.
	Panel Key Lock	See “Locking control keys” for details.
	Remote Control Code	See “Remote control code” for details.

	FUNCTION	Description
6. Information menu	Current System Status	<p>Source Shows the current signals source.</p> <p>Color mode Shows the selected mode in the Image menu.</p> <p>Resolution Shows the native resolution of the input signal.</p> <p>Color System Shows the input system format.</p> <p>IP Address Shows the IP address of your projector.</p> <p>MAC Address Shows the MAC Address of your projector.</p> <p> MAC Address stands for Media Access Control Address, which is a physical layer address used to uniquely identify a network node.</p> <p>Firmware Version Shows the current firmware version.</p>

Maintenance

Care of the projector

You must regularly clean the lens and/or filter.

Do not attempt to disassemble any part of the projector. Contact your dealer if you need to replace any parts.

Cleaning the lens

You can clean the dust-free glass lens if you notice any dirt or dust on its surface.

- Use a canister of compressed air to remove dust.
- Use a lens cleaning wipe or soft, or a moist cloth with some detergent to clean away any dust or dirt on the dust-free glass.



Note

Do not apply any granule material on the dust-free glass.

Cleaning the projector case

Before cleaning the case, please refer to the proper shutdown procedure described in [“Switch off the projector”](#) to shutdown the projector and unplug the power cable.

- To remove dirt or dust, wipe the case with a soft, lint-free cloth.
- To remove stubborn dirt or stains, moisten a piece of soft cloth with water and a neutral pH detergent. Then wipe the case.



Note

Never use wax, alcohol, benzene, thinners, or other chemical-based detergents. These can damage the case.

Storing the projector

Follow the instructions below to store the projector for an extended time:

- Make sure the temperature and humidity of the storage area are within the recommended range for the projector. Please refer to [“Specifications”](#) or inquire your dealer for details of the recommended range.
- Retract the projector support pegs.
- Remove the battery from the remote control.
- Pack the projector in its original packaging or equivalent material.

Transporting the projector

It is recommended that you ship the projector within its original packaging or equivalent material.

Using the filter

 **Note**

- we recommend cleaning the filters when using projector for a while.
- If the projector is suspended from the ceiling or mounted in a way that is difficult to access, please be mindful of personal safety during filter replacement.

Cleaning the filters

1. Make sure that the projector has been shut down and unplugged from the power source.
2. Press the latch pin on the filter and removed the filter from the projector.
3. Use a small vacuum cleaner or soft brush to remove dust from the filter.
4. Reinstall the filter.

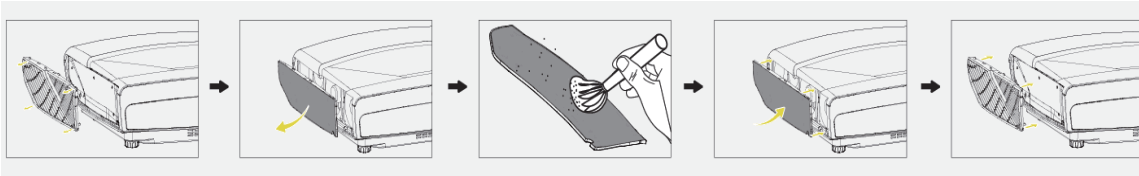

LED Indicator

Projector status	Power indicator	Status* indicator
Stand-by Mode	Red	Off
Powering On	Red flashing two second , purple flashing three second then Blue flashing 4 second	Off
Normal Operations	Blue	Off
Normal Shut Down	Blue flashing	Off
Fan Error	Off	Red flashing
Temperature	Off	Red
DMD	Blue flashing twice per second	Red flashing twice per second
Projector Status: Color Wheel Error	Power Indicator : Blue flashing once per second /	Red flashing twice per second
LD start failed	Blue flashing	Red flashing
LD shut down	Blue	Red flashing
Stand-by Mode (enable standby setting on OSD)	blue flashing by five second	Off

Troubleshooting

② Projector is not shutting down

Cause	Remedy
There is no power from the power cable.	Plug one end of the power cable at the AC inlet of the projector and the other end in the power outlet. If the power outlet has a switch, make sure that it is switched on.
Attempting to turn the projector on again during the cooling process.	Wait until the cooling down process has completed.

② No picture

Cause	Remedy
Video source is not turned on or is not connected correctly.	Switch the video source on and check that the signal cable is connected correctly.
The projector is not correctly connected to the input signal device.	Check the connection.
The input signal has not been correctly selected.	Select the correct input signal by using the [Source] key on the projector or remote control.

② Blurred image

Cause	Remedy
The projection lens is not correctly focused.	Use the focus function to adjust lens focus.
The projector and the screen are not aligned properly.	Adjust projection angle and direction as well as the height of the projector where necessary.

② Remote control does not work

Cause	Remedy
The battery is out of power.	Replace the batteries.
There is an obstacle between the remote control and the projector.	Remove the obstacle.
You are too far away from the projector.	Stand within 8 meters (26 feet) of the projector.
The remote control does not match the remote control code of the projector.	Adjust the remote control code.

Specifications

Projector specifications

- All specifications are subject to change without notice.
- Not all projector models are available at your location.

		L810	L820	L830
Input Terminals				
1	VGA Input (DB 15 pin)	x2	x2	x2
2	Audio Input (mini jack)	x1	x1	x1
3	Audio L/R (RCA x 2 Composite)	x1	x1	x1
4	HDMI (v1.4 with audio)	x1	x1	x1
5	HDMI 1.4/MHL 2.0	x1	x1	x1
6	Video (RCA)	x1	x1	x1
7	S-video(Mini DIN 4 pin)	x1	x1	x1
8	Component (RCAx3)	x1	x1	x1
9	3D sync (IR3D)	x1	x1	x1
Output Terminals				
1	VGA output (DB 15pin)	x1	x1	x1
2	Audio Ouput (mini jack)	x1	x1	x1
3	12 V Trigger	x1	x1	x1
4	USB 5V2A (micro USB cable on Dongle)	x1	x1	x1
5	USB A 5V2A	x1	x1	x1
6	Speaker	10W x1	10W x1	10W x1
Control Terminals				
1	RS232 (9 pin type1)	x1	x1	x1
2	USB (Type mini B) 5V2A	x1	x1	x1
3	LAN Control(RJ45)	x1	x1	x1

Dimensions

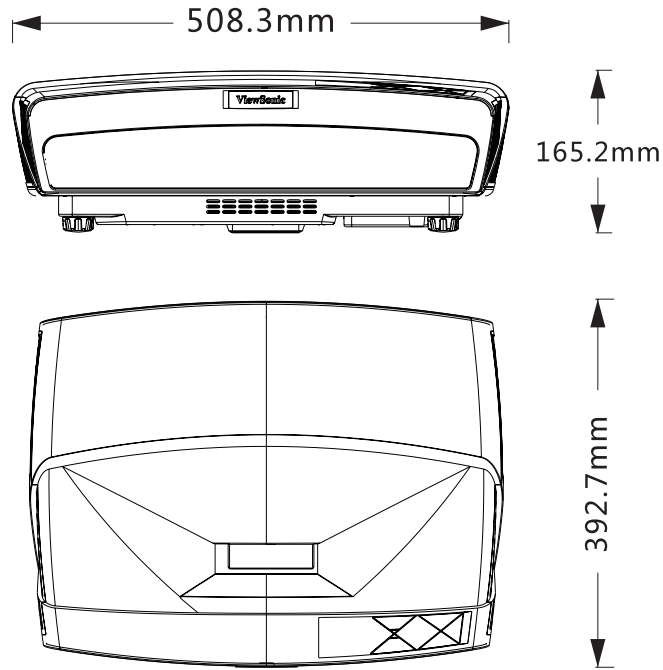

Ceiling mount installation

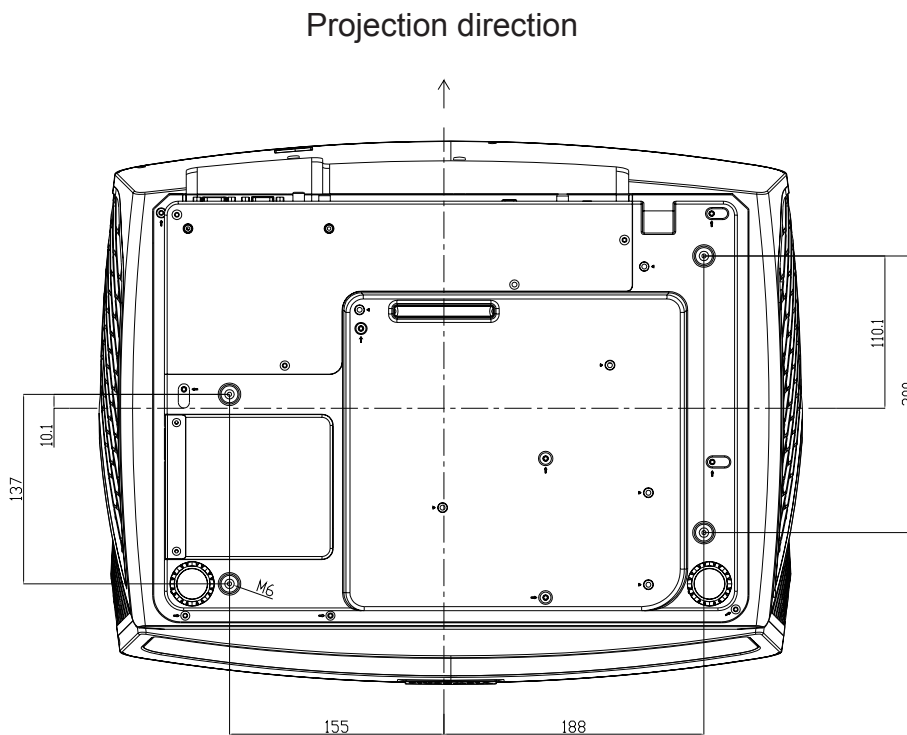

Note: M6L12 screws are recommended for securing the projector using suspended mounting M6 screw holes. (M6 / L12 x 4)

Timing chart

Analog RGB			
Signal	Resolution (pixels)	Aspect Ratio	Refresh rate (Hz)
VGA	640x480	4:3	60/72/75/85
SVGA	800x600	4:3	60/72/75/85
XGA	1024x768	4:3	60/70/75/85
	1152x864	4:3	75
WXGA	1280x768	15:9	60
	1280x800	16:10	60/75/85
	1360x768	16:9	60
Quad-VGA	1280x960	4:3	60/85
SXGA	1280x1024	5:4	60
SXGA+	1400x1050	4:3	60
WXGA+	1440x900	16:10	60
UXGA	1600x1200	4:3	60
WSXGA+	1680x1050	16:10	60
HD	1280x720	16:9	60
MAC 13"	640x480	4:3	67
MAC 16"	832x624	4:3	75
MAC 19"	1024x768	4:3	75
MAC 21"	1152x870	4:3	75
HDTV (1080p)	1920x1080	16:9	60

HDMI			
Signal	Resolution (pixels)	Aspect Ratio	Refresh rate (Hz)
VGA	640x480	4:3	60
SVGA	800x600	4:3	60
XGA	1024x768	4:3	60
WXGA	1280x768	15:9	60
	1280x800	16:10	60
	1360x768	16:9	60
Quad-VGA	1280x960	4:3	60
SXGA	1280x1024	5:4	60
SXGA+	1400x1050	4:3	60
WXGA+	1440x900	16:10	60
WSXGA+	1680x1050	16:10	60
HDTV(1080p)	1920x1080	16:9	50/60
HDTV (1080i)	1920x1080	16:9	50/60
HDTV (720p)	1280x720	16:9	50/60
SDTV(480p)	720x480	4:3/16:9	60
SDTV(576p)	720x576	4:3/16:9	50
SDTV (480i)	720x480	4:3/16:9	60
SDTV (576i)	720x576	4:3/16:9	50

3D (including HDMI signal)			
Signal	Resolution (pixels)	Aspect Ratio	Refresh rate (Hz)
SVGA	800x600	4:3	60*/120**
XGA	1024x768	4:3	60*/120**
HD	1280x720	16:9	60*/120**
WXGA	1280x800	16:9	60*/120**
For Video Signal			
Signal	Resolution (pixels)	Aspect Ratio	Refresh rate (Hz)
SDTV (480i)***	720x480	4:3/16:9	60
<p> * 60 Hz signals are supported for parallel, up-down, and frame sequence formats. ** 120Hz signals are only supported for frame sequence formats. *** Video signal (SDTV 480i) is only supported for frame sequence formats.</p>			

HDMI 3D			
Within frame packing formats			
Signal	Resolution (pixels)	Aspect Ratio	Refresh rate (Hz)
1080p	1920x1080	16:9	23.98/24
720p	1280x720	16:9	50/59.94/60
Within parallel formats			
Signal	Resolution (pixels)	Aspect Ratio	Refresh rate (Hz)
1080i	1920x1080	16:9	50/59.94/60
Within top-down formats			
Signal	Resolution (pixels)	Aspect Ratio	Refresh rate (Hz)
1080p	1920x1080	16:9	23.98/24
720p	1280x720	16:9	50/59.94/60

Component video			
Signal	Resolution (pixels)	Aspect Ratio	Refresh rate (Hz)
HDTV (1080p)	1920x1080	16:9	50/60
HDTV (1080i)	1920x1080	16:9	50/60
HDTV (720p)	1280x720	16:9	50/60
SDTV (480p)	720x480	4:3/16:9	60
SDTV (576p)	720x576	4:3/16:9	50
SDTV (480i)	720x480	4:3/16:9	60
SDTV (576i)	720x576	4:3/16:9	50

Composite video		
Signal	Aspect Ratio	Refresh rate (Hz)
NTSC	4:3	60
PAL	4:3	50
PAL60	4:3	60
SECAM	4:3	50

Copyright information

Copyright

Copyright 2015 All rights reserved. No part of this publication may be reproduced, transmitted, transcribed, stored in a retrieval system or translated into any language or computer language, in any form or by any means, electronic, mechanical, magnetic, optical, chemical, manual or otherwise, without the prior written permission of ViewSonic.

Disclaimer

ViewSonic does not make any statement or warranty, expressed or implied, for the merchantability and fitness for a particular purpose with respect to any contents within this manual. Additionally, ViewSonic reserves the right to revise and update the contents of this manual without notice.

*DLP and Digital Micromirror Device (DMD) are trademarks of Texas Instruments. Other names would be the copyrights of the respective companies or organizations.

Appendix

IR control table

Button	Format	Byte1	Byte2	Byte3	Byte4
PgDn	NEC	X3	F4	05	FA
PgUp	NEC	X3	F4	06	F9
Blank	NEC	X3	F4	07	F8
Auto sync	NEC	X3	F4	08	F7
Up	NEC	X3	F4	0B	F4
Down	NEC	X3	F4	0C	F3
Left	NEC	X3	F4	0E	F1
Right	NEC	X3	F4	0F	F0
Color Mode	NEC	X3	F4	10	EF
Mute	NEC	X3	F4	14	EB
Enter	NEC	X3	F4	15	EA
Power ON	NEC	X3	F4	17	E8
Presentation Timer	NEC	X3	F4	27	D8
Exit	NEC	X3	F4	28	D7
Eco Mode	NEC	X3	F4	2B	D4
Menu	NEC	X3	F4	30	CF
Mouse	NEC	X3	F4	31	CE
Mouse Left	NEC	X3	F4	36	C9
Mouse Right	NEC	X3	F4	37	C8
Source	NEC	X3	F4	40	BF
Pattern	NEC	X3	F4	55	AA
My button	NEC	X3	F4	56	A9
HDMI	NEC	X3	F4	58	A7
Volume+	NEC	X3	F4	82	7D
Volume-	NEC	X3	F4	83	7C
Magnify	NEC	X3	F4	18	e7
Aspect	NEC	83	F4	13	EC
Video	NEC	83	F4	9F	60
Audio Mode	NEC	X3	F4	9E	61
COMP	NEC	X3	F4	41	be
Panel Key Lock	NEC	X3	F4	8E	71
Help	NEC	X3	F4	21	DE

Address Code

Code 1	83F4
Code 2	93F4
Code 3	A3F4
Code 4	B3F4
Code 5	C3F4
Code 6	D3F4
Code 7	E3F4
Code 8	F3F4

RS232 command table

< Pin assignment for this two end >

Pin	Description	Pin	Description
1	NC	2	RX
3	TX	4	NC
5	GND	6	NC
7	RTSZ	8	CTS _Z
9	NC		

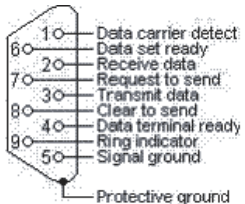

< Interface >

RS-232 protocol	
Baud Rate	19200bps (default)
Data Length	8 bit
Parity check	None
Stop bit	1 bit
flow control	None

<RS232 Command List >

FUNCTION	Status	Operation	cmd
Power supply	Write	Activate	0x06 0x14 0x00 0x04 0x00 0x34 0x11 0x00 0x00 0x5D
		Off	0x06 0x14 0x00 0x04 0x00 0x34 0x11 0x01 0x00 0x5E
	Read	Power status (ON/OFF)	0x07 0x14 0x00 0x05 0x00 0x34 0x00 0x00 0x11 0x00 0x5E
Reset All Settings		Execute	0x06 0x14 0x00 0x04 0x00 0x34 0x11 0x02 0x00 0x5F
Reset color settings		Execute	0x06 0x14 0x00 0x04 0x00 0x34 0x11 0x2A 0x00 0x87
Splash Screen	Write	Splash Screen - Black	0x06 0x14 0x00 0x04 0x00 0x34 0x11 0x0A 0x00 0x67
		Splash Screen - Blue	0x06 0x14 0x00 0x04 0x00 0x34 0x11 0x0A 0x01 0x68
		Splash Screen - ViewSonic	0x06 0x14 0x00 0x04 0x00 0x34 0x11 0x0A 0x02 0x69
		Splash Screen - Screen Capture	0x06 0x14 0x00 0x04 0x00 0x34 0x11 0x0A 0x03 0x6A
		Splash Screen - OFF	0x06 0x14 0x00 0x04 0x00 0x34 0x11 0x0A 0x04 0x6B
	Read	Splash Screen status	0x07 0x14 0x00 0x05 0x00 0x34 0x00 0x00 0x11 0x0A 0x68
Quick Power Off	Write	Quick Power Off OFF	0x06 0x14 0x00 0x04 0x00 0x34 0x11 0x0B 0x00 0x68
		Quick Power Off ON	0x06 0x14 0x00 0x04 0x00 0x34 0x11 0x0B 0x01 0x69
	Read	Quick Power Off status	0x07 0x14 0x00 0x05 0x00 0x34 0x00 0x00 0x11 0x0B 0x69
High Altitude Mode	Write	High Altitude Mode OFF	0x06 0x14 0x00 0x04 0x00 0x34 0x11 0x0C 0x00 0x69
		High Altitude Mode ON	0x06 0x14 0x00 0x04 0x00 0x34 0x11 0x0C 0x01 0x6A
	Read	High Altitude Mode status	0x07 0x14 0x00 0x05 0x00 0x34 0x00 0x00 0x11 0x0C 0x6A
light source Mode	Write	Normal	0x06 0x14 0x00 0x04 0x00 0x34 0x11 0x10 0x00 0x6D
		Eco	0x06 0x14 0x00 0x04 0x00 0x34 0x11 0x10 0x01 0x6E
	Read	light source Mode status	0x07 0x14 0x00 0x05 0x00 0x34 0x00 0x00 0x11 0x10 0x6E
Message	Write	Message OFF	0x06 0x14 0x00 0x04 0x00 0x34 0x11 0x27 0x00 0x84
		Message ON	0x06 0x14 0x00 0x04 0x00 0x34 0x11 0x27 0x01 0x85
	Read	Message status	0x07 0x14 0x00 0x05 0x00 0x34 0x00 0x00 0x11 0x27 0x85

Projector Position	Write	Front Table	0x06 0x14 0x00 0x04 0x00 0x34 0x12 0x00 0x00 0x5E
		Rear Table	0x06 0x14 0x00 0x04 0x00 0x34 0x12 0x00 0x01 0x5F
		Real ceiling	0x06 0x14 0x00 0x04 0x00 0x34 0x12 0x00 0x02 0x60
		Front ceiling	0x06 0x14 0x00 0x04 0x00 0x34 0x12 0x00 0x03 0x61
	Read	Projector Position status	0x07 0x14 0x00 0x05 0x00 0x34 0x00 0x00 0x12 0x00 0x5F
3D Sync	Write	Off	0x06 0x14 0x00 0x04 0x00 0x34 0x12 0x20 0x00 0x7E
		Auto	0x06 0x14 0x00 0x04 0x00 0x34 0x12 0x20 0x01 0x7F
		Frame Sequential	0x06 0x14 0x00 0x04 0x00 0x34 0x12 0x20 0x02 0x80
		Frame Packing	0x06 0x14 0x00 0x04 0x00 0x34 0x12 0x20 0x03 0x81
		Top-Bottom	0x06 0x14 0x00 0x04 0x00 0x34 0x12 0x20 0x04 0x82
		Side-by-Side	0x06 0x14 0x00 0x04 0x00 0x34 0x12 0x20 0x05 0x83
	Read	3D Sync Status	0x07 0x14 0x00 0x05 0x00 0x34 0x00 0x00 0x12 0x20 0x7F
3D Sync Invert	Write	Off	0x06 0x14 0x00 0x04 0x00 0x34 0x12 0x21 0x00 0x7F
		On	0x06 0x14 0x00 0x04 0x00 0x34 0x12 0x21 0x01 0x80
	Read	3D Sync Invert Status	0x07 0x14 0x00 0x05 0x00 0x34 0x00 0x00 0x12 0x21 0x80
Contrast	Write	Contrast decrease	0x06 0x14 0x00 0x04 0x00 0x34 0x12 0x02 0x00 0x60
		Contrast increase	0x06 0x14 0x00 0x04 0x00 0x34 0x12 0x02 0x01 0x61
	Read	Contrast	0x07 0x14 0x00 0x05 0x00 0x34 0x00 0x00 0x12 0x02 0x61
Brightness	Write	Brightness decrease	0x06 0x14 0x00 0x04 0x00 0x34 0x12 0x03 0x00 0x61
		Brightness increase	0x06 0x14 0x00 0x04 0x00 0x34 0x12 0x03 0x01 0x62
	Read	Brightness	0x07 0x14 0x00 0x05 0x00 0x34 0x00 0x00 0x12 0x03 0x62

Aspect ratio	Write	Aspect ratio Auto	0x06 0x14 0x00 0x04 0x00 0x34 0x12 0x04 0x00 0x62
		Aspect ratio 4:3	0x06 0x14 0x00 0x04 0x00 0x34 0x12 0x04 0x02 0x64
		Aspect ratio 16:9	0x06 0x14 0x00 0x04 0x00 0x34 0x12 0x04 0x03 0x65
		Aspect ratio 16:10	0x06 0x14 0x00 0x04 0x00 0x34 0x12 0x04 0x04 0x66
		Aspect ratio Anamorphic	0x06 0x14 0x00 0x04 0x00 0x34 0x12 0x04 0x05 0x67
		Aspect ratio Wide	0x06 0x14 0x00 0x04 0x00 0x34 0x12 0x04 0x06 0x68
		Aspect ratio 2.35:1	0x06 0x14 0x00 0x04 0x00 0x34 0x12 0x04 0x07 0x69
	Aspect ratio Panorama	0x06 0x14 0x00 0x04 0x00 0x34 0x12 0x04 0x08 0x6A	
Read	Aspect Ratio	0x07 0x14 0x00 0x05 0x00 0x34 0x00 0x00 0x12 0x04 0x63	
Auto Adjust	Execute		0x06 0x14 0x00 0x04 0x00 0x34 0x12 0x05 0x00 0x63
Horizontal position	Write	Horizontal position shift right / Horizontal position shift left	0x06 0x14 0x00 0x04 0x00 0x34 0x12 0x06 0x01 0x65
		Horizontal position shift right / Horizontal position shift left	0x06 0x14 0x00 0x04 0x00 0x34 0x12 0x06 0x00 0x64
	Read	Horizontal position	0x07 0x14 0x00 0x05 0x00 0x34 0x00 0x00 0x12 0x06 0x65
Vertical position	Write	Vertical Position shift up / Vertical Position shift down	0x06 0x14 0x00 0x04 0x00 0x34 0x12 0x07 0x00 0x65
		Vertical Position shift up / Vertical Position shift down	0x06 0x14 0x00 0x04 0x00 0x34 0x12 0x07 0x01 0x66
	Read	Read vertical position	0x07 0x14 0x00 0x05 0x00 0x34 0x00 0x00 0x12 0x07 0x66
Color Temperature	Write	Color Temperature Warm	0x06 0x14 0x00 0x04 0x00 0x34 0x12 0x08 0x00 0x66
		Color Temperature Normal	0x06 0x14 0x00 0x04 0x00 0x34 0x12 0x08 0x01 0x67
		Color Temperature Neutral	0x06 0x14 0x00 0x04 0x00 0x34 0x12 0x08 0x02 0x68
		Color Temperature Cool	0x06 0x14 0x00 0x04 0x00 0x34 0x12 0x08 0x03 0x69
	Read	Color Temperature status	0x07 0x14 0x00 0x05 0x00 0x34 0x00 0x00 0x12 0x08 0x67
Blank	Write	Blank ON	0x06 0x14 0x00 0x04 0x00 0x34 0x12 0x09 0x01 0x68
		Blank OFF	0x06 0x14 0x00 0x04 0x00 0x34 0x12 0x09 0x00 0x67
	Read	Blank status	0x07 0x14 0x00 0x05 0x00 0x34 0x00 0x00 0x12 0x09 0x68
Keystone Correction - Vertical	Write	Decrease	0x06 0x14 0x00 0x04 0x00 0x34 0x12 0x0A 0x00 0x68
		Increase	0x06 0x14 0x00 0x04 0x00 0x34 0x12 0x0A 0x01 0x69
	Read	Keystone Correction status	0x07 0x14 0x00 0x05 0x00 0x34 0x00 0x00 0x12 0x0A 0x69

Keystone Correction - Horizontal	Write	Decrease	0x06 0x14 0x00 0x04 0x00 0x34 0x11 0x31 0x00 0x8E
		Increase	0x06 0x14 0x00 0x04 0x00 0x34 0x11 0x31 0x01 0x8F
	Read	Keystone Correction status	0x07 0x14 0x00 0x05 0x00 0x34 0x00 0x00 0x11 0x31 0x8F
Color mode	Write	Brightest	0x06 0x14 0x00 0x04 0x00 0x34 0x12 0x0B 0x00 0x69
		Movie	0x06 0x14 0x00 0x04 0x00 0x34 0x12 0x0B 0x01 0x6A
		Standard	0x06 0x14 0x00 0x04 0x00 0x34 0x12 0x0B 0x04 0x6D
		ViewMatch	0x06 0x14 0x00 0x04 0x00 0x34 0x12 0x0B 0x05 0x6E
		Dynamic	0x06 0x14 0x00 0x04 0x00 0x34 0x12 0x0B 0x08 0x71
	Read	Preset Mode status	0x07 0x14 0x00 0x05 0x00 0x34 0x00 0x00 0x12 0x0B 0x6A
Primary color	Write	Original Color R	0x06 0x14 0x00 0x04 0x00 0x34 0x12 0x10 0x00 0x6E
		Original Color G	0x06 0x14 0x00 0x04 0x00 0x34 0x12 0x10 0x01 0x6F
		Original Color B	0x06 0x14 0x00 0x04 0x00 0x34 0x12 0x10 0x02 0x70
		Original Color C	0x06 0x14 0x00 0x04 0x00 0x34 0x12 0x10 0x03 0x71
		Original Color M	0x06 0x14 0x00 0x04 0x00 0x34 0x12 0x10 0x04 0x72
		Original Color Y	0x06 0x14 0x00 0x04 0x00 0x34 0x12 0x10 0x05 0x73
	Read	Original Color status	0x07 0x14 0x00 0x05 0x00 0x34 0x00 0x00 0x12 0x10 0x6F
Tint	Write	Color Adjustment decrease	0x06 0x14 0x00 0x04 0x00 0x34 0x12 0x11 0x00 0x6F
		Color Adjustment increase	0x06 0x14 0x00 0x04 0x00 0x34 0x12 0x11 0x01 0x70
	Read	Tint	0x07 0x14 0x00 0x05 0x00 0x34 0x00 0x00 0x12 0x11 0x70
Saturation	Write	Saturation decrease	0x06 0x14 0x00 0x04 0x00 0x34 0x12 0x12 0x00 0x70
		Saturation increase	0x06 0x14 0x00 0x04 0x00 0x34 0x12 0x12 0x01 0x71
	Read	Saturation	0x07 0x14 0x00 0x05 0x00 0x34 0x00 0x00 0x12 0x12 0x71
Gain	Write	Gain decrease	0x06 0x14 0x00 0x04 0x00 0x34 0x12 0x13 0x00 0x71
		Gain increase	0x06 0x14 0x00 0x04 0x00 0x34 0x12 0x13 0x01 0x72
	Read	Gain	0x07 0x14 0x00 0x05 0x00 0x34 0x00 0x00 0x12 0x13 0x72
Freeze	Write	Freeze ON	0x06 0x14 0x00 0x04 0x00 0x34 0x13 0x00 0x01 0x60
		Freeze OFF	0x06 0x14 0x00 0x04 0x00 0x34 0x13 0x00 0x00 0x5F
	Read	Freeze status	0x07 0x14 0x00 0x05 0x00 0x34 0x00 0x00 0x13 0x00 0x60

Source input	Write	Input source VGA	0x06 0x14 0x00 0x04 0x00 0x34 0x13 0x01 0x00 0x60
		Input source VGA2	0x06 0x14 0x00 0x04 0x00 0x34 0x13 0x01 0x08 0x68
		Input source HDMI	0x06 0x14 0x00 0x04 0x00 0x34 0x13 0x01 0x03 0x63
		Input source HDMI/MHL	0x06 0x14 0x00 0x04 0x00 0x34 0x13 0x01 0x07 0x67
		Input source Composite video	0x06 0x14 0x00 0x04 0x00 0x34 0x13 0x01 0x05 0x65
		Input source SVIDEO	0x06 0x14 0x00 0x04 0x00 0x34 0x13 0x01 0x06 0x66
	Read	Source	0x07 0x14 0x00 0x05 0x00 0x34 0x00 0x00 0x13 0x01 0x61
Quick Auto Search	Write	Quick Search ON	0x06 0x14 0x00 0x04 0x00 0x34 0x13 0x02 0x01 0x62
		Quick Search OFF	0x06 0x14 0x00 0x04 0x00 0x34 0x13 0x02 0x00 0x61
	Read	Quick Search status	0x07 0x14 0x00 0x05 0x00 0x34 0x00 0x00 0x13 0x02 0x62
Mute	Write	Mute ON	0x06 0x14 0x00 0x04 0x00 0x34 0x14 0x00 0x01 0x61
		Mute OFF	0x06 0x14 0x00 0x04 0x00 0x34 0x14 0x00 0x00 0x60
	Read	Mute status	0x07 0x14 0x00 0x05 0x00 0x34 0x00 0x00 0x14 0x00 0x61
Volume	Write	Volume increase	0x06 0x14 0x00 0x04 0x00 0x34 0x14 0x01 0x00 0x61
		Volume decrease	0x06 0x14 0x00 0x04 0x00 0x34 0x14 0x02 0x00 0x62
	Read	Volume	0x07 0x14 0x00 0x05 0x00 0x34 0x00 0x00 0x14 0x03 0x64

Language	Write	ENGLISH	0x06 0x14 0x00 0x04 0x00 0x34 0x15 0x00 0x00 0x61
		FRANÇAIS	0x06 0x14 0x00 0x04 0x00 0x34 0x15 0x00 0x01 0x62
		DEUTSCH	0x06 0x14 0x00 0x04 0x00 0x34 0x15 0x00 0x02 0x63
		ITALIANO	0x06 0x14 0x00 0x04 0x00 0x34 0x15 0x00 0x03 0x64
		ESPAÑOL	0x06 0x14 0x00 0x04 0x00 0x34 0x15 0x00 0x04 0x65
		РУССКИЙ	0x06 0x14 0x00 0x04 0x00 0x34 0x15 0x00 0x05 0x66
		繁體中文	0x06 0x14 0x00 0x04 0x00 0x34 0x15 0x00 0x06 0x67
		English	0x06 0x14 0x00 0x04 0x00 0x34 0x15 0x00 0x07 0x68
		日本語	0x06 0x14 0x00 0x04 0x00 0x34 0x15 0x00 0x08 0x69
		한국어	0x06 0x14 0x00 0x04 0x00 0x34 0x15 0x00 0x09 0x6A
		Svenska	0x06 0x14 0x00 0x04 0x00 0x34 0x15 0x00 0x0a 0x6B
		Nederlands	0x06 0x14 0x00 0x04 0x00 0x34 0x15 0x00 0x0b 0x6C
		Türkçe	0x06 0x14 0x00 0x04 0x00 0x34 0x15 0x00 0x0c 0x6D
		Čeština	0x06 0x14 0x00 0x04 0x00 0x34 0x15 0x00 0x0d 0x6E
		Português	0x06 0x14 0x00 0x04 0x00 0x34 0x15 0x00 0x0e 0x6F
		ไทย	0x06 0x14 0x00 0x04 0x00 0x34 0x15 0x00 0x0f 0x70
		Polski	0x06 0x14 0x00 0x04 0x00 0x34 0x15 0x00 0x10 0x71
		Suomi	0x06 0x14 0x00 0x04 0x00 0x34 0x15 0x00 0x11 0x72
		العربية	0x06 0x14 0x00 0x04 0x00 0x34 0x15 0x00 0x12 0x73
		Indonesian	0x06 0x14 0x00 0x04 0x00 0x34 0x15 0x00 0x13 0x74
हिन्दी	0x06 0x14 0x00 0x04 0x00 0x34 0x15 0x00 0x14 0x75		
	Read	Language	0x07 0x14 0x00 0x05 0x00 0x34 0x00 0x00 0x15 0x00 0x62
light source Usage Time	Write	Reset light source Usage Time to zero	0x06 0x14 0x00 0x04 0x00 0x34 0x15 0x01 0x00 0x62
	Read	light source Usage Time	0x07 0x14 0x00 0x05 0x00 0x34 0x00 0x00 0x15 0x01 0x63

HDMI Format	Write	RGB	0x06 0x14 0x00 0x04 0x00 0x34 0x11 0x28 0x00 0x85
		YUV	0x06 0x14 0x00 0x04 0x00 0x34 0x11 0x28 0x01 0x86
		Auto	0x06 0x14 0x00 0x04 0x00 0x34 0x11 0x28 0x02 0x87
	Read	HDMI Format status	0x07 0x14 0x00 0x05 0x00 0x34 0x00 0x00 0x11 0x28 0x86
HDMI range	Write	Enhanced	0x06 0x14 0x00 0x04 0x00 0x34 0x11 0x29 0x00 0x86
		Normal	0x06 0x14 0x00 0x04 0x00 0x34 0x11 0x29 0x01 0x87
		Auto	0x06 0x14 0x00 0x04 0x00 0x34 0x11 0x29 0x02 0x88
	Read	HDMI Range status	0x07 0x14 0x00 0x05 0x00 0x34 0x00 0x00 0x11 0x29 0x87
CEC	Write	Off	0x06 0x14 0x00 0x04 0x00 0x34 0x11 0x2B 0x00 0x88
		On	0x06 0x14 0x00 0x04 0x00 0x34 0x11 0x2B 0x01 0x89
	Read	CEC status	0x07 0x14 0x00 0x05 0x00 0x34 0x00 0x00 0x11 0x2B 0x89
Error status	Read	Read Error status	0x07 0x14 0x00 0x05 0x00 0x34 0x00 0x00 0x0C 0x0D 0x66
Brilliant Color	Write	Brilliant Color 0	0x06 0x14 0x00 0x04 0x00 0x34 0x12 0x0F 0x00 0x6D
		Brilliant Color 1	0x06 0x14 0x00 0x04 0x00 0x34 0x12 0x0F 0x01 0x6E
		Brilliant Color 2	0x06 0x14 0x00 0x04 0x00 0x34 0x12 0x0F 0x02 0x6F
		Brilliant Color 3	0x06 0x14 0x00 0x04 0x00 0x34 0x12 0x0F 0x03 0x70
		Brilliant Color 4	0x06 0x14 0x00 0x04 0x00 0x34 0x12 0x0F 0x04 0x71
		Brilliant Color 5	0x06 0x14 0x00 0x04 0x00 0x34 0x12 0x0F 0x05 0x72
		Brilliant Color 6	0x06 0x14 0x00 0x04 0x00 0x34 0x12 0x0F 0x06 0x73
		Brilliant Color 7	0x06 0x14 0x00 0x04 0x00 0x34 0x12 0x0F 0x07 0x74
		Brilliant Color 8	0x06 0x14 0x00 0x04 0x00 0x34 0x12 0x0F 0x08 0x75
		Brilliant Color 9	0x06 0x14 0x00 0x04 0x00 0x34 0x12 0x0F 0x09 0x76
	Brilliant Color 10	0x06 0x14 0x00 0x04 0x00 0x34 0x12 0x0F 0x0A 0x77	
Read	Brilliant Color status	0x07 0x14 0x00 0x05 0x00 0x34 0x00 0x00 0x12 0x0F 0x6E	

Remote control code	Write	Code 1	0x06 0x14 0x00 0x04 0x00 0x34 0x0C 0x48 0x00 0xA0
		Code 2	0x06 0x14 0x00 0x04 0x00 0x34 0x0C 0x48 0x01 0xA1
		Code 3	0x06 0x14 0x00 0x04 0x00 0x34 0x0C 0x48 0x02 0xA2
		Code 4	0x06 0x14 0x00 0x04 0x00 0x34 0x0C 0x48 0x03 0xA3
		Code 5	0x06 0x14 0x00 0x04 0x00 0x34 0x0C 0x48 0x04 0xA4
		Code 6	0x06 0x14 0x00 0x04 0x00 0x34 0x0C 0x48 0x05 0xA5
		Code 7	0x06 0x14 0x00 0x04 0x00 0x34 0x0C 0x48 0x06 0xA6
		Code 8	0x06 0x14 0x00 0x04 0x00 0x34 0x0C 0x48 0x07 0xA7
	Read	Remote Control Code status	0x07 0x14 0x00 0x05 0x00 0x34 0x00 0x00 0x0C 0x048 0xA1
Screen Color	Write	Screen Color OFF	0x06 0x14 0x00 0x04 0x00 0x34 0x11 0x32 0x00 0x8F
		Backboard	0x06 0x14 0x00 0x04 0x00 0x34 0x11 0x32 0x01 0x90
		Green board	0x06 0x14 0x00 0x04 0x00 0x34 0x11 0x32 0x02 0x91
		Whiteboard	0x06 0x14 0x00 0x04 0x00 0x34 0x11 0x32 0x03 0x92
	Read	Screen Color status	0x07 0x14 0x00 0x05 0x00 0x34 0x00 0x00 0x11 0x32 0x90
Overscan	Write	Overscan OFF	0x06 0x14 0x00 0x04 0x00 0x34 0x11 0x33 0x00 0x90
		Overscan 1	0x06 0x14 0x00 0x04 0x00 0x34 0x11 0x33 0x01 0x91
		Overscan 2	0x06 0x14 0x00 0x04 0x00 0x34 0x11 0x33 0x02 0x92
		Overscan 3	0x06 0x14 0x00 0x04 0x00 0x34 0x11 0x33 0x03 0x93
		Overscan 4	0x06 0x14 0x00 0x04 0x00 0x34 0x11 0x33 0x04 0x94
		Overscan 5	0x06 0x14 0x00 0x04 0x00 0x34 0x11 0x33 0x05 0x95
	Read	Overscan status	0x07 0x14 0x00 0x05 0x00 0x34 0x00 0x00 0x11 0x33 0x91

Remote Key	Write	Menu	0x02 0x14 0x00 0x04 0x00 0x34 0x02 0x04 0x0F 0x61
		Exit	0x02 0x14 0x00 0x04 0x00 0x34 0x02 0x04 0x13 0x65
		Up	0x02 0x14 0x00 0x04 0x00 0x34 0x02 0x04 0x0B 0x5D
		Down	0x02 0x14 0x00 0x04 0x00 0x34 0x02 0x04 0x0C 0x5E
		Left	0x02 0x14 0x00 0x04 0x00 0x34 0x02 0x04 0x0D 0x5F
		Right	0x02 0x14 0x00 0x04 0x00 0x34 0x02 0x04 0x0E 0x60
		Source	0x02 0x14 0x00 0x04 0x00 0x34 0x02 0x04 0x04 0x56
		Input	0x02 0x14 0x00 0x04 0x00 0x34 0x02 0x04 0x15 0x67
		Auto	0x02 0x14 0x00 0x04 0x00 0x34 0x02 0x04 0x08 0x5A
		My buttons	0x02 0x14 0x00 0x04 0x00 0x34 0x02 0x04 0x11 0x63

Customer Support

For technical support or product service, see the table below or contact your reseller.

Note : You will need the product serial number.

Country/Region	Website	T= Telephone C = CHAT ONLINE	Email
Australia New Zealand	www.viewsonic.com.au	AUS= 1800 880 818 NZ= 0800 008 822	service@au.viewsonic.com
Canada	www.viewsonic.com	T (Toll-Free)= 1-866-463-4775 T (Toll)= 1-424-233-2533	service.ca@viewsonic.com
Europe	www.viewsoniceurope.com	www.viewsoniceurope.com/uk/support/call-desk/	
Hong Kong	www.hk.viewsonic.com	T= 852 3102 2900	service@hk.viewsonic.com
India	www.in.viewsonic.com	T= 1800 419 0959	service@in.viewsonic.com
Korea	ap.viewsonic.com/kr/	T= 080 333 2131	service@kr.viewsonic.com
Latin America (Argentina)	www.viewsonic.com/la/	C= http://www.viewsonic.com/la/soporte/servicio-tecnico	soporte@viewsonic.com
Latin America (Chile)	www.viewsonic.com/la/	C= http://www.viewsonic.com/la/soporte/servicio-tecnico	soporte@viewsonic.com
Latin America (Columbia)	www.viewsonic.com/la/	C= http://www.viewsonic.com/la/soporte/servicio-tecnico	soporte@viewsonic.com
Latin America (Mexico)	www.viewsonic.com/la/	C= http://www.viewsonic.com/la/soporte/servicio-tecnico	soporte@viewsonic.com
Nexus Hightech Solutions, Cincinnati #40 Desp. 1 Col. De los Deportes Mexico D.F. Tel: 55) 6547-6454 55)6547-6484 Other places please refer to http://www.viewsonic.com/la/soporte/servicio-tecnico#mexico			
Latin America (Peru)	www.viewsonic.com/la/	C= http://www.viewsonic.com/la/soporte/servicio-tecnico	soporte@viewsonic.com
Macau	www.hk.viewsonic.com	T= 853 2870 0303	service@hk.viewsonic.com
Middle East	ap.viewsonic.com/me/	Contact your reseller	service@ap.viewsonic.com
Puerto Rico & Virgin Islands	www.viewsonic.com	T= 1-800-688-6688 (English) C= http://www.viewsonic.com/la/soporte/servicio-tecnico	service.us@viewsonic.com soporte@viewsonic.com
Singapore/ Malaysia/Thailand	www.ap.viewsonic.com	T= 65 6461 6044	service@sg.viewsonic.com
South Africa	ap.viewsonic.com/za/	Contact your reseller	service@ap.viewsonic.com
United States	www.viewsonic.com	T (Toll-Free)= 1-800-688-6688 T (Toll)= 1-424-233-2530	service.us@viewsonic.com

Limited Warranty

ViewSonic® Projector

What the warranty covers:

ViewSonic warrants its products to be free from defects in material and workmanship, under normal use, during the warranty period. If a product proves to be defective in material or workmanship during the warranty period, ViewSonic will, at its sole option, repair or replace the product with a like product. Replacement product or parts may include remanufactured or refurbished parts or components.

Limited One (1) year General Warranty

ViewSonic's standard warranty period is one (1) year for any product model in any country, unless a longer warranty period is specified and provided by ViewSonic. Please refer to the ViewSonic website in your country to check the local terms and model variants, and see if the product model in your country is eligible for a longer warranty period.

Limited One (1) year Heavy Usage Warranty:

Under heavy usage settings, where a projector's use includes more than fourteen (14) hours average daily usage, North and South America: One (1) year warranty for all parts excluding the Light Source, one (1) year for labor, and ninety (90) days for the original Light Source from the date of the first consumer purchase; Europe: One (1) year warranty for all parts excluding the Light Source, one (1) year for labor, and ninety (90) days for the original Light Source from the date of the first consumer purchase.

Other regions or countries: Please check with your local dealer or local ViewSonic office for the warranty information.

Light Source warranty subject to terms and conditions, verification and approval. Applies to manufacturer's installed Light Source only. All accessory Light Source purchased separately are warranted for 90 days.

Who the warranty protects:

This warranty is valid only for the first consumer purchaser.

What the warranty does not cover:

1. Any product on which the serial number has been defaced, modified or removed.
2. Damage, deterioration, failure, or malfunction resulting from:
 - a. Accident, abuse, misuse, neglect, fire, water, lightning, or other acts of nature, improper maintenance, unauthorized product modification, or failure to follow instructions supplied with the product.
 - b. Operation outside of product specifications.
 - c. Operation of the product for other than the normal intended use or not under normal conditions.
 - d. Repair or attempted repair by anyone not authorized by ViewSonic.
 - e. Any damage of the product due to shipment.
 - f. Removal or installation of the product.
 - g. Causes external to the product, such as electric power fluctuations or failure.
 - h. Use of supplies or parts not meeting ViewSonic's specifications.
 - i. Normal wear and tear.
 - j. Any other cause which does not relate to a product defect.
3. Removal, installation, and set-up service charges.

How to get service:

1. For information about receiving service under warranty, contact ViewSonic Customer Support (please refer to “Customer Support” page). You will need to provide your product’s serial number.
2. To obtain warranted service, you will be required to provide (a) the original dated sales slip, (b) your name, (c) your address, (d) a description of the problem, and (e) the serial number of the product.
3. Take or ship the product freight prepaid in the original container to an authorized ViewSonic service center or ViewSonic.
4. For additional information or the name of the nearest ViewSonic service center, contact ViewSonic.

Limitation of implied warranties:

There are no warranties, express or implied, which extend beyond the description contained herein including the implied warranty of merchantability and fitness for a particular purpose.

Exclusion of damages:

ViewSonic’s liability is limited to the cost of repair or replacement of the product.

ViewSonic shall not be liable for:

1. Damage to other property caused by any defects in the product, damages based upon inconvenience, loss of use of the product, loss of time, loss of profits, loss of business opportunity, loss of goodwill, interference with business relationships, or other commercial loss, even if advised of the possibility of such damages.
2. Any other damages, whether incidental, consequential or otherwise.
3. Any claim against the customer by any other party.

Effect of local law:

This warranty gives you specific legal rights, and you may also have other rights which vary from local authority. Some local governances do not allow limitations on implied warranties and/or do not allow the exclusion of incidental or consequential damages, so the above limitations and exclusions may not apply to you.

Sales outside the U.S.A. and Canada:

For warranty information and service on ViewSonic products sold outside of the U.S.A. and Canada, contact ViewSonic or your local ViewSonic dealer.

The warranty period for this product in mainland China (Hong Kong, Macao and Taiwan Excluded) is subject to the terms and conditions of the Maintenance Guarantee Card.

For users in Europe and Russia, full details of warranty provided can be found in www.viewsoniceurope.com under Support/Warranty Information.

Mexico Limited Warranty

ViewSonic® Projector

What the warranty covers:

ViewSonic warrants its products to be free from defects in material and workmanship, under normal use, during the warranty period. If a product proves to be defective in material or workmanship during the warranty period, ViewSonic will, at its sole option, repair or replace the product with a like product. Replacement product or parts may include remanufactured or refurbished parts or components & accessories.

How long the warranty is effective:

ViewSonic's standard warranty period is one (1) year for any product model in any country, unless a longer warranty period is specified and provided by ViewSonic. Please refer to the ViewSonic website in your country to check the local terms and model variants, and see if the product model in your country is eligible for a longer warranty period.

Who the warranty protects:

This warranty is valid only for the first consumer purchaser.

What the warranty does not cover:

1. Any product on which the serial number has been defaced, modified or removed.
2. Damage, deterioration or malfunction resulting from:
 - a. Accident, misuse, neglect, fire, water, lightning, or other acts of nature, unauthorized product modification, unauthorized attempted repair, or failure to follow instructions supplied with the product.
 - b. Any damage of the product due to shipment.
 - c. Causes external to the product, such as electrical power fluctuations or failure.
 - d. Use of supplies or parts not meeting ViewSonic's specifications.
 - e. Normal wear and tear.
 - f. Any other cause which does not relate to a product defect.
3. Any product exhibiting a condition commonly known as "image burn-in" which results when a static image is displayed on the product for an extended period of time.
4. Removal, installation, insurance, and set-up service charges.

How to get service:

For information about receiving service under warranty, contact ViewSonic Customer Support (Please refer to the attached Customer Support page). You will need to provide your product's serial number, so please record the product information in the space provided below on your purchase for your future use. Please retain your receipt of proof of purchase to support your warranty claim.

For Your Records

Product Name: _____ Model Number: _____
Document Number: _____ Serial Number: _____
Purchase Date: _____ Extended Warranty Purchase? _____ (Y/N)
If so, what date does warranty expire? _____

1. To obtain warranty service, you will be required to provide (a) the original dated sales slip, (b) your name, (c) your address, (d) a description of the problem, and (e) the serial number of the product.
2. Take or ship the product in the original container packaging to an authorized ViewSonic service center.
3. Round trip transportation costs for in-warranty products will be paid by ViewSonic.

Limitation of implied warranties:

There are no warranties, express or implied, which extend beyond the description contained herein including the implied warranty of merchantability and fitness for a particular purpose.

Exclusion of damages:

ViewSonic's liability is limited to the cost of repair or replacement of the product. ViewSonic shall not be liable for:

1. Damage to other property caused by any defects in the product, damages based upon inconvenience, loss of use of the product, loss of time, loss of profits, loss of business opportunity, loss of goodwill, interference with business relationships, or other commercial loss, even if advised of the possibility of such damages.
2. Any other damages, whether incidental, consequential or otherwise.
3. Any claim against the customer by any other party.
4. Repair or attempted repair by anyone not authorized by ViewSonic.

Contact Information for Sales & Authorized Service (Centro Autorizado de Servicio) within Mexico:	
Name, address, of manufacturer and importers: México, Av. de la Palma #8 Piso 2 Despacho 203, Corporativo Interpalmas, Col. San Fernando Huixquilucan, Estado de México Tel: (55) 3605-1099 http://www.viewsonic.com/la/soporte/index.htm	
NÚMERO GRATIS DE ASISTENCIA TÉCNICA PARA TODO MÉXICO: 001.866.823.2004	
Hermosillo: Distribuciones y Servicios Computacionales SA de CV. Calle Juárez 284 local 2 Col. Bugambilias C.P: 83140 Tel: 01-66-22-14-9005 E-Mail: disc2@hmo.megared.net.mx	Villahermosa: Compumantenimientos Garantizados, S.A. de C.V. AV. GREGORIO MENDEZ #1504 COL, FLORIDA C.P. 86040 Tel: 01 (993) 3 52 00 47 / 3522074 / 3 52 20 09 E-Mail: compumantenimientos@prodigy.net.mx
Puebla, Pue. (Matriz): RENTA Y DATOS, S.A. DE C.V. Domicilio: 29 SUR 721 COL. LA PAZ 72160 PUEBLA, PUE. Tel: 01(52).222.891.55.77 CON 10 LINEAS E-Mail: datos@puebla.megared.net.mx	Veracruz, Ver.: CONEXION Y DESARROLLO, S.A DE C.V. Av. Americas # 419 ENTRE PINZÓN Y ALVARADO Fracc. Reforma C.P. 91919 Tel: 01-22-91-00-31-67 E-Mail: gacosta@qplus.com.mx
Chihuahua Soluciones Globales en Computación C. Magisterio # 3321 Col. Magisterial Chihuahua, Chih. Tel: 4136954 E-Mail: Cefeo@soluglobales.com	Cuernavaca Compusupport de Cuernavaca SA de CV Francisco Leyva # 178 Col. Miguel Hidalgo C.P. 62040, Cuernavaca Morelos Tel: 01 777 3180579 / 01 777 3124014 E-Mail: aquevedo@compusupportcva.com
Distrito Federal: QPLUS, S.A. de C.V. Av. Coyoacán 931 Col. Del Valle 03100, México, D.F. Tel: 01(52)55-50-00-27-35 E-Mail : gacosta@qplus.com.mx	Guadalajara, Jal.: SERVICRECE, S.A. de C.V. Av. Niños Héroes # 2281 Col. Arcos Sur, Sector Juárez 44170, Guadalajara, Jalisco Tel: 01(52)33-36-15-15-43 E-Mail: mmiranda@servicrece.com
Guerrero Acapulco GS Computación (Grupo Sesicomp) Progreso #6-A, Colo Centro 39300 Acapulco, Guerrero Tel: 744-48-32627	Monterrey: Global Product Services Mar Caribe # 1987, Esquina con Golfo Pérsico Fracc. Bernardo Reyes, CP 64280 Monterrey N.L. México Tel: 8129-5103 E-Mail: aydeem@gps1.com.mx
MERIDA: ELECTROSER Av Reforma No. 403Gx39 y 41 Mérida, Yucatán, México CP97000 Tel: (52) 999-925-1916 E-Mail: rrrb@sureste.com	Oaxaca, Oax.: CENTRO DE DISTRIBUCION Y SERVICIO, S.A. de C.V. Murguía # 708 P.A., Col. Centro, 68000, Oaxaca Tel: 01(52)95-15-15-22-22 Fax: 01(52)95-15-13-67-00 E-Mail: gpotai2001@hotmail.com
Tijuana: STD Av Ferrocarril Sonora #3780 L-C Col 20 de Noviembre Tijuana, Mexico	FOR USA SUPPORT: ViewSonic Corporation 14035 Pipeline Ave. Chino, CA 91710, USA Tel: 800-688-6688 (English); 866-323-8056 (Spanish); E-Mail: http://www.viewsonic.com



ViewSonic®