

Projection Distance Chart

Screen diagonal (inch)	Display size (16:9)		Projection distance	
	W (mm)	H (mm)	Wide (m)	Tele (m)
60	1,328	747	1.78	3.66
70	1,549	872	2.09	4.28
80	1,771	996	2.40	4.89
90	1,992	1,121	2.70	5.51
100	2,214	1,245	3.01	6.13
110	2,435	1,370	3.31	6.75
120	2,656	1,494	3.62	7.36
130	2,878	1,619	3.92	7.98
140	3,099	1,743	4.23	8.60
150	3,320	1,868	4.53	9.22
160	3,542	1,992	4.84	9.84
170	3,763	2,117	5.14	10.45
180	3,984	2,241	5.45	11.07
190	4,206	2,366	5.75	11.68
200	4,427	2,490	6.06	12.30

*Projection distances are design specifications, so there is ±5% variation.

Connectors

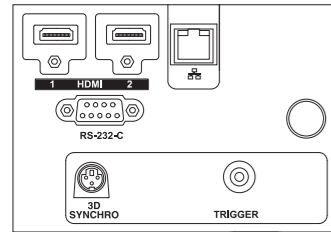

Specifications

	DLA-X9000	DLA-X7000	DLA-X5000
Device	0.7 inch Full HD D-ILA (1920 x 1080) x3		
4K e-shift Technology	●		
Resolution	3840 x 2160*1		
Lens	x2 Zoom & Focus: Motorised; f=21.4-42.8mm / F3.2-4		
Lens Shift	±80% Vertical and ±34% Horizontal (motorised)		
Lens Cover	●	●	—
Projection Display Size	60 inch – 200 inch (diagonal)		
Light Source Lamp	NSH 265W (lamp life: approx. 4,500 hours when the lamp is in Low mode)		
Brightness	1,900 lm	1,800 lm	1,700lm
Contrast Ratio	Dynamic	1,500,000:1	1,200,000:1
	Native	150,000:1	120,000:1
Input Terminal	HDMI 2 (3D/Deep Colour/HDCP 2.2)		
Output Terminals	Trigger 1 (Mini jack, DC12V/100mA)		
3D Sync	1 (Mini DIN 3pin)		
Control Terminals	RS-232C 1 (D-sub 9pin)		
LAN (RJ-45)	1		
Video Input Signal Format (Digital)	480p, 576p, 720p 60/50, 1080i 60/50, 1080p 60/50/24, 3840 x 2160p 60/50/30/25/24, 4096 x 2160p*2 60/50/30/25/24		
PC Input Signal Format (HDMI)	VGA/SVGA/XGA/WXGA/WXGA+/SXGA/WSXGA+		
3D Format	Frame Packing	720p 60/50, 1080p 24	
	Side-by-Side (half)	720p 60/50, 1080p 60/50/24, 1080i 60/50	
	Top & Bottom	720p 60/50, 1080p/24	
Power Consumption	380W (Normal standby: 1.5W, Eco-mode standby: 0.4W)		
Fan Noise	21dB (When the lamp is in Low mode)		
Power Requirement	AC100V-240V, 50/60Hz		
Dimensions (W x H x D)	455mm x 179mm x 472mm		
Weight (net)	15.6kg	15.6kg	15.4kg

*1 Resolution is 1920x1080 at 3D mode.

*2 When the video input signal is at 4096 x 2160p, data above 3840 is not displayed equally on the left and right.

External Dimensions (unit: mm)

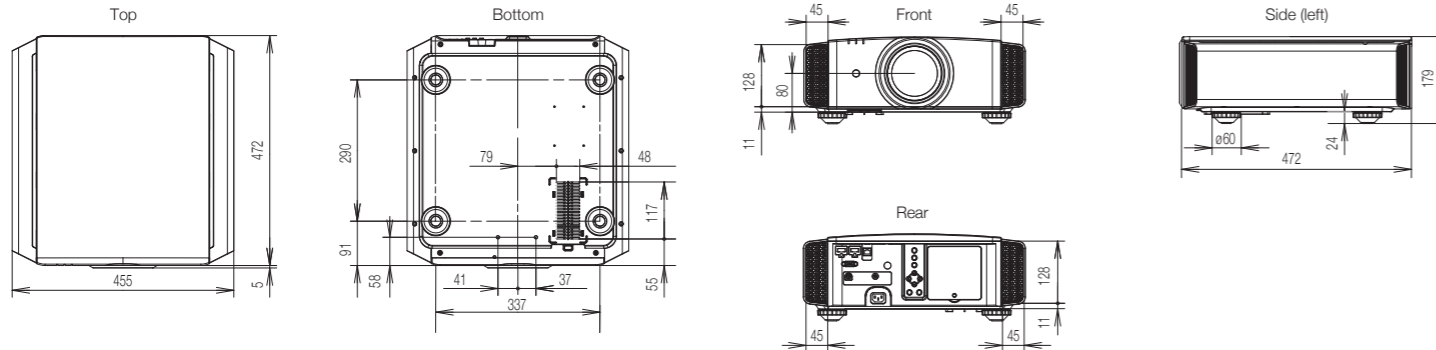

• D-ILA is a registered trademark of JVCケンウッド株式会社. • Control4 and the Control4 logo are registered trademarks of Control4 Corporation. • THX and THX logo are trademarks of THX Ltd., which may be registered in some jurisdictions. • ISF is a registered trademark of Imaging Science Foundation, Inc. • HDMI, the HDMI logo and High-Definition Multimedia Interface are registered trademarks of HDMI Licensing LLC. • Please be aware that, because the D-ILA device is manufactured using highly advanced technologies, 0.01% or fewer of the pixels may be non-performing (always on or off). • The projector is equipped with an ultra-high pressure mercury lamp, which may break, emitting a loud noise, when it is subjected to shock or after it has been used for some length of time. • Please note that, depending on how the projector is used, there can be considerable difference between individual lamps regarding how many hours they will operate before requiring replacement. • An additional payment is required for installation of the projector or a new lamp, if necessary. • All other brand or product names may be trademarks and/or registered trademarks of their respective owners. • All pictures on this brochure are simulated. • Design and specifications are subject to change without notice. • Any rights not expressly granted herein are reserved.

Copyright © 2015, JVCケンウッド株式会社. All Rights Reserved.

JVC

DISTRIBUTED BY

www.jvc.eu
www.jvc.net/asia

Printed in Japan
CCE-3750-15

JVC is the trademark or registered trademark of JVCケンウッド株式会社.

JVC

D-ILA PROJECTORS

DLA-X9000
DLA-X7000
DLA-X5000



4K e-shift4

ProSelecta

View :: Compare :: Select - www.ProSelecta.com

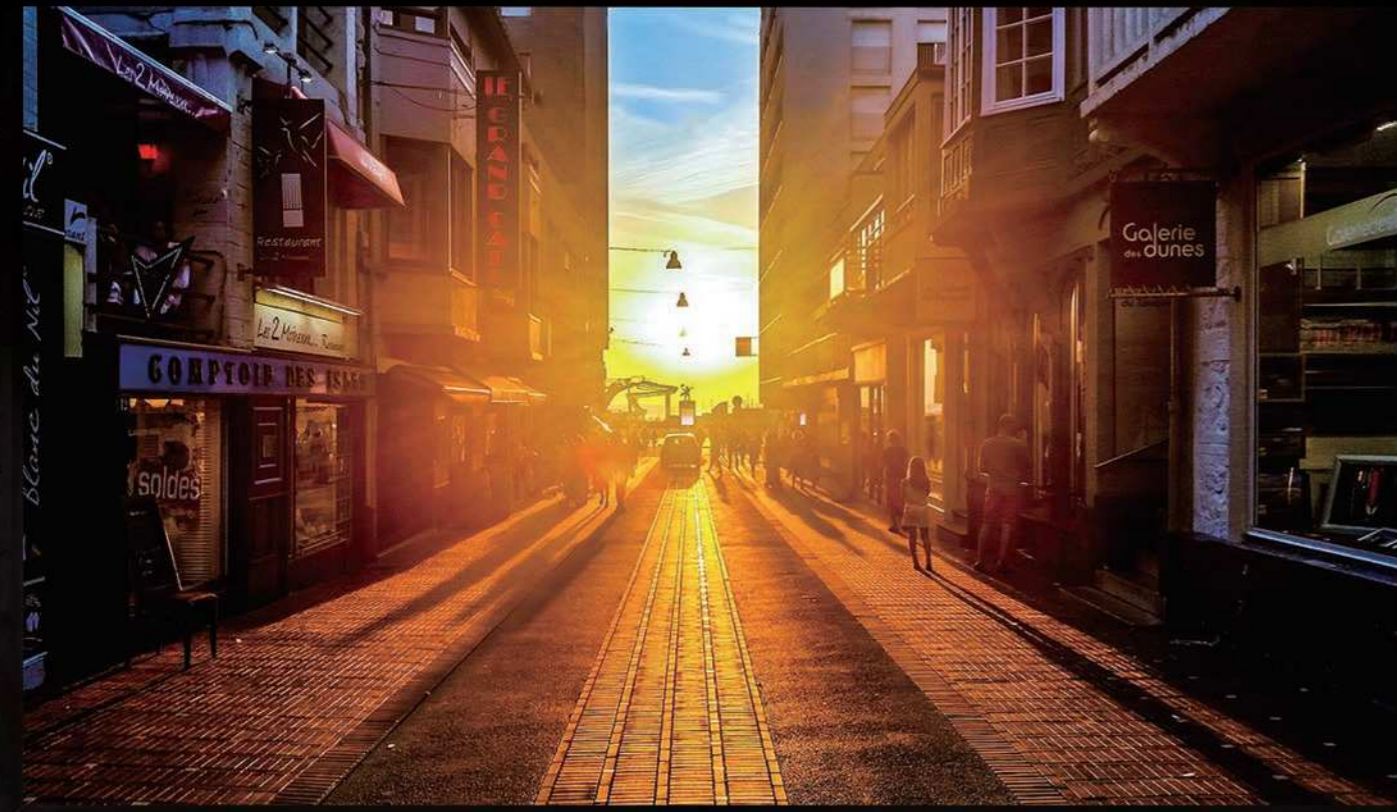

DLA-X9000

4K-resolution D-ILA Projector

4K e-shift4 D-ILA 3D TX3D DISPLAY ISF Control4

- Dynamic contrast ratio: 1,500,000:1
- Native contrast ratio: 150,000:1
- Brightness: 1,900 lm
- Compatible with HDMI standard (4K60P 4:4:4) and HDCP 2.2



DLA-X7000

4K-resolution D-ILA Projector

4K e-shift4 D-ILA 3D TX3D DISPLAY ISF Control4

- Dynamic contrast ratio: 1,200,000:1
- Native contrast ratio: 120,000:1
- Brightness: 1,800 lm
- Compatible with HDMI standard (4K60P 4:4:4) and HDCP 2.2



DLA-X5000

4K-resolution D-ILA Projector

4K e-shift4 D-ILA 3D Control4

- Dynamic contrast ratio: 400,000:1
- Native contrast ratio: 40,000:1
- Brightness: 1,700 lm
- Compatible with HDMI standard (4K60P 4:4:4) and HDCP 2.2
- Available in 2 colours (black and white)



Dynamic Definition

D-ILA®

4K
e-shift4



4K images with
1,900-lumen
brightness

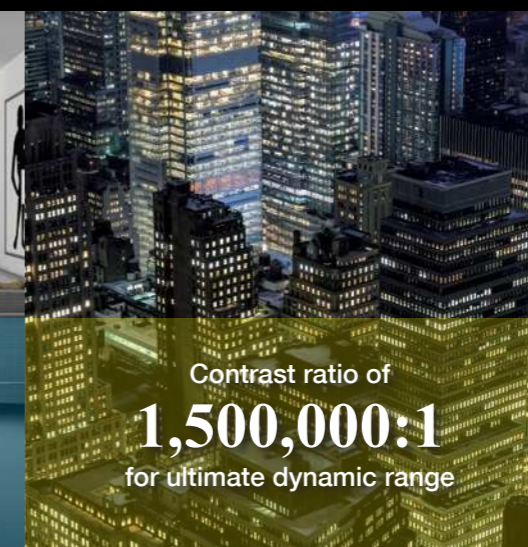

Contrast ratio of
1,500,000:1
for ultimate dynamic range



New generation formats
HDR
content compatibility

See the details even in the brightest highlights and darkest shadows

4K video full of reality is achieved through ultimate dynamic range

Smooth yet vivid — experience 4K quality as only D-ILA makes it possible

Technologies to realise D-ILA 4K images

Achieves exceptionally bright 1,900 lm*1 with newly adopted high-output lamp

The newly adopted 265W high-output lamp in the new D-ILA projectors delivers a brightness of 1,900 lm*1, which is an increase of over 40% compared to previous models*2. What's more, smoother and more powerful pictures can be achieved through the combination of the new lamp and JVC's original D-ILA device with an even narrower gap between pixels for efficient use of light. Powerful, vivid and highly detailed 4K high-definition video can be enjoyed even in environments where it's hard to block out light, such as living rooms, that are not ideally suited for viewing high-definition videos.

*1: DLA-X9000 *2: Previous model DLA-X900R.



Simulated picture

Ultimate dynamic contrast ratio of 1,500,000:1*3 achieved by 150,000:1 high native contrast ratio

The combination of JVC's original D-ILA device and an optical engine equipped with a wire grid that complements the new high-output lamp results in high native contrast ratio of 150,000:1*3. Input signals are analysed with an original algorithm that is combined with Intelligent Lens Aperture, which automatically controls the black level of the image to achieve an ultimate dynamic contrast of 1,500,000:1.

*3: DLA-X9000



Simulated picture

Compatible with the next-generation HDR*4 content

The new D-ILA projectors are compatible with content boasting a wide dynamic range such as the next-generation Blu-ray disc that is expected to expand in the future, and over-the-top (OTT) video services. Capitalising on the native contrast, these projectors are capable of achieving visual effects that are similar to the human eye with exceptional brightness that is close to the dynamic range for camcorders and a high contrast ratio. Also, the projectors can display images with peak brightness three times*5 that of

conventional cinemas thanks to the adoption of a new high-output lamp. With this, what was difficult to display up until now, such as lustre and glittering, as well as details in dark areas, can be viewed simultaneously.

*4: Stands for high dynamic range. *5: at 100-inch projection.

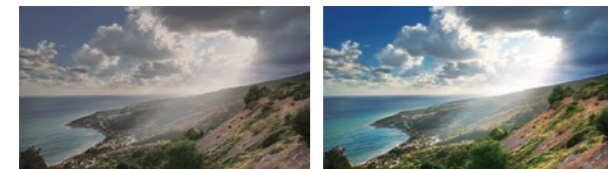

Conventional projector

DLA-X9000

Simulated picture

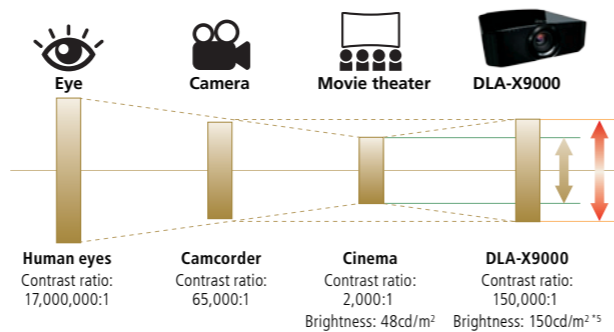

Complies with the latest HDMI/HDCP 2.2 standards to enable full spec 4K signal input

The projectors are capable of receiving full spec 4K signals including 4K60P 4:4:4, 4K60P 4:2:2/36-bit and 4K24P 4:4:4/36-bit as the units comply with the latest HDMI standard with 18 Gbps transmission bandwidth compatibility for reproducing more vivid colours with more precise gradation. In order to be compatible with copyright-protected

content such as OTT video services and the next-generation Blu-ray disc, the projectors comply with the latest HDMI standard and HDCP 2.2. With the two HDMI terminals, up to 2 copyright-protection-compatible HDMI devices can be directly connected.

Original 4K e-shift Technology continues to evolve

JVC's e-shift technology shifts sub-frames by 0.5 pixels both vertically and horizontally to achieve 4 times the pixel density of the original content. The latest e-shift4 Technology is capable of inputting full-spec 4K video signals including 4K60P 4:4:4 thanks to the optimised engine and the newly adopted high-power lamp. These improvements result in an even higher definition picture with more precision.

4K e-shift4

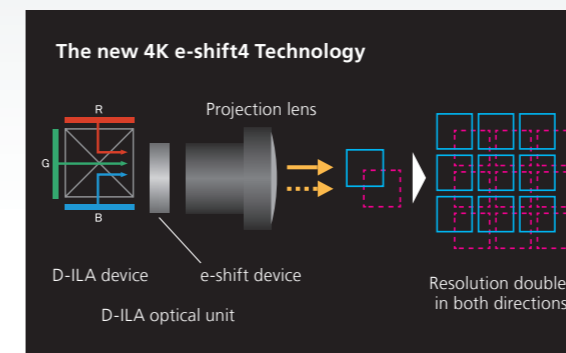

New Multiple Pixel Control

JVC's original high-performance image processing technology, Multiple Pixel Control, has been improved to match the trend towards higher resolution. Through adoption of a new analysis algorithm, the MPC is now capable of more accurate diagonal-detection between frames for both full HD and full 4K resolution signals, delivering a thoroughly immersive high-definition 4K image.



Original image

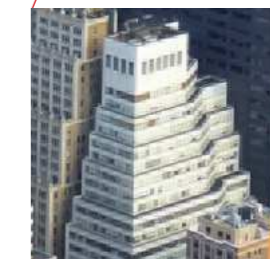

Previous MPC technology



New MPC

Simulated picture

High-quality moving images

Clear Motion Drive with High-speed LSI

Further improvement has been applied to JVC's original Clear Motion Drive. It now is compatible with 4K60P 4:4:4 signals for reproducing moving images without ghosting or afterimage issues.

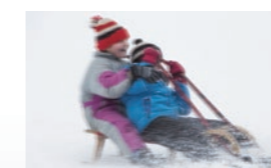

Clear Motion Drive OFF



Clear Motion Drive ON

New Motion Enhance

In addition to the improved Clear Motion Drive, the new D-ILA projectors are equipped with originally developed Motion Enhance technology. By optimally controlling the driving performance of D-ILA devices by image characteristics, residual images and blurring that are often found in fast-moving images are reduced. JVC's original Clear Motion Drive and Motion Enhance technologies will help to reproduce a variety of crisp and smooth moving images.

Creating images that match the viewing environment

JVC's advancing technologies and functions



Original Real Colour Imaging Technology*6

JVC's original Real Colour Imaging Technology accurately grasps the colour information for precise reproduction. The technology's colour reproduction ability has improved. With the adoption of a new colour filter, the DLA-X9000 and DLA-X7000 are now capable of covering the DCI*7 colour space. It is now possible to reproduce colours true to the original for exceptionally beautiful 4K images.

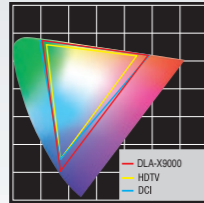

*6: DLA-X9000 and DLA-X7000.
*7: DCI stands for Digital Cinema Initiatives, a new standard for digital cinema.

Colour Management System with 6-Axis Matrix

A 6-axis matrix of red, green, blue, cyan, magenta, and yellow enables the precise adjustment of hue, saturation, and intensity. Only the colour being adjusted will be shown in colour while the others are grey-toned, making operation more intuitive.

Auto-Calibration Function*8

Using an optical sensor, precise calibration can be performed in just a few easy steps to match the changes in optical characteristics caused by installation situation of the projector. Auto-Calibration optimises all essential elements found in the image, including colour balance, gamma characteristics, colour space, and colour tracking.



Immediately after use



1,000 hrs after use



After Auto-Calibration

Simulated picture

12-point manual gamma adjustment

Manual gamma adjustment, as requested by users, has been added to the calibration software. In addition to a PC-based adjustment that are reflected to the image in real-time, adjustments using optical sensor can also be performed. It also features importing and exporting of gamma data.



*8: Exclusive JVC software installed on a PC connected to the projector via a LAN connection and optical sensor are required to set viewing configurations and auto calibration. Please visit the JVC website for the details.

Screen Adjustment Modes

The projector selects the best mode to match the screen being used for images with natural colour balance*9. The modes are compatible with the latest models offered by the world's major screen manufacturers.

*9: Refer to JVC website for a comparison of primary screens and adjustment modes.



Screen Adjustment Modes OFF



Screen Adjustment Modes ON

Simulated picture

Pixel Adjust Function

The Pixel Adjust function allows users to precisely correct colour deviation in 1/16-pixel increments. It is also capable of segmenting the entire screen into 121 points and adjusting them individually to realise clearer video without colour deviation. Two settings can be stored in the memory.

Lens Memory Function

This function stores ten*10 separate lens adjustments for zoom, shift and focus that can be easily recalled when needed. Memory settings can be switched between each setup via the remote controller.

*10: DLA-X9000 and DLA-X7000

Lens memory examples (when using CinemaScope screen)



Memory 1: Standard 16:9



Memory 2: CinemaScope size



Memory 3: CinemaScope size with subtitles outside of the screen

Simulated picture

Control4 SDDP Compatibility

JVC's new D-ILA projectors are compatible with Simple Device Discovery Protocol (SDDP) by Control4. When an SDDP-compatible device is added into a Control4 system, it is automatically recognised by the system and automatically adds driver to the projector to enable external control in no time.*11



*11: Requires separate home controller and application.

Industry Certified Projectors – THX 3D Display and ISF Certifications

The DLA-X9000 and X7000 are accredited with THX 3D Display Certification which was established to ensure the precise reproduction of picture quality in home environments for both 2D and 3D content, just as the original filmmaker envisioned. Encompassing more than 400 laboratory tests to evaluate a projector's colour accuracy, cross-talk, viewing angles and video processing, this certification helps to guarantee high-definition quality. The two projectors are also licensed with the ISF C3 (Certified Calibration Controls) mode*12, not only to help reproduce film or video content accurate to the source but also excellent picture quality optimised for specific environments.

*12: Professional calibration to desired screen is performed by trained dealers.



Even brighter and high-quality 3D images of D-ILA

In addition to JVC's original Frame Addressing method to reproduce 3D images with vivid colours, the optical engine featuring a set of new D-ILA devices is capable of achieving more brightness. Furthermore, 3D image adjustment functions such as Crosstalk Cancelling are featured to offer the kind of realistic and exciting 3D images that only D-ILA can provide.



Notes about viewing 3D video content

- The optional 3D Synchro Emitter and 3D glasses are required to view 3D images from the D-ILA projectors. 3D video software (3D media or output of 3D broadcasts) and a 3D-compatible video player are also required.
- Perception of 3D images will vary with individual viewers.
- Stop viewing 3D images immediately if any discomfort such as headaches, dizziness, eye fatigue, etc. occurs.
- Viewing of 3D images by children under the age of five is not recommended.
- Read the User Manual and Safety Precautions carefully before viewing any 3D source.

Feature Comparison

Model	DLA-X9000	DLA-X7000	DLA-X5000
4K e-shift4 Technology*1	●	●	●
4K signal input (4K60P 4:4:4)	●	●	●
HDR compatibility	●	●	●
3D capability	●	●	●
Multiple Pixel Control	●	●	●
Clear Motion Drive	●	●	●
Motion Enhance	●	●	●
Real Colour Imaging Technology	●	●	—
Colour Temperature (Xenon light-source colour)	●	●	—
MPC Analyser	●	●	●
Picture Tone	●	●	●
Pixel Adjust	● (by 1/16-pixel increment, 2 memories)	● (by 1/16-pixel increment, 2 memories)	● (by 1/16-pixel increment, 2 memories)
Lens Memory	● (10 memories)	● (10 memories)	● (5 memories)
Screen Adjustment Mode	●	●	●
Auto Calibration*2	●	●	●
12-point manual gamma adjustment*3	●	●	●
Picture Data In/Out*3	●	●	●
THX 3D Display Certification	●	●	—
ISF C3 mode	●	●	—
Control4 SDDP Compatibility	●	●	●

*1 This function cannot be used while projecting in 3D mode. *2 Requires a commercially available optical sensor and dedicated software as well as PC and LAN cables. *3 Requires dedicated software as well as PC and LAN cables.

Optional Accessories



PK-L2615U

Replacement Lamp



PK-AG3

RF (radio frequency) 3D Glasses



PK-EM2

RF (radio frequency) 3D Synchro Emitter