

User's Guide

EH-LS10000 EH-LS9600W

Home Projector



ProSelecta

View :: Compare :: Select - www.ProSelecta.com

Using Each Guide

The guides for this projector are organized as shown below.

Safety Instructions/Support and Service Guide

Contains information on using the projector safely, as well as a support and service guide, troubleshooting check lists, and so on. Make sure you read this guide before using the projector.



User's Guide (this guide)

Contains information on setting up and basic operations before using the projector, using the Configuration menu, and handling problems and performing routine maintenance.



Quick Start Guide

Contains information on the procedures for setting up the projector. Read this first.

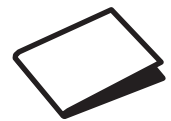

3D Glasses User's Guide

Contains information on handling the 3D Glasses and warnings and so on.

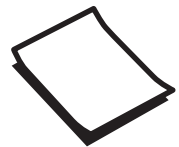

WirelessHD Transmitter User's Guide (EH-LS9600W only)

Contains information on handling the WirelessHD Transmitter and warnings and so on.





Notations Used in This Guide

Safety Indications

The User's Guide and the projector use graphical symbols to show how to use the projector safely. The following shows the symbols and their meanings. Please understand and respect these caution symbols in order to avoid injury to persons or property.

 **Warning**

This symbol indicates information that, if ignored, could possibly result in personal injury or even death due to incorrect handling.



 **Caution**

This symbol indicates information that, if ignored, could possibly result in personal injury or physical damage due to incorrect handling.

General Information Indications

Attention

Indicates procedures which may result in damage or malfunctions to occur.

	Indicates additional information and points which may be useful to know regarding a topic.
	Indicates a page where detailed information regarding a topic can be found.
Menu Name	Indicates Configuration menu items. Example: Image - Color Mode
Button Name	Indicates the buttons on the remote control or the control panel. Example:  button

About the Use of "This Product" or "This Projector"

As well as the main projector unit, supplied items or optional extras may be referred to using the phrase "this product" or "this projector".

Organization of the Guide and Notations in the Guide

Using Each Guide	1
Notations Used in This Guide	2
Safety Indications	2
General Information Indications	2
About the Use of "This Product" or "This Projector"	2

Preparing

Part Names and Functions	6
Front/Top	6
Rear	7
Interface	8
Base	9
Control Panel	10
Remote Control	12

Installing	16
Notes on Installing	16
How to Install	17
Placing on a shelf and projecting	17
Suspending from the ceiling and projecting	17
Projection Distance and Lens Shift Maximum Values	18

Connecting a Device	20
Removing the Cable Cover	20
Connecting Video Devices	21
Equipment with HDMI output ports	21
Equipment with a video output port	21
Equipment with component video output ports	21
Connecting a Computer	22
Computers with an RGB output port	22
Computers with an HDMI output port	22
Connecting External Devices	22
Connecting to Trigger out 1/Trigger out 2 ports	22
Connecting WirelessHD devices (EH- LS9600W only)	23

Connecting MHL devices (EH-LS9600W only)	23
Connecting to the LAN port	24
Securing Cables with the Cable Clamp	24

Preparing the Remote Control	25
Installing Batteries	25
Remote Control Operating Range	25
Operating range (left to right)	25
Operating range (top to bottom)	25

Basic Operations

Turning the Projector On and Off	27
Turning On	27
Turning Off	28

Configuration Menu Operations	29
Adjusting the Projected Screen	31

Displaying the Test Pattern	31
Adjusting the Projector's Tilt	31
Lens Adjustment Function (Focus, Zoom, Lens Shift)	31
Adjusting the focus	32
Adjusting the projection size (zoom adjustment)	33
Adjusting the position of the projected image (lens shift)	33
Keystone	34
Switching the Source	34
Aspect	35
Hiding the Image Temporarily	36

Viewing 3D Images	37
Warnings Regarding Viewing 3D Images	37
Projecting 3D Images	39
When the projector detects a 3D format	39
When the projector cannot detect a 3D format	39
If the 3D image cannot be viewed	40
Preparing the 3D Glasses	40
Charging the 3D Glasses	41
Pairing 3D Glasses	41
Wearing and viewing with the 3D Glasses	42

Range for Viewing 3D Images	42
Converting 2D Images to 3D Images and Viewing	43

Setting Image Quality

Basic 44

Color Mode	44
Super-resolution	46
Super-resolution/4K Enhancement	46
Detail Enhancement	48
Dynamic Contrast	48
Frame Interpolation	49

Precise Image Adjustment 50

Hue, Saturation, and Brightness	50
Gamma	51
Select and adjust the correction value	51
Adjust while viewing the image	51
Adjust using the gamma adjustment graph	52
RGB (Offset/Gain)	52
Color Temp.	53
Skin Tone	53
Sharpness	53
Lens Iris	55
Panel Alignment	56
Image Processing	58
Color Gamut	59

Useful Functions

HDMI Link 60

HDMI Link Function	60
HDMI Link Settings	60
Selecting the Connected Device	61

Lens Position Function 62

Saving the Lens Position	62
Loading the Lens Position	63
Erasing the Lens Position	63
Renaming the Lens Position	63

Memory Function 64

Settings that can be Saved	64
--------------------------------------	----

Saving the Memory	64
Loading the Memory	65
Erasing the Saved Memory	66
Renaming the Memory	66

Connecting with WirelessHD (EH-LS9600W Only) 67

Installing the WirelessHD Transmitter	67
WirelessHD Transmitter part names	68
WirelessHD Transmitter connection example and signal flow	69
Setting the WirelessHD Transmitter	71
Projecting Images	72
WirelessHD Settings Menu	73
WirelessHD Transmission Range	74
Remote Control Operating Range	75
Switching the Input and Output	75
Switching the target image	75
Switching the image source	76
Displaying as a Sub-Screen	78

Picture in Picture 79

Types of Screen that can be Displayed Simultaneously	79
Starting and Exiting Picture in Picture	79
Picture in Picture Settings	80

Operations and Settings Using the Network 81

Making Settings and Performing Operations from a Web Browser	81
Changing the projector's settings (Web Control)	81
Operating the projector (Web Remote)	82
Using the Mail Notification Function to Report Problems	84
Reading error notification mail	84

Configuration Menu

Configuration Menu Functions 86

Configuration Menu Table	86
Image menu	86
Signal menu	88
Settings menu	91
Memory menu	95

Network menu 96
 Info menu 99
 Reset menu 100
 Picture in Picture menu 100

Troubleshooting

Problem Solving 101

Reading the Indicators 101
 Indicator status during an error/warning ... 101
 Indicator status during normal operation ... 103
 When the Indicators Provide No Help 104
 Check the problem 104
 Problems relating to images 105
 Problems when projection starts 109
 Problems with the remote control 109
 Problems with the control panel 110
 Problems with 3D images 110
 Problems with HDMI 111
 Problems with WirelessHD (EH-LS9600W only) 111

Maintenance

Maintenance 113

Cleaning the Parts 113
 Cleaning and replacing the air filter 113
 Cleaning the main unit 115
 Cleaning the 3D Glasses 115

Appendix

Optional Accessories and Consumables 116

Optional Items 116
 Consumables 116

Supported Resolutions 117

HDMI1/HDMI2 Input Signals 117
 Component Video 117
 Composite Video 117
 Computer Signals (Analog RGB) 118
 3D Input Signals 118
 WirelessHD Input Signals 118

MHL Input Signals (via a WirelessHD Transmitter*) 119
 3D Input Signals MHL (via a WirelessHD Transmitter*) 119

Notes on Transportation 120

Moving Nearby 120
 When Transporting 120
 Preparing packaging 120
 Notes when packing and transporting 120

Specifications 121

Appearance 126

Glossary 127

General Notes 129

Precautions when a Using Laser Device 130
 Laser optical path 131
 General Notice 131

Part Names and Functions

Front/Top

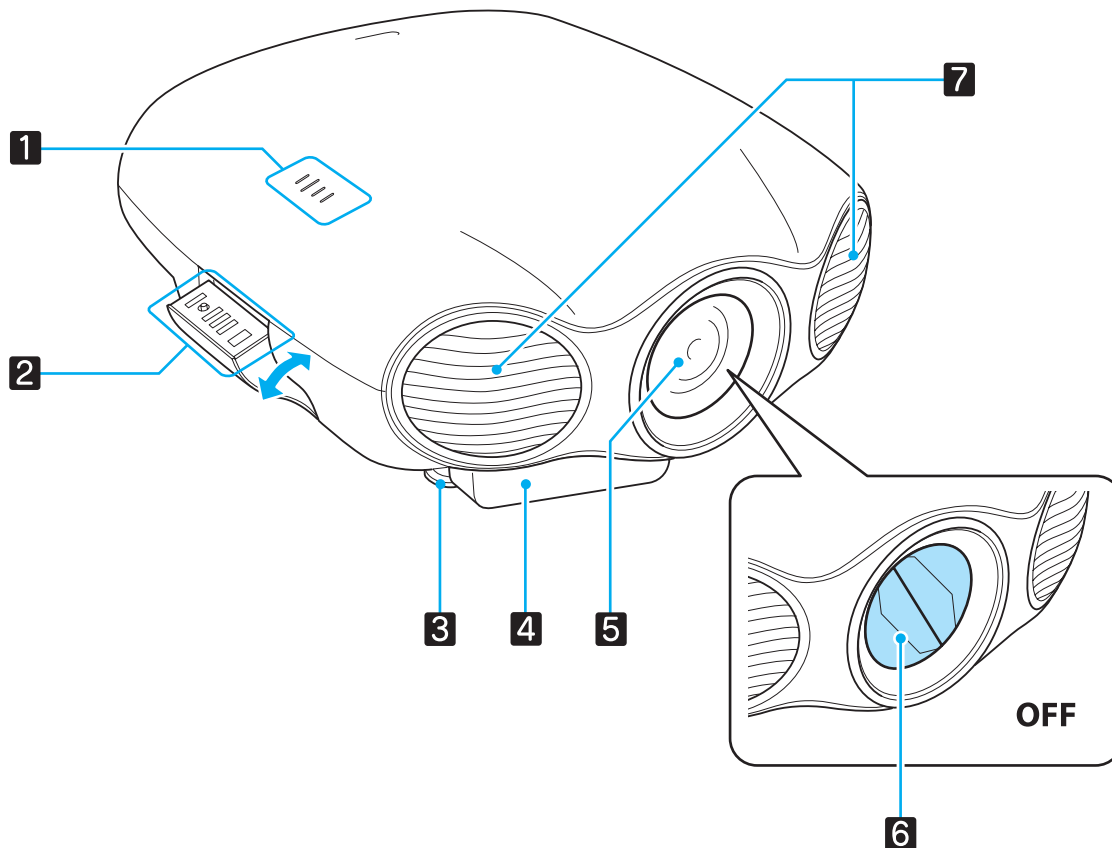

Name		Function
1	Indicators	The color of the indicators and whether they are flashing or lit indicate the status of the projector. p.10
2	Control panel	Retractable control panel on the side of the projector. p.10
3	Front adjustable foot	Adjust the projector's horizontal tilt when placing and projecting. p.31
4	WirelessHD receiver	Receives transmissions from the WirelessHD Transmitter. p.67
5	Projector's lens	Images are projected from here. Laser light is also irradiated from here. <div style="border: 1px solid black; padding: 5px; margin-top: 10px;"> <p> Warning</p> <p>Do not look into the lens during projection. Also, do not look into the lens using optical devices (such as a magnifying glass or telescope).</p> </div>
6	Lens shutter	Links to the projector's power on/off function, and automatically opens and closes the shutter. p.27

	Name	Function
7	Air exhaust vent	Exhaust vent for air used to cool the projector internally. <div style="border: 1px solid black; padding: 5px;"> <p>⚠ Caution</p> <p>While projecting, do not put your face or hands near the air exhaust vent, and do not place objects that may become warped or damaged by heat near the vent. Hot air from the air exhaust vent could cause burns, warping, or accidents to occur.</p> </div>

Rear

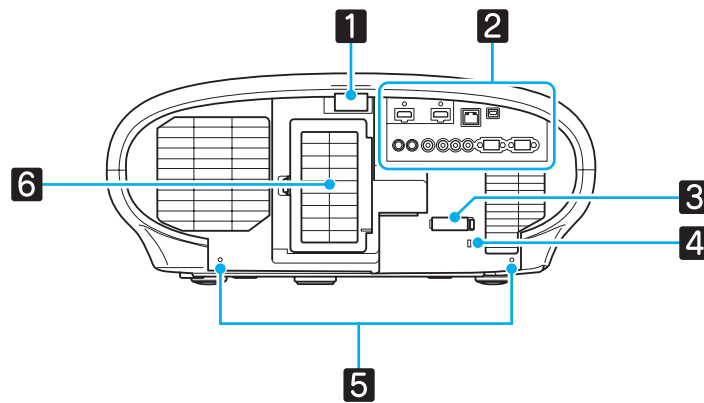

	Name	Function
1	Remote receiver	Receives signals from the remote control. ➡ p.25
2	Interface panel	Provides ports and so on for connecting external equipment. ➡ p.8
3	Cable clamp	Secures the cables. ➡ p.24
4	Security slot (🔒)	The security slot compatible with the MicroSaver security system manufactured by Kensington. For more details, visit the homepage of Kensington at http://www.kensington.com/ .
5	Screw holes to fix the cable cover	Screw holes to fix the cable cover in place. ➡ p.20
6	Air intake vent/Air filter cover	Intake vent for air used to cool the projector internally. When cleaning or replacing the air filter, open this cover and remove the air filter. ➡ p.113

Interface

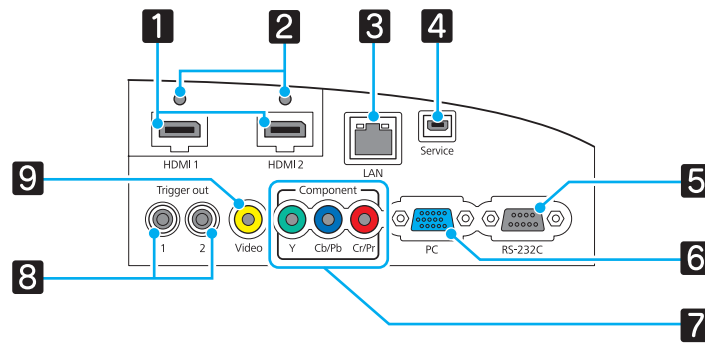

Name		Function
1	HDMI1/HDMI2 ports	Connects HDMI compatible video devices and computers. p.21
2	Cable holders	Insert the supplied HDMI cable clamp. Because thick HDMI cables with a large outer diameter, may disconnect easily due to the weight of the cable, secure the cables with the HDMI cable clamp. p.21 , p.22
3	LAN port	Connects a LAN cable to connect to a network. p.24
4	Service port	This port is a service port and should not normally be used.
5	RS-232C port	When controlling the projector, connect the projector to a computer with an RS-232C cable. This port is for control use and should not normally be used.
6	PC port	Connects to the RGB output port on a computer. p.22
7	Component ports	Connects to the component (YCbCr or YPbPr) output ports on video devices. p.21
8	Trigger out 1/Trigger out 2 ports	Connects with external devices such as motorized screens. p.22
9	Video port	Connects to the composite video output port on video devices. p.21



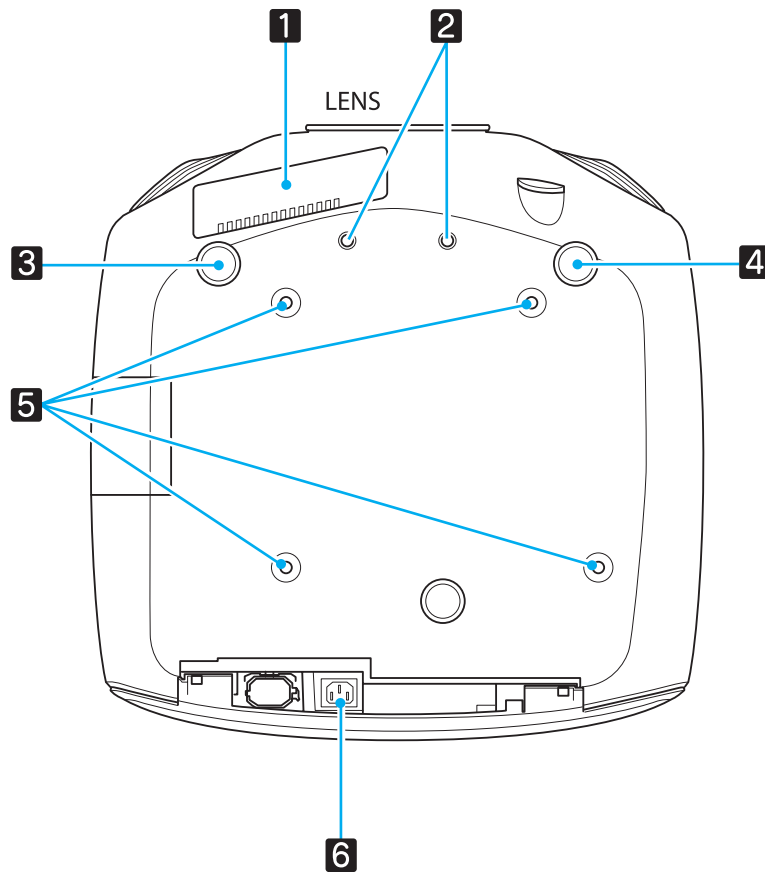



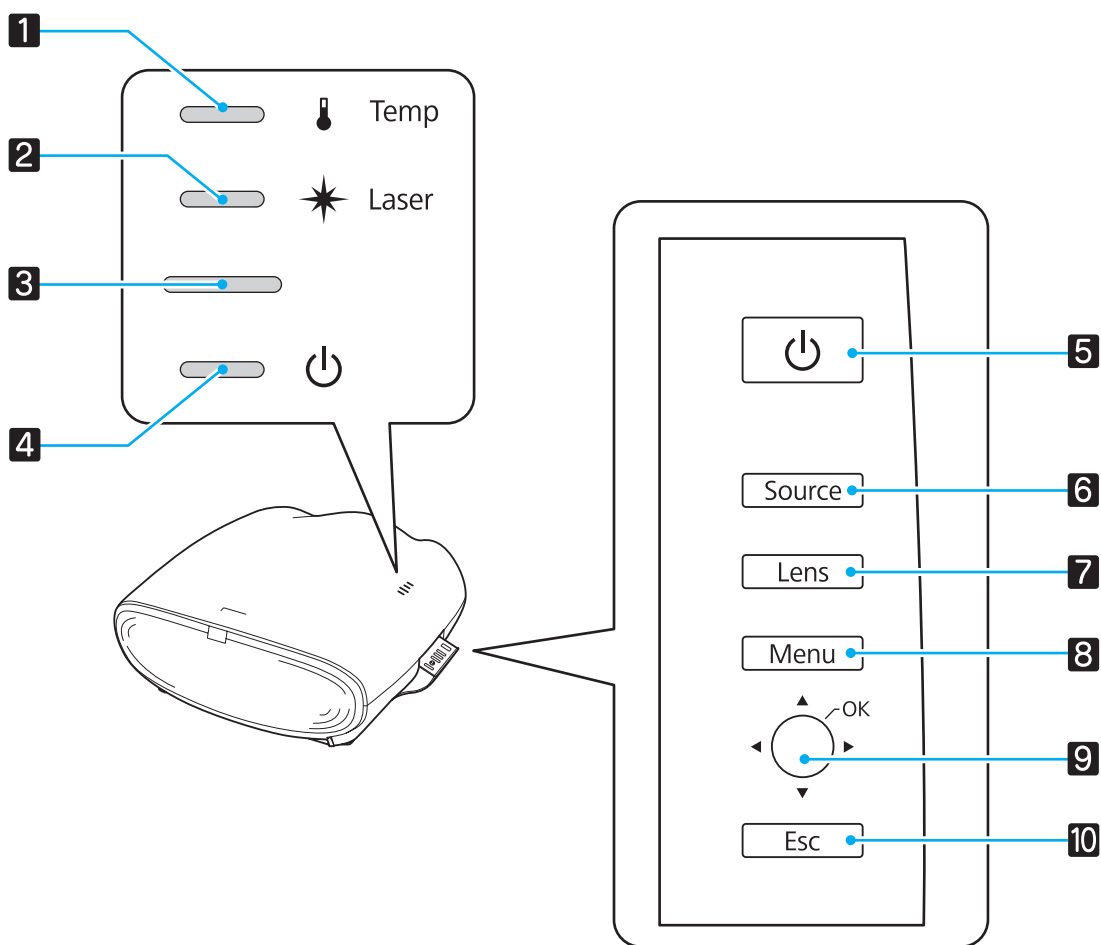

Base





Name		Function
1	Air intake vent	When suspending from a ceiling, install the projector so that dust does not collect in the vent.
2	Screw holes for anamorphic lens	Screw holes for attaching the anamorphic lens.
3	Front adjustable foot	Adjust the projector's horizontal tilt when placing and projecting. p.31
4		
5	Ceiling mount fixing points (four points)	Attach the ceiling mount here when suspending the projector from a ceiling.
6	Power inlet	Connect the power cord to the projector. p.27

Control Panel

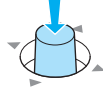

Buttons/Indicators	Function
1 	Flashes orange if the internal temperature is too high. Shows the projector's errors through a combination of other indicators lit and flashing. p.101
2 	Lit orange when an error occurs in the laser section. Shows the projector's errors through a combination of other indicators lit and flashing. p.101
3 	Flashes to indicate warm-up in progress or cool-down in progress. Shows the projector's status through a combination of other indicators lit and flashing. p.101
4 	Lit when the projector is on. Shows the projector's errors through a combination of other indicators lit and flashing. p.101
5 	Turns the projector power on or off. p.27
6 	Changes to the image from each input port. p.34
7 	Changes the adjustment item for the motorized lens function. The following adjustment items are available. <ul style="list-style-type: none"> • Focus p.32 • Zoom p.33 • Lens shift p.33
8 	Displays and closes the Configuration menu. p.29 On the Configuration menu, you can make adjustments and settings for Signal, Image, Input Signal, and so on. p.86







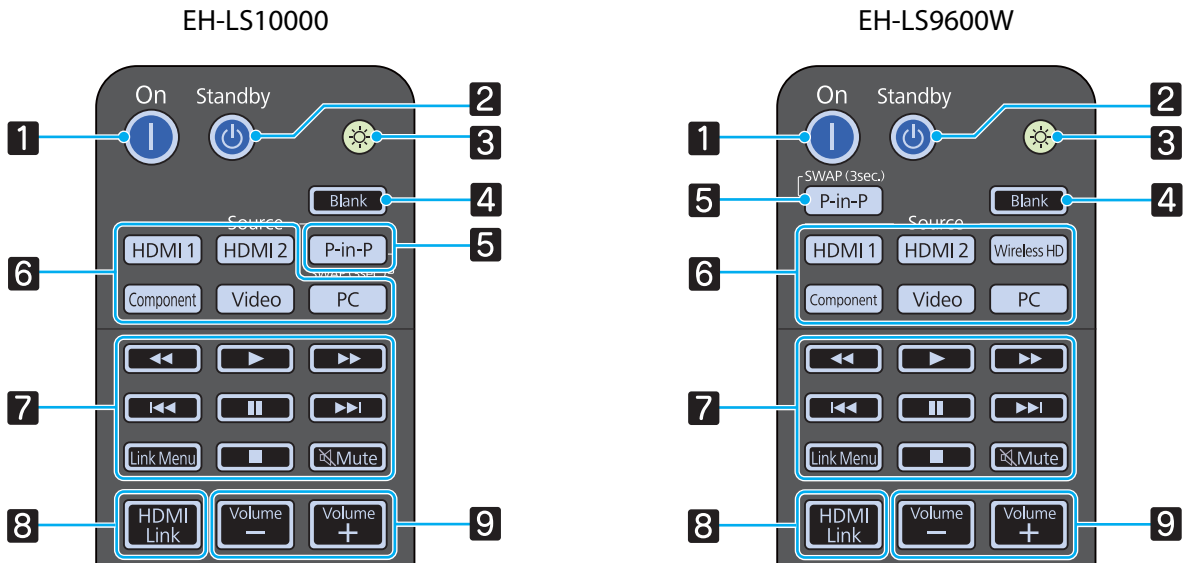







Buttons/Indicators		Function
9		<p>Move vertically and horizontally to select the adjustment value for the Configuration menu item. 🖱️ p.29</p> <p>Move vertically while projecting an image to correct keystone distortion. 🖱️ p.34</p>
		
10		When the Configuration menu is displayed, it moves to the previous menu level. 🖱️ p.29

Remote Control

Top section buttons









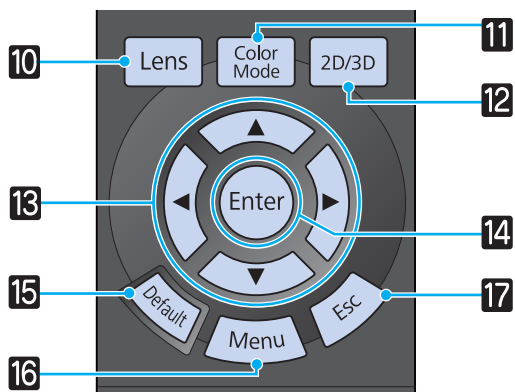











Button	Function
1	Turns the projector on. p.27
2	Turns the projector off. p.28
3	The remote control buttons light up for approximately 10 seconds. This is useful when operating the remote control in the dark.
4	Temporarily hides or shows the image. p.36 While the Configuration menu is displayed, the menu is temporarily hidden, and is displayed at the top-right of the screen.
5	Starts or exits Picture in Picture. p.79
6	Changes to the image from each input port. p.34 (The button is only available for EH-LS9600W.)

	Button	Function
7	        	<p>Performs operations such as play and stop for connected devices that meet the HDMI CEC standards.  p.60</p>
8		<p>Displays the HDMI link settings menu.  p.60</p>
9	 	<p>Adjusts the volume for connected devices that meet the HDMI CEC standards.</p>

Middle section buttons



	Button	Function
10		Changes the adjustment item for the motorized lens function. The following adjustment items are available. <ul style="list-style-type: none"> • Focus  p.32 • Zoom  p.33 • Lens shift  p.33
11		Changes the Color Mode .  p.44
12		Changes between 2D and 3D images.  p.39
13		Selects the Configuration menu items and adjustment values.  p.29
14		When the Configuration menu is displayed, it accepts and enters the current selection and moves to the next level.  p.29
15		The adjustment value returns to its default value when pressed while the Configuration menu's adjustment screen is displayed.  p.29
16		Displays and closes the Configuration menu.  p.29 On the Configuration menu, you can make adjustments and settings for Signal, Image, Input Signal, and so on.  p.29
17		When the Configuration menu is displayed, it moves to the previous menu level.  p.29

Bottom section buttons

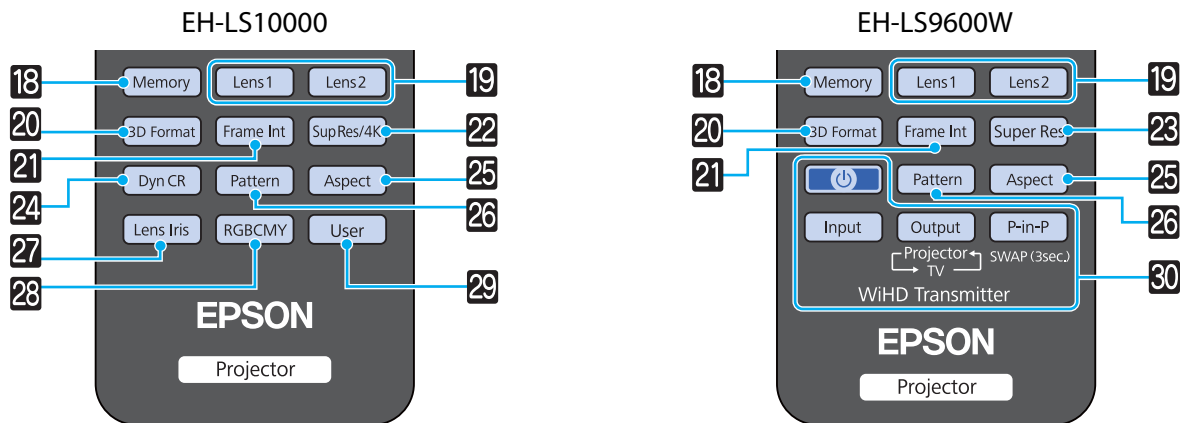

Button	Function
18 Memory	Saves, loads, or erases a memory, and allows you to change the name of a memory. p.64
19 Lens1 Lens2	Loads the lens position. p.63
20 3D format	Changes the 3D format. p.39
21 Frame Int	Reduces the jarring effect caused by quick movements by interpolating frames, and adjusts to render a smoother, clearer image. p.49
22 SupRes/4K	(EH-LS10000 only) Sets Super-resolution to reduce blurring in areas such as the edges of the image, or 4K Enhancement for ultra high definition images.
23 Super Res	(EH-LS9600W only) Sets Super-resolution to reduce blurring in areas such as the edges of the image.
24 Dyn CR	Sets Dynamic Contrast . p.48
25 Aspect	Selects the aspect mode according to the input signal. p.35
26 Pattern	Displays and closes the test pattern. p.31
27 Lens Iris	Lens Iris uses the lens' diaphragm to adjust the amount of light that enters the lens, which adjusts the contrast of the image. p.55
28 RGBCMY	Adjusts the hue, saturation, and brightness for each RGBCMY color. p.50
29 User	Performs the function assigned to the user button. p.91
30 Power Input Output P-in-P	WirelessHD Transmitter control Turns on the WirelessHD Transmitter, or switches the input and output. Make sure you point the remote control at the WirelessHD Transmitter when performing operations. p.67



Installing

Notes on Installing

Warning

Ceiling mount installations

- A special method of installation is required when suspending the projector from a ceiling (ceiling mount). If it is not installed correctly, it could fall causing an accident and injury.
- If you use adhesives, lubricants, or oil on the ceiling mount fixing points to prevent screws from loosening, or if you use things such as lubricants or oils on the projector, the projector case may crack causing it to fall from its ceiling mount. This could cause serious injury to anyone under the projector and also damage the projector.
- Do not setup the projector on its side. This may cause malfunctions to occur.
- Try not to setup the projector in locations subject to high humidity and dust, or in locations subject to smoke from fires or tobacco smoke.

Warning

Class 2 laser product

- Do not look into the lens during projection. Also, do not look into the lens using optical devices (such as a magnifying glass or telescope).
- Do not allow small children to make operations. If children do make operations, they must be accompanied by an adult.

Caution

- When lifting the projector, be careful not to drop it as it is heavy and could cause an injury.
- When installing the projector on a shelf and so on, take additional measures to prevent it from falling, such as securing with a wire. If it falls it could cause an injury.

Attention

- When lifting the projector, make sure you close the control panel.
- Do not apply excessive force to the control panel section. This may cause malfunctions to occur.
- Make sure there is at least 20 cm between the wall and the projector's air intake vent.

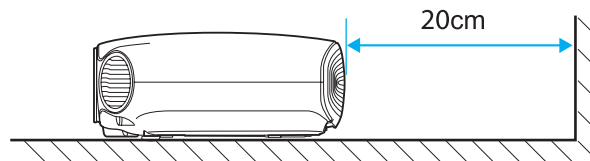

- It is recommended that you clean the air filter periodically. Clean more frequently if you are using the projector in a particularly dusty environment.  [p.113](#)

How to Install

The projector can be installed using a variety of methods, such as placing on a shelf or suspending from a ceiling. Using the lens shift function gives you more flexibility to place the projector where you want. 🖱️ [p.33](#)

■ Placing on a shelf and projecting

You can install the projector in an AV rack or on a shelf in your living room to project images.

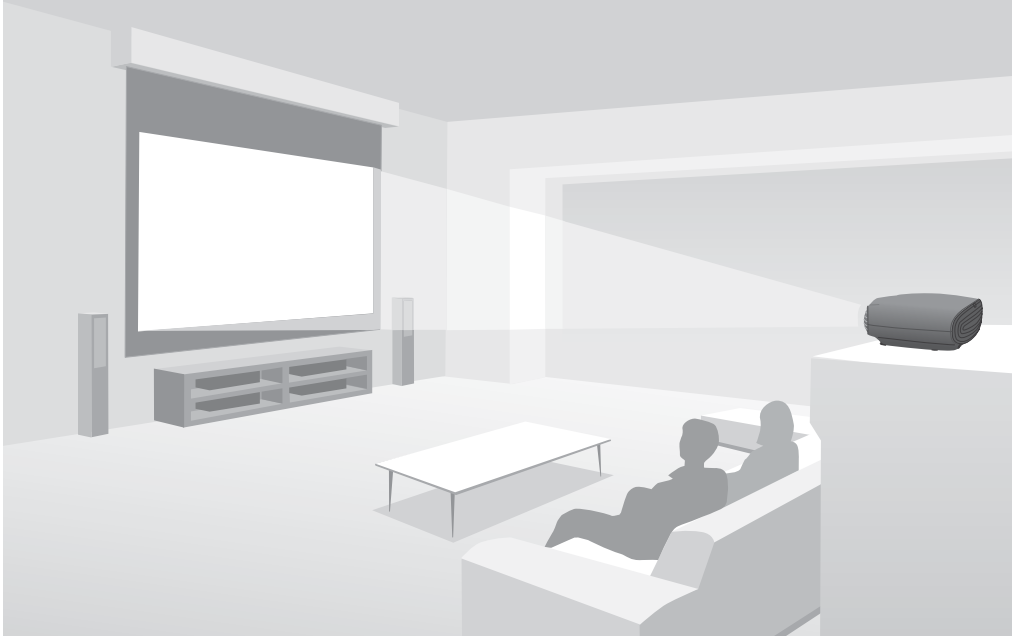

■ Suspending from the ceiling and projecting

You can suspend the projector from the ceiling creating a real theater-room atmosphere.

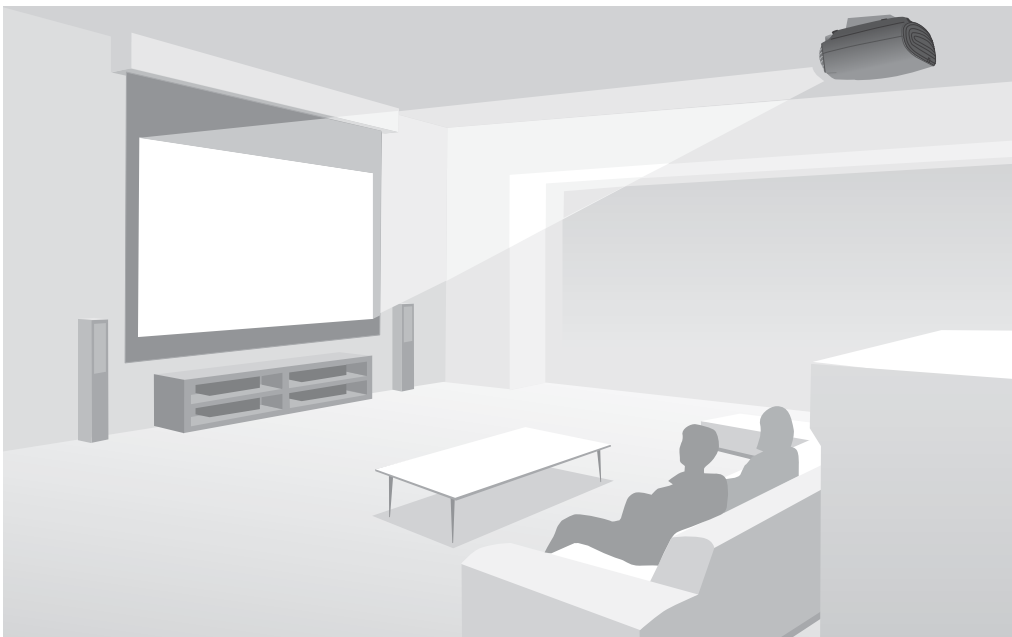

When projecting from a ceiling, change **Projection** to a ceiling setting. 🖱️ **Settings - Projection** [p.91](#)

Projection Distance and Lens Shift Maximum Values

The size of the projection increases as the projector is moved away from the screen. Use the following table to setup the projector so that it projects at the optimum size. The values given here are for your reference only.

You can also adjust the position by projecting using lens shift. [p.33](#)

The maximum lens shift adjustment values are shown in the following table.

When adjusting the projection position vertically in lens shift

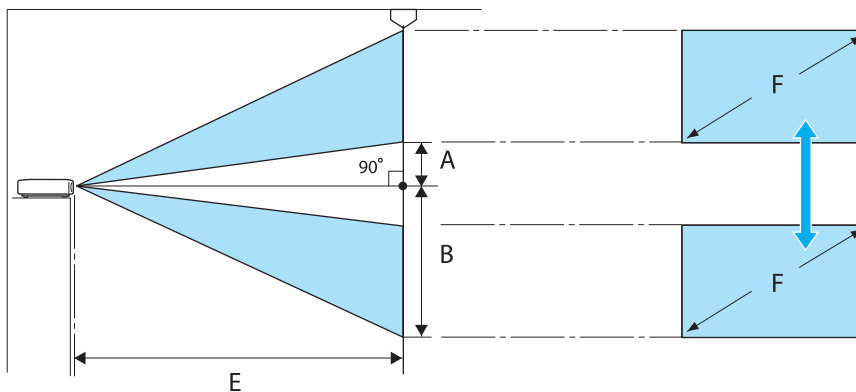

- A : Distance from the center of the lens to the bottom edge of the projected image (when lens shift is raised to its highest level)
- B : Distance from the center of the lens to the bottom edge of the projected image (when lens shift is lowered to its lowest level)
- E : Projection distance from the projector to the screen
- F : Size of the projected image

When adjusting the projection position horizontally in lens shift

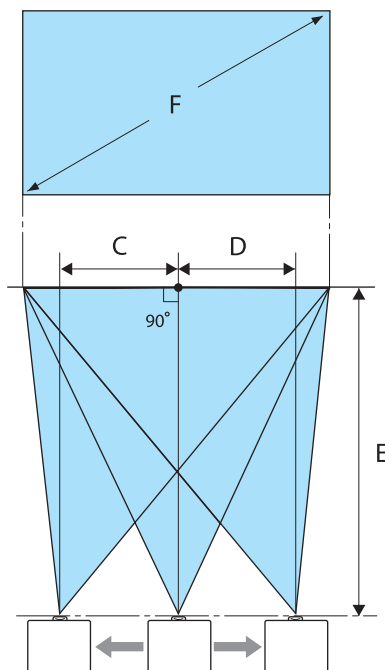

- C : Lens center movement distance when the projector is moved (when lens shift is set to maximum right)
- D : Lens center movement distance when the projector is moved (when lens shift is set to maximum left)
- E : Projection distance from the projector to the screen
- F : Size of the projected image

16:9 Projected Image Size		Projection Distance (E)		Lens Shift Maximum Values*		
F	W x H	Minimum (Wide)	Maximum (Tele)	Distance (A)	Distance (B)	Distance (C, D)
40"	89 x 50	111	240	20	70	35
60"	130 x 75	169	361	30	105	53
80"	180 x 100	226	482	40	139	71
100"	220 x 120	283	604	50	174	89
120"	270 x 150	341	725	60	209	106
150"	330 x 190	427	908	75	262	133
180"	440 x 250	513	1090	90	314	159

4:3 Projected Image Size		Projection Distance (E)		Lens Shift Maximum Values*		
F	W x H	Minimum (Wide)	Maximum (Tele)	Distance (A)	Distance (B)	Distance (C, D)
40"	81 x 61	137	294	24	85	43
60"	120 x 90	207	443	37	128	65
80"	160 x 120	277	591	49	171	87
100"	200 x 150	348	740	61	213	108
120"	240 x 180	418	889	73	256	130
150"	300 x 230	523	1112	91	320	163
200"	410 x 300	699	1483	122	427	217

* The position of the projected image cannot be moved to the maximum horizontal and vertical values at the same time. 🖱️ [p.33](#)

Connecting a Device

Attention

- Make cable connections before connecting to a power outlet.
- Check the shape of the cable's connector and the shape of the port, and then connect. If you force a connector of a different shape into the port, it could cause damage and a malfunction to occur.

Removing the Cable Cover

You can attach the cable cover to the rear of this projector to give it a clean and smooth look. Remove the cover when connecting devices using cables, or when replacing the air filter.

- 1 Loosen the screws at the lower edges of the cable cover, and then pull it forward.

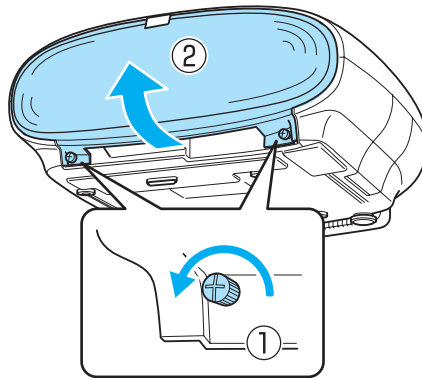

- 2 Lift the cable cover out of the grooves at the top.

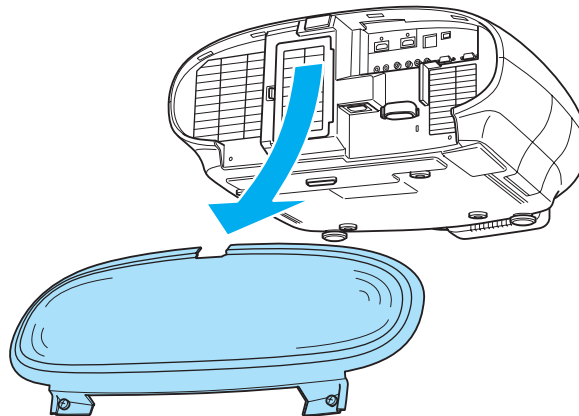

To attach the cable cover, perform this procedure in reverse.

Connecting Video Devices

To project images from Blu-ray disc players or video recorders and so on, connect to the projector using one of the following methods.



- Depending on the video device, there may be multiple types of output available. Check the documentation supplied with the video device to confirm the output types.
- This projector does not have a built-in speaker. Connect the projector to your AV system to listen to audio from connected equipment.

Equipment with HDMI output ports

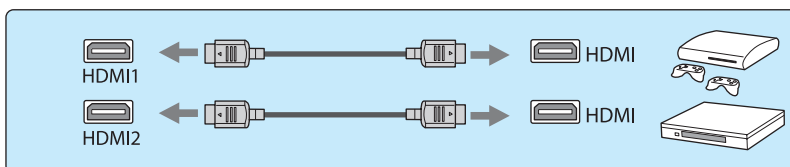
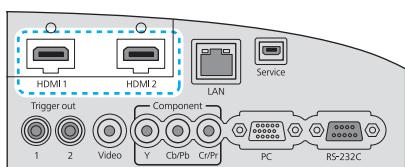

To prevent the weight of the HDMI cable disconnecting it from the port, make sure you secure it to the cable holder with the HDMI cable clamp.

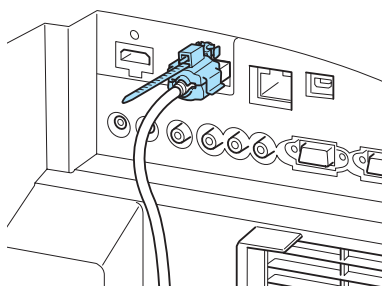

Equipment with a video output port

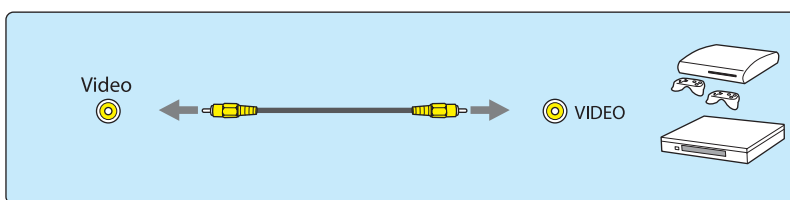
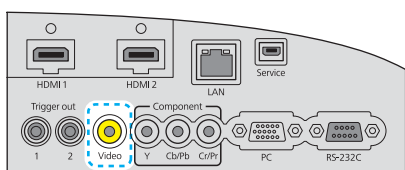

Equipment with component video output ports

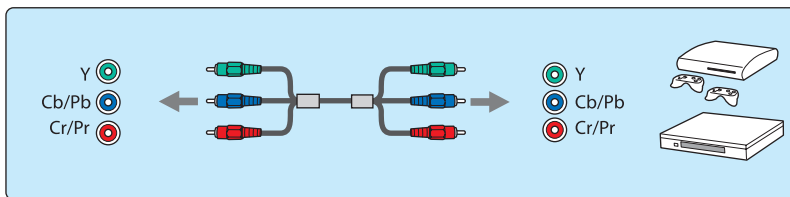
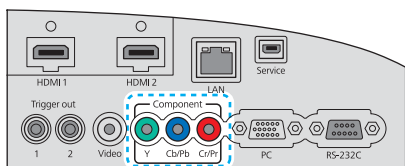

Connecting a Computer

To project images from a computer, connect the computer using one of the following methods.

Computers with an RGB output port

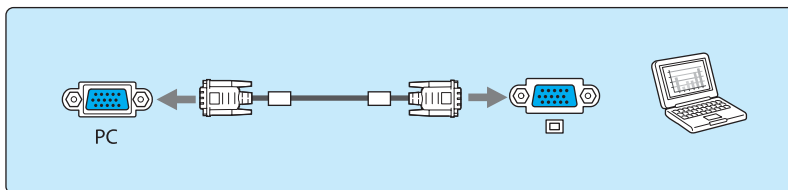
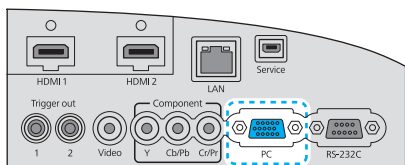

Computers with an HDMI output port

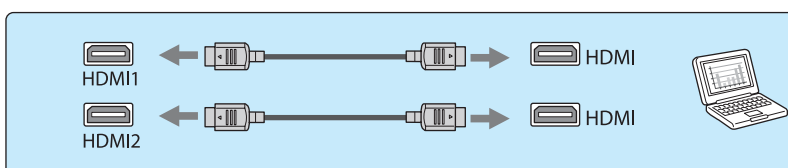
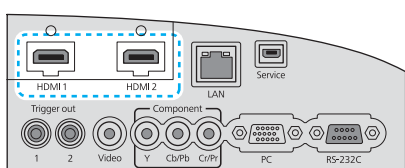

To prevent the weight of the HDMI cable disconnecting it from the port, make sure you secure it to the cable holder with the HDMI cable clamp.

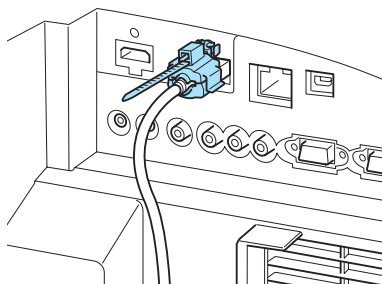

Connecting External Devices

Connecting to Trigger out 1/Trigger out 2 ports

To connect external devices such as motorized screens, connect a mini-jack stereo cable (3.5 mm).

When set to on, a signal (12 V DC) is output from this port to communicate the projector's status (on/off) to connected devices such as electric screens.

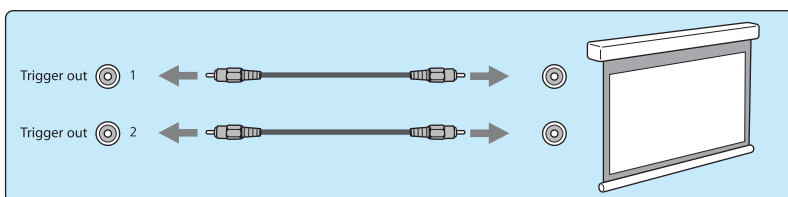
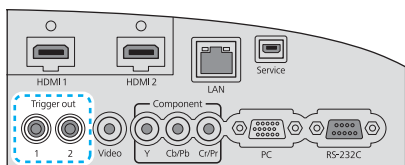

When using the Trigger out 1/Trigger out 2 ports, set Trigger Out 1/Trigger Out 2. **Settings - Operation - Trigger Out 1/Trigger Out 2** p.91

Connecting WirelessHD devices (EH-LS9600W only)

The projector receives transmissions from the WirelessHD Transmitter, and projects the images. [p.67](#)

Change the projected image by pressing the **WirelessHD** button on the remote control or the **Source** button on the control panel.



- When receiving WirelessHD images, make sure **WirelessHD** is set to **On**. [Settings - WirelessHD - WirelessHD p.91](#)
- You can change which device is displayed by selecting a device from **Device Connections** in **HDMI Link**. [HDMI Link - Device Connections p.61](#)

Connecting MHL devices (EH-LS9600W only)

You can connect MHL compatible smart devices or tablets to the WirelessHD Transmitter.

Use an MHL compatible cable to connect the micro USB port of MHL devices to the HDMI5 port on the WirelessHD Transmitter.

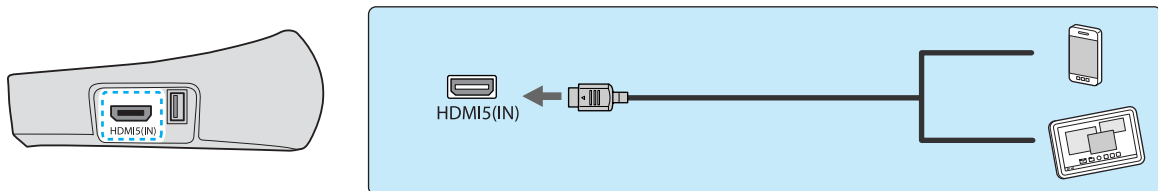

You can operate MHL devices from the projector's remote control.

You can also view video and listen to music while charging an MHL device.

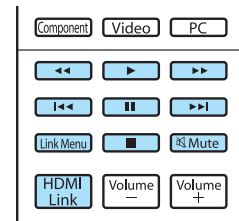

Warning

Be sure to use an MHL compatible cable for making connections. If you use a cable that is not compatible when charging, a fire could occur due problems such as overheating the MHL device, leaks, and explosions.

Attention

- When a connection is made using an MHL-HDMI conversion adapter, it may not be possible to charge or control the device from the remote control.
- This may not be available depending on the MHL device being used. For more details, contact the manufacturer of the MHL device.



- Some devices use more power during video playback than what is supplied and will therefore not enable charging during video playback or other operations.
- If the image is not projected, try disconnecting and then reconnecting the cable. If the image is still not projected after reconnecting the cable, contact the manufacturer of the MHL device.

Connecting to the LAN port

Connect to a network router, a hub, and so on, with a 100BASE-TX or 10BASE-T LAN cable.

You can operate the projector or check its status over a network from a computer or a smart device.

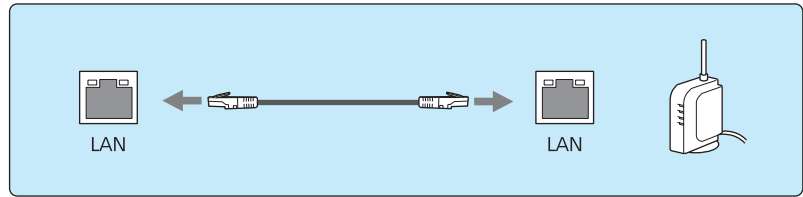
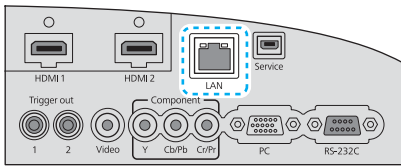

- To prevent malfunctions, use a category 5 or higher shielded LAN cable.
- You cannot project images over a network.

Securing Cables with the Cable Clamp

You can use the cable clamp to secure cables that have been connected to the projector.

1 Open the cable clamp.

Press the surface of the clamp gently with your finger to release the tab, and then pull it to swing it open.

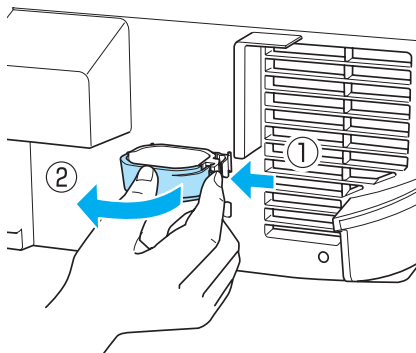

2 Gather the cables into the cable clamp.

You can gather all cables except for the power cord into the cable clamp.

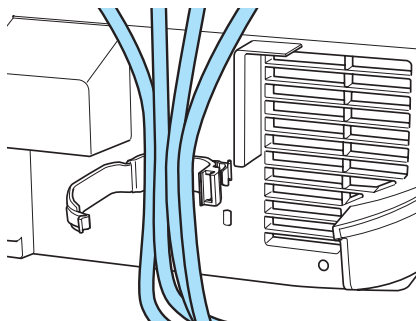

3 Close the cable clamp.

Press until the tab clicks into place.

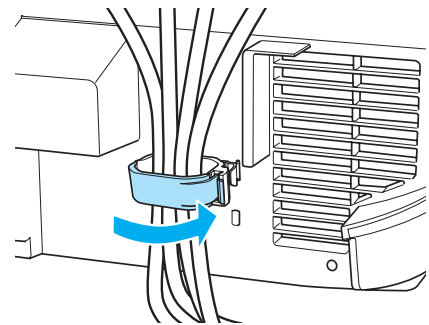



Preparing the Remote Control

Installing Batteries

Attention

- Check the positions of the (+) and (-) marks inside the battery holder to ensure the batteries are inserted the correct way.
- You cannot use other batteries except for the AA size manganese or alkaline.

- 1** Remove the battery cover.
While pushing the battery compartment cover catch, lift the cover up.

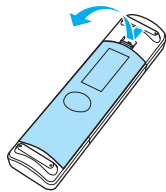

- 2** Install the batteries.
Check the polarity of the batteries (+) and (-) before installing.

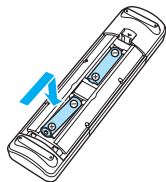

- 3** Reattach the battery cover.
Press the cover until it clicks into place.

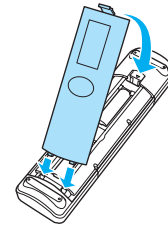

 If delays in the responsiveness of the remote control occur or if it does not operate, it probably means that the batteries are becoming flat. When this happens, replace them with new batteries. Have two AA size manganese or alkaline batteries ready.

Remote Control Operating Range

The remote control operating range is shown in the following figures.

Operating range (left to right)

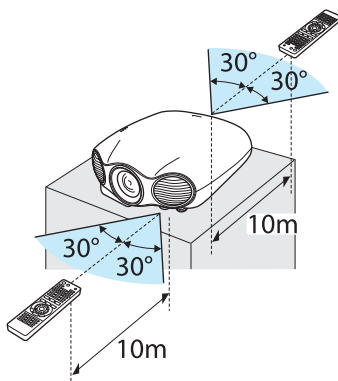

Operating range (top to bottom)

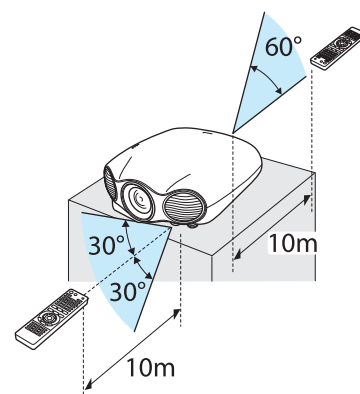



The operation range for the WirelessHD Transmitter differs.  [p.75](#)

Turning the Projector On and Off

Turning On

Warning

- Do not allow small children to make operations. If children do make operations, they must be accompanied by an adult.
- Do not look into the lens during projection. Also, do not look into the lens using optical devices (such as a magnifying glass or telescope). Powerful light can damage your eyes and cause visual impairment. Families with small children should take particular care.
- When turning on the projector at a distance using the remote control, make sure there is no one looking into the lens.

- 1 Connect the equipment to the projector.
- 2 Connect the power cord.
Connect using the power cord supplied.
- 3 Turn on the connected equipment.

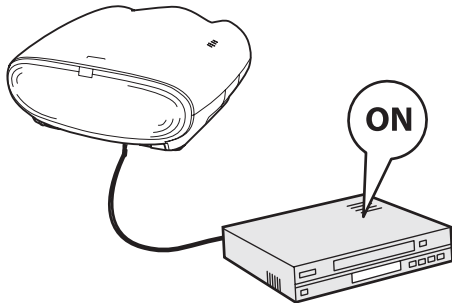

- 4 Press the button on the remote control or the control panel to turn on the projector.

Remote control

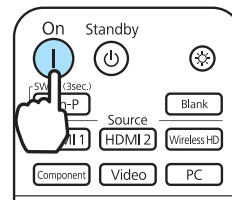

Control panel

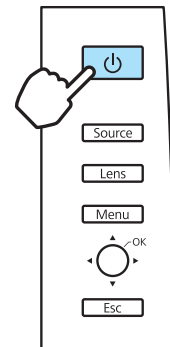

The lens shutter opens, and projection starts.



When **Direct Power On** is set to **On**, you can start projecting by simply connecting the power cord to the projector without having to press any buttons.  **Settings - Operation - Direct Power On** p.91

Attention

When using at an altitude of 1500 m or more, set **High Altitude Mode** to **On**.  **Settings - Operation - High Altitude Mode** p.91



- To obtain stable image quality, it is recommended that you leave the projector on for a while before starting operations.
- This projector provides a Child Lock function to prevent children from accidentally turning the power on and a Control Panel Lock function to prevent accidental operations. **Settings - Lock Setting - Child Lock/Control Panel Lock** p.91
- This projector comes with a Trigger out 1/Trigger out 2 ports to communicate the current status of the projector's power (on/off) to external devices. When using this function, set **Trigger Out 1/Trigger Out 2**. **Settings - Operation - Trigger Out 1/Trigger Out 2** p.91

Turning Off

1

Turn off the connected equipment.



When **Power Off Link** is set to **On** in the **HDMI Link** menu, turning off HDMI CEC compatible equipment also turns off the projector. **Settings - HDMI Link - Power Off Link** p.91

2

Press the  button on the remote control or the projector's control panel.

Remote control

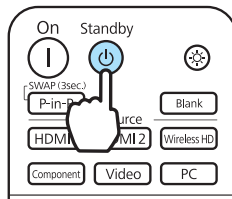

Control panel

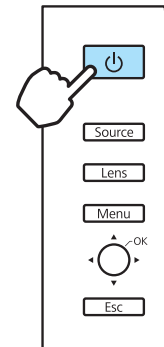

Projection ends, and the lens shutter closes automatically.



- When **Standby Confirmation** is set to **On**, a confirmation message is displayed, and the power turns off when you press the  button again. **Settings - Display - Standby Confirmation** p.91
- When you turn off the projector, the operation indicator flashes for a while as the projector cools down. When the operation indicator turns off, cool-down is complete.

3

Disconnect the power cord.

Configuration Menu Operations

Using the Configuration menu, you can make adjustments and settings for images or image quality.

- For items adjusted using an adjustment bar, such as the brightness level, you can press the **Default** button while the adjustment screen is displayed to return the adjustment value to its default value.
- You can also operate the Configuration menu from the control panel.

1 Press the **Menu** button on the remote control.

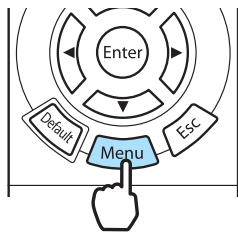

The Configuration menu is displayed.

2 Use the **Up** and **Down** buttons to select the top menu on the left, and then press the **Enter** button to confirm the selection.

When you select the top menu on the left, the sub menu on the right changes.

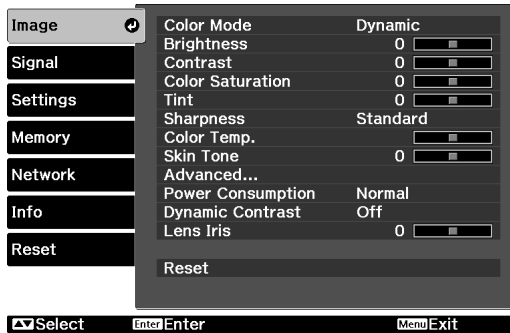

The line at the bottom is a guide for operations.

3 Use the **Up** and **Down** buttons to select the sub menu on the right, and then press the **Enter** button to confirm the selection.

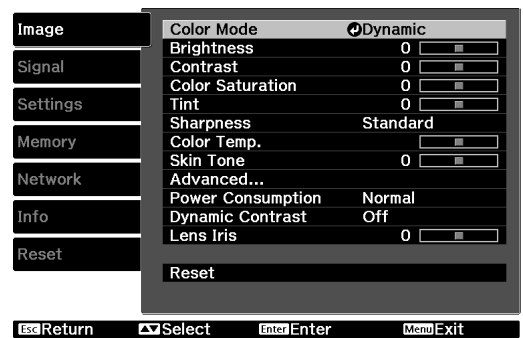

The adjustment screen for the selected function is displayed.

4 Use the **Up**, **Down**, **Left**, and **Right** buttons to adjust the settings.

Ex.) Adjustment bar



Ex.) Choices



Press the **Enter** button on an item displaying this **Enter** icon to change to the selection screen for that item.

Press the **Esc** button to return to the previous level.

5

Press the  button to exit the menu.

Adjusting the Projected Screen

Displaying the Test Pattern

Immediately after installation, a test pattern is used to adjust the zoom, focus, and the projection position. Press the **Pattern** button on the remote control to display the test pattern.

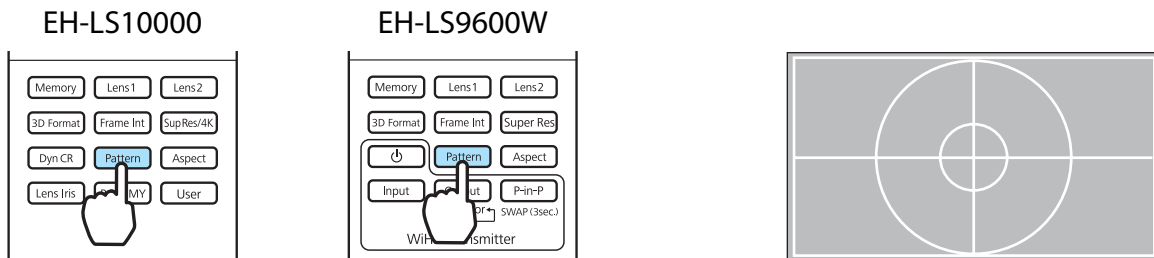

You can also select patterns that display R (red), G (green), and B (blue) individually, as well as the pattern for adjusting the display position. You can use it as a pattern to perform color adjustment when an image signal is being input.

Press the **Esc** button or select **Exit** to end the test pattern display.

Adjusting the Projector's Tilt

If the projected image is tilted (the left and right sides of the projector are at different heights) when the projector is setup on a shelf, adjust the front foot so that both sides are level with each other.

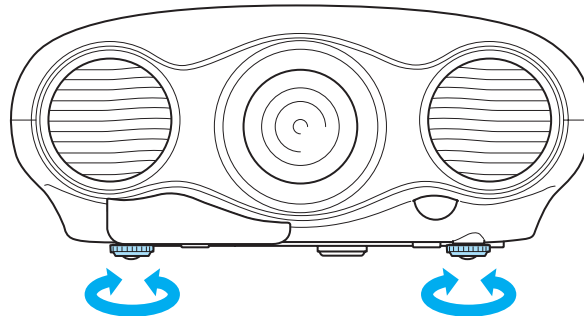

Lens Adjustment Function (Focus, Zoom, Lens Shift)

To adjust the focus, zoom, or lens shift, press the **Lens** button on the remote control or the control panel, and then select the item you want to adjust.

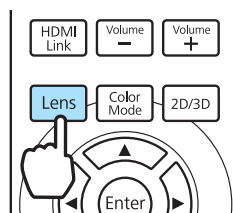

The adjustment items switch as shown in the following table.

1	Focus adjustment	Adjust Focus is displayed on the screen. Adjusts the focus of the projected image. p.32
2	Zoom adjustment	Adjust Zoom is displayed on the screen. Adjusts the size of the projected image. p.33
3	Lens shift adjustment	Adjust Lens Shift is displayed on the screen. Adjusts the position of the projected image. p.33

To finish making adjustments, press the Lens button in Lens shift adjustment.



- Using the lens position function, you can save and load lens adjustment positions.
- When you select **Adjust Lens Shift** and the following message is displayed, the image position is adjusted in the opposite direction to the lens shift using the buttons.

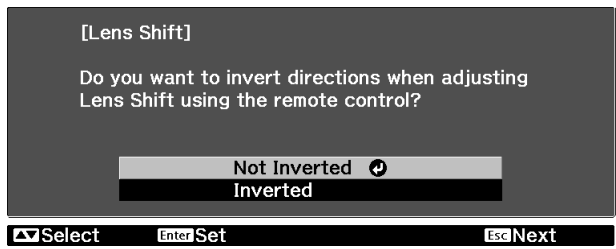

If you make the following selections in **Projection** settings, the image is adjusted in the same direction as the buttons. [Settings - Projection p.91](#)

- Front, Rear: Not Inverted**
- Front/Ceiling, Rear/Ceiling: Inverted**

Adjusting the focus

Press the buttons to adjust the focus.

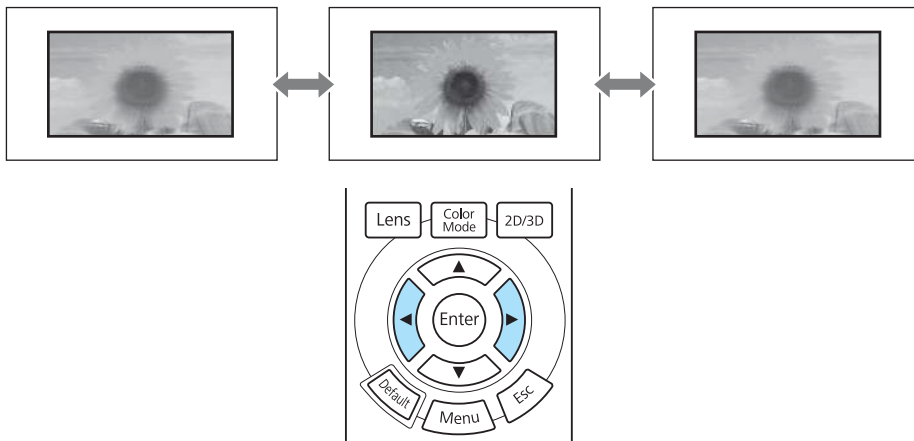

Adjusting the projection size (zoom adjustment)

Press the ◀ ▶ buttons to adjust the size of the projected screen.

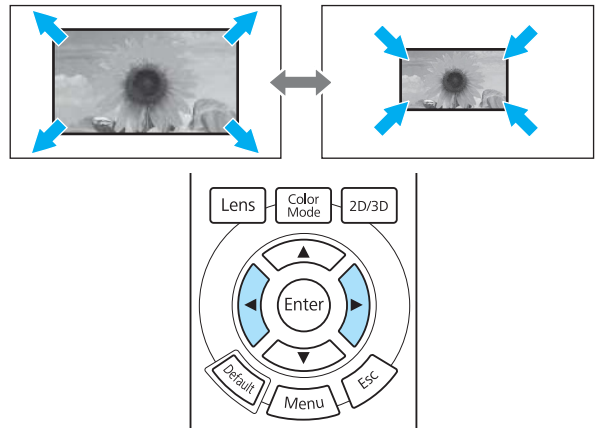

Adjusting the position of the projected image (lens shift)

If the projector cannot be setup in front of the screen, you can adjust the position of the image by using lens shift.

Use the ▲ ▼ ◀ ▶ buttons to adjust the position of the image.

 Hold down the ▲ ▼ ◀ ▶ buttons to return to the center position.

You can move the image within the range indicated by the dotted line in the figure on the right.

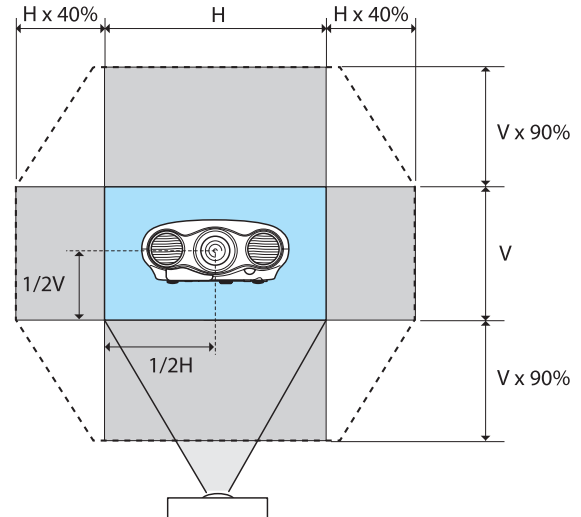

Caution

When transporting the projector, set the vertical and horizontal lens positions to the center. If you transport the projector when the lens is shifted up, down, left, or right, the lens shift mechanism could be damaged.

 When you cannot install the projector directly in front of the screen, it is recommended that you use lens shift to adjust the projection position. If you cannot adjust using lens shift, try using keystone correction.

Keystone

You can use the  button on the control panel to correct keystone distortion.

Move the  button up or down to display the adjustment gauges.

When the gauges are displayed, move the  button up or down to perform vertical correction.

When the top or bottom is too wide

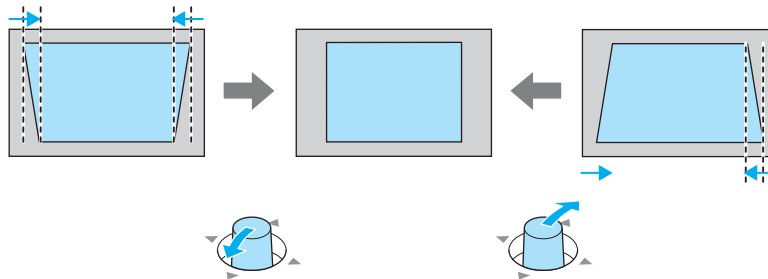

- The projected screen becomes smaller when correcting keystone distortion. Increase the projection distance to fit the projected screen to the screen size.
- You can make keystone settings from the Configuration menu.  **Settings - Keystone** p.91
- You can make effective corrections within a projection angle of 30° top to bottom.
- For position adjustment, you can maintain the quality of the projected image by performing correction using lens shift. Use keystone when you cannot make adjustments using lens shift.

Switching the Source

You can change the source using the following method.

Press the button for the target port.

EH-LS10000

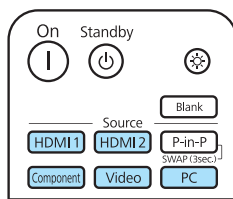

EH-LS9600W

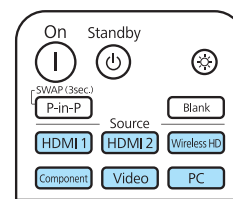

- You can also change the source by pressing the button on the control panel.
- For video devices, start playback first and then change the source.
- If the color looks unnatural when changing to a **Video** or **Component** source, check that the port you have connected to is the same as the **Input Signal**.  **Settings - Input Signal - Video Signal/Component** p.91

Aspect

You can change the input signal's type, aspect ratio, and resolution to match the **Aspect** of the projection screen.

The available **Aspect** varies depending on the image signal currently being projected.

 Note that using the aspect ratio function of the projector to reduce, enlarge, or split the projected image for commercial purposes or for public viewing may infringe upon the rights of the copyright holder of that image based on copyright law.

1 Press the **Aspect** button.

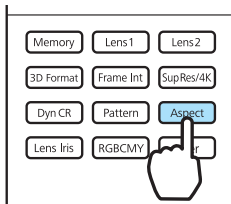

EH-LS10000



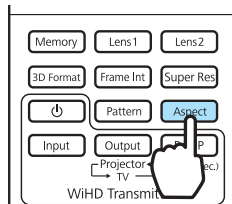

EH-LS9600W

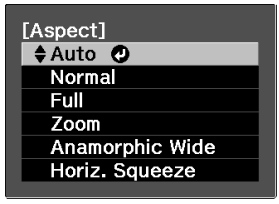

 You can make settings from the Configuration menu. **Signal - Aspect** [p.88](#)

2 Use the   buttons to select the setting name, and then press the  button to confirm the selection.



 **Aspect** may not be available depending on the type of signal.

By normally selecting Auto, the optimum aspect is used to display the input signal. Change the setting if you want to use a different aspect.

The table below shows the image projected on a 16:9 screen.

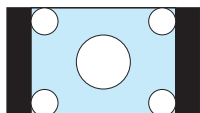
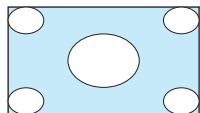
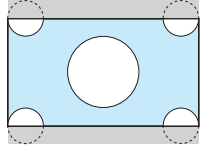
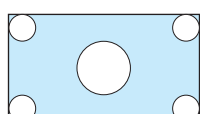
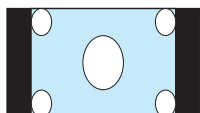
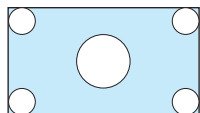
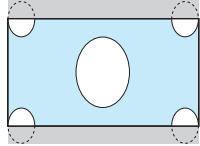
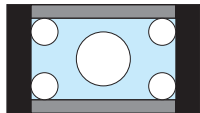
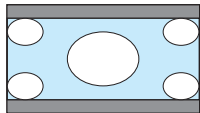
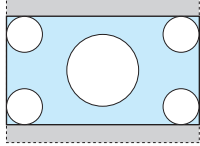
Input Image	Setting Name (Aspect)		
	Normal	Full	Zoom
4:3 images			
16:9 images		When projecting 16:9 images, Full and Zoom cannot be selected.	
Images recorded using squeeze			
Letterbox images*			

Input Image	Setting Name (Aspect)		
	Normal	Full	Zoom
Notes	Matches the vertical size of the projection panel. The aspect ratio differs depending on the input image.	Uses the entire projection panel.	Retains the aspect ratio of the input signal, and matches the horizontal size of the projection panel. The top and bottom of the image may be truncated.

* The letterbox image used in this explanation is a 4:3 aspect ratio image displayed in 16:9 with black margins at the top and bottom for subtitle placement. The margins at the top and bottom of the screen image are used for subtitles.

With this projector you can also set **Anamorphic Wide** and **Horiz. Squeeze**.

Set **Anamorphic Wide** and attach a commercially available anamorphic lens to enjoy DVDs, Blu-rays, and so on of images recorded at Cinema Scope size.

Horiz. Squeeze stretches the horizontal aspect of the input signal. This allows you to project across the full width of the screen when using a commercially available anamorphic lens.



- If **Anamorphic Wide** is selected when **Overscan** is set, the image may be truncated. Set **Overscan** to **Off** and then project. **Signal - Advanced - Overscan p.88**
- When projecting 3D images in **Anamorphic Wide**, only 1080p/24 Hz/frame packing signals are supported.
- When a 4K image signal is being input, you can only select **Normal**, **Anamorphic Wide**, and **Horiz. Squeeze**.

Hiding the Image Temporarily

You can use this to temporarily hide the image on the screen.

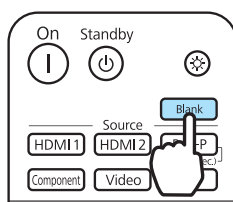

Press the **Blank** button to show or hide the image.

EH-LS10000

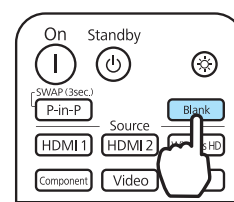

EH-LS9600W



- Because moving images continue to play even when they are hidden, you cannot return to the point at which you hid the images using the **Blank** button.
- If the **Blank** button is pressed while the Configuration menu is displayed, the menu is temporarily hidden, and  is displayed at the top-right of the screen.
- If you press the  button on the remote control or the control panel while the image is hidden, a confirmation message is displayed asking if you want to turn off the projector. Press the  button again to turn off the projector.



Viewing 3D Images

This projector allows you to view 3D images using 3D Glasses.



- Since the 3D Glasses use the active shutter method, they need to be charged in advance. [p.41](#)
- You also need to pair the 3D Glasses with the projector in advance. [p.41](#)

Warnings Regarding Viewing 3D Images

Note the following important points when viewing 3D images.



Warning

Disassembling or remodeling

- Do not disassemble or remodel the 3D Glasses.
This could cause a fire to occur or the images to appear abnormal when viewing, causing you to feel unwell.

Storage locations

- Do not leave the 3D Glasses or the supplied parts within reach of children.
If they are not handled correctly, they could cause an injury.

Wireless (Bluetooth) communication

- Electromagnetic interference may cause medical equipment to malfunction. Before using the device, make sure there is no medical equipment in the vicinity.
- Electromagnetic interference may cause automatically controlled equipment to malfunction which could cause an accident. Do not use the device near automatically controlled equipment such as automatic doors or fire alarms.

Heating

- Do not place the 3D Glasses in a fire, on a heat source, or leave them unattended in a location subject to high temperatures. Because this device has a built-in rechargeable lithium battery, it could cause burns or a fire if it ignites or explodes.

Charging

- When charging, connect the supplied cable to the USB port designated by Epson. Do not charge using other devices as it may cause the battery to leak, overheat, or explode.
- Only use the supplied charging cable to charge the 3D Glasses. Otherwise, it could overheat, ignite, or explode.



Caution

3D Glasses

- Do not drop or press too forcefully on the 3D Glasses.
If the glass sections and so on are broken, an injury could occur. Store the glasses in the soft glasses case.
- Be careful of the edges of the frame when wearing the 3D Glasses.
If it pokes your eye and so on, an injury could occur.
- Do not place your finger in any of the moving sections (such as the hinges) of the 3D Glasses.
Otherwise an injury could occur.

 **Caution**

Wearing 3D Glasses

- Make sure you wear the 3D Glasses correctly.
Do not wear the 3D Glasses upside down.
If the image is not displayed correctly into the right and left eyes, it could cause you to feel unwell.
- Do not wear the glasses unless you are viewing a 3D image.
- How a 3D image is perceived varies depending on the individual. Stop using the 3D function if you feel strange or cannot see in 3D.
Continuing to view the 3D images could cause you to feel unwell.
- Stop wearing the 3D Glasses immediately if they seem abnormal or a malfunction occurs.
Continuing to wear the 3D Glasses could cause an injury or cause you to feel unwell.
- Stop wearing the 3D Glasses if your ears, nose, or temples become red, painful, or itchy.
Continuing to wear the 3D Glasses could cause you to feel unwell.
- Stop wearing the 3D Glasses if your skin feels unusual when wearing the glasses.
In some very rare cases the paint or materials used in the 3D Glasses could cause an allergic reaction.

 **Caution**

Viewing time

- When viewing 3D images, always take periodic breaks during extended viewing.
Long periods of viewing 3D images may cause eye fatigue.
The amount of time and frequency of such breaks varies from person to person. If your eyes still feel tired or uncomfortable even after taking a break from viewing, stop viewing immediately.

 **Caution**

Watching 3D images

- If your eyes feel fatigued or uncomfortable when viewing 3D images, stop viewing immediately.
Continuing to view the 3D images could cause you to feel unwell.
- When viewing 3D images be sure to always wear 3D Glasses. Do not attempt to view 3D images without 3D Glasses.
Doing so could cause you to feel unwell.
- Do not place any breakable or fragile objects around you when using 3D Glasses.
3D images may cause you to move your body involuntarily, resulting in damage to nearby items or personal injury.
- Only wear 3D Glasses when viewing 3D images. Do not move around while wearing 3D Glasses.
Your vision may appear darker than normal, causing you to fall or injure yourself.
- Try to stay as level with the viewing screen as possible when viewing 3D images.
Viewing 3D images at an angle reduces the 3D effect and may cause you to feel unwell due to unintended color changes.
- If using 3D Glasses in a room with fluorescent or LED lighting, you may see flashing or flickering throughout the room. If this should occur, reduce the lighting until the flickering goes away or turn off the lights completely when viewing 3D images. In some very rare cases, this flickering could trigger seizures or fainting for some individuals. If you begin to feel uncomfortable or unwell at any time when viewing 3D images, stop immediately.
- Stay at least three times the height of the screen away from the screen when viewing 3D images.
The recommended viewing distance for an 80-inch screen is at least 3 meters, and at least 3.6 meters for a 100-inch screen.
Sitting or standing any closer than the recommended viewing distance may result in eye fatigue.

 **Caution**

Health risks

- You should not use 3D Glasses if you are sensitive to light, have a heart condition, or are unwell. Doing so could aggravate your pre-existing conditions.

 **Caution**

Recommended age of use

- The minimum recommended age to view 3D images is six years old.
- Children under the age of six are still developing and viewing 3D images may cause complications. Consult your doctor if you have any concerns.
- Children viewing 3D images through 3D Glasses should always be accompanied by an adult. It is often difficult to tell when a child is feeling tired or uncomfortable, which could result in them feeling suddenly unwell. Always check with your child to ensure that they are not experiencing any eye fatigue during viewing.

Projecting 3D Images

You can only view 3D images from devices connected to the HDMI1/HDMI2 ports or the WirelessHD Transmitter.

The projector supports following 3D formats.

- Frame packing
- Side by side
- Top and bottom



Depending on the device, 3D image signals may not be output correctly.

When the projector detects a 3D format

The projector automatically projects a 3D image when detecting a 3D format.

When the projector cannot detect a 3D format

Some 3D TV broadcasts may not contain 3D format signals. If this happens, set the 3D format manually. Press the  button to set the 3D format on the AV device.

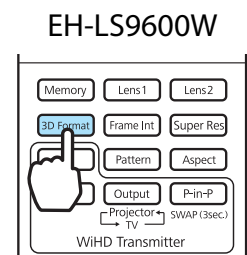
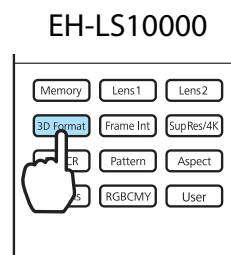



- For details on 3D format settings on the AV device, see the documentation supplied with the AV device.
- When the 3D format has not been set up correctly, the same image is split horizontally or vertically and is not projected correctly as shown below.

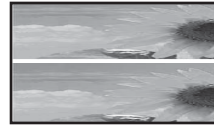
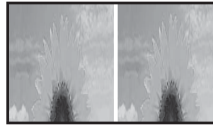

■ If the 3D image cannot be viewed

Check the following if the 3D effect is not applied correctly, even after setting the 3D formats.

- The synchronization timing for the 3D Glasses may have been inversed. Inverse the synchronization using **Inverse 3D Glasses**, and then try again. 🗨 **Signal - 3D Setup - Inverse 3D Glasses** p.88
- The image is not displayed in 3D if **3D Display** is set to **Off**. Press the  button on the remote control. 🗨 **Signal - 3D Setup - 3D Display** p.88



- How a 3D image is perceived varies depending on the individual.
- When a 3D image is displayed, a warning about viewing 3D images is displayed. You can turn off this warning by setting **3D Viewing Notice** to **Off**. 🗨 **Signal - 3D Setup - 3D Viewing Notice** p.88
- You can also convert 2D images to 3D images. 🗨 p.43
- During 3D image projection, the following Configuration menu functions cannot be changed. Aspect (set to Normal*), Noise Reduction (set to Off), Overscan (set to Off), Advanced - Sharpness, Picture in Picture
 - * You can select Anamorphic Wide only when 1080p/24 Hz/frame packing signals are projected.
- How the 3D image is viewed may change depending on the temperature of the surroundings. Refrain from using the projector if the image is not projected normally.

Preparing the 3D Glasses

Use 3D Glasses to view 3D images.



- The 3D Glasses come with protective stickers. Remove the protective stickers before use.

■ Charging the 3D Glasses

The following charging methods are available, depending on the model of 3D Glasses being used.

If you have a WirelessHD Transmitter, you can use it to charge the glasses.

If you do not have a WirelessHD Transmitter, you can charge by using an optional USB Charging Adapter.

Charging using the WirelessHD Transmitter

Use the USB cable to connect the 3D Glasses to the WirelessHD Transmitter.

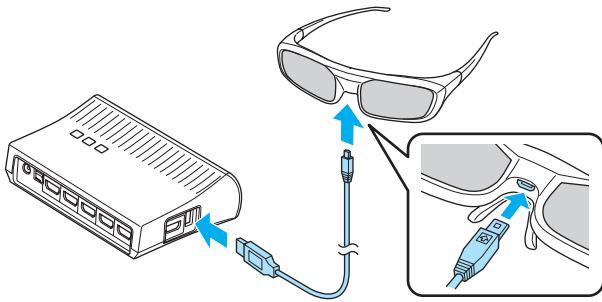

When a cable is connected to the HDMI5 port, the WirelessHD Transmitter cannot charge 3D Glasses.

Charging using the USB Charging Adapter

Use the USB cable to connect the 3D Glasses to the optional USB Charging Adapter, and then connect the USB Charging Adapter to an electrical outlet.

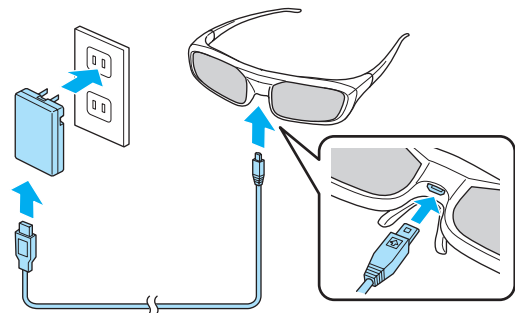

Attention

- Only connect to an electrical outlet that uses the voltage displayed on the adapter.
- Note the following points when handling the supplied microUSB cable.
 - You should not bend, twist, or pull the cable with too much force.
 - You should not modify the cable.
 - You should not perform wiring near an electric heater.
 - You should not use the cable if it is damaged.

■ Pairing 3D Glasses

To view 3D images, the 3D Glasses need to be paired with the projector.

Press the [Pairing] button for a while on the 3D Glasses to start pairing. See the User's Guide for the 3D Glasses for more information.



- For 3D Glasses that have not been used, pairing is performed when the 3D Glasses are turned on. You do not need to perform pairing if 3D images can already be viewed correctly.
- Once pairing has been performed, you can view 3D images the next time the devices are turned on.
- You can perform pairing within a range of three meters from the projector. While pairing is being performed, make sure you stay within a range of three meters from the projector. Otherwise, pairing may not be performed correctly.
- If synchronization cannot be performed within 30 seconds, pairing is automatically canceled. When pairing is cancelled, 3D images cannot be viewed because pairing fails.

■ Wearing and viewing with the 3D Glasses

- 1** Turn on the 3D Glasses by sliding the [Power] switch to On.

The indicator turns on for several seconds, and then turns off.

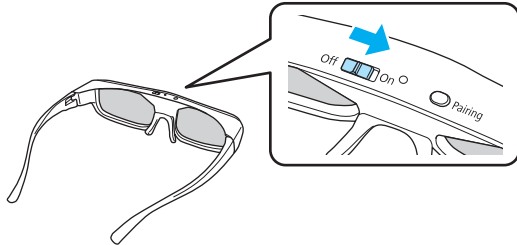

- 2** Put on the 3D Glasses and enjoy the show.



- When you have finished using the 3D Glasses, turn them off by sliding the [Power] switch to Off.
- If the 3D Glasses are not used for at least 30 seconds, they turn off automatically. To turn the 3D Glasses back on, slide the [Power] switch to Off, and then slide it back to On.
- You need more pairs of 3D Glasses if more than one person will be viewing the 3D image.

👁️ [p.116](#)

Range for Viewing 3D Images

This projector allows you to view 3D images within the range shown in the figure below.

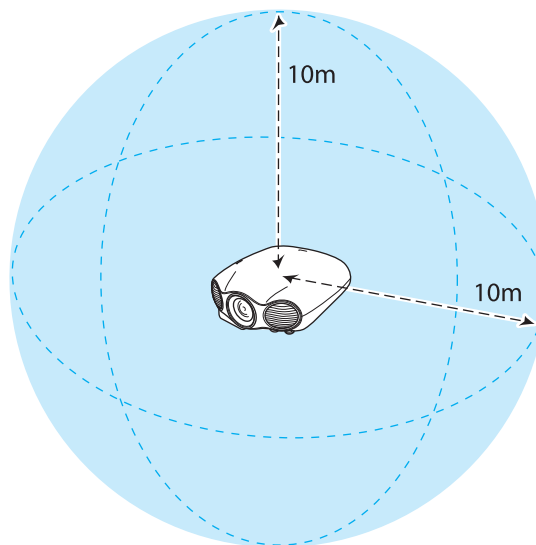

You can view 3D images within a range of 10 m from the projector.



- 3D images may not be displayed correctly if there is any interference from other Bluetooth communication devices. Do not use these devices at the same time.
- The communication method for 3D Glasses uses the same frequency (2.4 GHz) as wireless LAN (IEEE802.11b/g) or microwave ovens. Therefore, if these devices are used at the same time, radio wave interference may occur, the image may be interrupted, or communication may not be possible. If you do need to use these devices at the same time, make sure there is enough distance between them and the projector.
- The 3D Glasses use the active shutter system based on the standards provided by the Full HD 3D Glasses Initiative™.

Converting 2D Images to 3D Images and Viewing

You can convert 2D images to 3D images from HDMI1, HDMI2, or WirelessHD (EH-LS9600W only).

- 1 Press the  button, select **Signal - 3D Setup** from the Configuration menu, and then press the  button to confirm the selection.

The **3D Setup** screen is displayed.

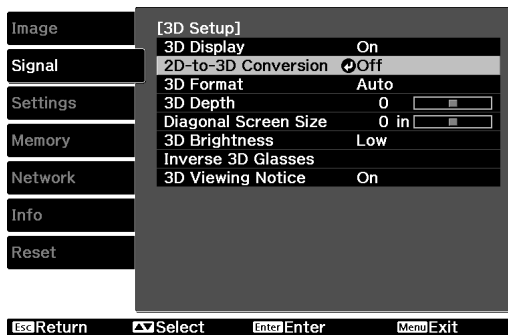

- 2 Select **2D-to-3D Conversion**, and then press the  button to confirm the selection.



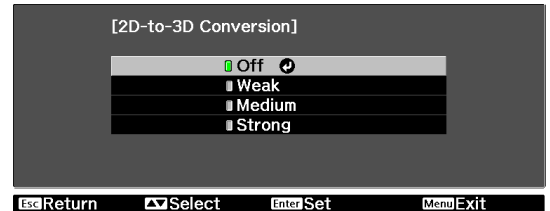

- 3 Select the strength of the 3D effect, and then press the  button to confirm the selection.



- 4 Press the  button to exit the menu.

 When **3D Display** is set to **Off**, press the  button on the remote control after making settings.



- When using **2D-to-3D Conversion**, set **3D Format** to **Auto** or **2D**.  **Signal - 3D Setup - 3D Format** [p.88](#)
- This cannot be set when **Image Processing** is set to **Fast** in the **Signal** menu.  **Signal - Advanced - Image Processing** [p.88](#)

Basic

Color Mode

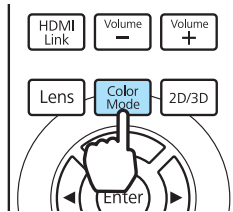

You can obtain the optimum image quality to suit your surroundings when projecting. The brightness of the image varies depending on the mode selected.

1 Press the  button.



You can make settings from the Configuration menu.  **Image - Color Mode** [p.86](#)

2 Select **Color Mode**.

Press the   buttons from the displayed menu to select **Color Mode**, and then press the  button to confirm the selection.

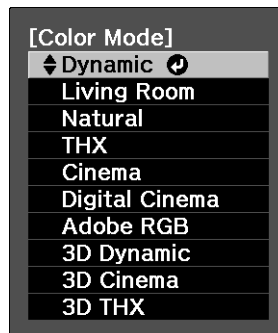

The following color modes are available.

- ✓ : Available
- : Grayed out and unavailable

Mode	Projected Image		Application
	2D	3D	
Dynamic	✓	-	Ideal for use in a bright room.
Living Room	✓	-	Projects a vivid, bright image.
Natural	✓	-	Ideal for use in a dark room. It is recommended that you perform color adjustment in this mode.
THX*1	✓	-	A color mode authorized by THX Ltd.
Cinema	✓	-	Ideal for watching movies and concerts in a dark room.
Digital Cinema*2	✓	-	Projects images using the same color spectrum as digital cinema used in movie theaters.
Adobe RGB*2	✓	-	Projects using the Adobe RGB color space. Ideal when the color profile of the image is Adobe RGB.
3D Dynamic	-	✓	Projects a brighter, more vivid image than 3D Cinema.
3D Cinema	-	✓	Produces crisper colors than 3D Dynamic.
3D THX*1	-	✓	A color mode authorized by THX Ltd.

*1 May not be displayed depending on the model you are using.

*2 EH-LS10000 only

Super-resolution

This function is only available for EH-LS9600W.

This setting sharpens blurred images, enhancing the apparent detail of the image by increasing the resolution of the image signal.

1 Press the **Super Res** button.

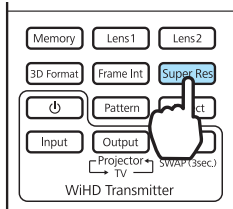

- You can make settings from the Configuration menu. ➡ **Signal - Super-resolution p.88**
- This cannot be set when a computer image signal is being input.
- This cannot be set when converting 2D images to 3D images. ➡ **Signal - 3D Setup - 2D-to-3D Conversion p.88**
- When projecting 3D images, this setting is enabled only for 1080p/24 Hz/frame packing signals.

2 Use the **◀ ▶** buttons to make adjustments.

The higher the number, the stronger the effect.



Press the **Default** button to return the adjustments to their default values.



Depending on the image, distortion at the edge of the image may be enhanced. If you notice any distortion, set it to "0".

3 Press the **Super Res** button to exit the menu.

Super-resolution/4K Enhancement

This function is only available for EH-LS10000.

There are two types of setting available, Super-resolution and 4K Enhancement.



When a low resolution image is input to the projector, it is increased to 1920 x 1080 pixels. Super-resolution sharpens blurred images, enhancing the apparent detail of the image by increasing the resolution of the image signal.

4K Enhancement projects 4K images (3840 x 2160 pixels) using "4K Enhancement Technology", employing super resolution processing and creating ultra high definition images.

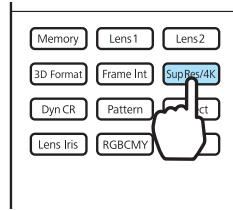

1

Press the  button.



- You can make settings from the Configuration menu.  **Signal - Super-resolution/4K** p.88
- This cannot be set when a computer image signal is being input.
- This cannot be set when converting 2D images to 3D images.  **Signal - 3D Setup - 2D-to-3D Conversion** p.88
- How the image is viewed may change depending on the temperature of the surroundings. It is recommended that you leave the projector on for a while before performing operations.

2

Use the   buttons to select the item, and then press the  button to confirm the selection.

Select **1** to **5** when setting the super-resolution.

Select **4K-1** to **4K-5** when projecting 4K images and setting super-resolution.

The higher the item number, the stronger the effect.



- Depending on the image, distortion at the edge of the image may be enhanced. If you notice any distortion, set another item.
- **4K Enhancement** cannot be set when projecting 3D images. **Super-resolution** is enabled only for 1080p/24 Hz/frame packing signals.
- **1** to **5** cannot be set when a 4K image signal is being input.
- **4K-1** to **4K-5** cannot be selected when **Image Processing** is set to **Fast**. Set **Fine**.  **Signal - Advanced - Image Processing** p.88

3

Press the  button to exit the menu.





The following restrictions apply when projecting a 4K image.

- **Aspect:** Only **Normal**, **Anamorphic Wide**, and **Horiz. Squeeze** are available
- **Frame Interpolation:** Only available when a 1080p/24 Hz signal is input, and fixed at **Off** when other signals are being input
- **Image Processing:** Fixed at **Fine**

Detail Enhancement





This function enhances details in an image to create clear outlines.

- 1 Press the  button, select **Signal - Detail Enhancement** from the Configuration menu, and then press the  button to confirm the selection.

The **Detail Enhancement** adjustment screen is displayed.





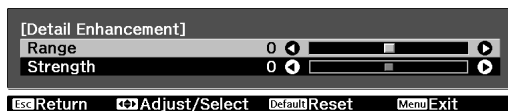

- This cannot be set when a computer image or a 4K image signal are being input.
- This cannot be set when converting 2D images to 3D images.  **Signal - 3D Setup - 2D-to-3D Conversion** p.88
- When projecting 3D images, this setting is enabled only for 1080p/24 Hz/frame packing signals.

- 2 Use the   buttons to select **Range**, and then use the   buttons to make the adjustments.

The higher the number, the wider the range from the outline area effected by the enhancement.



- 3 Use the   buttons to select **Strength**, and then use the   buttons to make the adjustments.

The higher the number the stronger the outlines are enhanced.

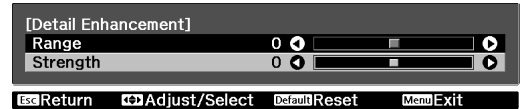



- 4 Press the  button to exit the menu.



Dynamic Contrast



By automatically setting the luminance according to the brightness of the displayed image, it lets you enjoy deep and rich images.

You can select the luminance adjustment tracking for changes in brightness in the displayed image from **Normal** to **High Speed**.

1 Press the  button, select **Image - Dynamic Contrast** from the Configuration menu, and then press the  button to confirm the selection.

The **Dynamic Contrast** adjustment screen is displayed.

 For EH-LS10000, you can also make settings by pressing the  button on the remote control.

2 Use the   buttons to select the item, and then press the  button to confirm the selection.

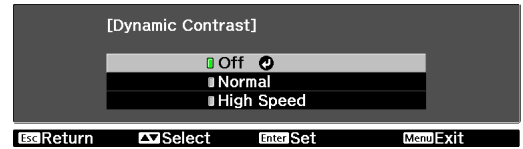

3 Press the  button to exit the menu.





Frame Interpolation

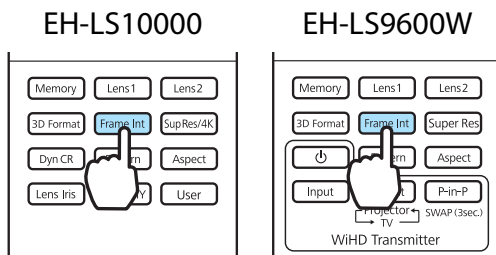

This setting compares the current and previous frames, and then creates a frame between them to create smooth images even for movies with a quick frame rate.

You can select the level of interpolation from **Low**, **Normal**, or **High**.

1 Press the  button.



-  You can make settings from the Configuration menu.  **Signal - Frame Interpolation** p.88
- This cannot be set when **Image Processing** is set to **Fast** in the **Signal** menu.  **Signal - Advanced - Image Processing** p.88
- This cannot be set when a computer image signal is being input.
- When projecting 3D images and when **Super-resolution/4K** from the **Signal** menu is set to **4K**, this setting is only available for 1080p/24 Hz signals.  **Signal - Super-resolution/4K** p.88

2 Use the   buttons to select the item, and then press the  button to confirm the selection.

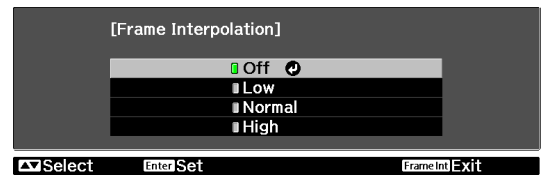

-  If you notice any distortion after changing the setting, set it to **Off**.
- When a 4K image signal is being input, this setting is fixed at **Off**, and **Low**, **Normal**, and **High** cannot be set.

3 Press the  button to exit the menu.



Precise Image Adjustment

Hue, Saturation, and Brightness

You can adjust the hue, saturation, and brightness for each of the R (red), G (green), B (blue), C (cyan), M (magenta), and Y (yellow) colors.

Hue	Adjusts the overall color of the image to be blue, green, or red.
Saturation	Adjusts the overall vividness of the image.
Brightness	Adjusts the overall color brightness of the image.

1 Press the button, select **Image - Advanced - RGBCMY** from the Configuration menu, and then press the button to confirm the selection.

The **RGBCMY** adjustment screen is displayed.



For EH-LS10000, you can also make settings by pressing the button on the remote control.

2 Use the buttons to select the color you want to adjust, and then press the button to confirm the selection.

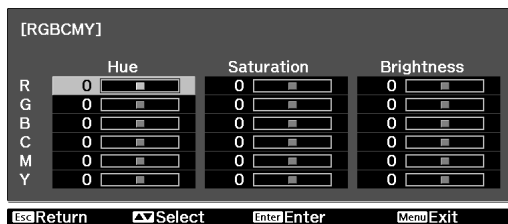

3 Use the buttons to select **Hue, Saturation, or Brightness**.

4 Use the buttons to make adjustments.

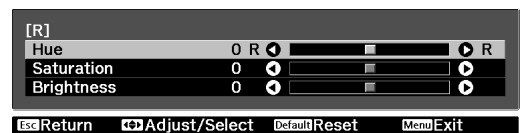

Press the button to adjust another color.

Press the button to return the adjustments to their default values.

5 Press the button to exit the menu.

Gamma

You can adjust slight coloration differences that may occur due to the device being used when the image is displayed.

You can use one of the following three methods selected from the Configuration menu.

Setting Method	Menu Settings
Select and adjust the correction value	Image - Advanced - Gamma
Adjust while viewing the image	Image - Advanced - Gamma - Customized - Adjust it from the image
Adjust using the gamma adjustment graph	Image - Advanced - Gamma - Customized - Adjust it from the graph

■ Select and adjust the correction value

Select the adjustment value, and then press the  button to confirm the selection.

The larger the value, the lighter the dark portions of the image become, but bright areas may appear discolored. The upper part of the gamma adjustment graph becomes rounded.

When a small value is entered, bright parts of the image become dark. The lower part of the gamma adjustment graph becomes rounded.



- The horizontal axis of the gamma adjustment graph shows the input signal level, and the vertical axis shows the output signal level.
- Press the  button to return the adjustments to their default values.



■ Adjust while viewing the image

Make adjustments while viewing the image being projected.

- 1 Move the gamma icon displayed on the image being projected to the area for which you want to adjust the brightness, and then press the  button.



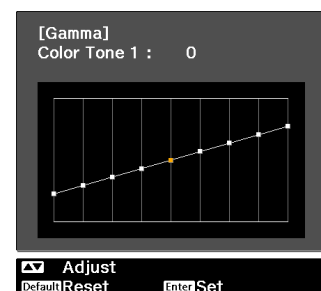

The gamma adjustment graph is displayed.

- 2 Use the   buttons to adjust the brightness, and then press the  button to confirm the selection.





Adjust using the gamma adjustment graph

Make adjustments while viewing the gamma adjustment graph for the image being projected.

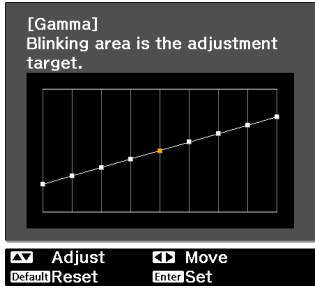
1 Use the   buttons to select the part you want to adjust from the graph.



2 Use the   buttons to adjust the brightness, and then press the  button to confirm the selection.

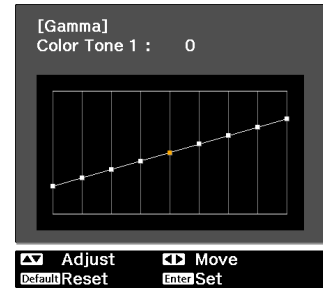





RGB (Offset/Gain)

For the image's brightness, you can adjust the dark areas (Offset) and the bright areas (Gain) for R (red), G (green), and B (blue). Increase the number to brighten the image, and decrease the number to darken the image.

Offset	When the image is made brighter, shading for the darker sections is more vividly expressed. When the image is made darker, the image appears more full-bodied but shading for the darker sections is harder to distinguish.
Gain	When the image is made brighter, the bright sections become whiter and shading is lost. When the image is made darker, shading for the bright sections is more vividly expressed.

The menu is displayed in the following order.

Image - Advanced - RGB

Use the   buttons to select the item, and then use the   buttons to make the adjustments.

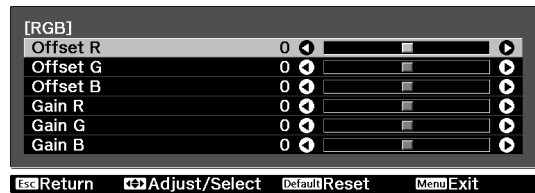



 Press the  button to return the adjustments to their default values.

Color Temp.

You can adjust the color temperature. Make adjustments if the image is a little too blue or too red.

The menu is displayed in the following order.

Image - Color Temp.

Use the   buttons to make adjustments.

Blue tints grow stronger as the value is increased, and red tints grow stronger as the value is reduced.

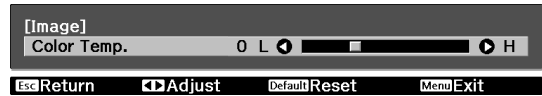



- The **Color Temp.** setting varies with the **Color Mode** setting.
- Press the  button to return the adjustments to their default values.

Skin Tone

You can adjust the skin tone. Make adjustments if the skin tone is too red or too green.

The menu is displayed in the following order.

Image - Skin Tone

Use the   buttons to make adjustments.

Increase the number to make colors greener, and decrease the number to make colors redder.

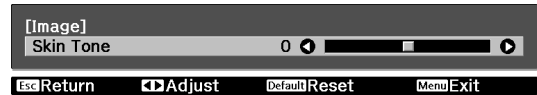

Press the  button to return the adjustments to their default values.

Sharpness



You can make the image clearer. There are two types available, **Standard** and **Advanced** which allows you to make more detailed adjustments.

Advanced cannot be adjusted in the following situations.

- When a computer signal is being input
- When **Image Processing** is set to **Fast** in the **Signal** menu
- When projecting 3D images

The following shows the setting items and procedures for **Advanced**.





Thin Line Enhancement	Details such as hair and patterns on clothing are enhanced.
Thick Line Enhancement	Rough parts such as outlines for entire subjects or the background are enhanced, making the overall image clearer.
Vert. Line Enhancement	Enhances the image horizontally or vertically.
Horiz. Line Enhancement	

- 1 Press the  button, select **Image - Sharpness** from the Configuration menu, and then press the  button to confirm the selection.

The **Sharpness** adjustment screen is displayed.

- 2 Select **Advanced** at the top right of the screen, and then press the  button to confirm the selection.

The **Advanced** adjustment screen is displayed.

- 3 Use the   buttons to select the item, and then use the   buttons to make the adjustments.

The image is enhanced when moved to the right (positive) and softer when moved to the left (negative).

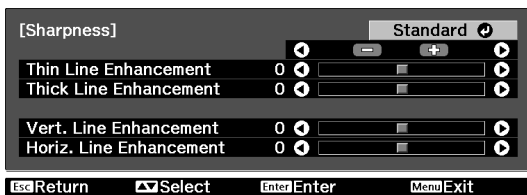

The upper bar adjusts high and low areas simultaneously.



Press the  button to return the adjustments to their default values.

- 4 Press the  button to exit the menu.

Lens Iris

Reduces the amount of light in the projection lens and adjusts the brightness of the image.



Unlike dynamic contrast that automatically adjusts the amount of light according to the brightness of the image, this allows you to adjust the amount of light for images with a lot of bright scenes.

- 1 Press the  button, select **Image - Lens Iris** from the Configuration menu, and then press the  button to confirm the selection.

The **Lens Iris** adjustment screen is displayed.



For EH-LS10000, you can also make settings by pressing the  button on the remote control.

- 2 Use the   buttons to make adjustments.

By lowering the number, the images become vivid.



Press the  button to return the adjustments to their default values.



The default values and settings differ depending on the **Color Mode** settings and zoom lens position.  **Image - Color Mode** [p.86](#)

- 3 Press the  button to exit the menu.

Panel Alignment

Adjusts the pixel color shift of the LCD display.



- When projecting using lens shift to adjust the position of the image, once you have adjusted to a suitable position, perform panel alignment. [p.33](#)
- Panel alignment cannot be performed correctly when projecting using extreme keystone correction. Install the projector in a position that does not require keystone correction.

- 1 Press the button, select **Settings - Panel Alignment** from the Configuration menu, and then press the button to confirm the selection.

The **Panel Alignment** adjustment screen is displayed.

- 2 Set **Panel Alignment** to **On**.

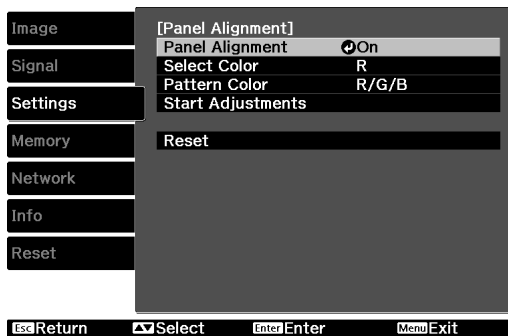

When set to **On**, the adjusted value is enabled. When set to **Off**, the corrected value returns to the default value.

- 3 In **Select Color**, select the color you want to adjust.

- 4 Select the grid color displayed when making adjustments from **Pattern Color**.

Select **Pattern Color**, and then press the button.

- 5 Select **Start Adjustments**, and then press the button to confirm the selection.

First, adjust the whole LCD display. When a message appears prompting you to start adjustments, press the button to start them.

- 6 Use the buttons for adjustments, and then press the button.

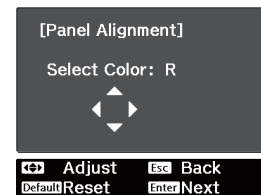

- 7 To make more detailed adjustments, select **Adjust the four corners**, and then press the button to confirm.

- 8 Use buttons to adjust, and then press the button to move to the next adjustment point.

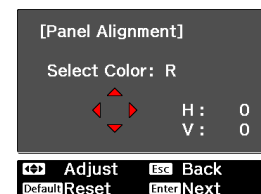

9

After adjusting four corners, select **Exit**, and then press the  button to confirm.

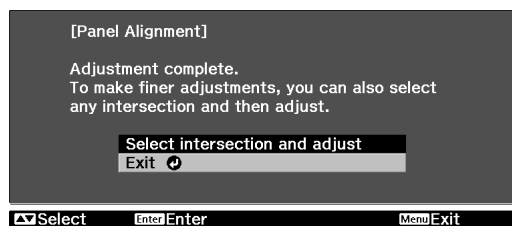

If the four corners still need adjustments, select **Select intersection and adjust**, and then continue adjustments.



10

Press the  button to exit the menu.



Image Processing

Improves the image quality or response speed for projected images.

This is only available when receiving a progressive signal input from the Component, Video, HDMI1, or HDMI2 ports, or from WirelessHD.

1 Press the  button, select **Signal - Advanced - Image Processing** from the Configuration menu, and then press the  button to confirm the selection.

The **Image Processing** adjustment screen is displayed.

2 Use the   buttons to select the item, and then press the  button to confirm the selection.

Fine: Improves the image quality.

Fast: Improves the response speed.



3 Press the  button to exit the menu.





- In the following situations, this is fixed at **Fine** and grayed out.
 - When a 3D image is being input
 - When a 4K image signal is being input
- When **Image Processing** is set to **Fast**, the following settings are applied and menu items are grayed out.
 - **Noise Reduction, Frame Interpolation, 2D-to-3D Conversion:** Fixed at **Off**
 - **Sharpness - Advanced, Super-resolution/4K - 4K:** Unavailable
- When **Super-resolution/4K** is set to **4K**, and **Image Processing** is set to **Fast**, a message is displayed informing you that 4K Enhancement has been cancelled. Select **Yes**, and set **Super-resolution/4K** to **Off**. If you select **No**, the screen displayed in step 2 is displayed again.
- When a signal is being input with a refresh rate of 24 Hz or 30 Hz, the **Fine** setting is used.

Color Gamut

Allows you to easily set the color gamut to match the standard for the video devices being used.

This can be set when **Color Mode** is set to **Natural**.

1 Press the  button, select **Image - Advanced - Color Gamut** from the Configuration menu, and then press the  button to confirm the selection.

The **Color Gamut** adjustment screen is displayed.

2 Select the item according to the device being used.

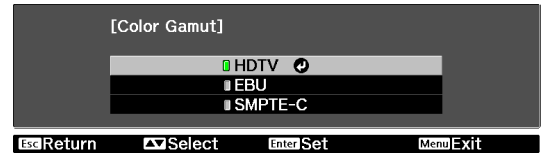

3 Press the  button to exit the menu.

HDMI Link

HDMI Link Function

When an AV device that meets the HDMI CEC standards is connected to the projector's HDMI1/HDMI2 ports, you can perform linked operations such as linked power on and volume adjustment for the AV system from one remote control.



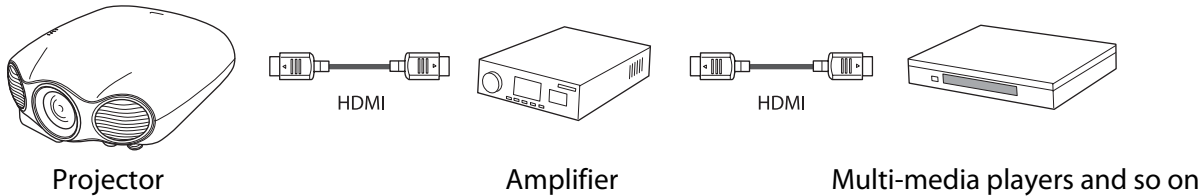

- Connect with a high-speed HDMI cable.
- When projecting images in WirelessHD, you can use the HDMI link function (EH-LS9600W only).
- As long as the AV device meets the HDMI CEC standards, you can use the HDMI link function even if the AV system in-between does not meet the HDMI CEC standards.
- Some connected devices or functions of those devices may not operate properly even if they meet the HDMI CEC standards. See the documentation and so on supplied with the connected device for more information.

Connection example



HDMI Link Settings

By pressing the  button on the remote control, and setting **HDMI Link** to **On**, you can operate the following functions.  [p.91](#)

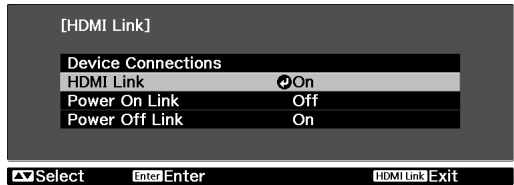

Function	Explanation
Power on link	Powers on the projector when content is played back on the connected device. Or, powers on the connected device when the projector is turned on.
Power off link	Powers off the connected device when the projector is turned off. <ul style="list-style-type: none"> • This only works when the connected device's CEC power link function is enabled. • Note that depending on the status of the connected device (for example, if it is recording), the device may not power off.
Input change link	Changes the input source of the projector to HDMI when content is played back on the connected device.
Connected devices operations	You can perform operations such as Play, Stop, Fast Forward, Rewind, Next Chapter, Previous Chapter, and Pause from the remote control for the projector.



- To use the HDMI Link function, you must configure the connected device. See the documentation supplied with the connected device for more information.
- When using the WirelessHD Transmitter, make the following settings when you want to use the power on/off link function (EH-LS9600W only).

Power On Link: Device -> PJ or Bidirectional

WirelessHD: On

Selecting the Connected Device

Display a list of the devices that can be operated with the HDMI link function, and then select the device you want to use.

1

Press the  button, and then select **Device Connections**.

The **Device Connections** list is displayed.

Devices that have a green icon to their left are linked.

If the device name cannot be determined this field is left blank.



Only one AV amplifier is recognized. If multiple amplifiers are connected, the amplifier recognized first is displayed.

2

Select the device you want to operate using the HDMI Link function.

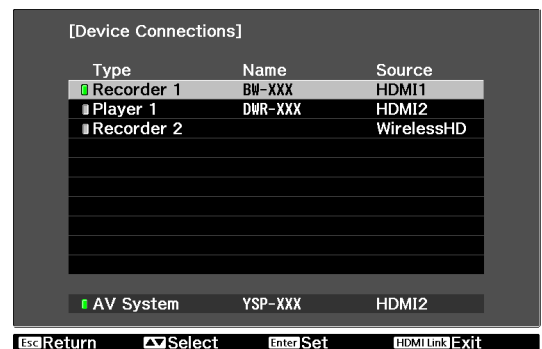

Type	Name	Source
Recorder 1	BW-XXX	HDMI1
Player 1	DWR-XXX	HDMI2
Recorder 2		WirelessHD
AV System	YSP-XXX	HDMI2

Navigation options at the bottom: **Return**, **Select**, **Enter/Set**, **HDMI Link/Exit**

Lens Position Function

You can save the focus, zoom, and lens shift positions for lens adjustment.

This allows you to load a saved lens position to quickly set the lens to the optimum projection position.



For example, you can easily load a lens position that was saved while projecting on a cinema scope screen, or when multiple screens with different aspects were being used.

Saving the Lens Position

1 Adjust the focus, zoom, and lens shift to the status you want to save.

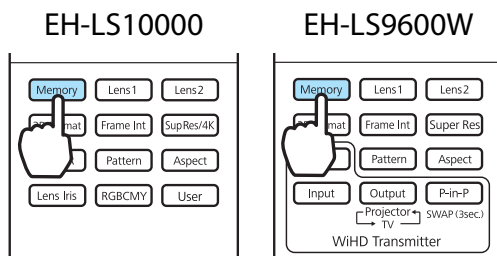

2 Press the **Memory** button.

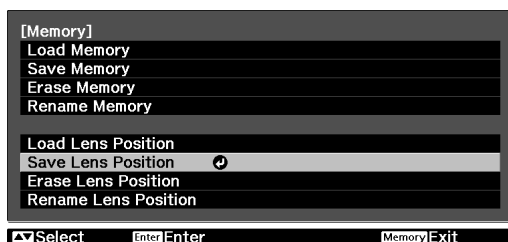

3 Use the   buttons to select **Save Lens Position**, and then press the **Enter** button to confirm the selection.



The **Save Lens Position** screen is displayed.

4 Use the   buttons to select the lens position name to be saved, and then press the **Enter** button to confirm the selection.

The adjustment values are saved.

If the mark on the left of the lens position name is turned green, it means the lens position has already been registered. When you select a registered lens position, a message is displayed asking you to confirm that you want to overwrite the lens position. If you select **Yes**, the previous settings are deleted and the current settings are registered.



- You can save up to 10 lens positions.
- If you save to **Memory1** or **Memory2**, you can load the settings by pressing the **Lens1** or **Lens2** button on the remote control.

Loading the Lens Position

1 Press the Memory button, and then select **Load Lens Position**.
The **Load Lens Position** screen is displayed.

2 Select the lens position name you want to load.
The zoom, focus, and lens shift are adjusted to the status you saved.
While adjustments are being performed, a message is displayed and the projector cannot be operated.

 • If you have saved to **Memory1** or **Memory2**, you can load the settings by pressing the Lens1 or Lens2 button on the remote control.
• This does not guarantee that the saved status will be completely restored. Errors could occur.

Erasing the Lens Position

1 Press the Memory button, and then select **Erase Lens Position**.
The **Erase Lens Position** screen is displayed.

2 Select the lens position name you want to erase.
A confirmation message is displayed. Select **Yes** to erase the content of the saved lens position.

 If you want to erase all of the saved lens positions, go to **Reset - Reset Lens Position** on the Configuration menu.  [p.100](#)





Renaming the Lens Position

You can change the lens position name using up to 12 characters. Giving the memory a name that is easy to remember is useful when loading the memory.

1 Press the Memory button, and then select **Rename Lens Position**.
The **Rename Lens Position** screen is displayed.

2 Select the lens position name you want to change.

3 Enter a name.
The soft keyboard is displayed.  [p.98](#)

Use the     buttons to select a character, and then press the Enter button to confirm the selection. Enter up to 12 characters.

When you have finished, select **Finish**.
The lens position name is changed.

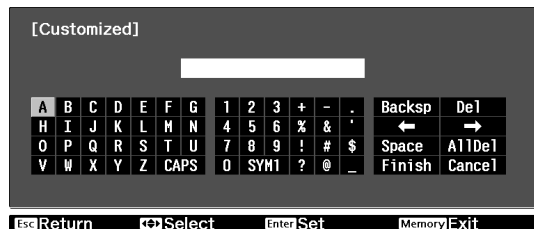

Memory Function

Settings that can be Saved

You can save some settings for the Configuration menu (Save Memory).

By saving settings, you can load settings made for specific images or scenes from the remote control (Load Memory).

You can save the following Configuration menu settings.

Image 👉 p.86	Color Mode, Power Consumption, Brightness, Contrast, Color Saturation, Tint, Sharpness, Color Temp., Skin Tone, Dynamic Contrast	
	Advanced	Sharpness, Offset, Gain, Gamma, Hue, Saturation, Brightness, EPSON Super White
Signal 👉 p.88	Deinterlacing, Motion Detection, Super-resolution*1, Super-resolution/4K*2, Detail Enhancement	
	Advanced	Noise Reduction, Setup Level, Overscan, HDMI Video Range

*1 EH-LS9600W only



*2 EH-LS10000 only

Saving the Memory

1 Make settings that you want to save to the Configuration menu.

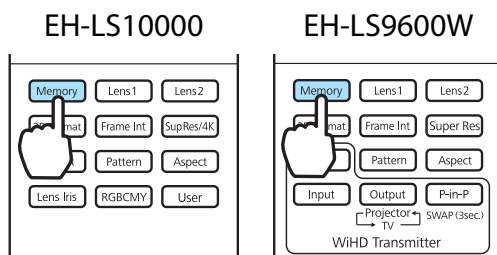
2 Press the **Memory** button.



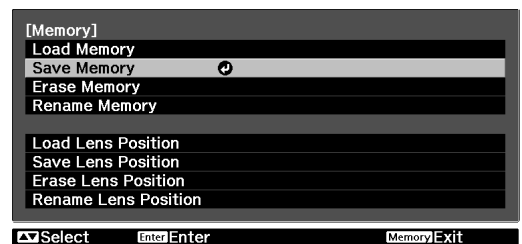

3 Use the   buttons to select **Save Memory**, and then press the  button to confirm the selection.



The **Save Memory** screen is displayed.

4

Use the   buttons to select the memory name to be saved, and then press the  button to confirm the selection.

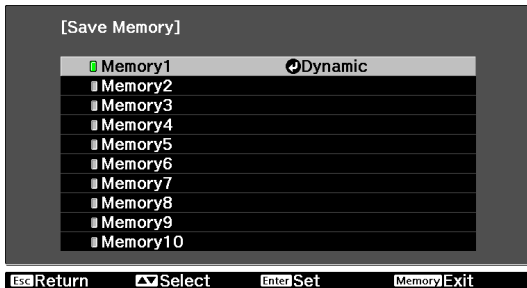

The current projector settings are saved as a memory.

If the mark on the left of the memory name is turned green, it means the memory has already been registered. When you select a registered memory, a message is displayed asking you to confirm that you want to overwrite the memory. If you select **Yes**, the previous settings are deleted and the current settings are registered.



You can save up to 10 memories.

Loading the Memory

1

Press the  button, and then select **Load Memory**.

The **Load Memory** screen is displayed.

2

Select the memory name you want to load.



- The color mode saved to the memory is displayed on the right.
- Depending on the input signal, part of the loaded memory item may not be applied to the projected image.
- Memories saved for 2D images can only be loaded when projecting 2D images. Memories saved for 3D images can only be loaded when projecting 3D images. Unavailable memory names are grayed out and cannot be selected.

Erasing the Saved Memory

1 Press the  button, and then select **Erase Memory**.

The **Erase Memory** screen is displayed.

2 Select the memory name you want to erase.

A confirmation message is displayed. Select **Yes** to erase the content of the saved memory.



You can erase all of saved memories from **Reset - Reset Memory** on the Configuration menu.
 [p.100](#)

Renaming the Memory

You can change the memory name using up to 12 characters. Giving the memory a name that is easy to remember is useful when loading the memory.

1 Press the  button, and then select **Rename Memory**.

The **Rename Memory** screen is displayed.

2 Select the memory name you want to change.





3 Select from the list of names, or enter a name of your own.

If you select from the name list, check that the memory name has been changed.

To enter a name of your own, select **Customized**, and then enter the name using the soft keyboard.

 [p.98](#)



Use the     buttons to select a character, and then press the  button to confirm the selection. Enter up to 12 characters.

When you have finished, select **Finish**.

The memory name is changed.



Connecting with WirelessHD (EH-LS9600W Only)

Installing the WirelessHD Transmitter

You can use the supplied WirelessHD Transmitter to wirelessly receive image data.

This is useful when the projector cannot be setup near your AV devices as you can connect the devices to the projector without using cables.



You can use the WirelessHD Transmitter in the following ways.

- You can connect up to five AV devices at the same time, and switch images using the remote control.
- As well as the projector, you can connect another monitor device, such as a television, to the Output port, and then switch the output using the remote control.
- This allows other monitor devices connected to the Output port to project images from the connected AV device, even if the projector is off.
- You can connect smart devices and tablets that support MHL, and then project images from the connected MHL device. You can also operate MHL devices from the projector's remote control, as well as charge the MHL device.

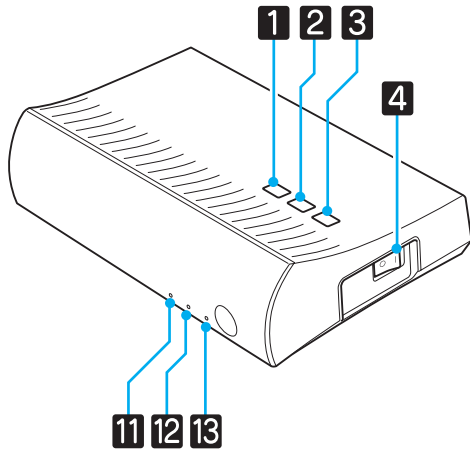

WirelessHD Transmitter part names

Front

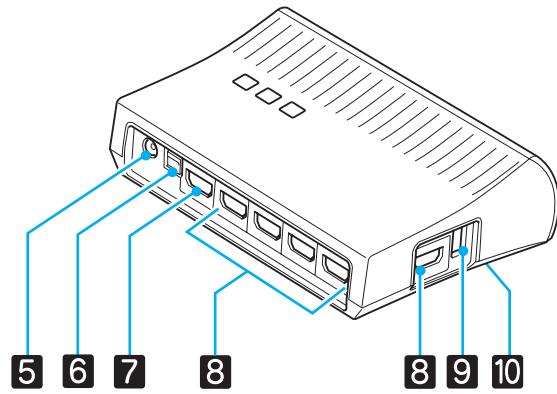

Rear



Name		Function
1	⏻ button	Turns the WirelessHD Transmitter on or off. This performs the same function as the  button for WiHD Transmitter on the lower section of the remote control.
2	Input button	Changes to the image from each input port. This performs the same function as the  button for WiHD Transmitter on the lower section of the remote control.
3	Output button	Switches the output image to the Wireless or Output port. This performs the same function as the  button for WiHD Transmitter on the lower section of the remote control.
4	Main power switch	Turns the main power for the WirelessHD Transmitter on or off.
5	AC adapter port	Connects the AC adapter.
6	Optical Audio-Out port	Connects to audio devices equipped with an optical digital audio input port.
7	HDMI Output port	Connects to monitor devices, such as televisions. You can switch the output using the Output button.
8	HDMI Input port	Connects to the AV device you want to playback. You can switch the input image using the Input button. The HDMI5 port of the unit meets the MHL standards. You can play content from MHL compatible smartphones or tablets connected with an MHL cable.
9	3D Glasses charging port	Connects a USB cable to charge the 3D Glasses.
10	Setup button	This is the button on the base of the WirelessHD Transmitter. It is used to reset the WirelessHD Transmitter.
11	⏻ indicator (orange/green)	Lit when the WirelessHD Transmitter is on. Lit orange when standing by, and green when operating (receiving or transmitting images).
12	WiHD indicator (orange)	Indicates the communication status for the WirelessHD. <ul style="list-style-type: none"> • Lit when wirelessly transmitting images to the projector. • Off when outputting to the Output port.
13	Link indicator (orange)	Indicates the connection status with the projector. <ul style="list-style-type: none"> • Turns on when connected to the projector. • Flashes when searching for a projector. • Flashes slowly when standing by in power saving status.

WirelessHD Transmitter connection example and signal flow

Connection example 1: Viewing without an AV amplifier

Connect a device to WirelessHD Transmitter without using an AV amplifier, and connect the sound bars and so on to the Optical Audio-Out port to output audio.

When outputting audio from a connected device, you need an optical digital audio cable.

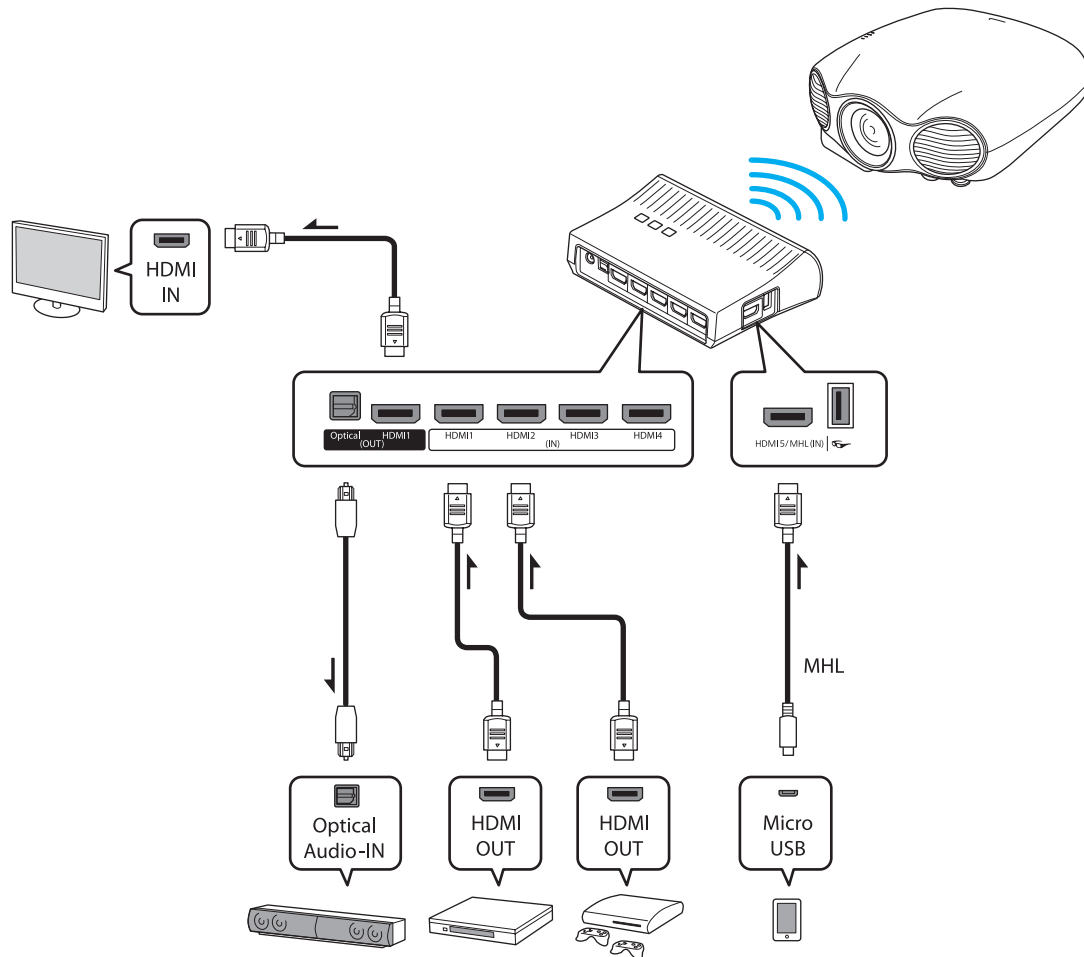

Connection example 2: Viewing with a connected AV amplifier

The audio from the device connected to the AV amplifier is output from the amplifier's audio-out port without passing through the WirelessHD Transmitter.

When outputting audio from a device connected with an MHL cable, you need an optical digital audio cable.

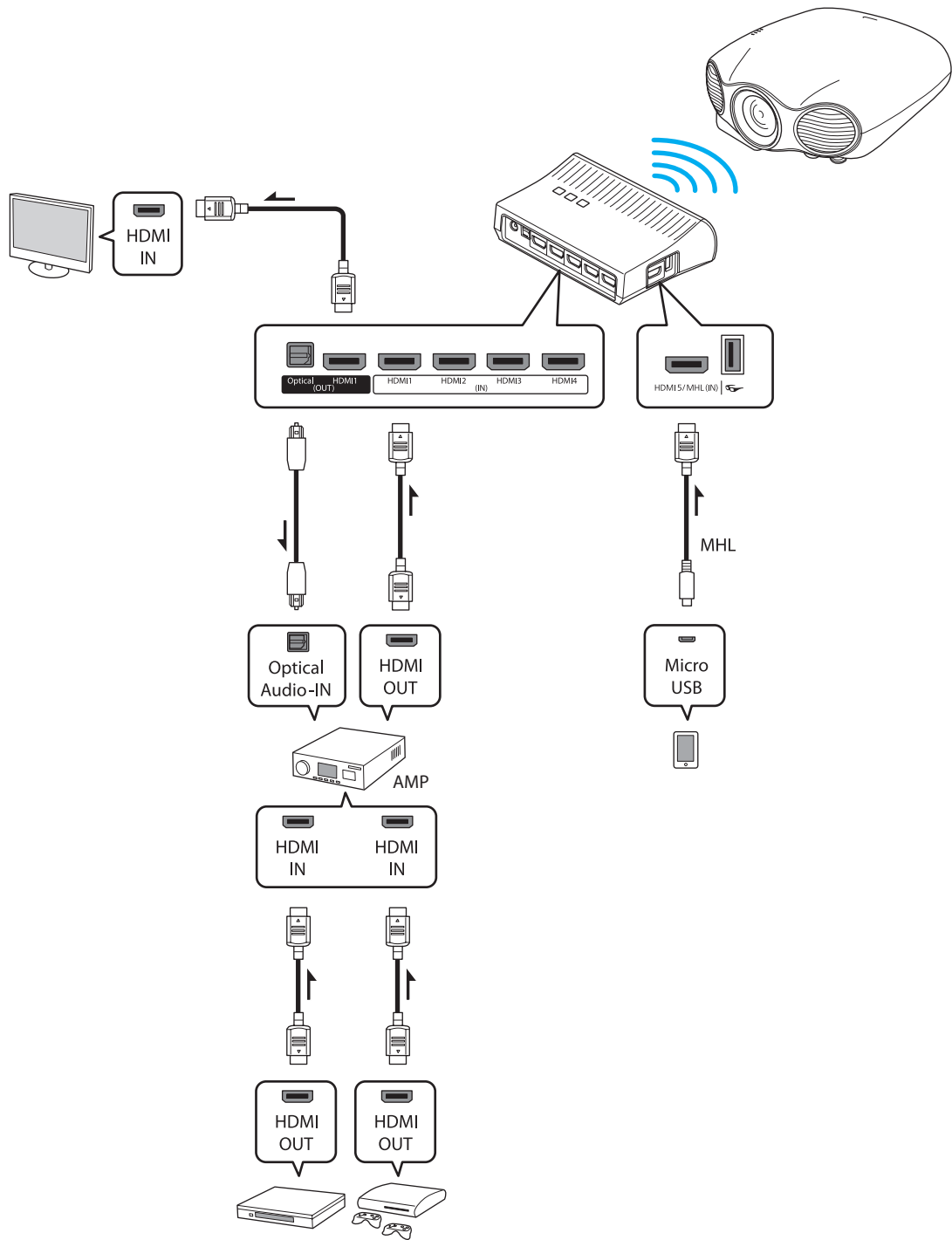

 The audio output method to an AV amplifier may be restricted by the specifications of the monitor device, such as a television, connected to the Output port. For more information on audio output settings, see the documentation supplied with the AV device.

Setting the WirelessHD Transmitter

1 Set up the WirelessHD Transmitter connected to the projector so that they are facing each other. p.74

- The receiver is located at the front of the projector and therefore cannot receive any signals directly from the rear. Set up the projector and the WirelessHD Transmitter so that they are facing each other. Also, make sure that the receiver is not covered.
- Place the WirelessHD Transmitter on a level surface facing towards the projector.

2 Connect the WirelessHD Transmitter using the supplied AC adapter.

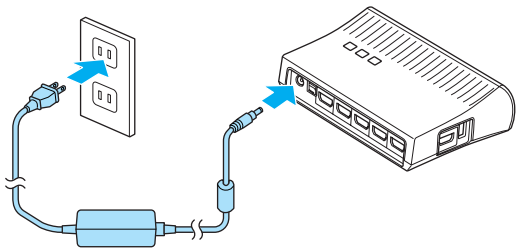

3 Using an HDMI cable, connect the AV device you want to use to the Input port on the WirelessHD Transmitter. You can connect up to five AV devices.

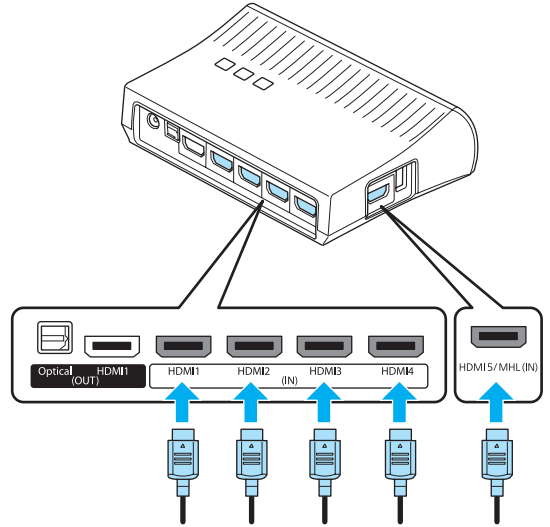

- You can connect another monitor device, such as a television, to the Output port on the WirelessHD Transmitter. You can switch between output images using the remote control. p.75
- The HDMI5 port of the WirelessHD Transmitter supports the MHL input signal. You can play content from MHL compatible smart devices or tablets connected with an MHL cable.
- If the following message is displayed when you connect an MHL device, the device has been connected to a port other than the HDMI5 port, or the connected device is not compatible with MHL.
"No Signal"
- You can use the HDMI link function even when using the WirelessHD Transmitter. p.60

Projecting Images

1 Start playback on the AV device, and then turn on the projector and the WirelessHD Transmitter.

The  indicator on the WirelessHD Transmitter turns on.

2 Check the status of the WiHD indicator on the WirelessHD Transmitter.

If the WiHD indicator is on, go to the next step.

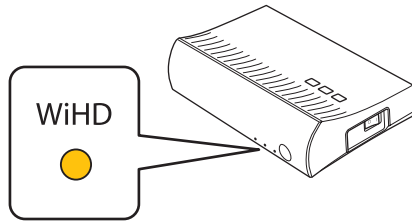

If the indicator is off, press the  button on the remote control or the WirelessHD Transmitter.

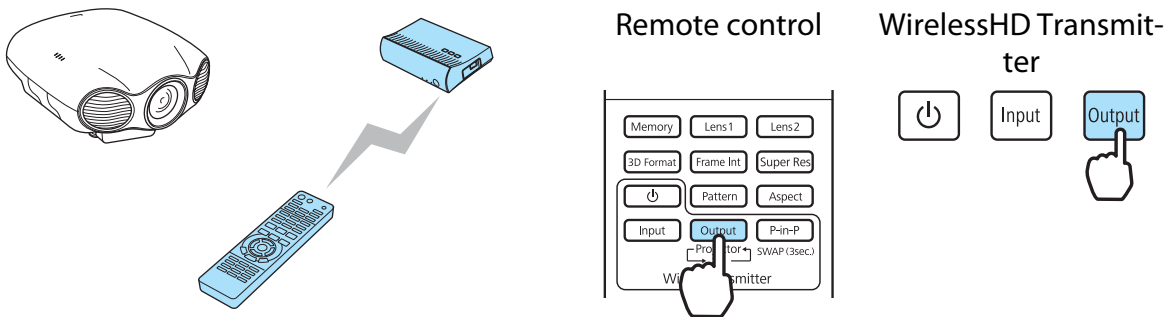

Make sure you point the remote control at the WirelessHD Transmitter when using the  button on the remote control.

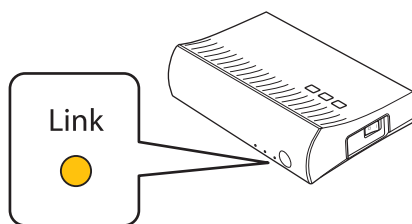

3 Check the status of the Link indicator on the WirelessHD Transmitter.

If the WirelessHD Transmitter is connected to the projector, the Link indicator flashes and then remains on.



-  If the indicator continues to flash slowly, the WirelessHD Transmitter cannot connect to the projector and has entered standby status. Make sure the projector has been setup correctly, such as turning on the power.
- You can view the signal strength while images are being projected from the **WirelessHD** settings menu.  **Settings - WirelessHD - Reception** [p.91](#)

4 If projection does not start, press the **WirelessHD** button on the remote control to change the source.

Make sure you point the remote control at the projector when using the **WirelessHD** button on the remote control.

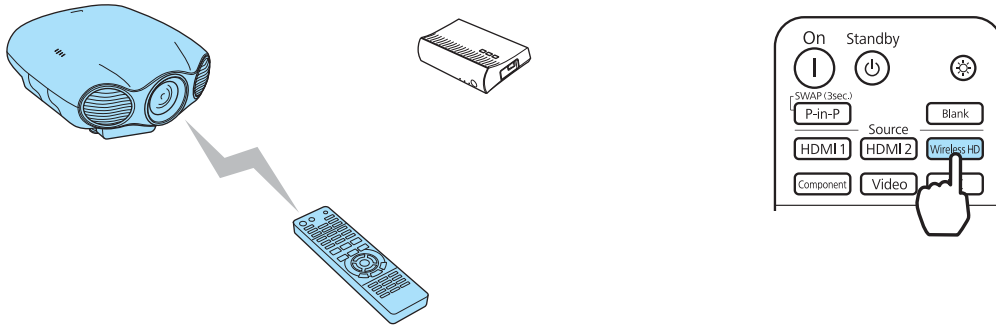

Projection starts.

5 When connecting two or more AV devices to the WirelessHD Transmitter, press the **Input** button to switch images. [p.76](#)



- When receiving WirelessHD images, make sure **WirelessHD** is set to **On** from the Configuration menu. **Settings - WirelessHD - WirelessHD** [p.91](#)
- Make sure you turn off the WirelessHD Transmitter if it is not going to be used for an extended period.

WirelessHD Settings Menu

1 Press the **Menu** button, select **Settings - WirelessHD** from the Configuration menu, and then press the **Enter** button to confirm the selection.

The **WirelessHD** settings screen is displayed.

2 Make settings for each of the displayed functions.

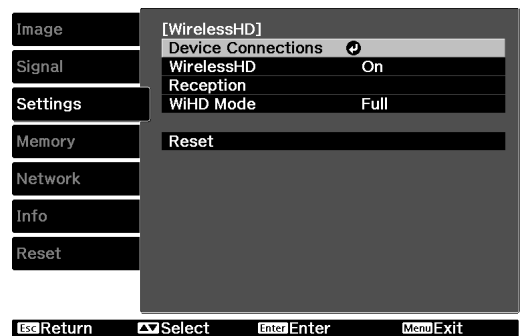

Available functions on the **WirelessHD** settings menu

Function	Explanation
Device Connections	Displays a list of available WirelessHD devices that can be connected. The device names and MAC addresses (device numbers) are displayed in the list. The MAC address is displayed on the label on the base.
WirelessHD	Enables or disables the WirelessHD function.
Reception	Displays the reception for the image being projected.
WiHD Mode	Use Full for most situations. Full mode uses the maximum video bandwidth at all times. Dynamic mode extends wireless ranges while optimally adjusting video bandwidth. Set to Dynamic if the image is interrupted due to weak signals and other causes.

Function	Explanation
Reset	Resets WirelessHD settings to their default settings.



Even when the WirelessHD Transmitter and the projector are connected, 0% is displayed as the **Reception** when no image signal is being input. Check the communication status using the Link indicator. [p.68](#)

WirelessHD Transmission Range

The following shows the WirelessHD transmission range. Make sure the front of the WirelessHD Transmitter faces the front of the projector.

Horizontal direction (when **WiHD Mode** is set to **Full**) Vertical direction (placed on a shelf)

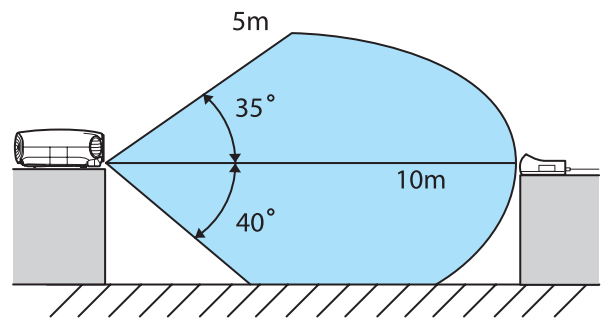
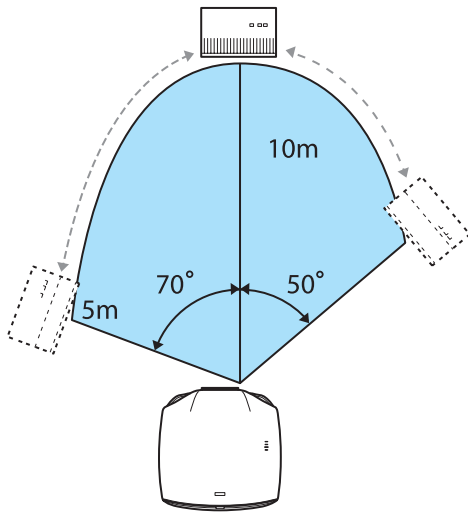

Horizontal direction (when **WiHD Mode** is set to **Dynamic**) Vertical direction (suspended from a ceiling)

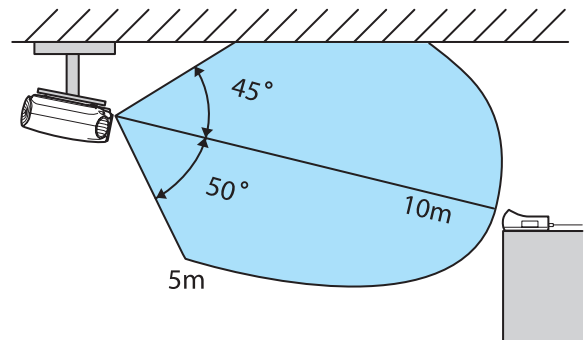
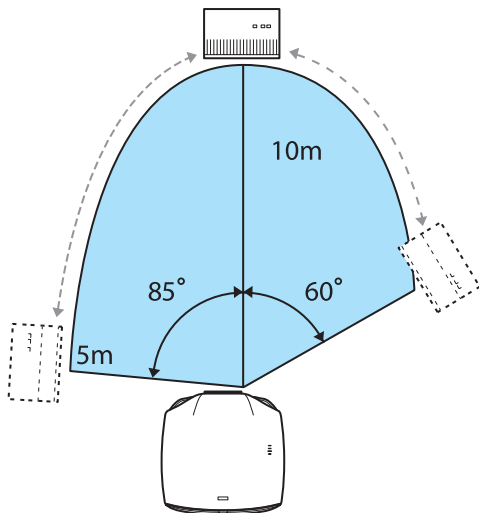



- The wireless transmission range varies depending on the placement and material of the surrounding furniture and walls. The values given here are for your reference only.
- The projector cannot communicate through walls.
- Place the WirelessHD Transmitter on a wooden shelf or other location that does not block the signal from being transmitted from the front of the device. Note that placing the transmitter on a metal shelf and so on may cause signal instability.
- The antennas are built-into the front of the projector and the WirelessHD Transmitter. Make sure the antennas face each other (face the front) when setting up the devices.
- When checking operations, place the projector and the WirelessHD Transmitter close to each other, and make sure there are no other projectors operating in the vicinity.
- Depending on the reception strength, the image's color information may be automatically discarded to avoid any interruptions and maintain a constant connection. To avoid any deterioration in image quality, adjust the position of the WirelessHD Transmitter so that the **Reception** is as strong as possible.

Remote Control Operating Range

The following shows the operating range between the remote control and the WirelessHD Transmitter.

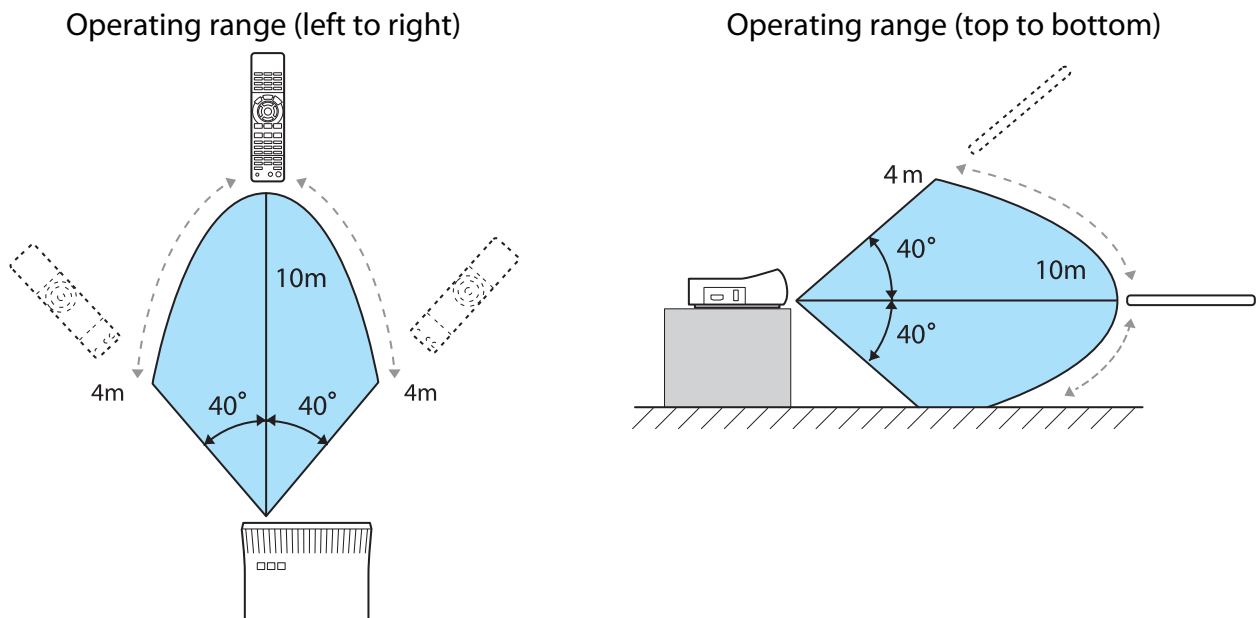

Switching the Input and Output

With the WirelessHD Transmitter, you can connect and switch between up to five multi-media players (input devices to be played back) and one monitor device (a monitor device displaying an image, such as a television).

Switching the target image

You can switch between a monitor device, such as a television, connected to the Output port on the WirelessHD Transmitter and the projector.

1

Turn on the projector or the monitor device, such as a television.

2

Turn on the WirelessHD Transmitter.

The ϕ indicator on the WirelessHD Transmitter turns on.

3 Point the remote control at the WirelessHD Transmitter, and then press the **Output** button.

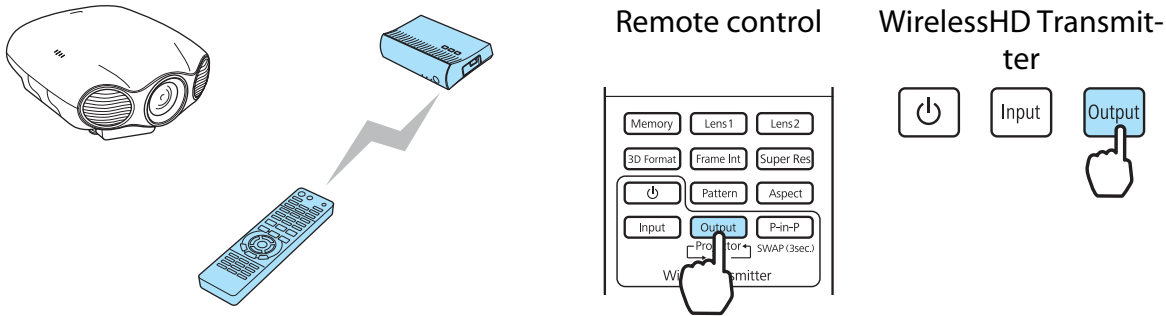

Depending on the output target, the WiHD indicator on the WirelessHD Transmitter indicates the following status.

On: The image is being output to the projector.

Off: The image is being output to the monitor device.

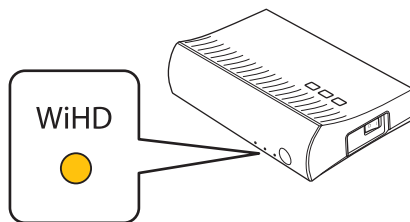

The output target projected last time is projected the next time the projector is turned on.



You can switch to the monitor device even when the projector is off.

Switching the image source

You can switch the image source for the AV device connected to the WirelessHD Transmitter. When switching, each input source is displayed on one screen as a preview. This allows you to switch easily between image sources even when two or more devices are connected using HDMI.

The projector uses InstaPrevue Technology from Silicon Image, Inc.

- 1 Point the remote control at the WirelessHD Transmitter, and then press the **Input** button.

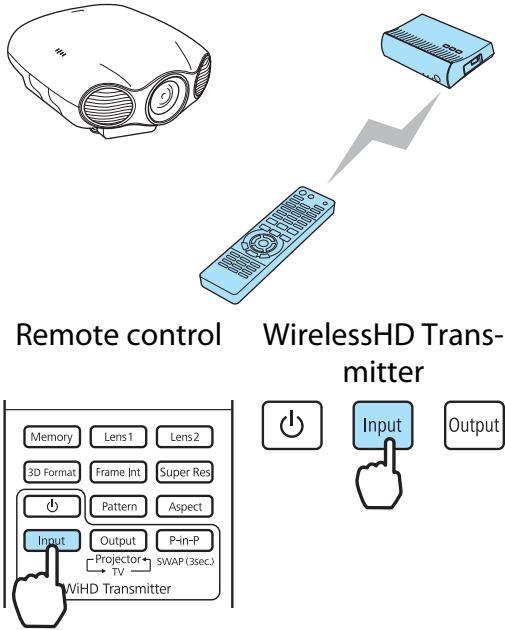

Displays the sub-screen (small screen) for the connected device.

The screen that is not receiving an image signal is displayed in blue or black.

Ex.) When projecting images for the device connected to the HDMI2 port

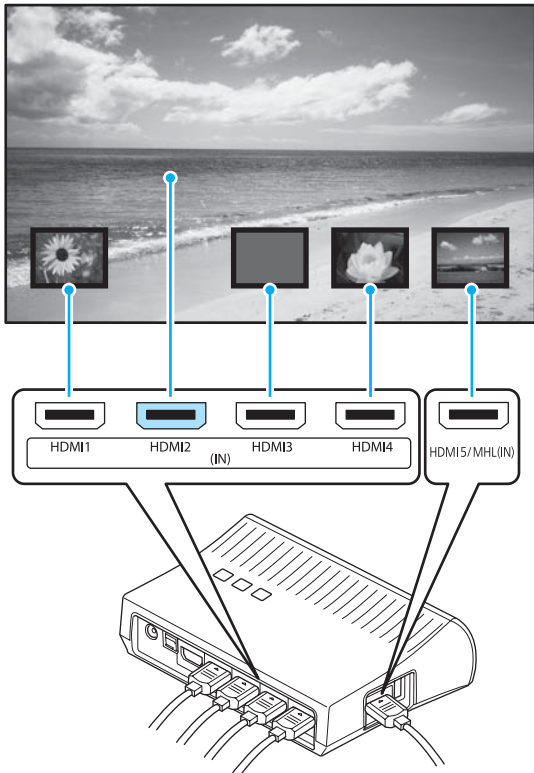

- 2 The target screen changes each time you press the **Input** button.

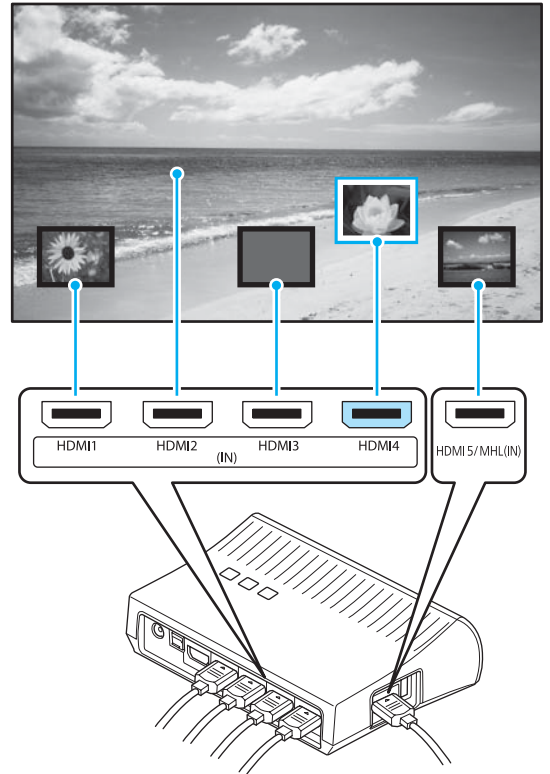

- 3 After selecting the target screen, please wait for a moment.

The projected image is switched.

Displaying as a Sub-Screen

- 1 Point the remote control at the WirelessHD Transmitter, and then press the **P-in-P** button.

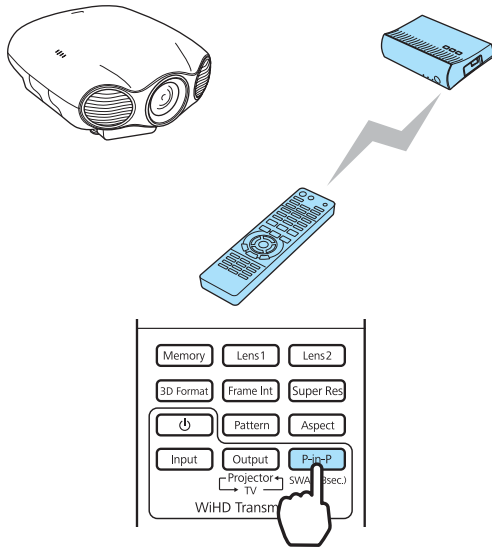

Displays the sub-screen (small screen) for the connected device.

- 2 When switching between the sub-screen and the main screen (large screen), press and hold down the **P-in-P** button (for approximately 3 seconds) until the screen changes.

- 3 To close the sub-screen, press the **P-in-P** button again.

The projected image is switched.



- When the sub-screen is displayed, press the **Input** button to switch the image for the sub-screen.
- When the sub-screen is displayed, press the **Output** button to change the position and size (large or small) of the sub-screen. Each time the **Output** button is pressed, the display position moves from bottom right, top right, top left, and bottom left allowing you to change the size.

Picture in Picture

In Picture in Picture, two different image sources can be projected, one in the main screen (large screen) and the other in the sub screen (small screen).

Types of Screen that can be Displayed Simultaneously

HDMI1, HDMI2 and WirelessHD are examples of input sources that can be displayed in Picture in Picture.

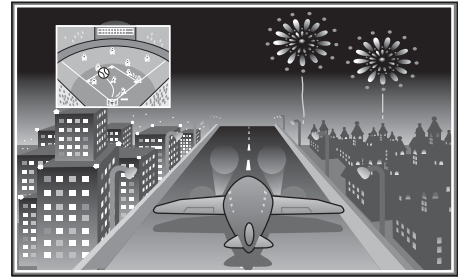

Combinations of input sources for Picture in Picture projection

Main Screen	Sub Screen
HDMI1	HDMI2, WirelessHD*
HDMI2	HDMI1, WirelessHD*
WirelessHD*	HDMI1, HDMI2

* EH-LS9600W only

The projector uses InstaPrevue Technology from Silicon Image, Inc.

Starting and Exiting Picture in Picture

Starting

Press the **P-in-P** button on the remote control while the projector is projecting.

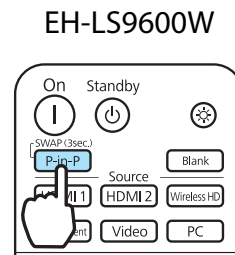
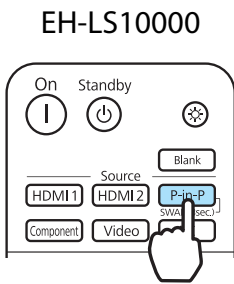

The currently input image is displayed on a Picture in Picture.

Main screen: The current image

Sub screen: The source different from the main screen

Exiting



Press the **P-in-P** button to exit.



- If the source being input is not supported, nothing is displayed in Picture in Picture.
- You cannot use Picture in Picture display to project 3D images or 4K images.
- If a 3D image or a 4K image is input during Picture in Picture display, the Picture in Picture function exits.

Picture in Picture Settings

Use the **Picture in Picture** menu to change the size or position of the sub screen.

- 1 Press the  button, select **Settings - Picture in Picture** from the Configuration menu, and then press the  button to confirm the selection.

The **Picture in Picture** menu is displayed.



The **Picture in Picture** menu is displayed directly by pressing the  button during Picture in Picture projection.

- 2 Make settings for each of the displayed functions.

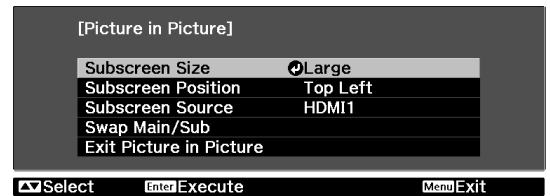

Available functions on the **Picture in Picture** menu

Function	Explanation
Subscreen Size	Selects the sub screen size using Small and Large .
Subscreen Position	Changes the sub screen position using Top Right , Bottom Right , Top Left , and Bottom Left .
Subscreen Source*	Selects which source is displayed as the sub screen.
Swap Main/Sub	Changes the main and sub screens.
Exit Picture in Picture	Exits the Picture in Picture display.

* Only EH-LS9600W is displayed.

Operations and Settings Using the Network

When the projector is connected to a network, you can make settings and control the projector from a computer or smart device over the network.

Making Settings and Performing Operations from a Web Browser

When a computer or smart device with a Web browser is connected to the same network as the projector, you can change the projector's settings in the same way as operating a remote control.

Change settings using Web Control, and perform operations using Web Remote.

The following Web browsers are supported.

Windows: Internet Explorer 8, 9 and 10 (except for Metro)

Mac OS X: Safari



If you set **Standby Mode** to **Communication On**, you can use the Web browser to make settings and perform control even if the projector is in standby mode (when the power is off).  **Settings - Standby Mode** [p.91](#)

Changing the projector's settings (Web Control)

By using Web Control, you can change the projector's settings.



If your Web browser is set up to connect via a proxy server, the Web Control screen cannot be displayed. To display Web Control, you need to make settings so that a proxy server is not used for a connection.

Displaying the Web Control screen on your computer

- 1 Start the Web browser, and then enter the IP address of the projector in the address input box of the Web browser.

The Web Control screen is displayed.

When Web Control Password is set in the Network menu from the projector's Configuration menu, the password entry screen is displayed. Enter the text set in Web Control Password.  [p.96](#)



You can check the projector's IP address from the Configuration menu.  **Network - Net. Info. - Wired LAN** [p.96](#)

- 2 The user ID and password entry screen is displayed. Enter "EPSONWEB" as the user ID.
The default password is "admin".

Displaying the Web Control screen on your smart device

- 1 Start the Web browser, and then enter the IP address of the projector in the address input box of the Web browser.

The **remote** and **config** icons are displayed in your Web browser.

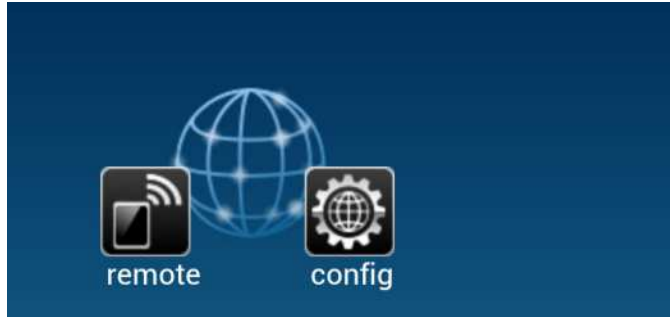

- 2 Tap the **config** icon.

The Web Control screen is displayed.

When Web Control Password is set in the Network menu from the projector's Configuration menu, the password entry screen is displayed. Enter the text set in Web Control Password.  [p.96](#)

- 3 The user ID and password entry screen is displayed. Enter "EPSONWEB" as the user ID.
The default password is "admin".

Items in the Configuration menu that cannot be set by Web Control

- **Settings - User Button**
- **Settings - Operation - High Altitude Mode**
- **Settings - Display - Menu Position**
- **Settings - Display - Menu Color**
- **Settings - Display - Standby Confirmation**
- **Settings - Panel Alignment**
- **Settings - Language**
- **Reset - Reset All**

The settings for items on each menu are the same as the projector's Configuration menu.  [p.86](#)

Operating the projector (Web Remote)

By using Web Remote, you can operate the projector from a Web browser.

Displaying the Web Remote screen on your computer

- 1 Display the Web Control screen.
 [p.81](#)

- 2 Click Web Remote.
The Web Remote screen is displayed.

Displaying the Web Remote screen on your smart device

- 1 Start the Web browser, and then enter the IP address of the projector in the address input box of the Web browser.





The **remote** and **config** icons are displayed in your Web browser.



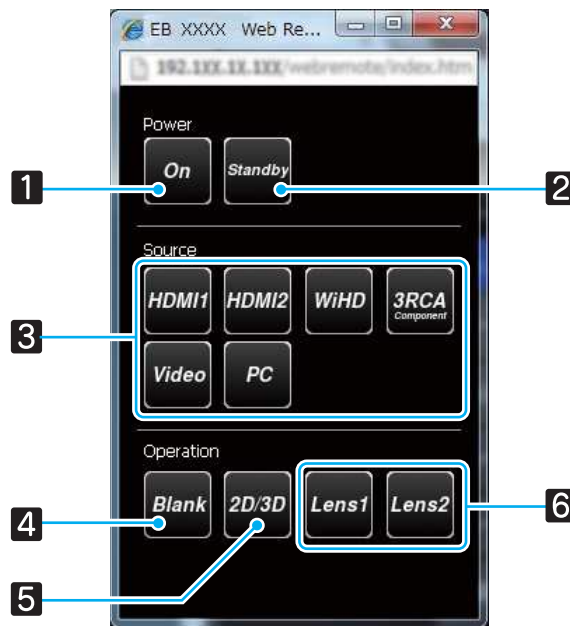







- 2 Tap the **remote** icon.
The Web Remote screen is displayed.

Web Remote screen buttons



	Button	Function
1		Turns the projector on.  p.27
2		Turns the projector off.  p.28

	Button	Function
3		Changes to the image from each input port.  p.34 (The WiHD button is only available for EH-LS9600W.)
4		Temporarily hides or shows the image.  p.36
5		Changes between 2D and 3D images.  p.39
6		Loads the lens position.  p.63

Using the Mail Notification Function to Report Problems

When you set Mail Notification in the Configuration menu, notification messages are sent to the preset email addresses when a problem or warning occurs with a projector. This will enable the operator to be notified of problems with projectors even at locations away from the projectors.  **Network - Mail - Mail Notification** [p.96](#)



- Up to a maximum of three notification destinations (addresses) can be registered, and notification messages can be sent to all three destinations at once.
- If a projector develops a critical problem and suddenly stops working, it may not be able to send a message notifying an operator of the problem.
- If you set **Standby Mode** to **Communication On**, you can monitor the projector even if it is in standby mode (when the power is off).  **Settings - Standby Mode** [p.91](#)

Reading error notification mail

When the Mail Notification function is set to On and a problem or warning occurs in the projector, the following email will be sent.

Subject: EPSON Projector

Line 1: The projector name where the problem has occurred

Line 2: The IP address set for the projector where the problem has occurred

Line 3 and on: Details of the problem

The details of the problem are listed line by line. The main message contents are listed below.

Message	Contents	Remedy
No-signal	No signal	No signal is input to the projector. Check the connection status or check that the power for the signal source is turned on.









Message	Contents	Remedy
Internal error	Internal error Laser driver error Fatal error Lens cover error	Handling errors or warnings is the same as checking the status of the indicators. ☛ p.101
Fan related error	Fan error	
Sensor error	Sensor error Light sensor error	
Cinema Filter Error	Cinema filter error	
Laser Error	Laser error Laser does not light up	
Internal temperature error	High temperature error	
High-speed cooling in progress	High temp warning	
Cinema Filter Warning	Cinema filter warning	
Static Iris Warning	Static iris warning	
Lens Iris Warning	Lens iris warning	
Static Iris Error	Static iris error	











Configuration Menu Functions

Configuration Menu Table

If there is no image signal being input, you cannot adjust items related to the image or signal in the Configuration menu. Note that the items displayed for the image, the signal, and other information vary depending on the image signal being projected.

Image menu

Function	Menu/Settings		Explanation
Color Mode	Dynamic, Living Room, Natural, THX* ¹ , Cinema, Digital Cinema* ² , Adobe RGB* ² , 3D Dynamic, 3D Cinema, 3D THX		Select the image quality based on your surroundings and the image you are projecting.  p.44
Brightness			Adjusts the image brightness.
Contrast			Adjusts the contrast between light and shade in the images. By increasing the contrast, the images become vivid.
Color Saturation* ³			Adjusts the color saturation for the images.
Tint* ³			Adjusts the tint for the images.
Sharpness	Standard		Adjusts the sharpness for the whole image.
	Advanced* ³	Thin Line Enhancement, Thick Line Enhancement, Vert. Line Enhancement, Horiz. Line Enhancement	 Adjusts the image sharpness. Use this to adjust specific areas.  p.53
Color Temp.	-3 - 6 (10 increments)* ⁴		Adjusts the tint for the images. The image is tinted blue for high values, and tinted red for low values.
Skin Tone			Increase the number to make colors greener, and decrease the number to make colors redder.

Function	Menu/Settings		Explanation	
Advanced	Gamma	2, 1, 0, -1, -2	Performs gamma adjustments. You can select a raw value or adjust the gamma while looking at the image or graph.  p.51	
		Customized		Adjust it from the image, Adjust it from the graph
		Reset		
	RGB	Offset R/G/B		Adjusts the offset and gain for each R, G, and B color.  p.52
		Gain R/G/B		
	RGBCMY	R/G/B/C/M/Y	Hue, Saturation, Brightness 	Adjusts the hue, saturation, and brightness for each R, G, B, C, M, and Y color.  p.50
EPSON Super White*5		On, Off	(This can only be set when the Color Mode is set to Natural, THX, Cinema, Adobe RGB, Digital Cinema, 3D Cinema , or 3D THX and when receiving signal input from the HDMI1 or HDMI2 ports, or from WirelessHD.) Set this to On if you are experiencing bright over exposure of whites in your image. When set to On , HDMI Video Range settings are disabled.	
Color Gamut		HDTV, EBU, SMPTE-C	Sets the color gamut to match the standard for the video devices being used.  p.59	
Power Consumption	High, Medium, ECO*6		You can set the brightness to one of three settings. Select ECO if the images being projected are too bright. When ECO is selected, power consumption during projection decreases, and fan rotation noise is reduced.	
Dynamic Contrast	Off, Normal, High Speed		You can change the luminance adjustment tracking for changes in brightness in the displayed image. Set to Off for no luminance adjustment.  p.48	
Lens Iris			Adjusts the amount of light entering the lens with the lens diaphragm, which adjusts the contrast of the image.  p.55	
Reset	Yes, No		You can reset all adjustment values for Image to their default settings.	

*1 This may not be displayed depending on the model you are using.

*2 Only EH-LS10000 is displayed.





*3 This is not displayed when a computer image signal is being input.





*4 When **Color Mode** is set to **Natural, THX, Adobe RGB**, or **3D THX** the settings change to **5000K - 10000K**.

*5 Settings are saved for each type of input source or Color Mode.

*6 When **Color Mode** is set to **THX**, the settings change to **Extra Bright, Normal**, and **ECO**.

■ Signal menu

Function	Menu/Settings		Explanation
3D Setup ^{*1 *2}	3D Display	On, Off	Enables or disables the 3D image display function.  p.39
	2D-to-3D Conversion	Off, Weak, Medium, Strong	Sets the strength of the 3D effect when converting 2D images to 3D images.  p.43
	3D Format	Auto, Side by Side, Top and Bottom, 2D	Sets the 3D format for the input signal. When set to Auto , the format is recognized automatically.
	3D Depth	-10 - 10	Sets the depth for the 3D image.
	Diagonal Screen Size	60 - 300	Sets the projection size for the 3D image. By matching this to the actual size, you can achieve the optimum 3D effect.
	Inverse 3D Glasses	Yes, No	Reverses the synchronization timing for the left/right shutters on the 3D Glasses and the left/right images. Enable this function if the 3D effect is not displayed correctly.
	3D Viewing Notice	On, Off	Enables or disables the notification that appears when viewing 3D image content.
Aspect ^{*3}	Auto, Normal, Full, Zoom, Anamorphic Wide, Horiz. Squeeze		Selects the aspect mode.  p.35
Tracking ^{*3 *4}	Varies depending on the input signal.		Adjusts computer images when vertical stripes appear in the images.
Sync. ^{*3 *4}	0 - 31		Adjusts computer images when flickering, fuzziness, or interference appear in the images. <ul style="list-style-type: none"> • Adjusting the Brightness, Contrast, or Sharpness may cause flickering or blurriness. • Adjusting the synchronization after adjusting tracking allows for more accurate adjustments.
Position ^{*3 *5}			Adjusts the display position up, down, left, and right when a part of the image is missing so that the whole image is projected.
Deinterlacing ^{*3}	Off, Video, Film/Auto ^{*6}		(This can only be set when receiving signal input from the Video port or when receiving 480i, 576i, or 1080i signal input from the Component, HDMI1, or HDMI2 ports or from WirelessHD.) Converts the signal from interlaced (i) to progressive (p) using a method appropriate for the image signal. <ul style="list-style-type: none"> • Off: This is ideal for dynamic motion images. • Video: This is ideal for viewing general video images. • Film/Auto: Performs the optimal conversion for film, CG, or animation input signals.
Motion Detection ^{*3 *6}	1 - 5		Sets the image motion speed from 1 (slow, for still images) to 5 (fast, for movies). Change this setting if you are experiencing poor still image quality or flickering movies.

Function	Menu/Settings		Explanation
Frame Interpolation*2 *6	Off, Low, Normal, High		Reduces afterimages when projecting moving images by interpolating between one frame and the next.  p.49
Super-resolution*6	0 - 5		(EH-LS9600W only) Reduces blurring that occurs at the edge of images when the resolution is increased.  p.46
Super-resolution/4K*2 *6	Off, 1, 2, 3, 4, 5, 4K-1, 4K-2, 4K-3, 4K-4, 4K-5		(EH-LS10000 only) Super-resolution (1 to 5) reduces blurring that occurs at the edge of images when the image is increased to 1920 x 1080 pixels. 4K Enhancement (4K-1 to 4K-5) projects 4K images (3840 x 2160 pixels), employing super resolution processing and creating ultra high definition images.  p.46
Detail Enhancement*2 *6 *7	Range, Strength	0 - 100	Enhances details in an image to create clear outlines. The higher the number, the wider the range from the outline area effected by the enhancement.  p.48
Auto Setup*4	On, Off		Sets whether or not to automatically adjust the image whenever the input signal is changed. When enabled, the Tracking, Position, and Sync. are automatically configured.
Advanced	Noise Reduction*2 *3 *6	Off, 1, 2, 3	(This can only be set when Image Processing is set to Fine .) Smooths out rough images. There are three modes available. Select your favorite setting. It is recommended that this is set to Off when viewing image sources in which noise is very low, such as for DVDs or Blu-ray discs.
	Setup Level*3 *6	0%, 7.5%	(This can be set when receiving an NTSC or component video signal from the Video port.) Change this setting when using devices with a different black level (Setup Level) such as products designed for the Korean market. Check the specifications for your connected device before changing this setting.

Function	Menu/Settings		Explanation
(Advanced)	Overscan ^{*2 *3 *8}	Auto, Off, 2%, 4%, 6%, 8%	Changes the output image ratio (the range of the projected image). <ul style="list-style-type: none"> • Off, 2% to 8%: Sets the range of the image. Off projects all ranges. Depending on the image signal you may notice noise at the top and bottom of the image. • Auto: This can only be set when receiving signal input from the HDMI1 or HDMI2 ports, or from WirelessHD. This may be automatically set to Off or 8% depending on the input signal.
	HDMI Video Range ^{*1 *3}	Auto, Normal, Expanded	(This can only be set when EPSON Super White is set to Off .) When set to Auto , the video level for the DVD input signal to the HDMI1 or HDMI2 ports, or to the WirelessHD is automatically detected and set. If you experience under or overexposure when set to Auto , set the video level of the projector to match that of the DVD/Blu-ray disc player's video level. Your DVD/Blu-ray disc player may be set to Normal or Expand. The Auto option is not displayed when connected to a connected device's DVI port.
	Image Processing ^{*6}	Fine, Fast	Performs processing to improve the image quality or response speed.  p.58
Reset	Yes, No		Resets all Signal settings except for Diagonal Screen Size , 3D Viewing Notice , Aspect , and Image Processing settings to their default settings.

*1 This is only displayed when an HDMI1, HDMI2, or WirelessHD image signal is being input (WirelessHD is for EH-LS9600W only).

*2 This cannot be set when a 4K image signal is being input.

*3 Settings are saved for each type of input source or signal.

*4 This is only displayed when a PC image signal is being input.





*5 This cannot be set when an HDMI1, HDMI2, or WirelessHD image signal is being input.











*6 This is not displayed when a PC image signal is being input.







*7 Settings are saved for each setting in Source, Color Mode, Super-resolution/4K (EH-LS10000), or Super-resolution (EH-LS9600W).

*8 This is only displayed when a Component, HDMI1, HDMI2, or WirelessHD image signal is being input (WirelessHD is for EH-LS9600W only).

Settings menu

Function	Menu/Settings		Explanation
Keystone	-60 - 60		Performs vertical keystone correction.  p.34
HDMI Link	Device Connections	-	Displays a list of devices connected from the HDMI1 or HDMI2 ports, or from WirelessHD*1.
	HDMI Link	On, Off	Enables or disables the HDMI Link function.
	Power On Link	Off, Bidirectional, Device -> PJ, PJ -> Device	Sets the link function when the power is turned on. Set to power on the projector when content is played on a connected device (Bidirectional or Device -> PJ) or to power on a connected device when the projector is turned on (Bidirectional or PJ -> Device).
	Power Off Link	On, Off	Sets whether or not to power off connected devices when the projector is turned off.
WirelessHD ^{1*}	Device Connections	-	Displays a list of available WirelessHD devices that can be connected.
	WirelessHD	On, Off	Enables or disables the WirelessHD function.
	Reception	55% 	Displays the reception for the image being projected. 0% is displayed when no image signal is being input. Use the Link indicator to check the communication status of the WirelessHD Transmitter.  p.68
	WiHD Mode	Full, Dynamic	Sets the connection mode of WirelessHD devices.
	Reset	Yes, No	Resets WirelessHD settings to their default settings. Note that even if you reset the projector, the WirelessHD Transmitter settings are not reset. To reset the WirelessHD Transmitter, press the Setup button on the base.  p.68

Function	Menu/Settings		Explanation
Lock Setting	Lens Lock	On, Off	When set to On , the focus, zoom, and lens shift settings are locked at their current settings. If you press the  button when Lens Lock is set to On ,  is displayed on the screen.
	Child Lock	On, Off	This locks the  button on the projector's control panel to prevent children from turning on the projector by accident. You can turn on the power when locked by holding down the  button for approximately three seconds. You can still turn off the device using the  button, or perform operations with the remote control as usual. If changed, this setting is enabled after you power off the projector and the cool-down process is complete. Note that even if Child Lock is set to On , the projector still turns on when the power cord is connected if Direct Power On is set to On .
	Control Panel Lock	On, Off	When set to On , all buttons on the control panel except for the  button are disabled.  is displayed on the screen if any buttons are pressed. To unlock, press and hold the  button on the control panel for at least 7 seconds. If changed, this setting is enabled once you close the Configuration menu.
Projection	Front, Front/Ceiling, Rear, Rear/Ceiling		Change this setting depending on how the projector is installed. <ul style="list-style-type: none"> • Front: Select if you are projecting in front of the screen. • Front/Ceiling: Select if you are projecting in front of the screen suspended from the ceiling. • Rear: Select if you are projecting to a rear screen from the back. • Rear/Ceiling: Select if you are projecting to a rear screen from the back when the projector is suspended from the ceiling.
User Button* ²	2D-to-3D Conversion, 3D Depth, Inverse 3D Glasses, Power Consumption, Detail Enhancement, Info		Select a Configuration menu item to assign to the  button on the remote control. By pressing the  button, the assigned menu item selection/adjustment screen is displayed, allowing you to make one-touch settings/adjustments.
Picture in Picture* ³	-		Starts the Picture in Picture display.  p.79
Standby Mode	Communication On, Communication Off		When set to Communication On , you can make settings and control the projector over the network even when the projector is in standby status.

Function	Menu/Settings		Explanation
Operation	Direct Power On	On, Off	You can set up the projector so that projection starts as soon as the power cord is plugged in without any button operations. Note that when this is set to On , projection starts if power is restored after a blackout or other power outage and the power cord is still plugged into the projector.
	Sleep Mode	Off, 5min., 10min., 20min.	If the set time is exceeded and no signal is input, the projector is automatically turned off and enters standby mode. When set to Off , the projector never enters sleep mode. When in standby mode, press the  button on the remote control or the  button on the control panel to start projection.
	Illumination	On, Off	Set this to Off if the light from the indicators on the control panel bothers you when watching a movie in a dark room.
	Trigger Out 1 Trigger Out 2	Off, Power, Anamorphic Wide	Set the Trigger Out function to communicate the projector's power on status to external devices. Trigger Out 1 corresponds to the Trigger out 1 port, and Trigger Out 2 corresponds to the Trigger out 2 port. When set to Off , no voltage is output from the Trigger out 1/Trigger out 2 ports. When set to Power , voltage is output from the Trigger out 1/Trigger out 2 ports when the projector is on. For Anamorphic Wide , when the projector is on and Aspect is set to Anamorphic Wide or Horiz. Squeeze , voltage is output from the Trigger out 1/Trigger out 2 ports. If you change this setting, the new setting will take effect the next time you turn the projector on.
	High Altitude Mode	On, Off	Set this to On if you are using the projector above an altitude of 1500 meters.
	Lens Adjustment Mode	1, 2, 3	Set the amount of lens movement for the focus, zoom, and lens shift adjustments when pressing the     buttons once. The default value is 2 . Select 1 to make the amount of movement smaller, and select 3 to make the amount of movement larger.

Function	Menu/Settings		Explanation
Display	Menu Position	-	Sets the position where the menu should be displayed.
	Menu Color	Color 1, Color 2	<p>Selects the color for the Configuration menu.</p> <ul style="list-style-type: none"> • Color 1 Main menu: Black Selected items: Gray • Color 2 Main menu: Blue Selected items: Orange
	Messages	On, Off	<p>Sets whether or not to display the following messages (On or Off).</p> <ul style="list-style-type: none"> • Item names for image signals, color modes, aspect ratios, and loading memory. • If the internal temperature is rising when no image signal is being input or an unsupported signal is detected.
	Display Background	Black, Blue, Logo	Selects the screen status when no image signal is being input.
	Startup Screen	On, Off	Sets whether or not to show a startup screen when projection begins (On or Off). If changed, this setting is enabled after you power off the projector and the cool-down process is complete.
	Standby Confirmation	On, Off	Sets whether or not to display a standby confirmation message (On or Off).  p.28
Input Signal	Video Signal	Auto, NTSC, NTSC4.43, PAL, M-PAL, N-PAL, PAL60, SECAM	<p>Sets the signal type depending on the video device connected to the Video port. When set to Auto, the video signal is set automatically. If you notice noise in the image even when set to Auto, or if you are not seeing any image at all, select the correct signal type from the available options.</p>
	Component	Auto, YCbCr, YPbPr	<p>Sets the output signal for the video device connected to the Component ports. When set to Auto, the output signal is set automatically. If you notice unnatural colors when set to Auto, set the appropriate output signal from the available options.</p>
Panel Alignment	Panel Alignment	On, Off	Enables or disables Panel Alignment .
	Select Color	R, B	Select the color to correct.
	Pattern Color	R/G/B, R/G, G/B	Select the pattern used for correction.
	Start Adjustments	-	Starts Panel Alignment .  p.56
	Reset	Yes, No	Resets the correction value.
Language	-		Selects the display language.









Function	Menu/Settings	Explanation
Reset	Yes, No	<p>All adjustment values for Settings are returned to their default settings, except for the following.</p> <ul style="list-style-type: none"> • Power On Link • Power Off Link • Projection • User Button • Standby Mode • High Altitude Mode • Component • Language

*1 Only EH-LS9600W is displayed.

*2 Only EH-LS10000 is displayed.

*3 Cannot be set when a 4K image signal is being input.





Memory menu

Function	Explanation
Load Memory	<p>Loads settings saved using the Save Memory function.  p.65</p> <p>This cannot be selected if you have not saved any settings with the Save Memory function.</p>
Save Memory	Saves certain Image menu and Signal menu settings to memory.  p.64
Erase Memory	Erases the saved memory.  p.66
Rename Memory	Renames a saved memory.  p.66
Load Lens Position	<p>Loads adjustment values saved using the Save Lens Position function.  p.63</p> <p>This cannot be selected if you have not saved any settings with the Save Lens Position function.</p>
Save Lens Position	Saves the focus, zoom, and lens shift adjustment as a lens position.  p.62
Erase Lens Position	Erases the saved lens position.  p.63
Rename Lens Position	Renames a saved lens position.  p.63

Network menu

When you have made network settings for the projector and you connect to a computer or smart device on the network, you can change settings from your Web browser without displaying the Configuration menu, or you can use the computer or smart device as a remote control.

Also, when mail notification settings have been made and an error or warning occurs in the projector, a notification email is sent to the email addresses you have specified.

Function	Explanation
Net. Info. - Wired LAN	<p>Displays the following network setting status information.</p> <ul style="list-style-type: none"> • Projector Name • DHCP • IP Address • Subnet Mask • Gateway Address • MAC Address
Network Configuration	<p>The following menus are available for setting Network items.</p> <ul style="list-style-type: none"> • Basic  p.96 • Wired LAN  p.97 • Mail  p.97 • Others  p.98 • Reset  p.98

Network menu operations

Selecting from the top menu and sub menus, and changing selected items is the same as making operations from the Configuration menu. When done, make sure you go to the **Setup complete** menu, and select **Yes**, **No**, or **Cancel**. When you select **Yes** or **No**, you are returned to the Configuration menu.



Yes: Saves the settings and exits the **Network** menu.

No: Does not save the settings and exits the **Network** menu.

Cancel: Allows you to continue making settings without exiting the **Network** menu.

Basic menu

Function	Explanation
Projector Name	<p>The name used to identify this projector on a network. When editing, you can enter up to 16 single-byte alphanumeric characters. (" * + , / ; < = > ? [¥] ` cannot be used.)</p>
PJLink Password	<p>Set a password to use when you access the projector using compatible PJLink software. You can enter up to 32 single-byte alphanumeric characters. (Symbols cannot be used.)</p>

Function	Explanation
Web Control Password	Set a password to use Web Control. You can enter up to 32 single-byte alphanumeric characters. (* cannot be used.) Web Control is a function that allows you to change the projector's settings by using the Web browser on a computer or smart device connected to the network.  p.81

Wired LAN menu

Function	Menu/Settings		Explanation
IP Settings	DHCP	On, Off	Set whether or not (On/Off) to use DHCP. If this is set to On , you cannot set any more addresses.
	IP Address		Enter the IP address assigned to the projector. You can enter a number from 0 to 255 in each field of the address. However, the following IP addresses cannot be used. 0.0.0.0, 127.x.x.x, 224.0.0.0 to 255.255.255.255 (where x is a number from 0 to 255)
	Subnet Mask		Enter the projector's subnet mask. You can enter a number from 0 to 255 in each field of the address. However, the following subnet masks cannot be used. 0.0.0.0, 255.255.255.255
	Gateway Address		Enter the projector's gateway IP address. You can enter a number from 0 to 255 in each field of the address. However, the following gateway addresses cannot be used. 0.0.0.0, 127.x.x.x, 224.0.0.0 to 255.255.255.255 (where x is a number from 0 to 255)
IP Address Display	On, Off		Set to Off to prevent the IP address from being displayed on the Net. Info. - Wired LAN or Web Control screen.

Mail menu

When this is set, you receive an email notification if a problem or warning occurs in the projector.

Function	Menu/Settings	Explanation
Mail Notification	On, Off	Set to On to send an email to the preset addresses when a problem or warning occurs with a projector.
SMTP Server	-	Enter the IP address for the SMTP server for the projector. You can enter a number from 0 to 255 in each field of the address. However, the following IP addresses cannot be used. 127.x.x.x, 224.0.0.0 to 255.255.255.255 (where x is a number from 0 to 255)
Port Number	1 - 65535	Enter the port number for the SMTP server. The default value is 25. You can input numbers between 1 to 65535.

Function	Menu/Settings	Explanation
Address 1 Setting Address 2 Setting Address 3 Setting	-	Enter the destination email addresses to which to send the notification email, and select the problems or warnings you want to be notified about. You can register up to three destinations. You can enter up to 64 single-byte alphanumeric characters for the email addresses. (" () , ; < > [¥] cannot be used.) You can enter up to 32 characters on the Configuration menu. When entering more than 32 characters, use your Web browser to enter the text.  p.81

Others menu

Function	Menu/Settings	Explanation
AMX Device Discovery	On, Off	When you want to allow the projector to be detected by AMX Device Discovery, set this to On . Set this to Off if you are not connected to an environment controlled by a controller from AMX or AMX Device Discovery.
Control4 SDDP*	On, Off	When you want to allow the projector to be detected by Control4 SDDP, set this to On . Set this to Off if you are not connected to an environment controlled by a controller from Control4 or Control4 SDDP.
Bonjour	On, Off	Set this to On when connecting to the network using Bonjour. See Apple's Web site for more information on the Bonjour service. http://www.apple.com/

* Only EH-LS10000 is displayed.





Reset menu

To reset all of the network settings, select **Yes**. After you reset all the settings, the **Basic** menu appears.



Complete menu

Select this when you have finished making settings on the **Network** menu.  p.96

Soft keyboard operations

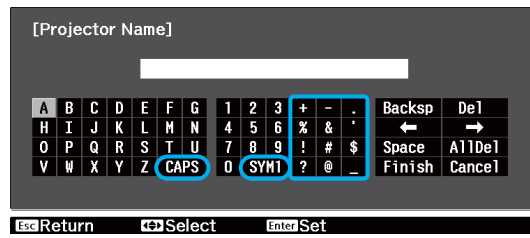
The **Network** menu contains items that require input of alphanumerics during setup. In this case, the following soft keyboard is displayed. Use the     buttons to move the cursor to the desired key, and then press the  button to enter the selected character. After inputting, press **Finish** on the soft keyboard to confirm your input. Press **Cancel** on the soft keyboard to cancel your input.



- Each time the **CAPS** key is selected and the  button is pressed, it sets and changes between upper case and lower case letters.
- Each time the **SYM1/SYM2** key is selected and the  button is pressed, it sets and changes the symbol keys for the section enclosed by the frame.

The following types of character can be entered.

Numbers	0123456789
Letters	ABCDEFGHIJKLMNOPQRSTUVWXYZabcdefghijklmnopqrstuvwxyz
Symbols	! # \$ % & ' () + - . / < = > ? @ ` ^ _ { } ~



- You cannot use colons (:) for **Network** menu items.
- You cannot use spaces for **Network** menu items.
- The following four characters cannot be entered using the soft keyboard. Enter these characters using a Web browser.  [p.81](#)
" * , ;

Info menu

Function	Explanation
Operation Hours	Displays the cumulative operating time.
Source	Displays the source name for the connected equipment currently being projected.
Input Signal	Displays the content of Input Signal set in the Signal menu according to the source.
Resolution	Displays the resolution.
Scan Mode	Displays the scan mode.
Refresh Rate	Displays the refresh rate.
3D Format	Displays the 3D format of the signal input during 3D projection (Frame Packing, Side by Side, or Top and Bottom).
Sync Info	Displays the image signal information. This information may be needed if service is required.
Deep Color	Displays deep color.
Video Signal	Displays the settings for Video Signal in the Settings menu.
Status	This is information about errors that have occurred on the projector. This information may be needed if service is required.
Serial Number	Displays the projector's serial number.
Version	Displays the firmware version of the projector.





Reset menu

Function	Explanation
Reset All	Resets all items in the Configuration menu to their default settings. The following items are not reset to their defaults: Input Signal - Component, Panel Alignment, Language, Save Memory, Save Lens Position, and Operation Hours.
Reset Memory	Erases all settings saved using the Save Memory function.
Reset Lens Position	Erases all settings saved using the Save Lens Position function.

Picture in Picture menu

Displayed by pressing the  button during Picture in Picture projection.



 This cannot be set when 3D image or 4K image signals are being input.

Function	Menu/Settings		Explanation
Picture in Picture	Subscreen Size	Small, Large	Changes the size of the sub screen.  p.80
	Subscreen Position	Top Right, Bottom Right, Top Left, Bottom Left	Changes the position of the sub screen.  p.80
	Subscreen Source*	HDMI1, HDMI2, WirelessHD	Selects which source is displayed as the sub screen.  p.80
	Swap Main/Sub		Changes the main and sub screens.  p.80
	Exit Picture in Picture		Exits the Picture in Picture display.  p.80

* Only EH-LS9600W is displayed.

Problem Solving



Reading the Indicators

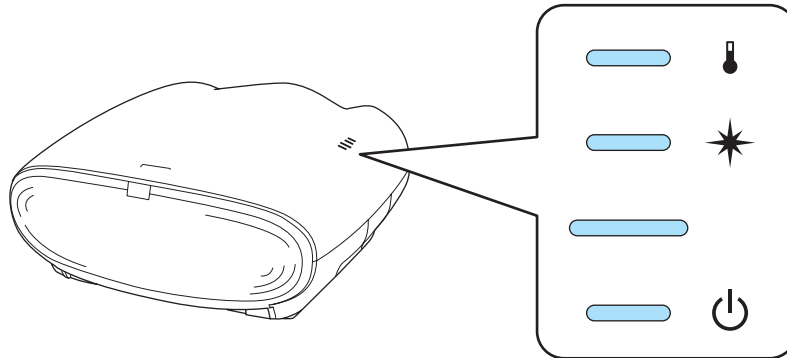















You can check the status of the projector from the flashing and lit , ,  operation indicators.





Refer to the following table to check the projector's status and how to remedy problems shown by the indicators.



Indicator status during an error/warning

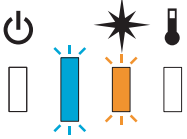
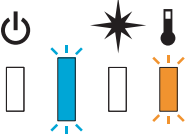
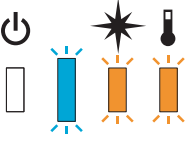
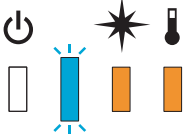

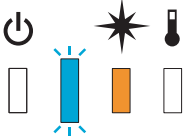

















 : Lit  : Flashing  : Status maintained  : Off

Indicators	Status	Remedy
       (blue)/(orange)	High temp warning	You can continue projecting. If the temperature rises too high again, projection stops automatically. <ul style="list-style-type: none"> • If the projector is installed next to a wall, make sure there is at least 20 cm between the wall and the projector's air intake vent. • If the air filter is clogged, clean it.  p.113
       (blue)/(orange)	High temp error (overheating)	The internal temperature is too high. <ul style="list-style-type: none"> • The laser turns off automatically and projection stops. When the fan has stopped, disconnect the power cord. • If the projector is installed next to a wall, make sure there is at least 20 cm between the wall and the projector's air intake vent. • If the air filter is clogged, clean it.  p.113 • If turning the power back on does not clear the problem, stop using the projector and remove the power plug from the electrical outlet. Contact your local dealer or the nearest Epson repair center.  Epson Projector Contact List



Indicators	Status	Remedy
 <p>(blue)/(orange)</p>	<p>Internal error</p>	<p>The projector has malfunctioned. Remove the power plug from the electrical outlet, and contact your local dealer or the nearest Epson repair center. Epson Projector Contact List</p>
 <p>(blue)/(orange)</p>	<p>Fan error Sensor error Light sensor error</p>	
 <p>(blue)/(orange)</p>	<p>Cinema filter error Static iris error Lens cover error</p>	
 <p>(blue)/(orange)</p>	<p>Laser driver error</p>	
 <p>(blue)/(orange)</p>	<p>Fatal error</p>	
 <p>(blue)/(orange)</p>	<p>Laser error Laser light failure</p>	<p>There is a problem with the laser section, or it failed to turn on.</p> <ul style="list-style-type: none"> When using at an altitude of 1500 m or more, set High Altitude Mode to On. Settings - Operation - High Altitude Mode p.91 If the problem does not improve even after trying the solutions mentioned above, stop using the projector and remove the power plug from the electrical outlet. Contact your local dealer or the nearest Epson repair center. Epson Projector Contact List

Indicator status during normal operation

 : Lit  : Flashing  : Off

Indicators	Status	Remedy
  	Standby condition	When you press the  button on the remote control, or the  button on the control panel, projection starts.
   (blue)	Standby condition (Standby Mode is set to Communication On.)	When you press the  button on the remote control, or the  button on the control panel, projection starts.
	WirelessHD standby status	When you start playback on the AV device connected to the WirelessHD Transmitter, projection starts.
   (blue)	Warm-up in progress	The power-off operation is disabled while the projector is warming-up.
	Cool-down in progress	All operations are disabled while the projector is cooling-down. The projector enters standby condition when cool-down is complete. If for any reason the power cord is disconnected during cool-down, wait until the projector has cooled down sufficiently, reconnect the power cord, and then press the  button on the remote control, or the  button on the control panel.
   (blue)	Projection in progress	The projector is operating normally.
	Standby condition (Standby Mode is set to Communication On.)	When you press the  button on the remote control, or the  button on the control panel, projection starts.



- Under normal operating conditions, the  and  indicators are off.
- When the **Illumination** function is set to **Off**, all indicators are off under normal projection conditions.
 **Settings - Operation - Illumination** [p.91](#)

When the Indicators Provide No Help

■ Check the problem







Check the following table to see if your problem is mentioned, and go to the appropriate page for information on handling the problem.

	Problem	Page
Problems relating to images	No images appear	p.105
	Projection does not start, the projection area is completely black, or the projection area is completely blue	
	Moving images being projected from a computer are not projected	p.105
	" Not supported " is displayed	p.106
	" No Signal " is displayed	p.106
	Images are fuzzy or out of focus	p.107
	Interference or distortion appears in the images	p.107
	The image is truncated (large) or small, or only a part of the image is projected	p.107
	Image colors are not right	p.108
	The whole image appears purplish or greenish, images are black & white, or colors appear dull*	
	Images appear dark	p.108
Projection stops automatically	p.108	
The LCD Alignment correction is not satisfactory or difficult to achieve	p.109	
Problems when projection starts	The projector does not turn on	p.109
Problems with the remote control	The remote control does not respond	p.109
Problems with the control panel	Cannot make settings on the control panel	p.110
Problems with 3D images	Cannot project correctly in 3D	p.110
	The 3D image is enlarged and truncated	p.111
Problems with HDMI	HDMI Link does not function	p.111
	The device name is not displayed under Device Connections	p.111
Problems with WirelessHD	Cannot project WirelessHD images	p.111
	Interference, distortion, or interruption appear in WirelessHD	p.112

* Because color reproduction differs between monitors and computer LCD screens, the image projected by the projector and the color tones displayed on the monitor may not match, however this is not a fault.

■ Problems relating to images

No images appear

Check	Remedy
Is the power turned on?	Press the  button on the remote control or the  button on the control panel.
Is the power cord connected?	Connect the power cord.
Are the indicators switched off?	Disconnect and then reconnect the projector's power cord. Check that pressing the power button after connection supplies the projector with power.
Is an image signal being input?	Check that the connected device is turned on. When Messages is set to On from the Configuration menu, image signal messages are displayed.  Settings - Display - Messages p.91
Has the power to the AV amplifier been disconnected?	If an AV amplifier is connected, check the AV amplifier's power supply.
Is an image signal being sent from the device?	Check that an image signal is being sent from the connected device.
Is the image signal format setting correct?	When Video is input If nothing is projected even when Video Signal is set to Auto from the Configuration menu, set the signal that matches the connected device.  Settings - Input Signal - Video Signal p.91
	When Component is input If nothing is projected even when Component is set to Auto from the Configuration menu, set the signal that matches the connected device.  Settings - Input Signal - Component p.91
Are the Configuration menu settings correct?	Reset all of the settings.  Reset - Reset All p.100
(Only when projecting computer image signals) Was the connection made while the power of the projector or the computer was already turned on?	If the connection is made while the power is already turned on, the key (Function key and so on) that changes the computer's image signal to external output may not work. Turn off the connected computer, and then turn it back on.

Moving images are not displayed

Check	Remedy
(Only when projecting computer image signals) Is the computer's image signal set to external output and to output to the LCD monitor at the same time?	Depending on the computer's specifications, moving images may not be displayed when the computer is set to external output and to the LCD monitor output at the same time. Change it so that the image signal is set to external output only. For the computer's specifications, see the documentation supplied with the computer.

"Not supported" is displayed

Check	Remedy
Is the image signal format setting correct?	<p>When Video is input If nothing is projected even when Video Signal is set to Auto from the Configuration menu, set the signal that matches the connected device. 🖱️ Settings - Input Signal - Video Signal p.91</p> <p>When Component is input If nothing is projected even when Component is set to Auto from the Configuration menu, set the signal that matches the connected device. 🖱️ Settings - Input Signal - Component p.91</p>
<p>(Only when projecting computer image signals)</p> <p>Do the image signal's frequency and resolution correspond to the mode?</p>	<p>Check the image signal being input in Resolution from the Configuration menu, and check that it corresponds to the projector's resolution. 🖱️ p.117</p>

"No Signal" is displayed

Check	Remedy
Are the cables connected correctly?	Check that all the cables required for projection are securely connected. 🖱️ p.20
Is the correct image input port selected?	Change the image with the source buttons on the remote control, or the <input type="button" value="Source"/> button on the control panel. 🖱️ p.34
Is the connected device turned on?	Turn on the device.
<p>(Only when projecting computer image signals)</p> <p>Are the image signals being output to the projector?</p>	<p>Change it so that the image signal is set to external output, and not just the computer's LCD monitor. For some models, when the image signals are output externally, they no longer appear on the LCD monitor. For the computer's specifications, see the documentation supplied with the computer.</p> <p>If the connection is made while the power of the projector or the computer is already turned on, the Fn key (Function key) that changes the computer's image signal to external output may not work. Turn off the computer and the projector, and then turn them back on.</p>
<p>When connecting an MHL device to the WirelessHD Transmitter with an MHL cable, is it connected to the HDMI5 port?</p> <p>(EH-LS9600W only)</p>	<p>Connect to the HDMI5 port on the WirelessHD Transmitter.</p> <p>The connected device is not compatible with MHL. For more details, contact the manufacturer of the device.</p>

Images are fuzzy or out of focus

Check	Remedy
Has the focus been adjusted?	Adjust the focus. 🖱️ p.32
Is the projector at the correct distance?	Check the recommended projection range. 🖱️ p.18
Has condensation formed on the lens?	If the projector is suddenly taken from a cold environment to a warm environment, or if sudden ambient temperature changes occur, condensation may form on the surface of the lens, and this may cause the images to appear fuzzy. Set the projector up in the room about one hour before it is used. If the projector is wet from condensation, turn off the projector, disconnect the power cord, and leave it for a while.

Interference or distortion appear in images

Check	Remedy
Is the image signal format setting correct?	<p>When Video is input If nothing is projected even when Video Signal is set to Auto from the Configuration menu, set the signal that matches the connected device. 🖱️ Settings - Input Signal - Video Signal p.91</p> <p>When Component is input If nothing is projected even when Component is set to Auto from the Configuration menu, set the signal that matches the connected device. 🖱️ Settings - Input Signal - Component p.91</p>
Are the cables connected correctly?	Check that all the cables required for projection are securely connected. 🖱️ p.20
Is an extension cable being used?	If an extension cable is used, electrical interference may affect the signals.
(Only when projecting computer image signals) Are the Sync. and Tracking settings adjusted correctly?	The projector uses automatic adjustment functions to project at the optimum status. However, depending on the signal, some may not be adjusted correctly even after performing self corrections. If this happens, adjust the Tracking and Sync. settings from the Configuration menu. 🖱️ Signal - Tracking/Sync. p.88
(Only when projecting computer image signals) Is the correct resolution selected?	Set the computer so that the signals being output are compatible with the projector. 🖱️ p.117

Part of the image is truncated (large) or small

Check	Remedy
Is the correct Aspect selected?	Press the <input type="button" value="Aspect"/> button, and then select the Aspect that matches the input signal. 🖱️ Signal - Aspect p.88
(Only when projecting computer image signals) Is the correct resolution selected?	Set the computer so that the signals being output are compatible with the projector. 🖱️ p.117



Image colors are not right

Check	Remedy
Is the image signal format setting correct?	<p>When Video is input If nothing is projected even when Video Signal is set to Auto from the Configuration menu, set the signal that matches the connected device. 🖱️ Settings - Input Signal - Video Signal p.91</p> <p>When Component is input If nothing is projected even when Component is set to Auto from the Configuration menu, set the signal that matches the connected device. 🖱️ Settings - Input Signal - Component p.91</p>
Are the cables connected correctly?	<p>Check that all the cables required for projection are securely connected. 🖱️ p.20</p> <p>For the Video and Component ports, make sure the connector is the same color as the cable port. 🖱️ p.21</p>
Is the contrast adjusted correctly?	Adjust the Contrast setting from the Configuration menu. 🖱️ Image - Contrast p.86
Is the color adjusted correctly?	Adjust the Advanced setting from the Configuration menu. 🖱️ Image - Advanced p.86
(Only when projecting images from a video device) Are the color saturation and tint adjusted correctly?	Adjust the Color Saturation and Tint settings from the Configuration menu. 🖱️ Image - Color Saturation/Tint p.86



Images appear dark

Check	Remedy
Is the image brightness set correctly?	Adjust the Brightness setting from the Configuration menu. 🖱️ Image - Brightness p.86
Is the contrast adjusted correctly?	Adjust the Contrast setting from the Configuration menu. 🖱️ Image - Contrast p.86

Projection stops automatically





Check	Remedy
Is Sleep Mode enabled?	<p>If the set time is exceeded and no signal is input, the laser turns off automatically, and the projector enters standby status. The projector returns from standby status when you press the  button on the remote control or the  button on the control panel. Do not look into the laser when returning from standby status. If you do not want to use Sleep Mode, change the setting to Off. 🖱️ Settings - Operation - Sleep Mode p.91</p>

The Panel Alignment adjustment is not satisfactory or difficult to achieve

Check	Remedy
Does the Projection setting match the projector's installation position?	The panel alignment adjustment method changes depending on the Projection setting. Make sure the Projection setting matches the projector's installation position.  Settings - Projection p.91
Is the projection surface suitable?	For best results, the projection surface should not be colored or textured, otherwise the adjustment grids will be difficult to align. Project onto a screen and so on that is white and does not have a pattern.
Were adjustments made immediately after the projector was turned on?	To obtain stable image quality, leave the projector on for a while before making adjustments.
Is the image size suitable?	The projected image should be a minimum of 60".
Is the shifted color magenta?	Adjust R (red) and B (blue) for Select Color since magenta is a mixture of red and blue.
Do the lines in the pattern look fuzzy or out of focus?	Adjust the focus.  p.32



 Problems when projection starts



The projector does not turn on

Check	Remedy
Is the power turned on?	Press the  button on the remote control or the  button on the control panel.
Is Child Lock set to On ?	When Child Lock is set to On from the Configuration menu, hold down the  button on the control panel for approximately three seconds, or perform operations from the remote control.  Settings - Lock Setting - Child Lock p.91
Do the indicators turn on and off when the power cord is touched?	Turn off the projector, and then disconnect and reconnect the projector's power cord. If the problem continues, stop using the projector, remove the power plug from the electrical outlet, and contact your local dealer or the nearest projector information center.  Epson Projector Contact List

 Problems with the remote control



The remote control does not respond

Check	Remedy
Is the remote control light-emitting area pointing towards the remote receiver on the projector during operation?	Point the remote control towards the remote receiver. Also, check the operating range.  p.25
Is the remote control too far from the projector?	Check the operating range.  p.25
Is direct sunlight or strong light from fluorescent lamps shining onto the remote receiver?	Set the projector up in a location where strong light does not shine onto the remote receiver.

Check	Remedy
Are the batteries dead or have the batteries been inserted correctly?	Make sure the batteries are inserted correctly or replace the batteries with new ones if necessary.  p.25
Is the remote control pointed at the WirelessHD Transmitter when operating the WiHD Transmitter buttons? (EH-LS9600W only)	Make sure you point the remote control at the WirelessHD Transmitter when using the WiHD Transmitter buttons on the remote control.  p.75





 Problems with the control panel

Cannot make settings on the control panel

Check	Remedy
Is Control Panel Lock set to On ?	If Control Panel Lock is set to On from the Configuration menu, all of the control panel buttons except for the  button are disabled. Perform operations from the remote control.  Settings - Lock Setting - Control Panel Lock p.91

 Problems with 3D images

Cannot project correctly in 3D



Check	Remedy
Are the 3D Glasses turned on?	Turn on the 3D Glasses.
Is a 3D image being projected?	If the projector is projecting a 2D image, or if an error occurs on the projector that prevents the 3D image from being projected, you cannot view 3D images even if you are wearing the 3D Glasses.
Is the input image in 3D?	Check that the input image is 3D compatible. Since most TV broadcasts do not contain a 3D format signal, 3D reception must be set manually.
Is 3D Display set to Off ?	If 3D Display is set to Off from the Configuration menu, the projector does not automatically change to 3D even when a 3D image is input. Press the  button.  Signal - 3D Setup - 3D Display p.88
Is the correct 3D format set?	The projector automatically selects the appropriate 3D format, but if the 3D image is not displayed correctly, use 3D Format from the Configuration menu to select another format.  Signal - 3D Setup - 3D Format p.88
Are you viewing within the reception range?	Check the range within which the 3D Glasses can communicate with the projector, and view within that range.  p.42
Has pairing been performed correctly?	See the User's Guide for the 3D Glasses to perform pairing.
Are there any devices that cause radio wave interference in the vicinity?	When using other devices at the same time with the frequency band (2.4 GHz) such as Bluetooth communication devices, wireless LAN (IEEE802.11b/g), or microwave ovens, radio wave interference may occur, the image may be interrupted, or communication may not be possible. Do not use the projector near these devices.

The 3D image is enlarged and truncated

Check	Remedy
Is the correct 3D video format set?	Video may be truncated if an incorrect 3D format is set. Set the correct 3D format.  p.37

 Problems with HDMI

HDMI Link does not function



Check	Remedy
Are you using a cable that meets the HDMI standards?	Only high-speed HDMI cables are supported.
Does the connected device meet the HDMI CEC standards?	If the connected device does not meet the HDMI CEC standards, it cannot be operated even if it is connected to the HDMI port. See the documentation and so on supplied with the connected device for more information. Also, press the  button, and then check if the device is available under Device Connections .  p.60
Are the cables connected correctly?	Check that all the cables required to use HDMI Link are securely connected.  p.60
Is the power for the amplifier or DVD/Blu-ray disc player and so on turned on?	Put each device in standby status. See the documentation and so on supplied with the connected device for more information.
Was a new device connected, or was the connection changed?	If the CEC function for a connected device needs to be set again, for example when a new device is connected or the connection is changed, you may need to restart the device.
Are many multi-media players connected?	Up to 3 multi-media players that meet the HDMI CEC standards can be connected at the same time.





The device name is not displayed under Device Connections

Check	Remedy
Does the connected device meet the HDMI CEC standards?	If the connected device does not meet the HDMI CEC standards, it is not displayed. See the documentation and so on supplied with the connected device for more information.





 Problems with WirelessHD (EH-LS9600W only)

Cannot project WirelessHD images

Check	Remedy
Does the cable connecting the supplied WirelessHD Transmitter meet the HDMI standards?	If the cable does not meet the HDMI standards, operations are not possible.
Is WirelessHD set to Off ?	When WirelessHD is set to Off from the Configuration menu, projection is not possible for WirelessHD input signals. Set WirelessHD to On , and then press the  button.  Settings - WirelessHD - WirelessHD p.91

Check	Remedy
Are signals being received within the WirelessHD transmission range?	Check the Wireless HD transmission range, and view within that range.  p.74
Is the supplied WirelessHD Transmitter turned on?	Check the  indicator on the WirelessHD Transmitter. If there is no power being supplied, make sure the connector for the AC adapter is securely connected, and then turn on the power switch.
Is the WiHD indicator for the supplied WirelessHD Transmitter off?	No signal is output from the AV device connected to the WirelessHD Transmitter. Check that the cables from the AV device and the WirelessHD Transmitter are securely connected.
	Images are being output from a monitor device, such as a television, connected to the Output port on the WirelessHD Transmitter. Press the  button and change the output image to the projector.
Is the Link indicator for the supplied WirelessHD Transmitter off?	The WirelessHD cannot communicate with the projector. Check the Wireless HD transmission range, and view within that range.
Has dust collected in the WirelessHD's air intake vent?	If the WirelessHD receiver becomes hot, it may not receive signals. Clean the dust so that heat can be vented.
Are the projector and the WirelessHD Transmitter facing the correct way?	Setup the projector and the WirelessHD Transmitter so that they are facing each other.
Is " Source: WirelessHD X "/" No Signal " displayed in the lower-left part of the screen?	Check that the AV device connected with the HDMI port on the WirelessHD Transmitter is turned on. The input signal number displayed on the screen is the same as the HDMI port number. In addition, unless HDMI Link is set to On , the connected device does not turn on. Set HDMI Link to On .  Settings - HDMI Link - HDMI Link p.91

Interference, distortion, or interruption appear in WirelessHD

Check	Remedy
Are signals being received within the WirelessHD transmission range?	Check the Wireless HD transmission range, and view within that range.  p.74
Are there any obstructions between the WirelessHD Transmitter and the projector?	Because WirelessHD communicates using a tight beamed electromagnetic wave, if there are any people or objects and so on obstructing the communication path, this could have an adverse affect on the image. Make sure that there are no obstacles between the WirelessHD Transmitter and the projector within the WirelessHD transmission range.  p.74
Is the reception too low?	If the transmissions are not strong enough, communication may be unstable. Check Reception while images are being projected as you set up the transmitter as it is sometimes possible to improve the strength of the transmission by moving the WirelessHD Transmitter or changing its direction.  Settings - WirelessHD - Reception p.91
	Transmission strength may differ depending on the surroundings, or they may be unstable. While checking Reception , setup the transmitter in a location where the number displayed remains steady.  Settings - WirelessHD - Reception p.91



Maintenance

Cleaning the Parts

You should clean the projector if it becomes dirty or if the quality of projected images starts to deteriorate.

Warning

Do not use sprays that contain flammable gas to remove dirt and dust from the projector's air filter, and so on. The gases may ignite and result in fire.

Cleaning and replacing the air filter

Clean the air filter if dust has accumulated on the air filter or when the following message is displayed. **"The projector is overheating. Make sure nothing is blocking the air vent, and clean or replace the air filter."**

Attention

- If dust collects on the air filter, it can cause the internal temperature of the projector to rise, and this can lead to problems with operation and shorten the optical engine's service life. It is recommended that you clean the air filter periodically. Clean more frequently if you are using the projector in a particularly dusty environment.
- Do not rinse the air filter in water. Do not use detergents or solvents.
- Lightly brush the air filter to clean it. If it is brushed too strongly, dust will be ground into the air filter and cannot be removed.



Dispose of used air filters properly in accordance with your local regulations.
Material: Polypropylene

1 Press the  button on the remote control or the control panel to turn off the power, and then disconnect the power cord.

2 Remove the cable cover if it is attached.  [p.20](#)

3 Open the air filter cover.
Hook your finger into the tab on the air filter cover, and pull it to swing it open.

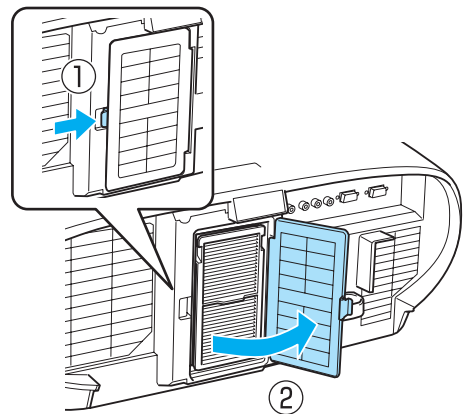

- 4** Remove the air filter.
Grip the knob in the center of the air filter and pull it out at an angle.

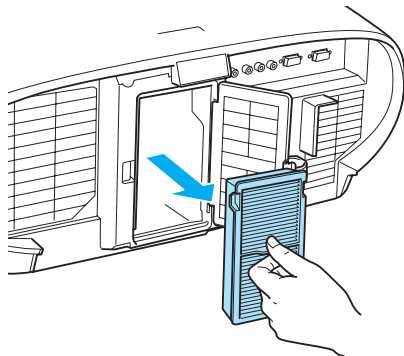

- 5** Hold the air filter with the surface facing down and tap it 4 or 5 times to remove the dust.
Turn it over and tap the other side in the same way.

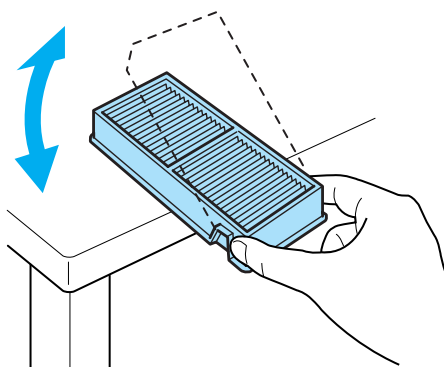



Attention

If the air filter is hit too hard, it may become unusable due to deformities and cracks.

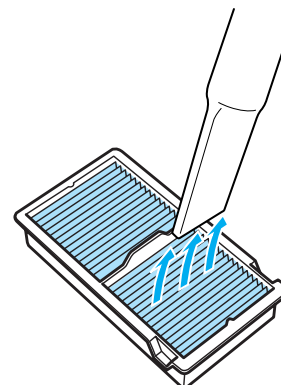
- 6** Remove any dust remaining on the air filter by using a vacuum cleaner from the front side.



 Replace the air filter if a message is displayed even after cleaning the air filter, or if it is still soiled.
 [p.116](#)

- 7** Install the air filter.
Grip the air filter by the knob in the center and insert it at an angle.

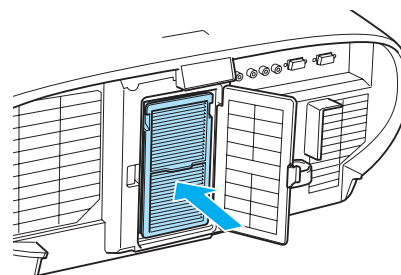

- 8** Close the air filter cover.
Press until the tab on the air filter cover clicks into place.

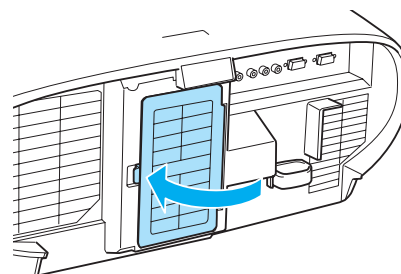

■ Cleaning the main unit

Clean the projector's surface by wiping it gently with a soft cloth.

If it is particularly dirty, moisten the cloth with water containing a small amount of neutral detergent, and then firmly wring the cloth dry before using it to wipe the surface.

Attention

- Do not use volatile substances such as wax, alcohol, or thinner to clean the projector's surface. The quality of the case may change or the paint may peel off.
- Do not touch the projection lens. When cleaning the lens, contact your local dealer or the nearest projector information center. 🗨️ [Epson Projector Contact List](#)

■ Cleaning the 3D Glasses

Clean the lenses of the glasses by wiping them gently with a soft cloth.

Attention

- Do not rub the lenses of the glasses with harsh materials or handle the lenses too roughly as they can easily become damaged.
- When maintenance is necessary, disconnect the USB Charging Adapter from the electrical outlet, and check that all cables have been disconnected.
- The 3D Glasses contain rechargeable batteries. Observe local regulations when you dispose of them.

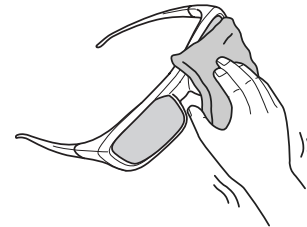



Optional Accessories and Consumables

The following optional accessories/consumables are available for purchase if required. This list of optional accessories/consumables is current as of: 2014.1. Details of accessories are subject to change without notice.

Varies depending on country of purchase.

Optional Items

Name	Model No.	Explanation
RF system 3D Glasses	ELPGS03	Use when viewing 3D images.
USB Charging Adapter	ELPAC01	Use when charging the 3D Glasses.

Consumables

Name	Model No.	Explanation
Air filter	ELPAF39	Use as a replacement for used air filters. (1 air filter)



Supported Resolutions

HDMI1/HDMI2 Input Signals

Signal	Refresh Rate (Hz)	Resolution (dots)
VGA	60	640 x 480
SDTV (480i)	60	720 x 480
SDTV (576i)	50	720 x 576
SDTV (480p)	60	720 x 480
SDTV (576p)	50	720 x 576
HDTV (720p)	50/60	1280 x 720
HDTV (1080i)	50/60	1920 x 1080
HDTV (1080p)	24/30/50/60	1920 x 1080
4K x 2K*	24/25/30/50/60	3840 x 2160
	50/60	4096 x 2160
4K x 2K (SMPTE)*	24	4096 x 2160

* EH-LS10000 only

Component Video

Signal	Refresh Rate (Hz)	Resolution (dots)
SDTV (480i)	60	720 x 480
SDTV (576i)	50	720 x 576
SDTV (480p)	60	720 x 480
SDTV (576p)	50	720 x 576
HDTV (720p)	50/60	1280 x 720
HDTV (1080i)	50/60	1920 x 1080
HDTV (1080p)	50/60	1920 x 1080

Composite Video

Signal	Refresh Rate (Hz)	Resolution (dots)
TV (NTSC)	60	720 x 480
TV (SECAM)	50	720 x 576
TV (PAL)	50/60	720 x 576

Computer Signals (Analog RGB)

Signal	Refresh Rate (Hz)	Resolution (dots)
VGA	60/72/75/85	640 x 480
SVGA	56/60/72/75/85	800 x 600
XGA	60/70/75/85	1024 x 768
SXGA	70/75/85	1152 x 864
	60/75/85	1280 x 960
	60/75/85	1280 x 1024
WXGA	60	1280 x 768
	60	1366 x 768
	60/75/85	1280 x 800
WXGA++	60	1600 x 900

3D Input Signals

Signal	Refresh Rate (Hz)	Resolution (dots)	3D Format		
			Frame Packing	Side by Side	Top and Bottom
HDTV (720p)	50/60	1280 x 720	✓	✓	✓
HDTV (1080i)	50/60	1920 x 1080	-	✓	-
HDTV (1080p)	50/60	1920 x 1080	-	✓	-
HDTV (1080p)	24	1920 x 1080	✓	✓	✓

WirelessHD Input Signals

Signal	Refresh Rate (Hz)	Resolution (dots)
VGA	60	640 x 480
SDTV (480i)	60	720 x 480
SDTV (576i)	50	720 x 576
SDTV (480p)	60	720 x 480
SDTV (576p)	50	720 x 576
HDTV (720p)*	50/60	1280 x 720
HDTV (1080i)	50/60	1920 x 1080
HDTV (1080p)*	24/50/60	1920 x 1080

* When projecting in WirelessHD, the following signals do not support Deep Color.

2D: 1080p 60/50 Hz

3D: 1080p 24 Hz frame packing/720p 50/60 Hz frame packing/1080p 60/50 Hz side by side

MHL Input Signals (via a WirelessHD Transmitter*)

Signal	Refresh Rate (Hz)	Resolution (dots)
SDTV (480i)	60	720 x 480
SDTV (576i)	50	720 x 576
SDTV (480p)	60	720 x 480
SDTV (576p)	50	720 x 576
HDTV (720p)	50/60	1280 x 720
HDTV (1080i)	50/60	1920 x 1080
HDTV (1080p)	24/50/60	1920 x 1080

* HDMI5 port only

3D Input Signals MHL (via a WirelessHD Transmitter*)

Signal	Refresh Rate (Hz)	Resolution (dots)	3D Format		
			Frame Packing	Side by Side	Top and Bottom
HDTV (720p)	50/60	1280 x 720	-	✓	✓
HDTV (1080i)	50/60	1920 x 1080	-	✓	-
HDTV (1080p)	50/60	1920 x 1080	-	-	-
HDTV (1080p)	24	1920 x 1080	-	✓	✓

* HDMI5 port only



Notes on Transportation

There are many glass parts and precision components inside the projector. To prevent damage due to impacts when transporting, handle the projector as follows.

Moving Nearby

Before carefully moving the projector, make sure it has been turned off and all cables have been disconnected.

Attention

- The projector is heavy and should not be carried by only one person. At least two people should carry the projector when unpacking or moving.
- When lifting the projector, make sure you close the control panel.
- Do not apply excessive force to the control panel section. This may cause malfunctions to occur.

When Transporting

■ Preparing packaging

After checking the points in "Moving Nearby", set the vertical and horizontal lens positions to the center, and then pack up the projector.  [p.33](#)

■ Notes when packing and transporting

Enclose the projector securely in buffer material to protect it from shock, and place it into a strong cardboard container. Be sure to notify the carrier company that the contents are fragile.



Specifications

Product name		EH-LS10000	EH-LS9600W
Appearance (not including adjustable foot)		550 (W) x 225 (H) x 553 (D) mm	
Panel size		0.74" wide	
Display method		Polysilicon TFT active matrix	
Resolution		1920 (W) x 1080 (H) x 3	
Focus adjustment		Motorized	
Zoom adjustment		Motorized (approx. 1 to 2.1)	
Light source		Laser diode, 41.9 mW, Repetition rate: 0 - 100%	Laser diode, 33.7 mW, Repetition rate: 0 - 100%
Power supply		100 - 240 V AC \pm 10%, 50/60 Hz, 4.6 - 2.1 A	100 - 240 V AC \pm 10%, 50/60 Hz, 3.5 - 1.6 A
Power consumption	100 to 120 V area	Operating: 459 W	Operating: 345 W
		Standby power consumption: 0.3 W*1 Standby power consumption: 2.8 W*2	Standby power consumption: 0.3 W*1 Standby power consumption: 3.4 W*3
	220 to 240 V area	Operating: 442 W	Operating: 334 W
		Standby power consumption: 0.4 W*1 Standby power consumption: 3.3 W*2	Standby power consumption: 0.4 W*1 Standby power consumption: 3.6 W*3
Operating altitude		Altitude 0 to 3000 m	
Operating temperature		+5 to +35°C (No condensation)	
Storage temperature		-10 to +60°C (No condensation)	
Mass		Approx. 18.0 kg	Approx. 17.0 kg
Connectors		Component port x 1, 3RCA pin jack	
		PC port x 1, Mini D-Sub15-pin (female) blue	
		HDMI port x 2, HDMI For HDCP*4, For CEC signals, Deep Color	
		Video port x 1, RCA pin jack	
		RS-232C port x 1, D-sub 9-pin (male)	
		Trigger out port x 2, 3.5 mm mini jack	
		LAN port x1, RJ-45	
		Mini USB TypeB port x 1	

*1 When the following settings are performed

Settings - Standby Mode - Communication Off  [p.91](#)

*2 When the following settings are performed

Settings - Standby Mode - Communication On  [p.91](#)

*3 When all of the following settings are performed

Settings - HDMI Link - Power On Link - Bidirectional or **Device -> PJ**

Settings - WirelessHD - WirelessHD - On

Settings - Standby Mode - Communication On

p.91

*4 For EH-LS10000, the HDMI1 port supports HDCP 2.2, and the HDMI2 port supports HDCP 1.4. For EH-LS9600W, both ports support HDCP 1.4.

Angle of tilt

If you use the projector tilted at an angle of more than 3°, it could be damaged or cause an accident.

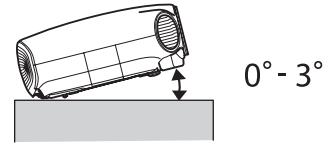

ESC/VP21 commands

Use of ESC/VP21 enables control of the projector from an external device. For more details, see the following Web site.

<http://www.epson.com>

RS-232C cable layouts

- Connector shape: D-sub 9-pin (male)
- Projector input port name: RS-232C
- Signal name:

Signal Name	Function
GND	Signal wire ground
TD	Transmit data
RD	Receive data

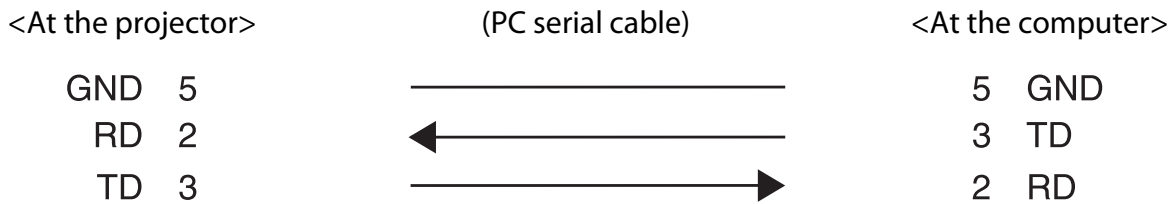

- Communications protocol
 - Default baud rate setting: 9600 bps
 - Data length: 8 bit
 - Parity: None
 - Stop-bit: 1 bit
 - Flow control: None

PJLink

The projector complies with the PJLink Class1 standard established by the JBMIA (Japan Business Machine and Information System Industries Association). From a computer connected to the projector on a network, you can control the projector with PJLink commands.

You need to make network settings before you can use PJLink.  [p.96](#)

With the exception of the following commands, the projector supports all commands defined by PJLink Class1, and agreement was confirmed by the PJLink standard adaptability verification.

Function		PJLink Command
Mute settings	Image muting set	AVMT 11
	Audio muting set	AVMT 12

For more details, see the following Web site.

<http://pjlink.jbmia.or.jp/english/>

Input names defined by PJLink and corresponding projector sources

Source	PJLink Command
HDMI1	INPT 32
HDMI2	INPT 33
WirelessHD*	INPT 34
Component	INPT 24
Video	INPT 21
PC	INPT 11

* EH-LS9600W only

Manufacturer name displayed for "Manufacture name information query"

EPSON

Model name displayed for "Product name information query"

EPSON 10000

EPSON 9600

DECLARATION of CONFORMITY

According to 47CFR, Part 2 and 15

Class B Personal Computers and Peripherals; and/or

CPU Boards and Power Supplies used with Class B Personal Computers

We: Epson America, Inc.
 Located at: 3840 Kilroy Airport Way
 MS: 3-13
 Long Beach, CA 90806
 Tel: 562-981-3840

Declare under sole responsibility that the product identified herein, complies with 47CFR Part 2 and 15 of the FCC rules as a Class B digital device. Each product marketed, is identical to the representative unit tested and found to be compliant with the standards. Records maintained continue to reflect the equipment being produced can be expected to be within the variation accepted, due to quantity production and testing on a statistical basis as required by 47CFR 2.909. Operation is subject to the following two conditions : (1) this device may not cause harmful interference, and (2) this device must accept any interference received, including interference that may cause undesired operation.

Trade Name: EPSON
 Type of Product: LCD Projector
 Model: H488C/H559C

FCC Compliance Statement**For United States Users**

This equipment has been tested and found to comply with the limits for a Class B digital device, pursuant to Part 15 of the FCC Rules. These limits are designed to provide reasonable protection against harmful interference in a residential installation. This equipment generates, uses, and can radiate radio frequency energy and, if not installed and used in accordance with the instructions, may cause harmful interference to radio communications. However, there is no guarantee that interference will not occur in a particular installation. If this equipment does cause harmful interference to radio or television reception, which can be determined by turning the equipment off and on, the user is encouraged to try to correct the interference by one or more of the following measures.

- Reorient or relocate the receiving antenna.
- Increase the separation between the equipment and receiver.
- Connect the equipment into an outlet on a circuit different from that to which the receiver is connected.
- Consult the dealer or an experienced radio/TV technician for help.

WARNING

The connection of a non-shielded equipment interface cable to this equipment will invalidate the FCC Certification or Declaration of this device and may cause interference levels which exceed the limits established by the FCC for this equipment. It is the responsibility of the user to obtain and use a shielded equipment interface cable with this device. If this equipment has more than one interface connector, do not leave cables connected to unused interfaces. Changes or modifications not expressly approved by the manufacturer could void the user's authority to operate the equipment.

This product is also designed for IT power distribution system with phase-to-phase voltage 230V.

Обладнання відповідає вимогам Технічного регламенту обмеження використання деяких небезпечних речовин в електричному та електронному обладнанні.



001

Indication of the manufacturer and the importer in accordance with requirements of directive 2011/65/EU (RoHS)

Manufacturer: SEIKO EPSON CORPORATION

Address: 3-5, Owa 3-chome, Suwa-shi, Nagano-ken 392-8502 Japan

Telephone: 81-266-52-3131

Importer: SEIKO EUROPE B.V.

Address: Azië building, Atlas ArenA, Hoogoorddreef 5, 1101 BA Amsterdam Zuidoost The Netherlands

Telephone: 31-20-314-5000



Appearance

Units: mm

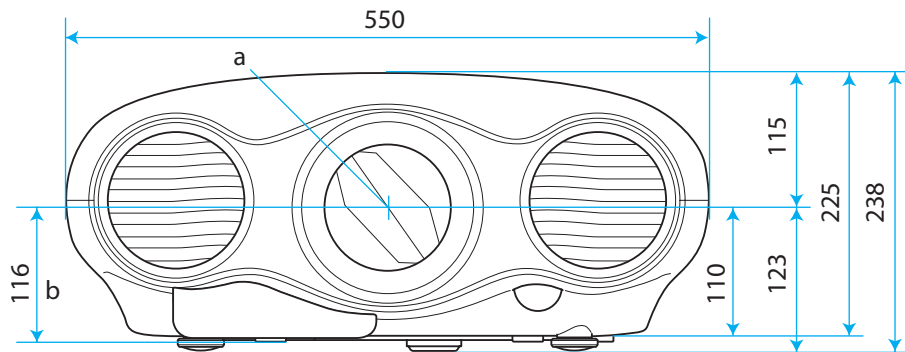

- a Center of lens
- b Distance from center of lens to suspension bracket fixing point
- c Lens direction

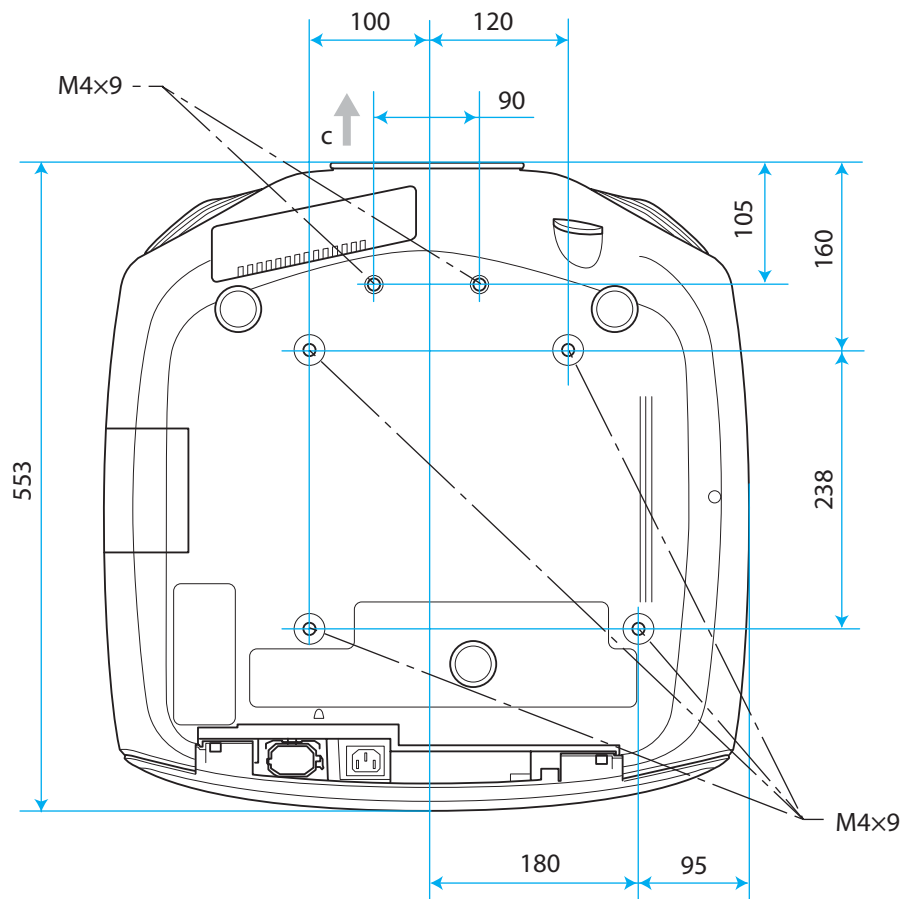



Glossary

This section briefly explains the difficult terms that are not explained in context in the text of this guide. For details, refer to other commercially available publications.

Aspect Ratio	<p>The ratio between an image's length and its height. Screens with a horizontal:vertical ratio of 16:9, such as HDTV screens, are known as wide screens.</p> <p>SDTV and general computer displays have an aspect ratio of 4:3.</p>
HDCP	<p>HDCP is an abbreviation for High-bandwidth Digital Content Protection. It is used to prevent illegal copying and protect copyrights by encrypting digital signals sent over DVI and HDMI ports. Because the HDMI port on this projector supports HDCP, it can project digital images protected by HDCP technology. However, the projector may not be able to project images protected with updated or revised versions of HDCP encryption.</p>
HDMI™	<p>An abbreviation for High Definition Multimedia Interface. This is the standard by which HD images and multichannel audio signals are digitally transmitted.</p> <p>HDMI™ is a standard aimed at digital consumer electronics and computers. By not compressing the digital signal, the image can be transferred at the highest quality possible. It also provides an encryption function for the digital signal.</p>
HDTV	<p>An abbreviation for High-Definition Television. This refers to high-definition systems which satisfy the following conditions.</p> <ul style="list-style-type: none"> • Vertical resolution of 720p or 1080i or greater (p = Progressive, i = Interlace) • Screen aspect of 16:9 Dolby Digital audio reception and playback (or output)
Interlace	<p>Transmits information needed to create one screen by sending every other line, starting from the top of the image and working down to the bottom. Images are more likely to flicker because one frame is displayed every other line.</p>
MHL	<p>An abbreviation for Mobile High-definition Link, which is a standard high-definition interface that enables high-speed transfer of video signals on mobile devices.</p> <p>It is a standard targeting smart devices and tablets that transfers uncompressed digital signals without loss of quality and also enables simultaneous charging of such devices.</p>
NTSC	<p>An abbreviation for the National Television Standards Committee. A terrestrial analog color broadcasting method. This method is used in Japan, North America, and Latin America.</p>
Pairing	<p>Register devices in advance when connecting with Bluetooth devices to ensure mutual communication.</p>
PAL	<p>An abbreviation for Phase Alternation by Line. A terrestrial analog color broadcasting method. This method is used in various Western European countries (with the exception of France), Asian countries such as China, and Africa.</p>
SDTV	<p>An abbreviation for Standard Definition Television. This refers to standard television systems which do not satisfy the conditions for HDTV High-Definition Television.</p>
SECAM	<p>An abbreviation for SEquential Couleur A Memoire. A terrestrial analog color broadcasting method. This method is used in France, Eastern Europe, the former Soviet Union, the Middle East, Africa, and so on.</p>
SVGA	<p>A screen size standard with a resolution of 800 (horizontal) x 600 (vertical) dots.</p>
SXGA	<p>A screen size standard with a resolution of 1,280 (horizontal) x 1,024 (vertical) dots.</p>
VGA	<p>A screen size standard with a resolution of 640 (horizontal) x 480 (vertical) dots.</p>
XGA	<p>A screen size standard with a resolution of 1,024 (horizontal) x 768 (vertical) dots.</p>

YCbCr	In component image signals for SDTV, Y is the brightness, while Cb and Cr indicate the color difference.
YPbPr	In component image signals for HDTV, Y is the brightness, while Pb and Pr indicate the color difference.



General Notes

All rights reserved. No part of this publication may be reproduced, stored in a retrieval system, or transmitted in any form or by any means, electronic, mechanical, photocopying, recording, or otherwise, without the prior written permission of Seiko Epson Corporation. No patent liability is assumed with respect to the use of the information contained herein. Neither is any liability assumed for damages resulting from the use of the information contained herein.

Neither Seiko Epson Corporation nor its affiliates shall be liable to the purchaser of this product or third parties for damages, losses, costs, or expenses incurred by the purchaser or third parties as a result of: accident, misuse, or abuse of this product or unauthorized modifications, repairs, or alterations to this product, or (excluding the U.S.) failure to strictly comply with Seiko Epson Corporation's operating and maintenance instructions.

Seiko Epson Corporation shall not be liable against any damages or problems arising from the use of any options or any consumable products other than those designated as Original Epson Products or Epson Approved Products by Seiko Epson Corporation.

The contents of this guide may be changed or updated without further notice.

Illustrations in this guide and the actual projector may differ.

Restriction of Use

When this product is used for applications requiring high reliability/safety such as transportation devices related to aviation, rail, marine, automotive etc.; disaster prevention devices; various safety devices etc; or functional/precision devices etc, you should use this product only after giving consideration to including fail-safes and redundancies into your design to maintain safety and total system reliability. Because this product was not intended for use in applications requiring extremely high reliability/safety such as aerospace equipment, main communication equipment, nuclear power control equipment, or medical equipment related to direct medical care etc, please make your own judgment on this product's suitability after a full evaluation.

Precautions when a Using Laser Device

This projector is a class 2 laser product that complies with the IEC60825-1 international standard on lasers. If they are not handled correctly, injuries could occur. Note the following points.

Warning

- If an error occurs in the projector, turn off the power immediately, unplug the projector from the outlet, and contact your local dealer or the nearest Epson repair center. Continuing to use it in an error condition may result in an electric shock, fire, or visual impairment.
- Never attempt to disassemble or modify the projector. The projector contains a high-power laser component. This could cause serious injury.
- Do not look into the lens during projection. Also, do not look into the lens using optical devices (such as a magnifying glass or telescope). This could cause visual impairment.
- When turning on the projector at a distance using the remote control, make sure there is no one looking into the lens.
- Do not allow small children to make operations. If children do make operations, they must be accompanied by an adult.
- Do not apply optical devices, such as a magnifying glass or reflector, to the projected image. Continuing to use it in this condition may result in physical harm. It could also cause a fire or an accident.
- Before starting projection, check that there is nothing in the surrounding area that could reflect the projected image.
- When disposing of the projector, do not disassemble it. Dispose in accordance with your local or national laws and regulations.

There is a label affixed to the projector to indicate that it is a Class 2 laser product.

The label contains the following information.

- Invisible laser radiation
- Do not stare into beam or view directly with optical instruments
- Class 2 laser product
- Pulse width

The label is placed in the following location.

EH-LS10000

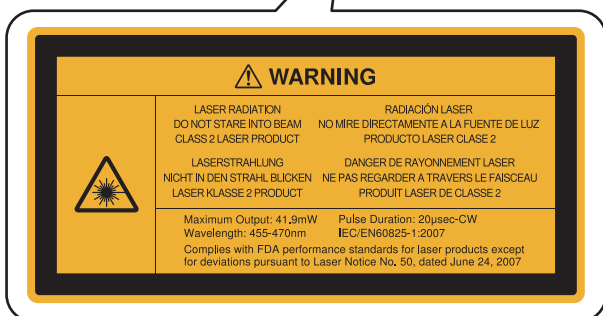
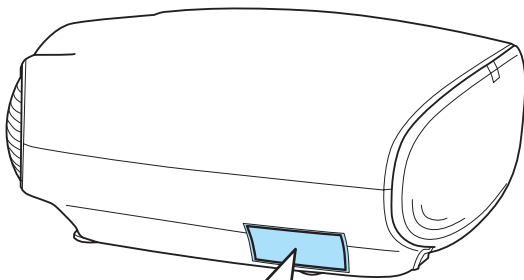

EH-LS9600W

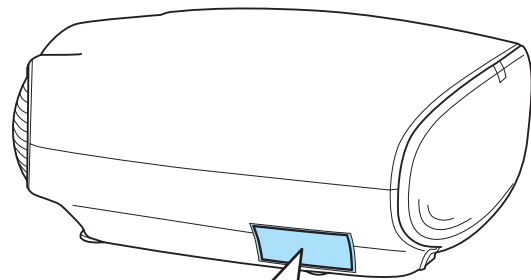

■ Laser optical path

When using the Lens Shift function, the laser light from the projection lens is diffused within the following range.

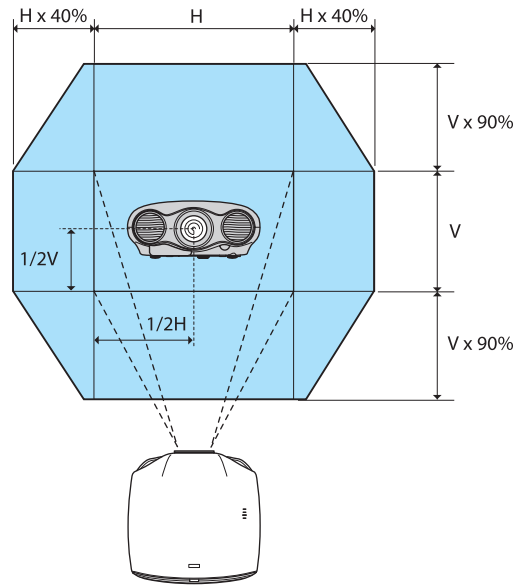

The laser beam is projected at the following angles.

When lens shift is at the maximum vertical position: 32° from the center of the lens

When lens shift is at the maximum horizontal position: 34° from the center of the lens

General Notice

EPSON is a registered trademark, EXCEED YOUR VISION, ELPLP and their logos are registered trademarks or trademarks of Seiko Epson Corporation.

HDMI and High-Definition Multimedia Interface are the trademarks or registered trademarks of HDMI Licensing LLC. **HDMI**
HIGH DEFINITION MULTIMEDIA INTERFACE

WirelessHD, WiHD, and the WiHD logo are trademarks or registered trademarks of WirelessHD LLC.

THX and the THX 3D logo are trademarks of THX Ltd. which may be registered in some jurisdictions. All rights reserved.

Full HD 3D Glasses™ logo and "Full HD 3D Glasses™" word are trademark of Full HD 3D Glasses Initiative™.

Adobe and Adobe RGB are registered trademarks of Adobe Systems Incorporated.

InstaPrevue and the InstaPrevue logo are the trademarks or registered trademarks of Silicon Image, Inc.

Bluetooth® and the Bluetooth logo are the trademarks of Bluetooth SIG, Inc.

MHL and the MHL logo are a trademark, registered trademark or service mark of MHL, LLC in the United States and/or other countries.

All other trademarks are the property of their respective owners and used for identification purpose only.

©SEIKO EPSON CORPORATION 2013. All rights reserved.

- 2**
- 2D-to-3D conversion 88
- 3**
- 3D depth 88
 - 3D display 88
 - 3D format 88, 99
 - 3D Glasses 40
 - 3D Glasses charging port 68
 - 3D images 39
 - 3D settings 88
 - 3D viewing notice 88
- A**
- Address settings 98
 - Adjust focus 32
 - Adjusting RGB 52
 - Adjusting the focus 32
 - Adjusting the tilt 31
 - Advanced 87, 89
 - Air filter 113
 - Air filter cover 113
 - AMX Device Discovery 98
 - Appearance 126
 - Aspect 35, 88
 - Auto setup 89
- B**
- Basic menu 96
 - Bonjour 98
 - Brightness 50, 86, 87
- C**
- Cable clamp 24
 - Cable cover 20
 - CEC standards 60
 - Child lock 92
 - Cleaning the 3D Glasses 115
 - Cleaning the air filter 113
 - Cleaning the main unit 115
 - Color gamut 59, 87
 - Color mode 44, 86
 - Color saturation 86
 - Color temp. 86
 - Complete menu 98
 - Component 94
 - Component ports 21
 - Configuration menu 29, 86
 - Connecting 20
 - Connecting a computer 22
 - Connecting MHL compatible devices 23
 - Connecting smart devices or tablets 23
 - Connecting video devices 21
 - Connecting WirelessHD devices 23
 - Contrast 86
 - Control panel 6, 10
 - Control panel lock 92
- D**
- Deep color 99
 - Deinterlacing 88
 - Detail enhancement 48, 89
 - Device connections 73, 91
 - DHCP 97
 - Diagonal screen size 88
 - Direct power on 93
 - Display background 94
 - Display settings 94
 - Displaying the test pattern 31
 - Dynamic contrast 48
- E**
- EPSON Super White 87
 - Erase lens position 63, 95
 - Erase memory 66, 95
 - Error/warning indicators 101
 - Exit Picture in Picture 100
- F**
- Focus 107
 - Frame interpolation 49, 89
 - Full 35
- G**
- Gain 52, 87
 - Gamma 51, 87
 - Gateway address 97
- H**
- HDMI link 60, 91
 - HDMI port 60
 - HDMI video range 90
 - HDMI1 port 21, 22
 - HDMI2 port 21, 22
 - High altitude mode 93
 - Hue 50, 87
- I**
- Illumination 93
 - Image 44

- Image menu 86
 - Image processing 90
 - Indicators 101
 - Info menu 99
 - Input signal 94, 99
 - Inverse 3D Glasses 88
 - IP address 97
 - IP address display 97
 - IP settings 97
- K**
- Keystone 34, 91
 - Keystone distortion 34
- L**
- LAN port 24
 - Language 94
 - Lens iris 55, 87
 - Lens position function 62
 - Lens shift 33
 - Link indicator 68
 - Load lens position 63, 95
 - Load memory 65, 95
 - Lock setting 92
- M**
- Mail menu 97
 - Mail notification 84, 97
 - Memory function 64
 - Memory menu 95
 - Menu 86
 - Menu color 94
 - Menu position 94
 - Messages 94
 - Motion detection 88
- N**
- Network information 96
 - Network menu 96
 - Noise 107
 - Noise reduction 89
- O**
- Offset 52, 87
 - Operating range 25
 - Operation 93
 - Others menu 98
 - Overscan 90
- P**
- Pairing 41
 - Panel alignment 94
 - Pattern color 94
 - PC port 22
 - Picture in Picture 79, 100
 - PJLink 123
 - PJLink password 96
 - Port number 97
 - Position 88
 - Power consumption 87
 - Power off link 91
 - Power on link 91
 - Power supply 27, 28
 - Projection 92
 - Projection distance 18
 - Projection size 18, 33
 - Projector name 96
- R**
- Reception 73, 91
 - Refresh rate 99
 - Remote control 12, 25
 - Rename lens position 63, 95
 - Rename memory 66, 95
 - Replacing the air filter 113
 - Reset 87, 90, 91, 94, 95
 - Reset all 100
 - Reset lens position 63, 100
 - Reset memory 66, 100
 - Reset menu 98, 100
 - Resolution 99
 - RGB 87
 - RGBCMY 50, 87
- S**
- Saturation 50, 87
 - Save lens position 62, 95
 - Save memory 64, 95
 - Scan mode 99
 - Select color 94
 - Serial number 99
 - Settings menu 91
 - Setup complete menu 96
 - Setup level 89
 - Sharpness 53, 86
 - Signal menu 88
 - Skin tone 86
 - Sleep mode 93
 - SMTP server 97
 - Soft keyboard 98
 - Source 34, 99
 - Specifications 121
 - Standby confirmation 94

Start adjustments	94
Startup screen	94
Status	99
Sub menu	29
Subnet mask	97
Sub-screen	78
Subscreen position	100
Subscreen size	100
Subscreen source	100
Super-resolution	46, 89
Super-resolution/4K	46, 89
Supported resolutions	117
Swap main/sub	100
Sync info	99
Sync.	88
T	
Tint	86
Top menu	29
Tracking	88
Transmission range	74
Trigger out 1	93
Trigger out 2	93
U	
User button	92
V	
Version	99
Video port	21
Video signal	94, 99
Viewing area	42
W	
Web browser	81
Web Control	81
Web Control password	97
Web Remote	82
WiHD indicator	68
WiHD mode	91
Wired LAN menu	97
WirelessHD	67, 91
Z	
Zoom	35
Zoom adjustment	33