

EIKI

OWNER'S MANUAL

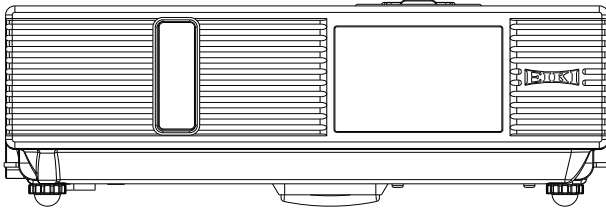

LC-XNB4000N

LC-XNB3500N

LC-WNB3000N

Projector

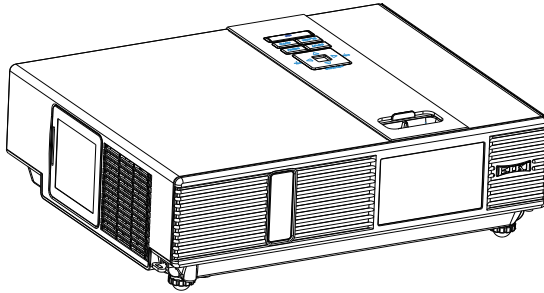

About the Owner's Manual

Please read the owner's manual thoroughly to ensure correct usage of the projector and its features.

After reading, store the owner's manual in a safe place for future reference.

Features

1. Dress up Design
2. Designed for tough environment
3. Side change lamp
4. Side change filter
5. Quick power off
6. Advanced Anti-theft features
7. Five auto features (Auto Search, Auto Sync, Auto Ceiling, Auto Keystone and Auto Filter Alert)
8. Seven display modes (Natural, Cinema, Daylight, Green board, White Board, Black Board and User)
9. Built-in 10W speaker
10. Logo capture
11. Image freeze function
12. Digital zoom adjustment
13. LAN Control
14. LAN Display
15. USB Display
16. PC-less presentation (Photo, Video, Audio and Microsoft Office Viewer)
17. 1.5G bytes free internal storage for multi-media display
18. WiFi Display

The content of this manual is subject to change without previous notice.
All rights reserved.

Contents

About Owner's Manual

Contents	1
Contents of Your Box	3
Safety Instructions	4
Safety Labels	8
Part Names	9
Projector.....	9
Control Panel	10
Rear.....	11
Setting Up	12
Arrangement	12
Power ON / OFF.....	14
Setting Up The Projector	15
Ceiling Mounted Installation Guide	16
Adjusting The Projector's Elevation	17
How To Connect.....	18
Remote Control	20
EZ Suit	22
Main Menu Layout and Function Definition	22
EZ Media	23
Layout and Behavior	23
EZ Display	31
Layout and Behavior	31
Setting and Configuration	47
System setting.....	47
Video setting.....	48
Photo setting	49
Audio setting.....	49
WiFi setting	50
Connect PC setting	58

Contents

Menu Operation	59
How To Operate On-Screen Display	59
MENU (PC Mode)	60
Picture Menu (PC Mode).....	60
Audio Menu (PC Mode).....	61
Setting Menu (PC Mode).....	62
MENU (Video Mode)	63
Picture Menu (Video Mode).....	63
Audio Menu (Video Mode)	64
Setting Menu (Video Mode).....	65
MENU	66
Advanced Menu.....	66
Presentation Menu	70
Security Menu.....	72
PIN Key In Operation.....	76
Network Control Software Application	77
Browser Control	77
Maintenance Of Projector	89
Filter / How to clean or replace the filiters	89
Lamp / Replacing New Lamp.....	90
Additional	90
Troubleshooting	92
Indicator.....	92
Error For Machine Defects	93
List of Supported Monitor Displays	95
Appendix	

Contents of Your Box

Check-list of your accessories

Please make sure that following items are included in the box.
If any items missing, contact your dealer please.

1. Projector

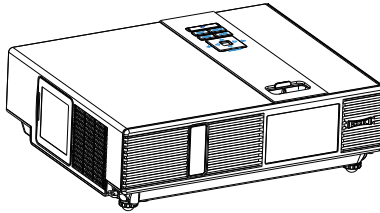

2. Quick Start Guide

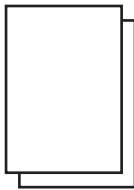

3. Owner's Manual CD

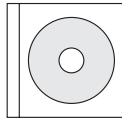

4. Remote control

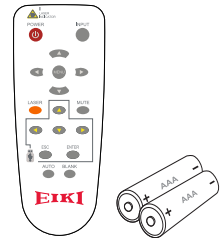

5. Power cord

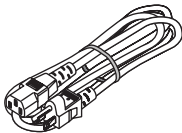

6. Computer cable

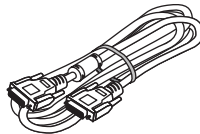

7. Wi-Fi Dongle



Safety Instructions

The projector is designed and tested to meet the latest standards for safety of information technology equipment. However, to ensure safe use of this product, it is important that you follow the instructions mentioned in this manual and marked on the product.



WARNING

This symbol indicates information that, if ignored, could possibly result in personal injury or even death.



CAUTION

This symbol indicates information that, if ignored, could result in personal injury or physical damage.

Typical Symbols



This symbol indicates an additional warning (including cautions). An illustration is provided to clarify the contents (for example: the illustration to the left indicates danger of electrical shock).



This symbol indicates a prohibited action. The contents will be clearly indicated in an illustration or description near the symbol (for example: the symbol to the left indicates that disassembly is prohibited).



This symbol indicates a compulsory action. The contents will be clearly indicated in an illustration or description near the symbol (for example: the symbol to the left shows that the power plug should be disconnected from the power outlet).

Safety Labels



WARNING

If a problem should occur

If smoke or strange odors arise, continued use could result in fire or electrical shock. In such case, immediately turn off the power switch and then disconnect the power plug from the power outlet. After making sure that the smoke or odor has stopped, contact your dealer for repairs. Never attempt to make repairs yourself because this is dangerous.

Do not use this projector if there is no image or sound, or if the sound is distorted. Continued use could result in fire or electrical shock. In such case, immediately turn off the power switch; disconnect the power plug from the power outlet and contact your dealer.

If water would enter the inside of this projector, immediately turn off the power switch, disconnect the power plug from the power outlet and contact your dealer.

Do not install on an unstable surface.

Do not install this projector on an unstable surface such as a wobbly stand or incline because this could result in the projector falling and causing injury.



Do not open the cabinet.

Never open the cabinet. There is high voltage inside which can cause electrical shock. Contact your dealer for internal inspection, adjustment and repair.



Do not modify.

Do not modify this projector because this could result in fire or electrical shock.



Do not place the projector upon either side to project an image.

NO SIDEWARD

Do not use in the bathroom or near water site.

Do not expose this unit to rain or use near water... for example, in the bathroom, a wet basement, near a swimming pool, etc...

Do not insert objects into the Projector.

Do not insert metal objects through the ventilation openings, etc., of this projector or drop such objects inside because this could result in fire or electrical shock.

If a foreign object should enter this projector, immediately turn off the power switch, disconnect the power plug from the power outlet and contact your dealer.

Continued use could result in fire or electrical shock. Use special caution in household and where children are present.

Safety Labels

WARNING

Do not look through the lens when the lamp is on.

Never look through the lens when the lamp is on. The powerful light could adversely affect vision. Use special caution in households where children are present.



Avoid shock or impact on the projector.

If the projector should fall, resulting in damage to the cabinet, immediately turn off the power switch, disconnect the power plug from the power outlet and contact your dealer.



Continued use could result in fire or electrical shock.

Do not place this projector in a container containing liquid. Do not place flower vases, flowerpots, cups, cosmetics, liquids such as water, etc., on top of this projector.

Do not use any power cable except those supplied with the projector.

The use of any other power cable could result in fire or electrical shock.

Do not shine the laser beam onto yourself or other.

The laser pointer function of projector remote control emits class II laser beam.

Do not look directly into the laser beam outlet or direct the laser beam at other people.

Vision can be impaired if the laser beam enters the eyes. Especially pay attention if children are present.

High temperatures are generated when the lamp is lit; so do not place objects in front of the lens.

Allowing the proper amount of space on the top, sides, and rear of the projector cabinet is critical for proper air circulation and cooling of the unit.

The dimension shown here indicate the minimum space required. If the projector is to be built into a compartment or similarly enclosed, these minimum distances must be maintained.

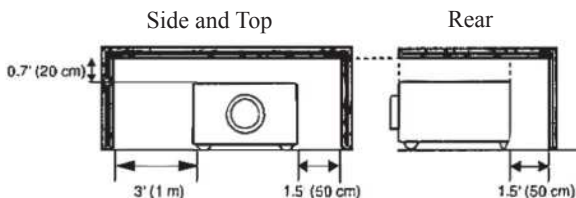

Safety Labels



CAUTION

Placing heavy objects on top of this projector could result in loss of balance or falling and cause personal injury or damage the projector.



Do not block the ventilation openings of this projector.

Blocking ventilation could lead to internal overheating which could result in fire.

Do not place this projector on its side during use or push it into a small, poorly ventilated location.

Do not place this projector on a carpet or bedding or cover it with a tablecloth, etc.

Care and maintenance.

For safety purposes, disconnect the power plug from the power outlet before starting the care and maintenance of this projector.



Battery usage.

Replace the batteries with the same type only.

Do not mix old and new batteries; this could result in fire or personal injury due to battery cracking or leakage.

Make sure the plus and minus terminals are correctly aligned when loading the batteries.

Incorrect loading could result in personal injury or contamination of the surroundings due to battery cracking or leakage.



Have the projector interior cleaned regularly.

Contact your dealer to arrange for the service.

Accumulations of dust inside the projector can result in fire or malfunction if not cleaned for an extended period.

Ask your dealer for details about internal cleaning.

Safety Labels

Safety labels are used on or within the projector to alert you to items or areas requiring your attention.

WARNING LABEL

<p>WARNING ⚠</p> <p>BEFORE OPERATING, PLEASE READ USER'S MANUAL. BEFORE REMOVING SCREWS, DISCONNECT POWER CABLE. DO NOT BLOCK VENTING OPENINGS.</p>	<p>WARNUNG ⚠</p> <p>VOR DEM EINSATZ DIE BEDIENUNGSANLEITUNG LESEN. VOR DEM ENTFERNEN DER SCHRAUBEN DAS NETZKABEL ABTRENNEN. LUFTUNGSÖFFNUNGEN NICHT BLOCKIEREN.</p>	<p>AVIS ⚠</p> <p>VEUILLEZ LIRE LE MODE D'EMPLOI AVANT L'USAGE. DÉBRANCHER LE CÂBLE D'ALIMENTATION AVANT DE RETIRER LES VIS. NE BOCHEZ PAS LES ORIFICES DE VENTILATION.</p>
<p>警告 ⚠</p> <p>ご使用になる前に、取扱説明書をお読みください。運気孔をふさがないでください。ファン取除きを行う前に、必ず電源プラグをコンセントから抜いてください。</p>	<p>警告 ⚠</p> <p>使用前 取扱説明書を使用説明書。 取除螺丝前 请务必先解除电源插头。 请勿堵塞通风口 以免内部温度升高导致故障或火灾。</p>	<p>警告 ⚠</p> <p>使用前 请仔细阅读使用说明书。 解除螺丝前 请务必先解除电源插头。 请勿堵塞通风口 以免内部温度升高导致故障或火灾。</p>

(USA ONLY) This product contains mercury. Disposal of mercury may be regulated due to environmental considerations. For disposal or recycling information, please contact your local authorities or the Electronic Industries Alliance: www.eia.org.

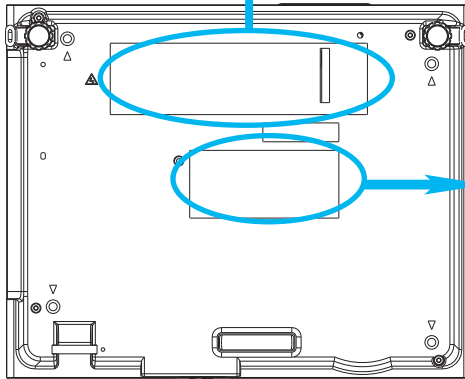

EMI LABEL

LCD Projector

Model:
 INPUT: AC 100-240V 50/60Hz 3.6-1.2A
 Serial No.:

XXXXXXXXXXXXXXXX

CE, FCC, UL LISTED E227061, and other certification logos.

LAMP DOOR WARNING LABEL

<p>CAUTION HOT</p> <p>TURN THE POWER OFF AND WAIT 1 HOUR BEFORE CHANGING THE LAMP. WARNING HEISS! SCHALTEN SIE DAS GERÄT AUS UND WARTEN SIE 1 STUNDE, BIS SIE DIE LAMPE WECHSELN.</p>	<p>ATTENTION CHAUD</p> <p>COUPER L'ALIMENTATION ET ATTENDRE 1 HEURE AVANT DE CHANGER LA LAMPE. 高温注意 ランプ交換は、電源を切った後、1時間待ってから行ってください。 天閉投影机電源后、必须冷却至少1小时后才进行更换灯泡。</p>
<p>CAUTION</p> <p>HIGH-PRESSURE LAMP MAY EXPLODE IF IMPROPERLY HANDLED. REPLACE WITH SAME TYPE NUMBER LAMP. DO NOT CLEAN THE AIR FILTER WITH WATER OR ANY LIQUID. DO NOT OPERATE THE PROJECTOR WITHOUT THE AIR FILTER. VORSICHT! DIE HOCHDRUCKLAMPE KANN BEI FALSCHER HANDHABUNG EXPLODIEREN. NUR MIT EINER LAMPE DES GLEICHEN TYPES AUSTAUSCHEN. VERWENDEN SIE ZUR REINIGUNG DES LUFTFILTERS WEDER WASSER NOCH ANDERE FLÜSSIGKEITEN. BETRIEBEN SIE IHREN PROJEKTOR NICHT OHNE DEN LUFTFILTERS.</p>	<p>ATTENTION</p> <p>LA LAMPE À HAUTE PRESSION PEUT EXPLOSER SI ELLE EST MANIPULÉE INCORRECTEMENT. REPLACER PAR UNE LAMPE AVEC UN NUMERO DE TYPE IDENTIQUE. N'UTILISEZ PAS D'EAU NI UN AUTRE LIQUIDE POUR NETTOYER LE FILTRE À AIR. NE FAITES PAS FONCTIONNER VOTRE PROJECTEUR SANS LE FILTRE À AIR. 注意 ランプは、同じタイプのものと交換してください。開った取り扱いはしときに、高圧ランプが破裂する恐れがあります。 水や油などで洗わないでください。フィルタをはずした状態で電源を入れないでください。 如果不正当处理灯泡也许会导致爆裂。请使用同类型的灯泡。 请不要用水或油清洗滤网。 没有装置滤网，请勿操作投影机。</p>

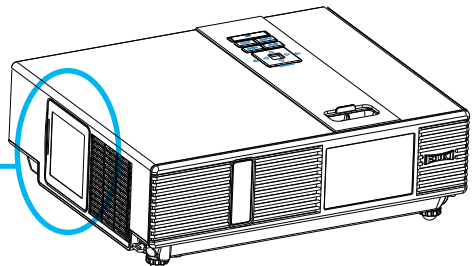

Projector

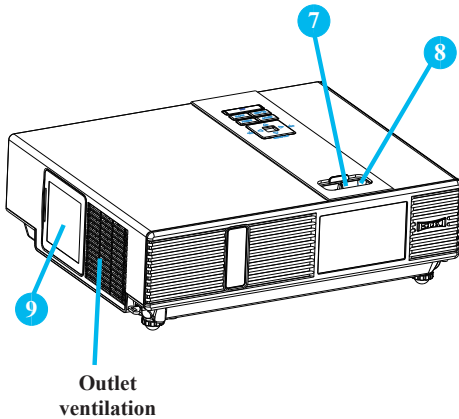
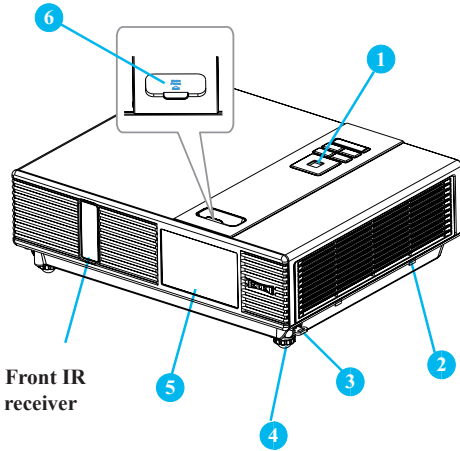

1 Control panel

Operating system.

2 Filter cover

Prevents dust and other foreign particles from being drawn into projector.

Remove the filter cover to clean the air filter.

3 Foot adjust button

Lock / unlock the adjustable foot.

4 Front adjustable foot

Extend and retract to adjust the projection angle.

5 Anti-dust glass

Dustproof function.

6 Gate Plate

Dustproof function.

7 Zoom ring

Use the zoom ring to adjust the size of the projected image.

Rotate the zoom ring until the image is the desired size.

8 Focus ring

Use the focus ring to focus the projector image.

Rotate the focus ring until the image is clear.

9 Lamp door

The lamp unit is inside.

Control Panel

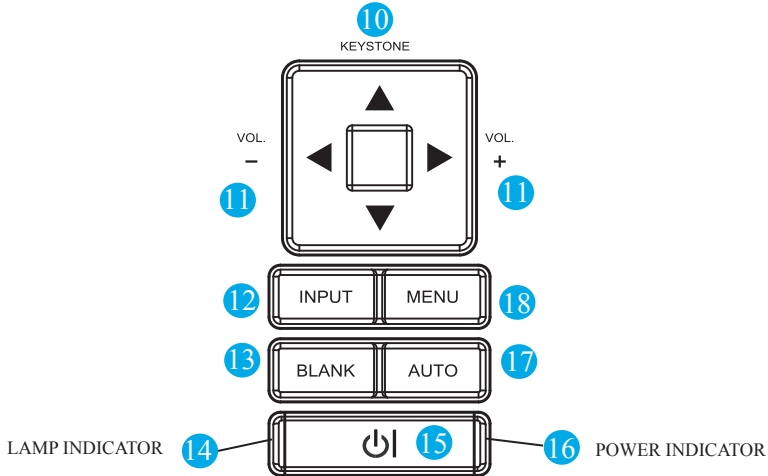

10 KEystone

Adjust the vertical keystone.

11 VOLUME + / -

Sound louder or lower.

12 INPUT

Select input source:



Note :

If the projector can not be captured the signals within 15 minutes, it will be shut down automatically.

13 BLANK

Blank the projected image. The time of Blank mode can be set in 15 minutes, 30 minutes or 60 minutes. The projector will shut down automatically after passing each set time.

14 LAMP INDICATOR

Indicates a status in the internal projector temperature, lamp door properly closed or cooling down.

15 (POWER)

Power On / Off.

16 POWER INDICATOR

Light on or flash to indicate the operating status of the projector.

17 AUTO

Automatically adjust the setting to match the current input.

18 MENU

Display or hide the OSD main menu.

Rear

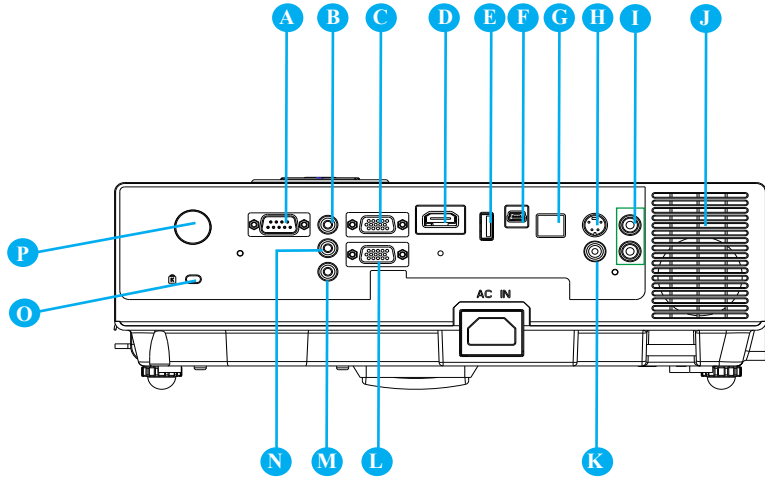

- A RS-232C**
Serial data port for controlling the projector with a computer or other RS-232 control device.
- B AUDIO IN 1 & N AUDIO IN 2**
Mini jack port corresponds to computer input. (RGB IN 1→AUDIO IN 1, RGB IN 2→AUDIO IN 2)
- C RGB IN 1**
Input analog RGB signal from a computer.
- D HDMI**
Input digital HDMI signal from a Computer & Video source.
- E USB Port (USB-A Type)**
1.Supports USB Storage Device and USB compatible hard disks.
2.Supports wireless (WiFi) USB dongle for wirelessly projecting the computer's image.
- F USB Display Port (Mini-USB Type)**
Support USB mini-B Connects from the computer's USB Port by using the USB mini-B type to A type cable. It also can access the internal memory from projector to perform the data.
- G LAN**
Please see page77 Network Control Application for details.
- H S-VIDEO**
Input the S-Video signal from a video source.
- I AUDIO IN 3, R / L**
RCA type corresponds to video input.
- J SPEAKER**
- K VIDEO**
To composite the video signal from a video source.
- L RGB IN 2/OUT**
Input analog RGB signal from a computer or connect an external monitor to this connection to view the "RGB IN" input. Please see P.67 for the setting.
- M AUDIO OUT**
This jack outputs the audio signal from computer& audio signal to external audio equipment.
- O Slot for Kensington Micro SaverSecurity System**
Built-in Security Slot.
This security slot supports the Micro Saver® Security System. Micro Saver® is a registered trademark of Kensington Microware Inc. The logo is trademarked and owned by Kensington Microware Inc.
- P REAR IR RECEIVER**

Setting Up

Arrangement

1. Before installation, make sure that the projector is turned off and the power cord is disconnected.
2. Do not set up and move the projector, while it is hot.
3. The distance between the projector and screen determines the actual image size. Refer to the table below to determine the screen size at a given distance.

Note: The dimensions in the table below are approximate.

LC-XNB4000N / LC-XNB3500N (4:3)

Screen size (diagonal)		Distance (m)		Distance (feet)	
inch	m	Tele	Wide	Tele	Wide
40	1.0	1.36	1.10	4.47	3.62
60	1.5	2.07	1.69	6.78	5.54
70	1.8	2.42	1.98	7.93	6.51
80	2.0	2.77	2.28	9.09	7.47
100	2.5	3.48	2.87	11.40	9.40
150	3.8	5.24	4.33	17.18	14.21
200	5.1	7.00	5.80	22.96	19.03
250	6.4	8.76	7.27	28.74	23.84
300	7.6	10.52	8.74	34.52	28.66

Distance(M) *Offset = a:b = 5:1

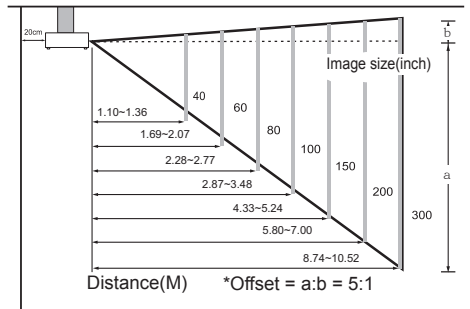
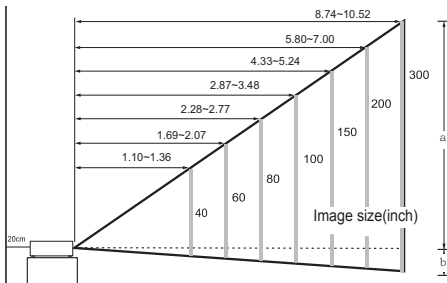

When in against at wall, leave about 20cm (7.9in.) between the projector and the wall.

Setting Up

LC-WNB3000 (16:10)

Screen size (diagonal)		Distance (m)		Distance (feet)	
inch	m	Tele	Wide	Tele	Wide
40	1.0	1.46	1.18	4.78	3.88
60	1.5	2.21	1.81	7.25	5.94
70	1.8	2.59	2.12	8.48	6.96
80	2.0	2.96	2.44	9.72	7.99
100	2.5	3.71	3.06	12.18	10.05
150	3.8	5.60	4.63	18.36	15.19
200	5.1	7.48	6.20	24.53	20.33
250	6.4	9.36	7.77	30.70	25.48
300	7.6	11.24	9.34	36.87	30.62

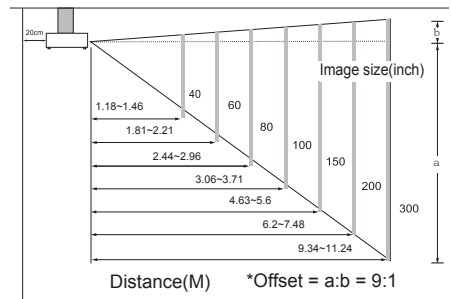
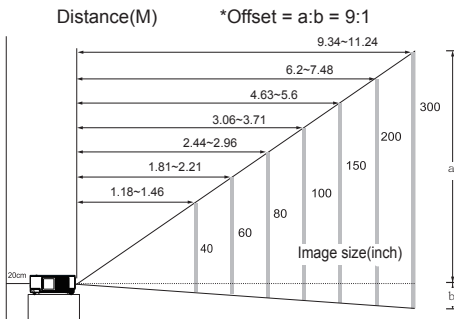

When in against at wall, leave about 20cm (7.9in.) between the projector and the wall.

Setting Up

Power ON / OFF

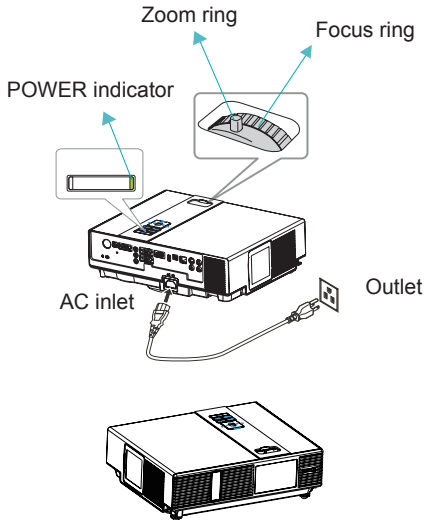

Turning On The Power

1. Make sure that power cord is firmly and correctly connected to the projector.
2. The green Power indicator blinks slowly.
3. Remove the lens cover.
4. Press POWER button on the control panel or the remote control to turn on the projector.
5. Rotate the zoom ring to adjust the screen size.
6. Rotate the focus ring to adjust the focus.

WARNING

- ★ A strong light is emitted when the projector's power is on. Do not look into the lens of the projector or look inside of the projector through any of the projector's openings.

1.



2.



3.~4.

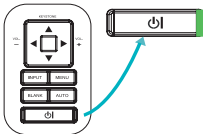

5.

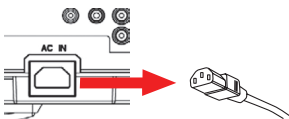

Turning Off The Power

1. Press the POWER button on the control panel or the remote control. The "power off" confirmation message will appear.
2. Press the POWER button again while the message is shown on the screen.
3. When the projector enters "Standby" mode, the green Power indicator blinks slowly.
4. The projector cannot be turned on while red "Lamp indicator" is blinking slowly in cooling mode.
5. If you don't use the projector for a long time, remove power cord.

WARNING

- ★ Do not touch around the lamp cover and the exhaust vents during use or just after use, since it is too hot.

CAUTION

- ★ Do not turn off the AC power for 120 seconds after the lamp is turned on. Doing so could cause premature lamp failure.

Setting Up

Setting Up The Projector

The projector supports the following four different projection methods.

1. Front projection

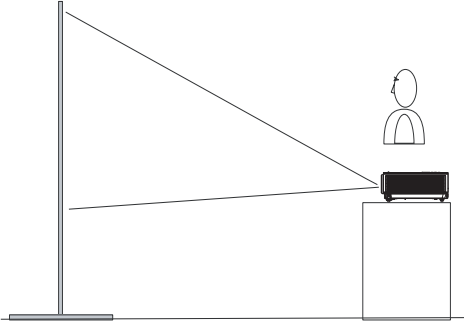

3. Rear ceiling projection

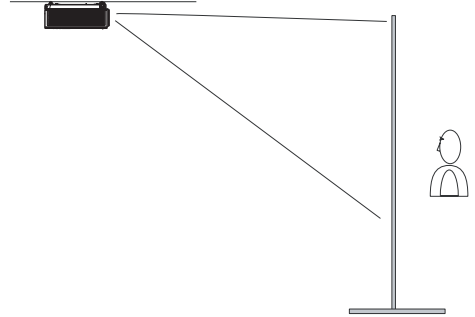

2. Rear projection

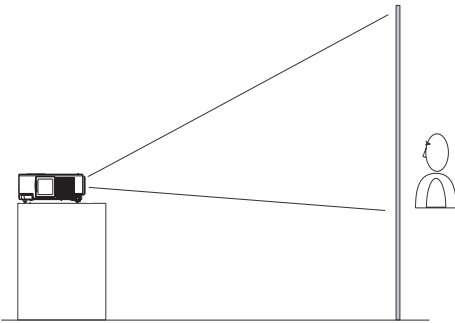

4. Front ceiling projection

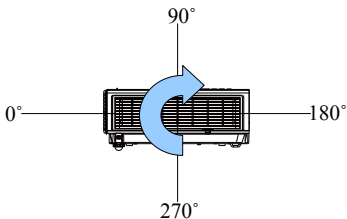
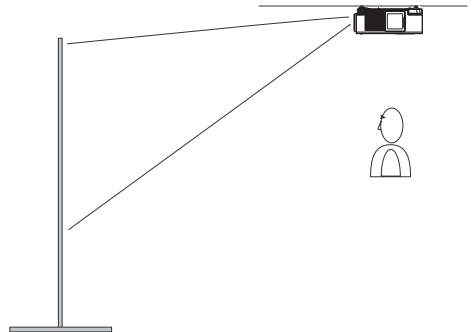

The projector can be installed pitched by any angle (360 degree) without any setting in fan mode. As for rolling it must be within 10 degree.

Special installation is required in order to suspend the projector from the ceiling. Please ask your dealer for details.

Ceiling Mounted Installation Guide

Attach ceiling mount at four-suspension bracket fixing points when suspending from a ceiling. Special installation is required in order to suspend the projector from the ceiling. Please ask your dealer for details.

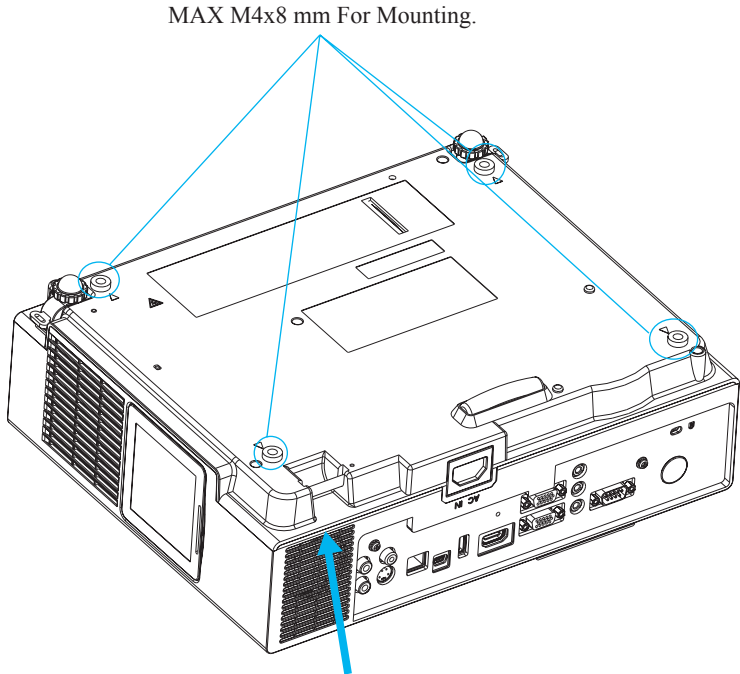

Security Anchor

The product is equipped with security anchor and PIN LOCK functions to help prevent unauthorized removal projector.

WARNING

- ▶ Do not grasp the security anchor to carry projector, since it is not designed for it.
- ▶ The security anchor is not for comprehensive theft prevention measures. It is intended to be used as supplemental theft prevention measure.

Adjusting The Projector's Elevation

Use the adjustable foot at the front of the projector to set the image height.

- 1 Holding the projector, push the foot adjust buttons to loosen the front adjustable foot.
- 2 Position the front side of the projector to the desired height.
- 3 Release the foot adjust buttons in order to lock the front adjustable feet.
- 4 Please make sure that the front adjustable feet are locked.
- 5 Please rotate the adjustable feet when fine adjustment of tilt is needed.

CAUTION

- * The adjustment range of front adjustable foot is 0 to 8.5 degrees.
- * When the foot is adjusted, it may cause the shape of the projected image to become distorted. Use the keystone correction function to correct this distortion.

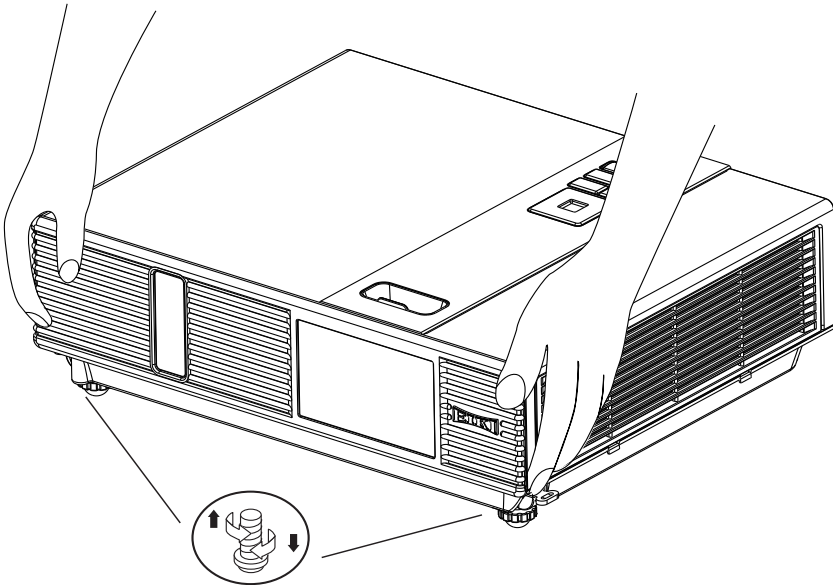

Setting Up

How To Connect

Laptop or desktop computer

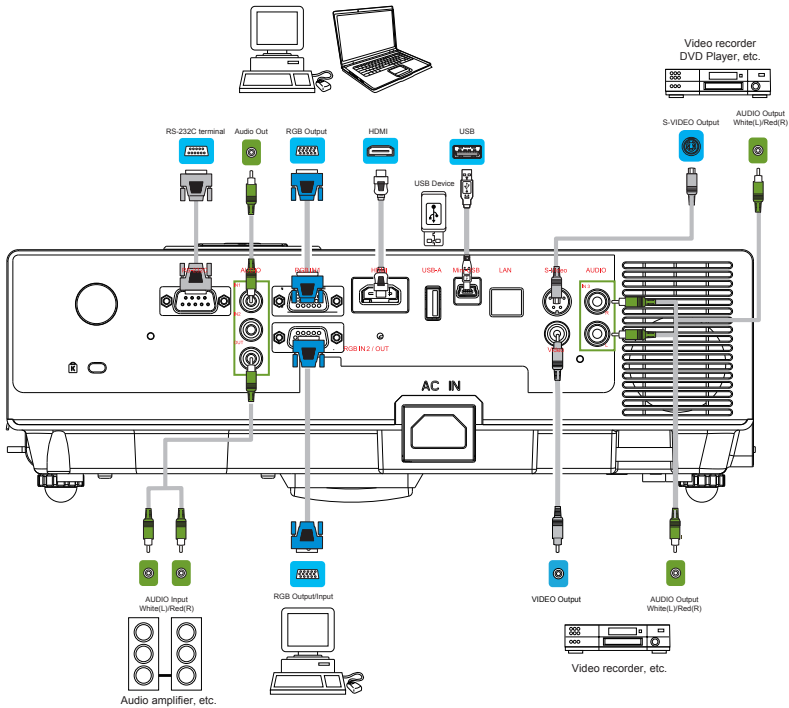

Before starting, make sure that the projector and computer are both turned off.

Connect the computer

Connect the computer cable from the computer to the projector's RGB IN.

Connect a computer cable from the MONITOR OUT to an external monitor to view the signal on RGB IN. Tighten the screw on all connectors.

Connect the audio

1. Please connect the audio cable to the AUDIO IN 1 if the computer cable connected to the projector's RGB IN.
2. Please connect the audio cable to the AUDIO IN 2 if the computer cable connected to the projector's RGB IN 2.
3. Please connect the audio cable to the AUDIO IN 3 if the video cables are connected to the VIDEO / S-VIDEO port of the projector.

Setting Up

- If the selected video image is not displayed after the projector is turned on and the correct video source has been selected, please check that the video source device is turned on and operating correctly. Also check that the signal cables have been connected correctly.
- Many laptops do not turn on their external video ports when connected to a projector. Usually a key combination like Fn + F3 or CRT/LCD key turns the external display on / off. Locate a function key labeled CRT/LCD or a function key with a monitor symbol on the laptop. Press Fn and the labeled function key simultaneously. Refer to your laptop's documentation to discover your laptop's key combination.

Remote Control Batteries Installation

1. Remove the battery cover.
2. Load the batteries.
Make sure the poles are correctly oriented.
3. Close the battery cover.

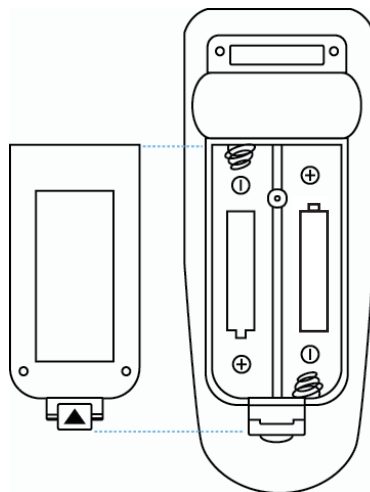

Caution

- Avoid excessive heat and humidity.
- Do not drop the remote control.
- If the remote control will not be used for an extended period, remove the batteries.
- Do not expose the remote control to water or moisture. This could result in malfunction.
- Replace the battery when remote control operation becomes sluggish or unresponsive.
- Do not place the remote control close to the cooling fan of the projector.
- Do not use batteries of different types at the same time.
- Do not mix a new battery with used one. Make sure the plus and terminals are correctly aligned when loading batteries.
- Dispose of batteries in accordance with environmental laws.
- Do not disassemble the remote control. If the remote control needs service, please contact your dealer.
- The batteries (battery pack or batteries installed) shall not be exposed to excessive heat such as sunshine, fire or the like.

Remote Control

POWER

Power on / operation mode, Standby mode, Cool down mode.

INPUT

Select input source :



MENU

Display or hide the On-Screen Display main menu page.



Press or to select On-Screen Display menu item.



Press or to select and adjust the function of On-Screen Display menu item or value.

LASER

Aim the remote control at the screen, press and hold button to activate the laser pointer.

MUTE

Mute audio.

ARROW Key



Press / / / to select the EZ Suite On-Screen Display menu item.

ESC

Escape current status.(to set the EZ Suite On-Screen Display menu item.)

ENTER

Select current status.(to set the EZ Suite On-Screen Display menu item.)

AUTO

Refresh the current image.

BLANK

Hide the current image, become black color on the screen.

Quick Key

If it is not in the On-Screen Display main menu, you could press the button as the quick key.



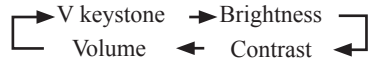



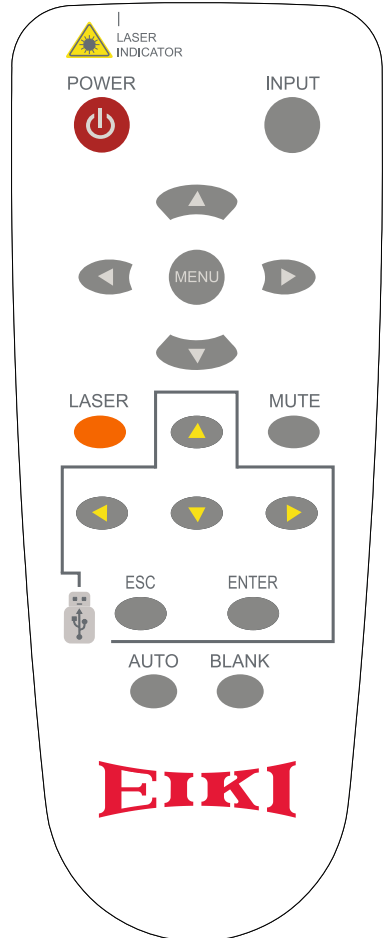





Press or to select the item.



Press or to adjust the value







Main Menu Layout & Function Definition

	Main-items	Function Definition	Sub-Function Definition	Description		
EZ Suite	 EZ Media EZ Media Function	 Internal Memory	Photo	Support Internal memory, USB compatible hard disks, Office viewer		
			Video			
			Audio			
			Office viewer			
		 USB	 EZ Display EZ Display Function	 EZ USB	 EZ WiFi	Support USB Display/ WiFi Display/ LAN Display
	 EZ LAN					
	 Video			Language		
				 Photo	Update	
	 Audio	Display Ratio				
 WiFi		Repeat Mode				
	 Connect PC	Display Ratio				
		Slideshow				
	Slideshow Duration					
	Repeat Mode					
	AP mode					
	Client mode					
	Connect PC					

EZ Suite(EZ Media Function)

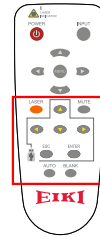

Before to use :

1. Use the , ,  or  buttons on the remote control to select an item.
2. Use the ENTER button on the remote control to enter item.
3. Use the ESC button on the remote control to exit items.



1. EZ Media Function: Layout & Behavior

Support Internal memory and USB-disk device (Support Photo, Video, Music, office viewer)

 EZ Media EZ Media Function	 Internal Memory  USB	Photo
		Video
		Audio
		Office viewer

► Note :

1. Internal Memory :

Internal memory, supports the memory size is 1.5GB.

2. USB :

Support USB Storage Device Type :

USB Flash Device (~64 GB), USB compatible hard disks.

Support FAT16, FAT32, NTFS File system.

3. Limitation (each type of storage) :

Support Max. to 999 directories and Max. to 9,999 Files





Support at most 10th level directory

4. Even if the inserted USB Storage Device or used Internal memory contains a mix of audio music, video, and photo files, you can only browse and playback one type of file at a time. For example, if you enter the Audio music folder, only audio music files can be browsed, added to playlist and played back. To browse photo files, go back to the EZ Media screen and select Photo.

1.1 Photo Function



It will show the file name / thumbnails display / file number progress bar

1. From the Photo layout. Press the  ,  ,  or  buttons on the remote control to select the file.
2. While the highlighted photo file is selected, press the ENTER button on the remote control, the screen will display the selected file, and it will enter the Browse mode.
3. Browse mode :



EZ Suite(EZ Media Function)

Photo navigator toolbar :



Press the , buttons on the remote control, to highlight control icon and press the ENTER button on the remote control to select.

Rotation : To rotate an image.

Using the or buttons on the remote control to rotate the image.

It will resume the image when press the ESC button on the remote control to exit shown image.

Zoom in : To magnify a photo.

Press the ENTER button again to expend the image. It supports x1,x2,x3 and x4 magnification.

During enlarged projection, use the , , or buttons on the remote control to move the image area.

It will resume the image when press ESC on the remote control to exit shown image.

Previous : Play previous photo.

Next : Play next one photo.

Slide Show On/Off : Turn On/Off the slide show function.

*The Slide show will operated after the toolbar hidden.

*There have turn on the Slide show function at the "Photo Setting" menu see page49 for more information.

Delete : To delete the photo file.

Copy : To copy the current display photo file, it will save the photo to internal memory.

Info : Showing the information of the current display photo file.

Quit : To quit browse mode and return to sub-menu.

4. To return to the sub- menu, press the ESC button on the remote control.

► Note :

1. Support *.jpg, *.jpeg, *.bmp file format.
2. Support files sorting by file name.
3. An on-screen image presented on slides automatically, when the setting of Photo Slide show is enable.

*For more information,please check the page49 for "Photo Setting"

1.2 Video Function

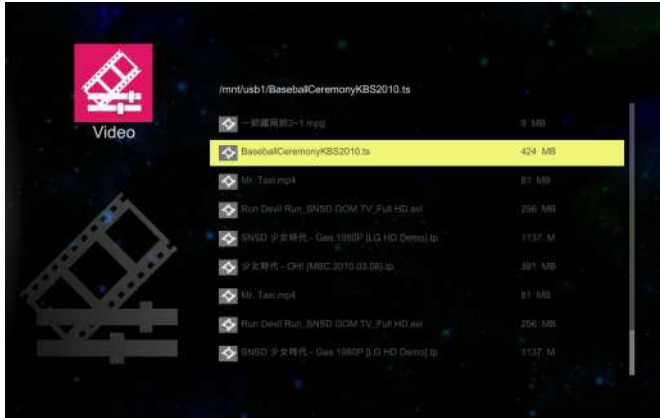

It will show the file name/ file list /file size/ file number progress bar

1. From the Video layout. Press the or buttons on the remote control, to highlight the file of video playlist and press the ENTER button on the remote control to display.
2. Press the ENTER button and a pop-up video navigator toolbar will displayed when the video is performed.

Video navigator toolbar :

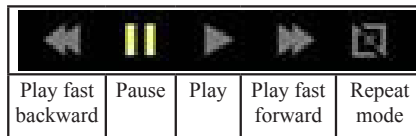

Play fast backward : To play fast backward by press the button.

Support x1, x2, x4 and x8 speeds.

Pause / Play : To pause or play the video by press the ENTER button.

Play fast forward : To play fast forward by press the button.

Support x1, x2, x4 and x8 speeds.

Repeat mode : Show the status of repeat mode.



Single display mode



Sequence repeat display mode

EZ Suite(EZ Media Function)

▶ While video navigator toolbar is disappeared, press the ◀ or ▶ on the remote control to play previous/next video file.

▶ **Note :**

1. Support MPEG1/2/4, H264, WMV, RMVB video format, up to 1080P(20Mbps) resolution. Please refer the multimedia support list document
 2. Support files sorting by file name
 3. Video play : Support original size and full screen size display
- *Fore more information, please check the page48 for Video Setting.

1.3 Audio Function

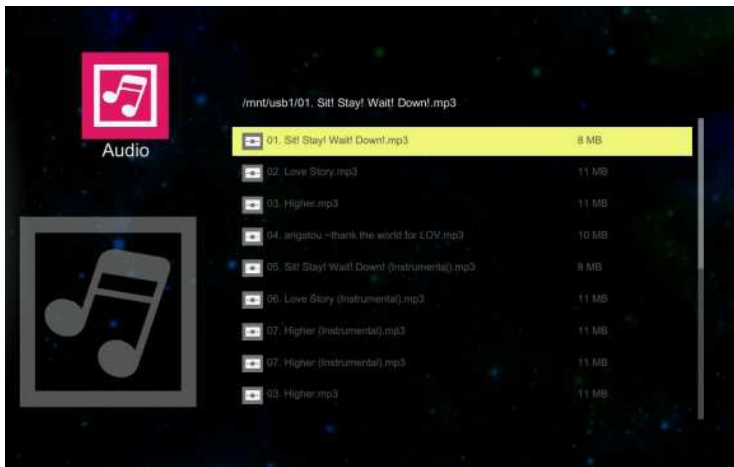

It will show the file name/ file list /file size/ file number progress bar.

EZ Suite(EZ Media Function)

- From the Audio layout. Press the  or  buttons on the remote control to highlight the file of audio playlist and press ENTER button to perform.

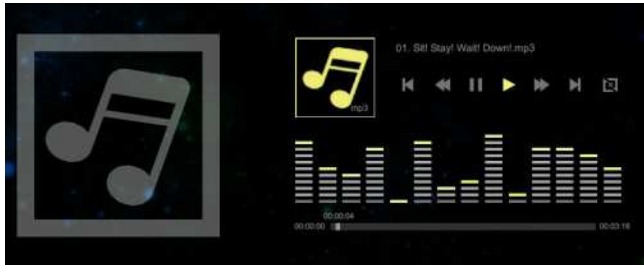

Audio navigator toolbar :

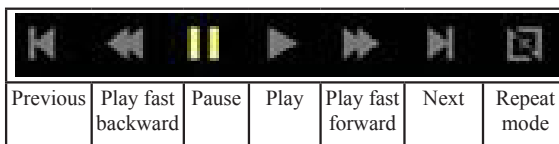

Previous : Play previous audio music file by press the  button twice.

Play fast backward : To play fast backward by press the  button.

Pause / Play : To pause or play the video by press the ENTER button.

Play fast forward : To play fast forward by press the  button twice.

Next : Play next audio music file by press the  button.

Repeat mode : Show the status of repeat mode.





Single display mode



Sequence repeat display mode

EZ Suite(EZ Media Function)

	Sound Spectrum
	Show the total time and indicate current playing time

► Note :

1. Support mp3, wma, ogg, and wav audio file format
2. Support file sorting by file name and modification date same as photo function

*For more information, please check the page49 for Audio Setting.

1.4 Office Viewer Function

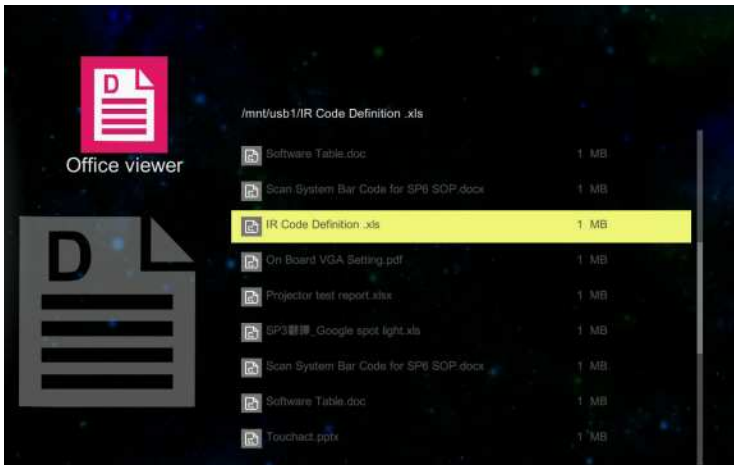

1. Select and enter a document file that you want to browse. It will show the translucent operating menu around 5 seconds on the screen.
2. The document displays on the screen.
Press **(EXIT)** button will show the translucent Tool bar on the screen. It will help you to browse the document.

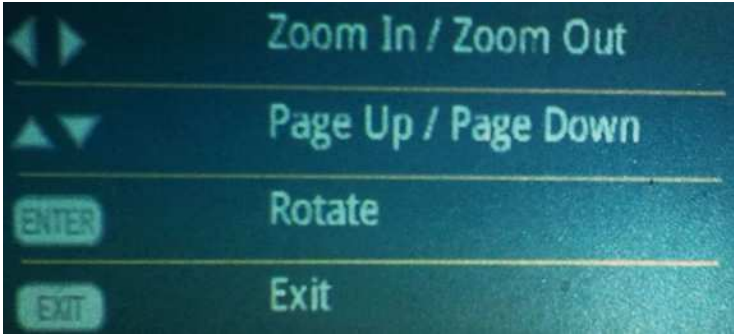

Operation info :

◀▶ Zoom In / Zoom out	Crops the image, and magnifies or reduces the result of the cropping.
▲▼Page up/Page down	These two buttons are used to go to the previous page or the next page in documents.
(ENTER) Rotate	Press "Enter" button for movement of document around a center of rotation.
(EXIT) Exit	Press "ESC" button to exit browse document.

► Note:

1. Embedded Pictel Office Viewer
2. Support Office 2010 (Word, Excel, PowerPoint), Adobe PDF & Plain text (TXT) format





Operation info :

▲▼◀▶Navigator	Use up/down/left/right keys.
(ENTER) Display mode	Press the ENTER button to set display mode.
(EXIT) Tool bar	Press the ESC button to show tool menu bar.

EZ Suite(EZ Display Function)

2. EZ Display Function: Layout & Behavior

Support USB Display, WiFi Display, LAN Display.

	EZ Display	 EZ USB
EZ Display Function	 EZ WiFi	
	 EZ LAN	

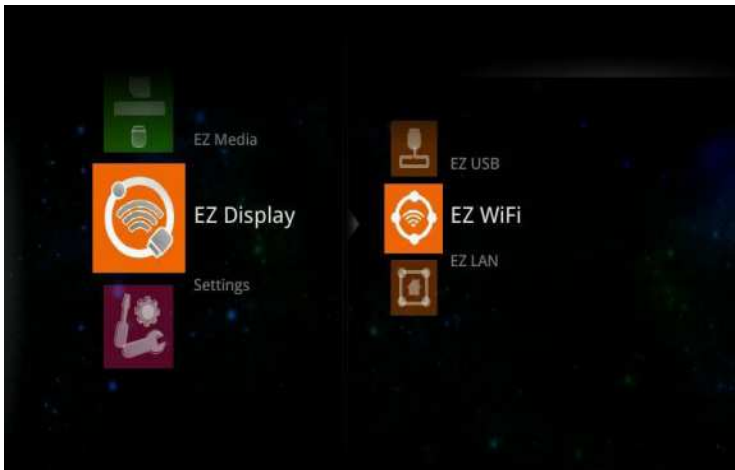

Function	Description	OS system
EZ USB	Display PC Screen with USB cable Extended Display with USB Cable	Windows OS, Mac OS
EZ WiFi	Wirelessly project the computer's screen	Windows OS, Mac OS, Android
EZ LAN	Display computer's screen with Ethernet	Windows OS, Mac OS

EZ Suite(EZ Display Function)

2.1 EZ USB



► **Note :** EZ USB support Windows OS, Mac OS

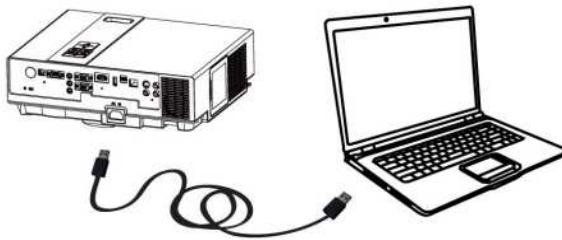

1. Select the EZ USB item at EZ Display interface. It will show the Ready for display image on the screen.



EZ Suite(EZ Display Function)

2. Connect the computer's USB port to the projector's USB (mini-USB) port via the USB A to USB mini-B type USB Cable.
3. Computer's system will examines newly discovered removable media and devices if you connect to projector via USB cable.



4. Click and execute “Detection.exe” program to run the USB Display adapter for projecting the images from a computer's screen.

Removing USB devices :

1. Press ESC button on the remote control to exit the USB Display adapter process.
2. Remove USB cable from the projector and the computer.

2.2 EZ WiFi



► Note :

- 1.EZ WiFi Display support Windows OS, Mac OS, Android
- 2.EZ WiFi can support WiFi AP mode,Client mode.

EZ Suite(EZ Display Function)

Running under WiFi AP Mode:



Projector Setup :

1. Connect an Wireless USB WiFi Dongle unit to the projector's USB Port (USB -A).
2. Set the AP mode parameters at \.\settings\WiFi\AP mode\.

*For more information, please check the page50 for 'WiFi settings'.



EZ Suite(EZ Display Function)

3. Select the EZ WiFi item at EZ Display interface on the screen. It will show the Ready for display image on the screen. And you can find the 4-character pass code on the screen too.



Computer Setup :

1. For first time use, please install PC/Mac-tool(EZ WiFi/LAN.exe) program. After installed, new USB device “EZ USB” and new adapter “EZ Display” (Virtual .Graphics Card) will be installed.

▶ You can download the PC/Mac-tool(EZ WiFi/LAN.exe) through the intranet by web browser. Please check "Download Tool" on Page80 for more information.

2. Find the wireless local area network manager from computer that you broadcast of the SSID(for example: the name of SSID is “Optivtw_W_I”). It would need to manually enter the correct SSID to connect to the network, then execute PC/Mac-Tool(EZ WiFi/LAN.exe) program.



3. It will show the “Enter the passcode” dialog window on the screen, then input 4-character pass code at the dialog(for example : the PCTool Password(EZ WiFi/LAN) passcode is “7200”). After click the OK button, computer will display the EZ Display dialog, it means you can wirelessly project the computer’s screen.

▶ PCTool Password is a 4-character pass code that should be entered on PC tool EZ WiFi (EZ WiFi/LAN), for example the 4-character pass code is ”7200”. EZ WiFi PC tool (EZ WiFi/LAN) will check the pass code for basic protection.

EZ Suite(EZ Display Function)



EZ Suite(EZ Display Function)

Mirror mode (default): Clone or mirror desktop mode



Mirror mode

Extension mode : Span or extended desktop mode

About : The information of EZ WiFi/LAN



Exit : To quit the program and discontinue projecting images from the computer.

Audio Streaming : On -Projecting images from the computer with audio sound.

Off -Projecting images from the computer without audio sound.

► **Note :** The frame rate of video would be decrease while the setting of Audio Streaming is ON.

Exit WIFI Display : Click the **Exit** button from the EZ WiFi/LAN dialog window on the computer or press the ESC button on the remote control to quit WiFi Display.

EZ Suite(EZ Display Function)

Running under WiFi Client Mode:



Projector Setup :

1. Connect an optional Wireless USB WiFi Dongle unit to the projector's USB Port (USB -A).
2. Set the Client mode parameters at \.\settings\WiFi\Client mode\
*For more information, please check the page53 'WiFi settings' for client mode.
3. Use remote control to select the WiFi Display item at EZ Display interface on the screen. It will show the Ready for display image on the screen. And you can find the 4-character pass code on the screen too.

EZ Suite(EZ Display Function)

Computer Ready :

1. We need to install PC/Mac-tool(EZ WiFi/LAN.exe) program. After installed, new USB device “EZ USB” and new adapter “EZ Display” (Virtual .Graphics Card) will be installed.
▶ You can download the PC/Mac-tool(EZ WiFi/LAN.exe) throw the internet by web browser. Please check "Download Tool"Page78 for more information.
2. Find the wireless local area network manager from computer that you broadcast of the SSID(for example: the name of SSID is “Optivtw_W_I”). It would need to manually enter the correct SSID to connect to the network, then execute PC/Mac-Tool (EZ WiFi/LAN.exe) program.



3. It will show the “Enter the pass code” dialog window on the screen, then input 4-character pass code at the dialog, for example : the PCTool(EZ WiFi/LAN.exe) passcode is “7278”, after click the OK button, computer will display the EZ Display dialog, it means you can wirelessly project the computer’s screen.



EZ Suite(EZ Display Function)



Mirror mode (default): Clone or mirror desktop mode



Mirror mode

Extension mode : Span or extended desktop mode

About : The information of EZ WiFi/LAN



EZ Suite(EZ Display Function)

Exit : To quit the program and discontinue projecting images from the computer.

Audio Streaming : On -Projecting images from the computer with audio sound.

Off -Projecting images from the computer without audio sound.

► **Note :** The frame rate of video would be decrease while the setting of Audio Streaming is ON.

1.Exit WIFI Display : Click the **Exit** button from the EZ WiFi/LAN dialog window on the computer or press the ESC button on the remote control to quit WiFi Display.

2.Run in EZ WiFi

3.After EZ-WiFi connection is established, you can execute EZ Display app on your iPhone/iPad, and you will be able to see the device's IP address now. Click it to enjoy EZ Display's complete functions.See Page56 for more information

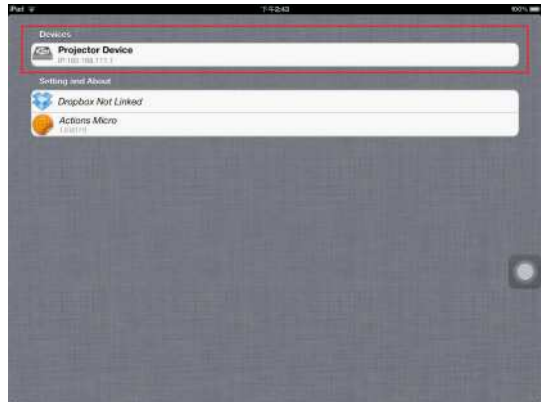

EZ Suite(EZ Display Function)

EZ Display main functions :

1.View MS-Office files(Word, Excel, PowerPoint), Adobe PDF,Apple iWorks(Pages, Numbers, Keynote),and it also supports Sketch function and save to photo roll.

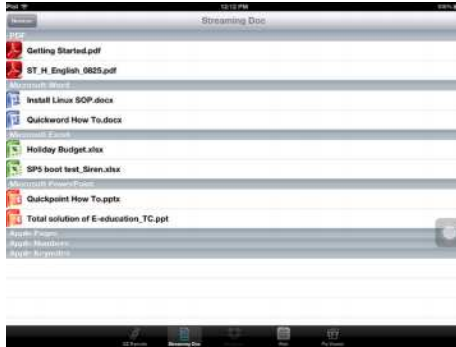

2.Link your Dropbox storage and view the documents stored on it.



3.Display Web pages and support sketch function as well.



EZ Suite(EZ Display Function)

4.View local photo gallery and do sketch



2.3 EZ LAN

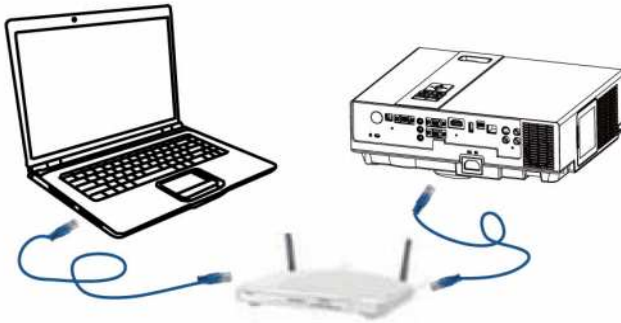

► **Note :** EZ LAN Display supports Windows OS, Mac OS

Projector Setup :

1. Connects projector's LAN port to Switch, Hub, or Local RJ45 outlet LAN port with the standard RJ45 Ethernet cable.
2. Select the EZ LAN item at EZ Display interface on the screen. It will show the Ready for display message on the screen. And you can find the 4-character pass code on the screen too.

EZ Suite(EZ Display Function)



Computer Setup :

1. We need to install PC/Mac-tool(EZ WiFi/LAN.exe) program. After installed, new USB device "EZ USB" and new adapter "EZ Display" (Virtual .Graphics Card) will be installed.
 - ▶ You can download the PC/Mac-tool(EZ WiFi/LAN.exe) through the internet by web browser. Please check Page80 for more information.
2. Executing PC Tools (EZ WiFi/LAN.exe) program from PC/Notebook.









3. It will show the "Enter the pass code" dialog window on the screen, then input 4-character pass code at the dialog. Click the OK button, computer will display the EZ WiFi/LAN dialog, it means you can project the computer's screen via Ethernet.
 - ▶ PC Tools Password is a 4-character pass code that should be entered on PC tool EZ WiFi (EZ WiFi/LAN), for example the 4-character pass code is "7891". EZ WiFi PC tool (EZ WiFi/LAN) will check the pass code for basic protection.

Exit EZ LAN Display :

Click the **Exit** button from the EZ WiFi/LAN dialog window on the computer or use remote control to press the ESC button to quit LAN Display.

3. Setting & Configuration

 Settings Setting & Configuration	 System	Version
		Language
		Update
	 Video	Display Ratio
		Repeat Mode
	 Photo	Display Ratio
		Slideshow
	Slideshow Duration	
 Audio	Repeat Mode	
 WiFi	AP mode	
	Client mode	
 Connect PC	Connect PC Setting	

3.1 System Setting



► **Note :**

1. **Version :** Show the EZ Suite firmware version
2. **Language:** Show the current language
3. **Update :** USB (upgrade the EZ Suite firmware with mini USB cable)

3.2 Video Setting

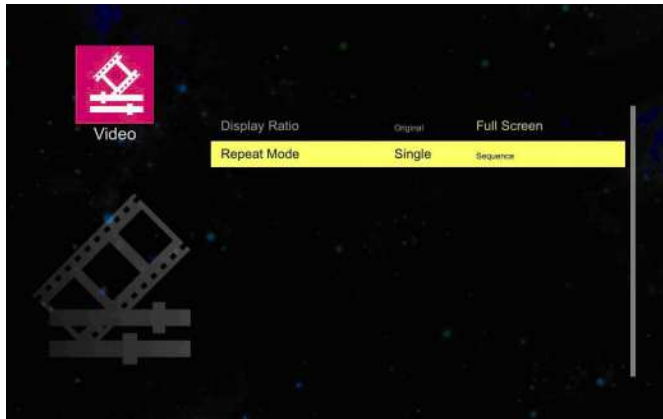

► **Note :**

1. Display ratio

Original : The video aspect ratio changes in the order of Original setting (according to the video image resolution.)

Full Screen : Change the aspect ratio to be displayed at full screen size.

2. Repeat Mode

Signal : Play the selected video file once.

Sequence : To play the playlist in sequence.

3.3 Photo Setting



► **Note :**

1. Display ratio

Original: Projected the image of original size.

Full Screen : Change the aspect ratio to be displayed at full screen size.

2. SlideShow

OFF : Turns SlideShow function off.

ON : Turns SlideShow function on.

3. Slideshow Duration: Set the Photo Slideshow duration time as 10 seconds, 30 seconds or 1 minutes.

3.4 Audio Setting

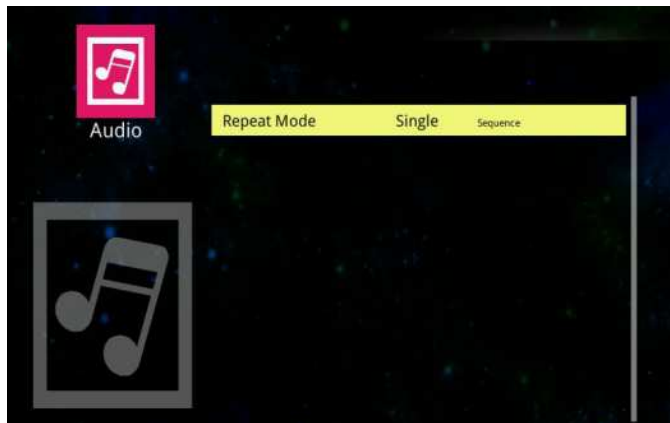

► **Note:**

Repeat mode

Signal : Play the selected audio file once.

Sequence : To play the playlist in sequence.

3.5 WiFi Setting

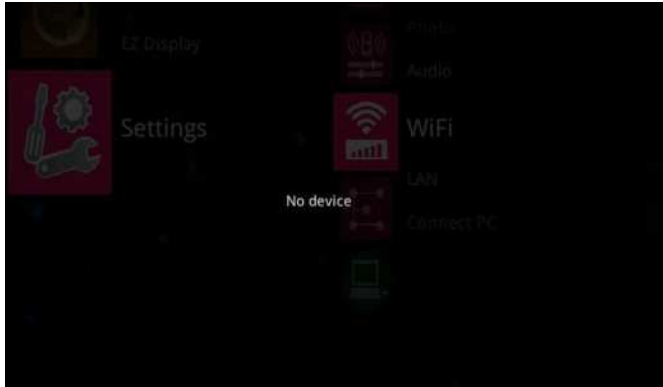

Please plug in the WIFI USB Dongle first; otherwise the projector would examine and project “No device” message on the screen.



There are AP mode, Client mode at the WiFi setting.

EZ Suite(Setting&Configuration)

AP mode(Ad Hoc) :



Select the **ON** button, then press the ENTER button on the remote control to go to set some parameters for being enabled under AP mode.



- ▶ These settings are only for basic wireless parameters. If you are going to modify these wireless parameters, the visual keyboard will pop-up on the screen. Press the **▲**, **▼**, **◀** or **▶** buttons to select a character on the visual keyboard, and press the ENTER button to key in the character. Press ESC button to quit the setting, it can help you to configure your setting.

EZ Suite(Setting&Configuration)

SSID (Service Set Identification) : The same name of SSID must be assigned to wireless devices in your network. Considering your wireless network security, the default SSID is set to be “rtwap”.

Security : you can configure the security settings of your wireless network.

There are three wireless security modes supported by the Router : Open, WPA2 and WPA.

Open – it means no security settings of this wireless network.

The default setting is automatic that based on the wireless station's capability and request.

WPA(default) and WPA2 – It's the WPA/WPA2 authentication type.

PSK (Pass-Key) : You can enter a key-code.

Channel : This field determines which operating frequency will be used. It is not necessary to change the wireless channel unless you notice interference problems with another nearby access point.

Auto : The default setting is automatic, which can adjust the channel width for your clients automatically.

V : press the ENTER button to enable AP mode, and then press the ESC button on the remote control to quit AP mode setting page.

X : abort the setting, or you can press the ESC button on the remote control to quit setting.

EZ Suite(Setting&Configuration)

Client mode :

When wireless clients survey the local area for wireless networks to associate with, they will detect the SSID broadcast by the Router. The SSID of the AP your Router is going to connect to as a client.



Select the **ON** button and press ENTER button on the remote control for starting Client mode.

Press the **▼** button on the remote control to go to the items of SSID. The visual keyboard will pop-up on the screen if select a SSID name and ask you PSK(pass-key) for connecting. Press the **▲**, **▼**, **◀** or **▶** ENTER buttons on the visual keyboard to key-in the PSK entry that should be chosen according to the AP's security configuration.



EZ Suite(Setting&Configuration)



Press the **OK** to connect to as a client.

EZ Suite(Setting&Configuration)



Connect successfully.

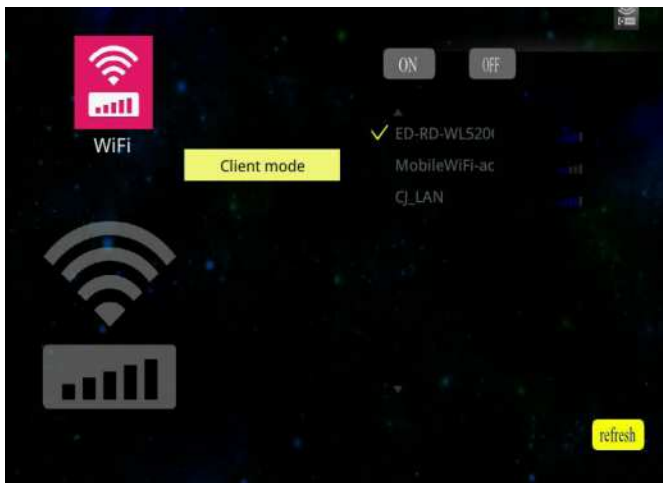

Select the **refresh**, then press the ENTER button on the remote control to detect the SSID broadcast with the Router again.

EZ Display :

Main functions :

- View MS-Office files(Word, Excel, PowerPoint), Adobe PDF, Apple iWorks(Pages, Numbers, Keynote), and it also supports Sketch function and save to photo roll.
- View local photo gallery and do sketch
- Display Web pages and support sketch function as well
- Link your Dropbox storage and view the documents stored on it.

1.Open App store to download the app which is EZ display.



2.Configuring the Projector's Wi-Fi:

EZ Display can support AP mode and Client mode.

AP mode :

Set the AP mode parameters at `\\.settings\WiFi\AP mode\.`

See 'WiFi settings' (Page50) for more information to set parameters.



Connects directly to a projector.

EZ Suite(Setting&Configuration)

Client mode :

Set the client mode parameters at \.\settings\WiFi\Client mode\.

See 'WiFi settings' (Page52) for more information to set parameters.



Connects through a wireless LAN router..

► Note :

Compatible Devices :

Application	Compatible OS version
EZ display	- iOS 5.1.1 or later - Android 4.0 or above.

3.6 Connect PC Setting

Connect PC for accessing internal memory.

- 1.Connect the computer's USB port to the projector's USB (mini-USB) port via the USB cable.
- 2.Computer's system will examines newly discovered removable media and devices.



- 3.Projector will display the connecting message on the screen.
4. Click and execute"Open folder to view files",it can access the internal memory from projector.

Remove connecting Internal Memory.

Press the “ESC” button on the remote control to exit communication process with computer, and then remove mini-USB cable from the projector and computer.

Menu Operation

How To Operate On-Screen Display

1. You could press "Menu" button. It will be shown blue main menu. The first main menu is " PICTURE" menu.
2. Choose which item you want to enter, you could press up / down /left/ right button of control panel or remote control to adjust item or value.



Up / Down / Right / Left button

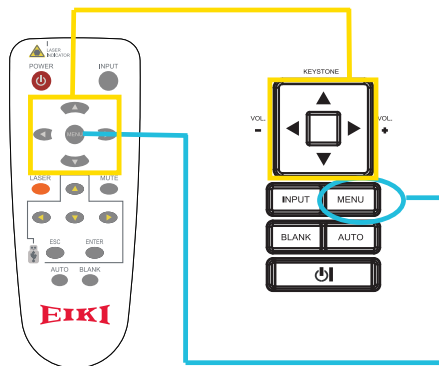

Menu button

Picture Menu

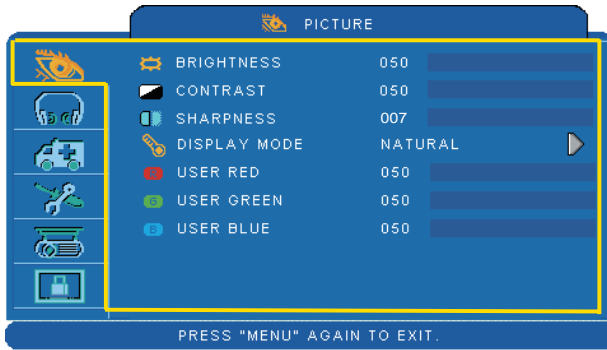

Step:

1. Use the ▲ / ▼ buttons to select an item.
2. Use the ◀ / ▶ cursor buttons to select an item or adjust the value.

Item	Selection	Description
BRIGHTNESS	000/100	Adjust the image brightness level.
CONTRAST	000/100	Adjust the image contrast level.
SHARPNESS	000/015	Adjusts the image sharpness.
DISPLAY MODE	NATURAL	Natural color.
	CINEMA	Enhance contrast ratio when displaying DVD contents.
	DAYLIGHT	Suitable when ambient light is strong.
	GREEN BOARD WHITE BOARD BLACK BOARD	Adjust the color settings to make the projected image on a (green, white, black) board more visible.
	USER	User Red 000/100 User Green 000/100 User Blue 000/100

*Only USER mode in Display mode USER RED/GREEN/BLUE can be adjusted.

*The setting data in this Picture Menu is not shown correctly if no signal is fed and projected.

Audio Menu

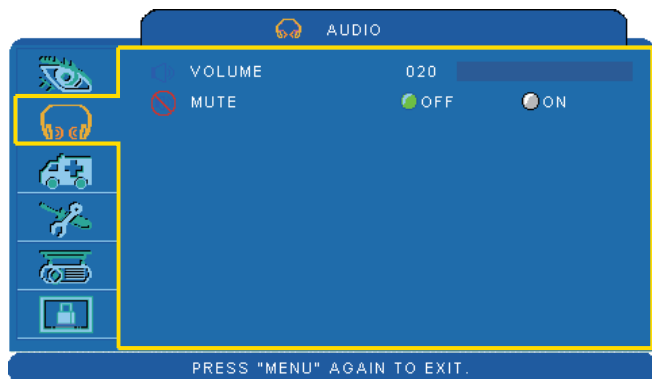

Step:

1. Use the ▲ / ▼ buttons to select an item.
2. Use the ◀ / ▶ buttons to select an item or adjust the value.

Item	Selection	Description
VOLUME	00/40	Adjust the volume.
MUTE	OFF/ON	Mute the volume OFF / ON.

Setting Menu



Step:

1. Use the ▲ / ▼ buttons to select an item.
2. Use the ◀ / ▶ buttons to select an item or adjust the value.

Item	Selection	Description
H POSITION	000/100	Move the image position horizontally. This function is only selected for computer signal.
V POSITION	000/100	Move the image position vertically. This function is only selected for computer signal.
PHASE	000/100	Adjust the image sharpness.
FREQUENCY	000/200	Set the horizontal scanning frequency.
AUTO KEYSTONE	OFF/ON	Correct keystone distortion in image automatically.
V KEYSTONE	-70/+70	Correct vertical keystone distortion in image manually.
AUTO SYNC	EXECUTE	Set all of the above setting automatically.
AUTO SEARCH	OFF/ON	Search signal source manually or automatically.

Picture Menu



Step:

1. Use the ▲ / ▼ buttons to select an item.
2. Use the ◀ / ▶ cursor buttons to select an item or adjust the value.

Item	Selection	Description
BRIGHTNESS	000/100	Adjust the image brightness level.
CONTRAST	000/100	Adjust the image contrast level.
SHARPNESS	000/015	Adjusts the image sharpness.
COLOR	000/100	Adjust the strength of whole color. This function can be used under video signal, S-Video signal, or component video signal input only.
TINT	000/100	Adjust the image tint. This function can be used under video signal, S-Video signal, or component video signal.
DISPLAY MODE	NATURAL	Natural color.
	CINEMA	Enhance contrast ratio when displaying DVD contents.
	DAYLIGHT	Suitable when ambient light is strong.
	GREEN BOARD WHITE BOARD BLACK BOARD	Adjust the color settings to make the projected image on a (green, white, black) board more visible.
	USER	User Red 000/100 User Green 000/100 User Blue 000/100

*Only USER mode in Display mode USER RED/GREEN/BLUE can be adjusted.

*The setting data in this Picture Menu is not shown correctly if no signal is fed and projected.

Audio Menu

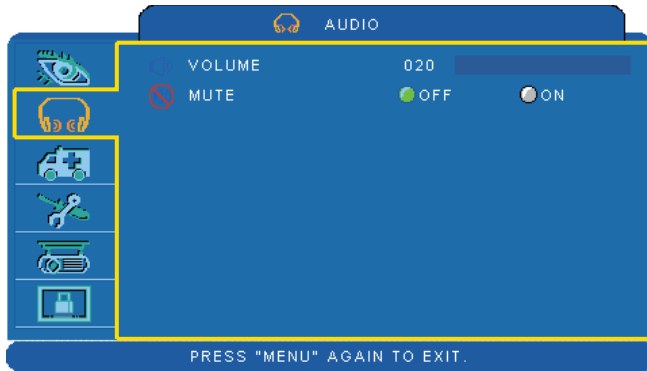

Step:

1. Use the ▲ / ▼ buttons to select an item.
2. Use the ◀ / ▶ buttons to select an item or adjust the value.

Item	Selection	Description
VOLUME	00/40	Adjust the volume.
MUTE	OFF/ON	Mute the volume OFF / ON.

Setting Menu



Step:

1. Use the ▲ / ▼ buttons to select an item.
2. Use the ◀ / ▶ buttons to select an item or adjust the value.

Item	Selection	Description
AUTO KEYSTONE	OFF/ON	Automatically Correct keystone distortion in image.
V KEYSTONE	-70/+70	Correct vertical keystone distortion in image manually.
AUTO SEARCH	OFF/ON	Search signal source manually or automatically.

Advanced Menu

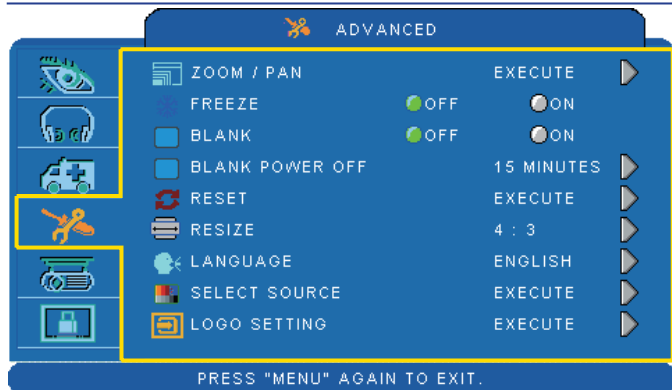

Step:

1. Use the ▲ / ▼ buttons to select an item.
2. Use the ◀ / ▶ buttons to select an item or adjust the value.

Item	Selection	Description
ZOOM / PAN	EXECUTE	Execute digital zoom and pan function.
FREEZE	OFF/ON	Freeze the current image on the screen.
BLANK	OFF/ON	Hide the image, display a black screen.
BLANK POWER OFF	15/30/60 Minute	Set power off time after blank.
RESET	EXECUTE	Reset all menu function to their factory default values.
RESIZE		4:3,16:9 16:10,1:1
LANGUAGE	ENGLISH	Select the language that the menu and on screen message is display in ▶ English → 繁體中文 → 简体中文 → 日本語 → 한국어 Italiano ← Deutsch ← Français ← Dutch ← ▶ Polski → Português → Русский → Español قىبرع ← ไทย ← Українська ← Svenska ←

MENU

SELECT SOURCE	EXECUTE	<p>Select the input source item, it will show the sub-items on the screen. Use the ▲ / ▼ buttons to change input source item. And use ► button to select input source</p> <p>RGB2 I/O could be turned into one of analog RGB IN 2 input source or output the projected from MONITOR OUT to an external monitor by RGB 1 source.</p>
LOGO SETTING	EXECUTE	<p>Customize the start-up logo. IMPORTANT: To implement Logo setting function, please enter PIN code first. Without inputting the PIN code, you cannot modify Logo setting function.</p>

Advanced Menu



LOGO SETTING

This function allows you to customize the start-up logo.

IMPORTANT:

To implement Logo setting function, please enter PIN code first. Without inputting the PIN code, you cannot modify Logo setting function.

Item	Selection	Description
LOGO MODE	DEFAULT	Select Mode(► cursor button)
	USER	The factory logo.
	OFF	The image you captured. The blank image. You can select color with background function.
LOGO CAPTURE	EXECUTE	Start to capture the image.(PC mode only)
BACKGROUND	BLACK BLUE WHITE	Set background color.
LOGO SIZE	ORIGINAL FULL	Display the captured image in original size and put in the center of the screen. Expend the image to full screen.

Advanced Menu

Logo Capture

How to use this function?

- ① Select Logo Capture item in the logo setting menu, and press ► button.
- ② You can see the red frame to select captured area.
- ③ Use 4 direction buttons to adjust the position of the frame.
- ④ Press “MENU” to start capturing and display a dialog.

②

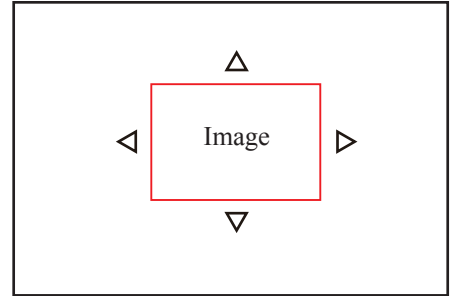

④

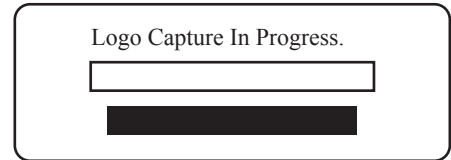

► NOTE

To capture an image is available only in PC mode.
The area that can be captured is 512 x 384 dots.

Presentation Menu

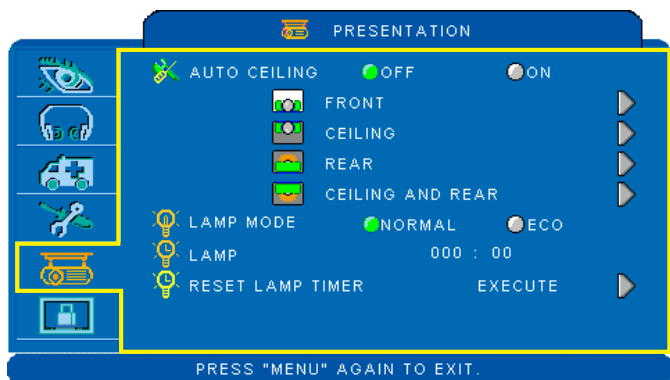

Step:

1. Use the ▲ / ▼ buttons to select an item.
2. Use the ◀ / ▶ buttons to select an item or adjust the value.

Item	Selection	Description
AUTO CEILING	OFF / ON	Automatically invert the image when the projector is turned upside down, i.e. when the projector is mounted on the ceiling.
FRONT	EXECUTE	Normal projection mode.
CEILING	EXECUTE	Mirror the image vertically, only for the projector mounted upside down.
REAR	EXECUTE	Mirror the image horizontally, only for projecting onto rear projection screen.
CEILING AND REAR	EXECUTE	Mirror the image horizontally and vertically. Projecting onto a rear projection screen while projector is upside down.
LAMP MODE	NORMAL / ECO	Switch lamp mode between Normal or ECO mode.
LAMP		Show lamp use time.
RESET LAMP TIMER	EXECUTE	After changing a new lamp, execute this function to reset the lamp timer.
POWER MANAGEMENT	15/30/60/off/ Minutes	Set power off time after detecting no signal.

Presentation Menu

Reset Lamp Timer

The lamp timer is the time counted after the last resetting. The usage time of the lamp is shown in the PRESENTATION Menu. Pressing the RESET button or the ► button displays a dialog.

To reset the lamp time, select the RESET using the ► button.

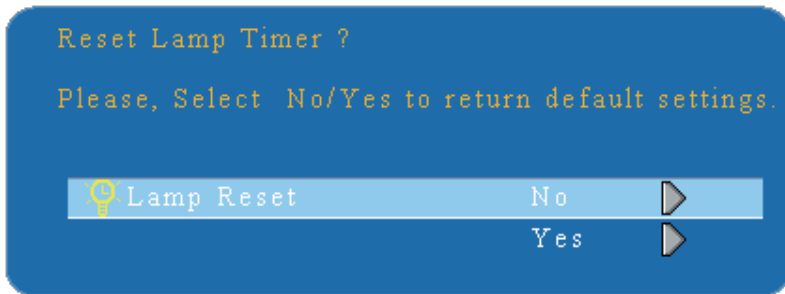

► NOTE

<LC-XNB4000N>The replacement warning message is set to appear after about 3000 hours of lamp use in order to maintain the initial brightness.

<LC-XNB3500N>The replacement warning message is set to appear after about 2000 hours of lamp use in order to maintain the initial brightness.

<LC-WNB3000N>The replacement warning message is set to appear after about 2000 hours of lamp use in order to maintain the initial brightness.

When replacement message appears, replace the lamp with a new one as soon as possible, even if the lamp is still workable.

Security Menu



Step:

1. Use the ▲ / ▼ buttons to select an item.
2. Use the ◀ / ▶ buttons to select an item or adjust the value.

Item	Selection	Description
PIN LOCK PROTECTION	OFF ON 1 ON 2	<p>OFF: Turn off PIN lock protection.</p> <p>ON 1: After plugging in AC power, you need to key in PIN code at the first time of use. If the AC power stays plugged, you do not need to key in PIN code next time when you use the projector.</p> <p>ON 2: You need to key in PIN code every time when you turn on the projector.</p> <div style="border: 1px solid black; padding: 5px; margin-top: 10px;"> <p>⚠ CAUTION: Once the PIN code had been set, the projector cannot be used unless you enter the correct PIN code.</p> </div>
MODIFY PIN	EXECUTE	<ol style="list-style-type: none"> 1. Press “ MENU ” on the projector or remote control. 2. Use the ▶ button to select the MODIFY PIN item of the SECURITY category. 3. Press the ▶ button to change PIN LOCK PROTECTION mode. 4. Please enter the original PIN code. <ol style="list-style-type: none"> (a) If the PIN is correct, system will allow you to change a new PIN code. (b) If the PIN is incorrect, a “ Code Error ” message will appear. 5. Please enter a new PIN code. And then enter again to confirm. <div style="border: 1px solid black; padding: 5px; margin-top: 10px;"> <p>NOTE:</p> <ol style="list-style-type: none"> (1) To change the PIN lock protection state, you must enter the PIN code first. (2) Please enter: 0000 for first-time use. (3) To avoid unnecessary trouble, if you activate the [PIN Lock Protection], it is highly recommended that you write down the PIN code and store it in a safe place. </div>

Security Menu

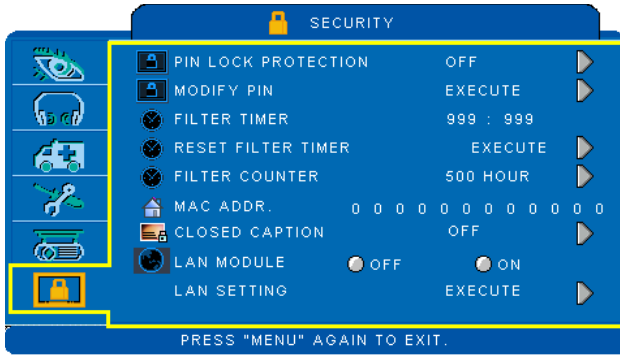

Step:

1. Use the ▲ / ▼ buttons to select an item.
2. Use the ◀ / ▶ buttons to select an item or adjust the value.

Item	Selection	Description
FILTER TIMER		Show the filter use hour.
RESET FILTER TIMER	EXECUTE	Reset the filter timer after cleaning / changing filter.
FILTER COUNTER	500 hours 800 hours 1000 hours	Select (500 / 800 / 1000 hours) depending on the environment.(default : 500 hours). Please see page75.
MAC ADDR.		If purchasing LAN control module, "MAC ADDR." will be shown in "Security" Menu. MAC address stands for unique Media Access Control address of LAN control module and displays with six groups of two hexadecimal digits.
CLOSED CAPTION	OFF(Default) C.C1 C.C2 C.C3 C.C4 T1 T2 T3 T4	The Closed Caption function intimates the sound effects, dialogue, and narration in the content of the television program or video source. Caption (C.C1~C.C4) : Display closed caption Text (T1~T4) : Display text data, which is for additional information such as news reports or a TV program guide. NOTE : This function is available only in video / S-Video source.
LAN MODULE	OFF ON	If purchasing LAN control module, "LAN MODULE" will be shown in "Security" Menu. Select ON/OFF to turn on/off LAN control feature.
LAN SETTING	EXECUTE	Enter LAN SETTING to set up projector network configuration.

Security Menu



Step:

1. Use the ▲ / ▼ buttons to select an item.
2. Use the ◀ / ▶ buttons to select an item or adjust the value.

Item	Selection	Description
PROJECTOR NAME	Default is Projector	Projector network setting display which shows bits that can be recognized by ASCII.
DHCP	OFF / ON	When setting ON, projector's IP address will be assigned by DHCP server automatically. When setting OFF, you can use remote control to do setting manually.
IP		Key in IP address manually. Press "ENTER" to do digit setting. When appears, press ▲ / ▼ to adjust value. When finishing value adjustment, press MENU to exit.
MASK		Enter MASK address manually. Press "ENTER" to do digit setting. When appears, press ▲ / ▼ to adjust value. When finishing value adjustment, press MENU to exit.
GATEWAY		Enter GATEWAY address manually. Press "ENTER" to do digit setting. When appears, press ▲ / ▼ to adjust value. When finishing value adjustment, press MENU to exit.

Auto Filter Alert

Auto Filter Alert is in SECURITY category to show the air filter use time and alert user to change filter. Pressing ► cursor button will display a dialog. When the operating time reaches the set time, a warning message will appear on the screen to remind user of filter cleaning / replacing.



Filter Replace...

Filter has been used for more than 500 hours.

► NOTE

Please reset the Filter time only when you replace the filter.

PIN Key In Operation

When the projector is turned on and the PIN LOCK PROTECTION is set to [ON], the image will show as on the right side.

1. Press the MENU button on the projector or remote control. Enter PIN code by keypad or remote control.
2. How to enter a PIN code?
You can use control panel or remote control.

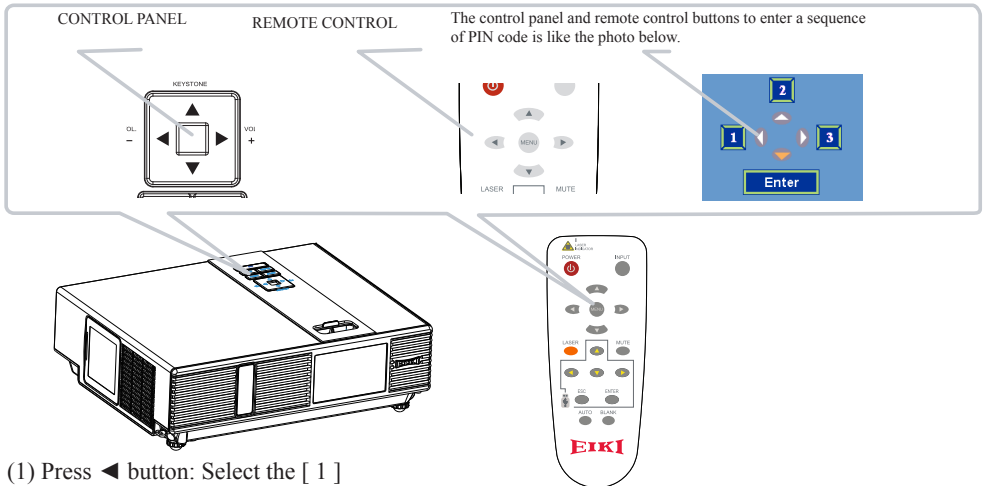
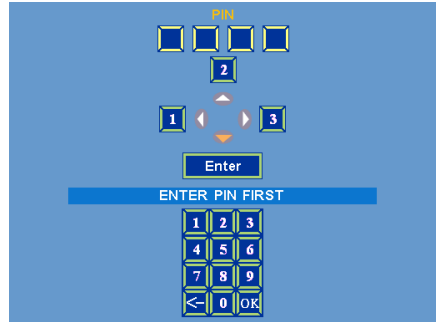

- (1) Press ◀ button: Select the [1]
- (2) Press ▲ button: Select the [2]
- (3) Press ▶ button: Select the [3]
- (4) Press ▼ button: Select the [Enter] move to next row.(4~6,7~9, ◀~OK)
- (5) Press ◀ (backspace) item:
In case you enter a wrong digit, select ◀ to delete the wrong digit you entered.
- (6) Press OK item:
Once all four digits of the PIN are entered, select OK to confirm.

► NOTE

- (1) Please enter: 0000 for first-time use.
- (2) If the PIN is incorrect, a "Enter new code" message will be shown. Please try again. If the PIN code input is incorrect for three times, a warning message will show up and the projector will shut itself down in 30 seconds.
- (3) If you have no idea about the PIN, please contact your dealer for help.

Network Control Software Application

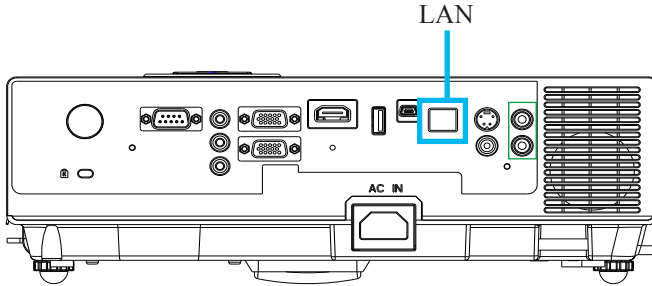

Procedure to utilize this function

It can help user to monitor and manage the projector(s) status in the local area network.

- ① Register the projector(s) which needs to be controlled.
" Auto search " can help you to seek the projector(s) source easily.
After registering in the work group, you can start to control the projector.
- ② Group the projector(s) into different sections.
You can monitor the status easily by the sort of group name function in the network.
- ③ Monitor the status for each projector.
a. You can manage and change the monitoring content by System Parameter Setting.
b. The Lamp timer, filter working time or system warning feedback etc. can be known by checking the status for projector(s).
- ④ Control the booked projector(s).
The status can be refreshed and acquired by monitoring functions; you can also operate the function easily by Network Control.

► NOTE

To monitor and control the projector(including stand-by mode), the following conditions need to be ready:

- (1) Projector should already be powered on.
- (2) Projector is connected to network.
- (3) LED light of the projector network port shows normal. (Green light on, Orange twinkle)

* Stand-by mode indicator: Green LED (Power) on the projector's control panel flashes.

Before Using Network Control Software

1. The projector should be powered on and the LAN wire is well connected to projector.
2. The LAN module ON/OFF item in SECURITY menu of OSD should be setting ON.
3. Make sure the computer and projector can connect to network. Network Control software needs to arrange in TCP/IP network communication and the network cable.

► NOTE:

IE8 browser & 1024x768 viewing resolution is recommended.

Network Control Software Application

Browser Control

Auto IP address setting (while DHCP setting is "ON"):

- (1) Enable DHCP from the projector on-screen-display menu, under "SECURITY \ LAN SETTING".
- (2) Please wait for the PC server to release IP address to the projector.
- (3) Enter "Given IP address (For example http://192.168.1.176/)" into the address bar of the web browser and press "Enter" key or click "Go" button.



Projector Network Control

V0.1

[Home](#) [Control Panel](#) [Network](#) [Alert Setting](#) [Schedule](#) [Time](#) [Crestron](#) [Logout](#)

Status

IP Address: 192.168.1.200
Projector Name: Projector
System Status: Power On
Input Source: RGB1
Lamp Hours: 3
Filter Hours: 3
Projector Status: Normal
MAC Address: 00:60:E9:00:15:21

Item Setting description:

ITEM SETTING	DESCRIPTION
Home (Status)	Show current projector status and network configuration settings.
Control Panel	Select projector's detailed setting from this page.
Network	Set up network configuration and password from this page.
Alert Setting	Show and setup Alert configurations.
Schedule	Show and set up Schedule, including Weekly Schedule and Specific Day.
Time	Set up the date/time on the projector.
Crestron	Crestron configuration.
Logout	Logout information.

If the Administrative & User password is enabled, select your User Name and enter password to login.

Network Control Software Application



ADMINISTRATOR MODE
User name: admin
Password: (Default password setting is disabled.)

Home (Status):

Show current projector status and network configuration settings.

Projector Network Control

V0.2

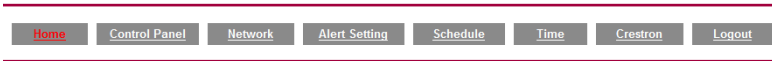

Status

Projector Name: PROJECTOR
System Status: Inactive
Input Source: ---
Lamp Hours: ---
Filter Hours: ---

Wired Lan

IP Address: 10.0.165.100
Subnet Mask: 255.255.0.0
Gateway: 10.0.0.201
MAC Address: 00:60:E9:00:15:21

Wireless Lan

Mode: ---
SSID: ---
Channel: ---
IP Address: ---
Subnet Mask: ---
Gateway: ---
MAC Address: ---

Download Tool



Network Control Software Application

ITEM	ITEM SETTING	DESCRIPTION
Status	Projector Name	Show projector name.
	System Status	Show if projector is Power On or Inactive .
	Input Source	Show current input source.
	Lamp Hours	Show lamp used hours on current projector.
	Filter Hours	Show filter used hours on current projector.
Wired LAN	IP Address	Show current IP address of wired LAN.
	Subnet Mask	Show current Subnet Mask of wired LAN.
	Gateway	Show current Gateway of wired LAN.
	MAC Address	Show current MAC Address of wired LAN.
Wireless LAN	Mode	Access Point Mode.
	SSID	SSID (Service Set Identification) is the wireless network name, it must be assigned to wireless devices in your network.
	Channel	This field determines which operating frequency will be used. The default channel is set to Auto, so the AP will choose the best channel automatically.
	IP Address	Show current IP address of Wireless LAN.
	Subnet Mask	Show current Subnet Mask of Wireless LAN.
	Gateway	Show current Gateway of Wireless LAN.
	MAC Address	Show current MAC Address of Wireless LAN.
Download Tool	Windows	To download the application program of EZ WiFi_LAN. The file is Windows OS only for EZ Display used.
	MAC	To download the application program of EZ WiFi_LAN. The file is MAC OS only for EZ Display used.

Control Panel:
Select projector's detailed setting from this page.

Projector Network Control

v0.1

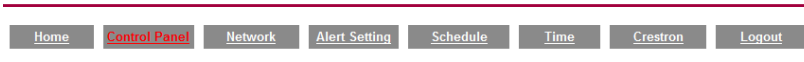

Control Panel

Projector Name Boston

Power

Input Source RGB1

Picture

Brightness

Contrast

Sharpness

Color

Tint

Display Mode Natural

Audio

Volume

Mute OFF

Setting

Keystone

Auto SYNC EXECUTE

Auto Search OFF

Advanced

Blank OFF

Blank PowerOff 60 Min.

Freeze ON

Resize 4:3

Reset All No

Presentation

Projection Front

LAMP Mode Economic

Network Control Software Application

ITEM SETTING	DESCRIPTION
Basic	
Projector Name	Show projector name on the current projector.
Power	Power On or Power Off the projector via network.
Input Source	Select input source.
Picture	
Brightness	Adjust the image brightness level.
Contrast	Adjust the image contrast level.
Sharpness	Adjust the image sharpness.
Color	Adjust the strength of whole color. This function can only be used under Video signal, S-Video signal, or component video signal input.
Tint	Adjust the image tint. This function can be used under Video signal, S-Video signal, or component video signal.
Display Mode	Adjust Natural/Cinema/Daylight/Green Board/White Board/Black/User Mode.
Audio	
Volume	Adjust the volume.
Mute	Mute the volume OFF / ON.
Setting	
Keystone	Manually correct vertical keystone distortion in image.
Auto Sync	Set all of the above setting automatically. (This function can only be used under PC mode)
Auto Search	Search signal source manually or automatically.
Advanced	
Blank	Blank the current image on the screen
Blank Power Off	No / 15 / 30 / 60 (minutes)
Freeze	Freeze the current image on the screen.
Resize	4:3,16:9, 1:1, 16:10
Reset All	Reset all menu function to their factory default values.
Presentation	
Projection	Select Front/Ceiling/Rear/Celing and Rear
Lamp Mode	Switch lamp mode between Powerful or Normal mode.

Network Control Software Application

Network :

Set up network configuration and password from this page.

Projector Network Control

V0.1

Home

Control Panel

Network

Alert Setting

Schedule

Time

Crestron

Logout

Network Setting

Network

DHCP

Manual

IP Address

Subnet Mask

Gateway

DNS Server

Group Name

Projector Name

Password

Administrator Enable Disable

New Password

Confirm Password

ITEM SETTING	DESCRIPTION
Network	
DHCP	Assign an IP address to the projector from the DHCP server automatically.
IP Address	Set up IP Address when DHCP is disabled.
Subnet Mask	Set up Subnet Mask when DHCP is disabled.
Gateway	Set up Gateway when DHCP is disabled.
DNS Server	Set up DNS Server address when DHCP is disabled.
Group Name	Create projector group. (Max length: 14 characters)
Projector Name	Create projector naming of the current projector. (Max length: 14 characters)
Password	
Administrator	Turn ON/OFF administrative password function.Administrator mode can control the conditions on web.
New Password	Enter administrative password.(Max length: 15 characters)
Confirm Password	Re-enter administrative password.

Alert:

Show and setup Alert configurations.

Projector Network Control

V0.1

Home

Control Panel

Network

Alert Setting

Schedule

Time

Crestron

Logout

Alert Setting

Email Setting

To

Cc

Subject

From

SMTP Setting

Server

User Name

Password

Alert Condition

Fan Lock

Over Temperature

Filter Time Alert

Lamp Fail

Lamp Time Alert

When problem occurs to the projector, it will automatically send e-mail to remind user.

How to operate:

1. Enter Email Setting columns.
2. Enter SMTP Setting columns.
3. Select Alert Condition. Multiple choices are fine.
4. Press Submit to confirm.
5. After completing Alert Setting for the first time, it is recommended that you press Issue Test Mail to see if the attendees can receive the e-mail. If the attendees cannot receive the e-mail, please check if the setting is correct or not. If you have questions with the Alert Setting, please contact your network service provider.

ITEM SETTING	DESCRIPTION
Email Setting	
To	Set up the mail alert attendee. (Max length: 40 characters)
Cc	Set up the backup mail alert attendee. (Max length: 40 characters)
Subject	Set up the subject of the alert e-mail. (Max length: 40 characters)
From	Set up the sender e-mail address. (Max length: 40 characters)
SMTP Setting	
Server	To enter the SMTP server (Mail server) name of the company or IP address.(Max length: 40 characters)
User Name	Enter the sender's e-mail address. (Max length: 40 characters) For example: david@xxxxx.com
Password	Enter password of the sender's e-mail account. (Max length: 15 characters)
Alert Condition	
Fan Lock	The cooling fan is not operating.
Over Temperature	The projector internal is over heated.
Lamp fail	The lamp does not light up.
Lamp Time Alert	Lamp has reached its life time. Suggest changing the lamp.
Lamp Cover Opened	Lamp Cover does not close well.
Filter Time Alert	Filter has reached its life time. Suggest cleaning the filter.

Network Control Software Application

Schedule :

Show and set up Schedule, including Weekly Schedule and Specific Day.

Weekly Schedule

Projector Network Control v0.1

Home **Control Panel** **Network** **Alert Setting** **Schedule** **Time** **Crestion** **Logout**

Weekly Schedule **Specific Day**

Weekly Schedule

Power On Time : Input Source

Power Off Time :

No.	Week	Power On	Power Off	Input Source	Cancel
1	-	-	-	-	<input type="button" value="Cancel"/>
2	-	-	-	-	<input type="button" value="Cancel"/>
3	-	-	-	-	<input type="button" value="Cancel"/>
4	-	-	-	-	<input type="button" value="Cancel"/>
5	-	-	-	-	<input type="button" value="Cancel"/>

To power on and power off projector based on Weekly Schedule.

How to set up:

1. Choose week days.
2. Set up power-on or power-off time.
(Please be sure that the interval between power-on and off setting is more than 5 minutes.)
3. Enter Input Source and select input source.
4. After completing setting, press ADD to confirm.
5. To cancel items, select the item and press "Cancel" button.

Specific Day

Projector Network Control v0.1

Home **Control Panel** **Network** **Alert Setting** **Schedule** **Time** **Crestion** **Logout**

Weekly Schedule **Specific Day**

Specific Day

Power On Time : : Input Source

Power Off Time : :

No.	Power On	Power Off	Input Source	Cancel
1	-	-	-	<input type="button" value="Cancel"/>
2	-	-	-	<input type="button" value="Cancel"/>
3	-	-	-	<input type="button" value="Cancel"/>
4	-	-	-	<input type="button" value="Cancel"/>
5	-	-	-	<input type="button" value="Cancel"/>

Based on Specific Day to set up power-on and power-off time.

How to set up:

1. Choose power-on days and time.
2. Choose power-off days and time.
(Please be sure the setting period between power-on time and off time is greater than 5 minutes.)
3. Enter Input Source and select input source.
4. After completing setting, press ADD to confirm.
5. To cancel items, select the item and press "Cancel" button.

Network Control Software Application

Time :

Projector Network Control v0.2

Home Control Panel Network Alert Setting Schedule **Time** Crestron Logout

Time

Current System Time	
2012-09-18 09:31:48 <input type="button" value="Refresh"/>	

System Time Setting			
Date	Year: 2012	Month: Sep	Day: 18
Time	Hour: (0-23) 9	Minute: (0-59) 31	Second: (0-59) 48

1. Current System Time Setting : Refresh the date/time on the webpage if you click “Refresh” button.
2. System Time Setting : To set the date/time manually
Enter the Date in Month/Day/Year format.
Enter the Time in Hour/Minute/Second format.
3. Click the “Submit” button to save your setting.

Crestron : Projector's detailed setting from Crestron.



Network Control Software Application

ITEM SETTING	DESCRIPTION
Power	Power On or Power Off the projector via network.
Vol + (Volume +)	Adjust the volume up.
Vol - (Volume -)	Adjust the volume down.
Mute	Mute the volume OFF / ON.
Source List	Select input source. RGB1 RGB2 HDMI/DVI VIDEO S-VIDEO USB
Brightness	Adjust the image brightness level.
Contrast	Adjust the image contrast level.
Color	Adjust the strength of whole color. This function can only be used under Video signal, S-Video signal, or component video signal input.
Sharpness	Adjust the image sharpness.
ZOOM	Zoom in/Zoom out and Pan.
Menu	Display or hide the OSD main menu.
UP/Down buttons	Use UP/Down buttons to select an items.
Left/Right buttons	Use left/right buttons to select an items or adjust the value.
Source	RGB1->RGB2->HDMI->USB->Video->S-Video->RGB1.
Enter	Use Enter buttons to select an item.
Auto	Automatically adjust the setting to match the current input.
Blank	Blank the projected image. The time of Blank mode can be set in 15 minutes, 30 minutes or 60 minutes. The projector will shut down automatically after passing each set time.

About the Tools button :

Set up network configuration, projector network web browser login password and set projector name from this page.

The screenshot displays the 'Tools' section of the Crestron Control software. It is divided into three main columns: 'Crestron Control', 'Projector', and 'User Password'.
Crestron Control: Includes fields for 'Ip Addr' (10.0.167.102), 'Ip Id' (5), and 'Port' (41794), with a 'Send' button.
Projector: Includes fields for 'Projector Name' (RD_EE), 'Location' (LOCATION), and 'Assigned To' (Projector), with a 'Send' button.
Network Settings: A section with a 'DHCP' checkbox (unchecked) and fields for 'Ip Address' (192.168.1.162), 'Subnet Mask' (255.255.255.0), 'Default Gateway' (192.168.1.254), and 'DNS Server' (168.95.1.1), with a 'Send' button.
User Password: Includes a 'User Password' section with an 'Enabled' checkbox and 'New Password' and 'Confirm' fields, and an 'Admin Password' section with an 'Enabled' checkbox and 'New Password' and 'Confirm' fields, both with 'Send' buttons.
 At the bottom center is an 'exit' button. The Crestron logo is in the bottom left, and 'Expansion Options' is in the bottom right.

Network Control Software Application

1. Click  button to leave this page.

2. Crestron Control

Projector Name :

Displays the projector name used to identify the projector when connected to a network. When editing, you can enter up to 14 single-byte alphanumeric characters.

Location :

Show the location where the projector is. When editing, you can enter up to 14 single-byte alphanumeric characters.

Assigned To :

Displays the name used to identify the projector is assigned to someone who can manage a network.

When editing, you can enter up to 14 single-byte alphanumeric characters.

Click  button to send and save the setting that you modify.

Projector's Network Configuration

DHCP Enabled	Assign an IP address to the projector from the DHCP server automatically.
IP Address	Set up IP Address when DHCP is disabled.
Subnet Mask	Set up Subnet Mask when DHCP is disabled.
Gateway	Set up Gateway when DHCP is disabled.
DNS Server	Set up DNS Server address when DHCP is disabled.

Click  button to send and save the setting that you modify.

Admin Password

Enabled	Turn ON administrative password function if selected.
New Password	Enter administrative password. (Max length: 15 characters).
Confirm Password	Re-enter administrative password.

Click  button to send and save the setting that you modify.

User Password

Enabled	Turn ON User password function if selected.
New Password	Enter administrative password. (Max length: 15 characters).
Confirm Password	Re-enter administrative password.

Click  button to send and save the setting that you modify.

Network Control Software Application

About the “Info” button :

Show current projector status from this page. Press exit button to leave this page.

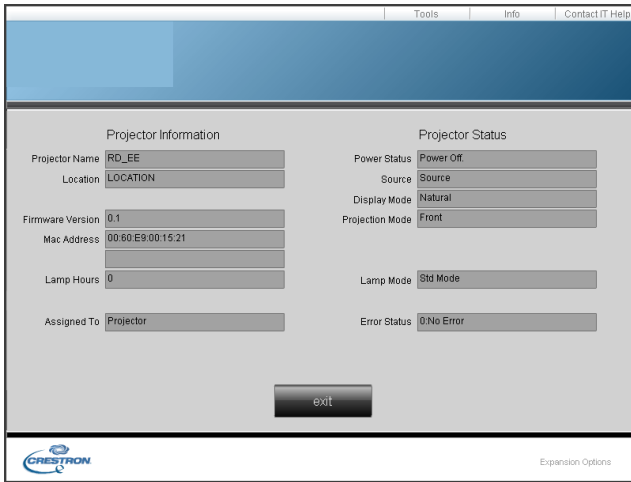

Click  button to leave this page.

About the “Contact IT Help” :



Click  to close Contact IT Help window dialog.

Click  to send the message to Crestron’s device and projector.

Logout : logging out of the projector network control.

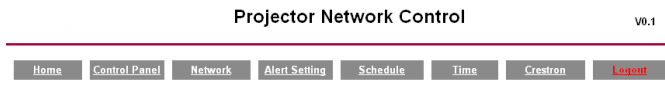

Logout

Please Refresh to re-login Network Control.

Maintenance of Projector

Filter

Keep the air filters clean by cleaning them periodically.

By using Filter Counter the projector can remind you of the timing.

There is black sponge attached just back side of the filter cover consists of a black frame.

How to clean or replace the filters

Turn off the projector, and unplug the power cord. Wait to allow the projector to cool down sufficiently.

1. Push up 2 white stoppers of the Filter cover and remove it from the side of projector as shown below.
2. Remove the sponge case from the projector by pull it front the right hand side.
3. Clean the filters with a vacuum cleaner except for the back side of the sponge, because the vacuum cleaner may suck it. Brush the sponge gently by a brush. (Do not clean the filters with water.)
4. Insert the filter parts to the side of the projector first and then close the Filter cover by pushing 2 white stoppers. Make sure that the Filter cover is well closed.
6. Reset the Filter Timer.(P.75)

1

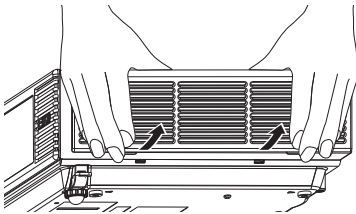

2

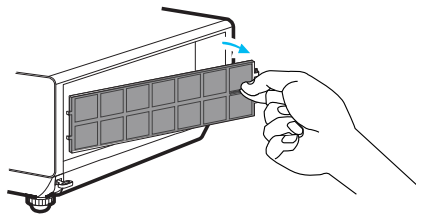

3

Sponge filter

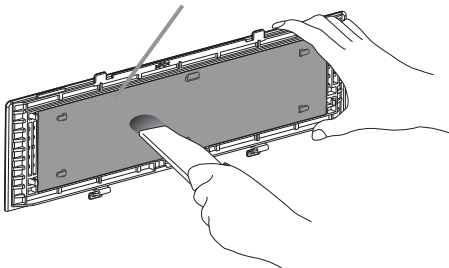

Maintenance of Projector

Lamp

Please turn off the projector and unplug the AC power cord. And then, let the projector cool down at least 60 minutes.

Replacing New Lamp

LC-XNB4000N Part Number:23040043

LC-XNB3500N Part Number:23040044

LC-WNB3000N Part Number:23040044

1. Remove the lamp door.
2. Loosen 2 screws of the lamp holder. Hold the handle on the top of the lamp, pull out the lamp straight off the projector.
3. Insert new lamp, lock the lamp door firmly with 2 screws.
4. Put the lamp door on.
5. Please reset the lamp timer after replacing lamp. (P.71)

When changing lamp, it is recommended that you change the filter at the same time.

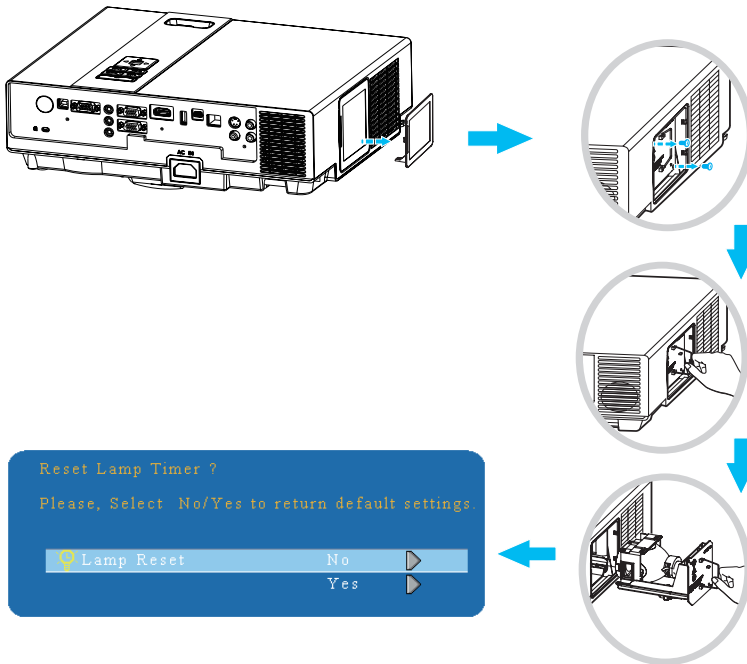

Maintenance of Projector

WARNING

The projector uses a high-pressure mercury lamp.

The explosion of lamp with a loud bang or burn out could possibly cause injury or a fire.

When the bulb burst, it is possible for shards of glass to fly into the lamp housing; and for gas containing mercury to escape from the projector's vent holes.

If the lamp has broken, do not check the inside of the projector. Please ventilate the room immediately.

Do not touch or bring your face close to the broken pieces since it might get into your eyes or mouth. In case of injury, seek medical advice immediately.

Disposal of a Lamp

Dispose of a lamp in accordance with the local recycling laws.

Do not put it to your trash.

Recycling Lamp's laws of the USA, go to www.lamprecycle.org.

Recycling Product's laws of USA, go to www.eiae.org.

Recycling Product's laws of Canada, go to www.epsc.ca.

For more information about recycling laws, please contact local government agency or dealer.

CAUTION HOT

Before replacing the Lamp part, pay attention to the following items:

1. The Lamp is optional part. Contact the dealer for replacement lamp.
2. The lamp becomes very hot when in use. Turn the power off and disconnect the power cord.
3. Wait 1 Hour before replacing the lamp.
4. Do not use old lamp part.

Additional

-In order to ensure the safe use of your projector, please contact your dealer to inspect about once a year.

-Before maintenance, make sure the power cable is unplugged, allow the projector to cool sufficiently. The high temperature state of the projector could cause a burn in and/or malfunction to the projector.

-Never try to maintain the inside of the projector by yourself.

Troubleshooting

Indicator

The power and lamp indicators show the status of the projector. Before requesting repair, check the projector status using the chart below. If the problem cannot be resolved, contact your dealer.

In normal status~~~

POWER	LAMP	CONDITIONS	DESCRIPTION
Blinking In Green	Off	Stand by mode	Projector is ready to be turned on.
Lighting In Green	Off	On mode	Projector is on and operating.
Lighting In Green	Blinking In Red (Slow)	Cool down mode	Projector is in cool down mode and will not respond to user input.
Lighting In Green	Blinking In Red (fast)	Cool down mode	When the projector is turned on in 2 minutes after it was turned off.

In abnormal status~~~

POWER	LAMP	CONDITIONS	DESCRIPTION
Blinking In Green	Blinking In Red (Fast)	Fan fault mode	The projector has detected a problem of a slow internal fan speed. The lamp will shut off automatically. Contact your dealer.
Blinking In Green	Lighting In Red	Lamp cover open	The lamp cover is open or there is a problem with the lamp. If the lamp door is closed and replacing the lamp does not correct the issue, contact your dealer.
Blinking In Green (Fast)	Blinking In Red (Fast)	High temperature	The projector has overheated and shut itself down. Correct the over temperature condition immediately. 1. Check that the ventilation slots are free from obstructions. 2. Check the cleanliness of the air filter.
Blinking In Green (Slow)	Blinking In Red (Slow)	Lamp fail	The lamp does not light. Come back to " stand by mode ", and press the power button.

Troubleshooting

Error For Machine Defects

The following problems may be confused with a machine defect. Check and follow the table. If it couldn't be improved, contact your dealer.

Symptom	Cause / Remedy
Projector power does not turn on.	The power cord is disconnected. Plug the power cord into an AC outlet.
	Intending to turn on the projector again during the cool down mode. Wait until the cool down mode has completed.
	There is no lamp and/or lamp cover is not firmly closed. Please turn off the power and disconnect the power plug from the power outlet. Check if the lamp is installed or the lamp cover is firmly closed and turn on the power again.
	Power cord has impaired. When you touch the power cord, the indicator goes on then off, please remove the power cord and connect it again. If the situation is repeated, remove the power cord and contact your dealer.
No image	The input is not connected correctly. Select the appropriate input source.
	No signal input. Connect correctly.
	The lens cover is attached to the lens. Remove the lens cover.
Colors are pale	Color density and color matching are not adjusted correctly. Adjust the RGB setting.
	Color lose. Caused by poor VGA cable connection.
Abnormal brightness & contrast	Brightness and contrast are not adjusted correctly. Adjust the brightness and contrast setting.
	The lamp is near the end of its service life. Replace with a new lamp.
Image is blurred	The projection lens is not focused. Adjust the focus using the focus ring.
	The lens is dirty or misty. Clean the lens.

Troubleshooting

Error For Machine Defects

Symptom	Cause / Remedy
No audio	The projector is not connected correctly. Check audio cable if connect correctly.
	The volume is set to minimum. Adjust the volume.
	Mute is turned on. Press the MUTE button.
Remote control is not working.	No battery. Before using the remote control, please check the battery of remote control.
	Remote signal is obstructed. Remove the obstacle between projector and remote control.

Troubleshooting

List of Supported Monitor Displays

Computer mode / HDMI table		
Signal	Refresh Rate (Hz)	Resolution (dots)
VGA	60	640x480
VESA	60 / 72 / 75 / 85	640x480
SVGA	56 / 60 / 72 / 75 / 85	800x600
XGA	60 / 70 / 75 / 85	1024x768
SXGA	70 / 75	1152x864
SXGA	60 / 75	1280x960
SXGA	60	1280x1024
WXGA	60 / 75	1280x800
WXGA+	60 / 75 / 85	1440x900
SXGA +	60 / 75	1400x1050
UXGA	60	1600x1200
WSXGA+	60	1680x1050
MAC	67	1280x1024 / 640x480
MAC	75	832x624
MAC	75	1024x768
MAC	75	1152x870
Component mode		
Signal	Refresh Rate (Hz)	Resolution (dots)
SDTV(480i / 576i)	30 / 25	720x480 / 720x576
SDTV(480p / 576p)	60 / 50	720x480 / 720x576
HDTV(720p)	60	1280x720
HDTV(1080i / 1080p)	30 / 60	1920x1080
Composite / S-Video		
Signal	Refresh Rate (Hz)	Resolution (dots)
TV(NTSC)	60	720x480
TV(PAL,SECAM)	50	720x576
HDMI		
Signal	Refresh Rate (Hz)	Resolution (dots)
SDTV(480P)	60	720x480
HDTV(720P)	60	1280x720
HDTV(1080i)	60	1920x1080
HDTV(1080P)	60	1920x1080

Appendix

Menu Tree (PC Mode)

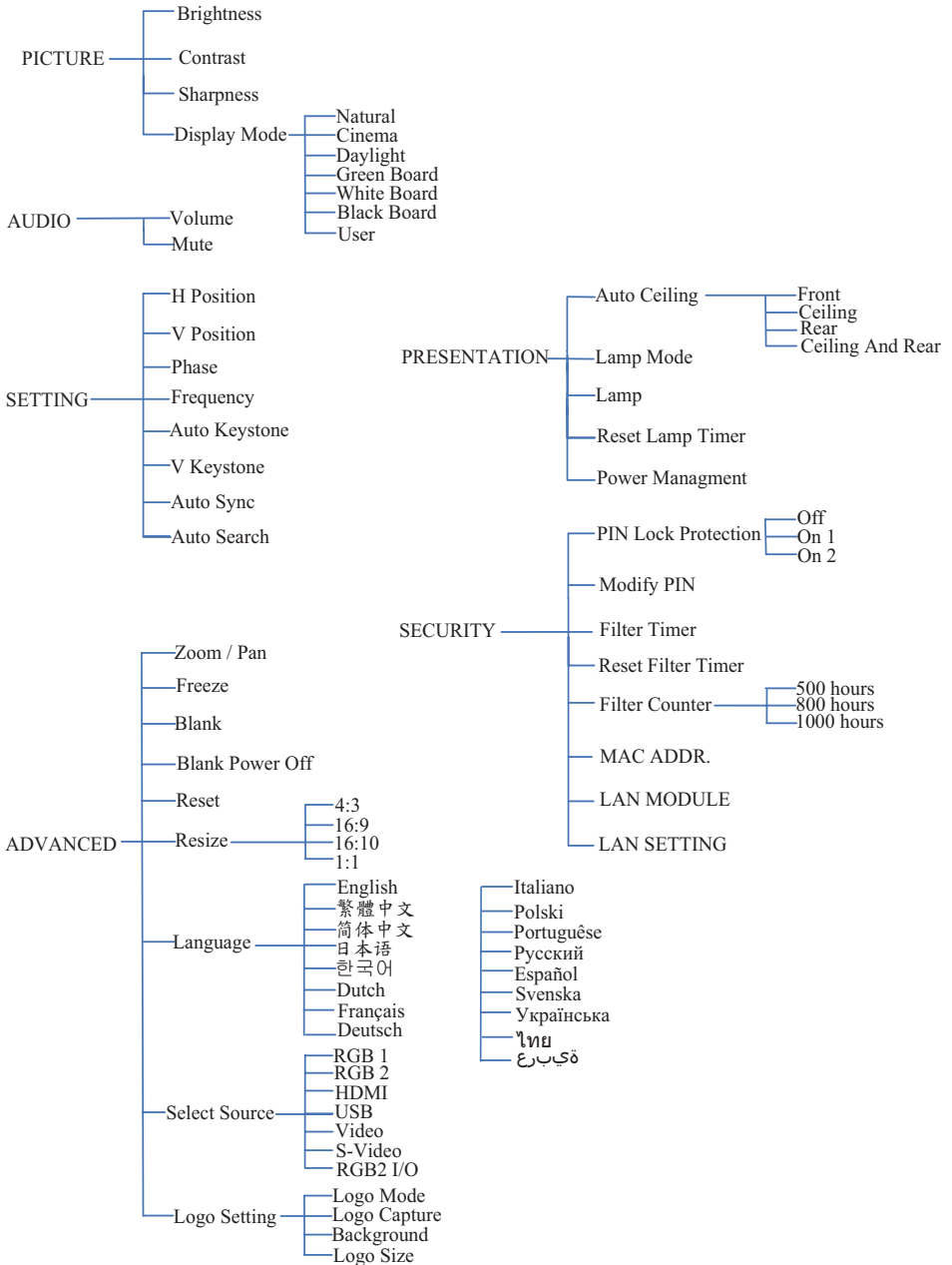

*DVI doesn't support H / V POSITION, PHASE, FREQUENCY, AUTO SYNC function.

Appendix

Menu Tree (Video Mode)

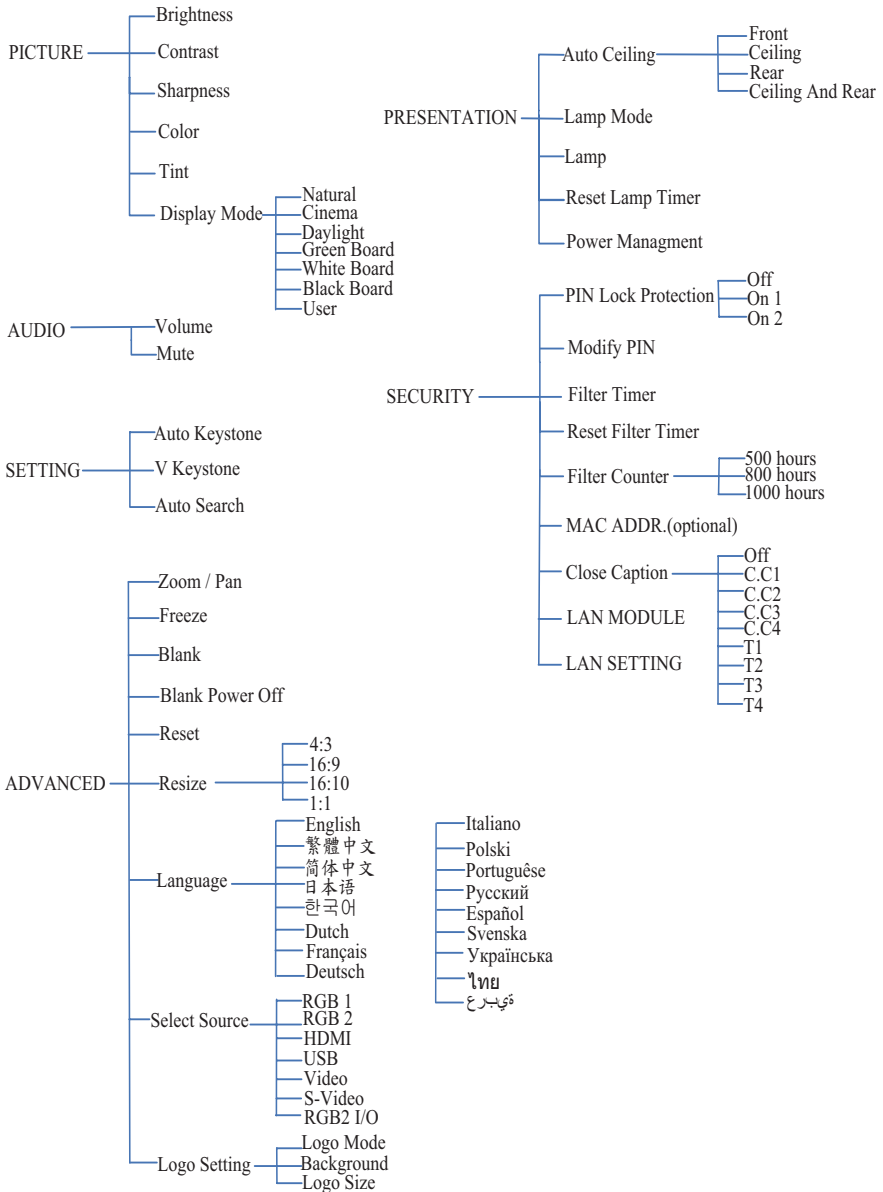

Appendix

Appearance

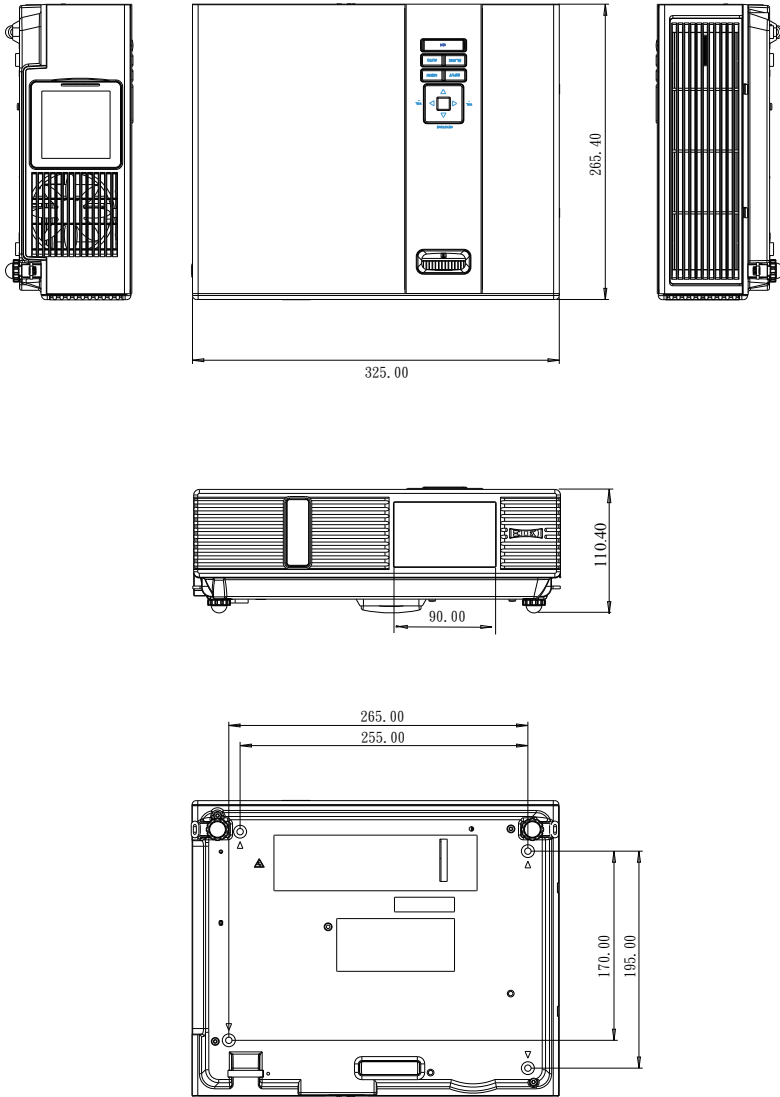

Screw for Ceiling Mounted M4x8mm 4pcs

Appendix

Configurations of Terminal

Analog RGB Input/Output

(1) Connections(15P HD-Sub)

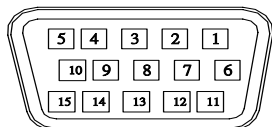

(2) Pin Number Define

Pin NO.	Signal Name	Connection
1	R signal Input	R
2	G signal Input	G/Sync. On G
3	B signal Input	B
4	N.C.	N.C.
5	GND	GND
6	R return(GND)	GND
7	G return(GND)	GND
8	B return(GND)	GND
9	N.C.	N.C.
10	N.C.	GND
11	Signal return(GND)	N.C.
12	DDC data	DDC/SDA
13	HSYNC/TTL/Comp.sync	H
14	VSYNC	V
15	DDC clock	DDC/SCL

(3) Connector

- 15P HD-Sub

(4) Input signal polarity

- Video signal (RGB): Positive
- Sync: Positive, Negative

(5)Input level

- Signal: 0.7V ±0.2V p-p 75Ω terminate, NRZ
- Sync: TTL

(6)Composite Sync.

- TTL:Negative

Appendix

HDMI

(1) Connections

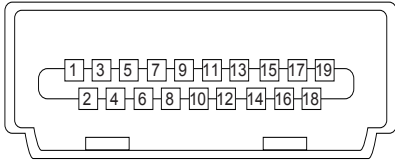

(2) Pin Number Define

Pin NO.	Signal Name	Pin NO.	Signal Name	Pin NO.	
1	TMDS Data 2+	9	TMDS Data 0-	17	Ground(DDC/CEC)
2	TMDS Data 2 (Ground)	10	TMDS Clock +	18	+5V POWER
3	TMDS Data 2-	11	TMDS Clock (Ground)	19	Hot plug detect
4	TMDS Data 1+	12	TMDS Clock		
5	TMDS Data 1 (Ground)	13	TMDS Data3+		
6	TMDS Data 1-	14	5V Power		
7	TMDS Data 0+	15	SCL		
8	TMDS Data 0 (Ground)	16	SDA		

Appendix

Composite Video Signal

(1) Connections



(2) Pin Number Define

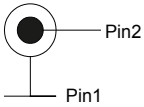

Pin NO.	Signal Name	Connection
1	Video Signal(GND)	GND
2	Video Input	V

(3) Connector: RCA jack

(4) Input signal polarity: Composite signal, Sync: Negative

(5) Input level: Video signal: $1.0V \pm 0.2V$ p-p 75Ω terminate, NRZ

Appendix

S-Video Signal

(1) S-Video Connections and Connector

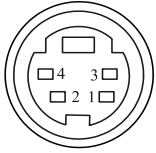

(2) Pin Number Define

Pin NO.	Signal Name	Connection
1	Y Signal(GND)	GND
2	C Signal(GND)	GND
3	Y Signal Input	Y
4	C Signal Input	C

(3) Input signal polarity

- Composite signal sync: Negative

(4)Input level

- Y Signal:1.0V \pm 0.2V p-p 75 Ω terminate, NRZ
- Sync:0.286V \pm 0.1V p-p
- Chromatic:75 Ω terminate, NRZ
- Burst:0.286V \pm 20%

Appendix

RS232 Control

Communication Protocol

Items	Specification
Standard Baud rate	9600 bps
Data length	8 bits
Parity	None
Stop bit	1 bit
Flow Control	None

RS232 Cable Define

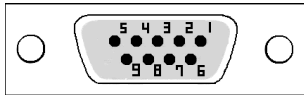

PC Side	Projector side with D-Sub Pin
RX 2	2 RX
TX 3	3 TX
GND 5	5 GND

LC-XNB4000N Technical Specifications

Mechanical Information

Projector Type	Normal-Throw Multimedia Projector
Dimensions(WxHxD)	325 x 110 x 265 mm
Net Weight	3.4 kg
Feet Adjustment	up to 8.5°

Panel Resolution

LCD Panel System	0.63" TFT LCD Panel, 3 panels
Panel Resolution	1,024 x 768 dots
Number of Pixels	2,359,296 (1,024 x 768 x 3 panels)

Signal Compatibility

Color System	PAL, SECAM, NTSC
SD/HD TV Signal	480i, 480p, 575i, 575p, 720p, 1080i and 1080p
Input Scanning Frequency	H-sync. 31~92kHz, V-sync. 48~120Hz

Optical Information

Projection Image Size	40"~300" Diagonal
Throw Distance	Wide: 1.14 ~ 8.76M Tele: 1.73 ~ 10.53M
Projection Lens	F=1.6 ~ 1.9 / f=18.5 ~22.2 mm
Projection Lamp	245W Lamp
Brightness	4000 lm

Interface

Input Terminals	D-SUB 15 pin x 1 HDMI x 1 Composite Video, RCA x 1 S-Video, Mini Din-4 x 1 Component Video, RCA x 3 3.5mm Mini-Stereo Audio Jack x 2 Audio RCA (Right /Left) x 2 USB-A x 1 Mini USB x 1
Output Terminals	D-SUB 15 pin x 1 3.5mm Mini-Stereo Audio Jack x 1
Control Terminals	RS232 DB-9 x 1 RJ45 x 1

Audio

Speaker	10W mono speaker built-in
---------	---------------------------

Power

Voltage and Power Consumption	AC100~240V, 50/60Hz(full range)
-------------------------------	---------------------------------

Operating Environment

Operating Temperature	5°C~35°C / 41°F~95°F
Storage Temperature	-20°C~50°C / -4°F~122°F

•The specifications are subject to change without notice.

LC-XNB3500N Technical Specifications

Mechanical Information

Projector Type	Normal-Throw Multimedia Projector
Dimensions(WxHxD)	325 x 110 x 265 mm
Net Weight	3.4 kg
Feet Adjustment	up to 8.5°

Panel Resolution

LCD Panel System	0.63" TFT LCD Panel, 3 panels
Panel Resolution	1,024 x 768 dots
Number of Pixels	2,359,296 (1,024 x 768 x 3 panels)

Signal Compatibility

Color System	PAL, SECAM, NTSC
SD/HD TV Signal	480i, 480p, 575i, 575p, 720p, 1080i and 1080p
Input Scanning Frequency	H-sync. 31~92kHz, V-sync. 48~120Hz

Optical Information

Projection Image Size	40"~300" Diagonal
Throw Distance	Wide: 1.14 ~ 8.76M Tele: 1.73 ~ 10.53M
Projection Lens	F=1.6 ~ 1.9 / f=18.5 ~22.2 mm
Projection Lamp	240W Lamp
Brightness	3500 lm

Interface

Input Terminals	D-SUB 15 pin x 1 HDMI x 1 Composite Video, RCA x 1 S-Video, Mini Din-4 x 1 Component Video, RCA x 3 3.5mm Mini-Stereo Audio Jack x 2 Audio RCA (Right /Left) x 2 USB-A x 1 Mini USB x 1
Output Terminals	D-SUB 15 pin x 1 3.5mm Mini-Stereo Audio Jack x 1
Control Terminals	RS232 DB-9 x 1 RJ45 x 1

Audio

Speaker	10W mono speaker built-in
---------	---------------------------

Power

Voltage and Power Consumption	AC100~240V, 50/60Hz(full range)
-------------------------------	---------------------------------

Operating Environment

Operating Temperature	5°C~35°C / 41°F~95°F
Storage Temperature	-20°C~50°C / -4°F~122°F

•The specifications are subject to change without notice.

Appendix

LC-WNB3000N Technical Specifications

Mechanical Information

Projector Type	Normal-Throw Multimedia Projector
Dimensions(WxHxD)	325 x 110 x 265 mm
Net Weight	3.4 kg
Feet Adjustment	up to 8.5°

Panel Resolution

LCD Panel System	0.59" TFT LCD Panel, 3 panels
Panel Resolution	1,280 x 800 dots
Number of Pixels	3,072,000 (1,280 x 800 x 3 panels)

Signal Compatibility

Color System	PAL, SECAM, NTSC
SD/HD TV Signal	480i, 480p, 575i, 575p, 720p, 1080i and 1080p
Input Scanning Frequency	H-sync. 31~92kHz, V-sync. 48~120Hz

Optical Information

Projection Image Size	40"~300" Diagonal
Throw Distance	Wide: 1.21 ~ 9.29M Tele: 1.83 ~ 9.29M
Projection Lens	F=1.6 ~ 1.9 / f=18.5 ~22.2 mm
Projection Lamp	240W Lamp
Brightness	3000 lm

Interface

Input Terminals	D-SUB 15 pin x 1 HDMI x 1 Composite Video, RCA x 1 S-Video, Mini Din-4 x 1 Component Video, RCA x 3 3.5mm Mini-Stereo Audio Jack x 2 Audio RCA (Right /Left) x 2 USB-A x 1 Mini USB x 1
Output Terminals	D-SUB 15 pin x 1 3.5mm Mini-Stereo Audio Jack x 1
Control Terminals	RS232 DB-9 x 1 RJ45 x 1

Audio

Speaker	10W mono speaker built-in
---------	---------------------------

Power

Voltage and Power Consumption	AC100~240V, 50/60Hz(full range)
-------------------------------	---------------------------------

Operating Environment

Operating Temperature	5°C~35°C / 41°F~95°F
Storage Temperature	-20°C~50°C / -4°F~122°F

•The specifications are subject to change without notice.