



GPI0

Ultra Lite LED Projector

User Manual

Table of contents

Important safety instructions 3

Introduction..... 6

Projector features.....	6
Shipping contents.....	7
Projector exterior view.....	8
Controls and functions.....	9

Positioning your projector 14

Obtaining a preferred projected image size.....	14
---	----

Connection 16

Connecting the power.....	16
Connecting the DVD player.....	16
Connecting a computer.....	17
Connecting Video source devices.....	19
Connecting an HDMI source device..	20
Connecting a Component Video source device.....	21
Connecting a composite Video source device.....	22
Connecting an external speaker.....	23
Connecting to an external memory device.....	24
Playing sound through the projector..	25

Operation 26

Starting up the projector.....	26
Switching input signal.....	26
Adjusting the projected image.....	27
Hiding the image.....	28
Securing the projector.....	29
Firmware upgrade.....	31

Selecting the aspect ratio.....	31
Optimizing the image.....	32
Operating in a high altitude environment.....	34
Adjusting the sound.....	34
Displaying images with PC and Video source devices.....	36
Using PC/ Video pop-up menus.....	37
Displaying files with internal memory, USB Drive and SD card.....	39
Using USB streaming.....	51
Using wireless streaming.....	53
Using settings menu.....	60
Shutting down the projector.....	65

Maintenance 66

Care of the projector.....	66
----------------------------	----

Troubleshooting..... 68

Specifications..... 69

Projector specifications.....	69
Dimensions.....	70
Timing chart.....	71

Warranty and Copyright information..... 74

Important safety instructions

Your projector is designed and tested to meet the latest standards for safety of information technology equipment. However, to ensure safe use of this product, it is important that you follow the instructions mentioned in this manual and marked on the product.

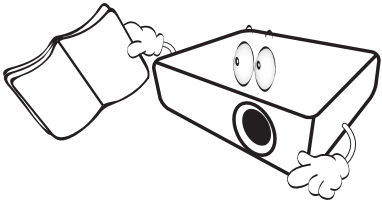
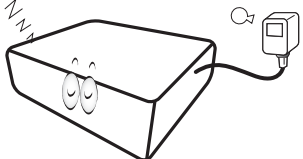
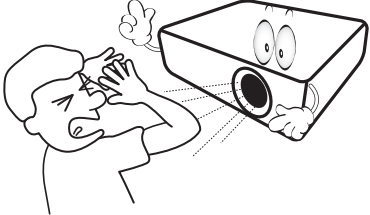
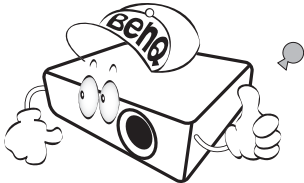
Safety Instructions	
<p>1. Please read this manual before you operate your projector. Save it for future reference.</p>	<p>4. In some countries, the line voltage is NOT stable. This projector is designed to operate safely within a mains voltage of 19 volts DC, but could fail if power cuts or surges of ± 10 volts occur. In areas where the mains voltage may fluctuate or cut out, it is recommended that you connect your projector through a power stabilizer, surge protector or uninterruptible power supply (UPS).</p>
 <p>2. Do not look straight at the projector lens during operation. The intense light beam may damage your eyes.</p>	
 <p>3. Refer servicing to qualified service personnel.</p>	<p>5. Do not block the projection lens with any objects when the projector is under operation as this could cause the objects to become heated and deformed or even cause a fire.</p>
	

Safety Instructions (Continued)

6. Never replace any electronic components unless the projector is unplugged.

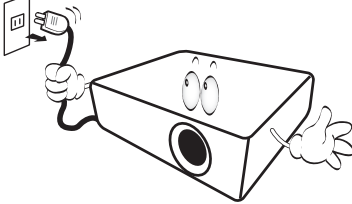

7. Do not place this product on an unstable cart, stand, or table. The product may fall, sustaining serious damage.

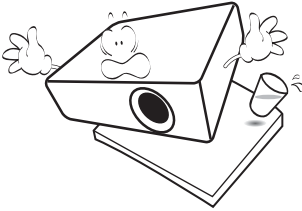

8. Do not attempt to disassemble this projector. There are dangerous high voltages inside which may cause death if you should come into contact with live parts. Refer servicing only to suitably qualified professional service personnel.

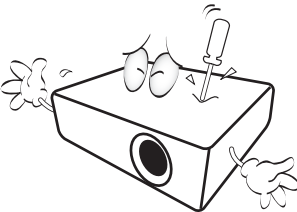

9. When the projector is under operation, you may sense some heated air and odor from its ventilation grill. It is a normal phenomenon and not a product defect.

10. Do not place this projector in any of the following environments.

- Space that is poorly ventilated or confined. Allow at least 50 cm clearance from walls and free flow of air around the projector.
- Locations where temperatures may become excessively high, such as the inside of a car with all windows rolled up.
- Locations where excessive humidity, dust, or cigarette smoke may contaminate optical components, shortening the projector's life span and darkening the image.

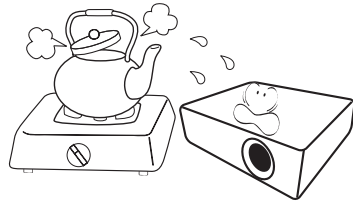

Safety Instructions (Continued)

- Locations near fire alarms
- Locations with an ambient temperature above 40°C / 104°F
- Locations where the altitudes are higher than 3000 m (10000 feet).

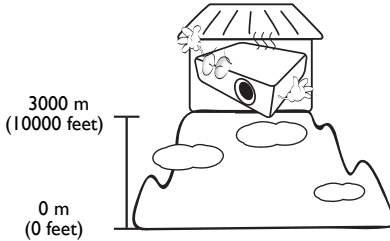

11. Do not block the ventilation holes.
- Do not place this projector on a blanket, bedding or any other soft surface.
 - Do not cover this projector with a cloth or any other item.
 - Do not place inflammables near the projector.



If the ventilation holes are seriously obstructed, overheating inside the projector may result in a fire.

12. Always place the projector on a level, horizontal surface during operation.

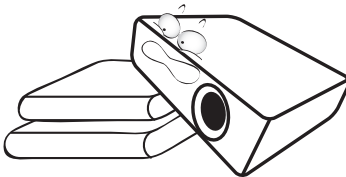

13. Do not stand the projector on end vertically. Doing so may cause the projector to fall over, causing injury or resulting in damage to the projector.

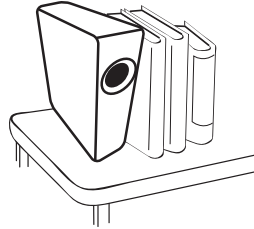

14. Do not step on the projector or place any objects upon it. Besides probable physical damage to the projector, doing so may result in accidents and possible injury.

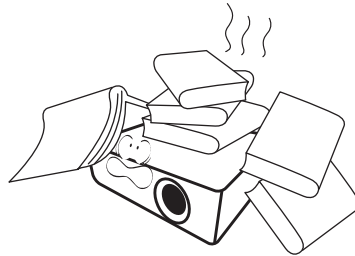

15. Do not place liquids near or on the projector. Liquids spilled into the projector may cause it to fail. If the projector does become wet, disconnect it from the power supply's wall socket and call BenQ to have the projector serviced.

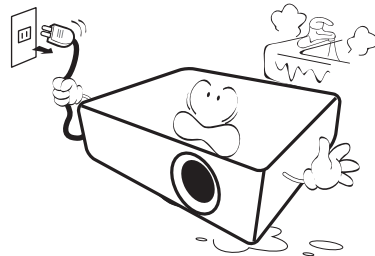

Introduction

Projector features

The projector integrates high-performance optical engine projection and a user-friendly design to deliver high reliability and ease of use.

The projector offers the following features.

- **Advanced LED light source**
Long lasting LEDs provides a longer life span than traditional lamps.
- **Optical engine with DLP technologies**
WXGA resolution and a bright picture.
- **Various useful features**
Supports iPhone/iPod player, multimedia player, document viewer, internal memory, SD card, USB flash drive, and USB display
- **Easy to carry**
The projector is small and light, making it useful for business trips and leisure activities. You can view documents, videos and photos anywhere.
- **Multiple input ports**
Multiple input ports, including PC, AV, HDMI, USB, and SD card provide flexible connectivity with peripheral devices.
- **Audio input & output**
Equipped with 3W x 2 speakers with RCA & mini-jack input ports and phone jack output port
- **Convenient menu items**
Friendly menu is used for all types of inputs, making the projector easy to use.
- ☞ • **The apparent brightness of the projected image will vary depending on the ambient lighting conditions, selected input signal contrast/brightness settings, and is proportional to projection distance.**
- **The lamp brightness will decline over time and may vary within the lamp manufacturers specifications. This is normal and expected behavior.**

Shipping contents

Carefully unpack and verify that you have all of the items shown below. If any of these items are missing, please contact your place of purchase.

Standard accessories

 The supplied accessories will be suitable for your region, and may differ from those illustrated.

*The warranty card is only supplied in some specific regions. Please consult your dealer for detailed information.

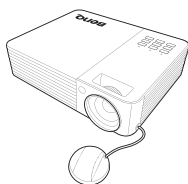

Projector

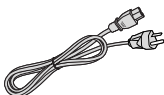

Power cord

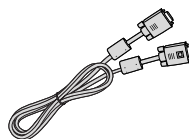

VGA cable



Quick start guide



Warranty card*



Projector carrying bag

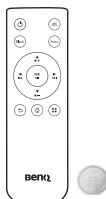

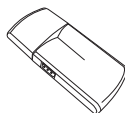

Remote control with
battery

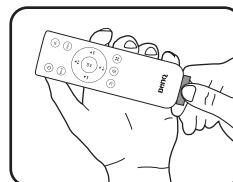

Wi-Fi dongle

 Pull the tab before using the remote control.



 User manual is inside the Projector device internal memory. Please use **USB** cable to link **PC/ Notebook** and Projector device. In main UI page, choose "**USB streaming**" > "**USB File transfer**". Meanwhile, projector device will be treated as external storage and you can access **UM** via **PC/Notebook**.

Optional accessories

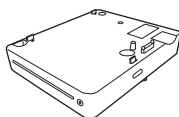

DVD Player

Projector exterior view

Front/upper side

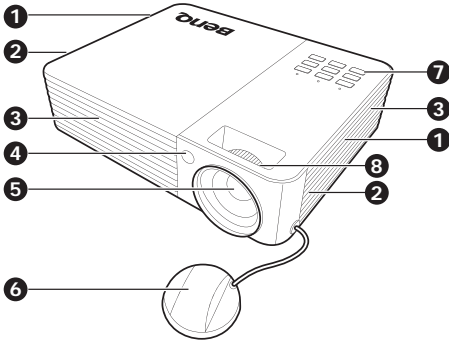

Rear/lower side

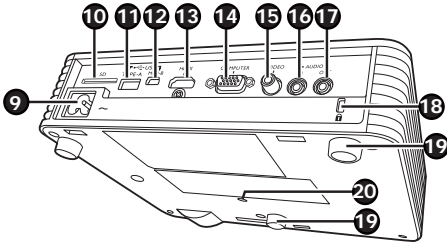

1. Vent (cold air intake)
2. Internal Speakers
3. Vent (heated air exhaust)
4. Front IR remote sensor
5. Projection lens
6. Lens cover
7. External control panel
(See "Projector" on page 9 for details.)
8. Focus ring
9. AC power jack
10. SD card slot
11. Type A USB jack
12. Mini-B USB jack
13. HDMI input jack
14. RGB (PC)/Component Video (YPbPr/ YCbCr) signal input jack
15. Video input jack
16. Audio input jack
17. Audio output jack
18. Kensington anti-theft lock slot
19. Adjuster feet
20. Tripod socket

 **Do not block the ventilation openings. Blocking the ventilation openings can cause your projector to overheat and may cause it to fail.**

Controls and functions

Projector

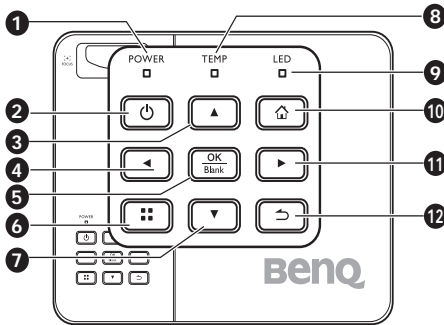

1. POWER indicator light

Lights up or flashes when the projector is under operation.

2. Power

Toggles the projector between standby mode and on.

See ["Starting up the projector" on page 26](#) and ["Shutting down the projector" on page 65](#) for details.

3. Up/Volume up key

When the On-Screen Display (OSD) menu is on:

- Navigate up to select the desired menu items.
- Make adjustments. (e.g. manual keystone...)

When the On-Screen Display (OSD) menu is off: (Only applied to SD card, internal memory and USB Drive)

- Magnifies the volume level.

4. Left key

When the On-Screen Display (OSD) menu is on:

- Navigate left to select the desired menu items.
- Make adjustments. (e.g. brightness, contrast...)

When the On-Screen Display (OSD) menu is off: (Only applied to SD card, internal memory and USB Drive)

- Play previous video and audio file.
- Press and hold to rewind video and audio file.

5. OK/Blank

Short press:

- Confirms a selected function when a menu is displayed.
- Plays or pauses a video, music, photo slideshow. (Only applied to SD card, internal memory and USB Drive)

Long press (3 seconds):

Toggles the Blank.

6. Menu

Turns on the Pop-up setting menu.

7. Down/Volume down key

When the On-Screen Display (OSD) menu is on:

- Navigate to down to select the desired menu items.
- Make adjustments. (e.g. manual keystone...)

When the On-Screen Display (OSD) menu is off: (Only applied to SD card, internal memory and USB Drive)

- Reduces the volume level.

8. TEMPerature indicator light

Lights up red if the projector's temperature becomes too high.

9. LED indicator light

Indicates the status of the light source.

Lights up or flashes when the light source has developed a problem.

10. Home

Directly returns to home screen from lower level of OSD.

Exits application/pop-up message and back to home screen directly.

11. Right key

When the On-Screen Display (OSD) menu is on:

- Navigate right to select the desired menu items.
- Make adjustments. (e.g. brightness, contrast...)

When the On-Screen Display (OSD) menu is off: (Only applied to SD card, internal memory and USB Drive)

- Play next video and audio file.
- Press and hold to fast forward video and audio file.

12. Back

Goes back to previous OSD menu, exits and saves menu settings.

Remote control

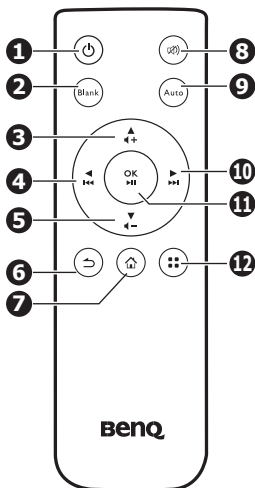

1. POWER

Toggles the projector between standby mode and on. See ["Starting up the projector" on page 26](#) and ["Shutting down the projector" on page 65](#) for details.

2. Blank

Toggles Blank on and off. See ["Hiding the image" on page 28](#) for details.

3. Up/Volume up key

When the On-Screen Display (OSD) menu is on:

- Navigate up to select the desired menu items.
- Make adjustments. (e.g. manual keystone...)

When the On-Screen Display (OSD) menu is off: (Only applied to SD card, internal memory and USB Drive)

- Magnifies the volume level.

4. Left key

When the On-Screen Display (OSD) menu is on:

- Navigate left to select the desired menu items.
- Make adjustments. (e.g. brightness, contrast...)

When the On-Screen Display (OSD) menu is off: (Only applied to SD card, internal memory and USB Drive)

- Play previous video and audio file.
- Press and hold to rewind video and audio file.

5. Down/Volume down key

When the On-Screen Display (OSD) menu is on:

- Navigate to down to select the desired menu items.
- Make adjustments. (e.g. manual keystone...)

When the On-Screen Display (OSD) menu is off: (Only applied to SD card, internal memory and USB Drive)

- Reduces the volume level.

6. Back

Returns to upper level of OSD.
Closes pop-up setting menu of OSD.
Leave current application of OSD.

7. Home

Directly returns to home screen from lower level of OSD.
Exits application/pop-up message and back to home screen directly.

8. Mute

Toggles projector audio between on and off.

9. Auto

Automatically determines the best picture timings for the displayed computer image. See ["Auto-adjusting the image" on page 27](#) for details.

10. Right key

When the On-Screen Display (OSD) menu is on:

- Navigate right to select the desired menu items.
- Make adjustments. (e.g. brightness, contrast...)

When the On-Screen Display (OSD) menu is off: (Only applied to SD card, internal memory and USB Drive)

- Play next video and audio file.
- Press and hold to fast forward video and audio file.

11. OK

Confirms a selected function when a menu is displayed.

Plays or pauses a video, music, photo slideshow. (Only applied to SD card, internal memory and USB Drive)

12. Menu

Turns on the Pop-up setting menu.

Remote control effective range

Infra-Red (IR) remote control sensor is located on the front of the projector. The remote control must be held at an angle within 15 degrees perpendicular to the projector's IR remote control sensor to function correctly. The distance between the remote control and the sensor should not exceed 7 meters (~ 23 feet).

Make sure that there are no obstacles between the remote control and the IR sensor on the projector that might obstruct the infra-red beam.

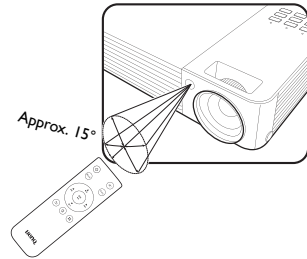

Replacing the remote control battery

1. Pull out the battery holder.

 Please follow the illustrated instructions. Push and hold the locking arm while pulling out the battery holder.

2. Insert the new battery in the holder. Note the positive polarity should face outward.

3. Push the holder into the remote control.



• **Avoid excessive heat and humidity.**

• **There may be battery damage if the battery is incorrectly replaced.**

• **Replace only with the same or equivalent type recommended by the battery manufacturer.**

• **Dispose of the used battery according to the battery manufacturer's instructions.**

• **Never throw a battery into a fire. There may be danger of an explosion.**

• **If the battery is dead or if you will not be using the remote control for a long time, remove the battery to prevent damage to the remote control from possible battery leakage.**

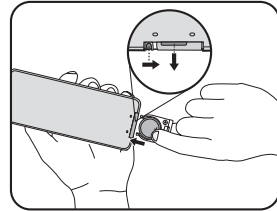

Positioning your projector

Obtaining a preferred projected image size

The distance from the projector lens to the screen, the zoom setting (if available), and the video format each factors in the projected image size.

16:10 is the native aspect ratio of this projector.

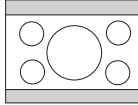

16:10 aspect image scaled to a 4:3 aspect display area

The projector should always be placed horizontally level (like flat on a table), and positioned directly perpendicular (90° right-angle square) to the horizontal center of the screen. This prevents image distortion caused by angled projections (or projecting onto angled surfaces).

The modern digital projector does not project directly forward (like older style reel-to-reel film projectors did). Instead, digital projectors are designed to project at a slightly upward angle above the horizontal plane of the projector. This is so that they can be readily placed on a table and will project forward and upwards onto a screen positioned so that the bottom edge of the screen is above the level of the table (and everyone in the room can see the screen).

If the projector is mounted on a ceiling, it must be mounted upside-down so that it projects at a slightly downward angle.

You can see from the diagram on page 15, that this type of projection causes the bottom edge of the projected image to be vertically offset from the horizontal plane of the projector. When ceiling mounted, this refers to the top edge of the projected image.

If the projector is positioned further away from the screen, the projected image size increases, and the vertical offset also increases proportionately.

When determining the position of the screen and projector, you will need to account for both the projected image size and the vertical offset dimension, which are proportional to the projection distance.

BenQ has provided a table of screen size to assist you in determining the ideal location for your projector. Refer to "[Projection dimensions](#)" on page 15 depending on the projector you are using. There are two dimensions to consider, the perpendicular horizontal distance from the center of the screen (projection distance), and the vertical offset height of the projector from the horizontal edge of the screen (offset).

Projection dimensions

Refer to "Dimensions" on page 70 for the center of lens dimensions of this projector before calculating the appropriate position.

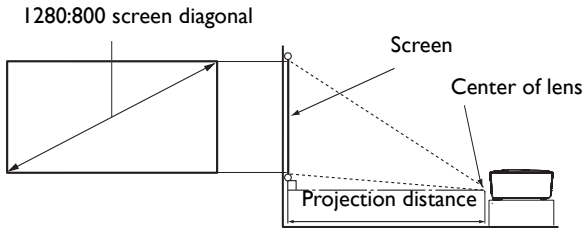

Screen Size				Projection distance in mm
Diagonal		W (mm)	H (mm)	
Inches	mm			
30	762	646	404	750
40	1016	862	538	1000
50	1270	1077	673	1250
60	1524	1292	808	1500
80	2032	1723	1077	2000
100	2540	2154	1346	2500
120	3048	2585	1615	3000
150	3810	3231	2019	3750
200	5080	4308	2692	5000
220	5588	4739	2962	5500
250	6350	5385	3365	6250
300	7620	6462	4039	7500

 All measurements are approximate and may vary from the actual sizes. BenQ recommends that if you intend to permanently install the projector, you should physically test the projection size and distance using the actual projector in situ before you permanently install it, so as to make allowance for this projector's optical characteristics. This will help you determine the exact mounting position so that it best suits your installation location.

Connection

 In the connections shown below, some cables may not be included with the projector (see "Shipping contents" on page 7). They are commercially available from electronics stores.

Connecting the power

1. Insert one end of the provided power cord into the AC IN terminal.
2. Insert the plug on the power cord into a wall outlet. Check that the Power LED indicator on the projector lights orange when using the AC adapter.

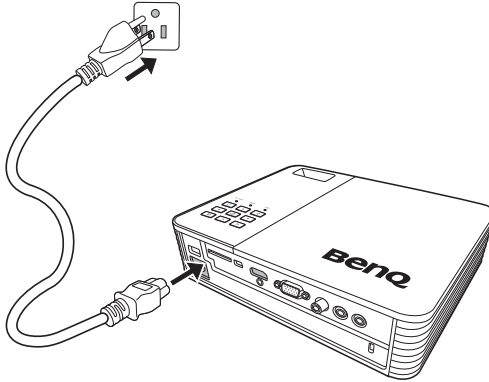

Connecting the DVD player

1. Take the DVD player (optional) and connect it to the projector as illustrated below.
2. Connect the projector power and insert the disc.
3. Turn on the projector and press ◀/▶ to select DVD and press **OK** to connect.
4. Use the remote control for the DVD player to operate the DVD player.
5. To disconnect the DVD player, remove the disc. And press the button on the front of the DVD player while removing the DVD player from the projector.

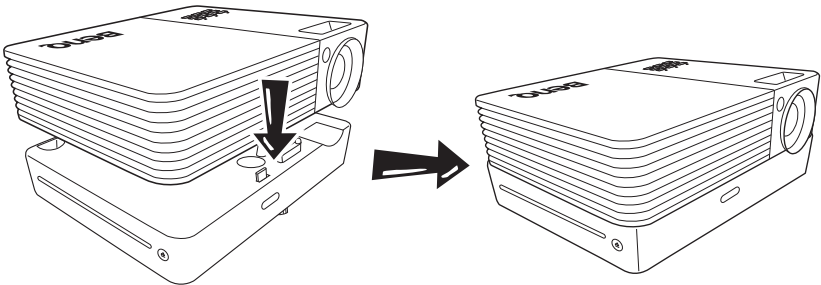

-  • The projector automatically starts the disc when it is inserted.
- The DVD player supports hot-plugging function. You can connect or disconnect the DVD player while the projector is turned on.

Connecting a computer

The projector provides a VGA input socket that allows you to connect it to both IBM® compatibles and Macintosh® computers. A Mac adapter is needed if you are connecting legacy version Macintosh computers.

To connect the projector to a notebook or desktop computer:

- Using a VGA cable
1. Take the supplied VGA cable and connect one end to the D-Sub output socket of the computer.
 2. Connect the other end of the VGA cable to the **COMPUTER** socket on the projector.
 3. If you wish to make use of the projector speaker, take a suitable audio cable and connect one end of the cable to the audio output socket of the computer, and the other end to the audio input socket on the projector.

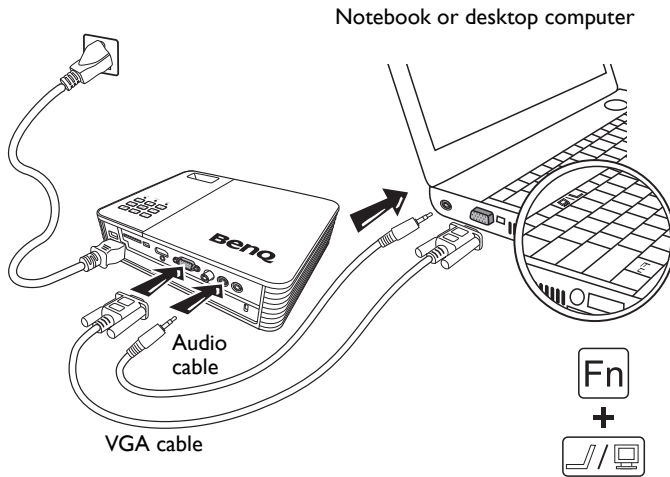

Many notebooks do not turn on their external video ports when connected to a projector. Usually a key combo like FN + F3 or CRT/LCD key turns the external display on/off. Locate a function key labeled CRT/LCD or a function key with a monitor symbol on the notebook. Press FN and the labeled function key simultaneously. Refer to your notebook's documentation to find your notebook's key combination.

- Using an HDMI cable

1. Take an HDMI cable and connect one end to the HDMI output jack of the computer.
2. Connect the other end of the HDMI cable to the HDMI jack on the projector.

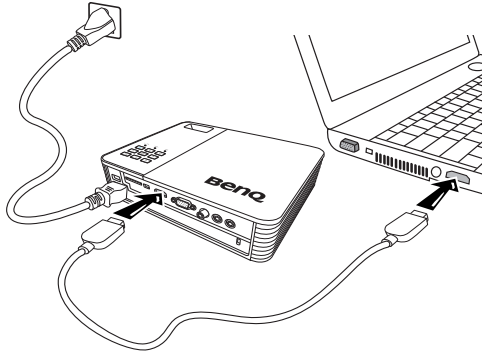

- Using a USB cable

1. Take a USB cable and connect the type A end to the USB output jack of the computer.
2. Connect the mini-B type end of the USB cable to the mini-B USB jack on the projector. When you connect the projector to a computer, you can display computer's image or transfer files from your computer to the internal memory of the projector.

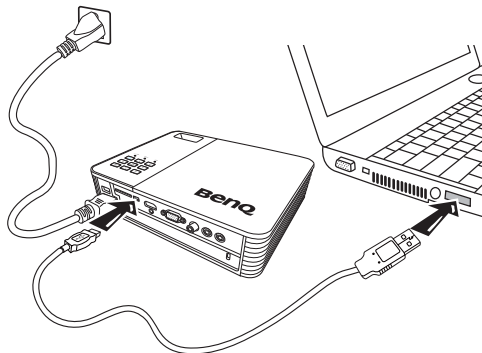

3. If you select USB Display, follow the on-screen message to install the USB driver in your computer first.
4. If you select USB File Transfer, go to My Computer or Windows Explorer to access the projector's files. The projector appears as a Removable Disk. Transfer the files from your computer to the projector by dragging and dropping or copying and pasting.

To disconnect the projector from a computer:

- i. Click  on the Windows Taskbar.
- ii. Click the pop-up message.





- iii. Disconnect the USB cable only when the message says that it is safe to remove the hardware.

- ☞ • **Do not disconnect the USB cable while the files are being copied, as this could result in loss of data or damage to the projector.**
- **The connection will not end if you have projector files open on the computer. Close all projector files and try again.**
- **Other versions of Windows operate similarly. Follow the correct procedure for removing a USB device from your computer safely for your version of Windows.**

Connecting Video source devices

You need only connect the projector to a Video source device using just one of the above connecting methods, however each provides a different level of video quality. The method you choose will most likely depend upon the availability of matching terminals on both the projector and the Video source device as described below:

Terminal name	Terminal appearance	Picture quality
HDMI	HDMI 	Best
Component Video	VGA 	Better
Video	Video 	Good

- ☞ **If the selected video image is not displayed after the projector is turned on and the correct video source has been selected, check that the Video source device is turned on and operating correctly. Also check that the signal cables have been connected correctly.**

Connecting an HDMI source device

The projector provides a HDMI input jack that allows you to connect it to an HDMI source device like a Blu-Ray player, a DTV tuner or a display.

HDMI (High-Definition Multimedia Interface) supports uncompressed video data transmission between compatible devices like DTV tuners, Blu-Ray player and displays over a single cable. It provides pure digital viewing and listening experience.

Examine your Video source device to determine if it has a set of unused HDMI output jacks available:

- If so, you can continue with this procedure.
- If not, you will need to reassess which method you can use to connect to the device.

To connect the projector to an HDMI source device:

1. Take an HDMI cable and connect one end to the HDMI output jack of the HDMI source device.
2. Connect the other end of the HDMI cable to the **HDMI** jack on the projector.

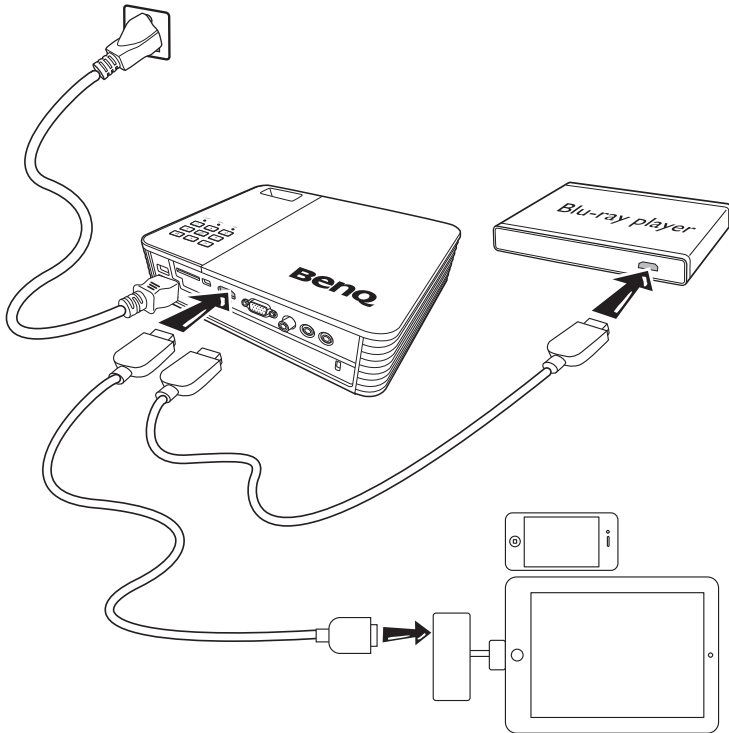

- The HDMI cable (shown in this example) for connection your video output device is not supplied as standard.
- The Apple Digital AV Adapter can be purchased from www.apple.com.

Connecting a Component Video source device

Examine your Video source device to determine if it has a set of unused Component Video output sockets available:

- If so, you can continue with this procedure.
- If not, you will need to reassess which method you can use to connect to the device.

To connect the projector to a Component Video source device:

1. Take a Component Video to VGA (D-Sub) adaptor cable and connect the end with 3 RCA type connectors to the Component Video output sockets of the Video source device. Match the color of the plugs to the color of the sockets; green to green, blue to blue, and red to red.
2. Connect the other end to the **COMPUTER** socket on the projector.
3. If you wish to make use of the projector speaker, take a suitable audio cable and connect one end of the cable to the audio output sockets of the Video source device, and the other end to the audio input socket on the projector.

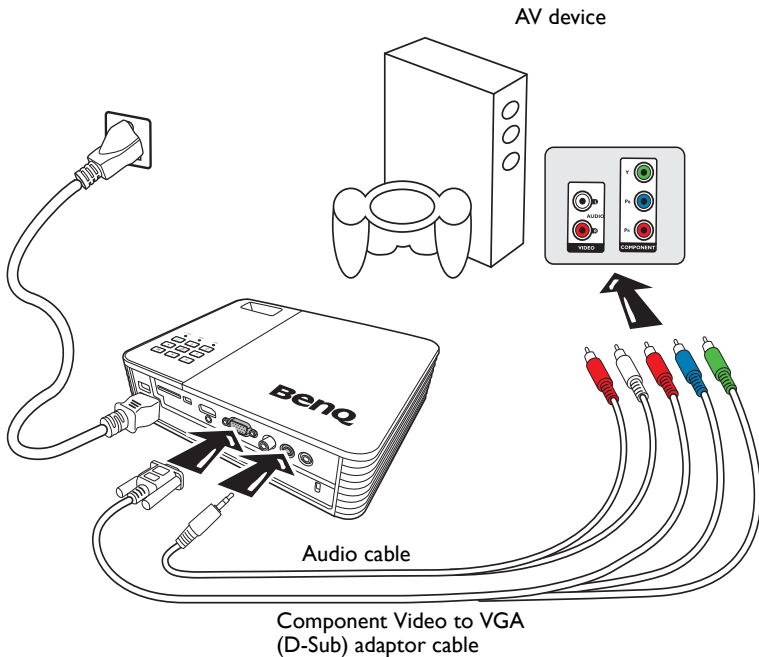

- ☞ • **When audio output jack is connected with the earphone or external speaker, the sound will not come out from the projector speaker.**
- **No sound will come out from the speaker or audio output jack if video signals are not input. Besides, the sound cannot be adjusted either.**

Connecting a composite Video source device

Examine your Video source device to determine if it has a set of unused composite Video output sockets available:

- If so, you can continue with this procedure.
- If not, you will need to reassess which method you can use to connect to the device.

To connect the projector to a composite Video source device:

1. Take a Video cable and connect one end to the composite Video output socket of the Video source device.
2. Connect the other end of the Video cable to the Video jack on the projector.
3. If you wish to make use of the projector speaker, take a suitable audio cable and connect one end of the cable to the audio output sockets of the Video source device, and the other end to the audio input socket on the projector.

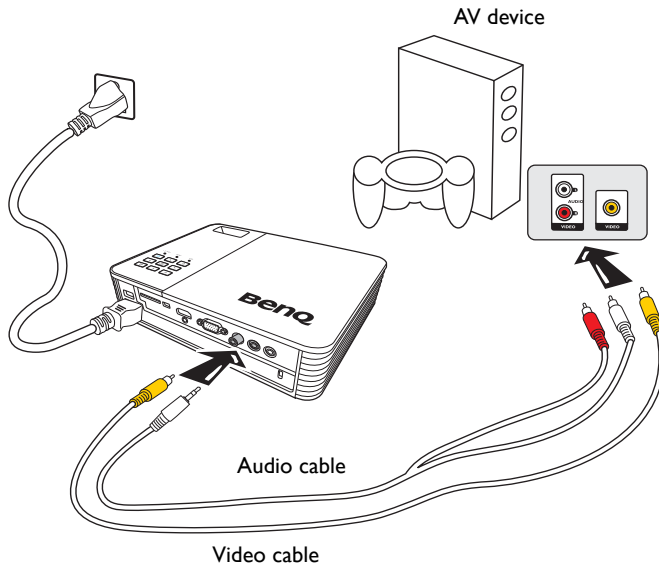

 You need only connect to this device using a composite Video connection if Component Video input is unavailable for use. See ["Connecting Video source devices"](#) on page 19 for details.

Connecting an external speaker

You can hear sound through an external speaker instead of the internal speakers built into the projector.

To connect the projector to an external speaker source device:

1. Connect an appropriate stereo cable to the external speaker and the audio output jack on the projector.

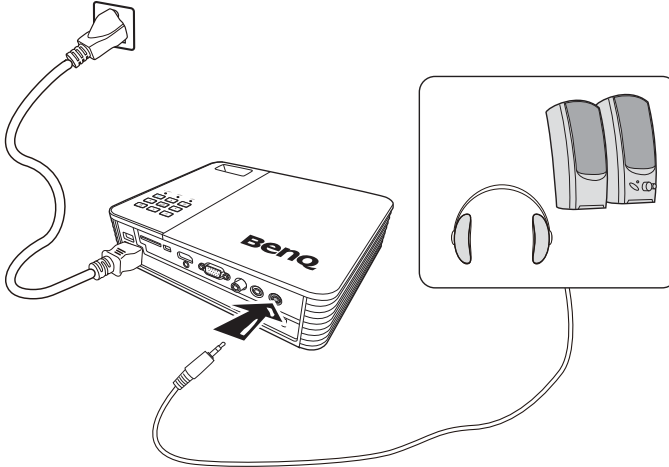

 When the audio cable is connected to the audio output jack, the speaker output is muted.

Connecting to an external memory device

Connecting an SD card

To connect the projector to an SD card:

1. Connect an SD card to the SD card slot on the projector.

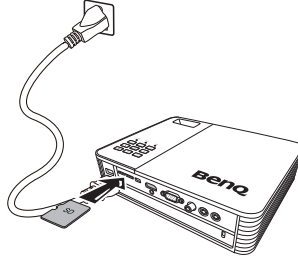

- ☞ • The maximum memory capacity supported for an SD(HC) card is 32 GB. (The maximum capacity supported for external memory is based on our factory test. Your experience may differ depending on the manufacturer of the memory device.)
- The projector may not be compatible with some SD cards.

Connecting a USB storage device

To connect the projector to a USB storage device:

1. Plug the USB storage device into the Type A USB socket.

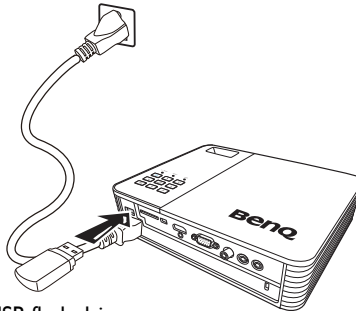

USB flash drive



- ☞ • This product supports USB memory device and HDD (Hard Disk Drive). Only one and only last one of partitions will be mounted. (The maximum capacity supported for external memory is based on our factory test. Your experience may differ depending on the manufacturer of the memory device.)
- This product does not support multi-card readers.
- This product does not work if the USB storage device is connected by a USB HUB.
- Some products which do not comply with standard USB specifications might not operate normally.
- A USB storage device with an automatic recognition application or its own driver might not operate normally.

- **A USB storage device that uses only a designated driver might not be recognized.**
- **Recognition speed for USB storage device may vary by device.**
- **Do not turn off the product or pull a connected USB storage device out while the USB storage device is in use. Doing so may result in damage to the USB storage device or stored file.**
- **Use a USB storage device which contains normal files. Abnormal files can cause a malfunction or the files may not play.**
- **USB storages must be formatted in FAT16/FAT32/NTFS. FAT32 and NTFS are recommended for HDD (Hard Disk Drive).**
- **As the data in the USB storage device can be damaged, please back up important data to avoid loss. The user is responsible for data management. BenQ shall not be held liable for any data loss.**
- **File tree in USB storage should be as simple as possible. Too many or too many layers of folders will result in lag of access time.**
- **If an external memory device does not operate after you've connected it to the projector, try to connect it to a PC. If it still does not operate normally, contact the memory device's manufacturer service center or related customer center.**

Playing sound through the projector

You can make use of the projector speaker in your presentations, and also connect separate amplified speakers to the audio output jack of the projector.

The table below describes the connection methods for different devices, and where the sound is from.

Device	PC/Component video	Video
Audio input jack	Audio input (L/R) AUDIO-IN	Audio input (L/R)
The projector can play the sound from...	Audio input (L/R) AUDIO-IN	Audio input (L/R)
Audio output jack		

- ☞ **The selected input signal determines which sound will be played by the projector speaker, and which sound will be output from the projector when audio output jack is connected.**
- **There's no need to connect to an audio input jack because the projector can play the sound from an HDMI, external memory and iPhone/iPod source device. However, you can connect to an external device to play the sound.**
- **USB display doesn't support audio function.**

Operation

Starting up the projector

1. Connect the power using the power cord. The Power indicator turns into orange.
2. Press **Power** on the projector or remote control to start the projector. The Power indicator lights green when the projector is on.

The start up procedure takes several seconds. In the later stage of start up, a startup logo is projected.

(If necessary) Rotate the focus ring to adjust the image clearness.

3. If the projector is activated for the first time, select your OSD language following the onscreen instructions.
4. If you are prompted for a password, press the arrow keys to enter a six digit password. See ["Utilizing the password function" on page 29](#) for details.
5. Switch all of the connected equipment on.
6. The projector will display the home screen.

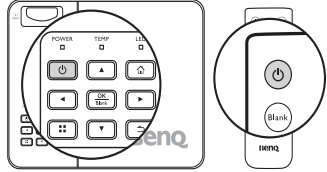

ⓘ If the frequency/resolution of the input signal exceeds the projector's operating range, you will see the message 'Out of Range' displayed on a blank screen.

Please change to an input signal which is compatible with the projector's resolution or set the input signal to a lower setting. See ["Timing chart" on page 71](#) for details.



Switching input signal

The projector can be connected to multiple devices at the same time. However, it can only display one full screen at a time. Press **◀/▶** on the projector or remote control to select your desired input signal.

ⓘ The input signal type effects the options available for the Picture Mode. See ["Selecting a picture mode" on page 32](#) for details.

- The native display resolution of this projector is in a 16:10 aspect ratio. For best display picture results, you should select and use an input signal which outputs at this resolution. Any other resolutions will be scaled by the projector depending upon the 'aspect ratio' setting, which may cause some image distortion or loss of picture clarity. See ["Selecting the aspect ratio" on page 31](#) for details.



Adjusting the projected image

Adjusting the image height

The projector is equipped with 2 adjuster feet. These adjusters change the image height. To adjust the projector:

1. Screw the adjuster feet to adjust the image height.

To retract the feet, screw the adjuster feet in a reverse direction.

If the projector is not placed on a flat surface or the screen and the projector are not perpendicular to each other, the projected image becomes trapezoidal. To correct this situation, see "[Correcting keystone](#)" on page 28 for details.

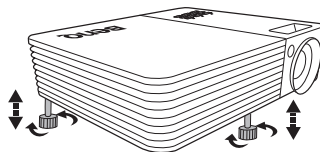

- ⚠ **Do not look into the lens while the lamp is on. The strong light from the lamp may cause damage to your eyes.**
- **Be careful when you screw the adjuster foot as it is close to the exhaust vent where hot air comes from.**

Fine-tuning the image clarity

1. Rotate the focus ring to sharpen the image.

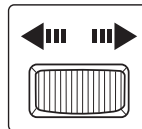
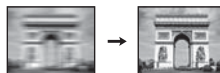

Auto-adjusting the image

In some cases, you may need to optimize the picture quality.

- Using the remote control

Press **AUTO**.

Within 3 seconds, the built-in Intelligent Auto Adjustment function will re-adjust the values of Frequency and Clock to provide the best picture quality.

The current source information will be displayed in the upper left corner of the screen for 3 seconds.

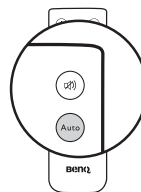

 **This function is only available when PC signal (analog RGB) is selected.**

Correcting keystone

Keystoning refers to the situation where the projected image is noticeably wider at either the top or bottom. It occurs when the projector is not perpendicular to the screen. Correcting keystone when an image is displayed on the screen.

To correct this, besides adjusting the height of the projector, you will need to manually correct it following one of these steps.

1. Press **⏏** and then press **▼** to highlight **Keystone**. The **Keystone** pop-up menu displays.
2. Press **▲** to correct keystone at the bottom of the image or press **▼** to correct keystone at the top of the image.

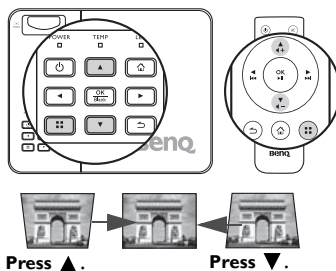

Hiding the image

In order to draw the audience's full attention to the presenter, you can:

- Using the remote control
Use **Blank** on the remote control to hide the screen image. Press again **Blank** or any keys on the remote control to restore the image.
- Using the projector
Press and hold **Blank** for 3 seconds on the projector to hide the screen image. Press again **Blank** or any keys on the projector to restore the image.

 **Do not block the projection lens from projecting as this could cause the blocking object to become heated and deformed or even cause a fire.**

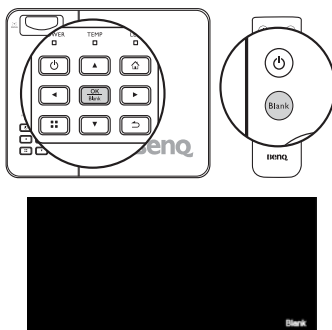

Securing the projector

Utilizing the password function

For security purposes and to help prevent unauthorized use, the projector includes an option for setting up password security. The password can be set through the Settings menu.

 **You will be inconvenienced if you activate the power-on lock functionality and subsequently forget the password. Print out this manual (if necessary) and write the password you used in this manual, and keep the manual in a safe place for later recall.**

Setting power on lock

-  • **Once a password has been set, the projector cannot be used unless the correct password is entered every time the projector is started.**
- **When setting a password for the projector that its password function is used for the first time, enter the default password (1, 1, 1, 1, 1, 1) of the projector by pressing the arrow key five times if you are prompted for a password.**
1. Press ◀ / ▶ until the **Settings** menu is highlighted and then press **OK** to enter.
 2. Go to the **Advanced > Security Settings > Change Security Settings** menu.
 3. Press **OK**. The message **'Input Current Password'** displays.
 4. As pictured to the right, the four arrow keys (▲, ▶, ▼, ◀) respectively represent 4 digits (1, 2, 3, 4). Press the arrow keys to enter six digits for the password.
 5. Once the correct password is set, the OSD menu returns to the **Change Security Settings** menu.
 6. Highlight **Power on Lock** and press **OK**. The pop-up menu displays. Select **On** and press **OK** to complete power on lock setting.
 7. To leave the OSD menu, press ↵ or ⏴.

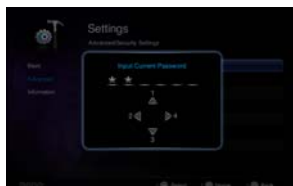

If you forget the password

If the password function is activated, you will be asked to enter the six-digit password every time you turn on the projector. If you enter the wrong password, the password error message displays lasting for three seconds, and the message **'Input Password'** follows. If you enter an incorrect password 5 times in succession, the projector will automatically shut down in a short time.



Entering the password recall procedure

1. Press and hold **⏏** on the remote control for 3 seconds. The projector will display a coded number on the screen.
2. Write down the number and turn off your projector.
3. Seek help from the local BenQ service center to decode the number. You may be required to provide proof of purchase documentation to verify that you are an authorized user of the projector.



Changing the password

1. Go to the **Settings > Advanced > Security Settings > Change password** menu.
2. Press **OK**. The message '**Input Current Password**' displays.
3. Enter the old password.
 - If the password is correct, another message '**Input New Password**' displays.
 - If the password is incorrect, the password error message displays lasting for three seconds, and the message '**Input Current Password**' displays for your retry. You can press **↵** to cancel the change or try another password.
4. Enter a new password.

 **The digits being input will display as asterisks on-screen. Write your selected password down here in this manual in advance or right after the password is entered so that it is available to you should you ever forget it.**

Password: _____

Keep this manual in a safe place.

5. Confirm the new password by re-entering the new password.
6. You have successfully assigned a new password to the projector. Remember to enter the new password next time the projector is started.
7. To leave the OSD menu, press **↵** or **⏏**.



Disabling the password function

To disable password protection, go back to the **Settings > Advanced > Security Settings > Power on Lock** menu. Select **Off** and press **OK**. The message '**Input Password**' displays. Enter the current password.

- If the password is correct, the OSD menu returns to the **Security Settings** page with '**Off**' shown in the row of **Power on Lock**. You will not have to enter the password next time you turn on the projector.
- If the password is incorrect, the password error message displays lasting for three seconds, and the message '**Input Password**' displays for your retry. You can press **↵** to cancel the change or try another password.

☞ Though the password function is disabled, you need to keep the old password in hand should you ever need to re-activate the password function by entering the old password.

Firmware upgrade

Follow below procedures to upgrade firmware version.



- ☞
- Only an SD Card is supported for a firmware update.
 - Do not remove the SD Card while an update is in progress.
 - Do not operate any buttons during the update.
 - Do not turn the projector off during the update.
 - To confirm that the firmware has been successfully updated, go to **Settings > Information > Firmware version**.

Updating the Firmware

1. Connect the SD card containing the latest firmware to the projector.
2. Select **Settings > Advanced > Firmware Upgrade** in the main menu page.
3. Select **OK** to begin.
4. After the firmware is updated, please turn off the projector.
5. Power on the projector and check the firmware version.

Selecting the aspect ratio

The 'aspect ratio' is the ratio of the image width to the image height. Most analog TV and computers are in 4:3 ratio, which is the default for this projector, and digital TV and DVDs are usually in 16:9 ratio.

With the advent of digital signal processing, digital display devices like this projector can dynamically stretch and scale the image output to a different aspect than that of the image input signal.

To change the projected image ratio (no matter what aspect the source is):

1. Press **⏏** to open the pop-up menu in one of the computer, DVD player, composite video, component and HDMI modes.
2. Press **▼** to highlight Aspect Ratio.
3. Press **◀/▶** to select an aspect ratio to suit the format of the video signal and your display requirements.

Optimizing the image

Selecting a picture mode

The projector is preset with several predefined picture modes so that you can choose one to suit your operating environment and input signal picture type.

To select an operation mode that suits your need, you can follow one of the following steps.

- Make sure the input source is on computer, DVD player, composite video, component and HDMI mode and the projection screen is displayed.
- Press **Mode** on the remote control projector repeatedly until your desired mode is selected.
- You may press **⏏** to open the pop-up menu. Press **▼** to select **Picture Mode Settings** and press **OK** to enter. Select **Picture Mode** and press **◀/▶** to select a desired mode.

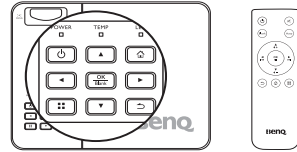

The picture modes are listed below.

1. **Bright mode:** Maximizes the brightness of the projected image. This mode is suitable for environments where extra-high brightness is required, such as using the projector in well lit rooms.
2. **Standard mode (Default):** Is designed for presentations. The brightness is emphasized in this mode.
3. **Cinema mode:** Is appropriate for playing colorful movies, video clips from digital cameras or DVs through the PC input for best viewing in a blackened (little light) environment.
4. **Game mode:** Is appropriate for playing games.
5. **User mode:** Recalls the settings customized based on the current available picture modes. See "[Setting the User mode](#)" on page 32 for details.

Setting the User mode

There is one user-definable modes if the current available picture modes are not suitable for your need. You can use one of the picture modes (except the **User**) as a starting point and customize the settings.

1. Press **⏏** to open the pop-up menu.
2. Press **▼** to select **Picture Mode Settings** and press **OK** to enter.
3. Select **Picture Mode** and press **◀/▶** to select **User**.
4. Press **▼** to highlight **Reference Mode**.

 This function is only available when **User mode** is selected in the **Picture Mode** sub-menu item.

5. Press **◀/▶** to select a picture mode that is closest to your need.
6. Press **▼** to select a sub-menu item to be changed and adjust the value with **◀/▶**. See "[Fine-tuning the image clarity](#)" below for details.
7. When all settings have been done, highlight **Save Settings** and press **OK** to store the settings.
8. The confirmation message '**Setting Saved**' displays.

Using Wall Color

In the situation where you are projecting onto a colored surface such as a painted wall which may not be white, the Wall Color feature can help correct the projected picture's color to prevent possible color difference between the source and projected pictures.

To use this function, press **⏏** to open the pop-up menu in one of the computer, iPhone/iPod, composite video, component and HDMI modes. Select **Wall Color** and press **◀ / ▶** to select a color which is the closest to the color of the projection surface. There are several precalibrated colors to choose from: Light Yellow, Pink, Light Green, Blue, and Blackboard.

Fine-tuning the image quality in user mode

According to the detected signal type, there are some user-definable functions available when User mode is selected. Based on your needs, you can make adjustments to these functions by highlighting them and pressing **◀ / ▶** on the projector or remote control

Adjusting Brightness

The higher the value, the brighter the image. And the lower the setting, the darker the image. Adjust this control so the black areas of the image appear just as black and that detail in the dark areas is visible.



Adjusting Contrast

The higher the value, the greater the contrast. Use this to set the peak white level after you have previously adjusted the **Brightness** setting to suit your selected input and viewing environment.



Adjusting Color

Lower setting produces less saturated colors. If the setting is too high, colors on the image will be overpowering, which makes the image unrealistic.

Adjusting Tint

The higher the value, the more reddish the picture becomes. The lower the value, the more greenish the picture becomes.

Adjusting Sharpness

The higher the value, the sharper the picture becomes. The lower the value, the softer the picture becomes.

Selecting a Color Temperature

There are a number of options available for color temperature* settings vary according to the signal type selected.

*About color temperatures:

There are many different shades that are considered to be "white" for various purposes. One of the common methods of representing white color is known as the "color temperature". A white color with a low color temperature appears to be reddish white. A white color with a high color temperature appears to have more blue in it.

Operating in a high altitude environment

We recommend you use the **High Altitude Mode** when your environment is between 1500 m –3000 m above sea level, and ambient temperature is between 0°C–30°C.

 **Do not use the High Altitude Mode if your altitude is between 0 m and 1499 m and ambient temperature is between 0°C and 35°C. The projector will be over cooled, if you turn the mode on under such a condition.**

To activate the **High Altitude Mode**:

1. Highlight **Settings** and press **OK** to enter.
2. Go to **Advanced > High Altitude Mode** and press **OK**.
3. Highlight **On** and press **OK** to confirm.
4. To leave the OSD, press \rightarrow until the projector returns to the home screen, or press \uparrow to go back to the home screen directly.

Operation under "**High Altitude Mode**" may cause a higher decibel operating noise level because of increased fan speed necessary to improve overall system cooling and performance.

If you use this projector under other extreme conditions excluding the above, it may display auto shut-down symptoms, which is designed to protect your projector from overheating. In cases like this, you should switch to High Altitude mode to solve these symptoms. However, this is not to state that this projector can operate under any and all harsh or extreme conditions.

Adjusting the sound

The sound adjustments made as below will have an effect on the projector speaker(s). Be sure you have made a correct connection to the projector audio input. See "[Connection](#)" on page 16 for how the audio input is connected.

SRS HD

Activating this function enables the SRS HD technology. The projector can provide a surround sound and restore natural sound.

1. Highlight **Settings** and press **OK** to enter.
2. Go to **Advanced > Audio Settings** and press **OK** to enter.
3. Highlight **SRS HD** and press **OK** to open the pop-up menu.
4. Highlight **On** and press **OK** to confirm.
5. To leave the OSD, press \rightarrow until the projector returns to the home screen, or press \uparrow to go back to the home screen directly.

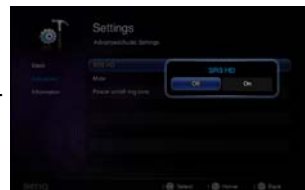

Muting the sound

To temporarily turn off the sound, press  on the remote control, or:

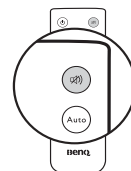

1. Highlight **Settings** and press **OK** to enter.
2. Go to **Advanced > Audio Settings** and press **OK** to enter.
3. Highlight **Mute** and press **OK** to open the pop-up menu.
4. Highlight **On** and press **OK** to confirm.
5. To leave the OSD, press \rightarrow until the projector returns to the home screen, or press \leftarrow to go back to the home screen directly.



Adjusting the sound level

To adjust the sound level, press + or - on the remote control.

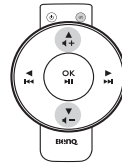

Turning off Power on/off ring tone

To turn off the Power on/off ring tone:

1. Repeat steps 1-2 above.
2. Highlight **Power on/off ring tone** and press **OK** to open the pop-up menu.
3. Highlight **Off** and press **OK** to confirm.

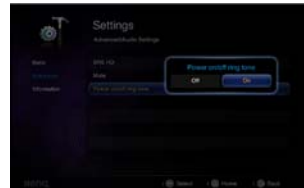

 The only way to change Power On/Off Ring Tone is setting On or Off here. Setting the sound mute or changing the sound level will not affect the Power On/Off Ring Tone.

Displaying images with PC and Video source devices

You can connect your projector to a PC and various Video source devices. (e.g. HDMI, composite video, component video) However, you need only connect the projector to an input source device.

To display images:

1. Connect the projector to one of the above signal source.
2. Turn on the power of the projector and your source device. The projector displays the home screen.
3. Press ◀/▶ on the projector or remote control to select the input signal and then press **OK** to enter.



4. Press ⇨ or ⇩ to go back to home screen.

Using PC/ Video pop-up menus

The projector has a multilingual OSD that allows you to make image adjustments and change a variety of settings. This menu is for the settings to be used in computer, DVD player, composite video, component and HDMI modes.





Using the menu

1. To open the OSD menu, press **⏏** on the projector or remote control when the projection screen is displayed.
2. When the OSD is displayed, press **▲/▼** to select the desired item and adjust the settings by using **◀/▶**.
3. To leave the OSD, press **⏏** again.

Menu system

Menu Item	Sub-menu	Options
Wall Color		Off/Light Yellow/Pink/Light Green/Blue/Blackboard
Aspect Ratio		Auto/Real/4:3/16:9/16:10
Auto Keystone		On/Off
Keystone		
Picture Mode Settings	Picture Mode	Bright/Standard/Cinema/Game/User
	Reference Mode	Bright/Standard/Cinema/Game/User
	Brightness	
	Contrast	
	Color	
	Tint	
	Sharpness	
	Color Temperature	Normal/Cold/Warm
	Save Settings	
3D Sync Invert		Disable/Invert
Information		Source
		Resolution
		Color System

Description of each menu

FUNCTION	DESCRIPTION
Wall Color	Corrects the projected picture's color when the projection surface is not white. See " Using Wall Color " on page 33 for details.
Aspect Ratio	There are four options to set the image's aspect ratio depending on your input signal source. See " Selecting the aspect ratio " on page 31 for details.
Auto Keystone	Auto corrects any keystone of the image.
Keystone	Corrects any keystone of the image. See " Correcting keystone " on page 28 for details.
Picture Mode Settings	<p>Picture Mode See "Selecting a picture mode" on page 32 for details.</p> <p>Reference Mode See "Setting the User mode" on page 32 for details.</p> <p> This function is only available when User is selected.</p> <p>Brightness See "Adjusting Brightness" on page 33 for details.</p> <p>Contrast See "Adjusting Contrast" on page 33 for details.</p> <p>Color See "Adjusting Color" on page 33 for details.</p> <p>Tint See "Adjusting Tint" on page 33 for details.</p> <p> This function is only available the system format is NTSC.</p> <p>Sharpness See "Adjusting Sharpness" on page 33 for details.</p> <p>Color Temperature See "Selecting a Color Temperature" on page 33 for details.</p> <p>Save Settings Saves the settings made for User mode.</p>
3D Sync Invert	When you discover the inversion of the image depth, enable this function to correct the problem.
Information	<p>Source Shows the current signal source.</p> <p>Resolution Shows the native resolution of the input signal.</p> <p>Color System Shows input system format, NTSC, PAL, SECAM, or RGB.</p>

Displaying files with internal memory, USB Drive and SD card

The projector can display files saved in internal memory or external storage like an SD card or a USB Drive when you have connected to projector.

To display files:

1. Turn on the power of the projector and the projector displays the home screen.
2. Connect the projector to one of the above external memory devices.
3. Press ◀/▶ to select SD card, USB Drive/Wireless Display or internal memory.



4. Storages are classified into **Videos, Photos, Music, Documents** menu in home screen. Press ▲/▼ to select desired item and then press **OK** to enter different file browser.

👉 See [“WDR8192 Wireless Dongle Quick Start Guide”](#) for details about the wireless display.

File browser window



Videos



Photos



Music

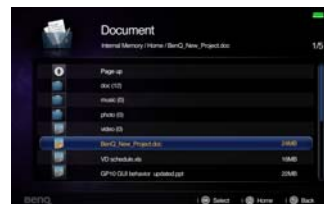

Documents

👉 You will only see relevant and supported files in each of file browser.

When playing videos



NAME		DESCRIPTION
OK	Play/Pause	Plays or pauses a video.
▲ / ▼	Volume	Volume up/down.
◀	Prev	<ul style="list-style-type: none"> Plays the previous video. Press and hold to rewind the video. <ul style="list-style-type: none"> The rewind speed increases to x2, x4, x8 and x16 at 2-second intervals.
▶	Next	<ul style="list-style-type: none"> Plays the next video. Press and hold to fast forward the video. <ul style="list-style-type: none"> The fast-forward speed increases to x2, x4, x8 and x16 at 2-second intervals.
⋮	Menu	Open/close video pop-up settings menu.
↶	Back	<ul style="list-style-type: none"> Return to upper level of OSD. Close video pop-up setting menu. Leave current video player and back to video file browser.
🏠	Home	Exit video player and go back to home screen.

Video player pop-up settings menu

The video player pop-up menu provides an on-screen display (OSD) for adjustments when playing videos.



Using the menu

- To open the OSD menu, press **⋮** on the projector or remote control when the projection screen is displayed.
- When the OSD is displayed, press **▲ / ▼** to select the desired item and adjust the settings by using **◀ / ▶**.
- To exit the OSD, press **⋮** on the projector or remote control again.





- See the table for supported subtitle file types. Refer to "[Supported file formats](#)" on page 50.

Menu system

Menu Item	Sub-menu	Options
Screen Settings	Wall Color	Off/Light Yellow/Pink/Light Green/Blue/Blackboard
	Auto Keystone	On/Off
	Keystone	
Picture Mode Settings	Picture Mode	Bright/Standard/Cinema/Game/User
	Reference Mode	Bright/Standard/Cinema/Game
	Brightness	
	Contrast	
	Color	
	Tint	
	Sharpness	
	Color Temperature	Warm/Normal/Cool
	Save Settings	
Play Settings	Play Mode	All in folder/One video
	Play Order	Normal/Shuffle
	Repeat	On/Off

Description of each menu

FUNCTION	DESCRIPTION
<p>Screen Settings</p>	<p>Wall Color Corrects the projected picture's color when the projection surface is not white. See "Using Wall Color" on page 33 for details.</p> <p>Auto Keystone Auto corrects any keystoneing of the image.</p> <p>Keystone Corrects any keystoneing of the image. See "Correcting keystone" on page 28 for details.</p>
<p>Picture Mode Settings</p>	<p>Picture Mode Pre-defined picture modes are provided so you can optimize your projector image set-up to suit your program type.</p> <p>Reference Mode Selects a picture mode that best suits your need for the image quality and further fine-tune the image based on the selections listed on the same page below.</p> <p> This function is only available when User is selected.</p> <p>Brightness Adjusts the brightness of the image.</p> <p>Contrast Adjusts the degree of difference between dark and light in the image.</p> <p>Color Adjusts the color saturation level -- the amount of each color in a video image.</p> <p>Tint Adjusts the red and green color tones of the image.</p> <p> This function is only available the system format is NTSC.</p> <p>Sharpness Adjusts the image to make it look sharper or softer.</p> <p>Color Temperature Adjusts the color temperature. Cool makes images appear bluish white. Normal maintains normal colorings for white. Warm makes images appear reddish white..</p> <p>Save Settings Saves the settings made for User mode.</p>
<p>Play Settings</p>	<p>Play Mode Lets you choose to play one video or all videos in a folder.</p> <p>Play Order Lets you select the playback order of video files.</p> <p>Repeat Lets you select whether to repeat video playback.</p>

When playing music



NAME		DESCRIPTION
OK	Play/Pause	Plays or pauses a music.
▲ / ▼	Volume	Volume up/down.
◀	Prev	<ul style="list-style-type: none"> Plays the previous music. Press and hold to rewind the music.
▶	Next	<ul style="list-style-type: none"> Plays the next music. Press and hold to fast forward the music.
⋮	Menu	Open/close music pop-up settings menu.
↶	Back	<ul style="list-style-type: none"> Return to upper level of OSD. Close video pop-up setting menu. Leave current music player and back to music file browser.
🏠	Home	Exit music player and go back to home screen.

Music player pop-up settings menu

The music player pop-up menu provides an on-screen display (OSD) for adjustments when playing music.



Using the menu

- To open the OSD menu, press **⋮** on the projector or remote control when the projection screen is displayed.
- When the OSD is displayed, press **▲ / ▼** to select the desired item and adjust the settings by using **◀ / ▶**.
- To exit the OSD, press **⋮** on the projector or remote control again.

Menu system

Menu Item	Options
Play Mode	All in folder/One music
Play Order	Normal / Shuffle
Repeat	On/Off

Description of each menu

FUNCTION	DESCRIPTION
Play Mode	Lets you choose to play one music or all music in a folder.
Play Order	Lets you select the playback order of music files.
Repeat	Lets you select whether to repeat music playback.

When viewing photos



NAME		DESCRIPTION
OK	Play/Pause	Plays or pauses a slideshow.
◀	Prev	Previous photo.
▶	Next	Next photo.
⋮	Menu	Open/close photo pop-up settings menu.
↶	Back	<ul style="list-style-type: none"> Return to upper level of OSD. Close photo pop-up setting menu. Leave current photo player and back to photo file browser.
🏠	Home	Exit photo player and go back to home screen.

Photo viewer pop-up settings menu

The photo view pop-up menu provides an on-screen display (OSD) for adjustments when viewing photos.



Using the menu



- To open the OSD menu, press **⋮** on the projector or remote control when the projection screen is displayed.
- When the OSD is displayed, press **▲/▼** to select the desired item and adjust the settings by using **◀/▶**.
- To exit the OSD, press **⋮** on the projector or remote control again.

Menu system

Menu Item	Sub-menu	Options
Screen Settings	Wall Color	Off/Light Yellow/Pink/Light Green/Blue/Blackboard
	Auto Keystone	On/Off
	Keystone	
Picture Mode Settings	Picture Mode	Bright/Standard/Cinema/Game/User
	Reference Mode	Bright/Standard/Cinema/Game
	Brightness	
	Contrast	
	Color	
	Tint	
	Sharpness	
	Color Temperature	Warm/Normal/Cool
	Save Settings	
Play Settings	Slideshow Speed	Fast/ Normal/ Slow
	Slideshow Mode	All in folder / One photo
	Slideshow Order	Normal / Shuffle
	Repeat	On/Off

Description of each menu

FUNCTION	DESCRIPTION
Screen Settings	<p>Wall Color Corrects the projected picture's color when the projection surface is not white. See "Using Wall Color" on page 33 for details.</p>
	<p>Auto Keystone Auto corrects any keystone of the image.</p>
	<p>Keystone Corrects any keystone of the image. See "Correcting keystone" on page 28 for details.</p>

<p>Picture Mode Settings</p>	<p>Picture Mode Pre-defined picture modes are provided so you can optimize your projector image set-up to suit your program type.</p> <p>Reference Mode Selects a picture mode that best suits your need for the image quality and further fine-tune the image based on the selections listed on the same page below.</p> <p> This function is only available when User is selected.</p> <p>Brightness Adjusts the brightness of the image.</p> <p>Contrast Adjusts the degree of difference between dark and light in the image.</p> <p>Color Adjusts the color saturation level -- the amount of each color in a video image.</p> <p>Tint Adjusts the red and green color tones of the image.</p> <p> This function is only available the system format is NTSC.</p> <p>Sharpness Adjusts the image to make it look sharper or softer.</p> <p>Color Temperature Adjusts the color temperature. Cool makes images appear bluish white. Normal maintains normal colorings for white. Warm makes images appear reddish white..</p> <p>Save Settings Saves the settings made for User mode.</p>
<p>Slideshow Speed</p>	<p>Lets you select slideshow speed.</p>
<p>Slideshow Mode</p>	<p>Lets you choose to slideshow one photo or all photos in a folder.</p>
<p>Slideshow Order</p>	<p>Lets you select the slideshow order of photo files.</p>
<p>Repeat</p>	<p>Lets you select whether to repeat slideshow.</p>

When viewing documents



NAME		DESCRIPTION
OK	Enter	Enlarge the current page. Magnify the page with a further press.
▲	Up	1. When the page is not enlarged: ▲ / ◀ : Move to the previous page. ▼ / ▶ : Move to the next page. 2. When the page is enlarged: ▲ / ▼ / ◀ / ▶ : Move to the top/down/left/right portion of the page.
▼	Down	
◀	Left	
▶	Right	
☰	Menu	Bring out the pop-up menu.
↶	Back	Leave current document viewer and back to document file browser.
🏠	Home	Exit document viewer and go back to home screen.

- ☞ • Loading time may be longer for large files.
- Document viewer may not work properly when a file does not comply with standards or it is damaged.
- Document viewer may not work when a file contains too much data to display on a screen. (For example, too much data on one sheet in an Excel file.)
- Document viewer supports only one font. If a screen uses other fonts, the image Media Play displays may be different than the original screen.
- For example:
 1. The position of line breaks in a sentence might be dissimilar.
 2. The position of page breaks in a MS Word document might be changed. In this case, the document might be shown incompletely according to the Layout properties for Picture or Shapes or Object in MS word . (Please refer to the manual of MS Word for more information on the Layout properties.)
- Some functions supported on your PC are not supported by the projector, such as these PowerPoint functions: Animation, 3D, Smart Art, Hyper Link, and Transparency and Gradation.
- This product does not support encrypted files (DRM).

Document viewer pop-up settings menu

The document view pop-up menu provides an on-screen display (OSD) for adjustments when viewing photos.



Using the menu

1. To open the OSD menu, press **⏏** on the projector or remote control when the projection screen is displayed.
2. When the OSD is displayed, press **▲/▼** to select the desired item and adjust the settings by using **◀/▶**.
3. To exit the OSD, press **⏏** on the projector or remote control again..

Menu system

Menu Item	Options
Page Navigation	
Aspect Ratio	Fit to Width / Fit to Height

Description of each menu

FUNCTION	DESCRIPTION
Page Navigation	Goes directly to a specific page. Enter a page number using the ▲/▼/◀/▶ buttons, check the page number in the preview window on the upper right corner of the screen, and then select <Go> to move to that page.
Aspect Ratio	Fit to Width displays a document so that it fits the screen width. Fit to Height displays a document so that it fits the screen height.

Supported file formats

- Document, Photo, Music

ITEM	FILE EXTENSION
Document	Adobe PDF 1.0~1.4 (PDF)
	MS PowerPoint 97~2010 (ppt, pptx)
	MS Excel 95~2010, Office XP (xls, xlsx)
	MS Word 95~2010, Office XP (doc, docx)
Photo	JPG (.jpg, .jpeg) , BMP (.bmp)
Music	MP3, MP2, MPI, OGG, AAC, WAV

- Video, Subtitles

ITEM	FILE EXTENSION	DESCRIPTION
Video	AVI (Xvid, MJPEG), MKV (XVID), DVIX (MJPEG, XVID), DAT (MPEG1), MPG(MPEG1), MPEG(MPEG1)	
Subtitles	SRT (.srt)	<ul style="list-style-type: none"> • Subtitle files must be in the same directory as the video files. • The name of subtitle files shall be the same as the name of video files. • SRT only supports for UTF (unicode 8).
Bit rate range : If peak bit rate of a video file is larger than 10MB, it might cause video playback lag.		

 Please visit BenQ.com to know more details about the latest supported formats.

Using USB streaming

The projector supports USB streaming for USB display and USB file transfer.

BenQ EZ USB display

The projector can project computer screen via a USB cable instead of a VGA cable.

To use USB display:

1. Connect the projector to a computer using a USB cable.
2. Turn on the power of the projector and your source device. The projector displays the home screen.
3. Press ◀/▶ to select USB Streaming.
4. Press ▲/▼ to select USB Display and then press **OK** to enter.
5. If your computer can automatically install USB driver, you can see computer's screen.
6. If computer's screen can't be projected, please go to "My Computer", find the "BenQUSB EZ Display" (same as using a flash disk drive), then run the "Autorun.exe" file.
7. Press ⏪ or ⏩ to leave computer projection screen and back to projector home screen.



System requirements

Windows	CPU	Intel/AMD Dual Core 2 GHz or higher (ATOM not supported)
	Graphic card	Intel, nVIDIA or AMD graphic card with 64MB VRAM or above
	OS	Windows XP Professional SP3, Vista SP3, Windows 7 SP2
	DRAM	1 GB DDR
Mac	CPU	Intel Dual Core 1.4 GHz or higher (PowerPC not supported)
	Graphic card	Intel, nVIDIA or AMD graphic card with 64MB VRAM or above
	OS	Mac OS X 10.6.5 and above
	DRAM	1 GB DDR
	Recommended Models	MacBook after 2009-01-21 All series of MacBook Pro MacBook Air after 2010-06-08

USB file transfer

You can connect the projector to transfer files from your computer to the projector. The files will be saved in the internal memory, and you can project images from the projector.

To use USB file transfer:

1. Connect the projector to a computer using a USB cable.

2. Turn on the power of the projector and your source device. The projector displays the home screen.
 3. Press ◀/▶ to select USB Streaming.
 4. Press ▲/▼ to select USB File Transfer and then press **OK** to enter.
 5. If the connection is successful, you will see “It is in USB file transfer mode.” message on the screen.
 6. Look for a new “removable disk” icon. This “removable disk” is actually the internal memory in your projector.
 7. Copy & Paste or Drag-N-Drop files from your computer to the removable disk.
 8. If you want to display those files, use ◀/▶ to select Internal Memory. See ["Displaying files with internal memory, USB Drive and SD card" on page 39](#) for details.
 9. Press ⇨ or ⇩ to leave USB File Transfer mode and back to projector home screen.
- To disconnect the projector from a PC:



Make sure to end the connection properly to prevent damage to the projector or your data.

1. Click on the Windows Taskbar.
2. Click the pop-up message.
3. Disconnect the USB cable only when the message says that it is safe to remove the hardware.



- **Do not disconnect the USB cable while the files are being copied, as this could result in loss of data or damage to the projector.**
- **The connection will not end if you have projector files open on the PC. Close all projector files and try again.**
- **Other versions of Windows operate similarly. Follow the correct procedure for removing a USB device from your PC safely for your version of Windows.**

Using wireless streaming

Display PC screen to projector wirelessly

BenQ EZ QPresenter is a power program to project your PC/NB screen to projector wirelessly. It also brings you extension display function so that you can show different content in the secondary display.

Follow the steps below to get it all set up in just a few minutes.

1. Connect the wireless dongle to the USB jack of the projector.

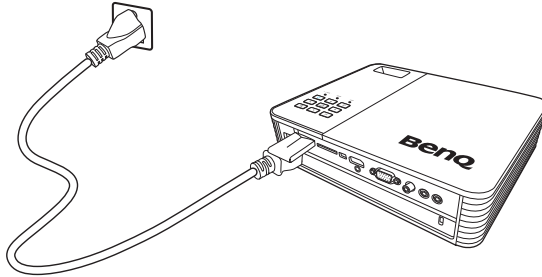

2. Select **“USB Drive/Wireless Streaming”** by pressing **▶** and press **“OK”** on your projector. Choose **“PC Display”**.



3. You will be prompted to the “**To install BenQ EZ QPresenter**” page and follow the steps as instructed.

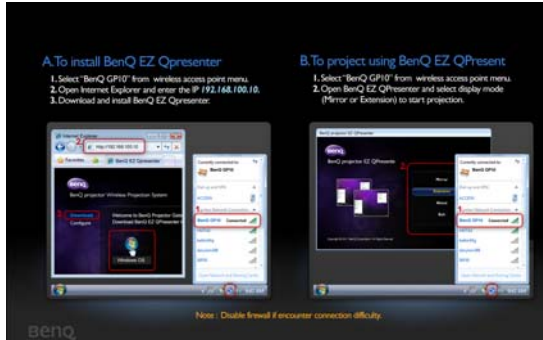

4. Select “**BenQ GP10**” as your WLAN connection on your computer (make sure your computer is equipped with wireless network card).
5. Start a web browser and key in IP address **192.168.100.10** into the address bar and press “**Enter**”.

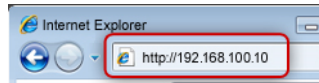

6. Select OS version and start downloading and installing BenQ EZ QPresenter by following the on-screen instructions on you PC.

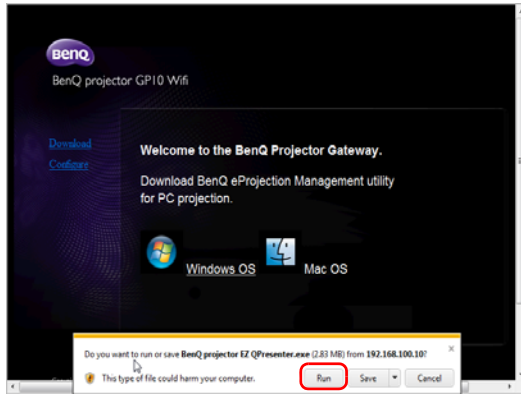

7. Open BenQ EZ QPresenter to start wireless projection
 - i. Select **“BenQ GPI0”** from wireless access point menu of your PC/NB.
 - ii. Open BenQ EZ QPresenter to start projection in mirror mode (default).



Tips:

- If you have installed BenQ EZ QPresenter prior to step i., it will be connected to GPI0 automatically.
- You can disable or enable audio streaming based on your preferences.

Frequently Asked Questions

- **Q: Why does my CPU become busier after launching the BenQ EZ QPresenter?**
- A: BenQ EZ QPresenter counts on your PC CPU to encode the screen images to reduce the data that needs to be transferred to the receiver. Hence there will be some overhead to your PC. In general, for a 4+ ranking PCs, it would need up to 30% of CPU overhead to perform wireless display.
- **Q: Why can't I project my screen?**
- A: BenQ EZ QPresenter needs to access the network connection at some point. As a result, when your Anti-virus or network security software prompts you for permission to allow the sender software to access the network, please grant access to proceed, or choose “add rule” to the fire wall settings.

- **Q: Why does my display frame rate slow down?**
- A: BenQ EZ QPresenter needs to encode display content while sending massive real-time data to the projector.
 - i. PC: A dual core PC (excluding Atom processors) or Mac is required to encode the screen images at 30FPS (Frame Per Second) speed. However, if you would like to increase the FPS speed, you can:
 - a. Use better media players, such as GOM player
 - b. Close all unused apps
 - c. Use a faster PC with Windows Experience Score higher than 4 (4+ recommended)
 - ii. Network:

Using 802.11n WiFi

 - a. Move your laptop closer to the projector
 - b. Disable the “Minimum Power Consumption” option from the “Advanced Tab” in your WiFi network Adaptor Property setting
 - c. Lower PC screen resolution

System Requirements for PC Wireless Display

Windows	CPU	Intel/AMD Dual core 2 GHz or higher (ATOM not supported)
	Graphic card	Intel, NVIDIA or AMD graphic card with 64MB VRAM or above
	OS	Windows XP Professional SP3, Vista SP3, Windows 7 SP2
	Wi-Fi	802.11n
Mac	CPU	Intel Dual core 1.4 GHz or higher (PowerPC not supported)
	Graphic card	Intel, NVIDIA or AMD graphic card with 64MB VRAM or above
	OS	Mac OS X 10.6.5 and above
	Recommended Models	MacBook after 2009-01-21 All series of Macbook Pro Macbook Air after 2010-06-08
	Wi-Fi	802.11n

Display iPhone/iPAD content to projector wirelessly

BenQ GPI0 QPresenter is an easy-to-use app which enables your mobile devices to project the display to BenQ GPI0 Ultra Lite LED projector. You can display your photos/documents including PDF, MS-Office and iWorks.

Follow the steps below to get it all set up in just a few minutes.

1. Connect the wireless dongle to the USB jack of the projector.
2. Select **“USB Drive/Wireless Streaming”** by pressing ► and press **“OK”** on your projector. Choose **“Mobile Display”**.



3. You will be prompted to the **“Mobile Display”** welcome page.



Please download GPI0 QPresenter in App store and install on your iPhone or iPad.

4. Connect your iPhone or iPad to NB/PC. Open iTunes and sync the documents from NB/PC to your iPhone or iPad. After it's done, you can disconnect your iPhone/iPad.

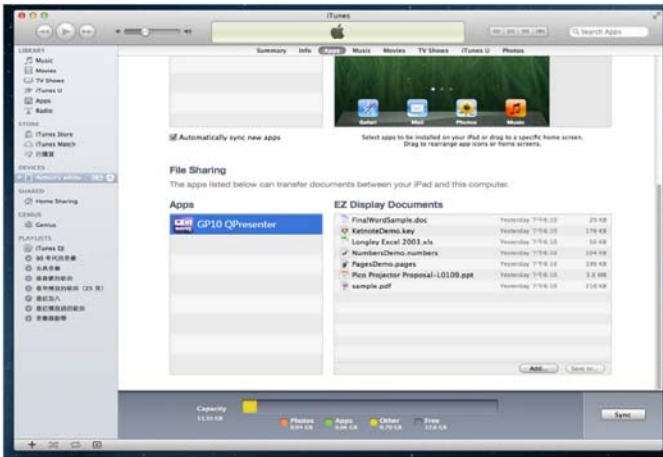

5. Turn on your iPhone/iPad WiFi , find BenQ GP10 or the projector SSID you defined to projector and connect with it directly. After WiFi connection is established, you can execute BenQ GP10 QPresenter app on your iPhone/iPad, and you will be able to see the device's IP address now. Click it to enjoy BenQ GP10 QPresenter's complete functions!!

Features of GP10 QPresenter:

- i. View MS-Office files (Word, Excel, PowerPoint), Adobe PDF, Apple iWorks (Pages, Numbers, Keynote), and it also supports Sketch function and save to photo roll.
- ii. View local photo gallery and do sketch.

Supported device:

- i. iPhone 4 and iPhone 4S, iPhone 5
- ii. iPad 2, and New iPad (gen 3 iPad)

Supported file format:

PDF: Adobe PDF 1.6 or later

Photo: JPEG/JPG/PNG

Office: MS Office 2003 or later

iWorks: iWorks' 09 (Pages' 09, Numbers' 09, Keynote' 09)

Not support:

Animation and embedded object in MS-Office or iWorks

Wi-Fi Dongle Specifications

Model Name	WDRT8192
Wireless Standard	IEEE 802.11 b/g/n
Interface	USB 2.0
Data Transfer Rate	up to 300Mbps
Frequency Band	2.4GHz ISM Band
Security	64 bit/128 bit WEP, TKIP, AES, WPA, WPA2
Supported OS	Windows 2000/XP/Vista/7
Minimum PC System Requirement	CPU: 200MHz or above RAM: 64MB RAM or above, 128MB recommended

Using settings menu

This menu is to set the projector's operating environment.

Using the menu

1. To open the OSD menu, press ◀/▶ to select **Settings** icon in home screen.
2. When the OSD is displayed, press ▲/▼ to select any item in the main menu.
3. After selecting the desired main menu item, press **OK** to enter the feature settings submenu.
4. Press ▲/▼ to select the desired item and press **OK** to open the pop-up menu.
5. Select the settings using ▲/▼/◀/▶ and press **OK** to confirm. Once the setting is selected, the OSD menu returns to the selected item.
6. Press ↵ to return to the main menu.
You may press ⏪ to go back to home screen directly.
7. Press ↵ again to go back to home screen.

Menu system

Main menu	Sub-menu	Options
	Language	English / Français / Deutsch Italiano / Español / Русский 繁體中文 / 简体中文 / 日本語 / 한국어 / Svenska / Nederlands / Türkçe / Čeština / Português / ไทย / Polski Magyar / Български / Hrvatski / Română / Suomi / Norsk / Dansk / Indonesian / Ελληνικά / العربية / हिन्दी
1. Basic	LED Mode	Normal/Eco
	Wall Color	Off/Light Yellow/Pink/Light Green/ Blue/Blackboard
	Auto Keystone	On/Off
	Eye Protection	On/Off
	Auto Power Off	Disable/5 min/10 min/15 min/20 min/25 min/30 min
	Splash Screen	BenQ/ Black/Blue
	High Altitude Mode	On/Off
Audio Settings	SRS HD	On/Off
	Mute	On/Off
	Volume	
	Power on/off ring tone	On/Off
Menu Display Time	5 sec/10 sec/15 sec/20 sec/25 sec/ 30 sec	
2. Advanced	Change Password	
	Recall Password	
	Change Security Settings	
	Power On Lock	On/Off
	Closed Caption Enable	On/Off
Caption Version	CC1/CC2/CC3/CC4	
	Test Pattern	
Firmware Upgrade		
Reset All Settings		
3. Information	Source	
	Picture Mode	
	Color System	
	Resolution	
	Memory / Internal Memory	
	DLP 3D	
	LED Lamp Life	
Firmware Version		

Description of each menu

FUNCTION	DESCRIPTION
Language	Sets the language for the On-Screen Display (OSD) menus.
LED Mode	Choose Eco to dim the projector LED which will lower power consumption, extend the LED life and reduce noise. Choose Normal to return normal mode.
Wall Color	Corrects the projected picture's color when the projection surface is not white.
Auto Keystone	Auto corrects any keystone of the image.
Eye Protection	When detecting something is in front of the projection lens, the projector automatically hides the image. The effective range is 20 cm-30 cm (varies with different ambient light and colors of reflected objects). See " Hiding the image " on page 28 for details on how to restore the image.
Auto Power Off	Allows the projector to turn off automatically if no input signal is detected after a set period of time.
Splash Screen	Allows you to select which logo screen will display during projector start-up. Three options are available: BenQ logo, Black screen, or Blue screen.

I. Basic menu

FUNCTION	DESCRIPTION
High Altitude Mode	A mode for operation in high altitude areas. See "Operating in a high altitude environment" on page 34 for details.
Audio Settings	See "Adjusting the sound" on page 34 for details.
Menu Display Time	Sets the length of time the OSD will remain active after your last key press. The range is from 5 to 30 seconds in 5-second increments.
Security Settings	See "Securing the projector" on page 29 for details.
Closed Caption	<p>Closed Caption Enable</p> <p>Activates the function by selecting On when the selected input signal carries closed captions.</p> <ul style="list-style-type: none"> • Captions: An on-screen display of the dialogue, narration, and sound effects of TV programs and videos that are closed captioned (usually marked as "CC" in TV listings).
	<p>Caption Version</p> <p>Selects a preferred closed captioning mode. To view captions, select CC1, CC2, CC3, or CC4 (CC1 displays captions in the primary language in your area).</p>
Test Pattern	Selecting OK enables the function and the projector displays the grid test pattern. It helps you adjust the image size and focus and check that the projected image is free from distortion.
Firmware Upgrade	Updating the latest firmware are only allowed via an SD card.
Reset All Settings	Returns all settings to the factory preset values.

2. Advanced menu

FUNCTION	DESCRIPTION
Source	Shows the current signal source.
Picture Mode	Shows the selected mode.
Color System	Shows input system format: RGB or YUV.
Resolution	Shows the native resolution of the input signal.
Memory / Internal Memory	Shows the memory capacity status: Internal Memory.
DLP 3D	Shows the DLP 3D status.
LED Lamp Life	Displays the number of hours the lamp has been used.
Firmware Version	Shows firmware version.

3. Information menu

Shutting down the projector

1. Press **Power** and a confirmation message displays prompting you.

If you don't respond in a few seconds, the message will disappear.

2. Press **Power** a second time.
3. The Power LED indicator flashes orange slowly and fans stop.

4. Disconnect the power cord from the wall socket if the projector will not be used in an extended period of time.

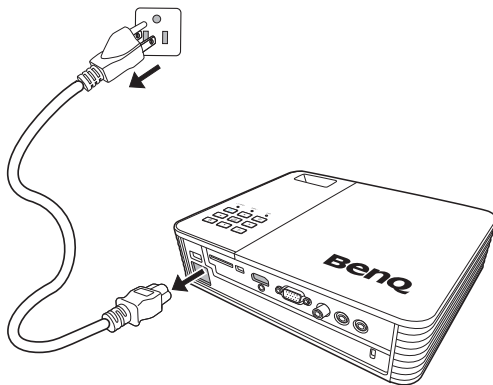
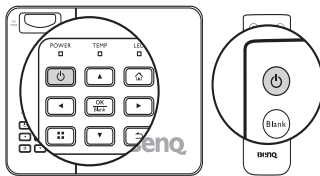

Maintenance

Care of the projector

Your projector needs little maintenance. The only thing you need to do on a regular basis is to keep the lens clean.

Never remove any parts of the projector. Contact your dealer if other parts need replacing.

Cleaning the lens

Clean the lens whenever you notice dirt or dust on the surface.

- Use a canister of compressed air to remove dust.
- If there is dirt or smears, use lens-cleaning paper or moisten a soft cloth with lens cleaner and gently wipe the lens surface.

 **Never rub the lens with abrasive materials.**

Cleaning the projector case

Before you clean the case, turn the projector off using the proper shutdown procedure as described in "[Shutting down the projector](#)" on page 65 and unplug the power cord.

- To remove dirt or dust, wipe the case with a soft, lint-free cloth.
- To remove stubborn dirt or stains, moisten a soft cloth with water and a neutral pH detergent. Then wipe the case.

 **Never use wax, alcohol, benzene, thinner or other chemical detergents. These can damage the case.**

Storing the projector

If you need to store the projector for an extended time, please follow the instructions below:

- Make sure the temperature and humidity of the storage area are within the recommended range for the projector. Please refer to "[Specifications](#)" on page 69 or consult your dealer about the range.
- Retract the adjuster feet.
- Remove the battery from the remote control.
- Pack the projector in its original packing or equivalent.

Transporting the projector

It is recommended that you ship the projector with its original packing or equivalent.

LED Indicators

Status / Problems	LED indicators			LED Behavior
	Power	Fan	Temp	
Standby	Orange solid on	Off	Off	Power LED slow flash
Power warm up	Green blanking			
Power on	Green	Off	Off	Light solid on sequence: Power→Key→Ring & OK
Cooling	Orange blanking	Off	Off	Power LED slow flash
Fan I error	Off	On	Off	Ring & OK LED flash first and then key LED flash (1.5 seconds interval)
Temp error	Off	Off	On	Ring & OK LED and Key LED flash at the same time (1.5 seconds interval for LED flash)

Troubleshooting

? The projector does not turn on.

Cause	Remedy
There is no power from the power cable.	Plug the AC adapter into the DC IN socket on the projector, plug the power cord into the AC inlet on the AC adapter, plug the power cord into the power outlet. If the power outlet has a switch, make sure that it is switched on.
Attempting to turn the projector on again during the cooling process.	Wait until the cooling down process has completed.

? No picture

Cause	Remedy
The source is not turned on or connected correctly.	Turn the source on and check that the signal cable is connected correctly.
The projector is not correctly connected to the input signal device.	Check the connection.
The input signal has not been correctly selected.	Select the correct input signal with the ◀/▶ key on the projector or remote control.

? Blurred image

Cause	Remedy
The projection lens is not correctly focused.	Adjust the focus of the lens using the focus ring.
The projector and the screen are not aligned properly.	Adjust the projection angle and direction as well as the height of the unit if necessary.

? Remote control does not work

Cause	Remedy
The battery is out of power.	Replace the battery with new one.
There is an obstacle between the remote control and the projector.	Remove the obstacle.
You are too far away from the projector.	Stand within 7 meters (23 feet) of the projector.

? The password is incorrect

Cause	Remedy
You do not remember the password.	Please see "Entering the password recall procedure" on page 30 for details.

Specifications

Projector specifications

 All specifications are subject to change without notice.

General	
Product name	Ultra Lite LED Projector
Model name	GPI0
Optical	
Resolution	1280 x 800 WXGA
Display system	1-CHIP DMD
Lens F/Number	F = 1.65
Lamp	3LED
Throw Ratio	1.2:1 (40" @ 1m)
Electrical	
Power supply	AC100–240V, 50-60 Hz (Automatic)
Power consumption	125 W (Max.); < 0.5 W (Standby)
Keystone Adjustment	1D, Vertical +/- 30 degrees
Mechanical	
Dimensions	220 mm (W) x 61.8 mm (H) x 177 mm (D)
Weight	1.5 kg
Input terminal	
Multi-input	
Computer input	D-Sub 15-pin (female) x 1
Video input	VIDEO RCA jack x 1 SD/HDTV signal input Analog - Component RCA jack x 3 (through RGB input)
HDMI	HDMI x1
Audio input	3.5 mm stereo mini jack x 1
USB-A type	For USB flash drive. Supports videos/photos/music/documents.
mini-B USB type	Supports USB display and USB file transfer
SD card slot	Supports videos/photos/music/documents
Internal memory	2GB
Output terminal	
Audio output	3.5 mm stereo mini jack x 1
Speaker	3 watt x 2
Environmental Requirements	
Operating temperature	0° C- 40° C at sea level

Operating relative humidity	10%-90% (without condensation)
Operating altitude	0-1499 m at 0°C-35°C 1500-3000 m at 0°C-30°C (with High Altitude Mode on)

Dimensions

- Without DVD player: 220 mm (W) × 61.8 mm (H) × 177 mm (D)
- With DVD player: 220 mm (W) × 95.0 mm (H) × 177 mm (D)

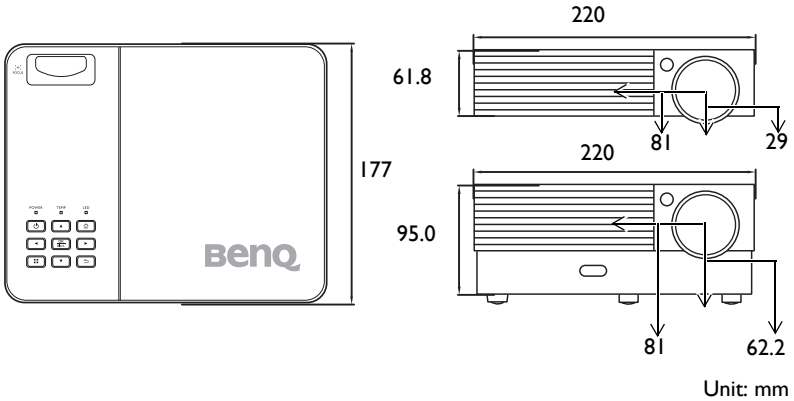

Timing chart

Supported timing for PC input

Resolution	Mode	Vertical Frequency (Hz)	Horizontal Frequency (kHz)
640 x 480	VGA_60	59.940	31.469
	VGA_72	72.809	37.861
	VGA_75	75.000	37.500
	VGA_85	85.008	43.269
720 x 400	720 x 400_70	70.087	31.469
800 x 600	SVGA_60	60.317	37.879
	SVGA_72	72.188	48.077
	SVGA_75	75.000	46.875
	SVGA_85	85.061	53.674
	SVGA_120*	119.854	77.425
1024 x 768	XGA_60	60.004	48.363
	XGA_70	70.069	56.476
	XGA_75	75.029	60.023
	XGA_85	84.997	68.667
	XGA_120*(Reduce Blanking)	119.989	97.551
1152 x 864	1152 x 864_75	75.00	67.500
1024 x 576	BenQ Notebook Timing	60.0	35.820
1024 x 600	BenQ Notebook Timing	64.995	41.467
1280 x 720	1280 x 720_60	60	45.000
1280 x 768			
1280 x 800	1280 x 768_60	59.870	47.776
	WXGA_60	59.810	49.702
	WXGA_75	74.934	62.795
	WXGA_85	84.880	71.554
	WXGA_120* (Reduce Blanking)	119.909	101.563
1280 x 1024	SXGA_60	60.020	63.981
	SXGA_75	75.025	79.976
1280 x 960	1280 x 960_60	60.000	60.000
	1280 x 960_85	85.002	85.938
1360 x 768	1360 x 768_60	60.015	47.712
1440 x 900	WXGA+_60	59.887	55.935
1400 x 1050	SXGA+_60	59.978	65.317
1680 x 1050	1680 x 1050_60	59.954	65.290
640 x 480 @67Hz	MAC13	66.667	35.000
832 x 624@75Hz	MAC16	74.546	49.722
1024 x 768@75Hz	MAC19	75.020	60.241
1152 x 870@75Hz	MAC21	75.06	68.68

 *Supported timing for 3D signal with frame sequential format.

Supported timing for HDMI input

PC timings:

Resolution	Mode	Vertical Frequency (Hz)	Horizontal Frequency (kHz)
640 x 480	VGA_60	59.940	31.469
	VGA_72	72.809	37.861
	VGA_75	75.000	37.500
	VGA_85	85.008	43.269
720 x 400	720 x 400_70	70.087	31.469
800 x 600	SVGA_60	60.317	37.879
	SVGA_72	72.188	48.077
	SVGA_75	75.000	46.875
	SVGA_85	85.061	53.674
	SVGA_120*	119.854	77.425
1024 x 768	XGA_60	60.004	48.363
	XGA_70	70.069	56.476
	XGA_75	75.029	60.023
	XGA_85	84.997	68.667
	XGA_120* (Reduce Blanking)	119.989	97.551
1152 x 864	1152 x 864_75	75.00	67.500
1024 x 576	BenQ Notebook Timing	60.000	35.820
1024 x 600	BenQ Notebook Timing	64.995	41.467
1280 x 720	1280 x 720_60	60	45.000
1280 x 768	1280 x 768_60	59.870	47.776
1280 x 800	WXGA_60	59.810	49.702
	WXGA_75	74.934	62.795
	WXGA_85	84.880	71.554
	WXGA_120* (Reduce Blanking)	119.909	101.563
1280 x 1024	SXGA_60	60.020	63.981
	SXGA_75	75.025	79.976
1280 x 960	1280 x 960_60	60.000	60.000
	1280 x 960_85	85.002	85.938
1360 x 768	1360 x 768_60	60.015	47.712
1440 x 900	WXGA+ 60	59.887	55.935
1400 x 1050	SXGA+ 60	59.978	65.317
1680 x 1050	1680 x 1050_60	59.954	65.290
640 x 480@67Hz	MAC13	66.667	35.000
832 x 624@75Hz	MAC16	74.546	49.772
1024 x 768@75Hz	MAC19	75.020	60.241
1152 x 870@75Hz	MAC21	75.06	68.68

 *Supported timing for 3D signal with frame sequential format.

Video timings:

Timing	Resolution	Vertical Frequency (Hz)	Horizontal Frequency (kHz)
480i	720 (1440) × 480	59.94	15.73
480p	720 × 480	59.94	31.47
576i	720 (1440) × 576	50	15.63
576p	720 × 576	50	31.25
720/50p	1280 × 720	50	37.5
720/60p	1280 × 720	60	45.00
1080/24P	1920 × 1080	24	27
1080/25P	1920 × 1080	25	28.13
1080/30P	1920 × 1080	30	33.75
1080/50i	1920 × 1080	50	28.13
1080/60i	1920 × 1080	60	33.75
1080/50P	1920 × 1080	50	56.25
1080/60P	1920 × 1080	60	67.5

Supported timing for Component-YPbPr input

Timing	Resolution	Vertical Frequency (Hz)	Horizontal Frequency (kHz)
480i	720 × 480	59.94	15.73
480p	720 × 480	59.94	31.47
576i	720 × 576	50	15.63
576p	720 × 576	50	31.25
720/50p	1280 × 720	50	37.5
720/60p	1280 × 720	60	45.00
1080/50i	1920 × 1080	50	28.13
1080/60i	1920 × 1080	60	33.75
1080/24P	1920 × 1080	24	27
1080/25P	1920 × 1080	25	28.13
1080/30P	1920 × 1080	30	33.75
1080/50P	1920 × 1080	50	56.25
1080/60P	1920 × 1080	60	67.5

Supported timing for Video input

Video mode	Vertical Frequency (Hz)	Horizontal Frequency (kHz)
NTSC	60	15.73
PAL	50	15.63
SECAM	50	15.63
PAL-M	60	15.73
PAL-N	50	15.63
PAL-60	60	15.73
NTSC4.43	60	15.73

Warranty and Copyright information

Patents

This BenQ projector is covered by the following patents:

U.S. patents 6,837,608; 7,275,834; 7,181,318; TW patents 202690; 205470; I228635; I259932; China Patents (中国发明专利) ZL01143168.7; ZL03119907.0; ZL200510051609.2

Limited warranty

BenQ warrants this product against any defects in material and workmanship, under normal usage and storage.

Proof of purchase date will be required with any warranty claim. In the event this product is found to be defective within the warranty period, BenQ's only obligation and your exclusive remedy shall be replacement of any defective parts (labor included). To obtain warranty service, immediately notify the dealer from which you purchased the product of any defects.

Important: The above warranty shall be void if the customer fails to operate the product in accordance with BenQ's written instructions, especially the ambient humidity must be in-between 10% and 90%, temperature in-between 0°C and 35°C, altitude lower than 4920 feet, and avoiding to operate the projector in a dusty environment. This warranty gives you specific legal rights, and you may have other rights which vary from country to country.

For other information, please visit www.BenQ.com.

Copyright

© 2012 BenQ Corp. Specification may vary by region, please visit your local stores for details. Actual product's features and specifications are subject to change without notice.

This material may include corporate names and trademarks of third parties which are the properties of the third parties respectively. Apple, the Apple logo, iPad, iPhone, iPod, iPod classic, iPod nano, iPod shuffle, and iPod touch are trademarks of Apple Inc., registered in the U.S. and other countries.

Disclaimer

BenQ Corporation makes no representations or warranties, either expressed or implied, with respect to the contents hereof and specifically disclaims any warranties, merchantability or fitness for any particular purpose. Further, BenQ Corporation reserves the right to revise this publication and to make changes from time to time in the contents hereof without obligation to notify any person of such revision or changes.

*DLP, Digital Micromirror Device and DMD are trademarks of Texas Instruments. Others are copyrights of their respective companies or organizations.